

Operating Instructions | EN

EP1957-0022 and EP1957-2222

TwinSAFE EtherCAT Box with 8 fail-safe inputs and 4 fail-safe outputs



Table of contents

1	Notes on the documentation.....	5
1.1	Disclaimer.....	5
1.1.1	Trademarks.....	5
1.1.2	Patents.....	5
1.1.3	Limitation of liability.....	6
1.1.4	Copyright.....	6
1.2	Documentation issue status.....	7
1.3	Version history of the TwinSAFE product.....	8
1.4	Staff qualification.....	8
1.5	Safety and instruction.....	9
1.5.1	Explanation of symbols.....	9
1.6	Beckhoff Support and Service.....	10
2	For your safety.....	11
2.1	Duty of care.....	11
2.2	Safety image signs.....	12
2.3	General safety instructions.....	13
2.3.1	Before operation.....	13
2.3.2	In operation.....	13
2.3.3	After operation.....	13
3	System description.....	14
3.1	EtherCAT Box Modules.....	14
4	Product description.....	15
4.1	EP1957-0022 and EP1957-2222.....	15
4.2	Intended use.....	16
4.3	Technical data.....	18
4.4	Safety parameters.....	19
4.5	Safe inputs and outputs.....	19
4.6	Dimensions.....	20
5	Operation.....	21
5.1	Environmental conditions.....	21
5.2	Installation.....	21
5.2.1	Fixing.....	21
5.2.2	Connection.....	22
5.2.3	Temperature measurement.....	29
5.2.4	Signal cables.....	30
5.3	Configuration of the EtherCAT Box in TwinCAT.....	32
5.3.1	Adding an EtherCAT device.....	32
5.3.2	Adding an EP1957.....	32
5.3.3	EP1957-0022: using the integrated TwinSAFE Logic functions.....	32
5.3.4	Address settings on the TwinSAFE EtherCAT Box.....	34
5.3.5	Alias devices.....	35
5.3.6	EP1957 parameters.....	37
5.3.7	Process image of the EP1957.....	41

5.4	TwinSAFE reaction times	43
5.5	Diagnosis	45
5.5.1	EtherCAT- Fieldbus LEDs	45
5.5.2	Status LEDs	46
5.5.3	Diagnostic LEDs.....	48
5.5.4	Flash code display	49
6	Service life	50
7	Maintenance and cleaning	51
8	Decommissioning	52
8.1	Disposal	52
8.1.1	Returning to the vendor.....	52
9	Appendix.....	53
9.1	Protection classes according to IP code	53
9.2	Volatility	54
9.3	Focus of certificates	55
9.4	Certificate	56

1 Notes on the documentation

1.1 Disclaimer

Beckhoff products are subject to continuous further development. We reserve the right to revise the operating instructions at any time and without prior announcement. No claims for the modification of products that have already been supplied may be made on the basis of the data, diagrams and descriptions in these operating instructions.

In these operating instructions we define all permissible use cases whose properties and operating conditions we can guarantee. The use cases we define are fully tested and certified. Use cases beyond this, which are not described in these operating instructions, require the approval of Beckhoff Automation GmbH & Co KG.

1.1.1 Trademarks

Beckhoff®, TwinCAT®, EtherCAT®, EtherCAT G®, EtherCAT G10®, EtherCAT P®, Safety over EtherCAT®, TwinSAFE®, XFC®, XTS® and XPlanar® are registered and licensed trademarks of Beckhoff Automation GmbH.

The use of other brand names or designations by third parties may lead to an infringement of the rights of the owners of the corresponding designations.

1.1.2 Patents

The EtherCAT technology is protected by patent rights through the following registrations and patents with corresponding applications and registrations in various other countries:

- EP1590927
- EP1789857
- EP1456722
- EP2137893
- DE102015105702



EtherCAT® is a registered trademark and patented technology, licensed by Beckhoff Automation GmbH.



Safety over EtherCAT® is a registered trademark and patented technology, licensed by Beckhoff Automation GmbH.

1.1.3 Limitation of liability

All components in this product as described in the operating instructions are delivered in a specific configuration of hardware and software, depending on the application regulations. Modifications and changes to the hardware and/or software configuration that go beyond the documented options are prohibited and nullify the liability of Beckhoff Automation GmbH & Co. KG.

The following is excluded from the liability:

- Failure to observe these operating instructions
- Improper use
- Use of untrained personnel
- Use of unauthorized spare parts

1.1.4 Copyright

© Beckhoff Automation GmbH & Co. KG, Germany.

The distribution and reproduction of this document as well as the use and communication of its contents without express authorization are prohibited.

Offenders will be held liable for the payment of damages. All rights reserved in the event of the grant of a patent, utility model or design.

1.2 Documentation issue status

Version	Comment
2.0.0	<ul style="list-style-type: none"> • Foreword changed to Notes on the documentation [► 5] and For your safety [► 11] • Service life [► 50] moved • Maintenance and cleaning [► 51] and Decommissioning [► 52] adapted • Appendix adapted and expanded
1.2.1	<ul style="list-style-type: none"> • Typo in Technical data [► 18] corrected
1.2.0	<ul style="list-style-type: none"> • In chapter Technical data [► 18] link to download page of certificates added • Chapter "Firmware update of TwinSAFE products" removed • I/O component EP1957-2222 added as variant of EP1957-0022 • Chapter Project design limits of EP1957 [► 33] moved • Figure labels changed
1.1.0	<ul style="list-style-type: none"> • Project design limits added
1.0.0	<ul style="list-style-type: none"> • First release • Dimensioning updated • Certificate added
0.5.0	<ul style="list-style-type: none"> • Dimensions of the EP1957 updated in the text
0.4.0	<ul style="list-style-type: none"> • Revision following review
0.3.0	<ul style="list-style-type: none"> • Diagrams updated • Description of <i>Module Fault Link active</i> parameter added
0.2.0	<ul style="list-style-type: none"> • Parameter descriptions expanded • Technical data updated • EN 81-20, EN 81-22 and EN 81-50 notes added
0.0.1	<ul style="list-style-type: none"> • First draft

Currentness

Please check whether you are using the current and valid version of this document. The current version can be downloaded from the Beckhoff homepage at <http://www.beckhoff.de/twinsafe>. In case of doubt, please contact Technical Support (see [Beckhoff Support and Service \[► 10\]](#)).

Origin of the document

The original documentation is written in German. All other languages are derived from the German original.

Product features

Only the product properties specified in the current operating instructions are valid. Further information given on the product pages of the Beckhoff homepage, in emails or in other publications is not authoritative.

1.3 Version history of the TwinSAFE product

This version history lists the software and hardware version numbers. A description of the changes compared to the previous version is also given.

● Updated hardware and software

I TwinSAFE products are subject to a cyclical revision. We reserve the right to revise and change the TwinSAFE products at any time and without prior notice.

No claims for changes to products already delivered can be asserted from these hardware and/or software changes.

Date	Software version	Hardware version	Modifications
			First release of the EP1957-2222
31/07/2018	01	00	First release of the EP1957-0022

1.4 Staff qualification

These operating instructions are intended exclusively for trained specialists in control technology and automation with the relevant knowledge.

The trained specialist personnel must ensure that the applications and use of the described product meet all safety requirements. This includes all applicable and valid laws, regulations, provisions and standards.

Trained specialists

Trained specialists have extensive technical knowledge from studies, apprenticeships or technical training. Understanding of control technology and automation is available. Trained specialists can:

- Independently identify, avoid and eliminate sources of hazard.
- Apply relevant standards and directives.
- Implement specifications from accident prevention regulations.
- Evaluate, prepare and set up the workplaces.
- Evaluate, optimize and execute work independently.

1.5 Safety and instruction

Read the contents that refer to the activities you have to perform with the product. Always read the chapter [For your safety \[▶ 11\]](#) in the operating instructions.

Observe the warnings in the chapters so that you can handle and work with the product as intended and safely.

1.5.1 Explanation of symbols

Various symbols are used for a clear arrangement:

1. The numbering indicates an action that should be taken.
 - The bullet point indicates an enumeration.
- [...] The square brackets indicate cross-references to other text passages in the document.
- [1] The number in square brackets indicates the numbering of a referenced document.

1.5.1.1 Pictograms

In order to make it easier for you to find text passages, pictograms and signal words are used in warning notices:

DANGER

Failure to observe will result in serious or fatal injuries.

WARNING

Failure to observe may result in serious or fatal injuries.

CAUTION

Failure to observe may result in minor or moderate injuries.

NOTE

Notes

Notes are used for important information on the product. The possible consequences of failure to observe these include:

- Malfunctions of the product
- Damage to the product
- Damage to the environment

Information

This sign indicates information, tips and notes for dealing with the product or the software.

1.6 Beckhoff Support and Service

Support

Beckhoff Support offers technical advice on the use of individual Beckhoff products and system planning. The employees support you in the programming and commissioning of sophisticated automation systems.

Hotline: +49 5246/963-157
E-mail: support@beckhoff.com
Web: www.beckhoff.com/support

Training

Training in Germany takes place in our training center at the Beckhoff headquarters in Verl, at subsidiaries or, by arrangement, at the customer's premises.

Hotline: +49 5246/963-5000
E-mail: training@beckhoff.com
Web: www.beckhoff.com/training

Service

The Beckhoff Service Center supports you with after-sales services such as on-site service, repair service or spare parts service.

Hotline: +49 5246/963-460
E-mail: service@beckhoff.com
Web: www.beckhoff.com/service

Download area

In the download area you can obtain product information, software updates, the TwinCAT automation software, documentation and much more.

Web: www.beckhoff.com/download

Headquarters

Beckhoff Automation GmbH & Co. KG
Hülshorstweg 20
33415 Verl
Germany

Phone: +49 5246/963-0
E-mail: info@beckhoff.com
Web: www.beckhoff.com

For the addresses of our worldwide locations, please visit our website at [Global Presence](#).

2 For your safety

Read this chapter containing general safety information. In addition, always observe the safety instructions and warnings in these operating instructions for your own safety, the safety of other persons and the safety of the product.

When working with control and automation products, many dangers can result from careless or incorrect use. Work particularly thoroughly, not under time pressure and responsibly towards other people.

2.1 Duty of care



Read entire documentation for TwinSAFE component

- TwinSAFE application manual
- EL6910 TwinSAFE logic terminal operating manual
- TwinSAFE Logic FB documentation manual

The operator must comply with all the requirements and notes specified in these operating instructions in order to fulfill his duty of care. This includes in particular that you

- comply with the provisions defined in the chapter [Limitation of liability](#) [▶ 6].
- only operate the TwinSAFE component when it is in perfect working order.
- provide the operating instructions in a legible condition and complete at the place of use of the TwinSAFE component.
- do not remove the safety markings attached to the TwinSAFE component and maintain their legibility.





No disposal in domestic waste

Products marked with a crossed-out waste bin must not be disposed of with domestic waste. The device is considered waste electrical and electronic equipment when it is disposed of. Observe the national regulations for the disposal of waste electrical and electronic equipment.

2.2 Safety image signs

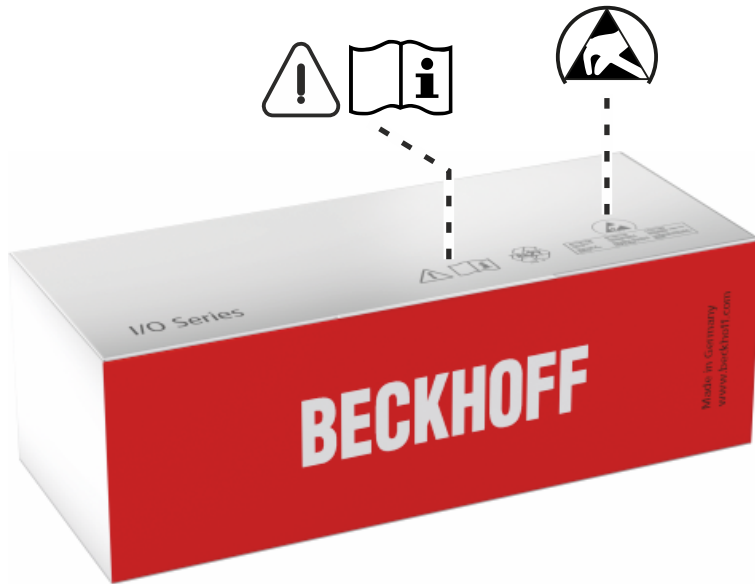
On Beckhoff products you will find attached or lasered safety pictograms, which vary depending on the product. They serve to ensure safety for people and to prevent damage to the products. Safety pictograms must not be removed and must be legible for the user.



-  **Read and observe the operating instructions**
Commissioning is only permitted if the operating instructions have been read and understood beforehand. This applies in particular to the safety instructions and warnings.

-  **Electrostatic sensitive components**
Work with and on the TwinSAFE component is only permitted in protected workplaces.

2.3 General safety instructions

2.3.1 Before operation

Use in machines according to the Machinery Directive

Only use the TwinSAFE component in machines that comply with the Machinery Directive. This is how you ensure safe operation.

Ensure traceability

Ensure the traceability of the TwinSAFE component via the serial number.

Use SELV/PELV power supply

Use a SELV/PELV power supply unit with an output-side voltage limit of $U_{\max} = 36 V_{DC}$ to supply the TwinSAFE component with $24 V_{DC}$.

Failure to observe this will endanger the safety function of the product. Depending on the machine, death and danger to life, serious physical injury and damage to the machine may result.

Carry out commissioning test

Before commissioning, wiring faults to the sensors must be excluded. Before commissioning, carry out a commissioning test. After a successful commissioning test, you can use the TwinSAFE component for the intended safety-related task.

In case of wiring errors, the safety function of the product is at risk. Depending on the machine, death and danger to life, serious bodily injury and damage to the machine may result.

Use permitted engineering tools and procedures

The TÜV SÜD certificate applies to the TwinSAFE component, the function blocks available in it, the documentation and the engineering tool. TwinCAT 3.1 and the TwinSAFE Loader are permitted as engineering tools.

Procedures or engineering tools deviating from this are not covered by the certificate. This applies in particular to externally generated xml files for the TwinSAFE import.

2.3.2 In operation

Interference due to emitted interference

Do not operate the following devices in the vicinity of the TwinSAFE component: for example, radio telephones, radios, transmitters or high-frequency systems.

TwinSAFE components comply with the requirements of the applicable electromagnetic compatibility standards with regard to interference emission and immunity. If you exceed the limits for emitted interference specified in the standards, the function of the TwinSAFE component may be impaired.

2.3.3 After operation

De-energize and switch off components before working on them

Check all safety-relevant equipment for functionality before working on the TwinSAFE component. Secure the working environment. Secure the machine or plant against being inadvertently started up. Observe the chapter [Decommissioning](#) [► 52].

3 System description

3.1 EtherCAT Box Modules

The EtherCAT system has been extended with EtherCAT Box modules with protection class IP67. Through the integrated EtherCAT interface the modules can be connected directly to an EtherCAT network without an additional Coupler Box. The high-performance of EtherCAT is thus maintained into each module.

The extremely low dimensions of only e.g. 126 x 30 x 26.5 mm are identical to those of the Fieldbus Box extension modules. They are thus particularly suitable for use where space is at a premium. The small mass of the EtherCAT modules facilitates applications with mobile I/O interface (e.g. on a robot arm). The EtherCAT connection is established via screened M8 connectors.

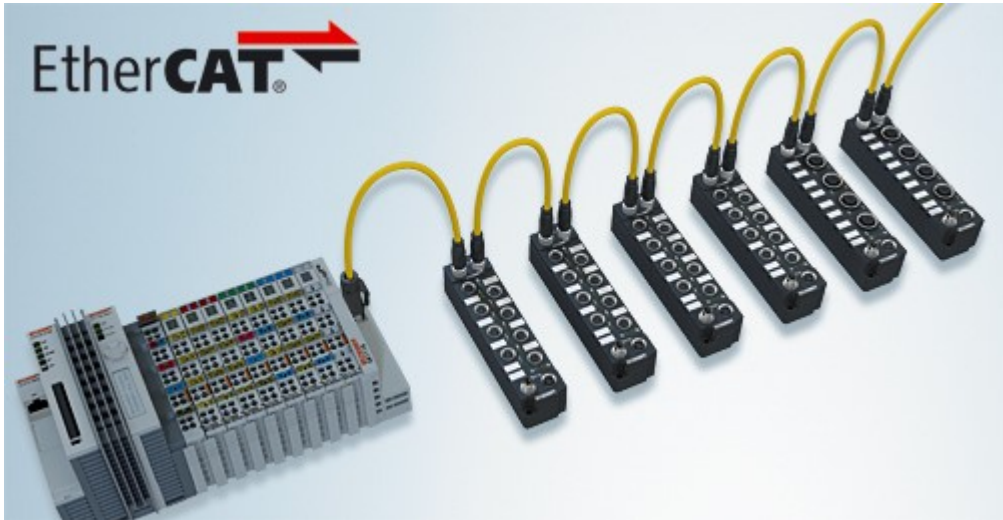

Fig. 1: EtherCAT Box modules extend the EtherCAT system with IP67 protection

The robust design of the EtherCAT Box modules enables them to be used directly at the machine. Control cabinets and terminal boxes are now no longer required. The modules are fully sealed and therefore ideally prepared for wet, dirty or dusty conditions.

Pre-assembled cables significantly simplify EtherCAT and signal wiring. Very few wiring errors are made, so that commissioning is optimized. In addition to pre-assembled EtherCAT, power and sensor cables, field-configurable connectors and cables are available for maximum flexibility. Depending on the application, the sensors and actuators are connected through M8 or M12 connectors.

● Basic EtherCAT documentation

i You will find a detailed description of the EtherCAT system in the Basic System Documentation for EtherCAT, which is available for download from our website (www.beckhoff.com) under *Downloads*.

4 Product description

4.1 EP1957-0022 and EP1957-2222

The EP1957 is an EtherCAT Box with digital inputs for 24 V_{DC} encoders or for potential-free contacts, with digital outputs for 24 V_{DC} actuators. The EtherCAT Box has 8 fail-safe inputs and 4 fail-safe outputs.

With a two-channel connection, the EP1957 meets the requirements of EN 61508-1:2010 SIL 3 and EN ISO 13849-1:2015 (Cat 4, PL e), see chapter [Safe inputs and outputs \[► 19\]](#).

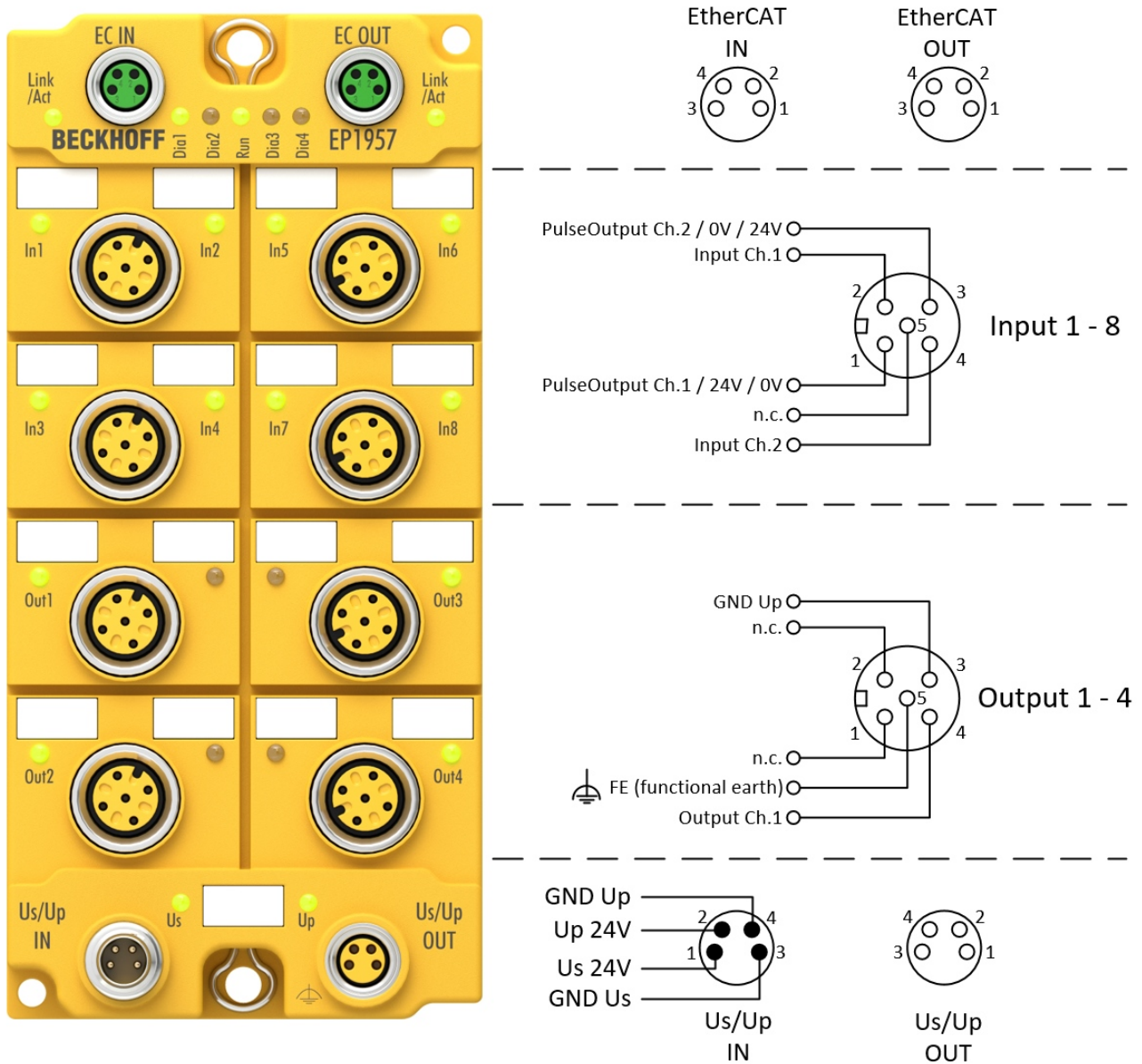

Fig. 2: Connection diagram

The control voltage U_s supplies the module electronics.

The clock outputs / sensor supply voltage (parameterizable) and the safe outputs are supplied from the field voltage U_p .

The TwinSAFE EtherCAT Box has the typical design of an EtherCAT Box with 60mm width.



EP1957 variants

The EP1957 has an integrated safety control that can be used for user-specific applications directly on the component. The variant EP1957-2222 does not have this functionality and represents a pure I/O component.

4.2 Intended use

⚠ WARNING

Caution - Risk of injury!

TwinSAFE components shall only be used for the purposes described below!

The TwinSAFE EtherCAT Box expands the application range of the Beckhoff system with functions that enable it to be used for machine safety applications. The TwinSAFE Boxes are designed for machine safety functions and directly associated industrial automation tasks. They are therefore only approved for applications with a defined fail-safe state. This safe state is the wattless state. Fail-safety according to the relevant standards is required.

The TwinSAFE EtherCAT Box allows the connection of:

24 V_{DC} sensors such as

- emergency stop push buttons, pull cord switches, position switches, two-hand switches, safety mats, light curtains, light barriers, laser scanners etc.
- Safe sensors, which use a 24V_{DC} supply and send safe OSSD signals.

24 V_{DC} actuators such as

- Contactors, protective door switches with tumblers, valves etc.

⚠ WARNING

The fail-safe principle!

The basic rule for a safety system such as TwinSAFE is that failure of a part, a system component or the overall system must never lead to a dangerous condition. The safe state is always the switched off and wattless state.

⚠ WARNING

System limits

The TÜV SÜD certificate applies to this TwinSAFE component, the function blocks available in it, the documentation and the engineering tool. *TwinCAT 3.1* and the *TwinSAFE Loader* are permitted as engineering tools. Any deviations from these procedures or tools, particularly externally generated xml files for TwinSAFE import or externally generated automatic project creation procedures, are not covered by the certificate.

⚠ WARNING

Power supply from SELV/PELV power supply unit!

The TwinSAFE components must be supplied with 24 V_{DC} by an SELV/PELV power supply unit with an output voltage limit U_{max} of 36 V_{DC}. Failure to observe this can result in a loss of safety.

⚠ WARNING

Commissioning test

Before the EP1957 can be used for the safety task, the user must carry out a commissioning test so that sensor and actuator wiring errors can be ruled out.

⚠ CAUTION

Follow the machinery directive!

The TwinSAFE components shall only be used in machines as defined in the machinery directive.

⚠ CAUTION**Ensure traceability!**

The buyer has to ensure the traceability of the device via the serial number.

⚠ CAUTION**Note on approval according to EN 81-20, EN 81-22 and EN 81-50**

- The release does **not** apply to the EL1918-2200, EL2911-2200 and EP1957-2222 variants.
- The TwinSAFE components may only be used in machines that have been designed and installed in accordance with the requirements of the EN 60204-1 standard.
- Provide a surge filter for the supply voltage of the TwinSAFE components against overvoltages (reduction to overvoltage category II).
- EN 81 requires that in the case of devices with internal temperature monitoring, a stop must be reached in the event of an overtemperature. In this case, passengers must be able to disembark (see EN 81-20 chapter 5.10.4.3, for example). To ensure this, application measures are necessary. The internal terminal temperature of the TwinSAFE components can be read out by the user. A direct switch-off occurs at the maximum permissible temperature of the respective TwinSAFE component (see chapter Temperature measurement).
The user must select a temperature threshold below the maximum temperature such that a stop can be reached in all cases before the maximum temperature is reached. Information on the optimum terminal configuration can be found under Notes on the arrangement of TwinSAFE components and under Example configuration for temperature measurement.
- For the use of the TwinSAFE components according to EN 81-22 and EN 81-50, the conditions described in the manuals for achieving category 4 according to EN ISO 13849-1:2015 **must** be observed.
- The use of TwinSAFE components is limited to indoor applications.
- Basic protection against direct contact must be provided, either by fulfilling protection class IP2X or by installing the TwinSAFE components in a control cabinet which corresponds at least to protection class IP54 according to EN 60529.
- The ambient conditions regarding temperature, humidity, heat dissipation, EMC and vibrations, as specified in the operating instructions under technical data, must be observed.
- The operating conditions in potentially explosive atmospheres (ATEX) are specified in the operating instructions.
- The safe state (triggering) of the application must be the de-energized state. The safe state of the TwinSAFE components is always the de-energized, switched-off state, and this cannot be changed.
- The service life specified in the operating instructions must be observed.
- If the TwinSAFE component is operated outside the permissible temperature range, it changes to "Global Shutdown" state.
- The TwinSAFE components must be installed in a control cabinet with protection class IP54 according to EN 60529, so that the requirement for degree of pollution 3 according to EN 60664-1 can be reduced to level 2.
- The TwinSAFE components must be supplied by a SELV/PELV power supply unit with a maximum voltage of $U_{\max} \leq 36 V_{DC}$.

4.3 Technical data

The current certificates of all TwinSAFE products with the underlying standards and directives can be found at <https://www.beckhoff.com/en-en/support/download-finder/certificates-approvals/>.

Product designation	EP1957-0022 and EP1957-2222
Fieldbus	EtherCAT
Number of inputs	8
Number of outputs	4
Input and output connections	M12
Status display	12 (one green LED per input/output) + 5 diagnostic LEDs + 2 LEDs for Us/Up + 2 LEDs for EtherCAT link/act
Response time (read input/write to E-bus)	typical: 4 ms (in default setting without local TwinSAFE logic), maximum: see fault reaction time
Watchdog time	adjustable from 2 ms to 60 s
Fault reaction time	≤ watchdog time
Cable length between sensor and EtherCAT Box	Unshielded: max. 100 m (0.75 or 1 mm ²) Shielded: max. 100 m (0.75 or 1 mm ²)
Output current of the clock outputs (Input Power Mode parameter: diag test pulse)	typically 10 mA
Output current of sensor supply (Input Power Mode parameter: PowerMode A/B)	max. 250 mA
Max. output current clock outputs / sensor supply in the event of an error	max. 3 A (the duration depends on the overtemperature-related shutdown of the output driver)
Safe outputs	max. 0.5 A per channel Diagnostic thresholds: > 4.7 V -> high signal is detected < 1.0 V -> low signal is detected
Input process image	7 bytes
Output process image	7 bytes
Supply voltage for the EP1957	24 V _{DC} (-15% / +20%)
Current consumption U _s (wired with 8 potential-free contacts and 4 outputs)	12 channels occupied: typically 120 mA 0 channels occupied: typically 100 mA (provide 4 A fuse)
Current consumption from U _p (connected with 8 potential-free contacts and 4 actuators, without load currents)	12 channels occupied: approx. 60 mA 0 channels occupied: approx. 20 mA (provide 4 A fuse)
Power loss of the EtherCAT Box	typically 4.7 watts
Electrical isolation (between the channels)	no
Electrical isolation (between the channels and EtherCAT)	yes
Insulation voltage (between the channels and EtherCAT, under common operating conditions)	Insulation tested with 500 V _{DC}
Dimensions (W x H x D)	60 (+0.5) mm x 126 (+0.5) mm x 26.5 mm
Housing material	PBT+PET (Valox 855)
Sealing compound	Polyurethane
Weight	approx. 315 g
Permissible ambient temperature (operation)	-25 °C to +60 °C
Permissible ambient temperature (transport/storage)	-40 °C to +85 °C
Permissible air pressure (operation/storage/transport)	750 hPa to 1100 hPa (this is equivalent to an altitude of approx. -690 m to 2450 m above sea level assuming an international standard atmosphere)
Inadmissible operating conditions	TwinSAFE EtherCAT Boxes must not be used under the following conditions: <ul style="list-style-type: none"> under the influence of ionizing radiation (exceeding the natural background radiation) in corrosive environments
EMC immunity / emission	conforms to EN 61000-6-2 / EN 61000-6-4
Vibration / shock resistance	conforms to EN 60068-2-6 / EN 60068-2-27
Shocks	15 g with pulse duration 11 ms in all three axes
Protection rating (when screwed together)	IP67 (according to EN 60529)
Correct installation position	variable

Product designation	EP1957-0022 and EP1957-2222
Approvals	CE, TÜV SÜD

4.4 Safety parameters

Key data	EP1957-0022 and EP1957-2222
Lifetime [a]	20
Proof test interval [a]	not required ¹
PFH _D	6.50E-09
PFD	8.30E-05
MTTF _D	high
DC	high
Performance level	PL e
Category	4
HFT	1
Classification element ²	Type B

1. Special proof tests throughout the service life of the EtherCAT Box are not required.
2. Classification according to EN 61508-2:2010 (see chapters 7.4.4.1.2 and 7.4.4.1.3)

The EtherCAT Box can be used for safety-related applications according to IEC 61508:2010 up to SIL 3 and EN ISO 13849-1:2015 up to PL e (Cat 4).

Further information on calculating or estimating the MTTF_D value from the PFH_D value can be found in the TwinSAFE Application Guide or in EN ISO 13849-1:2015, Table K.1.

In terms of safety-related parameters, the Safety-over-EtherCAT communication is already considered with 1% of SIL 3 according to the protocol specification.

4.5 Safe inputs and outputs

The safe input modules and corresponding clock outputs have a two-channel design. This has the advantage that a two-channel safe sensor with an M12 connection can be used, and a fault such as cross-circuit or external feed results in shutdown of the whole module.

The safe output modules have a single-channel design.

DANGER

Clocked signals inside a sheathed cable

If clocked signals (clock outputs for the safe inputs and safe outputs) of different modules are used within a sheathed cable, a fault in one module, such as cross-circuit or external feed, must lead to the disconnection of all these modules. This is achieved by setting the *Module Fault Link active* parameter for all modules involved. This parameter is set to TRUE by default. The parameter acts separately for the input and output modules.

DANGER

Safe inputs in Cat.4 / PL e

If two safe input channels are to be used in a category 4 structure that are not on one M12 connector, please make sure to combine always an even and an odd channel number.

4.6 Dimensions

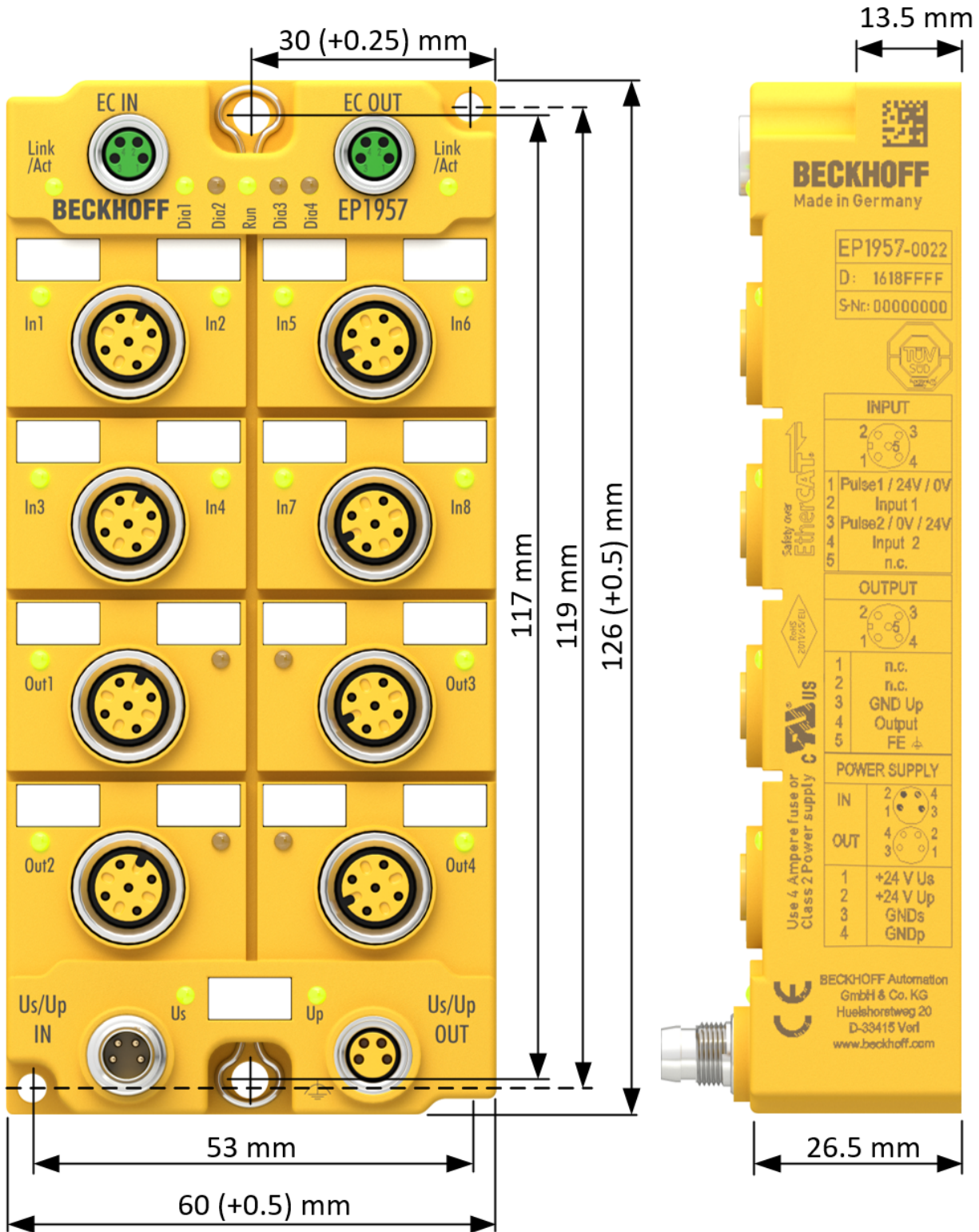

Fig. 3: Dimensions

The EtherCAT Box has the following dimensions:

- Width: 60 (+0.5) mm
- Height: 126 (+0.5) mm
- Depth: 26.5 mm

When fully wired, the connected cables increase the total depth of the module.

5 Operation

5.1 Environmental conditions

Please ensure that the TwinSAFE Boxes are only transported, stored and operated under the specified conditions (see technical data)!

⚠ WARNING

Risk of injury!

The TwinSAFE EtherCAT boxes must not be used under the following conditions.

- under the influence of ionizing radiation (that exceeds the level of the natural environmental radiation)
- in corrosive environments

NOTE

Electromagnetic compatibility

The TwinSAFE components comply with the current standards on electromagnetic compatibility with regard to spurious radiation and immunity to interference in particular.

However, in cases where devices such as mobile phones, radio equipment, transmitters or high-frequency systems that exceed the interference emissions limits specified in the standards are operated near TwinSAFE components, the function of the TwinSAFE components may be impaired.

5.2 Installation

5.2.1 Fixing

● **Protect connectors against soiling!**

i Protect all connections from contamination during installation and operation of the modules! Protection class IP67 is only guaranteed if all cables and plug connectors are connected, and unused connections are protected with the appropriate cover plugs!
Connector sets see catalog.

- Modules with narrow housing are installed with two M3 screws.
- Modules with wide housing are installed with two M3 screws in the mounting holes in the corners or two M4 screws in the central mounting holes (see also chapter [Power connection and grounding](#) [▶ 24]).
- The bolts must be longer than 15 mm. The fastening holes in the modules have no thread.
- Note when mounting that the overall height is increased further by the fieldbus connections.

Mounting rail ZS5300-0001

The mounting rail ZS5300-0001 (500 mm x 129 mm) allows time-saving configuration of the modules.

The rail is made of 1.5 mm thick stainless steel (V2A) and features ready-made M3 threads. The rail has 5.3 mm slots for mounting on the machine with M5 screws.

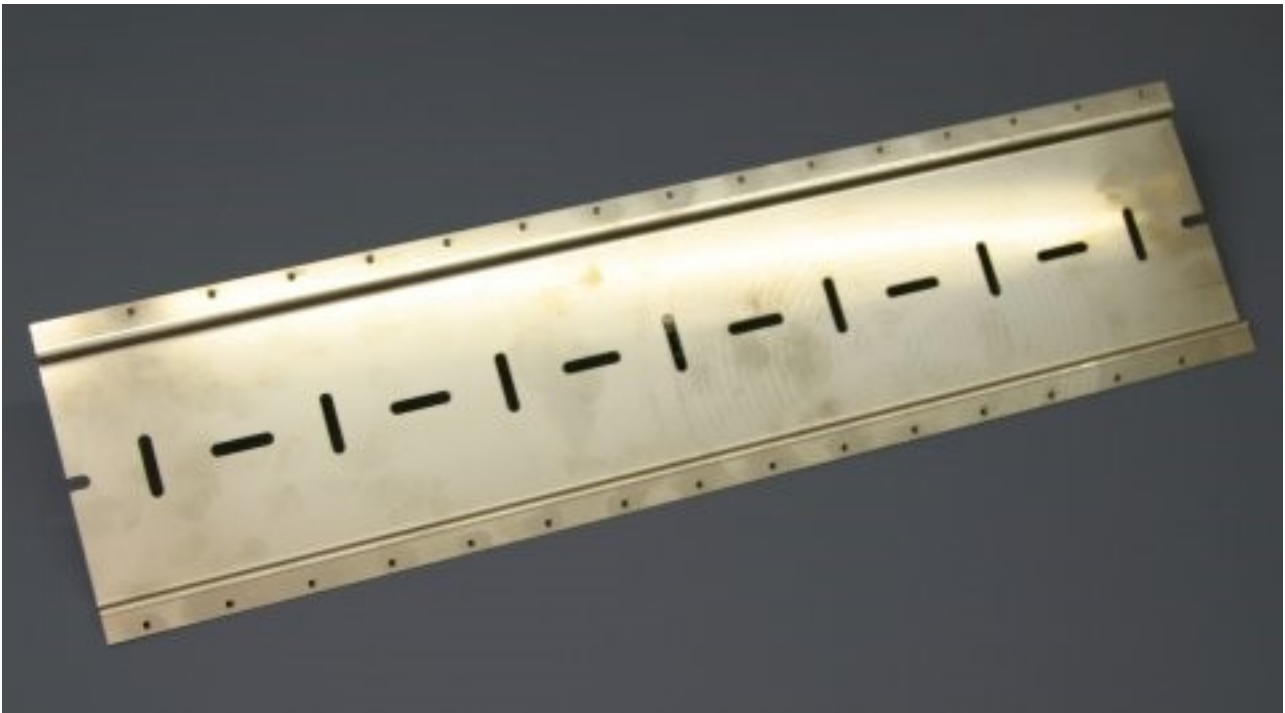

Fig. 4: Mounting rail ZS5300-0001

The mounting rail is 500 mm long and enables the installation of 15 narrow modules, with a distance of 2 mm between them. It can be shortened as required for your particular application.

Mounting Rail ZS5300-0011

The mounting rail ZS5300-0011 (500 mm x 129 mm) has in addition to the M3 treads also pre-made M4 treads to fix 60 mm wide modules via their middle holes.

Up to 14 narrow or 7 wide modules may be mixed mounted.

5.2.2 Connection

5.2.2.1 Tightening torque for connectors

The plug connectors should be tightened with the recommended torque.

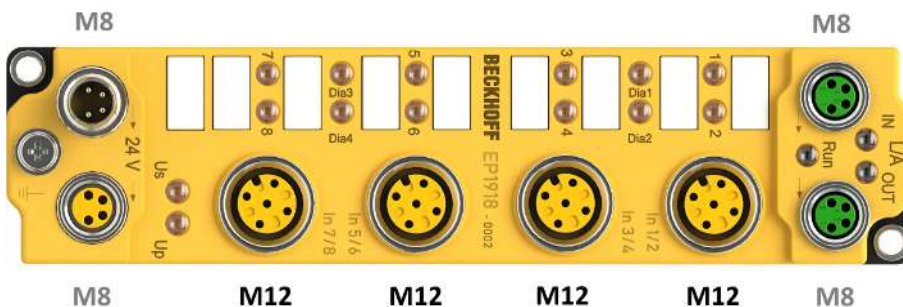

Fig. 5: EtherCAT Box with M8 and M12 connectors

Type	Connection	Nm	ft-lb
M8	Power supply, EtherCAT	0,4	0,3
M12	Input signals	0,6	0,44

Torque wrench



Fig. 6: Torque wrench ZB8801

- i** **Ensure the proper torque is used**
 Use torque wrenches available from Beckhoff to tighten the plug connectors (see accessories!)

5.2.2.2 EtherCAT connection

The EtherCAT Box (EPxxxx) has two M8 connectors marked **green** for the incoming and outgoing EtherCAT connection.



Fig. 7: EtherCAT connection 30 mm housing M8

Connection

There are various different standards for the assignment and colors of connectors and cables for EtherCAT.

EtherCAT		Connector	Cable		Standard
Signal	Description	M8	ZB9010, ZB9020, ZK1090-6292	ZB903x, ZK1090-31xx	TIA-568B
Tx +	Transmit Data+	Pin 1	yellow ¹	orange/white ²	white/orange
Tx -	Transmit Data-	Pin 4	orange ¹	orange ²	orange
Rx +	Receive Data+	Pin 2	white ¹	blue/white ²	white/green
Rx -	Receive Data-	Pin 3	blue ¹	blue ²	green
Shield	Shield	Housing	Shield	Shield	Shield

¹) Core colors according to EN 61918

²) Core colors

5.2.2.3 EtherCAT cables

For connecting EtherCAT devices only Ethernet cables that meet the requirements of at least **category 5 (CAT5) according to EN 50173 or ISO/IEC 11801** should be used.

i Wiring recommendations

Detailed recommendations for EtherCAT wiring can be found in the documentation "Design recommendations for EtherCAT/Ethernet infrastructure", which is available for download from www.Beckhoff.de.

EtherCAT uses four cable wires for signal transmission. Due to automatic cable detection (auto-crossing) symmetric (1:1) or cross-over cables can be used between EtherCAT devices from BECKHOFF.

5.2.2.4 Power connection and grounding

This chapter provides basic information about the power supply and grounding of the EP1957 TwinSAFE EtherCAT Box. In particular, please note that the *General information on connecting the functional earth* only serves as an example.

Supply voltages (power connection)

The supply and distribution of the supply voltages takes place via the connections:

- **Us/Up IN** for feeding in the supply voltages
- **Us/Up OUT** for forwarding the supply voltages.

Both connections have an M8 thread and are located to the left (Us/Up IN) and right (Us/Up OUT) of the TwinSAFE EtherCAT Box (see figure: *EP1957 - power connection*).

Information: An overview of pin assignment for the two connections can be found later in this chapter.

General information for connecting the functional earth

The grounding lugs of the EP1957 are internally connected to the safe outputs (pin 5 of the M12 connections).

To provide functional earthing  , if possible the connection should:

- have a large surface
- have low resistance and
- be permanent.

In order to establish a permanent connection, all operating states of the machine, such as vibrations, must be taken into account.

The connection can be established using the following two methods:

1. via a bolted connection from the TwinSAFE EtherCAT Box to the machine bed
2. through a ring terminal (hole dia. 4.3 mm) with cable connection to the functional earth

A grounding lug is available at the upper and lower mounting points (hole dia. 5 mm for M4 thread) on the housing.

NOTE



Connecting the functional earth

The functional earth connection should have low resistance and a large surface.



Power connection

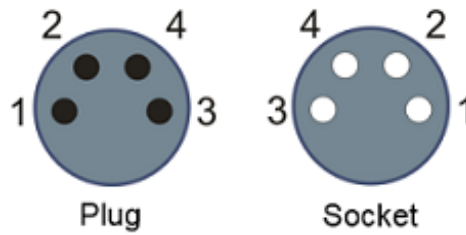

M8 - pin assignment

Contact	Voltage
1	Control voltage Us, +24 V _{DC}
2	Peripheral voltage Up, +24 V _{DC}
3	GND Us
4	GND Up
	Connecting the functional earth

The contacts of the M8 connectors can conduct a maximum current of 4 A.

Two LEDs indicate the status of the supply voltages.

NOTE

Do not confuse the power port with EtherCAT port!

Never connect the power cables (M8, 24 V_{DC}) to the green-marked EtherCAT sockets of the EtherCAT Box modules. This can cause the destruction of the modules!

Control voltage Us

The fieldbus and the processor logic are supplied from the 24 V_{DC} control voltage Us. The control voltage is electrically isolated from the fieldbus circuitry.

Peripheral voltage Up

The peripheral voltage Up supplies the digital clock outputs, the safe inputs and the safe outputs.

Redirection of the supply voltages

The power IN and OUT connections are bridged in the module. Hence, the supply voltages Us and Up can be passed from EtherCAT Box to EtherCAT Box in a simple manner.

⚠ CAUTION

Note the maximum current!

For the distribution of the supply voltages Us and Up, please note that the maximum permitted current of 4 A for the respective contacts of the M8 plug connector should not be exceeded, even in the event of a fault, e.g. short circuit!

5.2.2.5 Signal connection for inputs

The EtherCAT Box has eight fail-safe inputs.

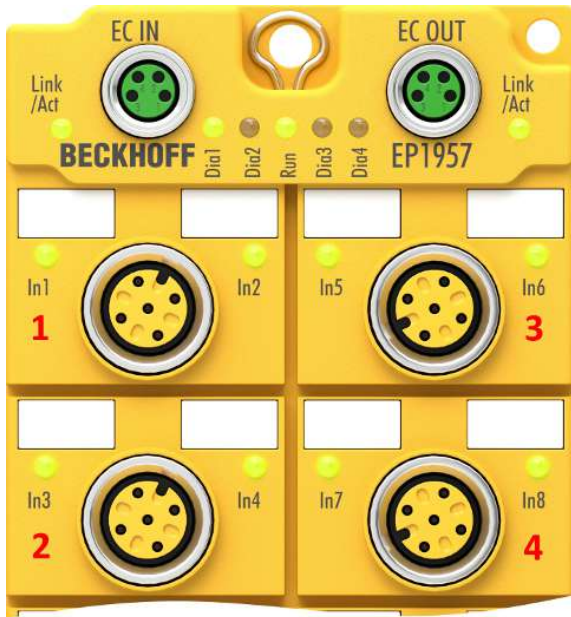

Fig. 8: Safe inputs 1 to 8

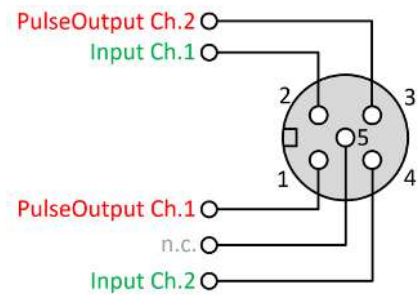

Fig. 9: PinOut default setting

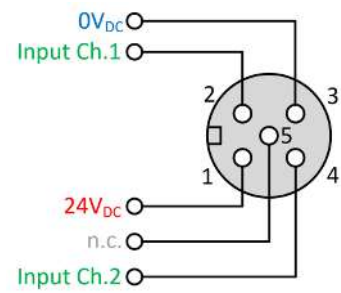

Fig. 10: PinOut alternative 1 (parameter input power mode = power mode A)

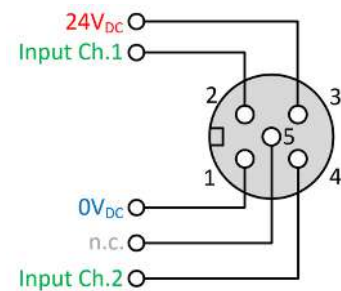

Fig. 11: PinOut alternative 2 (parameter input power mode = power mode B)

M12 connection (numbered in red)	Contact	Channel	Signal	Alternative 1: Parameter PowerMode A	Alternative 2: Parameter PowerMode B
1	1	1	Pulse output 1	24 V _{DC} sensor power supply	0 V _{DC} sensor power supply
	2		Input 1	Input 1	Input 1
	3	2	Pulse output 2	0 V _{DC} sensor power supply	24 V _{DC} sensor power supply
	4		Input 2	Input 2	Input 2
	5	-	not connected	not connected	not connected
2	1	3	Pulse output 3	24 V _{DC} sensor power supply	0 V _{DC} sensor power supply
	2		Input 3	Input 3	Input 3
	3	4	Pulse output 4	0 V _{DC} sensor power supply	24 V _{DC} sensor power supply
	4		Input 4	Input 4	Input 4
	5	-	not connected	not connected	not connected
3	1	5	Pulse output 5	24 V _{DC} sensor power supply	0 V _{DC} sensor power supply
	2		Input 5	Input 5	Input 5
	3	6	Pulse output 6	0 V _{DC} sensor power supply	24 V _{DC} sensor power supply
	4		Input 6	Input 6	Input 6
	5	-	not connected	not connected	not connected
4	1	7	Pulse output 7	24 V _{DC} sensor power supply	0 V _{DC} sensor power supply
	2		Input 7	Input 7	Input 7
	3	8	Pulse output 8	0 V _{DC} sensor power supply	24 V _{DC} sensor power supply
	4		Input 8	Input 8	Input 8
	5	-	not connected	not connected	not connected

● Sensor power supply

i For the sensor supply, please ensure that the maximum current consumption does not exceed 250 mA and the parameter *Diag TestPulse active* is set to FALSE.

⚠ CAUTION

Configurable inputs

The inputs 1 to 8 can be occupied as you want with normally closed contacts or normally open contacts. The corresponding evaluation takes place in the safety controller. Alternatively, a safe sensor can be supplied with 24 V_{DC}, instead of the clock outputs for potential-free contacts. The polarity of pins 1 and 3 can be parameterized. Detection of cross-circuits or external feeds must take place via the connected safe sensor.

● Functional earth

i Pin 5 of the M12 connections is not connected to the functional ground, since an SELV/PELV power supply unit is specified for the EtherCAT Box.

5.2.2.6 Characteristic curve of the inputs

The characteristic curve of the inputs is similar to type 3 according to EN 61131-2.

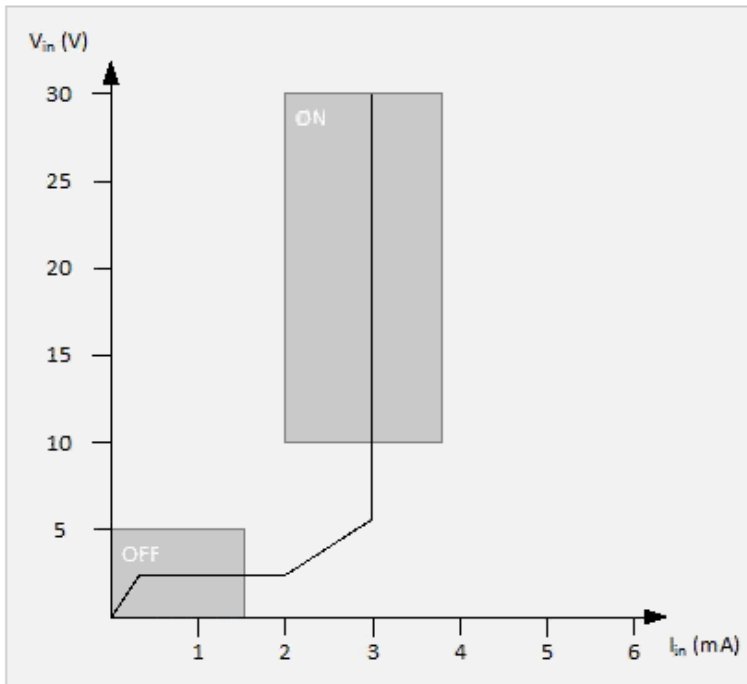

Fig. 12: Characteristic curve of the inputs

5.2.2.7 Signal connection for outputs

The EtherCAT Box has 4 safe outputs, each with a maximum output current of 0.5 A.

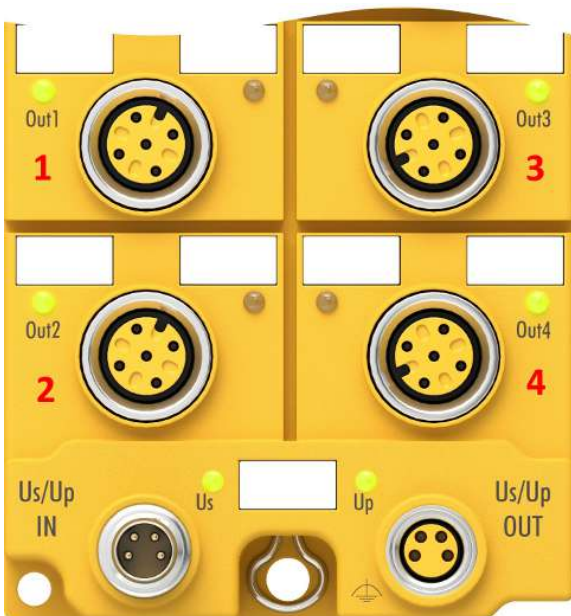

Fig. 13: Safe outputs 1 to 4

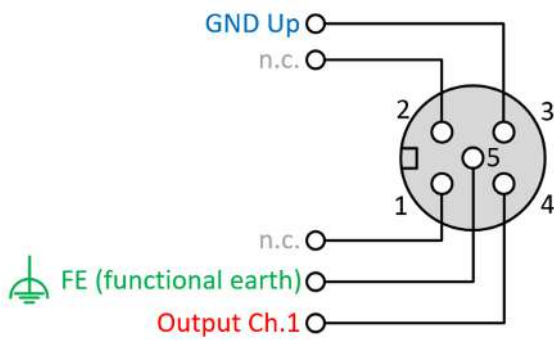

Fig. 14: PinOut safe output

M12 connection (numbered in red)	Contact	Channel	Signal
1	1	-	not connected
	2		not connected
	3	1	GND Up
	4		Output 1
	5	-	Functional earth FE
2	1	-	not connected
	2		not connected
	3	2	GND Up
	4		Output 2
	5	-	Functional earth FE
3	1	-	not connected
	2		not connected
	3	3	GND Up
	4		Output 3
	5	-	Functional earth FE
4	1	-	not connected
	2		not connected
	3	4	GND Up
	4		Output 4
	5	-	Functional earth FE

Functional earth

The functional earth on pin 5 of the M12 connections of the outputs is internally connected to the grounding lugs of the EtherCAT Box.

5.2.2.8 Overvoltage protection

If protection against overvoltage is necessary in your system, provide a protective circuit (surge filter) against overvoltage for the power supply to the EtherCAT Box.

5.2.3 Temperature measurement

The temperature measurement of the EP boxes consists of a single box which is wired with corresponding supply and communication lines. The inputs and/or outputs of the EP Box are switched on for the test.

NOTE

External heat sources / radiant heat / impaired convection

The maximum permissible ambient temperature of 60°C was tested with the example configuration described above. Impaired convection or an unfavorable location near heat sources may result in overheating of the TwinSAFE components.

The key parameter is always the maximum permitted internally measured temperature of 110°C, above which the TwinSAFE components switch to safe state and report an error. The internal temperature can be read from the TwinSAFE components via CoE.

5.2.4 Signal cables

Permitted cable length

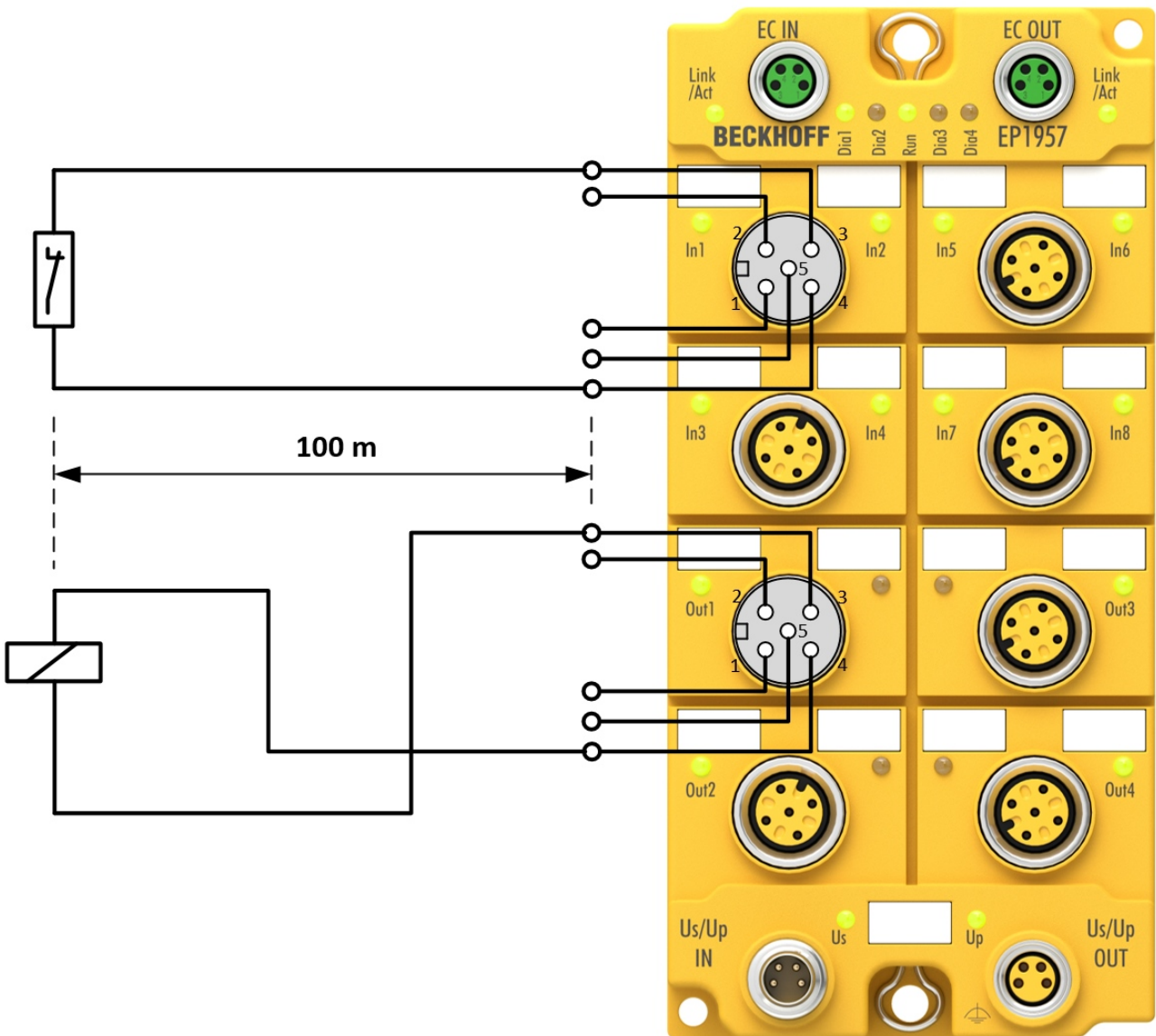

Fig. 15: Signal lines

When connecting a single switching contact via a dedicated continuous cable (or via a sheathed cable), the maximum permitted cable length is 100 m if a sensor test is active.

The use of contact points, connectors or additional switching contacts in the cabling reduces the maximum propagation.

Cable routing

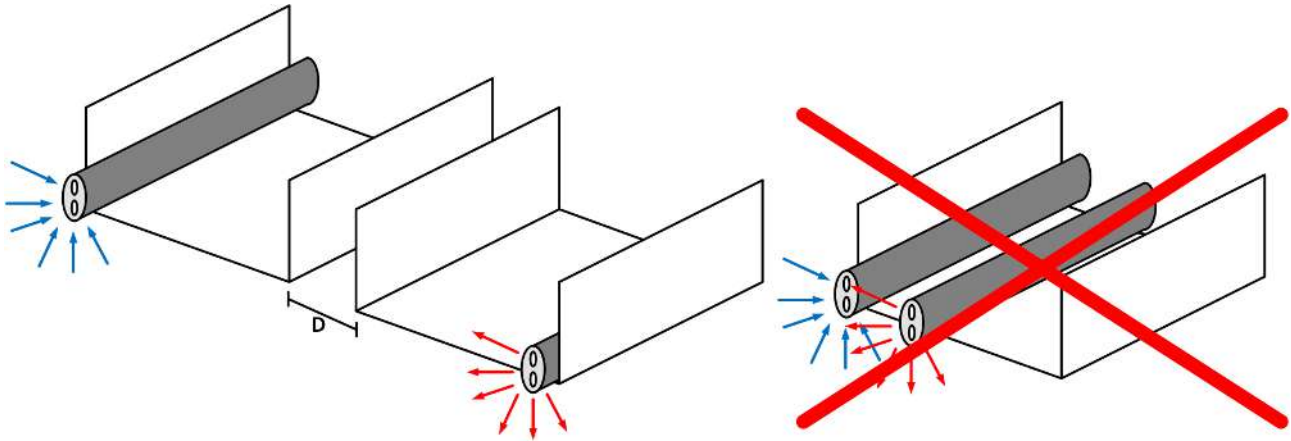

Fig. 16: Cable routing

NOTE

Route the signal cable separately

The signal cable must be routed separately from potential sources of interference, such as motor supply cables, 230 V_{AC} power cables etc.!

Interference caused by cables routed in parallel can influence the signal form of the test pulses and thus cause diagnostic messages (e.g. sensor errors or OpenLoad errors).

D: Distance between the cable ducts should be as large as possible

blue arrows: signal line

red arrows: potential source of interference

The common routing of signals together with other clocked signals in a common cable also reduces the maximum propagation, since crosstalk of the signals can occur over long cable lengths and cause diagnostic messages.

5.3 Configuration of the EtherCAT Box in TwinCAT

● Identical configuration

The configuration of the EtherCAT Box in TwinCAT is identical for the variant EP1957-2222.

5.3.1 Adding an EtherCAT device

See TwinCAT automation software documentation.

5.3.2 Adding an EP1957

An EP1957 is added in exactly the same way as any other Beckhoff EtherCAT Box. Open the *TwinSAFE Fieldbus Boxes* item in the list and select the EL1957.

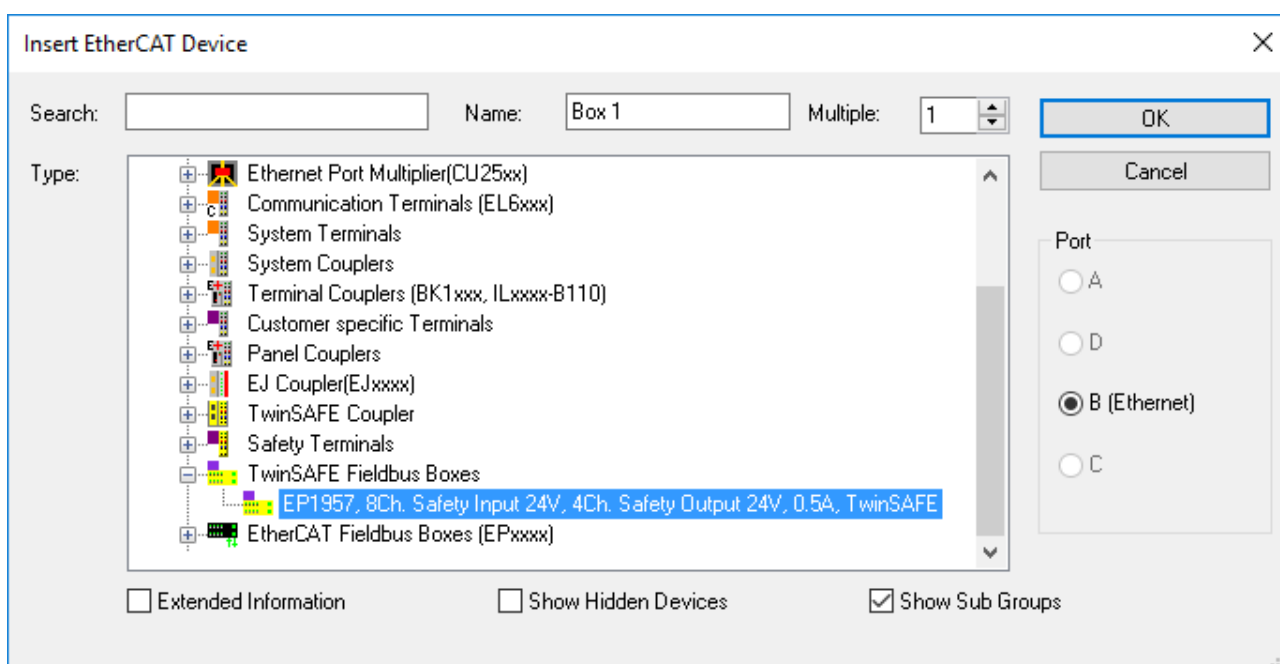

Fig. 17: Adding an EP1957

5.3.3 EP1957-0022: using the integrated TwinSAFE Logic functions

● Does not apply to EP1957-2222

Since the EP1957-2222 variant is a pure I/O component, this chapter does not apply to the EP1957-2222.

On delivery, the EP1957 behaves like a safe TwinSAFE I/O slave, which can be used as an alias device within a TwinSAFE Logic, e.g. EL6910.

Alternatively, the local logic function of the EP1957 can be used. To this end please create a TwinSAFE project in the Safety Editor and select the EP1957 as the target system. Further information on creating a project can be found in the EL6910 documentation and the description of the function blocks under <http://www.beckhoff.de/german/download/twinsafe.htm>.

In order to be able to use the EP1957 again as a safe TwinSAFE I/O slave, please delete the logic, the mapping and the parameter data on the EtherCAT Box and switch the voltage off and on again.

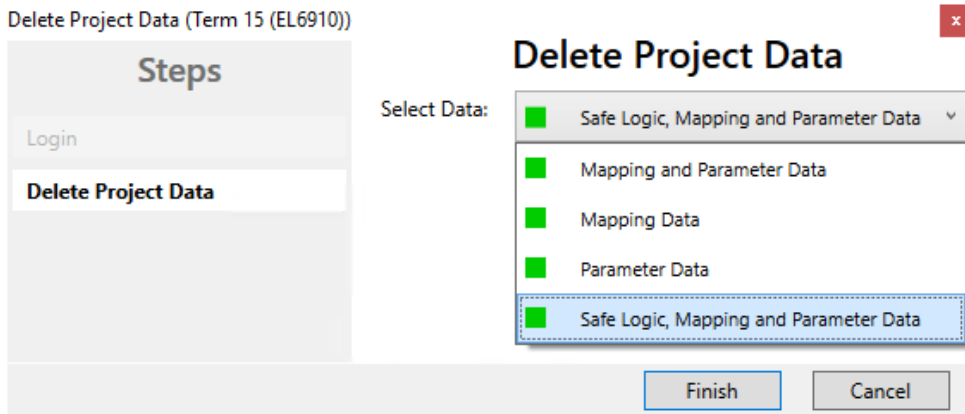

Fig. 18: EP1957 - Delete project data

5.3.3.1 Project design limits of EP1957

i **Project design limits**

The maximum project design size for EP1957 is determined by the available memory. This is managed dynamically. The values specified in the following table are therefore only guide values and may differ from the actual values, depending on the safety project.

NOTE

Execution time of the logic function

The execution time of the logic program - with identical logic program - will typically be longer compared to the EL6910, since the safe I/O signals must be processed additionally. This also has a corresponding effect on the processing of the I/O signals, since with increasing project size these can only be evaluated with a lower frequency.

Process image size	max. 1486 byte per data direction (Maximum memory size 0x1E00 for 3 buffers, ie with the same size of input and output process data, a maximum size of 1280 bytes per data direction is possible. Only straight start addresses are possible, so fill bytes must be taken into account.)
TwinSAFE connections	128 max. (up to 255 CRCs in total; 1 CRC is required for a TwinSAFE connection with 1 or 2 byte safe data.)
Safe data per TwinSAFE connection	maximum 126 byte (telegram length 255 byte)
TwinSAFE blocks	maximum 512 (For using ESTOP function blocks with complete input and output mapping. Other function blocks can lead to a smaller maximum number.)
TwinSAFE groups	128 max.
TwinSAFE user	40 max.
Standard PLC inputs	dynamic (memory-dependent), max. 1483 byte
Standard PLC outputs	dynamic (memory-dependent), max. 1483 byte

NOTE

Project development

TwinCAT 3.1 Build 4022.25 or newer is required to use the internal logic functions. If the EP1957 is used as TwinSAFE slave with the default project, at least an EL6910, EK1960 or newer logic component is required as TwinSAFE master.

5.3.4 Address settings on the TwinSAFE EtherCAT Box

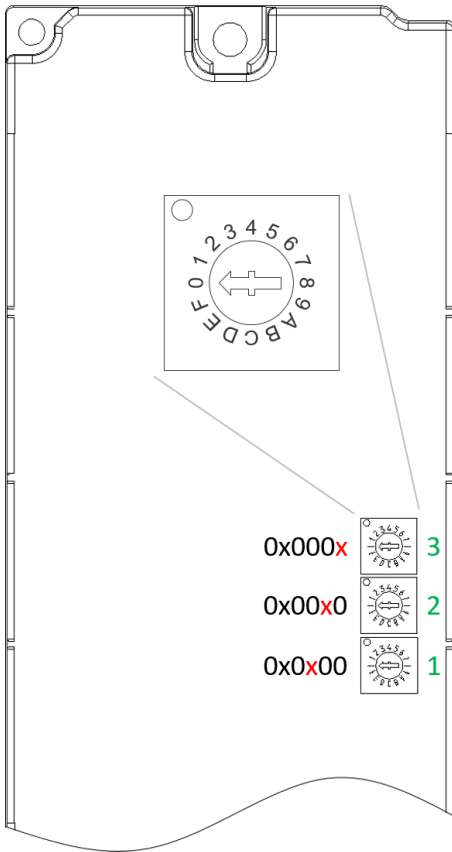

Fig. 19: Rotary switches on the underside

The TwinSAFE address of the Box must be set using the three rotary switches on the underside of the TwinSAFE-EP Box. TwinSAFE addresses between 1 and 4095 are available.

Rotary switch			Address
1 (bottom)	2 (center)	3 (top)	
0	0	1	1
0	0	2	2
0	0	3	3
...
0	0	F	15
0	1	0	16
0	1	1	17
...
0	F	F	255
1	0	0	256
1	0	1	257
...
F	F	F	4095

⚠ WARNING

TwinSAFE address

Each TwinSAFE address set may only occur once within a network or configuration. The address 0 is not a valid address.

5.3.5 Alias devices

The communication between the safety logic and the I/O level is realized via an alias level. At this alias level (subnode *Alias Devices*) corresponding alias devices are created for all safe inputs and outputs, and also for standard signal types. For the safe inputs and outputs, this can be done automatically via the I/O configuration.

The connection- and device-specific parameters are set via the alias devices.

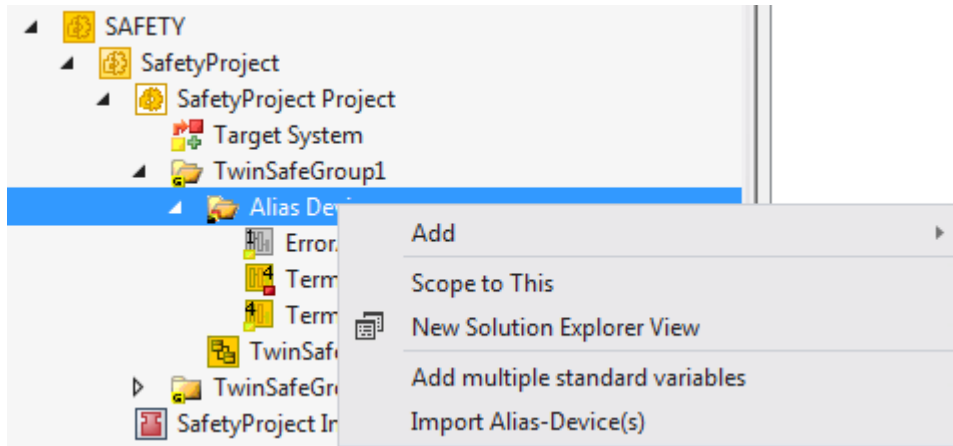

Fig. 20: Starting the automatic import from the I/O configuration

If the automatic import is started from the I/O configuration, a selection dialog opens, in which the individual terminals to be imported can be selected.

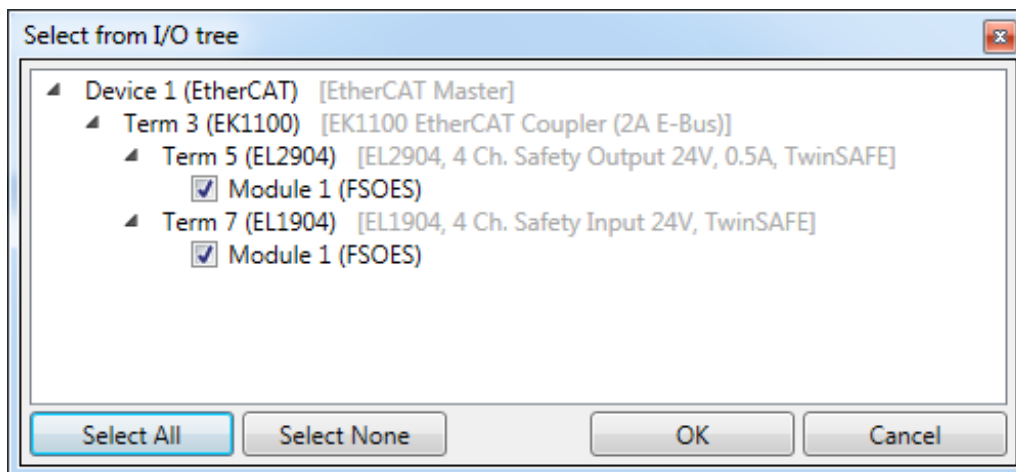

Fig. 21: Selection from the I/O tree

The alias devices are created in the safety project when the dialog is closed via OK.

Alternatively, the user can create the alias devices individually. To this end select *Add* and *New item* from the context menu, followed by the required device.

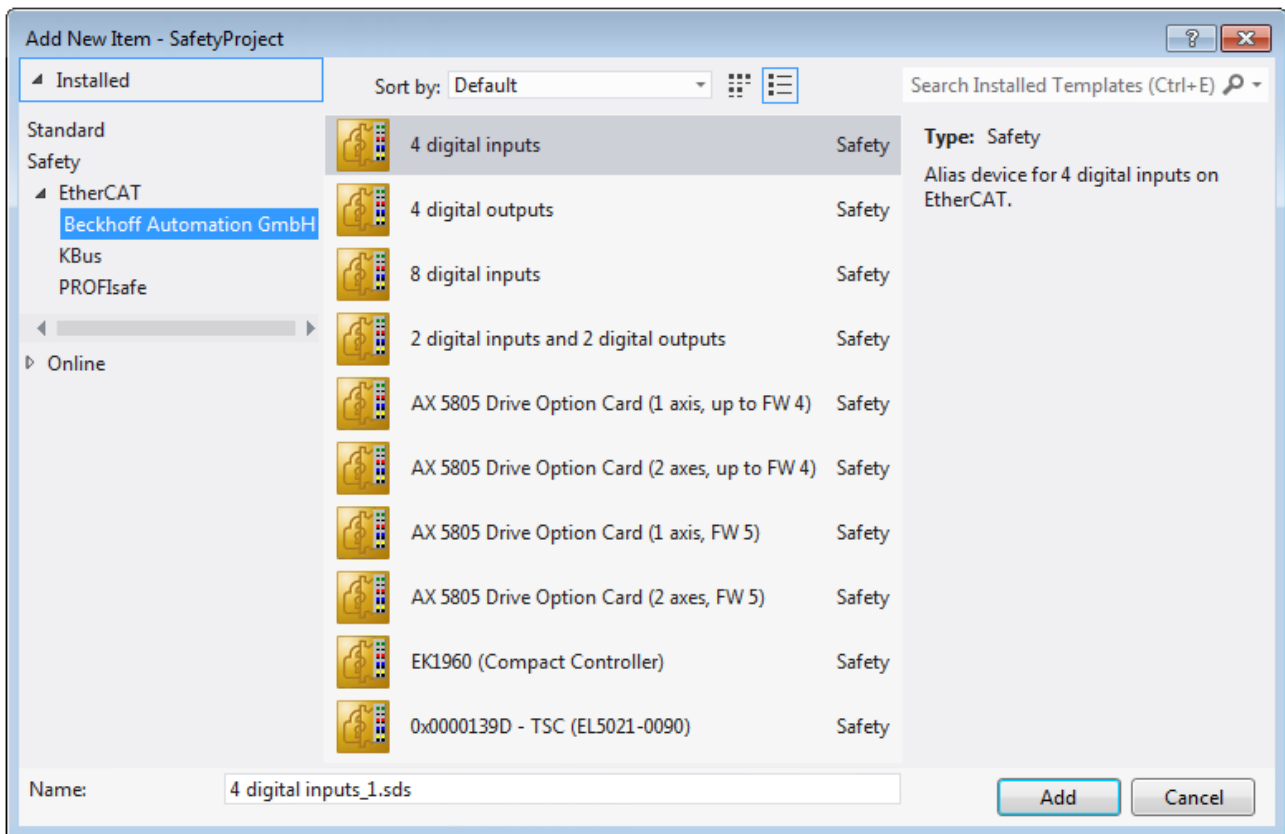

Fig. 22: Creating alias devices by the user

5.3.6 EP1957 parameters

After creating the alias device, it can be parameterized according to the user specifications. The FSoE address is set under the *Linking* tab, and the link to the physical device is created.

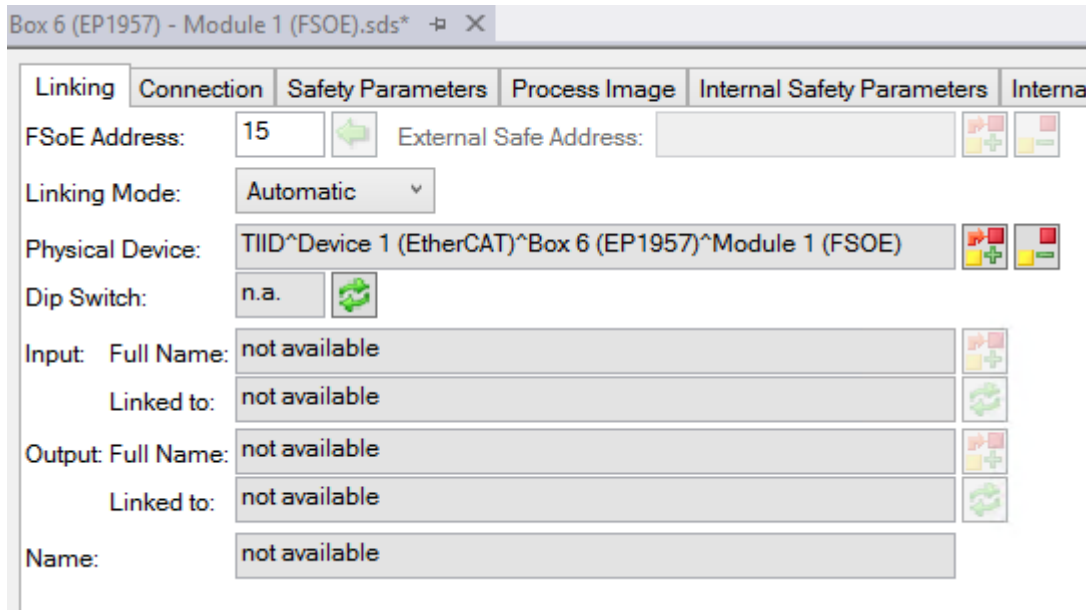

Fig. 23: *Linking* tab

Name	Description
FSoE address	Parameterized FSoE address (to be set by the user)
External safe address	currently not supported
Linking mode	<ul style="list-style-type: none"> • Automatic (automatic linking to the physical device) • Manual (manual linking, e.g. to network variables) • Local (signals are used in the local logic)
Physical device	Link to the TwinSAFE component within the TwinCAT solution
DIP switch	DIP or rotary switch address read from the TwinSAFE component
Input: Full Name	In manual mode: Display of the variables below the TwinSAFE Logic, e.g. EL6910
Input: Linked to:	In manual mode: display of the linked variables
Output: Full Name	In manual mode: Display of the variables below the TwinSAFE Logic, e.g. EL6910
Output: Linked to	In manual mode: display of the linked variables
Name	In manual mode: name of the TwinSAFE message below the TwinSAFE Logic and for the info data

Under the *Connection* tab you can make further settings, e.g. the mapping of the info data or the behavior in case of a module error.

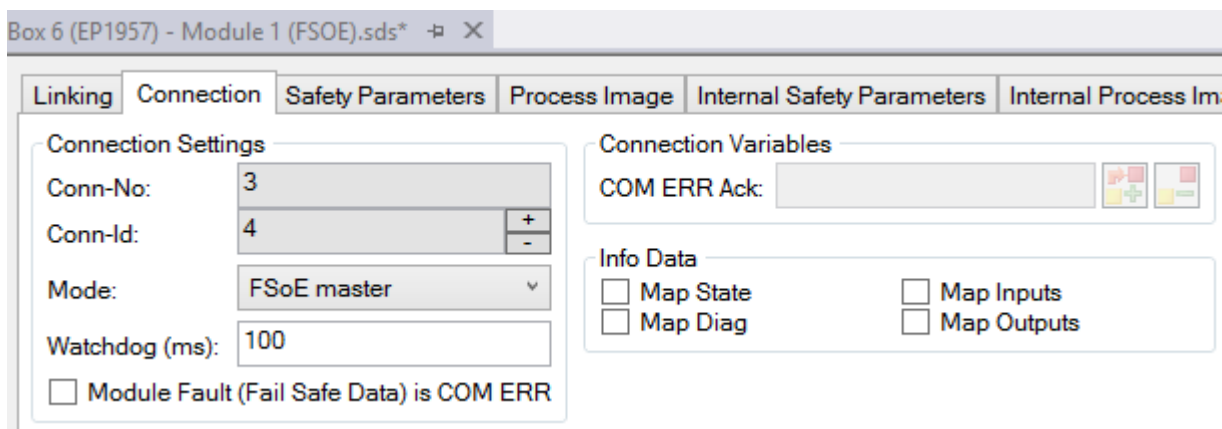

Fig. 24: *Connection* tab

Name	Description
Conn. no.	Connection number (issued by the system)
Conn. Id	Connection ID: preallocated by the system, but can be changed by the user. The connection ID must be unique within the TwinCAT project.
Mode	<ul style="list-style-type: none"> • FSoE master (the logic is the master for this alias device) • FSoE slave (the logic is a slave for this alias device)
Watchdog	Setting the watchdog time in ms for this connection. This setting directly affects the fault reaction time.
Module Fault is ComError	If the checkbox is checked, module error also triggers a ComError, which switches the TwinSAFE group where the connection was created to the error state.
Com ERR Ack	For each connection, an additional error acknowledge can be configured. In this case, the connection must also be acknowledged, in addition to the Err Ack for the respective group.
Map state	The connection state is placed in the cyclic process data.
Map diag	The connection diagnostics is placed in the cyclic process data.
Map inputs	The safe input information of the connection is placed in the cyclic process data.
Map outputs	The safe output information of the connection is placed in the cyclic process data.

The *Safety Parameters* tab contains the parameters of the EP1957 to be set. The outputs are parameterized via the objects 0x8000 etc. The inputs are configured via the objects 0x8040 etc.

Linking	Connection	Safety Parameters	Process Image	Internal Safety Parameters	Internal Process Image
Index	Name	Value	Unit		
8000:0	FSOUT Module 1 Settings Common	>7<			
8000:01	ModuloDiagTestPulse	0x00 (0)			
8000:02	MultiplierDiagTestPulse	0x01 (1)			
8000:03	Standard Outputs active	FALSE (0)			
8000:04	Diag TestPulse active	TRUE (1)			
8000:07	Module Fault Link active	TRUE (1)			
8010:0	FSOUT Module 2 Settings Common	>7<			
8020:0	FSOUT Module 3 Settings Common	>7<			
8030:0	FSOUT Module 4 Settings Common	>7<			
8040:0	FSIN Module 1 Settings Common	>12<			
8040:01	ModuloDiagTestPulse	0x00 (0)			
8040:02	MultiplierDiagTestPulse	0x01 (1)			
8040:04	Diag TestPulse active	TRUE (1)			
8040:05	Module Fault Link active	TRUE (1)			
8040:0C	Input Power Mode	Diag TestPulse (1)			
8041:0	FSIN Module 1 Settings Channel	>5<			
8041:01	Channel 1.InputFilterTime	0x000A (10)	x 0.1 ms		
8041:02	Channel 1.DiagTestPulseFilterTime	0x0002 (2)	x 0.1 ms		
8041:04	Channel 2.InputFilterTime	0x000A (10)	x 0.1 ms		
8041:05	Channel 2.DiagTestPulseFilterTime	0x0002 (2)	x 0.1 ms		
8050:0	FSIN Module 2 Settings Common	>12<			
8051:0	FSIN Module 2 Settings Channel	>5<			
8060:0	FSIN Module 3 Settings Common	>12<			
8061:0	FSIN Module 3 Settings Channel	>5<			
8070:0	FSIN Module 4 Settings Common	>12<			
8071:0	FSIN Module 4 Settings Channel	>5<			

Edit

Fig. 25: Safety Parameter tab

Index	Name	Default value/ unit	Description
8000:01	ModuloDiagTestPulse (FSOUT Module 1)	0x00 / integer	Modulo value for the frequency of the generation of a test pulse. 0 -> every time 1 -> every second time and so on
8000:02	MultiplierDiagTestPulse (FSOUT Module 1)	0x01 / integer	Length of the test pulse in multiples of 400 µs
8000:03	Standard Outputs active (FSOUT Module 1)	FALSE / Boolean	Activation of the logical AND operator of the safe and standard outputs of the module
8000:04	Diag TestPulse active (FSOUT Module 1)	TRUE / Boolean	Activation of test pulses for the corresponding output module
8000:07	Module Fault Link active	TRUE / Boolean	If a module error occurs in this module, a module error is also set for all other output modules of this TwinSAFE component for which this parameter is also set to TRUE.
8010:01-04	Parameters for FSOUT module 2	see module 1	see module 1
8020:01-04	Parameters for FSOUT module 3	see module 1	see module 1
8030:01-04	Parameters for FSOUT module 4	see module 1	see module 1
8040:01	ModuloDiagTestPulse (FSIN Module 1)	0x00 / integer	Modulo value for the frequency of the generation of a test pulse. 0 -> every time 1 -> every second time and so on
8040:02	MultiplierDiagTestPulse (FSIN Module 1)	0x01 / integer	Length of the test pulse in multiples of 400 µs
8040:04	Diag TestPulse active (FSIN Module 1)	TRUE / Boolean	Activation of test pulses for the corresponding input module

Index	Name	Default value/ unit	Description
8040:05	Module Fault Link active	TRUE / Boolean	If a module error occurs in this module, a module error is also set for all other input modules of this TwinSAFE component for which this parameter is also set to TRUE.
8040:0C	Input Power Mode (FSIN Module 1)	Diag test pulse / ENUM	<ul style="list-style-type: none"> • Diag test pulse • PowerMode A (<i>Diag TestPulse active</i> must be FALSE) • PowerMode B (<i>Diag TestPulse active</i> must be FALSE) see chapter Signal connection for inputs [► 26]
8041:01	Channel1.InputFilterTime	0x000A / 0.1 ms	Input filter of the safe input. Following this time the internal input signal changes to the applied signal state. Internal test pulses can have a length of up to 2 ms.
8041:02	Channel1.DiagTestPulseFilter Time	0x0002 / 0.1 ms	Input filter for the test pulse signal
8041:04	Channel2.InputFilterTime	0x000A / 0.1 ms	Input filter of the safe input. Following this time the internal input signal changes to the applied signal state. Internal test pulses can have a length of up to 2 ms.
8041:05	Channel2.DiagTestPulseFilter Time	0x0002 / 0.1 ms	Input filter for the test pulse signal
8050:01-0C	Parameters for FSIN module 2	see module 1	see module 1
8051:01-05	Parameters for FSIN module 2	see module 1	see module 1
8060:01-0C	Parameters for FSIN module 3	see module 1	see module 1
8061:01-05	Parameters for FSIN module 3	see module 1	see module 1
8070:01-0C	Parameters for FSIN module 4	see module 1	see module 1
8071:01-05	Parameters for FSIN module 4	see module 1	see module 1

5.3.7 Process image of the EP1957

The process image of EP1957 consists of 7 bytes of input data and 7 bytes of output data. Each of these 7-byte telegrams contains 2 bytes of safe data.

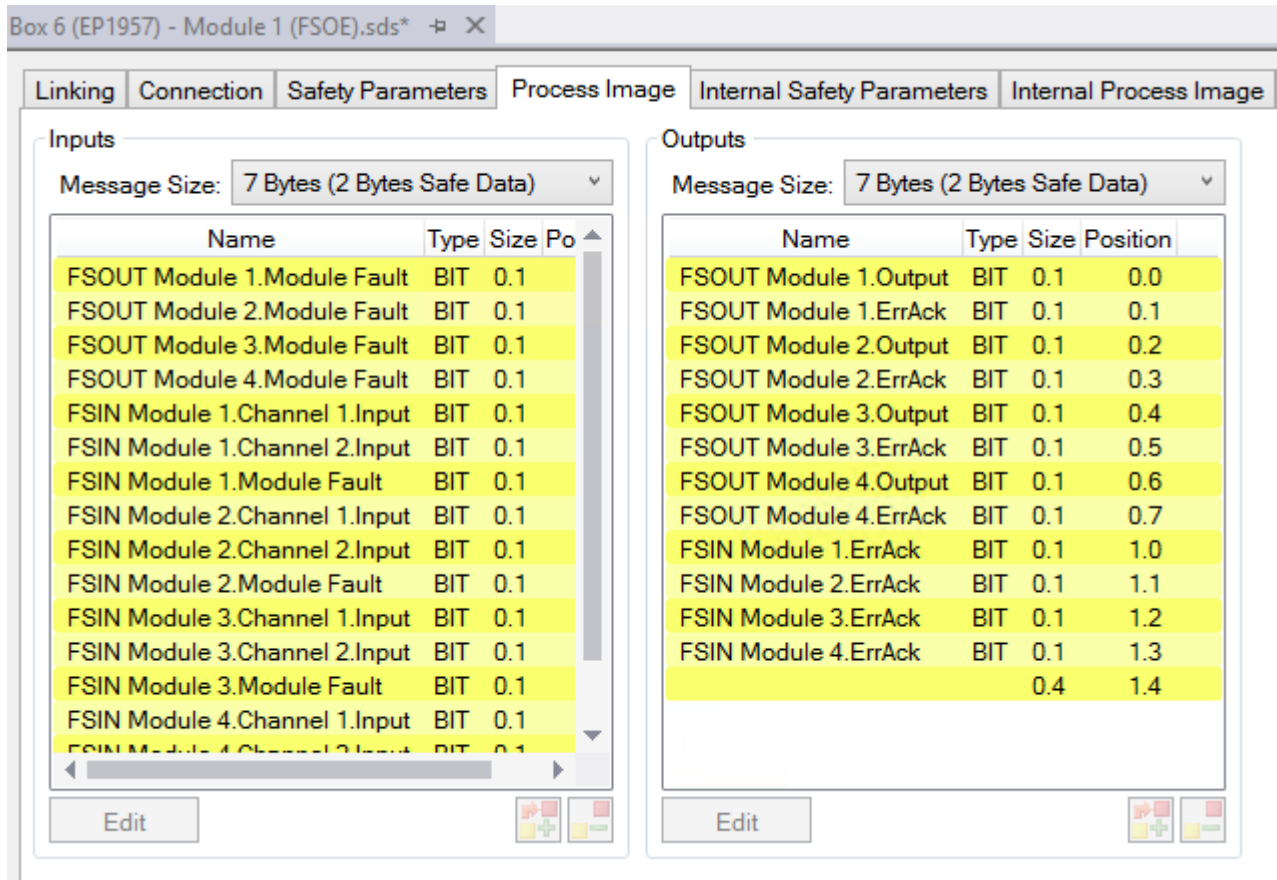

Fig. 26: Process image

The assignment of the individual signals in the safe data is listed in the following table.

Name	Process image	Bit position	Description
FSOUT module 1. module fault	IN	0.0	Module error information for safe output 1
FSOUT module 2. module fault	IN	0.1	Module error information for safe output 2
FSOUT module 3. module fault	IN	0.2	Module error information for safe output 3
FSOUT module 4. module fault	IN	0.3	Module error information for safe output 4
FSIN Module1.Channel1.Input	IN	0.4	Safe input channel 1
FSIN Module1.Channel2.Input	IN	0.5	Safe input channel 2
FSIN Module1.Module Fault	IN	0.6	Module error information for safe input module 1
FSIN Module2.Channel1.Input	IN	0.7	Safe input channel 3
FSIN Module2.Channel2.Input	IN	1.0	Safe input channel 4
FSIN Module2.Module Fault	IN	1.1	Module error information for safe input module 2
FSIN Module3.Channel1.Input	IN	1.2	Safe input channel 5
FSIN Module3.Channel2.Input	IN	1.3	Safe input channel 6
FSIN Module3.Module Fault	IN	1.4	Module error information for safe input module 3
FSIN Module4.Channel1.Input	IN	1.5	Safe input channel 7
FSIN Module4.Channel2.Input	IN	1.6	Safe input channel 8
FSIN Module4.Module Fault	IN	1.7	Module error information for safe input module 4
FSOUT Module1.Output	OUT	0.0	Safe output 1
FSOUT Module1.ErrAck	OUT	0.1	Error acknowledge for safe output module 1

Name	Process image	Bit position	Description
FSOUT Module2.Output	OUT	0.2	Safe output 2
FSOUT Module2.ErrAck	OUT	0.3	Error acknowledge for safe output module 2
FSOUT Module3.Output	OUT	0.4	Safe output 3
FSOUT Module3.ErrAck	OUT	0.5	Error acknowledge for safe output module 3
FSOUT Module4.Output	OUT	0.6	Safe output 4
FSOUT Module4.ErrAck	OUT	0.7	Error acknowledge for safe output module 4
FSIN Module1.ErrAck	OUT	1.0	Error acknowledge for safe input module 1
FSIN Module2.ErrAck	OUT	1.1	Error acknowledge for safe input module 2
FSIN Module3.ErrAck	OUT	1.2	Error acknowledge for safe input module 3
FSIN Module4.ErrAck	OUT	1.3	Error acknowledge for safe input module 4

5.4 TwinSAFE reaction times

The TwinSAFE terminals form a modular safety system that exchanges safety-oriented data via the Safety-over-EtherCAT protocol. This chapter is intended to help you determine the system's reaction time from the change of signal at the sensor to the reaction at the actuator.

Typical reaction time

The typical reaction time is the time that is required to transmit information from the sensor to the actuator, if the overall system is working without error in normal operation.

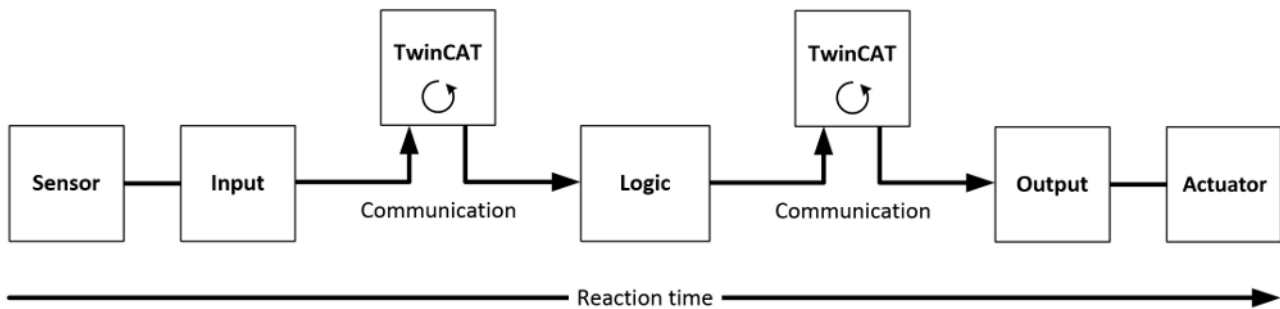

Fig. 27: Typical reaction time

Definition	Description
RTSensor	Reaction time of the sensor until the signal is provided at the interface. Typically supplied by the sensor manufacturer.
RTInput	Reaction time of the safe input, such as EL1904 or EP1908. This time can be found in the technical data. In the case of the EL1904 it is 4 ms.
RTComm	Reaction time of the communication. This is typically 3x the EtherCAT cycle time, because new data can only be sent in a new Safety-over-EtherCAT telegram. These times depend directly on the higher-level standard controller (cycle time of the PLC/NC).
RTLogic	Reaction time of the logic terminal. This is the cycle time of the logic terminal and typically ranges from 500 μs to 10 ms for the EL6900, depending on the size of the safety project. The actual cycle time can be read from the terminal.
RTOutput	Reaction time of the output terminal. This typically lies within the range of 2 to 3 ms.
RTActor	Reaction time of the actuator. This information is typically supplied by the actuator manufacturer.
WDComm	Watchdog time of the communication

This results in the following equation for the typical reaction time:

$$ReactionTime_{typ} = RT_{Sensor} + RT_{Input} + 3 * RT_{Comm} + RT_{Logic} + 3 * RT_{Comm} + RT_{Output} + RT_{Actuator}$$

with, for example

$$ReactionTime_{typ} = 5ms + 4ms + 3 * 1ms + 10ms + 3 * 1ms + 3ms + 20ms = 48ms$$

Worst-case reaction time

The worst case reaction time is the maximum time required to switch off the actuator in the case of an error.

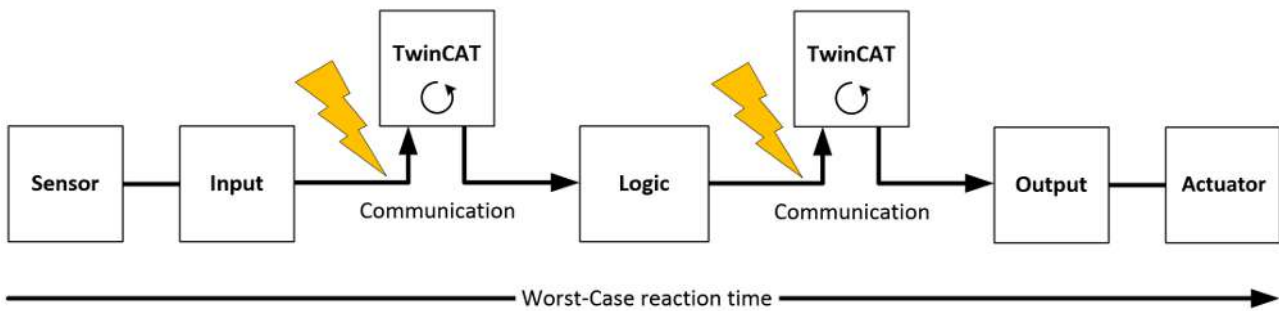

Fig. 28: Worst-case reaction time

This assumes that a signal change occurs at the sensor and is transmitted to the input. A communication error occurs at precisely the moment when the signal is to be transferred to the communication interface. This is detected by the logic following the watchdog time of the communication link. This information should then be transferred to the output, but a further communication error occurs here. This error is detected at the output following the expiry of the watchdog time and leads to the switch-off.

This results in the following equation for the worst-case reaction:

$$ReactionTime_{max} = WD_{Comm} + WD_{Comm} + RT_{Actuator}$$

with, for example

$$ReactionTime_{max} = 15\text{ ms} + 15\text{ ms} + 20\text{ ms} = 50\text{ ms}$$

5.5 Diagnosis

5.5.1 EtherCAT- Fieldbus LEDs

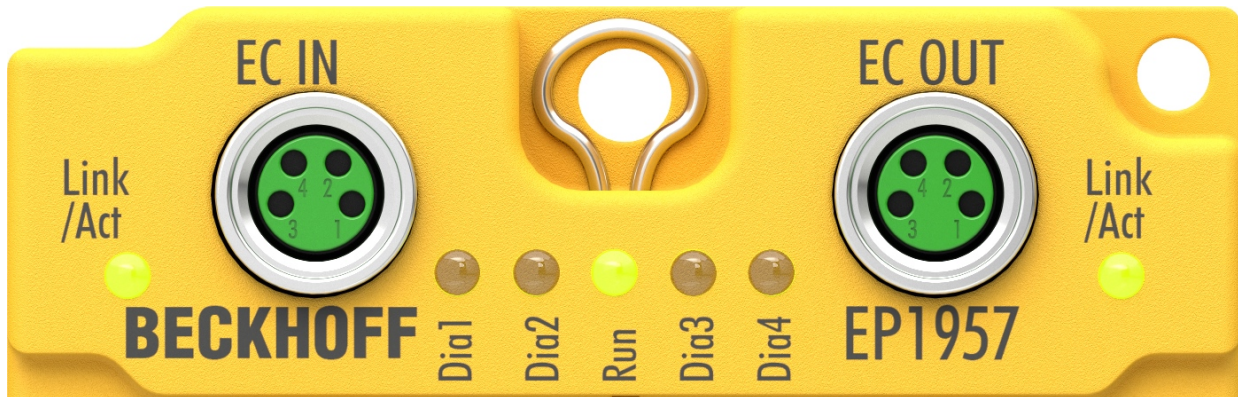

Fig. 29: EtherCAT- Fieldbus LEDs

LED displays

LED	Display	Meaning
IN Link/Act	off	no connection to the preceding EtherCAT module
	lit	LINK: connection to the preceding EtherCAT module
	flashes	ACT: communication with the preceding EtherCAT module
OUT Link/Act	off	no connection to the following EtherCAT module
	lit	LINK: connection to the following EtherCAT module
	flashes	ACT: Communication with the following EtherCAT module
Run	off	Status of the EtherCAT module is Init
	flashes quickly	Status of the EtherCAT module is pre-operational
	flashes slowly	Status of the EtherCAT module is safe-operational
	lit	Status of the EtherCAT module is operational

5.5.2 Status LEDs

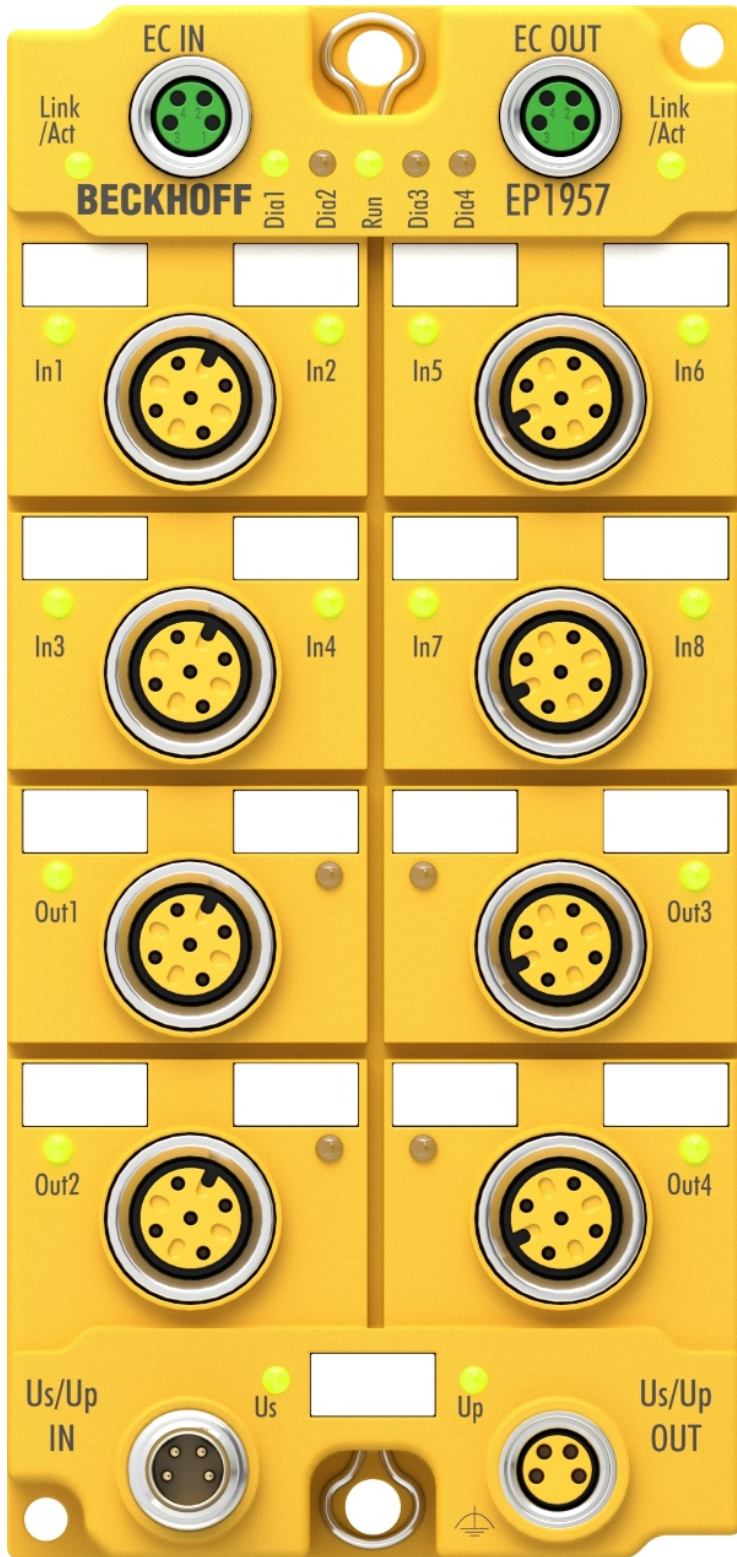

Fig. 30: Status LEDs

LED	Display	Meaning
In 1	on	Input 1 is connected and logical 1
	off	Input 1 is not connected and logical 0
In 2	on	Input 2 is connected and logical 1
	off	Input 2 is not connected and logical 0
In 3	on	Input 3 is connected and logical 1

LED	Display	Meaning
	off	Input 3 is not connected and logical 0
In 4	on	Input 4 is connected and logical 1
	off	Input 4 is not connected and logical 0
In 5	on	Input 5 is connected and logical 1
	off	Input 5 is not connected and logical 0
In 6	on	Input 6 is connected and logical 1
	off	Input 6 is not connected and logical 0
In 7	on	Input 7 is connected and logical 1
	off	Input 7 is not connected and logical 0
In 8	on	Input 8 is connected and logical 1
	off	Input 8 is not connected and logical 0
Out 1	on	Output 1 is connected
	off	Output 1 is not connected
Out 2	on	Output 2 is connected
	off	Output 2 is not connected
Out 3	on	Output 3 is connected
	off	Output 3 is not connected
Out 4	on	Output 4 is connected
	off	Output 4 is not connected
Us	on	Control voltage Us is available
	off	Control voltage Us is not available
Up	on	Control voltage Up is available
	off	Control voltage Up is not available

5.5.3 Diagnostic LEDs



Fig. 31: Diagnostic LEDs

LED displays

LED	lit	flashes	flickering	off
DIA1 (green)	Environment variables, operating voltage and internal tests are in the valid range <ul style="list-style-type: none"> If DIA2 flashes, a logic error code applies 	-		Environment variables, operating voltage and internal tests are outside the valid range <ul style="list-style-type: none"> If DIA2 flashes, an environment error code applies
DIA2 (red)	Together with DIA3 and 4: Global Shutdown ¹⁾ has occurred. (see diag history of the TwinSAFE components)	Logic or environment error code according to DIA1 and tables below is output	Fault in a safe input or output module	Together with DIA3 and 4: Global Fault ¹⁾ has occurred. (see diag history of the TwinSAFE components)
DIA3 (red)	Global Fault or Global Shutdown on μ C1 ¹⁾	-		No Global Fault or Global Shutdown on μ C1 ¹⁾
DIA4 (red)	Global Fault or Global Shutdown on μ C2 ¹⁾	-		No Global Fault or Global Shutdown on μ C2 ¹⁾

1. A global fault permanently disables the TwinSAFE component, so that it has to be replaced. A global shutdown temporarily disables the TwinSAFE component. The error can be reset by switching off and back on again.



Logic error codes of LED DIA2 (if LED DIA1 is lit)

Flashing Code	Description
1	Function block error in one of the TwinSAFE groups
2	Communication error in one of the TwinSAFE groups
3	Error combination: function block and communication
4	General error in one of the TwinSAFE groups
5	Error combination: general and function block
6	Error combination: general and communication
7	Error combination: general, function block and communication

Environment error codes of LED DIA2 (if LED DIA1 is off)

Flashing Code	Description
1	Maximum supply voltage μ C1 exceeded
2	Supply voltage μ C1 below minimum value
3	Maximum supply voltage μ C2 exceeded
4	Supply voltage μ C2 below minimum value
5	Maximum internal temperature exceeded
6	Internal temperature below minimum value
7	Valid temperature difference between μ C1 and μ C2 exceeded
8	not used
9	not used
10	General error

5.5.4 Flash code display

LED	Display	Description
flashing		400 ms ON / 400 ms OFF 1 second pause between the flash codes
flickering		50 ms ON / 50 ms OFF

6 Service life

The TwinSAFE EtherCAT Boxes have a service life of 20 years.

Due to the high diagnostic coverage within the lifecycle no special proof tests are required.

Date code

The TwinSAFE EtherCAT Boxes have a date code (D:), which is structured as follows:

Date Code: WW JJ SW HW

Key:	Example: Date Code 16 18 01 02
WW: calendar week of manufacture	Calendar week: 16
JJ: year of manufacture	Year: 2018
SW: software version	Software version: 01
HW: hardware version	Hardware version: 02

Serial number (S. no.)

In addition, the TwinSAFE EtherCAT Boxes have a unique serial number (S. no.).

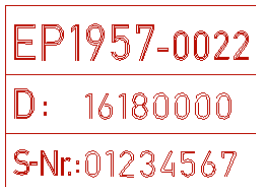

Fig. 32: Serial number

7 Maintenance and cleaning

● Cleaning by the manufacturer only



Do not operate the TwinSAFE component if it is impermissibly dirty according to protection class IP20. Send impermissibly dirty TwinSAFE components to the manufacturer for cleaning.

TwinSAFE components are basically maintenance-free.

8 Decommissioning

8.1 Disposal

NOTE

Correct disposal

Observe the applicable national laws and guidelines for disposal.

Incorrect disposal may result in environmental damage.

Remove the TwinSAFE component for disposal.

Depending on your application and the products used, make sure that the respective components are disposed of properly:

Cast iron and metal

Hand over cast iron and metal parts to scrap metal recycling.

Cardboard, wood and polystyrene

Dispose of packaging materials made of cardboard, wood or Styrofoam in accordance with regulations.

Plastic and hard plastic

You can recycle parts made of plastic and hard plastic via the waste management center or reuse them in accordance with the component regulations and markings.

Oils and lubricants

Dispose of oils and lubricants in separate containers. Hand over containers to the waste oil collection point.

Batteries and accumulators

Batteries and accumulators may also be marked with the crossed-out wheeled garbage can symbol. You must separate these components from waste. You are legally obliged to return used batteries and accumulators within the EU. Outside the validity of the EU Directive 2006/66/EC, observe the respective regulations.

8.1.1 Returning to the vendor

In accordance with the WEEE-2012/19/EU directives, you can return used devices and accessories for professional disposal. The transport costs are borne by the sender.

Send the used devices with the note "For disposal" to:

Beckhoff Automation GmbH & Co. KG
Gebäude „Service“
Stahlstraße 31
D-33415 Verl

In addition, you have the option to contact a local certified specialist company for the disposal of used electrical and electronic appliances. Dispose of the old components in accordance with the regulations applicable in your country.

9 Appendix

9.1 Protection classes according to IP code

The levels of protection are defined and divided into different classes in the IEC 60529 standard (DIN EN 60529). The designation follows the scheme below.

1st digit: Protection against ingress of dust and access to hazardous parts

1 st digit	Meaning
0	Non-protected
1	Protection against access to hazardous parts with back of hand. Protection against ingress of solid foreign objects = 50 mm diameter
2	Protection against access to hazardous parts with a finger. Protection against ingress of solid foreign objects = 12.5 mm diameter
3	Protection against access to hazardous parts with a tool. Protection against ingress of solid foreign objects = 2.5 mm diameter
4	Protection against access to hazardous parts with a wire. Protection against ingress of solid foreign objects = 1 mm diameter
5	Protection against access to hazardous parts with a wire. Protection against ingress of dust. Ingress of dust is not prevented completely, although the quantity of dust able to penetrate is limited to such an extent that the proper function of the device and safety are not impaired
6	Protection against access to hazardous parts with a wire. Dust-proof. No ingress of dust

2nd digit: Protection against ingress of water*

2 nd digit	Meaning
0	Non-protected.
1	Protection against dripping water.
2	Protection against dripping water when housing tilted up to 15°.
3	Protection against spraying. Water sprayed at an angle of up to 60° from vertical must not have any adverse effect.
4	Protection against splashing. Water splashing against the housing from any direction must not have any adverse effects.
5	Protection against jetting.
6	Protection against powerful jetting.
7	Protection against the effects of temporary immersion. The quantity of water being able to penetrate if the housing is submerged in water for 30 minutes at a depth of 1 m must not have any adverse effects.

*) These protection classes only define protection against water, not against other liquids.

9.2 Volatility

If there are requirements concerning the volatility of products in your application, for example of the U.S. Department of Defense or similar authorities or security organizations, the following process applies:

The product has both volatile and non-volatile components. Volatile components lose their data immediately after removing power. Non-volatile components keep the data even after loss of power.

If there is customer specific data saved on the product, it cannot be ensured that this data might not be restored through for example forensic measures, even after the data is deleted through the provided tool chain. If this data is confidential, the scrapping of the product after usage is recommended to protect this data.

9.3 Focus of certificates

The most decisive document for certified components of the TwinSAFE department is the EC type examination certificate. The document contains both the test coverage and the regarded component and component family.

The current certificates of all TwinSAFE components with the underlying standards and directives can be found at <https://www.beckhoff.com/en-en/support/download-finder/certificates-approvals/>.

If the document refers only to the first four figures of a product (ELxxxx), the certificate is valid for all available variants of the component (ELxxxx-abcd). This is applicable for all components like EtherCAT Terminals, EtherCAT Boxes, EtherCAT plug-in modules and Bus Terminals.

CERTIFICADO ◆ CERTIFICADO ◆ СЕРТИФИКАТ ◆ СЕРТИФИКАТ ◆ 書	
	<h1>EC-Type Examination Certificate</h1> <p>No. M6A 062386 0055 Rev. 01</p>
	<p>Holder of Certificate: Beckhoff Automation GmbH & Co. KG Hülshorstweg 20 33415 Verl GERMANY</p>
	<p>Product: Safety components</p>
	<p>Model(s): EL1918</p>
<p>Parameters:</p> <p>Supply voltage: 24VDC (-15%/+20%) Ambient temperature: -25°C...+55°C Protection class: IP20</p>	
<p>This EC Type Examination Certificate is issued according to Article 12(3) b or 12(4) a of Council Directive 2006/42/EC relating to machinery. It confirms that the listed Annex-IV equipment complies with the principal protection requirements of the directive. It refers only to the sample submitted to TÜV SÜD Product Service GmbH for testing and certification. For details see: www.tuvsud.com/ps-cert</p>	
<p>Test report no.:</p>	<p>BV99670C</p>

If you regard the example EL1918 in the picture, the certificate is valid for both the EL1918 and the available variant EL1918-2200.

9.4 Certificate

BECKHOFF New Automation Technology		Originalerklärung Original declaration
EG-Konformitätserklärung EC Declaration of Conformity		
Nummer: 20180058EP1957-2, Datum: 16.11.2022 <i>Number, Date</i>		
Hersteller <i>Manufacturer</i>	Beckhoff Automation GmbH & Co. KG Hülshorstweg 20, 33415 Verl, Germany	
erklärt, dass das Produkt <i>declares that the product</i>	TwinSAFE EP1957 TwinSAFE-EtherCAT-Box mit 8 sicheren Ein- und 4 sicheren Ausgängen 24V DC <i>TwinSAFE-EtherCAT-Box with 8 safe inputs and 4 safe outputs, 24V DC</i>	
den Bestimmungen der folgenden EG-Richtlinien entspricht: <i>complies with the relevant requirements of the following EC directives:</i>		
2006/42/EG <i>2006/42/EC</i>	Richtlinie 2006/42/EG des Europäischen Parlaments und des Rates vom 17. Mai 2006 über Maschinen und zur Änderung der Richtlinie 95/16/EG (Neufassung) <i>Directive 2006/42/EC of the European Parliament and of the Council of 17 May 2006 on machinery, and amending Directive 95/16/EC (recast)</i>	
2011/65/EU <i>2011/65/EU</i>	Richtlinie 2011/65/EU des Europäischen Parlaments und des Rates vom 8. Juni 2011 zur Beschränkung der Verwendung bestimmter gefährlicher Stoffe in Elektro- und Elektronikgeräten <i>Directive 2011/65/EU of the European Parliament and of the Council of 8 June 2011 on the restriction of the use of certain hazardous substances in electrical and electronic equipment (recast)</i>	
2014/30/EU <i>2014/30/EU</i>	Richtlinie 2014/30/EU des Europäischen Parlaments und des Rates vom 26. Februar 2014 zur Harmonisierung der Rechtsvorschriften der Mitgliedstaaten über die elektromagnetische Verträglichkeit (Neufassung) <i>Directive 2014/30/EU of the European Parliament and of the Council of 26 February 2014 on the harmonisation of the laws of the Member States relating to electromagnetic compatibility (recast)</i>	
Die Konformität mit den Bestimmungen der genannten Richtlinien wird durch Einhaltung der folgenden Normen nachgewiesen: <i>The conformity with the listed directives is proved by compliance with the following standards:</i>		
EN ISO 13849-1:2015 EN 62061:2005/A2:2015	EN IEC 63000:2018	EN 61000-6-2:2005 EN 61000-6-4:2007 EN 61131-2:2007
Die Übereinstimmung eines Baumusters des bezeichneten Produkts mit den EU-Richtlinien wurde bescheinigt von <i>The accordance of a production sample of the designated product with the EC directives is certified by</i>		
Richtlinie <i>Directive</i>	Benannte Stelle <i>Notified Body</i>	Baumusterprüfbescheinigung <i>type examination certificate</i>
2006/42/EG <i>2006/42/EC</i>	TÜV SÜD Product Service GmbH Ridlerstraße 65, 80339 München, Germany	M6A 062386 0058 Rev. 01 2022-11-10
Verantwortlich für die Zusammenstellung der technischen Unterlagen <i>Responsible for the compilation of technical documentation</i>		
Bevollmächtigter <i>Authorised person</i>	Beckhoff Automation GmbH & Co. KG Hülshorstweg 20, 33415 Verl, Germany	
Verl, 16.11.2022		
Ort / Datum <i>Place / Date</i>	Dipl.-Phys. Hans Beckhoff, Geschäftsführer <i>Dipl.-Phys. Hans Beckhoff, CEO</i>	

Fig. 33: EP1957 EC Declaration of Conformity

List of figures

Fig. 1	EtherCAT Box modules extend the EtherCAT system with IP67 protection	14
Fig. 2	Connection diagram	15
Fig. 3	Dimensions	20
Fig. 4	Mounting rail ZS5300-0001	22
Fig. 5	EtherCAT Box with M8 and M12 connectors	22
Fig. 6	Torque wrench ZB8801	23
Fig. 7	EtherCAT connection 30 mm housing M8	23
Fig. 8	Safe inputs 1 to 8	26
Fig. 9	PinOut default setting	26
Fig. 10	PinOut alternative 1 (parameter input power mode = power mode A)	26
Fig. 11	PinOut alternative 2 (parameter input power mode = power mode B)	26
Fig. 12	Characteristic curve of the inputs	28
Fig. 13	Safe outputs 1 to 4	28
Fig. 14	PinOut safe output	29
Fig. 15	Signal lines	30
Fig. 16	Cable routing	31
Fig. 17	Adding an EP1957	32
Fig. 18	EP1957 - Delete project data	33
Fig. 19	Rotary switches on the underside	34
Fig. 20	Starting the automatic import from the I/O configuration	35
Fig. 21	Selection from the I/O tree	35
Fig. 22	Creating alias devices by the user	36
Fig. 23	Linking tab	37
Fig. 24	Connection tab	38
Fig. 25	Safety Parameter tab	39
Fig. 26	Process image	41
Fig. 27	Typical reaction time	43
Fig. 28	Worst-case reaction time	44
Fig. 29	EtherCAT- Fieldbus LEDs	45
Fig. 30	Status LEDs	46
Fig. 31	Diagnostic LEDs	48
Fig. 32	Serial number	50
Fig. 33	EP1957 EC Declaration of Conformity	56

More Information:
www.beckhoff.com/EP1957-0022

Beckhoff Automation GmbH & Co. KG
Hülshorstweg 20
33415 Verl
Germany
Phone: +49 5246 9630
info@beckhoff.com
www.beckhoff.com

