

Montageanleitung B17 Hybrid

konfektionierbares Steckergehäuse mit Crimpanschluss, axial,
3x1,5mm² + 4xAWG22, ECP: Powerbuchse / Datenbuchse

Stückliste

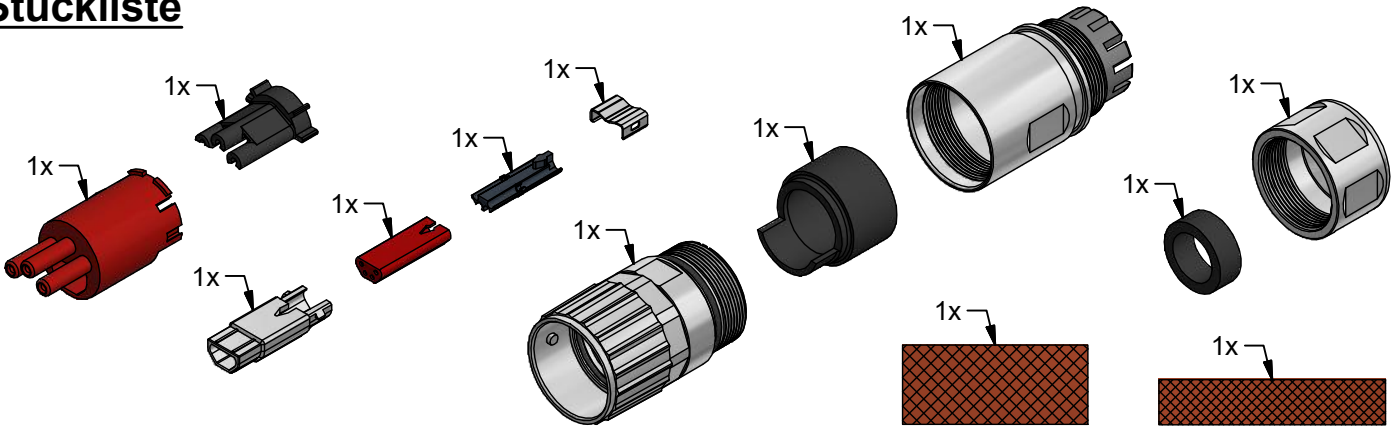

Laufrichtung beachten!

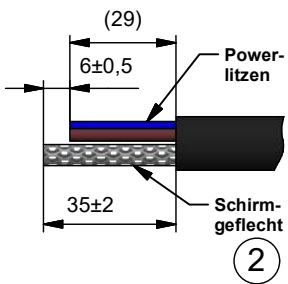
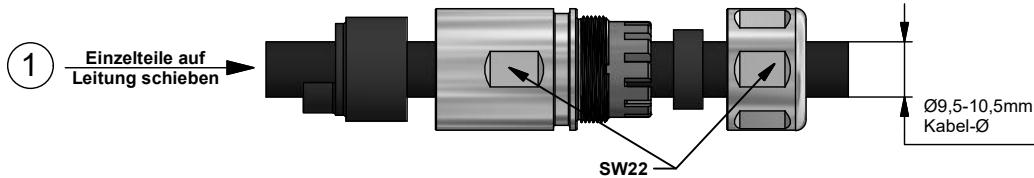

Füllstoffe bündig mit Kabelmantel wegschneiden!

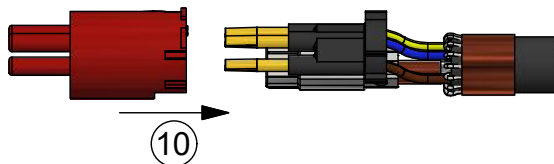
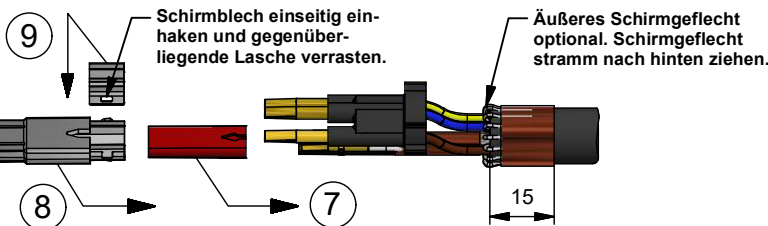
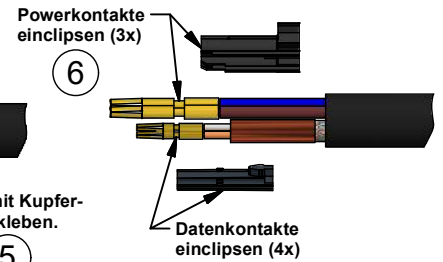
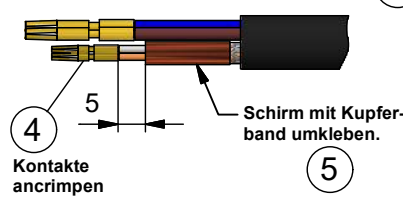
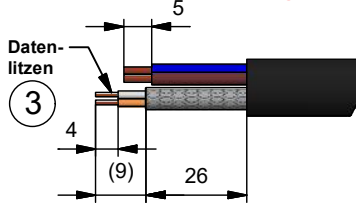

Achtung: Ansicht von Kabelausgang dargestellt! Auf richtige Farbwahl achten!

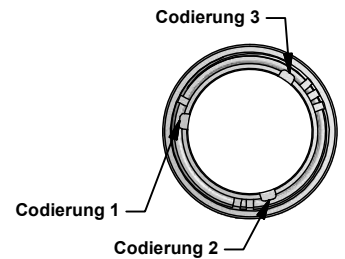
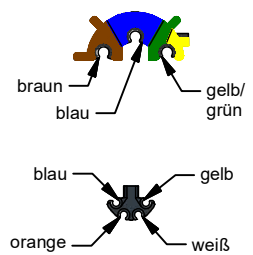

Nur eine Codierung montierbar!

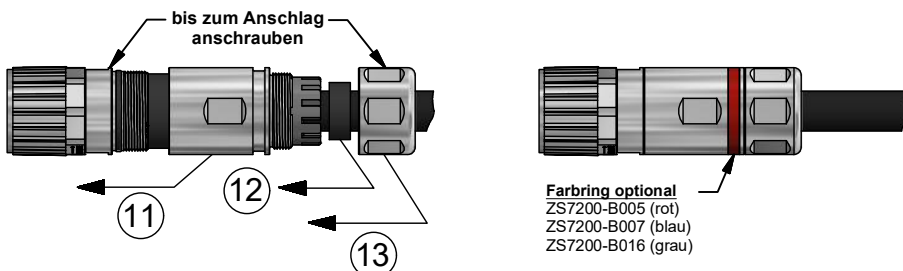

Farbring optional
ZS7200-B005 (rot)
ZS7200-B007 (blau)
ZS7200-B016 (grau)

Werkzeug / Zubehör

Crimpzange	Crimpeinsatz / Locator
ZB8810-0000	ZB8810-0001

Assembly instruction B17 hybrid

field attachable plug housing with crimp connection, axial,
 3x1.5mm² + 4xAWG22, ECP: power (female) / data (female)

parts list

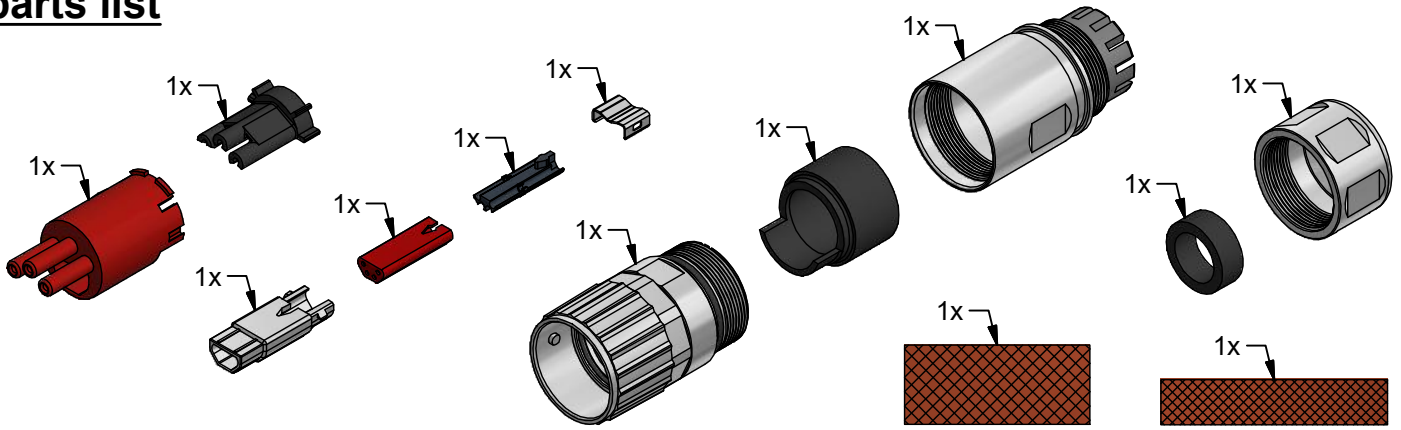

Please consider the cable direction!

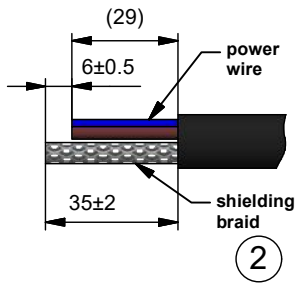
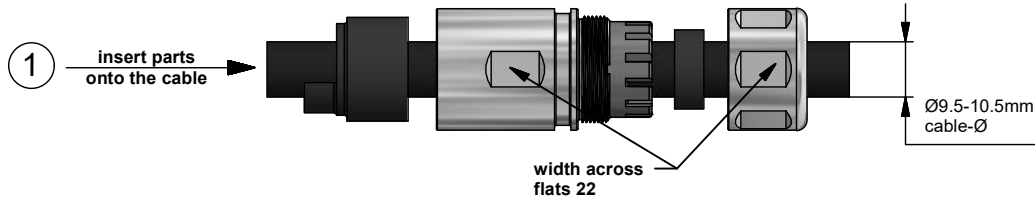

Cut off the fillers!

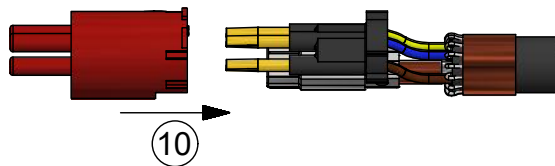
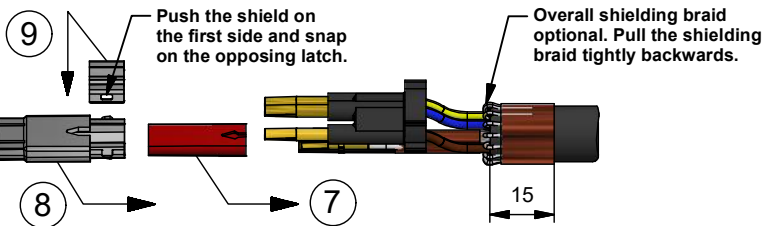
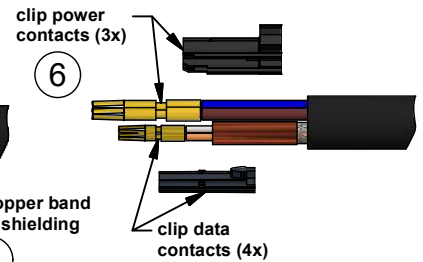
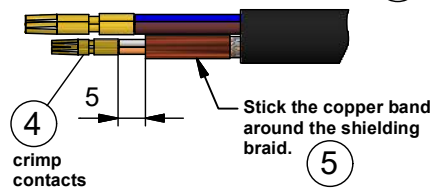
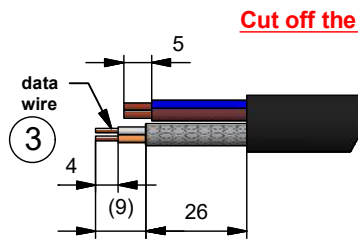

Attention: View from cable outlet!
 Consider the right choice of colors!

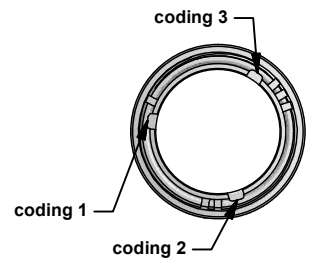
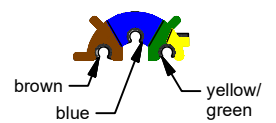

Only one coding mountable!

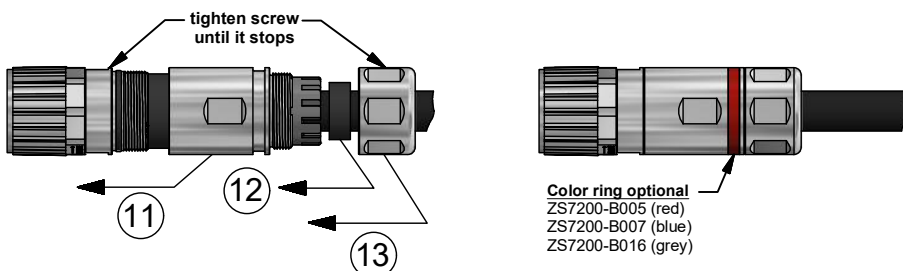

Color ring optional
 ZS7200-B005 (red)
 ZS7200-B007 (blue)
 ZS7200-B016 (grey)

tools / accessory parts

crimping tool	crimping insert / locator
ZB8810-0000	ZB8810-0001

BECKHOFF