

Documentation | EN

KL62x1/KS62x1, KL952x/KS952x

Master terminals, power supply terminals and potential feed terminals for AS-interface



Table of contents

1	Foreword	5
1.1	Notes on the documentation.....	5
1.2	Safety instructions	6
1.3	Documentation issue status	7
2	Product overview	9
2.1	KL6201, KL6211 - Introduction.....	9
2.2	Technical data	10
2.3	Functionality of the AS-i master.....	11
2.3.1	AS-i status machine.....	11
2.3.2	Lists	12
2.3.3	Operation modes	12
2.3.4	Details of the operating phases	13
2.3.5	Address assignment of the AS-i slaves	14
2.3.6	Automatic project design	14
2.4	Commissioning instructions	15
2.5	KL9528 - AS-i Power Supply Terminal	16
2.6	KL9520 - AS-i potential feed terminal with filter.....	19
3	Mounting and wiring	21
3.1	Instructions for ESD protection.....	21
3.2	Installation on mounting rails	22
3.3	Installation positions	24
3.4	Installation instructions for enhanced mechanical load capacity	26
3.5	Connection	27
3.5.1	Connection system	27
3.5.2	Wiring.....	29
3.5.3	Shielding	30
3.6	AS-i installation	30
3.7	Disposal.....	32
3.8	ATEX - Special conditions (standard temperature range).....	33
3.9	Continuative documentation for ATEX and IECEx	34
4	KS2000 Configuration Software	35
4.1	KS2000 - Introduction.....	35
4.2	Configuration of the KL6201/KL6211	36
4.3	Register	38
4.4	KS2000 Settings.....	39
4.5	KS2000 - AS-i settings	40
4.6	KS2000 - AS-i system overview	42
4.7	KS2000 - AS-i slave parameters	43
4.8	Process data.....	45
5	Access from the user program	47
5.1	Process image.....	47
5.1.1	6-byte process image	47
5.1.2	12-byte process image Process image.....	47

5.1.3	22-byte process image	48
5.1.4	38-byte process image	49
5.1.5	Description of the data blocks.....	50
5.2	Register overview	56
5.3	Register description.....	57
5.4	Examples of Register Communication	58
5.4.1	Example 1: reading the firmware version from Register 9.....	58
5.4.2	Example 2: Writing to an user register.....	58
5.5	Register pages	61
5.6	AS-i parameters - overview	65
5.7	AS-i parameter description	67
5.8	Access to AS-i parameters	98
5.9	Mapping of analog AS-i slaves	100
6	Operation at the fieldbus, overview.....	104
6.1	KL6201/KL6211 at PROFIBUS couplers.....	104
6.2	KL6201/KL6211 at CANopen couplers.....	110
6.3	Firmware version of the Bus Couplers	116
7	Diagnostics	118
7.1	LEDs.....	118
8	Appendix	119
8.1	Support and Service	119

1 Foreword

1.1 Notes on the documentation

Intended audience

This description is only intended for the use of trained specialists in control and automation engineering who are familiar with the applicable national standards.

It is essential that the documentation and the following notes and explanations are followed when installing and commissioning these components.

It is the duty of the technical personnel to use the documentation published at the respective time of each installation and commissioning.

The responsible staff must ensure that the application or use of the products described satisfy all the requirements for safety, including all the relevant laws, regulations, guidelines and standards.

Disclaimer

The documentation has been prepared with care. The products described are, however, constantly under development.

We reserve the right to revise and change the documentation at any time and without prior announcement.

No claims for the modification of products that have already been supplied may be made on the basis of the data, diagrams and descriptions in this documentation.

Trademarks

Beckhoff®, TwinCAT®, TwinCAT/BSD®, TC/BSD®, EtherCAT®, EtherCAT G®, EtherCAT G10®, EtherCAT P®, Safety over EtherCAT®, TwinSAFE®, XFC®, XTS® and XPlanar® are registered trademarks of and licensed by Beckhoff Automation GmbH. Other designations used in this publication may be trademarks whose use by third parties for their own purposes could violate the rights of the owners.

Patent Pending

The EtherCAT Technology is covered, including but not limited to the following patent applications and patents: EP1590927, EP1789857, EP1456722, EP2137893, DE102015105702 with corresponding applications or registrations in various other countries.

The logo for EtherCAT, featuring the word "EtherCAT" in a bold, black, sans-serif font. A red arrow points from the top of the "A" towards the right, ending above the "T". A registered trademark symbol (®) is located to the right of the "T".

EtherCAT® is registered trademark and patented technology, licensed by Beckhoff Automation GmbH, Germany.

Copyright

© Beckhoff Automation GmbH & Co. KG, Germany.

The reproduction, distribution and utilization of this document as well as the communication of its contents to others without express authorization are prohibited.

Offenders will be held liable for the payment of damages. All rights reserved in the event of the grant of a patent, utility model or design.

1.2 Safety instructions

Safety regulations

Please note the following safety instructions and explanations!
Product-specific safety instructions can be found on following pages or in the areas mounting, wiring, commissioning etc.

Exclusion of liability

All the components are supplied in particular hardware and software configurations appropriate for the application. Modifications to hardware or software configurations other than those described in the documentation are not permitted, and nullify the liability of Beckhoff Automation GmbH & Co. KG.

Personnel qualification

This description is only intended for trained specialists in control, automation and drive engineering who are familiar with the applicable national standards.

Description of instructions

In this documentation the following instructions are used.
These instructions must be read carefully and followed without fail!

DANGER

Serious risk of injury!

Failure to follow this safety instruction directly endangers the life and health of persons.

WARNING

Risk of injury!

Failure to follow this safety instruction endangers the life and health of persons.

CAUTION

Personal injuries!

Failure to follow this safety instruction can lead to injuries to persons.

NOTE

Damage to environment/equipment or data loss

Failure to follow this instruction can lead to environmental damage, equipment damage or data loss.



Tip or pointer

This symbol indicates information that contributes to better understanding.

1.3 Documentation issue status

Version	Comment
2.1.0	<ul style="list-style-type: none"> • Technical data updated • Ex markings added to technical data • Chapter <i>KS2000 Configuration Software</i> updated • Chapter <i>AS-i installation</i> updated • Chapter <i>AS-i parameters - overview</i> updated • Chapter <i>Instructions for ESD protection</i> added • Chapter <i>Disposal</i> added • New title page
2.0.0	<ul style="list-style-type: none"> • Migration
1.5.0	<ul style="list-style-type: none"> • Chapter on <i>Mounting rail installation</i> updated • Notes about Firmware Version of the Bus Couplers updated • Description of the AS-i string parameters added (AS-i string parameters are supported from firmware version BA) • Description of the AS-i command interface updated • Description of the AS-i settings via KS2000 updated • Mounting instructions updated
1.4	<ul style="list-style-type: none"> • Description of the KL6211 AS-i master terminal with power contacts added • Description of the KL9520 AS-i potential feed terminal with filter added • Mounting instructions for AS-i master terminals added • Minor routine corrections (typing errors, spelling, etc.)
1.3	<ul style="list-style-type: none"> • Description of the acknowledgement to the AS-i command interface (AS-i parameter 0x100) extended • Description of the process image updated and 6-byte process image added • Description of the KL6201 operation under PROFIBUS updated • Description of the KL6201 operation under CANopen updated • Notes about Firmware Version of the Bus Couplers updated
1.2	<ul style="list-style-type: none"> • up to 62 AS-i slaves are now supported directly in the process image • analog AS-i slaves are supported • Description of KL6201 parameterization via KS2000 software added • Description of the AS-i parameters revised • Description of KL6201 operation under PROFIBUS updated • Description of KL6201 operation under CANopen updated • Description of the KL9528 AS-i power supply terminal added
1.1	<ul style="list-style-type: none"> • up to 62 AS-i slaves are supported (32 directly in the process image, a further 32 via parameter access) • ID code 1 and 2 are now read during start-up • during short-circuiting of the SET inputs, ID codes 1 and 2 are also saved
1.0	<ul style="list-style-type: none"> • Complete revision • Description of KL6201 operation under CANopen added
0.9	<ul style="list-style-type: none"> • First preliminary version: Description of the KL6201 operation under PROFIBUS

Firmware and hardware versions

Documentation version	KL6201-0000 / KS6201-0000		KL6211-0000 / KS6211-0000	
	Firmware	Hardware	Firmware	Hardware
2.1.0	D6	0K	D6	0K
2.0.0	D6	0J	D6	0J
1.5.0	BA	0D	BA	0D
1.4	B9	09	B9	09
1.3	B7	09	-	-
1.2	B4	09	-	-
1.1	B1-FE	05	-	-
1.0	B0	04	-	-

The firmware and hardware versions (delivery state) can be taken from the serial number printed on the side of the terminal.

Syntax of the serial number

Structure of the serial number: WW YY FF HH

WW - week of production (calendar week)

YY - year of production

FF - firmware version

HH - hardware version

Example with serial number 12 06 B9 09:

12 - week of production 12

06 - year of production 2006

B9 - Firmware version B9

09 - hardware version 09

2 Product overview

2.1 KL6201, KL6211 - Introduction

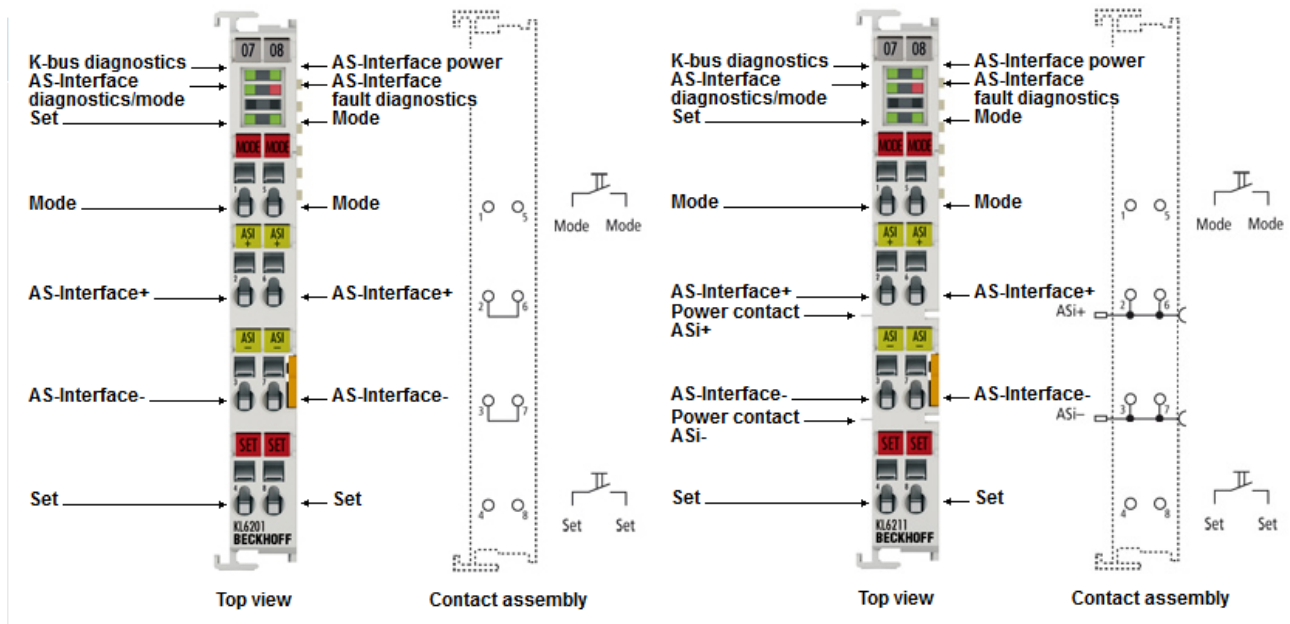

Fig. 1: KL6201, KL6211

The AS Interface master terminal enables the direct connection of AS-i slaves. The AS-i compliant interface supports digital and analog slaves, versions 2.0 and 2.1. Process data exchange, parameterization and the diagnosis are fieldbus-independent. Together with the different Bus Couplers available from BECKHOFF, the KL6201 represents a universal fieldbus/AS-i gateway.

The size of the process image can be set to 6 bytes, 12 bytes (default), 22 bytes or 38 bytes, as required.

Since the usual register interface (with 64 registers per terminal or channel) is not sufficient for transferring all the information of the AS-i master terminal ([terminal registers \[► 56\]](#) and [AS-i parameters \[► 65\]](#)), a parameter interface was defined that can be accessed cyclically (via the process image) or acyclically (via fieldbus-specific acyclic services).

2.2 Technical data

Technical data	KL6201-0000 / KS6201-0000	KL6211-0000 / KS6211-0000
AS-i channels	1	
AS-i versions	Automatic support of version 2.0 and version 2.1 (master profile M3)	
Number of AS-i slaves	Version 2.0: 31 Version 2.1: 62	
AS-i slave types	Digital or analog (conversion of analog data in the KL6201)	
Diagnostics	Power failure, slave failure, parameterization fault	
AS-i address assignment	via configuration or automatic	
Cycle time	max. 5 ms (31 slaves), 10 ms (62 slaves)	
Connection	2 lines via spring force technology	
Electrical isolation	500 V (AS-Interface / K-bus)	
Current consumption from K-bus	typ. 55 mA	
Current consumption from the AS-Interface	typ. 60 mA	
K-bus bit width	selectable: 12 bytes, 22 bytes, 38 bytes, of which 6 bytes represent the parameter interface, the rest represent the process data interface	
Configuration	via fieldbus parameter interface, DP-V1 or Bus Coupler via Configuration software KS2000	
Pluggable wiring	for all KSxxxx Bus Terminals	
Weight	approx. 55 g	
Mounting [► 22]	on 35 mm mounting rail conforms to EN 60715	
Permissible ambient temperature during operation	0 °C ... +55 °C (see chapter Installation positions [► 24])	
Permissible ambient temperature during storage	-25°C ... +85°C	
Permissible relative humidity	95% no condensation	
Vibration / shock resistance	conforms to EN 60068-2-6 / EN 60068-2-27 see also installation instructions [► 26] for enhanced mechanical load capacity	
EMC resistance burst / ESD	conforms to EN 61000-6-2 / EN 61000-6-4	
Protection class	IP20	
Installation position	optimum installation position (see chapter Installation positions [► 24])	
Approvals, markings*	CE, UKCA, cULus, EAC, ATEX [► 33]	CE, UKCA, cULus, EAC

*) Real applicable approvals/markings see type plate on the side (product marking).

Ex marking

Standard	KL6201-0000 / KS6201-0000	KL6211-0000 / KS6211-0000
ATEX	II 3 G Ex nA IIC T4 Gc	-

2.3 Functionality of the AS-i master

2.3.1 AS-i status machine

First, an overview of the status machine is provided. Details of the individual operating phases can be found below.

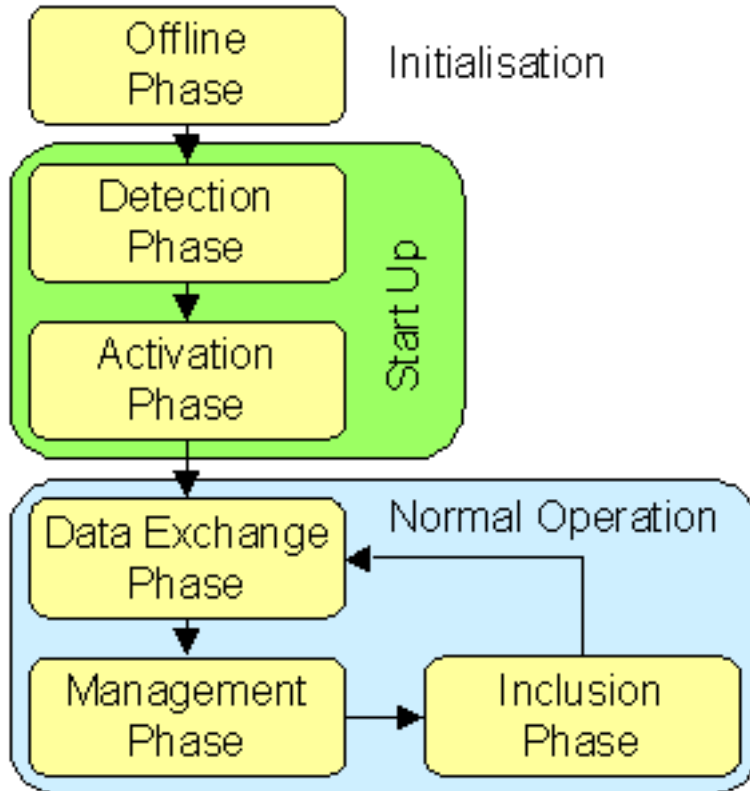

Fig. 2: Status machine overview

Initialization

Offline phase: During initialization, there is no AS-i data traffic.

Start-up

Detection phase

In this phase the AS-i master initially looks for existing slaves, irrespective of whether or not they are currently projected. This phase is only exited once at least one slave has been found.

Activation phase

During this phase, the slave that were found are activated depending on the operation mode:

- protected mode: All detected and currently projected slaves are activated, if the I/O ID and ID code of the detected slaves match the currently projected data.
- configuration mode: All detected slaves are activated by the master.

Normal operation

Data exchange phase

Cyclic data exchange between the AS-i master and the activated slaves.

Management phase

At the end of a cycle, the AS-i master enters the management phase, during which it can send a command to a specific slave (if required).

Inclusion phase

The AS-i master then enters the inclusion phase, during which it sends a command to a free slave address, in order to detect new slaves. If there is no response, the master immediately starts the next data exchange phase.

2.3.2 Lists

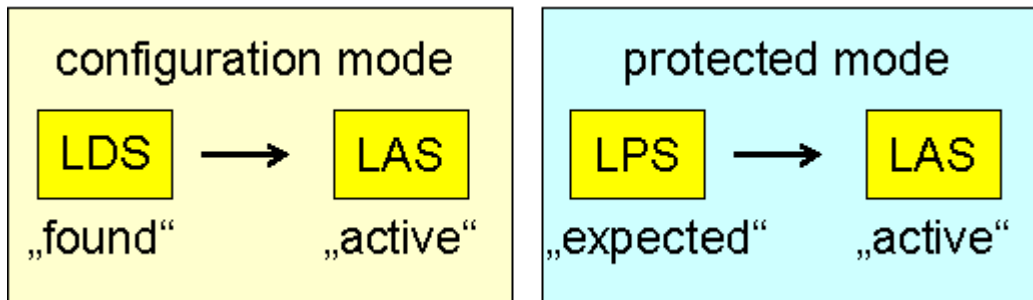

Fig. 3: Lists of the AS-i slaves in configuration and protected mode

LDS - list of detected slaves

This lists all slaves that physically exist in the network, have a valid address and were detected by the master.

LPS - list of currently projected slaves

This list comprises all slaves that the master expects to find in the network. In protected mode, the master only communicates with these slaves and issues a message as soon as additional slaves are detected, or if slaves are missing from this list.

LAS - list of activated slaves

All slaves with which the master communicates. In protected mode, this list corresponds to the LPS, in configuration mode it corresponds to the LDS.

2.3.3 Operation modes

Protected Mode

In protected mode, only the AS-i slaves that are entered in the LPS are activated. Furthermore, their configuration (I/O ID and ID codes) must match the currently projected configuration comprising the parameters

- [0x40 to 0x47](#) [[▶ 67](#)] (currently projected I/O IDs) or
 - [0x48 to 0x4F](#) [[▶ 69](#)] (currently projected ID codes)
 - [0xE0 to 0xE7](#) [[▶ 83](#)] (currently projected extended ID codes 1) and
 - [0xE8 to 0xEF](#) [[▶ 84](#)] (currently projected extended ID codes 2),
- if verification of I/O ID or ID codes is enabled in parameters [0x60 to 0x61](#) [[▶ 72](#)] or [0x68 to 0x69](#) [[▶ 72](#)], [0x70 to 0x71](#) [[▶ 73](#)] and [0x78 to 0x79](#) [[▶ 73](#)].

Automatic addressing is possible, if I/O ID and ID code verification is enabled for all AS-i slaves listed in the LPS, and if precisely one currently projected AS-i slave is missing.

Configuration Mode

In configuration mode, all AS-i slaves that are found are activated. Automatic addressing is possible, with the next free address being assigned when a slave with address 0 is found. An AS-i address can also be set manually via the parameter [0x100 \[► 85\]](#) (AS-i command interface). All AS-i slaves that were found can be projected by setting the set input or via the parameter [0x108 \[► 87\]](#) (general command interface). In this case, the

- the corresponding I/O IDs and ID codes are entered in parameters [0x40 to 0x47 \[► 67\]](#) (currently projected I/O IDs) or [0x48 to 0x4F \[► 69\]](#), [0xE0 to 0xE7 \[► 83\]](#) and [0xE8 to 0xEF \[► 84\]](#) (currently projected ID codes) and
- verification in parameters [0x60 to 0x61 \[► 72\]](#) (I/O IDs) or [0x68 to 0x69 \[► 72\]](#), [0x70 to 0x71 \[► 73\]](#) and [0x78 to 0x79 \[► 73\]](#) (ID codes) is enabled.

2.3.4 Details of the operating phases

Offline

After power-on, the AS-i master goes into offline mode, i.e. there is no communication with the AS-i slaves.

During normal operation, the AS-i master can be put into offline mode (OFFLINE-flag is set) via the process data. The output data of all activated AS-i slaves are set to default value 1_{bin} , and the input data of all activated AS-i slaves are set to default value 0_{bin} . The AS-i master is then in offline mode and will send no further AS-i commands.

As soon as the OFFLINE flag is no longer set, the AS-i master copies the new list of currently projected slaves from parameters [0x58 and 0x59 \[► 72\]](#) to parameters [0xA8 and 0xA9 \[► 79\]](#) (LPS) and automatically returns to the detection phase. If an AS-i slave in the list of currently projected slaves (LPS) is activated, the AS-i master operates in protected mode (PRJ_ACTIVE flag is set in the process data), otherwise it operates in configuration mode (PRJ_ACTIVE flag is reset in the process data).

Start-up

Detection phase

During the detection phase the I/O ID and ID codes of all AS-i slaves are queried and entered in parameters

- [0x90 to 0x97 \[► 75\]](#) (read I/O IDs) or
- [0x98 to 0x9F \[► 76\]](#) (read ID codes),
- [0xD0 to 0xD7 \[► 80\]](#) (read extended ID codes 1) and
- [0xD8 to 0xDF \[► 81\]](#) (read extended ID codes 2).

All AS-i slaves that were found are entered in the list of **detected AS-i slaves** (LDS, parameters [0xB0 and 0xB1 \[► 79\]](#)). The AS-i master will only enter the activation phase once at least one slave was detected or found.

Activation phase

In protected mode, the AS-i master activates only the projected AS-i slaves from the list of currently **projected slaves** (LPS, parameters [0xA8 and 0xA9 \[► 79\]](#)).

In configuration mode, all AS-i slaves that were found during the detection phase are activated. To this end, the AS-i master sends a parameterization request (activation parameter, parameters [0x50 to 0x57 \[► 70\]](#)) and a data request (with default values 1_{bin} as outputs). All activated slaves are entered in the list of **activated slaves** (LAS, parameters [0xB8 and 0xB9 \[► 80\]](#)). Once all AS-i slaves have been processed, the AS-i master automatically enters the data exchange phase.

Normal operation

Data exchange phase

During the data exchange phase, the AS-i master exchanges data with each activated AS-i slave. If an AS-i slave does not respond in three consecutive data exchange phases, it is removed from the LAS and the LDS, and its inputs are set to the default value 0_{bin} . Once a data cycle has been completed with all activated AS-i slaves, the AS-i master enters the management phase.

Management phase

During the management phase, an AS-i command is sent if an operating address is to be set via automatic address programming, or if an AS-i command was requested via the AS-i command interface (parameter [0x100 \[► 85\]](#)). Otherwise the AS-i master enters the inclusion phase without issuing an AS-i command.

Inclusion phase

During the inclusion phase, only one command is sent. The system will attempt to find and activate new AS-i slaves, and the respective status is updated accordingly. The steps are the same as during the recognition or activation phase, except that they are now distributed over up to seven cycles.

2.3.5 Address assignment of the AS-i slaves

Address assignment can be done via the AS-i master or via an addressing slave. AS-i slaves are usually supplied with address 0. Slaves that were added later are searched under this address, and an address is then assigned. Address 0 is not permitted during the data exchange phase.

For AS-i Specification 2.1 slaves, addresses 33 to 63 are also permitted (AS-i slave address 32 is not permitted).

Normal address assignment

New AS-i slaves usually have address 0. An addressing call command can be triggered via the parameter [0x100 \[► 85\]](#) (AS-i command interface). However, the addressing call command only works if precisely one AS-i slave with address 0 is connected to the bus.

Automatic address assignment

Automatic address assignment has to be enabled with [bit 6.1 \[► 54\]](#) of the output data.

Configuration Mode

In configuration mode, the next free address is automatically assigned if a slave with address 0 is found.

Protected Mode

In protected mode, an AS-i slave with address 0 is automatically programmed with its new address, if precisely one currently projected AS-i slave is missing, and if no other not currently projected AS-i slave is present at the bus. This enables a (no longer functioning) AS-i slave to be exchanged during operation.

2.3.6 Automatic project design

The currently detected slaves (from the LDS) can automatically be projected via SET or via the parameter [0x108 \[► 87\]](#) (general command interface).

2.4 Commissioning instructions

The following steps enable rapid commissioning of an AS-i network with the KL6201/KL6211 AS-i master terminal:

1. Address the AS-i slaves.
2. Connect the AS-i slaves to the KL6201/KL6211.
3. In delivery state the KL6201/KL6211 is set to the 12-byte process image, which supports direct access to the process data of AS-i slaves 1 to 11. A larger [process image \[► 40\]](#) is required for direct access to further AS-i addresses.
- 4.

● Enabling process data communication

i For enabling process data communication, set bit 3 in the AS-i command nibble (ASI CN in byte 6) to 1_{bin}.

Example for the 12-byte process image:

Parameter data block						Process data block					
Byte 0	Byte 1	Byte 2	Byte 3	Byte 4	Byte 5	Byte 6	Byte 7	Byte 8	Byte 9	Byte 10	Byte 11
CB0	CB1	ParaOut0	ParaOut1	ParaOut2	ParaOut3	ASI CN + ASI Out Slave 1	ASI Out Slave 2+3	ASI Out Slave 4+5	ASI Out Slave 6+7	ASI Out Slave 8+9	ASI Out Slave 10+11
0x00	0x00	0x00	0x00	0x00	0x00	0x8p	0xpp	0xpp	0xpp	0xpp	0xpp

Key

- ASI CN: AS-i command nibble [► 40]
- p: process data nibbles (outputs) for the respective AS-i slaves
- CB n: control byte n
- Para Out n: Output parameter, byte n

5. Once the AS-i cycle is completed, the KL6201/KL6211 responds with the input data (delayed by one or several cycles, depending on the higher-level fieldbus system).

● Short-circuiting the two set inputs is not necessary for operation

i Short-circuiting of the two set inputs is not required for operation. During the commissioning phase this would in fact be a hindrance, since the KL6201/KL6211 would then only include those AS-i slaves in the data exchange that were found during short-circuiting of the set inputs.

2.5 KL9528 - AS-i Power Supply Terminal

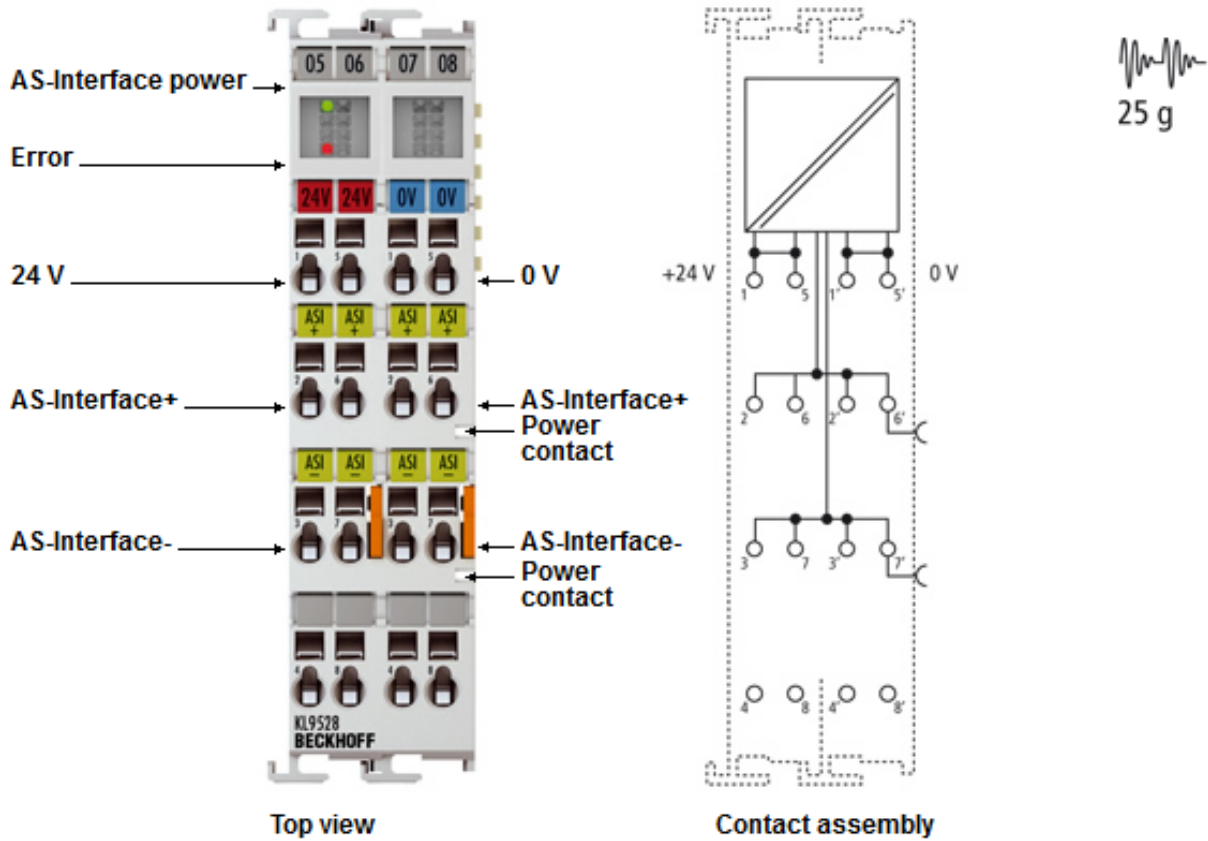

Fig. 4: KL9528 - AS-i Power Supply Terminal

The KL9528 power supply terminal generates a 30 V_{DC} output voltage from the 24 V_{DC} control voltage for operating an AS-i network. The output voltage is high-frequency decoupled, short-circuit-proof and limited to a current of 1.3 A. There is no electrical isolation between the input voltage and the output voltage.

The connection to the KL6211 AS-i master terminal is established by the power contacts during side-by-side plugging.

The KL6201 AS-i master terminal must be connected via cable bridges.

LED display

LED	Meaning	
AS-i power (green)	off	AS-i voltage is switched off.
	on	AS-i voltage is switched on.
Error (red)	off	KL9528 OK
	on	An error (e.g. undervoltage, overload) has occurred.

Technical data

Technical data		KL9528-0000 / KS9528-0000
Short-circuit strength		yes, restart after enable via rising edge of output bit 0
Input voltage		21 to 28.8 V _{DC}
Output voltage		30 V _{DC} (± 5%)
Output current		max. 1.25 A
Short circuit current limit		max. 1.3 A
Efficiency		approx. 95% (at nominal load)
Bit width in process image		2 input bits, 2 output bits (see KL9528 process image)
Current consumption from K-bus		typ. 10 mA
AS interface current consumption		approx. 60 mA
Isolation voltage	input / output voltage	none
	AS-i / K-bus	1500 V _{AC} (permanently)
Pluggable wiring		for all KSxxxx Bus Terminals
Weight		app. 150 g
Mounting ▶ 22		on 35 mm mounting rail conforms to EN 60715
Permissible ambient temperature during operation		0°C... +55°C
Permissible ambient temperature during storage		-25°C ... +85°C
Permissible relative humidity		95 %, no condensation
Vibration / shock resistance		conforms to EN 60068-2-6 / EN 60068-2-27 see also installation instructions ▶ 26 for enhanced mechanical load capacity
EMC resistance burst / ESD		conforms to EN 61000-6-2 / EN 61000-6-4
Protection class		IP20
Installation position		variable
Approvals/markings*		CE, UKCA, EAC

*) Real applicable approvals/markings see type plate on the side (product marking).

● Mapping of the KL6201 and KL9528

- i** Please note the following for addressing (mapping) of the KL6201 and KL9528:
- The KL6201 AS-i master terminal is a byte-oriented terminal!
 - The KL9528 AS-i power supply terminal is a byte-orientated terminal.

The Bus Terminals are always mapped in the following order in the Bus Coupler:

- First, all byte-oriented Bus Terminals appear in the process image in the order they were connected.
- Then, all bit-oriented Bus Terminals appear in the process image in the order they were connected.

This means that the KL6201 and KL9528 do not necessarily follow each other in the process image, even if they are connected side by side!

KL9528 - process image**Input data**

Bit	Value	Name	Meaning
1 and 0	00 _{bin}	OK	No error
	01 _{bin}	Overload	Due to an AS-i overload, the KL9528 has switched off the voltage. It can be switched on again with a leading edge of output bit 0. If the overload is still present, the KL9528 is switched off again.
	10 _{bin}	reserved	-
	11 _{bin}	Under-voltage	The KL9528 has switched off the AS-i voltage, because the input voltage had fallen below 21 V. As soon as the input voltage rises above 21 V, the KL9526 automatically switches the AS-i voltage back on.

Output data

Bit	Meaning
0	After a switch-off due to overload, a rising edge of this bit switches the AS-i voltage back on.
1	reserved

2.6 KL9520 - AS-i potential feed terminal with filter

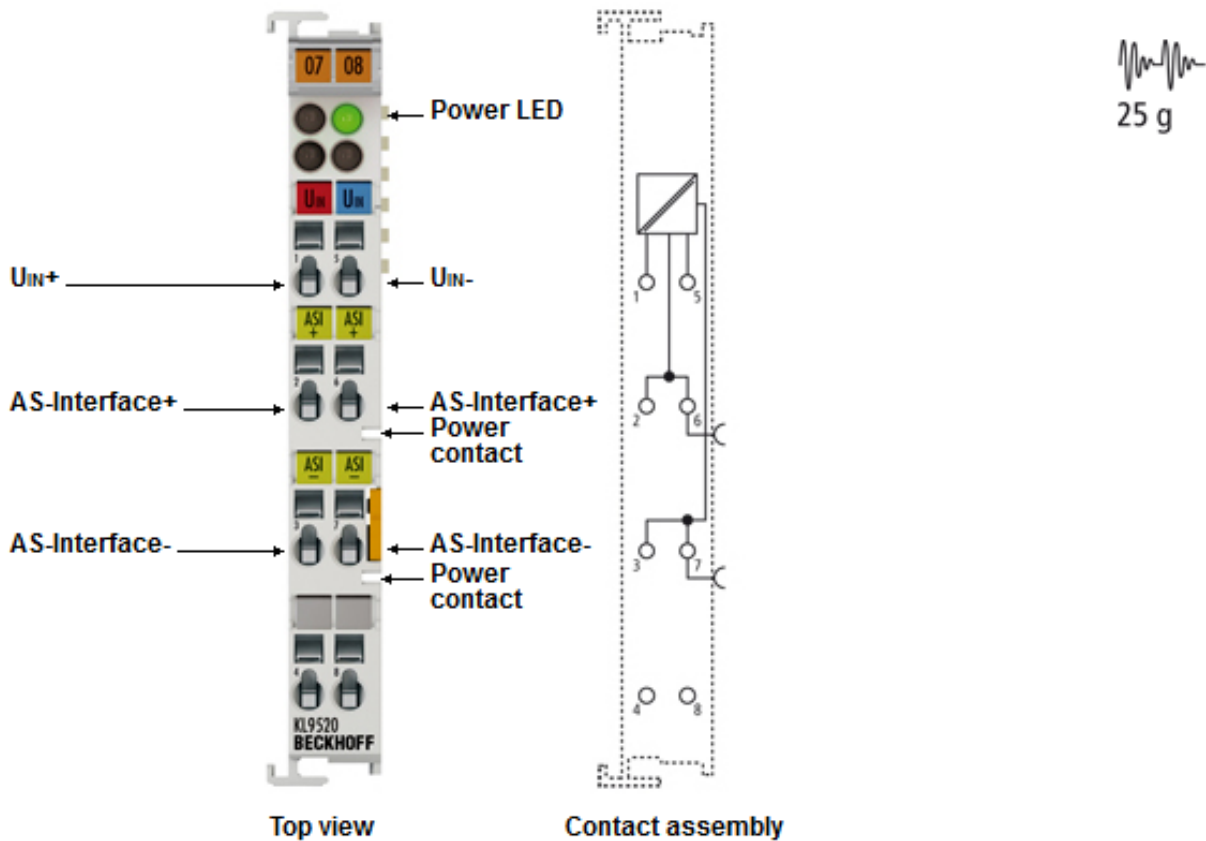

Fig. 5: KL9520 - AS-i potential feed terminal with filter

The KL9520 enables AS-i networks to be supplied from standard power supply units or another AS-Interface network. The combination of KL9520 and AS-i master terminal can be repeated several times in a Bus Terminal block, thereby saving several AS-i power supply units.

The KL9520 potential feed terminal decouples the input and output voltage through an integrated filter. There is no short-circuit protection and no electrical isolation between the input voltage and the output voltage!

The connection to the KL6211 AS-i master terminal is established by the power contacts during side-by-side plugging.

The KL6201 AS-i master terminal must be connected via cable bridges.

LED display

LED	Meaning	
Power (green)	off	AS-i voltage is switched off.
	on	AS-i voltage is switched on.

Technical data

Technical data		KL9520-0000 / KS9520-0000
Input voltage		up to 35 V _{DC}
Output voltage		up to 35 V _{DC}
Input current		max. 2 A
Output current		max. 2 A (not short-circuit-proof)
Current consumption from K-bus		0 mA
Isolation voltage	AS-i / K-bus	1500 V _{AC} (permanently)
	input / output voltage	none
Configuration		no address or configuration settings required
Bit width in process image		0 input bits, 0 output bits
Weight		app. 90 g
Permissible ambient temperature during operation		0°C ... +55°C
Permissible ambient temperature during storage		-25°C ... +85°C
Permissible relative humidity		95 %, no condensation
Pluggable wiring		for all KSxxxx Bus Terminals
Mounting [▶ 22]		on 35 mm mounting rail conforms to EN 60715
Vibration / shock resistance		conforms to EN 60068-2-6 / EN 60068-2-27 see also installation instructions [▶ 26] for enhanced mechanical load capacity
EMC resistance burst / ESD		conforms to EN 61000-6-2 / EN 61000-6-4
Protection class		IP20
Installation position		variable
Approvals/markings*		CE, UKCA, EAC

*) Real applicable approvals/markings see type plate on the side (product marking).

3 Mounting and wiring

3.1 Instructions for ESD protection

NOTE

Destruction of the devices by electrostatic discharge possible!

The devices contain components at risk from electrostatic discharge caused by improper handling.

- Please ensure you are electrostatically discharged and avoid touching the contacts of the device directly.
- Avoid contact with highly insulating materials (synthetic fibers, plastic film etc.).
- Surroundings (working place, packaging and personnel) should be grounded probably, when handling with the devices.
- Each assembly must be terminated at the right hand end with a KL9010 bus end terminal, to ensure the protection class and ESD protection.

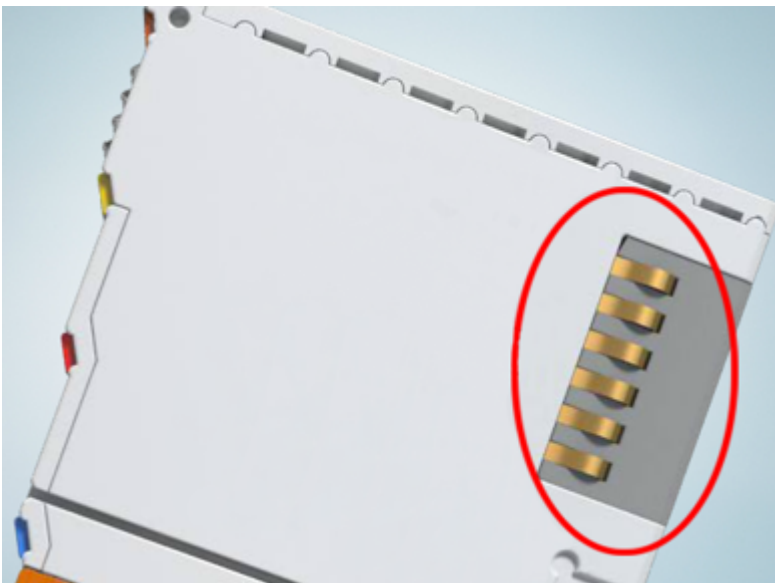

Fig. 6: Spring contacts of the Beckhoff I/O components

3.2 Installation on mounting rails

⚠ WARNING

Risk of electric shock and damage of device!

Bring the bus terminal system into a safe, powered down state before starting installation, disassembly or wiring of the bus terminals!

Assembly

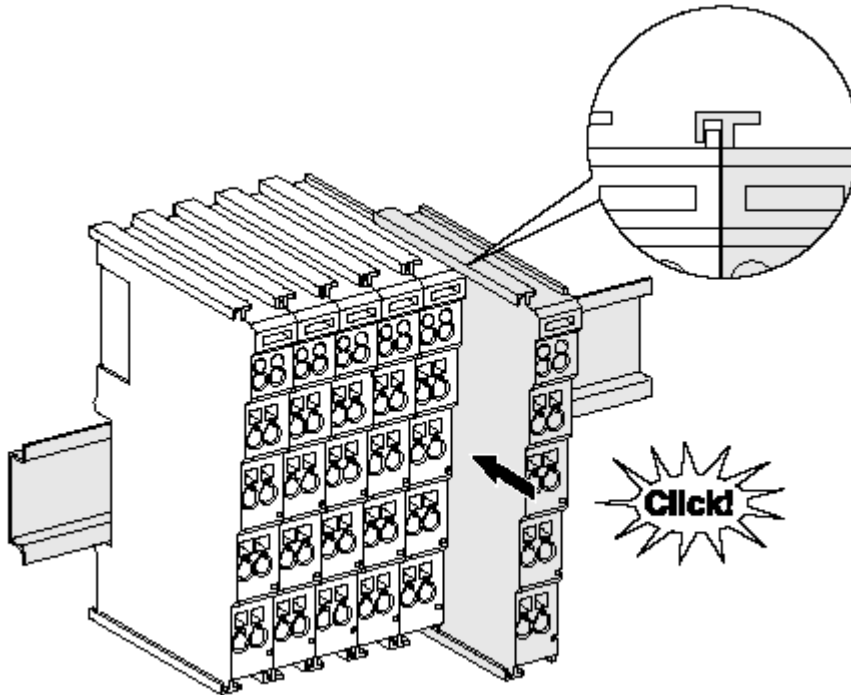

Fig. 7: Attaching on mounting rail

The bus coupler and bus terminals are attached to commercially available 35 mm mounting rails (DIN rails according to EN 60715) by applying slight pressure:

1. First attach the fieldbus coupler to the mounting rail.
2. The bus terminals are now attached on the right-hand side of the fieldbus coupler. Join the components with tongue and groove and push the terminals against the mounting rail, until the lock clicks onto the mounting rail.

If the terminals are clipped onto the mounting rail first and then pushed together without tongue and groove, the connection will not be operational! When correctly assembled, no significant gap should be visible between the housings.

i Fixing of mounting rails

The locking mechanism of the terminals and couplers extends to the profile of the mounting rail. At the installation, the locking mechanism of the components must not come into conflict with the fixing bolts of the mounting rail. To mount the mounting rails with a height of 7.5 mm under the terminals and couplers, you should use flat mounting connections (e.g. countersunk screws or blind rivets).

Disassembly

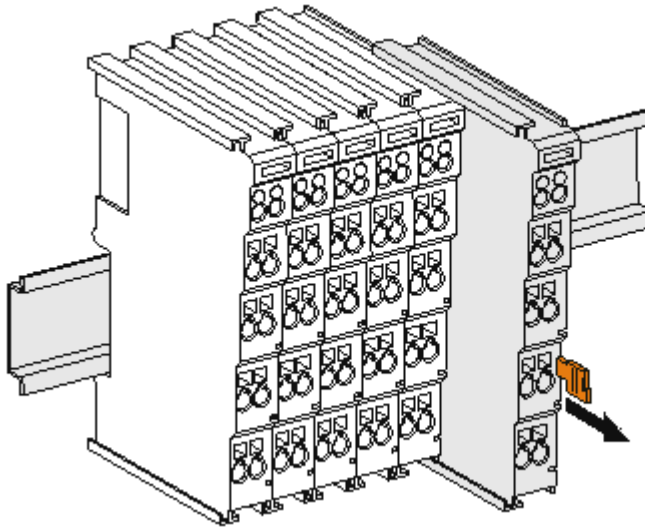

Fig. 8: Disassembling of terminal

Each terminal is secured by a lock on the mounting rail, which must be released for disassembly:

1. Pull the terminal by its orange-colored lugs approximately 1 cm away from the mounting rail. In doing so for this terminal the mounting rail lock is released automatically and you can pull the terminal out of the bus terminal block easily without excessive force.
2. Grasp the released terminal with thumb and index finger simultaneous at the upper and lower grooved housing surfaces and pull the terminal out of the bus terminal block.

Connections within a bus terminal block

The electric connections between the Bus Coupler and the Bus Terminals are automatically realized by joining the components:

- The six spring contacts of the K-Bus/E-Bus deal with the transfer of the data and the supply of the Bus Terminal electronics.
- The power contacts deal with the supply for the field electronics and thus represent a supply rail within the bus terminal block. The power contacts are supplied via terminals on the Bus Coupler (up to 24 V) or for higher voltages via power feed terminals.

● Power Contacts
i

During the design of a bus terminal block, the pin assignment of the individual Bus Terminals must be taken account of, since some types (e.g. analog Bus Terminals or digital 4-channel Bus Terminals) do not or not fully loop through the power contacts. Power Feed Terminals (KL91xx, KL92xx or EL91xx, EL92xx) interrupt the power contacts and thus represent the start of a new supply rail.

PE power contact

The power contact labeled PE can be used as a protective earth. For safety reasons this contact mates first when plugging together, and can ground short-circuit currents of up to 125 A.

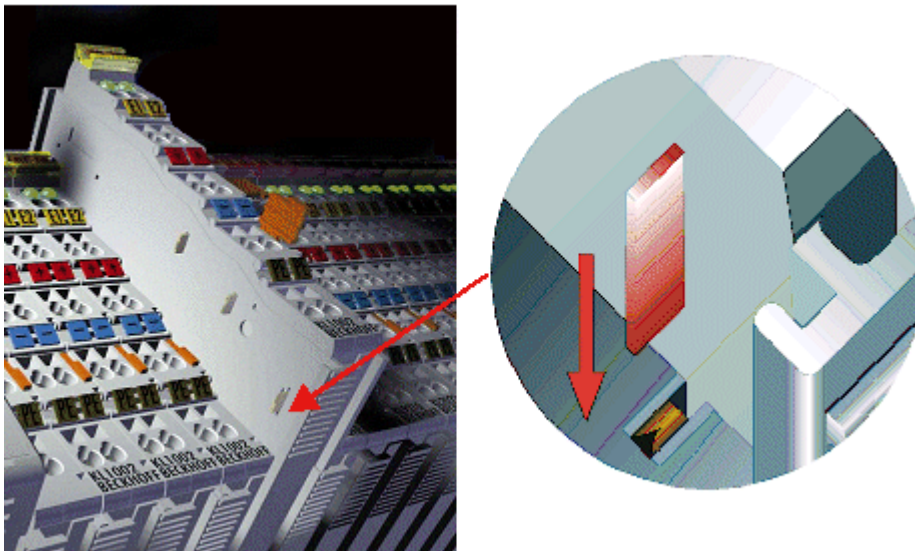

Fig. 9: Power contact on left side

NOTE**Possible damage of the device**

Note that, for reasons of electromagnetic compatibility, the PE contacts are capacitatively coupled to the mounting rail. This may lead to incorrect results during insulation testing or to damage on the terminal (e.g. disruptive discharge to the PE line during insulation testing of a consumer with a nominal voltage of 230 V). For insulation testing, disconnect the PE supply line at the Bus Coupler or the Power Feed Terminal! In order to decouple further feed points for testing, these Power Feed Terminals can be released and pulled at least 10 mm from the group of terminals.

⚠ WARNING**Risk of electric shock!**

The PE power contact must not be used for other potentials!

3.3 Installation positions

NOTE**Constraints regarding installation position and operating temperature range**

Please refer to the technical data for a terminal to ascertain whether any restrictions regarding the installation position and/or the operating temperature range have been specified. When installing high power dissipation terminals ensure that an adequate spacing is maintained between other components above and below the terminal in order to guarantee adequate ventilation!

Optimum installation position (standard)

The optimum installation position requires the mounting rail to be installed horizontally and the connection surfaces of the EL/KL terminals to face forward (see Fig. *Recommended distances for standard installation position*). The terminals are ventilated from below, which enables optimum cooling of the electronics through convection. "From below" is relative to the acceleration of gravity.

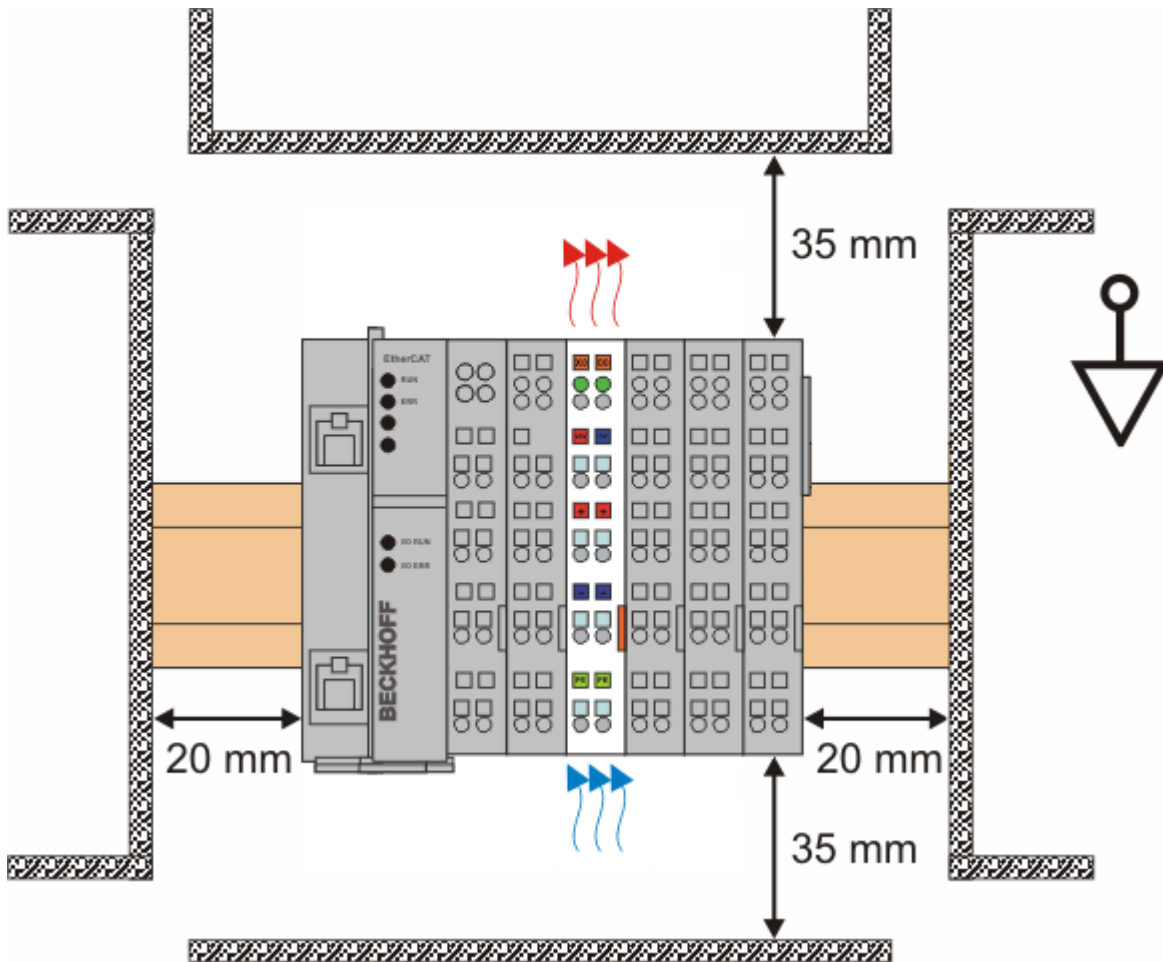

Fig. 10: Recommended distances for standard installation position

Compliance with the distances shown in Fig. *Recommended distances for standard installation position* is recommended.

Other installation positions

All other installation positions are characterized by different spatial arrangement of the mounting rail - see Fig *Other installation positions*.

The minimum distances to ambient specified above also apply to these installation positions.

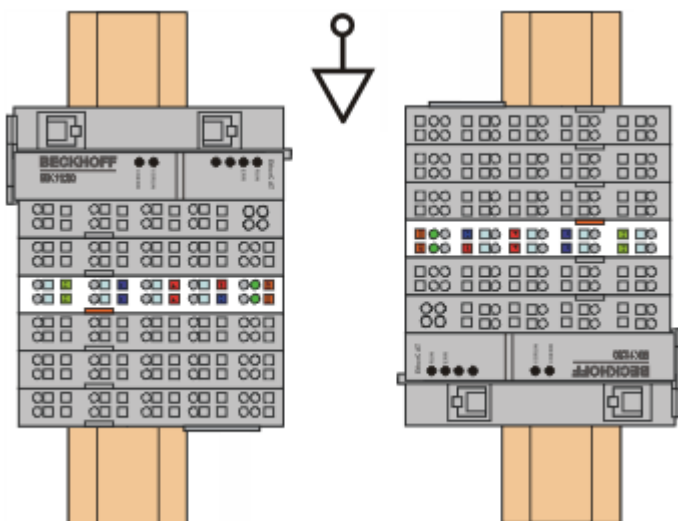

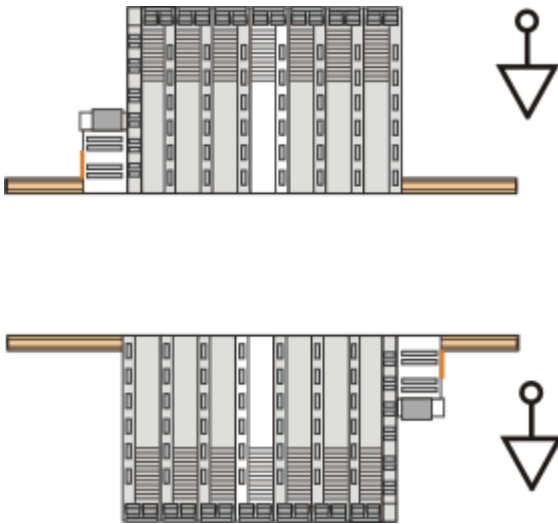

Fig. 11: Other installation positions

3.4 Installation instructions for enhanced mechanical load capacity

⚠ WARNING

Risk of injury through electric shock and damage to the device!

Bring the Bus Terminal system into a safe, de-energized state before starting mounting, disassembly or wiring of the Bus Terminals!

Additional checks

The terminals have undergone the following additional tests:

Verification	Explanation
Vibration	10 frequency runs in 3 axes
	6 Hz < f < 60 Hz displacement 0.35 mm, constant amplitude
	60.1 Hz < f < 500 Hz acceleration 5 g, constant amplitude
Shocks	1000 shocks in each direction, in 3 axes
	25 g, 6 ms

Additional installation instructions

For terminals with enhanced mechanical load capacity, the following additional installation instructions apply:

- The enhanced mechanical load capacity is valid for all permissible installation positions
- Use a mounting rail according to EN 60715 TH35-15
- Fix the terminal segment on both sides of the mounting rail with a mechanical fixture, e.g. an earth terminal or reinforced end clamp
- The maximum total extension of the terminal segment (without coupler) is:
64 terminals (12 mm mounting with) or 32 terminals (24 mm mounting with)
- Avoid deformation, twisting, crushing and bending of the mounting rail during edging and installation of the rail
- The mounting points of the mounting rail must be set at 5 cm intervals
- Use countersunk head screws to fasten the mounting rail
- The free length between the strain relief and the wire connection should be kept as short as possible. A distance of approx. 10 cm should be maintained to the cable duct.

3.5 Connection

3.5.1 Connection system

⚠ WARNING

Risk of electric shock and damage of device!

Bring the bus terminal system into a safe, powered down state before starting installation, disassembly or wiring of the bus terminals!

Overview

The bus terminal system offers different connection options for optimum adaptation to the respective application:

- The terminals of ELxxxx and KLxxxx series with standard wiring include electronics and connection level in a single enclosure.
- The terminals of ESxxxx and KSxxxx series feature a pluggable connection level and enable steady wiring while replacing.
- The High Density Terminals (HD Terminals) include electronics and connection level in a single enclosure and have advanced packaging density.

Standard wiring (ELxxxx / KLxxxx)



Fig. 12: Standard wiring

The terminals of ELxxxx and KLxxxx series have been tried and tested for years. They feature integrated screwless spring force technology for fast and simple assembly.

Pluggable wiring (ESxxxx / KSxxxx)



Fig. 13: Pluggable wiring

The terminals of ESxxxx and KSxxxx series feature a pluggable connection level. The assembly and wiring procedure is the same as for the ELxxxx and KLxxxx series. The pluggable connection level enables the complete wiring to be removed as a plug connector from the top of the housing for servicing. The lower section can be removed from the terminal block by pulling the unlocking tab. Insert the new component and plug in the connector with the wiring. This reduces the installation time and eliminates the risk of wires being mixed up.

The familiar dimensions of the terminal only had to be changed slightly. The new connector adds about 3 mm. The maximum height of the terminal remains unchanged.

A tab for strain relief of the cable simplifies assembly in many applications and prevents tangling of individual connection wires when the connector is removed.

Conductor cross sections between 0.08 mm² and 2.5 mm² can continue to be used with the proven spring force technology.

The overview and nomenclature of the product names for ESxxxx and KSxxxx series has been retained as known from ELxxxx and KLxxxx series.

High Density Terminals (HD Terminals)



Fig. 14: High Density Terminals

The terminals from these series with 16 terminal points are distinguished by a particularly compact design, as the packaging density is twice as large as that of the standard 12 mm bus terminals. Massive conductors and conductors with a wire end sleeve can be inserted directly into the spring loaded terminal point without tools.

● Wiring HD Terminals

i The High Density Terminals of the ELx8xx and KLx8xx series doesn't support pluggable wiring.

Ultrasonically “bonded” (ultrasonically welded) conductors

● Ultrasonically “bonded” conductors

i It is also possible to connect the Standard and High Density Terminals with ultrasonically “bonded” (ultrasonically welded) conductors. In this case, please note the tables concerning the wire-size width [► 29]!

3.5.2 Wiring

⚠ WARNING

Risk of electric shock and damage of device!

Bring the bus terminal system into a safe, powered down state before starting installation, disassembly or wiring of the bus terminals!

Terminals for standard wiring ELxxxx/KLxxxx and for pluggable wiring ESxxxx/KSxxxx

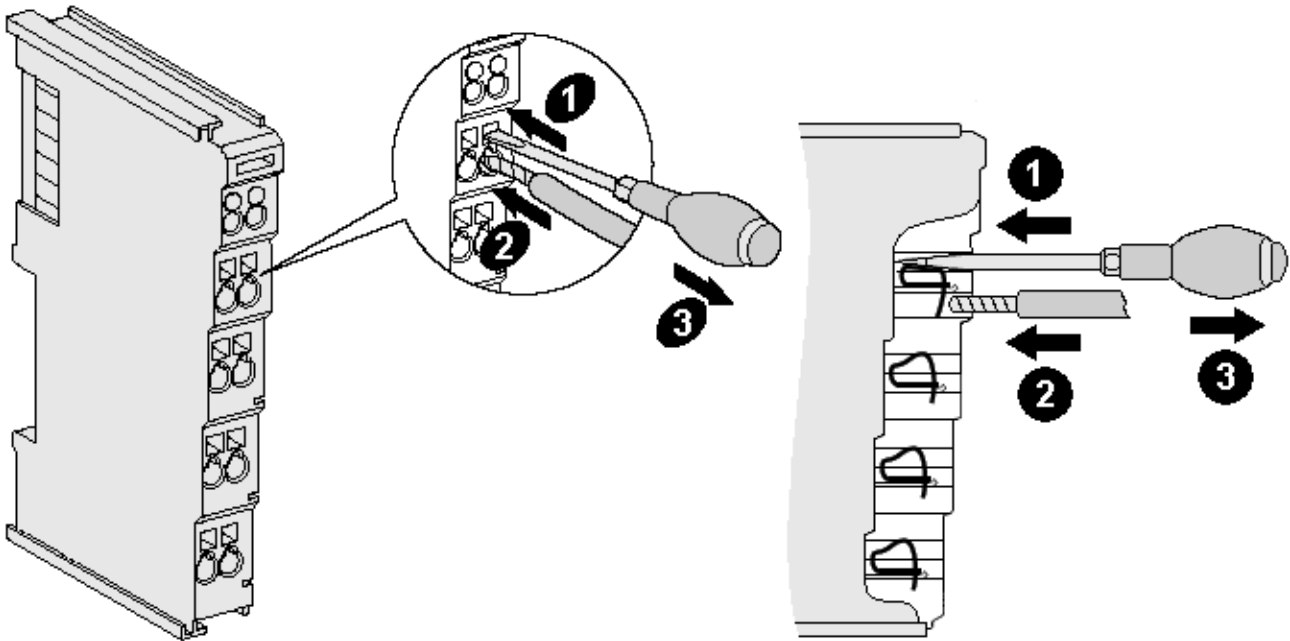

Fig. 15: Connecting a cable on a terminal point

Up to eight terminal points enable the connection of solid or finely stranded cables to the bus terminal. The terminal points are implemented in spring force technology. Connect the cables as follows:

1. Open a terminal point by pushing a screwdriver straight against the stop into the square opening above the terminal point. Do not turn the screwdriver or move it alternately (don't toggle).
2. The wire can now be inserted into the round terminal opening without any force.
3. The terminal point closes automatically when the pressure is released, holding the wire securely and permanently.

See the following table for the suitable wire size width.

Terminal housing	ELxxxx, KLxxxx	ESxxxx, KSxxxx
Wire size width (single core wires)	0.08 ... 2.5 mm ²	0.08 ... 2.5 mm ²
Wire size width (fine-wire conductors)	0.08 ... 2.5 mm ²	0.08 ... 2.5 mm ²
Wire size width (conductors with a wire end sleeve)	0.14 ... 1.5 mm ²	0.14 ... 1.5 mm ²
Wire stripping length	8 ... 9 mm	9 ... 10 mm

High Density Terminals (HD Terminals [▶ 28]) with 16 terminal points

The conductors of the HD Terminals are connected without tools for single-wire conductors using the direct plug-in technique, i.e. after stripping the wire is simply plugged into the terminal point. The cables are released, as usual, using the contact release with the aid of a screwdriver. See the following table for the suitable wire size width.

Terminal housing	High Density Housing
Wire size width (single core wires)	0.08 ... 1.5 mm ²
Wire size width (fine-wire conductors)	0.25 ... 1.5 mm ²
Wire size width (conductors with a wire end sleeve)	0.14 ... 0.75 mm ²
Wire size width (ultrasonically "bonded" conductors)	only 1.5 mm ² (see notice [▶ 28])
Wire stripping length	8 ... 9 mm

3.5.3 Shielding



Shielding

Encoder, analog sensors and actors should always be connected with shielded, twisted paired wires.

3.6 AS-i installation

⚠ WARNING

Risk of injury through electric shock and damage to the device!

Bring the Bus Terminals system into a safe, de-energized state before starting mounting, disassembly or wiring of the Bus Terminals!

Connection of the AS interface

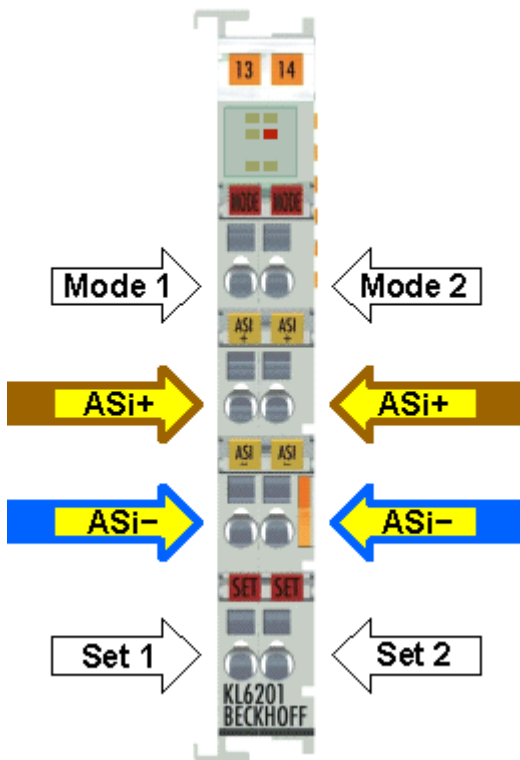

Fig. 16: Connection of the AS interface

Terminal	Use
Mode 1, Mode 2	The AS-i master terminal can be reset to factory default settings by short-circuiting the two mode inputs.
ASi+	ASi+ connection (brown). Both terminal points identified with ASi+ are connected internally.
ASi-	ASi- connection (blue). Both terminal points identified with ASi- are connected internally.
Set 1, Set 2	The detected devices from the list of detected devices (LDS [▶ 12]) can be projected for protected mode by short-circuiting the two set inputs. This corresponds to the functionality of parameter 0x108 [▶ 87] (command interface), if the value 0x0210 is entered there.

Wiring of the AS interface

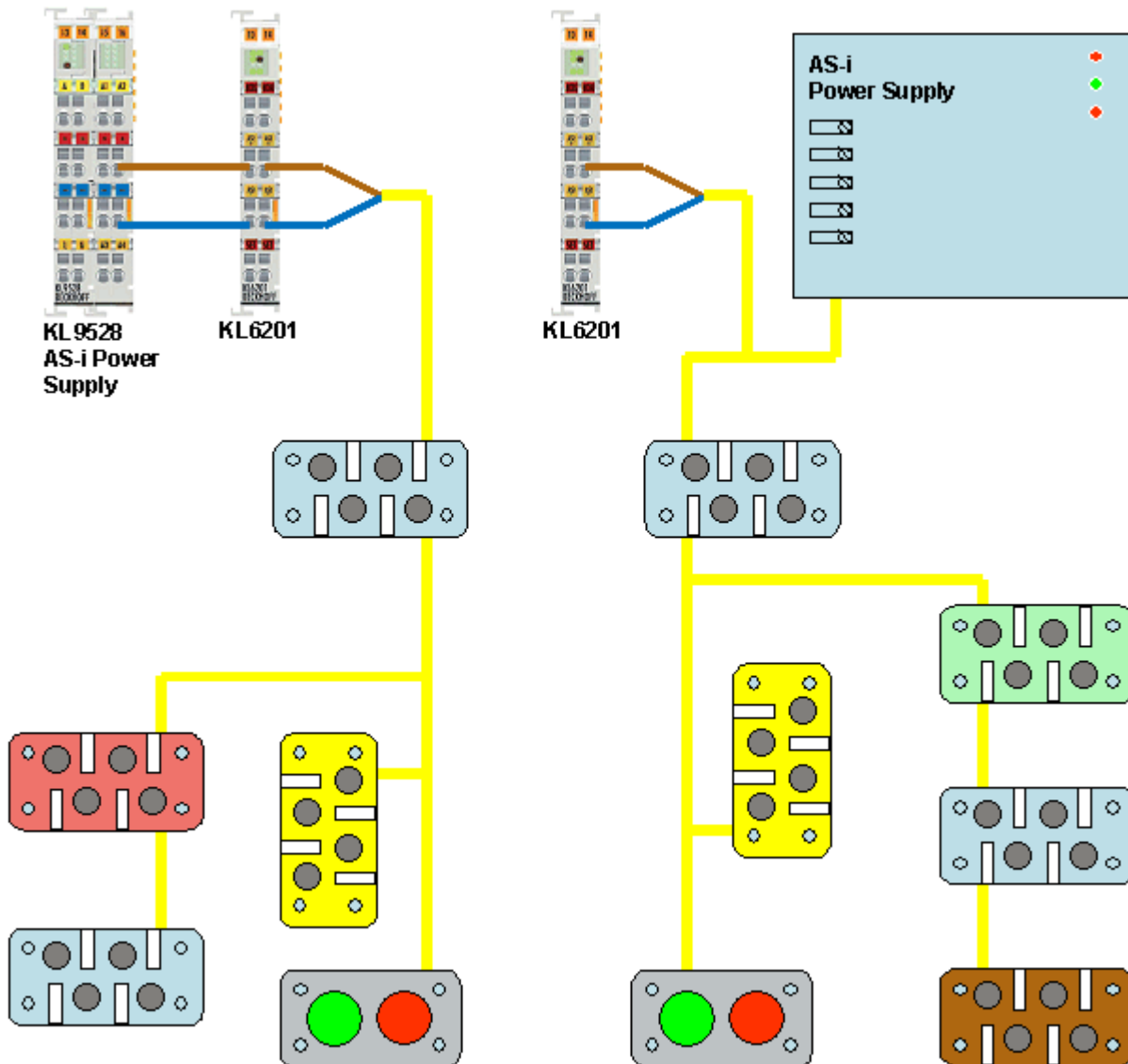

Fig. 17: Wiring of the AS interface

Since the user data are modulated on the power supply line with the AS-Interface, a special AS-i power supply unit (30.5 V_{DC}) is required. You can

- use the [KL9528](#) [[▶ 16](#)] AS-i power supply terminal with integrated data decoupling or
- the [KL9520](#) [[▶ 19](#)] AS-i potential feed terminal in conjunction with a standard power supply units.

3.7 Disposal



Products marked with a crossed-out wheeled bin shall not be discarded with the normal waste stream. The device is considered as waste electrical and electronic equipment. The national regulations for the disposal of waste electrical and electronic equipment must be observed.

3.8 ATEX - Special conditions (standard temperature range)

⚠ WARNING

Observe the special conditions for the intended use of Beckhoff fieldbus components with standard temperature range in potentially explosive areas (directive 2014/34/EU)!

- The certified components are to be installed in a suitable housing that guarantees a protection class of at least IP54 in accordance with EN 60079-15! The environmental conditions during use are thereby to be taken into account!
- For dust (only the fieldbus components of certificate no. KEMA 10ATEX0075 X Issue 9): The equipment shall be installed in a suitable enclosure providing a degree of protection of IP54 according to EN 60079-31 for group IIIA or IIIB and IP6X for group IIIC, taking into account the environmental conditions under which the equipment is used!
- If the temperatures during rated operation are higher than 70°C at the feed-in points of cables, lines or pipes, or higher than 80°C at the wire branching points, then cables must be selected whose temperature data correspond to the actual measured temperature values!
- Observe the permissible ambient temperature range of 0 to 55°C for the use of Beckhoff fieldbus components standard temperature range in potentially explosive areas!
- Measures must be taken to protect against the rated operating voltage being exceeded by more than 40% due to short-term interference voltages!
- The individual terminals may only be unplugged or removed from the Bus Terminal system if the supply voltage has been switched off or if a non-explosive atmosphere is ensured!
- The connections of the certified components may only be connected or disconnected if the supply voltage has been switched off or if a non-explosive atmosphere is ensured!
- The fuses of the KL92xx/EL92xx power feed terminals may only be exchanged if the supply voltage has been switched off or if a non-explosive atmosphere is ensured!
- Address selectors and ID switches may only be adjusted if the supply voltage has been switched off or if a non-explosive atmosphere is ensured!

Standards

The fundamental health and safety requirements are fulfilled by compliance with the following standards:

- EN 60079-0:2012+A11:2013
- EN 60079-15:2010
- EN 60079-31:2013 (only for certificate no. KEMA 10ATEX0075 X Issue 9)

Marking

The Beckhoff fieldbus components with standard temperature range certified according to the ATEX directive for potentially explosive areas bear one of the following markings:



II 3G KEMA 10ATEX0075 X Ex nA IIC T4 Gc Ta: 0 ... +55°C
 II 3D KEMA 10ATEX0075 X Ex tc IIIC T135°C Dc Ta: 0 ... +55°C
 (only for fieldbus components of certificate no. KEMA 10ATEX0075 X Issue 9)

or



II 3G KEMA 10ATEX0075 X Ex nA nC IIC T4 Gc Ta: 0 ... +55°C
 II 3D KEMA 10ATEX0075 X Ex tc IIIC T135°C Dc Ta: 0 ... +55°C
 (only for fieldbus components of certificate no. KEMA 10ATEX0075 X Issue 9)

3.9 Continulative documentation for ATEX and IECEx

NOTE



Continulative documentation about explosion protection according to ATEX and IECEx

Pay also attention to the continuative documentation

Ex. Protection for Terminal Systems

Notes on the use of the Beckhoff terminal systems in hazardous areas according to ATEX and IECEx,

that is available for [download](#) within the download area of your product on the Beckhoff homepage www.beckhoff.com!

4 KS2000 Configuration Software

4.1 KS2000 - Introduction

The KS2000 configuration software permits configuration, commissioning and parameterization of bus couplers, of the affiliated bus terminals and of Fieldbus Box Modules. The connection between bus coupler / Fieldbus Box Module and the PC is established by means of the serial configuration cable or the fieldbus.



Fig. 18: KS2000 configuration software

Configuration

You can configure the Fieldbus stations with the Configuration Software KS2000 offline. That means, setting up a terminal station with all settings on the couplers and terminals resp. the Fieldbus Box Modules can be prepared before the commissioning phase. Later on, this configuration can be transferred to the terminal station in the commissioning phase by means of a download. For documentation purposes, you are provided with the breakdown of the terminal station, a parts list of modules used and a list of the parameters you have modified. After an upload, existing fieldbus stations are at your disposal for further editing.

Parameterization

KS2000 offers simple access to the parameters of a fieldbus station: specific high-level dialogs are available for all bus couplers, all intelligent bus terminals and Fieldbus Box modules with the aid of which settings can be modified easily. Alternatively, you have full access to all internal registers of the bus couplers and intelligent terminals. Refer to the register description for the meanings of the registers.

Commissioning

The KS2000 software facilitates commissioning of machine components or their fieldbus stations: Configured settings can be transferred to the fieldbus modules by means of a download. After a *login* to the terminal station, it is possible to define settings in couplers, terminals and Fieldbus Box modules directly *online*. The same high-level dialogs and register access are available for this purpose as in the configuration phase.

The KS2000 offers access to the process images of the bus couplers and Fieldbus Box modules.

- Thus, the coupler's input and output images can be observed by monitoring.
- Process values can be specified in the output image for commissioning of the output modules.

All possibilities in the *online mode* can be used in parallel with the actual fieldbus mode of the terminal station. The fieldbus protocol always has the higher priority in this case.

4.2 Configuration of the KL6201/KL6211

Connect the configuration interface of your fieldbus coupler with the serial interface of your PC via the configuration cable and start the *KS2000* Configuration Software.



Click on the *Login* button. The configuration software will now load the information for the connected fieldbus station.

In the example shown, this is

- a BK9000 Ethernet Coupler
- a KL9528 AS-i power supply terminal (double overall width)
- a KL6201 AS-i Master Terminal
- a KL9010 bus end terminal

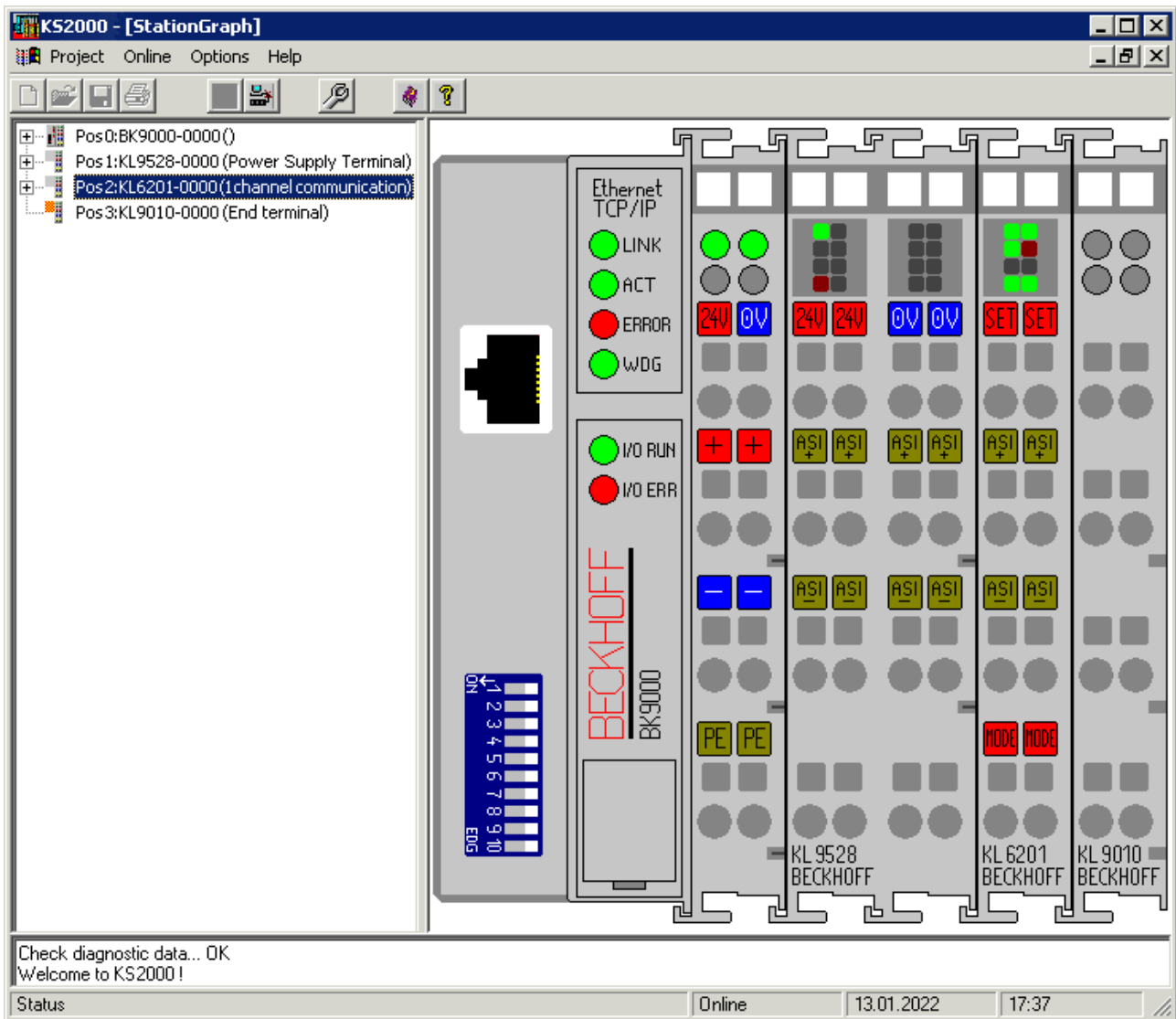

Fig. 19: Display of the fieldbus station in KS2000

The left-hand KS2000 window displays the terminals of the fieldbus station in a tree structure. The right-hand KS2000 window contains a graphic display of the fieldbus station terminals.

In the tree structure of the left-hand window, click on the plus-sign next to the terminal whose parameters you wish to change (item 1 in the example).

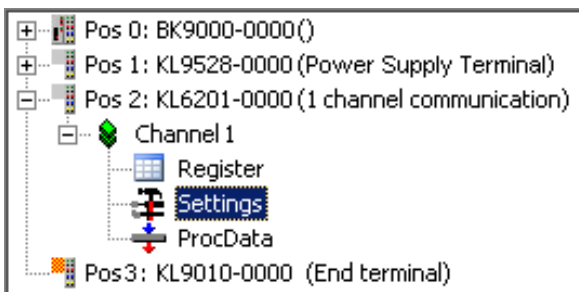

Fig. 20: KS2000 branches for channel 1 of the KL6201

For the KL6201/KL6211, the branches *Register*, *Settings* and *ProcData* are displayed:

- [Register](#) [▶ 38] enables direct access to the KL6201/KL6211 registers.
- Dialog masks for the parameterization of the KL6201/KL6211 can be found under [Settings](#) [▶ 39].
- [ProcData](#) [▶ 45] shows the process data of the KL6201/KL6211.

4.3 Register

Under *Register* you can directly access the registers of the KL6201/KL6211. The meaning of the register is explained in the [register overview](#) [▶ 56].

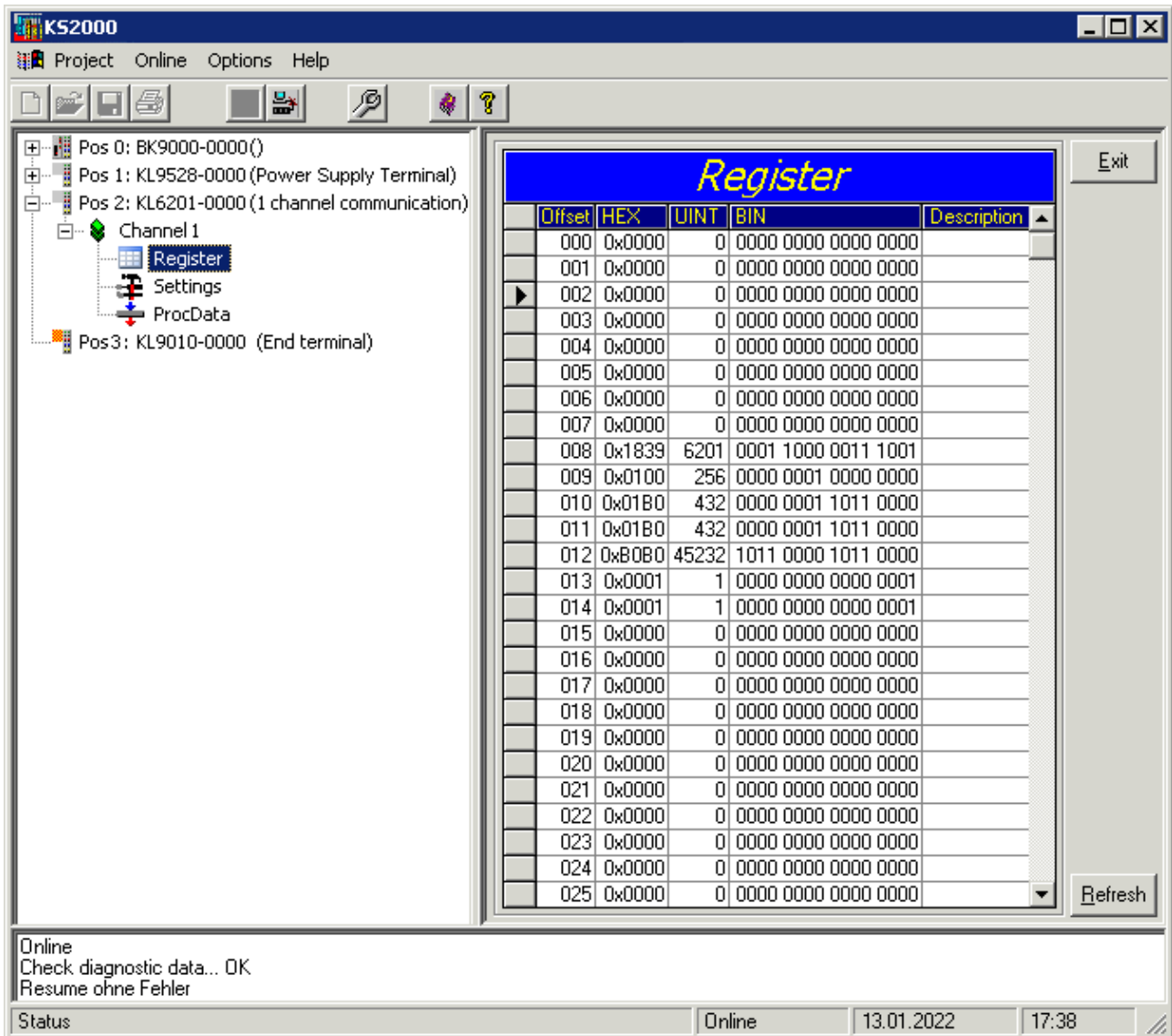

Fig. 21: Register view in KS2000

The screenshot shows the registers of the KL6201.

Also see about this

- AS-i installation [▶ 30]
- KS2000 - AS-i settings [▶ 40]

4.4 KS2000 Settings

The dialog masks for parameterizing the KL6201/KL6211 and AS-i slaves connected to it can be found under *Settings*.

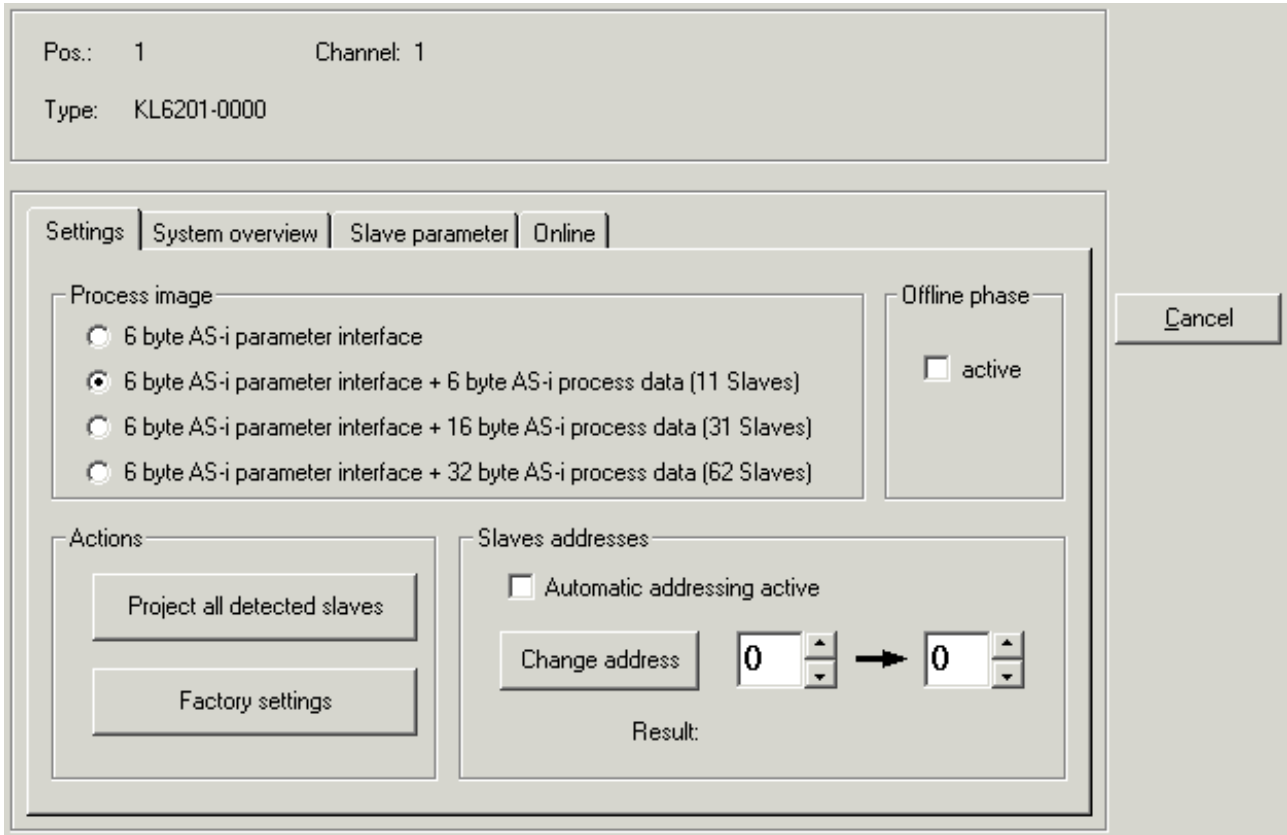

Fig. 22: Settings for the KL6201 in the KS2000 configuration software

Settings

Under this tab you can change the [settings \[▶ 40\]](#) of the KL6201/KL6211 and the connected AS-i slaves.

System overview

Select this tab for checking the [projecting state \[▶ 42\]](#) of the connected AS-i slaves.

Slave parameters

Select this tab for modifying the [Parameters \[▶ 43\]](#) of the connected AS-i slaves.

4.5 KS2000 - AS-i settings

Under this tab you can change the settings of the KL6201/KL6211 and the connected AS-i slaves.

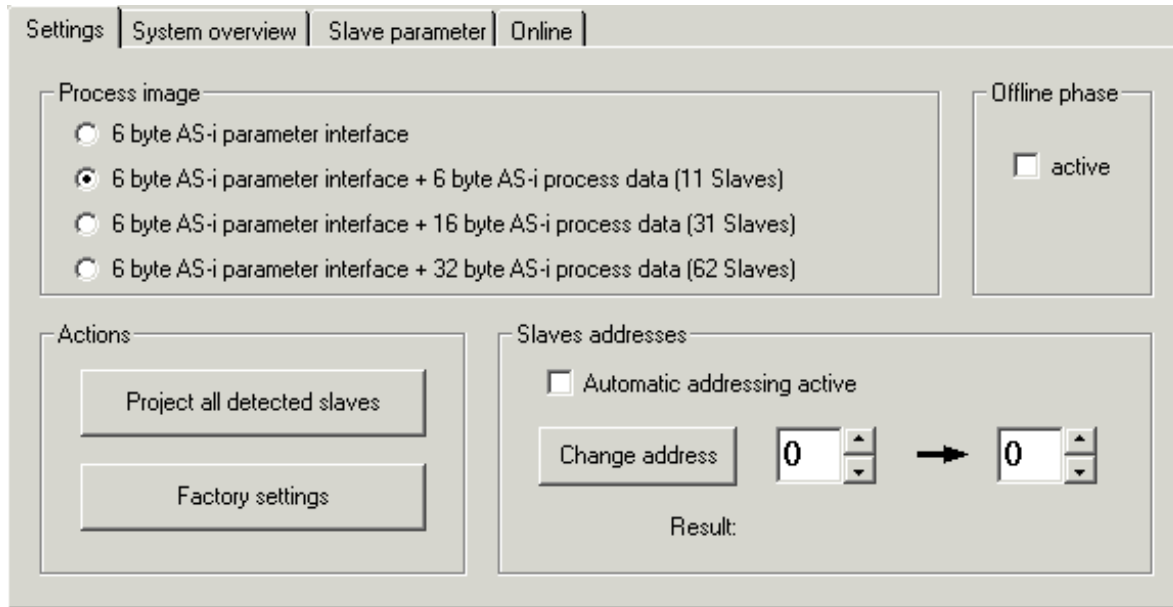

Fig. 23: KS2000 - AS-i settings

Process image

Here you can select the size of the process image of the KL6201/KL6211. It is stored in register [R27 \[► 57\]](#) of the KL6201/KL6211.

- 6-byte AS-i parameter interface = 6-byte process image:
no direct access to the process data of the AS-i slaves! The process data access must take place via the AS-i parameters [0x80 to 0x87 \[► 73\]](#) (digital slaves) or [0x204 to 0x27F \[► 94\]](#) (analog slaves).
- 6-byte AS-i parameter interface + 6-byte AS-i process data (11 slaves) = 12-byte process image:
supports direct access to the process data of AS-i slaves 1 to 11 (default).
- 6-byte AS-i parameter interface + 16-byte AS-i process data (32 slaves) = 22-byte process image:
supports direct access to the process data of AS-i slaves 1 to 21.
- 6-byte AS-i parameter interface + 32-byte AS-i process data (64 slaves) = 38-byte process image:
supports direct access to the process data of AS-i slaves 1 to 31 and 33 (1B) to 63 (31B)

After changing the process image the Bus Coupler must be restarted for the modified process image to take effect.

Please refer to chapter [Bus Coupler firmware version \[► 116\]](#) to ascertain whether your Bus Coupler/Bus Terminal Controller supports the required KL6201/KL6211 process image.

Offline phase

This checkbox can be used to switch the KL6201/KL6211 to the offline phase. The setting is transferred with bit 2 of the AS-i command nibble.

Actions

project all detected slaves:

When this button is pressed, the KL6201/KL6211 reconfigures all detected and currently projected AS-i slaves.

Factory settings:

Press this button to reset the KL6201/KL6211 to the delivery state. Any existing projection settings are deleted.

Slave addresses

Automatic addressing activated

Automatic addressing can be activated with this check box. The setting is transferred with bit 1 of the AS-i command nibble.

Change address

The AS-i slave addresses can be changed here. Enter the old address in the left field, enter the new address of the AS-i slave whose address you would like to change in the right field and press *Change address*. The address change can be verified via the [System overview](#) [▶ 42] tab.

AS-i slaves whose address have been changed have to be re-projected (see actions: [Project all detected slaves](#) [▶ 40] button).

● AS-i slaves



- AS-i slaves 1 to 31 may also be identified as 1A to 31A (A addresses).
- AS-i slave address 32 is not permitted.
- AS-i slaves 33 to 63 may also be identified as 1B to 31B (B addresses).
- AS-i slaves 33 to 63 (B addresses) are only supported by digital AS-i slaves (A/B slaves). Analog AS-i slaves, for example, do not support the B addresses!

The KS2000 software uses the AS-i command interface for addressing (AS-i parameter [0x100](#) [▶ 85]).

Result

- OK is displayed if the address change was successful.
- If the address could not be changed, an error code is displayed.

Code	Meaning
OK (0x00)	Address modification was successful.
0x11	There is no slave with the address that was specified in the left field (old address).
0x22	Address 0 is currently assigned to another slave. To change the address of an AS-i slave, the KL6201/KL6211 first has to assign the address 0 to it, before a new address can be assigned.
0x36	A slave with the address that was specified in the right field (new address) already exists.
0x47	After deleting the old address, no slave with address 0 exists.
0x58	After deleting the old address, an error is generated during reading of the extended ID code 1 of slave 0. Address changes for A/B slaves also require the extended ID code 1.
0x69	After writing of extended ID code 1, no slave with address 0 exists.
0x6B	After writing of the new address, the slave with the new address is not available during reading of the ID code.
0x6C	After writing of the new address, the slave with the new address is not available during reading of the status.
0x7D	The address could not be saved permanently (non-volatile).
0x7E	The extended ID code of an A/B slave could not be saved permanently (non-volatile).
0x7F	ID code 1 is invalid for A/B slaves
0x83	The new address is a B address. If slaves are to be operated on two parallel addresses in address ranges A and B, e.g. 10A (10) and 10B (42), both slaves have to support B addressing. In this case, the parallel A address already contains a slave that does not support B addressing!
0x84	The new address is a B address. The slave selected with the old address is not an A/B slave, i.e. it does not support the B addresses (33 to 63).
0x85	The new address is an A address. Slave is not an A/B slave: the associated B slave for the new address exists.

4.6 KS2000 - AS-i system overview

This tab can be used to check the projecting state of the connected AS-i slaves.

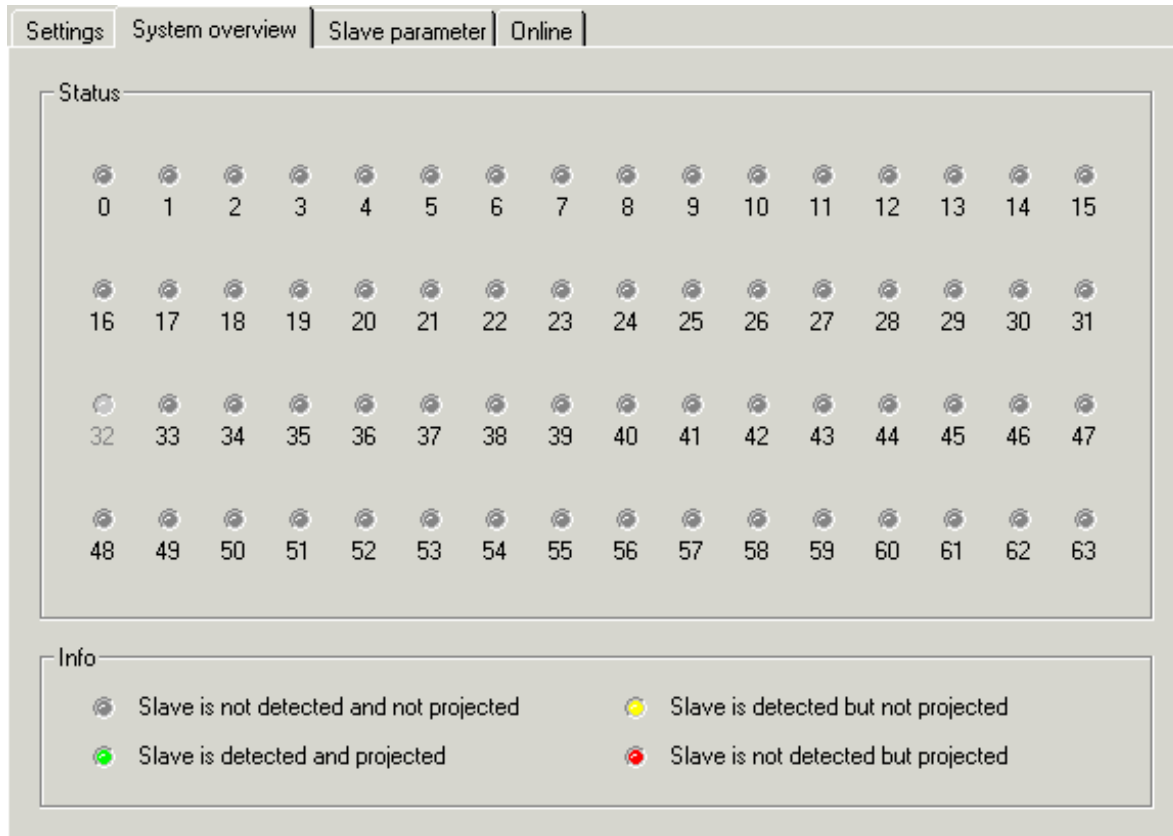

Fig. 24: KS2000 - AS-i system overview

The current projecting state corresponds to the color shown.

i AS-i slaves

- AS-i slaves 1 to 31 may also be identified as 1A to 31A.
- AS-i slave address 32 is not permitted.
- AS-i slaves 33 to 63 may also be identified as 1B to 31B.

4.7 KS2000 - AS-i slave parameters

This tab shows information about the connected AS-i configuration.

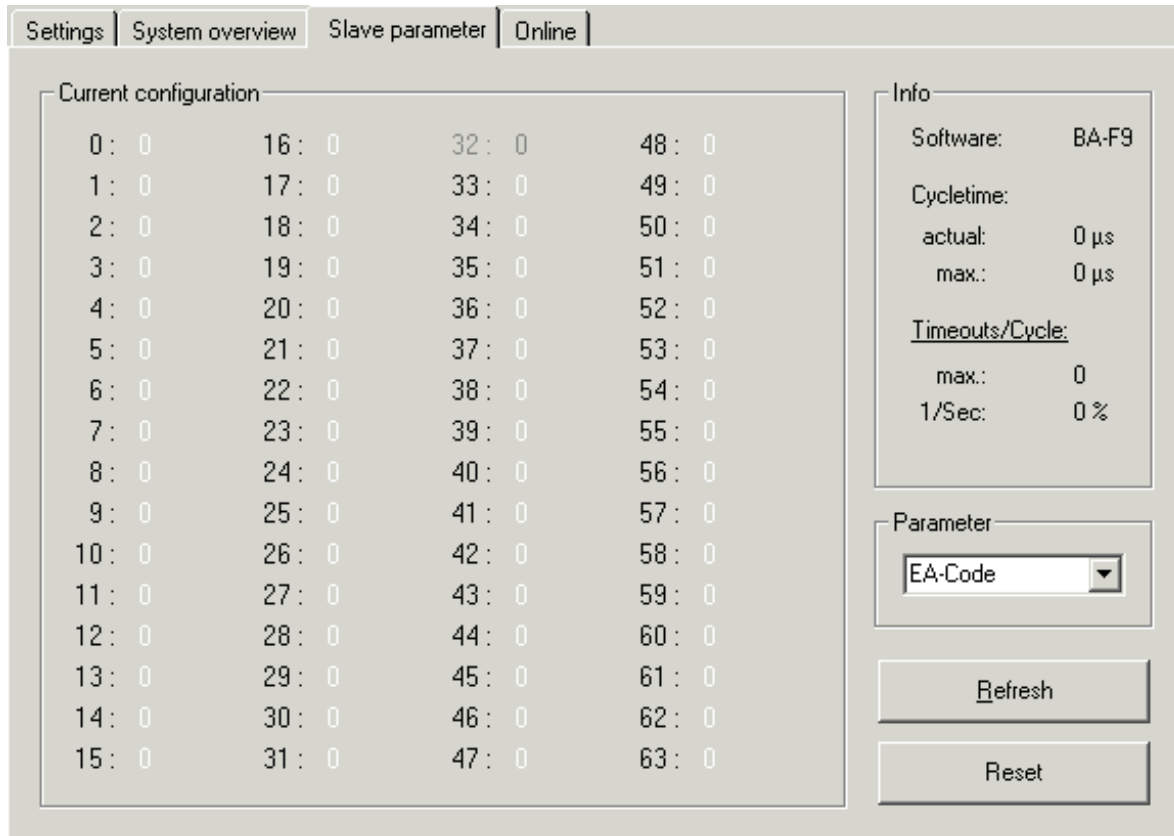

Fig. 25: KS2000 - AS-i slave parameters

Current configuration

Here you can check the parameters of the connected AS-i slave.

Parameter

Select the required parameter in the check box. It is displayed for all AS-i slaves in the *current configuration* field.

I/O code

Displays the read I/O codes of the AS-i slaves (parameters [0x90 to 0x97](#) [[▶ 75](#)]).

ID code

Displays the read standard ID codes of the AS-i slaves (parameters [0x48 to 0x4F](#) [[▶ 76](#)]).

Parameter

Displays the activation parameters for the AS-i slaves (parameters [0x50 to 0x57](#) [[▶ 70](#)]).

Status

Displays the read states of the AS-i slaves (parameters [0xA0 to 0xA7](#) [[▶ 77](#)]).

Timeout

Displays the timeout counters of the AS-i slaves (parameters [0x160 to 0x17F](#) [[▶ 89](#)]).

LeaveDataExch

Displays the LeaveDataExch counters of the AS-i slaves (parameters [0x1A0 to 0x1BF](#) [[▶ 91](#)]).

Physical Fault

Displays the physical fault counter of the AS-i slaves (parameters [0x140 to 0x15F](#) [[▶ 87](#)]).

Repeat 1 to 5

Displays one of the 5 repeat counters of the AS-i slaves (parameters [0x340 to 0x35F](#) [[▶ 96](#)]).

Info

Displays further information about the connected AS-i configuration.

Software

Shows the firmware version of the KL6201/KL6211.

Cycle time

Displays the cycle time of the AS-i bus:

- current: current AS-i cycle time
- max.: maximum cycle time so far

Timeouts/Cycle

Displays the timeouts on the AS-i bus:

- max.: maximum number of timeouts that have occurred during a cycle so far
- 1/sec: timeouts relative to the number of AS-i telegrams

4.8 Process data

The Status byte (Status), the Control byte (Ctrl) and the process data (Data) are displayed in a tree structure under *ProcData*.

Process data							
Pos	Type	I-Address	Value	Bitsize	O-Address	Value	Bitsize
2	KL6201-0000						
	Channel 1						
	Status	0.0	0x0241	16			
	Parameter In	2.0	0x80000120	32			
	ASI In Slave 1 Slave 2	6.0	0x01	8			
	ASI In Slave 3 Slave 4	7.0	0x00	8			
	ASI In Slave 5 Slave 6	8.0	0x00	8			
	ASI In Slave 7 Slave 8	9.0	0x00	8			
	ASI In Slave 9 Slave 10	10.0	0x00	8			
	ASI In Slave 11 Slave 12	11.0	0x00	8			
	Control				0.0	0x0000	16
	Parameter Out				2.0	0x00000000	32
	ASI Out Slave 1 Control				6.0	0x00	8
	ASI Out Slave 3 Slave 4				7.0	0x00	8
	ASI Out Slave 5 Slave 6				8.0	0x00	8
	ASI Out Slave 7 Slave 8				9.0	0x00	8
	ASI Out Slave 9 Slave 10				10.0	0x00	8
	ASI Out Slave 11 Slave 12				11.0	0x00	8

Fig. 26: KS2000 - Process data

The reading glasses mark the data that are currently graphically displayed in the *History* field.

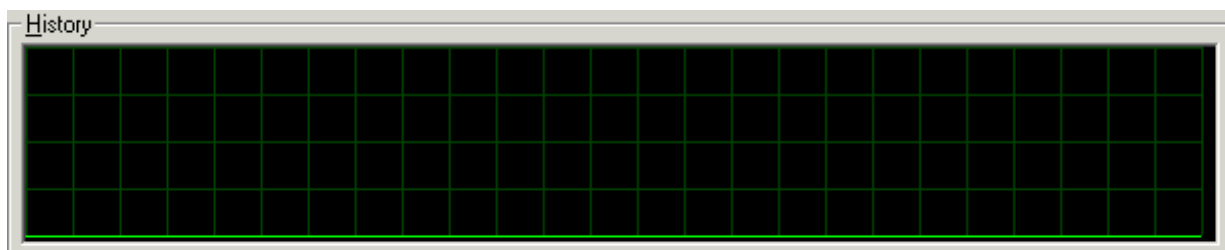

Fig. 27: KS2000 - Process data chart

The current input values are displayed numerically in the *Value* field.

Value

Decimal

Hexadecimal

Binary

Fig. 28: KS2000 - Current value of process data

Output values can be modified through direct input or by means of the fader control.

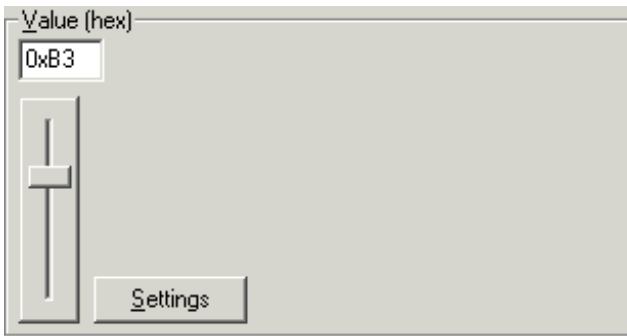

Fig. 29: KS2000 - Output values

⚠ CAUTION**Danger for persons, the environment or devices!**

Note that changing initial values (forcing them) can have a direct effect on your automation application. Only modify these initial values if you are certain that the state of your equipment permits it, and that there will be no risk to people or to the machine!

After pressing the *Settings* button you can set the format of the numerical display to hexadecimal, decimal or binary.

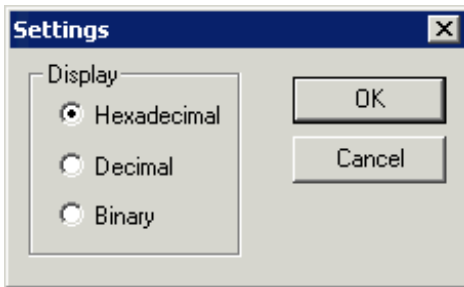

Fig. 30: KS2000 - Selecting the display format for process data

5 Access from the user program

5.1 Process image

The process image of the AS-i master terminal always consists of a 6-byte parameter data block and a 0-, 6-, 16- or 30-byte process data block. The result is a 6-, 12-, 22-, or 38-byte process image. The size of the process image can be set via the KS2000 configuration software, or fieldbus-specific via the Bus Coupler. If the KL6201/KL6211 is used in conjunction with Bus Couplers or Bus Terminal Controllers for PROFIBUS and CANopen, there are certain special characteristics which are described in chapters [KL6201/KL6211 with \[▶ 104\] PROFIBUS couplers \[▶ 104\]](#) and [KL6201/KL6211 with CANopen coupler \[▶ 110\]](#).

Description of the process images



Dummy nibbles

Unused AS-i slave addresses are stored as a dummy nibble on the output side of the process image and are not evaluated. The associated entries in the input data are zeroed.

5.1.1 6-byte process image

The 6-byte process image only consists of the parameter data block. In contrast to the other process images, it does not support direct access to the process data of the AS-i slaves. The process data access must take place via the AS-i parameters [0x80 to 0x87 \[▶ 73\]](#) (digital slaves) or [0x204 to 0x27F \[▶ 94\]](#) (analog slaves).

Input data (KL6201/KL6211 -> PLC)

Parameter data block [▶ 51] (6 bytes)					
Byte 0	Byte 1	Byte 2	Byte 3	Byte 4	Byte 5
SB0	SB1	ParaIn0	ParaIn1	ParaIn2	ParaIn3

Output data (PLC -> KL6201/KL6211)

Parameter data block [▶ 50] (6 bytes)					
Byte 0	Byte 1	Byte 2	Byte 3	Byte 4	Byte 5
CB0	CB1	ParaOut0	ParaOut1	ParaOut2	ParaOut3

Key

- CB n: control byte n
- SB n: status byte n
- Para In n: Input parameter, byte n
- Para Out n: Output parameter, byte n
- ASiSN: AS-i status nibble
- ASiCN: AS-i command nibble
- ASiIn slave x+y: Input data of the AS-i slaves x and y (one nibble per slave)
- ASiOut slave x+y: Output data of the AS-i slaves x and y (one nibble per slave)

5.1.2 12-byte process image Process image

If only AS-i slave addresses lower than 12 are used, the 12-byte process image is sufficient. This selection saves bandwidth both on the fieldbus and on the K-bus. Since the 12 bytes for AS-i terminal can be transferred in one K-Bus cycle, this selection also provides optimum speed for the update rate of the other terminals. This setting is enabled in delivery state of the KL6201/KL6211.

Input data (KL6201/KL6211 -> PLC)

Parameter data block [▶ 51] (6 bytes)						Process data block [▶ 52] (6 bytes)					
Byte 0	Byte 1	Byte 2	Byte 3	Byte 4	Byte 5	Byte 6	Byte 7	Byte 8	Byte 9	Byte 10	Byte 11
SB0	SB1	Para In0	Para In1	Para In2	Para In3	ASiSN + ASiIn Slave 1	ASiIn Slaves 2+3	ASiIn Slaves 4+5	ASiIn Slaves 6+7	ASiIn Slaves 8+9	ASiIn Slaves 10+11

Output data (PLC -> KL6201/KL6211)

Parameter data block [▶ 50] (6 bytes)						Process data block [▶ 54] (6 bytes)					
Byte 0	Byte 1	Byte 2	Byte 3	Byte 4	Byte 5	Byte 6	Byte 7	Byte 8	Byte 9	Byte 10	Byte 11
CB0	CB1	Para Out0	Para Out1	Para Out2	Para Out3	ASiCN + ASiOut Slave 1	ASiOut Slaves 2+3	ASiOut Slaves 4+5	ASiOut Slaves 6+7	ASiOut Slave 8+9	ASiOut Slaves 10+11

Key

CB n: control byte n

SB n: status byte n

Para In n: Input parameter, byte n

Para Out n: Output parameter, byte n

ASiSN: AS-i status nibble

ASiCN: AS-i command nibble

ASiIn slave x+y: Input data of the AS-i slaves x and y (one nibble per slave)

ASiOut slave x+y: Output data of the AS-i slaves x and y (one nibble per slave)

5.1.3 22-byte process image

For AS-i networks, in which slave addresses between 12 and 31 are used, the 22-byte process image is required for direct access to the process data of these AS-i slaves.

Input data (KL6201/KL6211 -> PLC)

Parameter data block [▶ 51] (6 bytes)						Process data block [▶ 52] (16 bytes)					
Byte 0	Byte 1	Byte 2	Byte 3	Byte 4	Byte 5	Byte 6	Byte 7	Byte 8	...	Byte 21	
SB0	SB1	ParaIn0	ParaIn1	ParaIn2	ParaIn3	ASiSN + ASiIn Slave 1	ASiIn Slaves 2+3	ASiIn Slaves 4+5	...	ASiIn Slaves 30+31	

Output data (PLC -> KL6201/KL6211)

Parameter data block [▶ 50] (6 bytes)						Process data block [▶ 54] (16 bytes)					
Byte 0	Byte 1	Byte 2	Byte 3	Byte 4	Byte 5	Byte 6	Byte 7	Byte 8	...	Byte 21	
CB0	CB1	ParaOut0	ParaOut1	ParaOut2	ParaOut3	ASiCN + ASiOut Slave 1	ASiOut Slaves 2+3	ASiOut Slaves 4+5	...	ASiOut Slaves 30+31	

Key

CB n: control byte n

SB n: status byte n

Para In n: Input parameter, byte n

Para Out n: Output parameter, byte n

ASiSN: AS-i status nibble

ASiCN: AS-i command nibble

ASiIn slave x+y: Input data of the AS-i slaves x and y (one nibble per slave)

ASiOut slave x+y: Output data of the AS-i slaves x and y (one nibble per slave)

5.1.4 38-byte process image

For AS-i networks, in which slave addresses greater than 32 are used, the 38-byte process image is required for direct access to the process data of these AS-i slaves.

Input data (KL6201/KL6211 -> PLC)

Parameter data block [▶ 51] (6 bytes)						Process data block [▶ 52] (32 bytes)					
Byte 0	Byte 1	Byte 2	Byte 3	Byte 4	Byte 5	Byte 6	Byte 7	Byte 8	...	Byte 37	
SB0	SB1	ParaIn0	ParaIn1	ParaIn2	ParaIn3	ASiSN + ASiIn Slave 1	ASiIn Slaves 2+3	ASiIn Slaves 4+5	...	ASiIn Slaves 62+63	

Output data (PLC -> KL6201/KL6211)

Parameter data block [▶ 50] (6 bytes)						Process data block [▶ 54] (32 bytes)					
Byte 0	Byte 1	Byte 2	Byte 3	Byte 4	Byte 5	Byte 6	Byte 7	Byte 8	...	Byte 37	
CB0	CB1	ParaOut0	ParaOut1	ParaOut2	ParaOut3	ASiCN + ASi Out Slave 1	ASiOut Slaves 2+3	ASiOut Slaves 4+5	...	ASiOut Slaves 62+63	

Key

- CB n: control byte n
- SB n: status byte n
- Para In n: Input parameter, byte n
- Para Out n: Output parameter, byte n
- ASiSN: AS-i status nibble
- ASiCN: AS-i command nibble
- ASiIn slave x+y: Input data of the AS-i slaves x and y (one nibble per slave)
- ASiOut slave x+y: Output data of the AS-i slaves x and y (one nibble per slave)

5.1.5 Description of the data blocks

5.1.5.1 Parameter data block (byte 0 to 5 of the process image)

All AS-i parameters of the KL6201/KL6211 can be accessed via bytes 0 to 5 of the process image interface. The output and input data are then assigned as follows:

Output parameters (PLC -> KL6201/KL6211)

A new task is detected, if one of the bits in the 6-byte parameter data block has changed.

Byte	Bit	Description
0 (CB0)	0 to 5	Parameter number bit 0 to 5
	6	0 _{bin} : Read 1 _{bin} : Write
	7	Always 0 (due to compatibility with register communication)
1 (CB1)	0 to 3	Parameter number bit 6 to 9
	4	Only relevant for write with masked access: 0 _{bin} : Low word (bit 0 to 15) is addressed 1 _{bin} : High word (bit 16 to 31) is addressed
	5	Only relevant for write: 0 _{bin} : Normal 32-bit access 1 _{bin} : Masked 16-bit access with 16-bit mask (only those bits are changed whose mask is set to "1")
	6	0 _{bin} : Parameter access is locked 1 _{bin} : Parameter access:
	7	always 0
2 (ParaOut0)	0 to 7	Read: free Write (normal): Parameter value bits 0 to 7 Write (masked): Parameter value bits 0 to 7
3 (ParaOut1)	0 to 7	Read: free Write (normal): Parameter value bits 8 to 15 Write (masked): Parameter value bits 8 to 15
4 (ParaOut2)	0 to 7	Read: free Write (normal): Parameter value bits 16 to 23 Write (masked): Mask bits 0 to 7
5 (ParaOut3)	0 to 7	Read: free Write (normal): Parameter value bits 24 to 31 Write (masked): Mask bits 8 to 15

Input parameters (KL6201/KL6211 -> PLC)

Byte	Bit	Description
0 (SB0)	0	Only relevant in protected mode: 1 _{bin} : The set configuration and the actual configuration match
	1	1 _{bin} : A power failure has occurred
	2	1 _{bin} : automatic addressing is enabled (protected mode must be active) 0 _{bin} : automatic addressing is locked: <ul style="list-style-type: none"> an AS-i slave with address 0 was found, but no projected AS-i slave is missing or a non-projected AS-i slave was found
	3	1 _{bin} : automatic addressing is available (protected mode must be active and precisely one projected AS-i slave must be missing)
	4	1 _{bin} : an AS-i slave with address "0" was found
	5	reserved for extensions
	6	Diagnostic bit, 1 _{bin} : <ul style="list-style-type: none"> a power failure has occurred in protected mode, the set configuration does not match the actual configuration, or an AS-i slave with the address 0 was found, or automatic address programming in the output data (byte 1, bit 5) was enabled by the controller but is locked at the AS-i master (input data byte 0, bit 2), or
	7	always 0 (for compatibility with register communication)
1 (SB1)	0	0 _{bin} : the AS-i master responds to a read command 1 _{bin} : the AS-i master acknowledges a write command
	1	0 _{bin} : the AS-i master operates in projecting mode 1 _{bin} : the AS-i master operates in protected mode
	2	the AS-i master is set to offline phase (the outputs of the activated AS-i slaves are set to the default value (1 _{bin}), the inputs of the activated AS-i slaves in the controller were also set to the default value (0 _{bin}))
	3	1 _{bin} : the AS-i master operates in normal mode (data exchange phase was reached, AS-i outputs and AS-i inputs have the current values)
	4	Toggle bit, this bit toggles after each executed task
	5	0 _{bin} : Parameter access was completed successfully 1 _{bin} : Error during parameter access
	6	Acknowledges bit 6 of CB1: 0 _{bin} : Process data mode 1 _{bin} : Parameter access
	7	always 0 _{bin}
2 (Paraln0)	0 to 7	Read (without error): Parameter value bits 0 to 7 Write (without error): read parameter value bits 0 to 7 Read or write (with error): Error code bits 0 to 7
3 (Paraln1)	0 to 7	Read (without error): Parameter value bits 8 to 15 Write (without error): read parameter value bits 8 to 15 Read or write (with error): Error code bits 8 to 15
4 (Paraln2)	0 to 7	Read (without error): Parameter value bits 16 to 23 Write (without error): read parameter value bits 16 to 23 Read or write (with error): Error code bits 16 to 23
5 (Paraln3)	0 to 7	Read (without error): Parameter value bits 24 to 31 Write (without error): read parameter value bits 24 to 31 Read or write (with error): Error code bits 24 to 31

5.1.5.2 Process data block (bytes 6 to 33 of the K-bus interface)

In delivery state the output and input data of the KL6201/KL6211 have the following meaning:

Input data (KL6201/KL6211 -> PLC)

Byte	Bit	Description	
6	0	AS-i SN (AS-i status nibble)	
	1		Only relevant in protected mode: 1 _{bin} : Set configuration matches actual configuration
	2		1 _{bin} : A power failure has occurred
	3		the AS-i master is set to offline phase (the outputs of the activated AS-i slaves are set to the default value (1 _{bin}), the inputs of the activated AS-i slaves in the controller were also set to the default value (0 _{bin}))
	4 to 7	1 _{bin} : The AS-i master operates in normal mode (the data exchange phase was reached, AS-i outputs and AS-i inputs have the current values)	
7	0 to 3	AS-i slave 1 (1A): digital inputs, valid flags* or safety flags**	
	4 to 7	AS-i slave 2 (2A): digital inputs, valid flags* or safety flags**	
8	0 to 3	AS-i slave 3 (3A): digital inputs, valid flags* or safety flags**	
	4 to 7	AS-i slave 4 (4A): digital inputs, valid flags* or safety flags**	
9	0 to 3	AS-i slave 5 (5A): digital inputs, valid flags* or safety flags**	
	4 to 7	AS-i slave 6 (6A): digital inputs, valid flags* or safety flags**	
10	0 to 3	AS-i slave 7 (7A): digital inputs, valid flags* or safety flags**	
	4 to 7	AS-i slave 8 (8A): digital inputs, valid flags* or safety flags**	
11	0 to 3	AS-i slave 9 (9A): digital inputs, valid flags* or safety flags**	
	4 to 7	AS-i slave 10 (10A): digital inputs, valid flags* or safety flags**	
12	0 to 3	AS-i slave 11 (11A): digital inputs, valid flags* or safety flags**	
	4 to 7	AS-i slave 12 (12A): digital inputs, valid flags* or safety flags**	
13	0 to 3	AS-i slave 13 (13A): digital inputs, valid flags* or safety flags**	
	4 to 7	AS-i slave 14 (14A): digital inputs, valid flags* or safety flags**	
14	0 to 3	AS-i slave 15 (15A): digital inputs, valid flags* or safety flags**	
	4 to 7	AS-i slave 16 (16A): digital inputs, valid flags* or safety flags**	
15	0 to 3	AS-i slave 17 (17A): digital inputs, valid flags* or safety flags**	
	4 to 7	AS-i slave 18 (18A): digital inputs, valid flags* or safety flags**	
16	0 to 3	AS-i slave 19 (19A): digital inputs, valid flags* or safety flags**	
	4 to 7	AS-i slave 20 (20A): digital inputs, valid flags* or safety flags**	
17	0 to 3	AS-i slave 21 (21A): digital inputs, valid flags* or safety flags**	
	4 to 7	AS-i slave 22 (22A): digital inputs, valid flags* or safety flags**	
18	0 to 3	AS-i slave 23 (23A): digital inputs, valid flags* or safety flags**	
	4 to 7	AS-i slave 24 (24A): digital inputs, valid flags* or safety flags**	
19	0 to 3	AS-i slave 25 (25A): digital inputs, valid flags* or safety flags**	
	4 to 7	AS-i slave 26 (26A): digital inputs, valid flags* or safety flags**	
20	0 to 3	AS-i slave 27 (27A): digital inputs, valid flags* or safety flags**	
	4 to 7	AS-i slave 28 (28A): digital inputs, valid flags* or safety flags**	
21	0 to 3	AS-i slave 29 (29A): digital inputs, valid flags* or safety flags**	
	4 to 7	AS-i slave 30 (30A): digital inputs, valid flags* or safety flags**	
22	0 to 3	AS-i slave 31 (31A): digital inputs, valid flags* or safety flags**	
	4 to 7	Reserved (AS-i slave address 32 is not permitted)	
23	0 to 3	AS-i slave 33 (1B): digital inputs	
	4 to 7	AS-i slave 34 (2B): digital inputs	
24	0 to 3	AS-i slave 35 (3B): digital inputs	
	4 to 7		

Byte	Bit	Description
24	0 to 3	AS-i slave 36 (4B): digital inputs
	4 to 7	AS-i slave 37 (5B): digital inputs
25	0 to 3	AS-i slave 38 (6B): digital inputs
	4 to 7	AS-i slave 39 (7B): digital inputs
26	0 to 3	AS-i slave 40 (8B): digital inputs
	4 to 7	AS-i slave 41 (9B): digital inputs
27	0 to 3	AS-i slave 42 (10B): digital inputs
	4 to 7	AS-i slave 43 (11B): digital inputs
28	0 to 3	AS-i slave 44 (12B): digital inputs
	4 to 7	AS-i slave 45 (13B): digital inputs
29	0 to 3	AS-i slave 46 (14B): digital inputs
	4 to 7	AS-i slave 47 (15B): digital inputs
30	0 to 3	AS-i slave 48 (16B): digital inputs
	4 to 7	AS-i slave 49 (17B): digital inputs
31	0 to 3	AS-i slave 50 (18B): digital inputs
	4 to 7	AS-i slave 51 (19B): digital inputs
32	0 to 3	AS-i slave 52 (20B): digital inputs
	4 to 7	AS-i slave 53 (21B): digital inputs
33	0 to 3	AS-i slave 54 (22B): digital inputs
	4 to 7	AS-i slave 55 (23B): digital inputs
34	0 to 3	AS-i slave 56 (24B): digital inputs
	4 to 7	AS-i slave 57 (25B): digital inputs
35	0 to 3	AS-i slave 58 (26B): digital inputs
	4 to 7	AS-i slave 59 (27B): digital inputs
36	0 to 3	AS-i slave 60 (28B): digital inputs
	4 to 7	AS-i slave 61 (29B): digital inputs
37	0 to 3	AS-i slave 62 (30B): digital inputs
	4 to 7	AS-i slave 63 (31B): digital inputs

Output data (PLC -> KL6201/KL6211)

Byte	Bit	Description
6	0	AS-i CN reserved
	1	(AS-i command nibble) 0 _{bin} : automatic addressing locked. 1 _{bin} : automatic addressing enabled
	2	1 _{bin} : the AS-i master enters the offline phase 0 _{bin} : the AS-i master exits the offline phase. This bit is acknowledged in the input process data (byte 0, bit 2) and in the input parameter interface data (byte 1, bit 2).
	3	Enabling of AS-i data exchange: 1 _{bin} : the current AS-i outputs are sent to the AS-i slaves, and the received AS-i inputs transferred to the controller. 0 _{bin} : the default values (1 _{bin}) are sent to the AS-i slaves, the received AS-i inputs are deleted, and the default values (0 _{bin}) are transferred to the controller. This bit is acknowledged in the input process data (byte 0, bit 3) and in the input parameter interface data (byte 1, bit 3).
	4 to 7	AS-i slave 1 (1A): digital outputs
7	0 to 3	AS-i slave 2 (2A): digital outputs
	4 to 7	AS-i slave 3 (3A): digital outputs
8	0 to 3	AS-i slave 4 (4A): digital outputs
	4 to 7	AS-i slave 5 (5A): digital outputs
9	0 to 3	AS-i slave 6 (6A): digital outputs
	4 to 7	AS-i slave 7 (7A): digital outputs
10	0 to 3	AS-i slave 8 (8A): digital outputs
	4 to 7	AS-i slave 9 (9A): digital outputs
11	0 to 3	AS-i slave 10 (10A): digital outputs
	4 to 7	AS-i slave 11 (11A): digital outputs
12	0 to 3	AS-i slave 12 (12A): digital outputs
	4 to 7	AS-i slave 13 (13A): digital outputs
13	0 to 3	AS-i slave 14 (14A): digital outputs
	4 to 7	AS-i slave 15 (15A): digital outputs
14	0 to 3	AS-i slave 16 (16A): digital outputs
	4 to 7	AS-i slave 17 (17A): digital outputs
15	0 to 3	AS-i slave 18 (18A): digital outputs
	4 to 7	AS-i slave 19 (19A): digital outputs
16	0 to 3	AS-i slave 20 (20A): digital outputs
	4 to 7	AS-i slave 21 (21A): digital outputs
17	0 to 3	AS-i slave 22 (22A): digital outputs
	4 to 7	AS-i slave 23 (23A): digital outputs
18	0 to 3	AS-i slave 24 (24A): digital outputs
	4 to 7	AS-i slave 25 (25A): digital outputs
19	0 to 3	AS-i slave 26 (26A): digital outputs
	4 to 7	AS-i slave 27 (27A): digital outputs
20	0 to 3	AS-i slave 28 (28A): digital outputs
	4 to 7	AS-i slave 29 (29A): digital outputs
21	0 to 3	AS-i slave 30 (30A): digital outputs
	4 to 7	AS-i slave 31 (31A): digital outputs
22	0 to 3	Reserved (AS-i slave address 32 is not permitted)
	4 to 7	AS-i slave 33 (1B): digital outputs

Byte	Bit	Description
23	0 to 3	AS-i slave 34 (2B): digital outputs
	4 to 7	AS-i slave 35 (3B): digital outputs
24	0 to 3	AS-i slave 36 (4B): digital outputs
	4 to 7	AS-i slave 37 (5B): digital outputs
25	0 to 3	AS-i slave 38 (6B): digital outputs
	4 to 7	AS-i slave 39 (7B): digital outputs
26	0 to 3	AS-i slave 40 (8B): digital outputs
	4 to 7	AS-i slave 41 (9B): digital outputs
27	0 to 3	AS-i slave 42 (10B): digital outputs
	4 to 7	AS-i slave 43 (11B): digital outputs
28	0 to 3	AS-i slave 44 (12B): digital outputs
	4 to 7	AS-i slave 45 (13B): digital outputs
29	0 to 3	AS-i slave 46 (14B): digital outputs
	4 to 7	AS-i slave 47 (15B): digital outputs
30	0 to 3	AS-i slave 48 (16B): digital outputs
	4 to 7	AS-i slave 49 (17B): digital outputs
31	0 to 3	AS-i slave 50 (18B): digital outputs
	4 to 7	AS-i slave 51 (19B): digital outputs
32	0 to 3	AS-i slave 52 (20B): digital outputs
	4 to 7	AS-i slave 53 (21B): digital outputs
33	0 to 3	AS-i slave 54 (22B): digital outputs
	4 to 7	AS-i slave 55 (23B): digital outputs
34	0 to 3	AS-i slave 56 (24B): digital outputs
	4 to 7	AS-i slave 57 (25B): digital outputs
35	0 to 3	AS-i slave 58 (26B): digital outputs
	4 to 7	AS-i slave 59 (27B): digital outputs
36	0 to 3	AS-i slave 60 (28B): digital outputs
	4 to 7	AS-i slave 61 (29B): digital outputs
37	0 to 3	AS-i slave 62 (30B): digital outputs
	4 to 7	AS-i slave 63 (31B): digital outputs

5.2 Register overview

The registers are used for parameterization of the terminal and can be read or written via the register communication.

Register	Comment	Default value		R/W	Memory
R0 to R3	reserved	0x0000	0 _{dec}	-	-
R4 [▶ 57]	Register page [▶ 61] selection register	0x0000	0 _{dec}	R/W	
R5 to R7	reserved	0x0000	0 _{dec}	-	-
R8 [▶ 57]	Terminal description	KL6201	0x1839	R	ROM
		KL6211	0x1843		
R9 [▶ 57]	Firmware version	e.g. 0x0100	e.g. 256 _{dec}	R	ROM
R10 [▶ 57]	Multiplex shift register	0x0160	352 _{dec}	R	ROM
R11 [▶ 57]	Signal channels	0x0160	352 _{dec}	R	ROM
R12 [▶ 57]	Minimum data length	0x6060	24672 _{dec}	R	ROM
R13 [▶ 57]	Data structure of the Bus Terminal	0x0001	1 _{dec}	R	ROM
R14	reserved	-	-	-	-
R15 [▶ 57]	Alignment register	-	-	R/W	RAM
R16 to R26	reserved	0x0000	0 _{dec}	-	-
R27 [▶ 57]	Size of the process image	0x0001	1 _{dec}	R/W	SEEROM/ RAM
R28 to R30	reserved	0x0000	0 _{dec}	-	-
R31 [▶ 57]	Code word register	0x0000	0 _{dec}	R/W	RAM
R32 to R63 [▶ 58]	Register for displaying the register pages [▶ 61]	-	-	-	-

5.3 Register description

The registers are used for parameterization of the terminal and can be read or written via the register communication.

R4: Register page selection register

This register is used to specify which register page [► 61] is shown in registers R32 to R63 of the KL6201/ KL6211 (default: 0x0000). The register pages provide access to the AS-i parameters [► 65] of the KL6201/ KL6211.

R8: Terminal description

Register R8 contains the terminal identifier in hexadecimal coding: 0x1839 (6201_{dec})

R9: Firmware version

Register R9 contains the firmware version of the terminal in hexadecimal coding, e. g. 0x0100 (256_{dec}).

R10: Shift register length

0x0160

R11: Number of signal channels

0x0160

R12: Minimum data length

0x6060

R13: Data structure of the Bus Terminal

Register R13 contains the data structure of the Bus Terminal.

R15: Alignment register

R27: Size of the process image

This register specifies the size of the process image of the KL6201/ KL6211.

Value	Process image	Default
0000 _{hex}	6-byte process image	0001 _{hex}
0001 _{hex}	12-byte process image	
0002 _{hex}	22-byte process image	
0003 _{hex}	38-byte process image	
further	reserved	

After changing the process image the Bus Coupler must be restarted for the modified process image to take effect.

R31: Code word register

- If you write values into the user registers without previously having entered the user code word (0x1235) in the code word register, these values are only stored in the RAM registers, but not in the EPROM registers and are therefore lost if the terminal is restarted.
- If you write values into the user registers and have previously entered the user code word (0x1235) in the code word register, these values are stored in the RAM registers and in the EPROM registers and are therefore retained if the terminal is restarted.

The code word is reset if the terminal is restarted.

R32 to R63

In these registers the KL6201/KL6211 shows the AS-i parameters [▶ 65] of the register page [▶ 61] selected with register R4 [▶ 57].

5.4 Examples of Register Communication

The numbering of the bytes in the examples corresponds to the display without word alignment.

5.4.1 Example 1: reading the firmware version from Register 9

Output Data

Byte 0: Control byte	Byte 1: DataOUT1, high byte	Byte 2: DataOUT1, low byte
0x89 (1000 1001 _{bin})	0xXX	0xXX

Explanation:

- Bit 0.7 set means: Register communication switched on.
- Bit 0.6 not set means: reading the register.
- Bits 0.5 to 0.0 specify the register number 9 with 00 1001_{bin}.
- The output data word (byte 1 and byte 2) has no meaning during read access. To change a register, write the required value into the output word.

Input Data (answer of the Bus Terminal)

Byte 0: Status byte	Byte 1: DataIN1, high byte	Byte 2: DataIN1, low byte
0x89	0x33	0x41

Explanation:

- The terminal returns the value of the control byte as a receipt in the status byte.
- The terminal returns the firmware version 0x3341 in the input data word (byte 1 and byte 2). This is to be interpreted as an ASCII code:
 - ASCII code 0x33 represents the digit 3
 - ASCII code 0x41 represents the letter A
 The firmware version is thus 3A.

5.4.2 Example 2: Writing to a user register

i Code word

In normal mode all user registers are read-only with the exception of Register 31. In order to deactivate this write protection you must write the code word (0x1235) into Register 31. If a value other than 0x1235 is written into Register 31, write protection is reactivated. Please note that changes to a register only become effective after restarting the terminal (power-off/power-on).

I. Write the code word (0x1235) into Register 31.

Output Data

Byte 0: Control byte	Byte 1: DataOUT1, high byte	Byte 2: DataOUT1, low byte
0xDF (1101 1111 _{bin})	0x12	0x35

Explanation:

- Bit 0.7 set means: Register communication switched on.
- Bit 0.6 set means: writing to the register.
- Bits 0.5 to 0.0 specify the register number 31 with 01 1111_{bin}.
- The output data word (byte 1 and byte 2) contains the code word (0x1235) for deactivating write protection.

Input Data (answer of the Bus Terminal)

Byte 0: Status byte	Byte 1: DataIN1, high byte	Byte 2: DataIN1, low byte
0x9F (1001 1111 _{bin})	0xXX	0xXX

Explanation:

- The terminal returns a value as a receipt in the status byte that differs only in bit 0.6 from the value of the control byte.
- The input data word (byte 1 and byte 2) is of no importance after the write access. Any values still displayed are invalid!

II. Read Register 31 (check the set code word)

Output Data

Byte 0: Control byte	Byte 1: DataOUT1, high byte	Byte 2: DataOUT1, low byte
0x9F (1001 1111 _{bin})	0xXX	0xXX

Explanation:

- Bit 0.7 set means: Register communication switched on.
- Bit 0.6 not set means: reading the register.
- Bits 0.5 to 0.0 specify the register number 31 with 01 1111_{bin}.
- The output data word (byte 1 and byte 2) has no meaning during read access.

Input Data (answer of the Bus Terminal)

Byte 0: Status byte	Byte 1: DataIN1, high byte	Byte 2: DataIN1, low byte
0x9F (1001 1111 _{bin})	0x12	0x35

Explanation:

- The terminal returns the value of the control byte as a receipt in the status byte.
- The terminal returns the current value of the code word register in the input data word (byte 1 and byte 2).

III. Write to Register 32 (change contents of the feature register)

Output data

Byte 0: Control byte	Byte 1: DataIN1, high byte	Byte 2: DataIN1, low byte
0xE0 (1110 0000 _{bin})	0x00	0x02

Explanation:

- Bit 0.7 set means: Register communication switched on.
- Bit 0.6 set means: writing to the register.
- Bits 0.5 to 0.0 indicate register number 32 with 10 0000_{bin}.
- The output data word (byte 1 and byte 2) contains the new value for the feature register.

⚠ CAUTION**Observe the register description!**

The value of 0x0002 given here is just an example!

The bits of the feature register change the properties of the terminal and have a different meaning, depending on the type of terminal. Refer to the description of the feature register of your terminal (chapter *Register description*) regarding the meaning of the individual bits before changing the values.

Input data (response from the Bus Terminal)

Byte 0: Status byte	Byte 1: DataIN1, high byte	Byte 2: DataIN1, low byte
0xA0 (1010 0000 _{bin})	0xXX	0xXX

Explanation:

- The terminal returns a value as a receipt in the status byte that differs only in bit 0.6 from the value of the control byte.
- The input data word (byte 1 and byte 2) is of no importance after the write access. Any values still displayed are invalid!

IV. Read Register 32 (check changed feature register)**Output Data**

Byte 0: Control byte	Byte 1: DataOUT1, high byte	Byte 2: DataOUT1, low byte
0xA0 (1010 0000 _{bin})	0xXX	0xXX

Explanation:

- Bit 0.7 set means: Register communication switched on.
- Bit 0.6 not set means: reading the register.
- Bits 0.5 to 0.0 indicate register number 32 with 10 0000_{bin}.
- The output data word (byte 1 and byte 2) has no meaning during read access.

Input Data (answer of the Bus Terminal)

Byte 0: Status byte	Byte 1: DataIN1, high byte	Byte 2: DataIN1, low byte
0xA0 (1010 0000 _{bin})	0x00	0x02

Explanation:

- The terminal returns the value of the control byte as a receipt in the status byte.
- The terminal returns the current value of the feature register in the input data word (byte 1 and byte 2).

V. Write Register 31 (reset code word)**Output Data**

Byte 0: Control byte	Byte 1: DataOUT1, high byte	Byte 2: DataOUT1, low byte
0xDF (1101 1111 _{bin})	0x00	0x00

Explanation:

- Bit 0.7 set means: Register communication switched on.
- Bit 0.6 set means: writing to the register.
- Bits 0.5 to 0.0 specify the register number 31 with 01 1111_{bin}.
- The output data word (byte 1 and byte 2) contains 0x0000 for reactivating write protection.

Input Data (answer of the Bus Terminal)

Byte 0: Status byte	Byte 1: DataIN1, high byte	Byte 2: DataIN1, low byte
0x9F (1001 1111 _{bin})	0xXX	0xXX

Explanation:

- The terminal returns a value as a receipt in the status byte that differs only in bit 0.6 from the value of the control byte.
- The input data word (byte 1 and byte 2) is of no importance after the write access. Any values still displayed are invalid!

5.5 Register pages

The [AS-i parameters \[► 65\]](#) of the KL6201/KL6211 can be accessed via register communication or via the [KS2000 \[► 35\]](#) configuration software. The register model of the terminals is used as a basis. The KL6201/ KL6211 has 64 registers (words). Registers 0 to 31 always have the same meaning. The content of registers 32 to 63 is specified via the register page selection register ([R4 \[► 57\]](#)).

A register page is 32 registers (64 bytes) long and can therefore address 16 AS-i parameters.

- In terminal registers 32 to 63, page 0 addresses AS-i parameters 0 to 15
- In terminal registers 32 to 63, page 1 addresses AS-i parameters 16 to 31
- etc.

Assignment of the AS-i parameters to a register page and a terminal register

Reg. page	KL6201/KL6211 registers	AS-i Parameters	Length	Description
0x02	48 to 49	0x28 [▶ 67]	4 bytes	General Information (byte 0 corresponds to bit 0 to 7 of parameter 0x28)
0x04	32 to 47	0x40 to 0x47 [▶ 67]	32 bytes	Projected I/O IDs of all AS-i slaves (byte 0 corresponds to bit 0 to 7 of parameter 0x40)
	48 to 63	0x48 to 0x4F [▶ 69]	32 bytes	Projected ID codes of all AS-i slaves (byte 0 corresponds to bit 0 to 7 of parameter 0x48)
0x05	32 to 47	0x50 to 0x57 [▶ 70]	32 bytes	Activation parameters for the AS-i slaves (byte 0 corresponds to bit 0 to 7 of parameter 0x50)
	48 to 51	0x58 to 0x59 [▶ 72]	8 bytes	List of the AS-i slaves that are projected at the next start (byte 0 corresponds to bit 0 to 7 of parameter 0x58)
0x06	32 to 35	0x60 to 0x61 [▶ 72]	8 bytes	List of I/O IDs of all AS-i slaves to be checked (byte 0 corresponds to bit 0 to 7 of parameter 0x60)
	48 to 51	0x68 to 0x69 [▶ 72]	8 bytes	List of ID codes of all AS-i slaves to be checked (byte 0 corresponds to bit 0 to 7 of parameter 0x68)
0x07	32 to 35	0x70 to 0x71 [▶ 73]	8 bytes	List of extended ID codes 1 of all AS-i slaves to be checked (byte 0 corresponds to bit 0 to 7 of parameter 0x70)
	48 to 51	0x78 to 0x79 [▶ 73]	8 bytes	List of extended ID codes 2 of all AS-i slaves to be checked (byte 0 corresponds to bit 0 to 7 of parameter 0x78)
0x08	32 to 47	0x80 to 0x87 [▶ 73]	32 bytes	Digital inputs of all AS-i slaves (byte 0 corresponds to bit 0 to 7 of parameter 0x80)
0x09	32 to 47	0x90 to 0x97 [▶ 75]	32 bytes	Read I/O IDs of all AS-i slaves (byte 0 corresponds to bit 0 to 7 of parameter 0x90)
	48 to 63	0x98 to 0x9F [▶ 76]	32 bytes	Read ID codes of all AS-i slaves (byte 0 corresponds to bit 0 to 7 of parameter 0x98)
0x0A	32 to 47	0xA0 to 0xA7 [▶ 77]	32 bytes	Read status of all AS-i slaves (byte 0 corresponds to bit 0 to 7 of parameter 0xA0)
	48 to 51	0xA8 to 0xA9 [▶ 79]	8 bytes	List of currently projected AS-i slaves (LPS) (byte 0 corresponds to bit 0 to 7 of parameter 0xA8)
0x0B	32 to 35	0xB0 to 0xB1 [▶ 79]	8 bytes	List of detected AS-i slaves (LDS) (byte 0 corresponds to bit 0 to 7 of parameter 0xB0)
	48 to 51	0xB8 to 0xB9 [▶ 80]	8 bytes	List of activated AS-i slaves (LAS) (byte 0 corresponds to bit 0 to 7 of parameter 0xB8)
0x0C	32 to 35	0xC0 to 0xC1 [▶ 79]	8 bytes	List of slaves that support the extended ID codes (ID codes 1 and 2) (byte 0 corresponds to bit 0 to 7 of parameter 0xC0)
	48 to 49	0xC8 [▶ 79]	4 bytes	List of slaves that support extended addressing (as B slaves with AS-i addresses greater than 32) (byte 0 corresponds to bit 0 to 7 of parameter 0xC8)

Reg. page	KL6201/KL6211 registers	AS-i Parameters	Length	Description
0x0D	32 to 47	0xD0 to 0xD7	32 bytes	Read extended ID codes 1 of all AS-i slaves (byte 0 corresponds to bit 0 to 7 of parameter 0xD0)
	48 to 63	0xD8 to 0xDF [▶ 81]	32 bytes	Read extended ID codes 2 of all AS-i slaves (byte 0 corresponds to bit 0 to 7 of parameter 0xD8)
0x0E	32 to 47	0xE0 to 0xE7 [▶ 83]	32 bytes	Currently projected extended ID codes 1 of all AS-i slaves (byte 0 corresponds to bit 0 to 7 of parameter 0xE0)
	48 to 63	0xE8 to 0xEF [▶ 84]	32 bytes	Currently projected extended ID codes 2 of all AS-i slaves (byte 0 corresponds to bit 0 to 7 of parameter 0xE8)
0x0F	32 to 33	0xF0 [▶ 85]	4 bytes	List of analog slaves (byte 0 corresponds to bit 0 to 7 of parameter 0xF0)
	34 to 35	0xF8 [▶ 85]	4 bytes	List of safety slaves (byte 0 corresponds to bit 0 to 7 of parameter 0xF8)
0x12	32 to 47	0x120 to 0x127 [▶ 87]	32 bytes	Status registers 0 to 15 (byte 0 corresponds to bit 0 to 7 of parameter 0x120)
	48 to 63	0x128 to 0x12F [▶ 87]	32 bytes	Status registers 16 to 31 (byte 0 corresponds to bit 0 to 7 of parameter 0x128)
0x14	32 to 47	0x140 to 0x147 [▶ 87]	32 bytes	Physical fault counter, AS-i slaves 0 to 15 (byte 0 corresponds to bit 0 to 7 of parameter 0x140)
	48 to 63	0x148 to 0x14F [▶ 87]	32 bytes	Physical fault counter, AS-i slaves 16 to 31 (byte 0 corresponds to bit 0 to 7 of parameter 0x148)
0x15	33 to 47	0x150 to 0x157 [▶ 87]	32 bytes	Physical fault counter, AS-i slaves 33 to 47 (byte 0 corresponds to bit 0 to 7 of parameter 0x150)
	48 to 63	0x158 to 0x15F [▶ 87]	32 bytes	Physical fault counter, AS-i slaves 48 to 63 (byte 0 corresponds to bit 0 to 7 of parameter 0x158)
0x16	32 to 47	0x160 to 0x167 [▶ 89]	32 bytes	Timeout counter, AS-i slaves 0 to 15 (byte 0 corresponds to bit 0 to 7 of parameter 0x160)
	48 to 63	0x168 to 0x16F [▶ 89]	32 bytes	Timeout counter, AS-i slaves 16 to 31 (byte 0 corresponds to bit 0 to 7 of parameter 0x168)
0x17	33 to 47	0x170 to 0x177 [▶ 89]	32 bytes	Timeout counter, AS-i slaves 33 to 47 (byte 0 corresponds to bit 0 to 7 of parameter 0x170)
	48 to 63	0x178 to 0x17F [▶ 89]	32 bytes	Timeout counter, AS-i slaves 48 to 63 (byte 0 corresponds to bit 0 to 7 of parameter 0x178)
0x18	32 to 47	0x180 to 0x187 [▶ 90]	32 bytes	Response counter, AS-i slaves 0 to 15 (byte 0 corresponds to bit 0 to 7 of parameter 0x180)
	48 to 63	0x188 to 0x18F [▶ 90]	32 bytes	Response counter, AS-i slaves 16 to 31 (byte 0 corresponds to bit 0 to 7 of parameter 0x188)
0x19	33 to 47	0x190 to 0x197 [▶ 90]	32 bytes	Response counter, AS-i slaves 33 to 47 (byte 0 corresponds to bit 0 to 7 of parameter 0x190)
	48 to 63	0x198 to 0x19F [▶ 90]	32 bytes	Response counter, AS-i slaves 48 to 63 (byte 0 corresponds to bit 0 to 7 of parameter 0x198)

Reg. page	KL6201/KL6211 registers	AS-i Parameters	Length	Description
0x1A	32 to 47	0x1A0 to 0x1A7 [► 91]	32 bytes	Leave data exchange counter, AS-i slaves 0 to 15 (byte 0 corresponds to bit 0 to 7 of parameter 0x1A0)
	48 to 63	0x1A8 to 0x1AF [► 91]	32 bytes	Leave data exchange counter, AS-i slaves 16 to 31 (byte 0 corresponds to bit 0 to 7 of parameter 0x1A8)
0x1B	33 to 47	0x1B0 to 0x1B7 [► 91]	32 bytes	Leave data exchange counter, AS-i slaves 33 to 47 (byte 0 corresponds to bit 0 to 7 of parameter 0x1B0)
	48 to 63	0x1B8 to 0x1BF [► 91]	32 bytes	Leave data exchange counter, AS-i slaves 48 to 63 (byte 0 corresponds to bit 0 to 7 of parameter 0x1B8)
0x1C	32 to 47	0x1C0 to 0x1C7 [► 92]	32 bytes	DataExch failed counter, AS-i slaves 0 to 15 (byte 0 corresponds to bit 0 to 7 of parameter 0x1C0)
	48 to 63	0x1C8 to 0x1CF [► 92]	32 bytes	DataExch failed counter, AS-i slaves 16 to 31 (byte 0 corresponds to bit 0 to 7 of parameter 0x1C8)
0x1D	33 to 47	0x1D0 to 0x1D7 [► 92]	32 bytes	DataExch failed counter, AS-i slaves 33 to 47 (byte 0 corresponds to bit 0 to 7 of parameter 0x1D0)
	48 to 63	0x1D8 to 0x1DF [► 92]	32 bytes	DataExch failed counter, AS-i slaves 48 to 63 (byte 0 corresponds to bit 0 to 7 of parameter 0x1D8)
0x20	40 to 63	0x200 to 0x20F [► 94]	64 bytes	Data of analog slaves 1 to 3 (byte 0 corresponds to bit 0 to 7 of parameter 0x204)
0x21	32 to 63	0x210 to 0x21F [► 94]	64 bytes	Data of analog slaves 4 to 7 (byte 0 corresponds to bit 0 to 7 of parameter 0x210)
... [► 100]
0x27	32 to 63	0x270 to 0x27F [► 94]	64 bytes	Data of analog slaves 30 to 31 (byte 0 corresponds to bit 0 to 7 of parameter 0x270)
0x30	32 to 33	0x300 [► 94]	4 bytes	Cycle times (byte 0 corresponds to bit 0 to 7 of parameter 0x300)
0x31	32 to 33	0x310 [► 94]	4 bytes	Statistics (byte 0 corresponds to bit 0 to 7 of parameter 0x310)
0x32	32 to 63	0x320 to 0x32F [► 95]	64 bytes	Timeout statistics for each AS-i slaves (byte 0 corresponds to bit 0 to 7 of parameter 0x320)
0x34	32 to 63	0x340 to 0x35F [► 96]	64 bytes	Data exchange repeat counter for each AS-i slave (byte 0 corresponds to bit 0 to 7 of parameter 0x340)

5.6 AS-i parameters - overview

All information contained in the AS-i master and the AS-i slaves are described in the following parameters, which are accessible via the cyclic parameter interface (process data mode), via acyclic services (e.g. PROFIBUS DPV1), or via the [KS2000 \[▶ 38\]](#) configuration software.

Overview of the parameters

Parameter numbers	Access	stored in flash	Description
0x20 [▶ 67]	R/W	yes	Width of the process image interface
0x28 [▶ 67]	R	yes	General Information
0x30 [▶ 67]	R/W	no	AS-i string parameters
0x40 to 0x47 [▶ 67]	R/W	yes*	Projected I/O IDs of all AS-i slaves
0x48 to 0x4F [▶ 69]	R/W	yes*	Projected ID codes of all AS-i slaves
0x50 to 0x57 [▶ 70]	R/W	yes**	Activation parameters for the AS-i slaves
0x58 to 0x59 [▶ 72]	R/W	yes*	List of the AS-i slaves that are projected at the next start
0x60 to 0x61 [▶ 72]	R/W	yes*	List of I/O IDs of all AS-i slaves to be checked
0x68 to 0x69 [▶ 72]	R/W	yes*	List of ID codes of all AS-i slaves to be checked
0x70 to 0x71 [▶ 73]	R/W	yes*	List of extended ID codes 1 of all AS-i slaves to be checked
0x78 to 0x79 [▶ 73]	R/W	yes*	List of extended ID codes 2 of all AS-i slaves to be checked
0x80 to 0x87 [▶ 73]	R	no	Data of digital AS-i slaves
0x90 to 0x97 [▶ 75]	R	no	Read I/O IDs of all AS-i slaves
0x98 to 0x9F [▶ 76]	R	no	Read ID codes of all AS-i slaves
0xA0 to 0xA7 [▶ 77]	R	no	Read status of all AS-i slaves
0xA8 and 0xA9 [▶ 79]	R	no	List of currently projected AS-i slaves (LPS)
0xB0 and 0xB1 [▶ 79]	R	no	List of detected AS-i slaves (LDS)
0xB8 and 0xB9 [▶ 80]	R	no	List of activated AS-i slaves (LAS)
0xC0 and 0xC1 [▶ 79]			List of slaves that support the extended ID codes (ID codes 1 and 2)
0xC8 [▶ 79]			List of slaves that support extended addressing (as B slaves with addresses greater than 32)
0xD0 to 0xD7 [▶ 80]	R	no	Read extended ID codes 1 of all AS-i slaves
0xD8 to 0xDF [▶ 81]	R	no	Read extended ID codes 2 of all AS-i slaves
0xE0 to 0xE7 [▶ 83]	R/W	yes*	Currently projected extended ID codes 1 of all AS-i slaves
0xE8 to 0xEF [▶ 84]	R/W	yes*	Currently projected extended ID codes 2 of all AS-i slaves
0xF0 [▶ 85]			List of analog slaves
0xF8 [▶ 85]			List of safety slaves
0x100 [▶ 85]	W	-	AS-i command interface
0x108 [▶ 87]	W	-	General command interface
0x120 to 0x12F [▶ 87]	R	no	Status register
0x140 to 0x15F [▶ 87]	R/W	no	Physical fault counter
0x160 to 0x17F [▶ 89]	R/W	no	Timeout counter
0x180 to 0x19F [▶ 90]	R/W	no	Response counter
0x1A0 to 0x1BF [▶ 91]	R/W	no	Leave DataExch counter
0x1C0 to 0x1DF [▶ 92]	R/W	no	DataExch failed counter
0x200 to 0x27F [▶ 94]	R/W	no	Data of analog AS-i slaves
0x300 [▶ 94]			Cycle times
0x310 [▶ 94]			Statistics
0x320 to 0x32F [▶ 95]			Timeout statistics for each AS-i slave
0x340 to 0x35F [▶ 96]			Data exchange repeat counter for each AS-i slave

i ● ***) Activation parameters for the AS-i slaves**

Activation parameters can only be changed:

- in Config Mode
 - ii Protected Mode, if *Config OK* is not set
-

i ● ****) Adoption of the parameters**

Changes of these parameters are not indicated by the AS-i terminal until the AS-i terminal has passed the activation phase again. This is the case after

- the AS-i terminal has been switched off and on again (power-on/reset) or
 - the AS-i master has been switched offline and online again by setting and resetting the offline flag (checkbox *Offline Phase* in the [Settings \[▶ 40\]](#) dialog of KS2000).
 - Set Protected has been executed by short-circuiting the Set inputs [Set A and Set B \[▶ 30\]](#) or
 - Set Protected has been executed via the [Project all detected slaves] button in the [Settings \[▶ 40\]](#) dialog of ks2000.
-

5.7 AS-i parameter description

Parameter 0x20: Size of the process image

Parameter 0x20 contains the size of the process image. This parameter can be read or written. It is stored in the flash of the KL6201/KL6211 (i.e. it is still available after power off/on).

Parameter	Bit	Description	default
0x20	0 to 15	0 _{dec} : 6-byte interface 1 _{dec} : 12-byte interface 2 _{dec} : 22-byte interface 3 _{dec} : 38-byte interface	1 _{dec}
	16 to 31	reserved	-

After changing the process image the Bus Coupler must be restarted for the modified process image to take effect.

Parameter 0x28: General Information

Parameter 0x28 contains the number of the terminal (6201) and firmware version (this parameter is read only):

Parameter	Bit	Description
0x28	0 to 15	Terminal identifier: 0x1839 (6201 _{dec})
	16 to 31	Firmware version of the terminal

Parameter 0x30: AS-i string parameters

Parameter 0x30 can be used to read or write AS-i strings. The whole AS-i string is transferred in triples. Parameter 0x30 is supported from firmware version BA.

Parameter	Bit	Description	Value
0x30	0 to 7	Byte 0 of data triple m (byte m)	0 to 255
	8 to 15	Byte 1 of data triple m (byte m + 1)	0 to 255
	16 to 23	Byte 2 of data triple m (byte m + 2)	0 to 255
	24 to 31	Byte offset (m = multiple of 3)	m

i String transfer

A string transfer can be used to transfer up to 219 bytes of string data. A string transfer consists of several parameter access operations, each of which transfers 4 bytes. These 4 bytes consist of three bytes (1 triple) of string data and 1 byte for the byte offset.

Parameters 0x40 to 0x47: Projected I/O ID (set configuration)

In protected mode, the I/O ID of the projected AS-i slaves is checked. The currently projected 4-bit I/O IDs of the AS-i slaves are located in parameters 0x40 to 0x47 (these parameters are read/write and are stored in the flash of the AS-i master (i.e. they are still available after power off/on)):

Parameter	Bit	Description
0x40	0 to 3	reserved
	4 to 7	projected I/O ID, AS-i slave 1 (1A)
	8 to 11	projected I/O ID, AS-i slave 2 (2A)
	12 to 15	projected I/O ID, AS-i slave 3 (3A)
	16 to 19	projected I/O ID, AS-i slave 4 (4A)
	20 to 23	projected I/O ID, AS-i slave 5 (5A)
	24 to 27	projected I/O ID, AS-i slave 6 (6A)
	28 to 31	projected I/O ID, AS-i slave 7 (7A)

Parameter	Bit	Description
0x41	0 to 3	projected I/O ID, AS-i slave 8 (8A)
	4 to 7	projected I/O ID, AS-i slave 9 (9A)
	8 to 11	projected I/O ID, AS-i slave 10 (10A)
	12 to 15	projected I/O ID, AS-i slave 11 (11A)
	16 to 19	projected I/O ID, AS-i slave 12 (12A)
	20 to 23	projected I/O ID, AS-i slave 13 (13A)
	24 to 27	projected I/O ID, AS-i slave 14 (14A)
	28 to 31	projected I/O ID, AS-i slave 15 (15A)
0x42	0 to 3	projected I/O ID, AS-i slave 16 (16A)
	4 to 7	projected I/O ID, AS-i slave 17 (17A)
	8 to 11	projected I/O ID, AS-i slave 18 (18A)
	12 to 15	projected I/O ID, AS-i slave 19 (19A)
	16 to 19	projected I/O ID, AS-i slave 20 (20A)
	20 to 23	projected I/O ID, AS-i slave 21 (21A)
	24 to 27	projected I/O ID, AS-i slave 22 (22A)
	28 to 31	projected I/O ID, AS-i slave 23 (23A)
0x43	0 to 3	projected I/O ID, AS-i slave 24 (24A)
	4 to 7	projected I/O ID, AS-i slave 25 (25A)
	8 to 11	projected I/O ID, AS-i slave 26 (26A)
	12 to 15	projected I/O ID, AS-i slave 27 (27A)
	16 to 19	projected I/O ID, AS-i slave 28 (28A)
	20 to 23	projected I/O ID, AS-i slave 29 (29A)
	24 to 27	projected I/O ID, AS-i slave 30 (30A)
	28 to 31	projected I/O ID, AS-i slave 31 (31A)
0x44	0 to 3	Reserved (AS-i slave address 32 is not permitted)
	4 to 7	projected I/O ID, AS-i slave 33 (1B)
	8 to 11	projected I/O ID, AS-i slave 34 (2B)
	12 to 15	projected I/O ID, AS-i slave 35 (3B)
	16 to 19	projected I/O ID, AS-i slave 36 (4B)
	20 to 23	projected I/O ID, AS-i slave 37 (5B)
	24 to 27	projected I/O ID, AS-i slave 38 (6B)
	28 to 31	projected I/O ID, AS-i slave 39 (7B)
0x45	0 to 3	projected I/O ID, AS-i slave 40 (8B)
	4 to 7	projected I/O ID, AS-i slave 41 (9B)
	8 to 11	projected I/O ID, AS-i slave 42 (10B)
	12 to 15	projected I/O ID, AS-i slave 43 (11B)
	16 to 19	projected I/O ID, AS-i slave 44 (12B)
	20 to 23	projected I/O ID, AS-i slave 45 (13B)
	24 to 27	projected I/O ID, AS-i slave 46 (14B)
	28 to 31	projected I/O ID, AS-i slave 47 (15B)
0x46	0 to 3	projected I/O ID, AS-i slave 48 (16B)
	4 to 7	projected I/O ID, AS-i slave 49 (17B)
	8 to 11	projected I/O ID, AS-i slave 50 (18B)
	12 to 15	projected I/O ID, AS-i slave 51 (19B)
	16 to 19	projected I/O ID, AS-i slave 52 (20B)
	20 to 23	projected I/O ID, AS-i slave 53 (21B)
	24 to 27	projected I/O ID, AS-i slave 54 (22B)
	28 to 31	projected I/O ID, AS-i slave 55 (23B)
0x47	0 to 3	projected I/O ID, AS-i slave 56 (24B)
	4 to 7	projected I/O ID, AS-i slave 57 (25B)
	8 to 11	projected I/O ID, AS-i slave 58 (26B)
	12 to 15	projected I/O ID, AS-i slave 59 (27B)
	16 to 19	projected I/O ID, AS-i slave 60 (28B)
	20 to 23	projected I/O ID, AS-i slave 61 (29B)
	24 to 27	projected I/O ID, AS-i slave 62 (30B)
	28 to 31	projected I/O ID, AS-i slave 63 (31B)

Parameters 0x48 to 0x4F: Projected ID code (nominal configuration)

In protected mode, the ID code of the projected AS-i slaves is checked. The projected 4-bit ID codes of the AS-i slaves are located in parameters 0x48 to 0x4F (these parameters are read/write and are stored in the flash of the AS-i master (i.e. they are still available after power off/on)):

Parameter	Bit	Description
0x48	0 to 3	reserved
	4 to 7	projected ID code, AS-i slave 1 (1A)
	8 to 11	projected ID code, AS-i slave 2 (2A)
	12 to 15	projected ID code, AS-i slave 3 (3A)
	16 to 19	projected ID code, AS-i slave 4 (4A)
	20 to 23	projected ID code, AS-i slave 5 (5A)
	24 to 27	projected ID code, AS-i slave 6 (6A)
	28 to 31	projected ID code, AS-i slave 7 (7A)
0x49	0 to 3	projected ID code, AS-i slave 8 (8A)
	4 to 7	projected ID code, AS-i slave 9 (9A)
	8 to 11	projected ID code, AS-i slave 10 (10A)
	12 to 15	projected ID code, AS-i slave 11 (11A)
	16 to 19	projected ID code, AS-i slave 12 (12A)
	20 to 23	projected ID code, AS-i slave 13 (13A)
	24 to 27	projected ID code, AS-i slave 14 (14A)
	28 to 31	projected ID code, AS-i slave 15 (15A)
0x4A	0 to 3	projected ID code, AS-i slave 16 (16A)
	4 to 7	projected ID code, AS-i slave 17 (17A)
	8 to 11	projected ID code, AS-i slave 18 (18A)
	12 to 15	projected ID code, AS-i slave 19 (19A)
	16 to 19	projected ID code, AS-i slave 20 (20A)
	20 to 23	projected ID code, AS-i slave 21 (21A)
	24 to 27	projected ID code, AS-i slave 22 (22A)
	28 to 31	projected ID code, AS-i slave 23 (23A)
0x4B	0 to 3	projected ID code, AS-i slave 24 (24A)
	4 to 7	projected ID code, AS-i slave 25 (25A)
	8 to 11	projected ID code, AS-i slave 26 (26A)
	12 to 15	projected ID code, AS-i slave 27 (27A)
	16 to 19	projected ID code, AS-i slave 28 (28A)
	20 to 23	projected ID code, AS-i slave 29 (29A)
	24 to 27	projected ID code, AS-i slave 30 (30A)
	28 to 31	projected ID code, AS-i slave 31 (31A)
0x4C	0 to 3	Reserved (AS-i slave address 32 is not permitted)
	4 to 7	projected ID code, AS-i slave 33 (1B)
	8 to 11	projected ID code, AS-i slave 34 (2B)
	12 to 15	projected ID code, AS-i slave 35 (3B)
	16 to 19	projected ID code, AS-i slave 36 (4B)
	20 to 23	projected ID code, AS-i slave 37 (5B)
	24 to 27	projected ID code, AS-i slave 38 (6B)
	28 to 31	projected ID code, AS-i slave 39 (7B)
0x4D	0 to 3	projected ID code, AS-i slave 40 (8B)
	4 to 7	projected ID code, AS-i slave 41 (9B)
	8 to 11	projected ID code, AS-i slave 42 (10B)
	12 to 15	projected ID code, AS-i slave 43 (11B)
	16 to 19	projected ID code, AS-i slave 44 (12B)
	20 to 23	projected ID code, AS-i slave 45 (13B)
	24 to 27	projected ID code, AS-i slave 46 (14B)
	28 to 31	projected ID code, AS-i slave 47 (15B)

Parameter	Bit	Description
0x4E	0 to 3	projected ID code, AS-i slave 48 (16B)
	4 to 7	projected ID code, AS-i slave 49 (17B)
	8 to 11	projected ID code, AS-i slave 50 (18B)
	12 to 15	projected ID code, AS-i slave 51 (19B)
	16 to 19	projected ID code, AS-i slave 52 (20B)
	20 to 23	projected ID code, AS-i slave 53 (21B)
	24 to 27	projected ID code, AS-i slave 54 (22B)
	28 to 31	projected ID code, AS-i slave 55 (23B)
0x4F	0 to 3	projected ID code, AS-i slave 56 (24B)
	4 to 7	projected ID code, AS-i slave 57 (25B)
	8 to 11	projected ID code, AS-i slave 58 (26B)
	12 to 15	projected ID code, AS-i slave 59 (27B)
	16 to 19	projected ID code, AS-i slave 60 (28B)
	20 to 23	projected ID code, AS-i slave 61 (29B)
	24 to 27	projected ID code, AS-i slave 62 (30B)
	28 to 31	projected ID code, AS-i slave 63 (31B)

Parameters 0x50 to 0x57: Activation parameters for the AS-i slaves

During the activation phase (or during the inclusion phase - for AS-i slaves that are added later), 4-bit parameter data are sent once to each AS-i slave prior to the first data exchange. The activation parameters can be specified for each AS-i slave via parameters 0x50 to 0x57. The precise definition of the activation parameters for each individual AS-i slave can be found in the documentation associated with the slave.

Parameters 0x50 to 0x57 can be read or written and are stored in the flash of the AS-i master, i.e. they are still available after power off/on of the AS-i master.

Parameter	Bit	Description	default
0x50	0 to 3	reserved	-
	4 to 7	Activation parameter, AS-i slave 1 (1A)	0x0F
	8 to 11	Activation parameter, AS-i slave 2 (2A)	0x0F
	12 to 15	Activation parameter, AS-i slave 3 (3A)	0x0F
	16 to 19	Activation parameter, AS-i slave 4 (4A)	0x0F
	20 to 23	Activation parameter, AS-i slave 5 (5A)	0x0F
	24 to 27	Activation parameter, AS-i slave 6 (6A)	0x0F
	28 to 31	Activation parameter, AS-i slave 7 (7A)	0x0F
0x51	0 to 3	Activation parameter, AS-i slave 8 (8A)	0x0F
	4 to 7	Activation parameter, AS-i slave 9 (9A)	0x0F
	8 to 11	Activation parameter, AS-i slave 10 (10A)	0x0F
	12 to 15	Activation parameter, AS-i slave 11 (11A)	0x0F
	16 to 19	Activation parameter, AS-i slave 12 (12A)	0x0F
	20 to 23	Activation parameter, AS-i slave 13 (13A)	0x0F
	24 to 27	Activation parameter, AS-i slave 14 (14A)	0x0F
	28 to 31	Activation parameter, AS-i slave 15 (15A)	0x0F
0x52	0 to 3	Activation parameter, AS-i slave 16 (16A)	0x0F
	4 to 7	Activation parameter, AS-i slave 17 (17A)	0x0F
	8 to 11	Activation parameter, AS-i slave 18 (18A)	0x0F
	12 to 15	Activation parameter, AS-i slave 19 (19A)	0x0F
	16 to 19	Activation parameter, AS-i slave 20 (20A)	0x0F
	20 to 23	Activation parameter, AS-i slave 21 (21A)	0x0F
	24 to 27	Activation parameter, AS-i slave 22 (22A)	0x0F
	28 to 31	Activation parameter, AS-i slave 23 (23A)	0x0F

Parameter	Bit	Description	default
0x53	0 to 3	Activation parameter, AS-i slave 24 (24A)	0x0F
	4 to 7	Activation parameter, AS-i slave 25 (25A)	0x0F
	8 to 11	Activation parameter, AS-i slave 26 (26A)	0x0F
	12 to 15	Activation parameter, AS-i slave 27 (27A)	0x0F
	16 to 19	Activation parameter, AS-i slave 28 (28A)	0x0F
	20 to 23	Activation parameter, AS-i slave 29 (29A)	0x0F
	24 to 27	Activation parameter, AS-i slave 30 (30A)	0x0F
	28 to 31	Activation parameter, AS-i slave 31 (31A)	0x0F
0x54	0 to 3	Reserved (AS-i slave address 32 is not permitted)	-
	4 to 7	Activation parameter, AS-i slave 33 (1B)	0x0F
	8 to 11	Activation parameter, AS-i slave 34 (2B)	0x0F
	12 to 15	Activation parameter, AS-i slave 35 (3B)	0x0F
	16 to 19	Activation parameter, AS-i slave 36 (4B)	0x0F
	20 to 23	Activation parameter, AS-i slave 37 (5B)	0x0F
	24 to 27	Activation parameter, AS-i slave 38 (6B)	0x0F
	28 to 31	Activation parameter, AS-i slave 39 (7B)	0x0F
0x55	0 to 3	Activation parameter, AS-i slave 40 (8B)	0x0F
	4 to 7	Activation parameter, AS-i slave 41 (9B)	0x0F
	8 to 11	Activation parameter, AS-i slave 42 (10B)	0x0F
	12 to 15	Activation parameter, AS-i slave 43 (11B)	0x0F
	16 to 19	Activation parameter, AS-i slave 44 (12B)	0x0F
	20 to 23	Activation parameter, AS-i slave 45 (13B)	0x0F
	24 to 27	Activation parameter, AS-i slave 46 (14B)	0x0F
	28 to 31	Activation parameter, AS-i slave 47 (15B)	0x0F
0x56	0 to 3	Activation parameter, AS-i slave 48 (16B)	0x0F
	4 to 7	Activation parameter, AS-i slave 49 (17B)	0x0F
	8 to 11	Activation parameter, AS-i slave 50 (18B)	0x0F
	12 to 15	Activation parameter, AS-i slave 51 (19B)	0x0F
	16 to 19	Activation parameter, AS-i slave 52 (20B)	0x0F
	20 to 23	Activation parameter, AS-i slave 53 (21B)	0x0F
	24 to 27	Activation parameter, AS-i slave 54 (22B)	0x0F
	28 to 31	Activation parameter, AS-i slave 55 (23B)	0x0F
0x57	0 to 3	Activation parameter, AS-i slave 56 (24B)	0x0F
	4 to 7	Activation parameter, AS-i slave 57 (25B)	0x0F
	8 to 11	Activation parameter, AS-i slave 58 (26B)	0x0F
	12 to 15	Activation parameter, AS-i slave 59 (27B)	0x0F
	16-19	Activation parameter, AS-i slave 60 (28B)	0x0F
	20 to 23	Activation parameter, AS-i slave 61 (29B)	0x0F
	24 to 27	Activation parameter, AS-i slave 62 (30B)	0x0F
	28 to 31	Activation parameter, AS-i slave 63 (31B)	0x0F

Parameters 0x58 and 0x59: List of the AS-i slaves that are projected at the next start

This list contains the AS-i slaves that are projected during the next start (transition from offline phase to detection phase). For each AS-i slave, parameters 0x58 to 0x59 contain a bit that indicates whether the associated AS-i slave is projected (this parameter is read/write and is stored in the flash of the AS-i master (i.e. it is still available after power off/on)):

Parameter	Bit	Description
0x58	0	reserved
	1	0 _{bin} : AS-i slave 1 (1A) is not projected 1 _{bin} : AS-i slave 1 (1A) is projected

	31	0 _{bin} : AS-i slave 31 (31A) is not projected 1 _{bin} : AS-i slave 31 (31A) is projected
0x59	0	reserved
	1	0 _{bin} : AS-i slave 33 (1B) is not projected 1 _{bin} : AS-i slave 33 (1B) is projected

	31	0 _{bin} : AS-i slave 63 (31B) is not projected 1 _{bin} : AS-i slave 63 (31B) is projected

Parameters 0x60 and 0x61: Verification of the I/O IDs of the AS-i slaves

This list defines whether the I/O IDs should be checked in protected mode (projecting active). For each AS-i slave, parameters 0x60 and 0x61 contain a bit that indicates whether the I/O ID of the associated AS-i slave should be checked (this parameter is read/write and is stored in the flash of the AS-i master (i.e. it is still available after power off/on)):

Parameter	Bit	Description
0x60	0	reserved
	1	0 _{bin} : I/O ID of AS-i slave 1 (1A) is not checked in protected mode (0) 1 _{bin} : I/O ID of AS-i slave 1 (1A) is checked in protected mode (1)

	31	0 _{bin} : I/O ID of AS-i slave 31 (31A) is not checked in protected mode (0) 1 _{bin} : I/O ID of AS-i slave 31 (31A) is checked in protected mode (1)
0x61	0	reserved
	1	0 _{bin} : I/O ID of AS-i slave 33 (1B) is not checked in protected mode (0) 1 _{bin} : I/O ID of AS-i slave 33 (1B) is checked in protected mode (1)

	31	0 _{bin} : I/O ID of AS-i slave 63 (31B) is not checked in protected mode (0) 1 _{bin} : I/O ID of AS-i slave 63 (31B) is checked in protected mode (1)

Parameters 0x68 and 0x69: Verification of the ID codes of the AS-i slaves

This list defines whether the ID codes should be checked in protected mode (projecting active). For each AS-i slave, parameters 0x68 and 0x69 contain a bit that indicates whether the ID code of the associated AS-i slave should be checked (this parameter is read/write and is stored in the flash of the AS-i master (i.e. it is still available after power off/on)):

Parameter	Bit	Description
0x68	0	reserved
	1	0 _{bin} : ID code of AS-i slave 1 (1A) is not checked in protected mode 1 _{bin} : ID code of AS-i slave 1 (1A) is checked in protected mode

	31	0 _{bin} : ID code of AS-i slave 31 (31A) is not checked in protected mode 1 _{bin} : ID code of AS-i slave 31 (31A) is checked in protected mode
0x69	0	reserved
	1	0 _{bin} : ID code of AS-i slave 33 (1B) is not checked in protected mode 1 _{bin} : ID code of AS-i slave 33 (1B) is checked in protected mode

	31	0 _{bin} : ID code of AS-i slave 63 (31B) is not checked in protected mode 1 _{bin} : ID code of AS-i slave 63 (31B) is checked in protected mode

Parameters 0x70 and 0x71: Verification of the extended ID codes 1 of the AS-i slaves

This list defines whether the extended ID codes 1 should be checked in protected mode (projecting active). For each AS-i slave, parameters 0x70 and 0x71 contain a bit that indicates whether the extended ID code 2 of the associated AS-i slave should be checked (this parameter is read/write and is stored in the flash of the AS-i master (i.e. it is still available after power off/on)):

Parameter	Bit	Description
0x70	0	reserved
	1	0 _{bin} : Extended ID code 1 of AS-i slave 1 (1A) is not checked in protected mode 1 _{bin} : Extended ID code 1 of AS-i slave 1 (1A) is checked in protected mode

	31	0 _{bin} : Extended ID code 1 of AS-i slave 31 (31A) is not checked in protected mode 1 _{bin} : Extended ID code 1 of AS-i slave 31 (31A) is checked in protected mode
0x71	0	reserved
	1	0 _{bin} : Extended ID code 1 of AS-i slave 33 (1B) is not checked in protected mode 1 _{bin} : Extended ID code 1 of AS-i slave 33 (1B) is checked in protected mode

	31	0 _{bin} : Extended ID code 1 of AS-i slave 63 (31B) is not checked in protected mode 1 _{bin} : Extended ID code 1 of AS-i slave 63 (31B) is checked in protected mode

Parameters 0x78 and 0x79: Verification of the extended ID codes 2 of the AS-i slaves

This list defines whether the ID codes should be checked in protected mode (projecting active). For each AS-i slave, parameters 0x78 and 0x79 contain a bit that indicates whether the extended ID code 2 of the associated AS-i slave should be checked (this parameter is read/write and is stored in the flash of the AS-i master (i.e. it is still available after power off/on)):

Parameter	Bit	Description
0x78	0	reserved
	1	0 _{bin} : Extended ID code 2 of AS-i slave 1 (1A) is not checked in protected mode 1 _{bin} : Extended ID code 2 of AS-i slave 1 (1A) is checked in protected mode

	31	0 _{bin} : Extended ID code 2 of AS-i slave 31 (31A) is not checked in protected mode 1 _{bin} : Extended ID code 2 of AS-i slave 31 (31A) is checked in protected mode
0x79	0	reserved
	1	0 _{bin} : Extended ID code 2 of AS-i slave 33 (1B) is not checked in protected mode 1 _{bin} : Extended ID code 2 of AS-i slave 33 (1B) is checked in protected mode

	31	0 _{bin} : Extended ID code 2 of AS-i slave 63 (31B) is not checked in protected mode 1 _{bin} : Extended ID code 2 of AS-i slave 63 (31B) is checked in protected mode

Parameters 0x80 to 0x87: Digital inputs and outputs

The digital process data of the AS-i slaves can also be read or written via the parameters. For the 12-byte KBus interface, digital outputs can only be written for the AS-i slaves from address 12 (the digital outputs of AS-i slaves 1-11 are overwritten by the process data), for the 22-byte KBus interface from address 33 (the digital outputs of AS-i slaves 1-31 are overwritten by the process data), and for the 30-byte KBus interface from address 48 (the digital outputs of AS-i slaves 1-47 are overwritten by the process data). The digital inputs (read access) or digital outputs (write access) of all AS-i slaves are stored in parameters 0x80 to 0x87 (these parameters are read/write (read for inputs, write for outputs)):

Parameter	Bit	Description
0x80	0 to 3	Digital inputs (read) or digital outputs (write), AS-i slave 0
	4 to 7	Digital inputs (read) or digital outputs (write), AS-i slave 1 (1A)
	8 to 11	Digital inputs (read) or digital outputs (write), AS-i slave 2 (2A)
	12 to 15	Digital inputs (read) or digital outputs (write), AS-i slave 3 (3A)
	16-19	Digital inputs (read) or digital outputs (write), AS-i slave 4 (4A)
	20 to 23	Digital inputs (read) or digital outputs (write), AS-i slave 5 (5A)
	24 to 27	Digital inputs (read) or digital outputs (write), AS-i slave 6 (6A)
	28 to 31	Digital inputs (read) or digital outputs (write), AS-i slave 7 (7A)

Parameter	Bit	Description
0x81	0 to 3	Digital inputs (read) or digital outputs (write), AS-i slave 8 (8A)
	4 to 7	Digital inputs (read) or digital outputs (write), AS-i slave 9 (9A)
	8 to 11	Digital inputs (read) or digital outputs (write), AS-i slave 10 (10A)
	12 to 15	Digital inputs (read) or digital outputs (write), AS-i slave 11 (11A)
	16-19	Digital inputs (read) or digital outputs (write), AS-i slave 12 (12A)
	20 to 23	Digital inputs (read) or digital outputs (write), AS-i slave 13 (13A)
	24 to 27	Digital inputs (read) or digital outputs (write), AS-i slave 14 (14A)
	28 to 31	Digital inputs (read) or digital outputs (write), AS-i slave 15 (15A)
0x82	0 to 3	Digital inputs (read) or digital outputs (write), AS-i slave 16 (16A)
	4 to 7	Digital inputs (read) or digital outputs (write), AS-i slave 17 (17A)
	8 to 11	Digital inputs (read) or digital outputs (write), AS-i slave 18 (18A)
	12 to 15	Digital inputs (read) or digital outputs (write), AS-i slave 19 (19A)
	16-19	Digital inputs (read) or digital outputs (write), AS-i slave 20 (20A)
	20 to 23	Digital inputs (read) or digital outputs (write), AS-i slave 21 (21A)
	24 to 27	Digital inputs (read) or digital outputs (write), AS-i slave 22 (22A)
	28 to 31	Digital inputs (read) or digital outputs (write), AS-i slave 23 (23A)
0x83	0 to 3	Digital inputs (read) or digital outputs (write), AS-i slave 24 (24A)
	4 to 7	Digital inputs (read) or digital outputs (write), AS-i slave 25 (25A)
	8 to 11	Digital inputs (read) or digital outputs (write), AS-i slave 26 (26A)
	12 to 15	Digital inputs (read) or digital outputs (write), AS-i slave 27 (27A)
	16-19	Digital inputs (read) or digital outputs (write), AS-i slave 28 (28A)
	20 to 23	Digital inputs (read) or digital outputs (write), AS-i slave 29 (29A)
	24 to 27	Digital inputs (read) or digital outputs (write), AS-i slave 30 (30A)
	28 to 31	Digital inputs (read) or digital outputs (write), AS-i slave 31 (31A)
0x84	0 to 3	Reserved (AS-i slave address 32 is not permitted)
	4 to 7	Digital inputs (read) or digital outputs (write), AS-i slave 33 (1B)
	8 to 11	Digital inputs (read) or digital outputs (write), AS-i slave 34 (2B)
	12 to 15	Digital inputs (read) or digital outputs (write), AS-i slave 35 (3B)
	16 to 19	Digital inputs (read) or digital outputs (write), AS-i slave 36 (4B)
	20 to 23	Digital inputs (read) or digital outputs (write), AS-i slave 37 (5B)
	24 to 27	Digital inputs (read) or digital outputs (write), AS-i slave 38 (6B)
	28 to 31	Digital inputs (read) or digital outputs (write), AS-i slave 39 (7B)
0x85	0 to 3	Digital inputs (read) or digital outputs (write), AS-i slave 40 (8B)
	4 to 7	Digital inputs (read) or digital outputs (write), AS-i slave 41 (9B)
	8 to 11	Digital inputs (read) or digital outputs (write), AS-i slave 42 (10B)
	12 to 15	Digital inputs (read) or digital outputs (write), AS-i slave 43 (11B)
	16 to 19	Digital inputs (read) or digital outputs (write), AS-i slave 44 (12B)
	20 to 23	Digital inputs (read) or digital outputs (write), AS-i slave 45 (13B)
	24 to 27	Digital inputs (read) or digital outputs (write), AS-i slave 46 (14B)
	28 to 31	Digital inputs (read) or digital outputs (write), AS-i slave 47 (15B)
0x86	0 to 3	Digital inputs (read) or digital outputs (write), AS-i slave 48 (16B)
	4 to 7	Digital inputs (read) or digital outputs (write), AS-i slave 49 (17B)
	8 to 11	Digital inputs (read) or digital outputs (write), AS-i slave 50 (18B)
	12 to 15	Digital inputs (read) or digital outputs (write), AS-i slave 51 (19B)
	16 to 19	Digital inputs (read) or digital outputs (write), AS-i slave 52 (20B)
	20 to 23	Digital inputs (read) or digital outputs (write), AS-i slave 53 (21B)
	24 to 27	Digital inputs (read) or digital outputs (write), AS-i slave 54 (22B)
	28 to 31	Digital inputs (read) or digital outputs (write), AS-i slave 55 (23B)
0x87	0 to 3	Digital inputs (read) or digital outputs (write), AS-i slave 56 (24B)
	4 to 7	Digital inputs (read) or digital outputs (write), AS-i slave 57 (25B)
	8 to 11	Digital inputs (read) or digital outputs (write), AS-i slave 58 (26B)
	12 to 15	Digital inputs (read) or digital outputs (write), AS-i slave 59 (27B)
	16 to 19	Digital inputs (read) or digital outputs (write), AS-i slave 60 (28B)
	20 to 23	Digital inputs (read) or digital outputs (write), AS-i slave 61 (29B)
	24 to 27	Digital inputs (read) or digital outputs (write), AS-i slave 62 (30B)
	28 to 31	Digital inputs (read) or digital outputs (write), AS-i slave 63 (31B)

Parameters 0x90 to 0x97: Read I/O ID (actual configuration)

Each AS-i slave has a 4-bit I/O ID, which is stored in parameters 0x90 to 0x97 (these parameters are read only):

Parameter	Bit	Description
0x90	0 to 3	read I/O ID, AS-i slave 0
	4 to 7	read I/O ID, AS-i slave 1 (1A)
	8 to 11	read I/O ID, AS-i slave 2 (2A)
	12 to 15	read I/O ID, AS-i slave 3 (3A)
	16 to 19	read I/O ID, AS-i slave 4 (4A)
	20 to 23	read I/O ID, AS-i slave 5 (5A)
	24 to 27	read I/O ID, AS-i slave 6 (6A)
	28 to 31	read I/O ID, AS-i slave 7 (7A)
0x91	0 to 3	read I/O ID, AS-i slave 8 (8A)
	4 to 7	read I/O ID, AS-i slave 9 (9A)
	8 to 11	read I/O ID, AS-i slave 10 (10A)
	12 to 15	read I/O ID, AS-i slave 11 (11A)
	16 to 19	read I/O ID, AS-i slave 12 (12A)
	20 to 23	read I/O ID, AS-i slave 13 (13A)
	24 to 27	read I/O ID, AS-i slave 14 (14A)
	28 to 31	read I/O ID, AS-i slave 15 (15A)
0x92	0 to 3	read I/O ID, AS-i slave 16 (16A)
	4 to 7	read I/O ID, AS-i slave 17 (17A)
	8 to 11	read I/O ID, AS-i slave 18 (18A)
	12 to 15	read I/O ID, AS-i slave 19 (19A)
	16 to 19	read I/O ID, AS-i slave 20 (20A)
	20 to 23	read I/O ID, AS-i slave 21 (21A)
	24 to 27	read I/O ID, AS-i slave 22 (22A)
	28 to 31	read I/O ID, AS-i slave 23 (23A)
0x93	0 to 3	read I/O ID, AS-i slave 24 (24A)
	4 to 7	read I/O ID, AS-i slave 25 (25A)
	8 to 11	read I/O ID, AS-i slave 26 (26A)
	12 to 15	read I/O ID, AS-i slave 27 (27A)
	16 to 19	read I/O ID, AS-i slave 28 (28A)
	20 to 23	read I/O ID, AS-i slave 29 (29A)
	24 to 27	read I/O ID, AS-i slave 30 (30A)
	28 to 31	read I/O ID, AS-i slave 31 (31A)
0x94	0 to 3	Reserved (AS-i slave address 32 is not permitted)
	4 to 7	read I/O ID, AS-i slave 33 (1B)
	8 to 11	read I/O ID, AS-i slave 34 (2B)
	12 to 15	read I/O ID, AS-i slave 35 (3B)
	16 to 19	read I/O ID, AS-i slave 36 (4B)
	20 to 23	read I/O ID, AS-i slave 37 (5B)
	24 to 27	read I/O ID, AS-i slave 38 (6B)
	28 to 31	read I/O ID, AS-i slave 39 (7B)
0x95	0 to 3	read I/O ID, AS-i slave 40 (8B)
	4 to 7	read I/O ID, AS-i slave 41 (9B)
	8 to 11	read I/O ID, AS-i slave 42 (10B)
	12 to 15	read I/O ID, AS-i slave 43 (11B)
	16 to 19	read I/O ID, AS-i slave 44 (12B)
	20 to 23	read I/O ID, AS-i slave 45 (13B)
	24 to 27	read I/O ID, AS-i slave 46 (14B)
	28 to 31	read I/O ID, AS-i slave 47 (15B)

Parameter	Bit	Description
0x96	0 to 3	read I/O ID, AS-i slave 48 (16B)
	4 to 7	read I/O ID, AS-i slave 49 (17B)
	8 to 11	read I/O ID, AS-i slave 50 (18B)
	12 to 15	read I/O ID, AS-i slave 51 (19B)
	16 to 19	read I/O ID, AS-i slave 52 (20B)
	20 to 23	read I/O ID, AS-i slave 53 (21B)
	24 to 27	read I/O ID, AS-i slave 54 (22B)
	28 to 31	read I/O ID, AS-i slave 55 (23B)
0x97	0 to 3	read I/O ID, AS-i slave 56 (24B)
	4 to 7	read I/O ID, AS-i slave 57 (25B)
	8 to 11	read I/O ID, AS-i slave 58 (26B)
	12 to 15	read I/O ID, AS-i slave 59 (27B)
	16 to 19	read I/O ID, AS-i slave 60 (28B)
	20 to 23	read I/O ID, AS-i slave 61 (29B)
	24 to 27	read I/O ID, AS-i slave 62 (30B)
	28 to 31	read I/O ID, AS-i slave 63 (31B)

Parameters 0x98 to 0x9F: Read standard ID code (actual configuration)

Each AS-i slave has a 4-bit standard ID code, which is stored in parameters 0x98 to 0x9F (these parameters are read only):

Parameter	Bit	Description
0x98	0 to 3	read ID code, AS-i slave 0
	4 to 7	read ID code, AS-i slave 1 (1A)
	8 to 11	read ID code, AS-i slave 2 (2A)
	12 to 15	read ID code, AS-i slave 3 (3A)
	16 to 19	read ID code, AS-i slave 4 (4A)
	20 to 23	read ID code, AS-i slave 5 (5A)
	24 to 27	read ID code, AS-i slave 6 (6A)
	28 to 31	read ID code, AS-i slave 7 (7A)
0x99	0 to 3	read ID code, AS-i slave 8 (8A)
	4 to 7	read ID code, AS-i slave 9 (9A)
	8 to 11	read ID code, AS-i slave 10 (10A)
	12 to 15	read ID code, AS-i slave 11 (11A)
	16 to 19	read ID code, AS-i slave 12 (12A)
	20 to 23	read ID code, AS-i slave 13 (13A)
	24 to 27	read ID code, AS-i slave 14 (14A)
	28 to 31	read ID code, AS-i slave 15 (15A)
0x9A	0 to 3	read ID code, AS-i slave 16 (16A)
	4 to 7	read ID code, AS-i slave 17 (17A)
	8 to 11	read ID code, AS-i slave 18 (18A)
	12 to 15	read ID code, AS-i slave 19 (19A)
	16 to 19	read ID code, AS-i slave 20 (20A)
	20 to 23	read ID code, AS-i slave 21 (21A)
	24 to 27	read ID code, AS-i slave 22 (22A)
	28 to 31	read ID code, AS-i slave 23 (23A)
0x9B	0 to 3	read ID code, AS-i slave 24 (24A)
	4 to 7	read ID code, AS-i slave 25 (25A)
	8 to 11	read ID code, AS-i slave 26 (26A)
	12 to 15	read ID code, AS-i slave 27 (27A)
	16 to 19	read ID code, AS-i slave 28 (28A)
	20 to 23	read ID code, AS-i slave 29 (29A)
	24 to 27	read ID code, AS-i slave 30 (30A)
	28 to 31	read ID code, AS-i slave 31 (31A)

Parameter	Bit	Description
0x9C	0 to 3	Reserved (AS-i slave address 32 is not permitted)
	4 to 7	read ID code, AS-i slave 33 (1B)
	8 to 11	read ID code, AS-i slave 34 (2B)
	12 to 15	read ID code, AS-i slave 35 (3B)
	16 to 19	read ID code, AS-i slave 36 (4B)
	20 to 23	read ID code, AS-i slave 37 (5B)
	24 to 27	read ID code, AS-i slave 38 (6B)
	28 to 31	read ID code, AS-i slave 39 (7B)
0x9D	0 to 3	read ID code, AS-i slave 40 (8B)
	4 to 7	read ID code, AS-i slave 41 (9B)
	8 to 11	read ID code, AS-i slave 42 (10B)
	12 to 15	read ID code, AS-i slave 43 (11B)
	16 to 19	read ID code, AS-i slave 44 (12B)
	20 to 23	read ID code, AS-i slave 45 (13B)
	24 to 27	read ID code, AS-i slave 46 (14B)
	28 to 31	read ID code, AS-i slave 47 (15B)
0x9E	0 to 3	read ID code, AS-i slave 48 (16B)
	4 to 7	read ID code, AS-i slave 49 (17B)
	8 to 11	read ID code, AS-i slave 50 (18B)
	12 to 15	read ID code, AS-i slave 51 (19B)
	16 to 19	read ID code, AS-i slave 52 (20B)
	20 to 23	read ID code, AS-i slave 53 (21B)
	24 to 27	read ID code, AS-i slave 54 (22B)
	28 to 31	read ID code, AS-i slave 55 (23B)
0x9F	0 to 3	read ID code, AS-i slave 56 (24B)
	4 to 7	read ID code, AS-i slave 57 (25B)
	8 to 11	read ID code, AS-i slave 58 (26B)
	12 to 15	read ID code, AS-i slave 59 (27B)
	16 to 19	read ID code, AS-i slave 60 (28B)
	20 to 23	read ID code, AS-i slave 61 (29B)
	24 to 27	read ID code, AS-i slave 62 (30B)
	28 to 31	read ID code, AS-i slave 63 (31B)

Parameters 0xA0 to 0xA7: read status

Each AS-i slave has a 4-bit status, which is stored in parameters 0xA0 to 0xA7 (these parameters are read only):

Parameter	Bit	Description
0xA0	0 to 3	Status, AS-i slave 0
	4 to 7	status, AS-i slave 1 (1A)
	8 to 11	status, AS-i slave 2 (2A)
	12 to 15	status, AS-i slave 3 (3A)
	16 to 19	status, AS-i slave 4 (4A)
	20 to 23	status, AS-i slave 5 (5A)
	24 to 27	status, AS-i slave 6 (6A)
	28 to 31	status, AS-i slave 7 (7A)
0xA1	0 to 3	status, AS-i slave 8 (8A)
	4 to 7	status, AS-i slave 9 (9A)
	8 to 11	status, AS-i slave 10 (10A)
	12 to 15	status, AS-i slave 11 (11A)
	16 to 19	status, AS-i slave 12 (12A)
	20 to 23	status, AS-i slave 13 (13A)
	24 to 27	status, AS-i slave 14 (14A)
	28 to 31	status, AS-i slave 15 (15A)

Parameter	Bit	Description
0xA2	0 to 3	status, AS-i slave 16 (16A)
	4 to 7	status, AS-i slave 17 (17A)
	8 to 11	status, AS-i slave 18 (18A)
	12 to 15	status, AS-i slave 19 (19A)
	16 to 19	status, AS-i slave 20 (20A)
	20 to 23	status, AS-i slave 21 (21A)
	24 to 27	status, AS-i slave 22 (22A)
	28 to 31	status, AS-i slave 23 (23A)
0xA3	0 to 3	status, AS-i slave 24 (24A)
	4 to 7	status, AS-i slave 25 (25A)
	8 to 11	status, AS-i slave 26 (26A)
	12 to 15	status, AS-i slave 27 (27A)
	16 to 19	status, AS-i slave 28 (28A)
	20 to 23	status, AS-i slave 29 (29A)
	24 to 27	status, AS-i slave 30 (30A)
	28 to 31	status, AS-i slave 31 (31A)
0xA4	0 to 3	Reserved (AS-i slave address 32 is not permitted)
	4 to 7	Status, AS-i slave 33 (1B)
	8 to 11	Status, AS-i slave 34 (2B)
	12 to 15	Status, AS-i slave 35 (3B)
	16 to 19	Status, AS-i slave 36 (4B)
	20 to 23	Status, AS-i slave 37 (5B)
	24 to 27	Status, AS-i slave 38 (6B)
	28 to 31	Status, AS-i slave 39 (7B)
0xA5	0 to 3	Status, AS-i slave 40 (8B)
	4 to 7	Status, AS-i slave 41 (9B)
	8 to 11	Status, AS-i slave 42 (10B)
	12 to 15	Status, AS-i slave 43 (11B)
	16 to 19	Status, AS-i slave 44 (12B)
	20 to 23	Status, AS-i slave 45 (13B)
	24 to 27	Status, AS-i slave 46 (14B)
	28 to 31	Status, AS-i slave 47 (15B)
0xA6	0 to 3	Status, AS-i slave 48 (16B)
	4 to 7	Status, AS-i slave 49 (17B)
	8 to 11	Status, AS-i slave 50 (18B)
	12 to 15	Status, AS-i slave 51 (19B)
	16 to 19	Status, AS-i slave 52 (20B)
	20 to 23	Status, AS-i slave 53 (21B)
	24 to 27	Status, AS-i slave 54 (22B)
	28 to 31	Status, AS-i slave 55 (23B)
0xA7	0 to 3	Status, AS-i slave 56 (24B)
	4 to 7	Status, AS-i slave 57 (25B)
	8 to 11	Status, AS-i slave 58 (26B)
	12 to 15	Status, AS-i slave 59 (27B)
	16 to 19	Status, AS-i slave 60 (28B)
	20 to 23	Status, AS-i slave 61 (29B)
	24 to 27	Status, AS-i slave 62 (30B)
	28 to 31	Status, AS-i slave 63 (31B)

Parameters 0xA8 and 0xA9: List of currently projected AS-i slaves (LPS)

This list contains the currently projected AS-i slaves. As soon as at least one AS-i slave from this list is projected, the AS-i master is in protected mode. This list is only updated during the transition from the offline phase to the detection phase, with the list of the AS-i slaves projected at the next start being read. For each AS-i slave, parameters 0xA8 and 0xA9 contain a bit that indicates whether the respective AS-i slave is projected (this parameter is read only):

Parameter	Bit	Description
0xA8	0	reserved
	1	0 _{bin} : AS-i slave 1 (1A) is not projected 1 _{bin} : AS-i slave 1 (1A) is projected

	31	0 _{bin} : AS-i slave 31 (31A) is not projected 1 _{bin} : AS-i slave 31 (31A) is projected
0xA9	0	reserved
	1	0 _{bin} : AS-i slave 33 (1B) is not projected 1 _{bin} : AS-i slave 33 (1B) is projected

	31	0 _{bin} : AS-i slave 63 (31B) is not projected 1 _{bin} : AS-i slave 63 (31B) is projected

Parameters 0xB0 and 0xB1: List of currently detected AS-i slaves (LDS)

This list contains the AS-i slaves that are currently detected at the bus. For each AS-i slave, parameters 0xB0 and 0xB1 contain a bit that indicates whether the respective AS-i slave was detected (this parameter is read only):

Parameter	Bit	Description
0xB0	0	reserved
	1	0 _{bin} : AS-i slave 1 (1A) was not detected 1 _{bin} : AS-i slave 1 (1A) was detected

	31	0 _{bin} : AS-i slave 31 (31A) was not detected 1 _{bin} : AS-i slave 31 (31A) was detected
0xB1	0	reserved
	1	0 _{bin} : AS-i slave 33 (1B) was not detected 1 _{bin} : AS-i slave 33 (1B) was detected

	31	0 _{bin} : AS-i slave 63 (31B) was not detected 1 _{bin} : AS-i slave 63 (31B) was detected

Parameters 0xC0 and 0xC1: List of slaves that support the extended ID codes (ID codes 1 and 2)

Parameter	Bit	Description
0xC0	0	Slave 0 supports extended ID codes
	1	Slave 1 (1A) supports extended ID codes

	31	Slave 31 (31A) supports extended ID codes
0xC1	0	free
	1	Slave 1 (1A) supports extended ID codes

	31	Slave 31 (31A) supports extended ID codes

Parameter 0xC8: List of slaves that support extended addressing (as B slaves with addresses greater than 32)

Parameter	Bit	Description
0xC8	0	Slave 0 supports extended addressing
	1	Slave 1 (1A) supports extended addressing

	31	Slave 31 (31A) supports extended addressing

Parameters 0xB8 and 0xB9: List of activated AS-i slaves (LAS)

This list contains the AS-i slaves that are currently activated on the bus. In projecting mode, all detected AS-i slaves are activated. In protected mode, only those projected AS-i slaves with matching ID code and I/O ID in the actual and set configuration are activated. For each AS-i slave, parameters 0xB8 and 0xB9 contain a bit that indicates whether the respective AS-i slave was activated (this parameter is read only):

Parameter	Bit	Description
0xB8	0	reserved
	1	0 _{bin} : AS-i slave 1 (1A) was not activated 1 _{bin} : AS-i slave 1 (1A) was activated

	31	0 _{bin} : AS-i slave 31 (31A) was not activated 1 _{bin} : AS-i slave 31 (31A) was activated
0xB9	0	reserved
	1	0 _{bin} : AS-i slave 33 (1B) was not activated 1 _{bin} : AS-i slave 33 (1B) was activated

	31	0 _{bin} : AS-i slave 63 (31B) was not activated 1 _{bin} : AS-i slave 63 (31B) was activated

Parameters 0xD0 to 0xD7: Read extended ID code 1 (actual configuration)

AS-i slaves optionally have a 4-bit extended ID code 1, which is stored in parameters 0xD0 to 0xD7 (these parameters are read only):

Parameter	Bit	Description
0xD0	0 to 3	read extended ID code 1, AS-i slave 0
	4 to 7	read extended ID code 1, AS-i slave 1 (1A)
	8 to 11	read extended ID code 1, AS-i slave 2 (2A)
	12 to 15	read extended ID code 1, AS-i slave 3 (3A)
	16 to 19	read extended ID code 1, AS-i slave 4 (4A)
	20 to 23	read extended ID code 1, AS-i slave 5 (5A)
	24 to 27	read extended ID code 1, AS-i slave 6 (6A)
	28 to 31	read extended ID code 1, AS-i slave 7 (7A)
0xD1	0 to 3	read extended ID code 1, AS-i slave 8 (8A)
	4 to 7	read extended ID code 1, AS-i slave 9 (9A)
	8 to 11	read extended ID code 1, AS-i slave 10 (10A)
	12 to 15	read extended ID code 1, AS-i slave 11 (11A)
	16 to 19	read extended ID code 1, AS-i slave 12 (12A)
	20 to 23	read extended ID code 1, AS-i slave 13 (13A)
	24 to 27	read extended ID code 1, AS-i slave 14 (14A)
	28 to 31	read extended ID code 1, AS-i slave 15 (15A)
0xD2	0 to 3	read extended ID code 1, AS-i slave 16 (16A)
	4 to 7	read extended ID code 1, AS-i slave 17 (17A)
	8 to 11	read extended ID code 1, AS-i slave 18 (18A)
	12 to 15	read extended ID code 1, AS-i slave 19 (19A)
	16 to 19	read extended ID code 1, AS-i slave 20 (20A)
	20 to 23	read extended ID code 1, AS-i slave 21 (21A)
	24 to 27	read extended ID code 1, AS-i slave 22 (22A)
	28 to 31	read extended ID code 1, AS-i slave 23 (23A)
0xD3	0 to 3	read extended ID code 1, AS-i slave 24 (24A)
	4 to 7	read extended ID code 1, AS-i slave 25 (25A)
	8 to 11	read extended ID code 1, AS-i slave 26 (26A)
	12 to 15	read extended ID code 1, AS-i slave 27 (27A)
	16 to 19	read extended ID code 1, AS-i slave 28 (28A)
	20 to 23	read extended ID code 1, AS-i slave 29 (29A)
	24 to 27	read extended ID code 1, AS-i slave 30 (30A)
	28 to 31	read extended ID code 1, AS-i slave 31 (31A)

Parameter	Bit	Description
0xD4	0 to 3	Reserved (AS-i slave address 32 is not permitted)
	4 to 7	read extended ID code 1, AS-i slave 33 (1B)
	8 to 11	read extended ID code 1, AS-i slave 34 (2B)
	12 to 15	read extended ID code 1, AS-i slave 35 (3B)
	16 to 19	read extended ID code 1, AS-i slave 36 (4B)
	20 to 23	read extended ID code 1, AS-i slave 37 (5B)
	24 to 27	read extended ID code 1, AS-i slave 38 (6B)
	28 to 31	read extended ID code 1, AS-i slave 39 (7B)
0xD5	0 to 3	read extended ID code 1, AS-i slave 40 (8B)
	4 to 7	read extended ID code 1, AS-i slave 41 (9B)
	8 to 11	read extended ID code 1, AS-i slave 42 (10B)
	12 to 15	read extended ID code 1, AS-i slave 43 (11B)
	16 to 19	read extended ID code 1, AS-i slave 44 (12B)
	20 to 23	read extended ID code 1, AS-i slave 45 (13B)
	24 to 27	read extended ID code 1, AS-i slave 46 (14B)
	28 to 31	read extended ID code 1, AS-i slave 47 (15B)
0xD6	0 to 3	read extended ID code 1, AS-i slave 48 (16B)
	4 to 7	read extended ID code 1, AS-i slave 49 (17B)
	8 to 11	read extended ID code 1, AS-i slave 50 (18B)
	12 to 15	read extended ID code 1, AS-i slave 51 (19B)
	16 to 19	read extended ID code 1, AS-i slave 52 (20B)
	20 to 23	read extended ID code 1, AS-i slave 53 (21B)
	24 to 27	read extended ID code 1, AS-i slave 54 (22B)
	28 to 31	read extended ID code 1, AS-i slave 55 (23B)
0xD7	0 to 3	read extended ID code 1, AS-i slave 56 (24B)
	4 to 7	read extended ID code 1, AS-i slave 57 (25B)
	8 to 11	read extended ID code 1, AS-i slave 58 (26B)
	12 to 15	read extended ID code 1, AS-i slave 59 (27B)
	16 to 19	read extended ID code 1, AS-i slave 60 (28B)
	20 to 23	read extended ID code 1, AS-i slave 61 (29B)
	24 to 27	read extended ID code 1, AS-i slave 62 (30B)
	28 to 31	read extended ID code 1, AS-i slave 63 (31B)

Parameters 0xD8 to 0xDF: Read extended ID code 2 (actual configuration)

AS-i slaves optionally have a 4-bit extended ID code 2, which is stored in parameters 0xD8 to 0xDF (these parameters are read only):

Parameter	Bit	Description
0xD8	0 to 3	read extended ID code 2, AS-i slave 0
	4 to 7	read extended ID code 2, AS-i slave 1 (1A)
	8 to 11	read extended ID code 2, AS-i slave 2 (2A)
	12 to 15	read extended ID code 2, AS-i slave 3 (3A)
	16 to 19	read extended ID code 2, AS-i slave 4 (4A)
	20 to 23	read extended ID code 2, AS-i slave 5 (5A)
	24 to 27	read extended ID code 2, AS-i slave 6 (6A)
	28 to 31	read extended ID code 2, AS-i slave 7 (7A)
0xD9	0 to 3	read extended ID code 2, AS-i slave 8 (8A)
	4 to 7	read extended ID code 2, AS-i slave 9 (9A)
	8 to 11	read extended ID code 2, AS-i slave 10 (10A)
	12 to 15	read extended ID code 2, AS-i slave 11 (11A)
	16 to 19	read extended ID code 2, AS-i slave 12 (12A)
	20 to 23	read extended ID code 2, AS-i slave 13 (13A)
	24 to 27	read extended ID code 2, AS-i slave 14 (14A)
	28 to 31	read extended ID code 2, AS-i slave 15 (15A)

Parameter	Bit	Description
0xDA	0 to 3	read extended ID code 2, AS-i slave 16 (16A)
	4 to 7	read extended ID code 2, AS-i slave 17 (17A)
	8 to 11	read extended ID code 2, AS-i slave 18 (18A)
	12 to 15	read extended ID code 2, AS-i slave 19 (19A)
	16 to 19	read extended ID code 2, AS-i slave 20 (20A)
	20 to 23	read extended ID code 2, AS-i slave 21 (21A)
	24 to 27	read extended ID code 2, AS-i slave 22 (22A)
	28 to 31	read extended ID code 2, AS-i slave 23 (23A)
0xDB	0 to 3	read extended ID code 2, AS-i slave 24 (24A)
	4 to 7	read extended ID code 2, AS-i slave 25 (25A)
	8 to 11	read extended ID code 2, AS-i slave 26 (26A)
	12 to 15	read extended ID code 2, AS-i slave 27 (27A)
	16 to 19	read extended ID code 2, AS-i slave 28 (28A)
	20 to 23	read extended ID code 2, AS-i slave 29 (29A)
	24 to 27	read extended ID code 2, AS-i slave 30 (30A)
	28 to 31	read extended ID code 2, AS-i slave 31 (31A)
0xDC	0 to 3	Reserved (AS-i slave address 32 is not permitted)
	4 to 7	read extended ID code 2, AS-i slave 33 (1B)
	8 to 11	read extended ID code 2, AS-i slave 34 (2B)
	12 to 15	read extended ID code 2, AS-i slave 35 (3B)
	16 to 19	read extended ID code 2, AS-i slave 36 (4B)
	20 to 23	read extended ID code 2, AS-i slave 37 (5B)
	24 to 27	read extended ID code 2, AS-i slave 38 (6B)
	28 to 31	read extended ID code 2, AS-i slave 39 (7B)
0xDD	0 to 3	read extended ID code 2, AS-i slave 40 (8B)
	4 to 7	read extended ID code 2, AS-i slave 41 (9B)
	8 to 11	read extended ID code 2, AS-i slave 42 (10B)
	12 to 15	read extended ID code 2, AS-i slave 43 (11B)
	16 to 19	read extended ID code 2, AS-i slave 44 (12B)
	20 to 23	read extended ID code 2, AS-i slave 45 (13B)
	24 to 27	read extended ID code 2, AS-i slave 46 (14B)
	28 to 31	read extended ID code 2, AS-i slave 47 (15B)
0xDE	0 to 3	read extended ID code 2, AS-i slave 48 (16B)
	4 to 7	read extended ID code 2, AS-i slave 49 (17B)
	8 to 11	read extended ID code 2, AS-i slave 50 (18B)
	12 to 15	read extended ID code 2, AS-i slave 51 (19B)
	16 to 19	read extended ID code 2, AS-i slave 52 (20B)
	20 to 23	read extended ID code 2, AS-i slave 53 (21B)
	24 to 27	read extended ID code 2, AS-i slave 54 (22B)
	28 to 31	read extended ID code 2, AS-i slave 55 (23B)
0xDF	0 to 3	read extended ID code 2, AS-i slave 56 (24B)
	4 to 7	read extended ID code 2, AS-i slave 57 (25B)
	8 to 11	read extended ID code 2, AS-i slave 58 (26B)
	12 to 15	read extended ID code 2, AS-i slave 59 (27B)
	16 to 19	read extended ID code 2, AS-i slave 60 (28B)
	20 to 23	read extended ID code 2, AS-i slave 61 (29B)
	24 to 27	read extended ID code 2, AS-i slave 62 (30B)
	28 to 31	read extended ID code 2, AS-i slave 63 (31B)

Parameters 0xE0 to 0xE7: Projected extended ID code 1 (nominal configuration)

In protected mode, the extended ID code 1 of the currently projected AS-i slaves is checked. The currently projected 4-bit extended ID codes 1 of the AS-i slaves are located in parameters 0xE0 to 0xE7 (these parameters are read/write and are stored in the flash of the AS-i master (i.e. they are still available after power off/on)):

Parameter	Bit	Description
0xE0	0 to 3	reserved
	4 to 7	projected extended ID code 1, AS-i slave 1 (1A)
	8 to 11	projected extended ID code 1, AS-i slave 2 (2A)
	12 to 15	projected extended ID code 1, AS-i slave 3 (3A)
	16 to 19	projected extended ID code 1, AS-i slave 4 (4A)
	20 to 23	projected extended ID code 1, AS-i slave 5 (5A)
	24 to 27	projected extended ID code 1, AS-i slave 6 (6A)
	28 to 31	projected extended ID code 1, AS-i slave 7 (7A)
0xE1	0 to 3	projected extended ID code 1, AS-i slave 8 (8A)
	4 to 7	projected extended ID code 1, AS-i slave 9 (9A)
	8 to 11	projected extended ID code 1, AS-i slave 10 (10A)
	12 to 15	projected extended ID code 1, AS-i slave 11 (11A)
	16 to 19	projected extended ID code 1, AS-i slave 12 (12A)
	20 to 23	projected extended ID code 1, AS-i slave 13 (13A)
	24 to 27	projected extended ID code 1, AS-i slave 14 (14A)
	28 to 31	projected extended ID code 1, AS-i slave 15 (15A)
0xE2	0 to 3	projected extended ID code 1, AS-i slave 16 (16A)
	4 to 7	projected extended ID code 1, AS-i slave 17 (17A)
	8 to 11	projected extended ID code 1, AS-i slave 18 (18A)
	12 to 15	projected extended ID code 1, AS-i slave 19 (19A)
	16 to 19	projected extended ID code 1, AS-i slave 20 (20A)
	20 to 23	projected extended ID code 1, AS-i slave 21 (21A)
	24 to 27	projected extended ID code 1, AS-i slave 22 (22A)
	28 to 31	projected extended ID code 1, AS-i slave 23 (23A)
0xE3	0 to 3	projected extended ID code 1, AS-i slave 24 (24A)
	4 to 7	projected extended ID code 1, AS-i slave 25 (25A)
	8 to 11	projected extended ID code 1, AS-i slave 26 (26A)
	12 to 15	projected extended ID code 1, AS-i slave 27 (27A)
	16 to 19	projected extended ID code 1, AS-i slave 28 (28A)
	20 to 23	projected extended ID code 1, AS-i slave 29 (29A)
	24 to 27	projected extended ID code 1, AS-i slave 30 (30A)
	28 to 31	projected extended ID code 1, AS-i slave 31 (31A)
0xE4	0 to 3	Reserved (AS-i slave address 32 is not permitted)
	4 to 7	projected extended ID code 1, AS-i slave 33 (1B)
	8 to 11	projected extended ID code 1, AS-i slave 34 (2B)
	12 to 15	projected extended ID code 1, AS-i slave 35 (3B)
	16 to 19	projected extended ID code 1, AS-i slave 36 (4B)
	20 to 23	projected extended ID code 1, AS-i slave 37 (5B)
	24 to 27	projected extended ID code 1, AS-i slave 38 (6B)
	28 to 31	projected extended ID code 1, AS-i slave 39 (7B)
0xE5	0 to 3	projected extended ID code 1, AS-i slave 40 (8B)
	4 to 7	projected extended ID code 1, AS-i slave 41 (9B)
	8 to 11	projected extended ID code 1, AS-i slave 42 (10B)
	12 to 15	projected extended ID code 1, AS-i slave 43 (11B)
	16 to 19	projected extended ID code 1, AS-i slave 44 (12B)
	20 to 23	projected extended ID code 1, AS-i slave 45 (13B)
	24 to 27	projected extended ID code 1, AS-i slave 46 (14B)
	28 to 31	projected extended ID code 1, AS-i slave 47 (15B)

Parameter	Bit	Description
0xE6	0 to 3	projected extended ID code 1, AS-i slave 48 (16B)
	4 to 7	projected extended ID code 1, AS-i slave 49 (17B)
	8 to 11	projected extended ID code 1, AS-i slave 50 (18B)
	12 to 15	projected extended ID code 1, AS-i slave 51 (19B)
	16 to 19	projected extended ID code 1, AS-i slave 52 (20B)
	20 to 23	projected extended ID code 1, AS-i slave 53 (21B)
	24 to 27	projected extended ID code 1, AS-i slave 54 (22B)
	28 to 31	projected extended ID code 1, AS-i slave 55 (23B)
0xE7	0 to 3	projected extended ID code 1, AS-i slave 56 (24B)
	4 to 7	projected extended ID code 1, AS-i slave 57 (25B)
	8 to 11	projected extended ID code 1, AS-i slave 58 (26B)
	12 to 15	projected extended ID code 1, AS-i slave 59 (27B)
	16 to 19	projected extended ID code 1, AS-i slave 60 (28B)
	20 to 23	projected extended ID code 1, AS-i slave 61 (29B)
	24 to 27	projected extended ID code 1, AS-i slave 62 (30B)
	28 to 31	projected extended ID code 1, AS-i slave 63 (31B)

Parameters 0xE8 to 0xEF: Projected extended ID code 2 (nominal configuration)

In protected mode, the extended ID code 2 of the currently projected AS-i slaves is checked. The currently projected 4-bit ID codes of the AS-i slaves are located in parameters 0xE8 to 0xEF (these parameters are read/write and are stored in the flash of the AS-i master (i.e. they are still available after power off/on)):

Parameter	Bit	Description
0xE8	0 to 3	reserved
	4 to 7	projected extended ID code 2, AS-i slave 1 (1A)
	8 to 11	projected extended ID code 2, AS-i slave 2 (2A)
	12 to 15	projected extended ID code 2, AS-i slave 3 (3A)
	16 to 19	projected extended ID code 2, AS-i slave 4 (4A)
	20 to 23	projected extended ID code 2, AS-i slave 5 (5A)
	24 to 27	projected extended ID code 2, AS-i slave 6 (6A)
	28 to 31	projected extended ID code 2, AS-i slave 7 (7A)
0xE9	0 to 3	projected extended ID code 2, AS-i slave 8 (8A)
	4 to 7	projected extended ID code 2, AS-i slave 9 (9A)
	8 to 11	projected extended ID code 2, AS-i slave 10 (10A)
	12 to 15	projected extended ID code 2, AS-i slave 11 (11A)
	16 to 19	projected extended ID code 2, AS-i slave 12 (12A)
	20 to 23	projected extended ID code 2, AS-i slave 13 (13A)
	24 to 27	projected extended ID code 2, AS-i slave 14 (14A)
	28 to 31	projected extended ID code 2, AS-i slave 15 (15A)
0xE/A	0 to 3	projected extended ID code 2, AS-i slave 16 (16A)
	4 to 7	projected extended ID code 2, AS-i slave 17 (17A)
	8 to 11	projected extended ID code 2, AS-i slave 18 (18A)
	12 to 15	projected extended ID code 2, AS-i slave 19 (19A)
	16 to 19	projected extended ID code 2, AS-i slave 20 (20A)
	20 to 23	projected extended ID code 2, AS-i slave 21 (21A)
	24 to 27	projected extended ID code 2, AS-i slave 22 (22A)
	28 to 31	projected extended ID code 2, AS-i slave 23 (23A)
0xEB	0 to 3	projected extended ID code 2, AS-i slave 24 (24A)
	4 to 7	projected extended ID code 2, AS-i slave 25 (25A)
	8 to 11	projected extended ID code 2, AS-i slave 26 (26A)
	12 to 15	projected extended ID code 2, AS-i slave 27 (27A)
	16 to 19	projected extended ID code 2, AS-i slave 28 (28A)
	20 to 23	projected extended ID code 2, AS-i slave 29 (29A)
	24 to 27	projected extended ID code 2, AS-i slave 30 (30A)
	28 to 31	projected extended ID code 2, AS-i slave 31 (31A)

Parameter	Bit	Description
0xEC	0 to 3	Reserved (AS-i slave address 32 is not permitted)
	4 to 7	projected extended ID code 2, AS-i slave 33 (1B)
	8 to 11	projected extended ID code 2, AS-i slave 34 (2B)
	12 to 15	projected extended ID code 2, AS-i slave 35 (3B)
	16 to 19	projected extended ID code 2, AS-i slave 36 (4B)
	20 to 23	projected extended ID code 2, AS-i slave 37 (5B)
	24 to 27	projected extended ID code 2, AS-i slave 38 (6B)
	28 to 31	projected extended ID code 2, AS-i slave 39 (7B)
0xED	0 to 3	projected extended ID code 2, AS-i slave 40 (8B)
	4 to 7	projected extended ID code 2, AS-i slave 41 (9B)
	8 to 11	projected extended ID code 2, AS-i slave 42 (10B)
	12 to 15	projected extended ID code 2, AS-i slave 43 (11B)
	16 to 19	projected extended ID code 2, AS-i slave 44 (12B)
	20 to 23	projected extended ID code 2, AS-i slave 45 (13B)
	24 to 27	projected extended ID code 2, AS-i slave 46 (14B)
	28 to 31	projected extended ID code 2, AS-i slave 47 (15B)
0xEE	0 to 3	projected extended ID code 2, AS-i slave 48 (16B)
	4 to 7	projected extended ID code 2, AS-i slave 49 (17B)
	8 to 11	projected extended ID code 2, AS-i slave 50 (18B)
	12 to 15	projected extended ID code 2, AS-i slave 51 (19B)
	16 to 19	projected extended ID code 2, AS-i slave 52 (20B)
	20 to 23	projected extended ID code 2, AS-i slave 53 (21B)
	24 to 27	projected extended ID code 2, AS-i slave 54 (22B)
	28 to 31	projected extended ID code 2, AS-i slave 55 (23B)
0xEF	0 to 3	projected extended ID code 2, AS-i slave 56 (24B)
	4 to 7	projected extended ID code 2, AS-i slave 57 (25B)
	8 to 11	projected extended ID code 2, AS-i slave 58 (26B)
	12 to 15	projected extended ID code 2, AS-i slave 59 (27B)
	16 to 19	projected extended ID code 2, AS-i slave 60 (28B)
	20 to 23	projected extended ID code 2, AS-i slave 61 (29B)
	24 to 27	projected extended ID code 2, AS-i slave 62 (30B)
	28 to 31	projected extended ID code 2, AS-i slave 63 (31B)

Parameter 0xF0: List of analog slaves

(only up to address 31, because analog slaves do not support extended addressing)

Parameter	Bit	Description
0xF0	0	Slave 0 is an analog slave
	1	Slave 1 is an analog slave

	31	Slave 31 is an analog slave

Parameter 0xF8: List of safety slaves

(only up to address 31, because safety slaves do not support extended addressing)

Parameter	Bit	Description
0xF8	0	Slave 0 is a safety slave
	1	Slave 1 is a safety slave

	31	Slave 31 is a safety slave

Parameter 0x100: AS-i command interface

Commands can be sent to the AS-i slaves via parameter 0x100. This is possible both during the offline phase (no other commands on the AS-i bus) and during the management phase. During the management phase, only non-activated AS-i slaves can be addressed (this parameter is write only).

Parameter	Bit	Value	Description
0x100	0 to 7	0 to 255	must be unequal 0 in order for the command to be sent
	8 to 15	1	ASI command for reading ID code
		2	ASI command for reading the EA ID
		3	ASI command for reading the status
		4	AS-i command write parameter
		5	ASI command for data exchange
		6	ASI command for resetting an ASI slave
		7	AS-i command addressing call If an address in bits 16 to 23 is not equal 0, the AS-i command "Delete operating address" must be called first, because the address can only be set if it was previously 0.
		8	AS-i command <i>Delete operating address</i>
	16 to 23	0 to 31	Address of the AS-i slave for which the command is intended
24 to 31	0 to 31	AS-i command data: <ul style="list-style-type: none"> for AS-i command <i>Write parameter</i>: Parameter data for AS-i command <i>Addressing call</i>: new address 	

Acknowledge

If AS-i parameter 0x100 is written to the KL6201/KL6211 via register communication, the following information is returned as acknowledgement:

Parameter	Bit	Description
Acknowledgement to 0x100	7 to 0	always 0
	14 to 8	Corresponding to bits 0 to 14 of the command call.
	15	Error bit: If bit 15 is set, an error occurred during command execution, and an error code is issued in bits 31 to 24!
	23 to 16	Address of the AS-i slave to which the command was sent.
	31 to 24	Acknowledgement of the AS-i command for parameter writing (bit 4 of the AS-i commands was set): Bits 31 to 24 return the data transferred when the AS-i command was called (bits 31 to 24 of the AS-i command). Acknowledgement of the AS-i command for addressing call (bit 7 of the AS-i command was set): addressing call [▶ 85] If the error bit (bit 15) is not set, bits 31 to 24 contain the value 00 _{hex} . If the error bit (bit 15) is set, bits 31 to 24 contain an error code. This error code is also issued if AS-i addresses are modified via the KS2000 configuration software.
	0x00	Address modification was successful.
	0x11	No slave exists with an address that was specified as the old address.
	0x22	Address 0 is currently assigned to another slave. To change the address of an AS-i slave, the KL6201/KL6211 first has to assign the address 0 to it, before a new address can be assigned.
	0x36	A slave with the address that was specified as the new address already exists.
	0x47	After deleting the old address, no slave with address 0 exists.
	0x58	After deleting the old address, an error is generated during reading of the extended ID code 1 of slave 0. Address changes for A/B slaves also require the extended ID code 1.
	0x69	After writing of extended ID code 1, no slave with address 0 exists.
	0x6B	After writing of the new address, the slave with the new address is not available during reading of the ID code.
	0x6C	After writing of the new address, the slave with the new address is not available during reading of the status.
	0x7D	The address could not be saved permanently (non-volatile).
	0x7E	The extended ID code of an A/B slave could not be saved permanently (non-volatile).
	0x7F	ID code 1 is invalid for A/B slaves
	0x83	The new address is a B address. If slaves are to be operated on two parallel addresses in address ranges A and B, e.g. 10A (10) and 10B (42), both slaves have to support B addressing. In this case, the parallel A address contains a slave that does not support B addressing!
	0x84	The new address is a B address. The slave selected with the old address is not an A/B slave, i.e. it does not support the B addresses (33 to 63).
	0x85	The new address is an A address. Slave is not an A/B slave: the associated B slave for the new address exists.

Parameter 0x108: General command interface

Parameter 0x108 can be used to execute general commands (this parameter is write only):

Parameter	Bit	Value	Description
0x108	0 to 15	0x0210	The detected AS-i slaves are automatically projected (all AS-i slaves from the LDS are entered in the LPS, including read ID codes and I/O IDs)
	16 to 31	0	reserved
0x108	0 to 15	0x0301	Specifies which data exchange repeat counter is addressed via parameters 0x340 to 0x35F [► 96].
		0x01	Repeat counter for one repetition of the data exchange telegram
		0x02	Repeat counter for two repetitions of the data exchange telegram
		0x03	Repeat counter for three repetitions of the data exchange telegram
		0x04	Repeat counter for four repetitions of the data exchange telegram
	0x05	Repeat counter for five repetitions of the data exchange telegram	
25 to 31	0	reserved	
0x108	0 to 15	0x0C00	Initialization of the string transfer to slave profile 7.4
		0x0C10	Command Read_ID_String
		0x0C20	Command Read_Diagnosis_String
		0x0C30	Command Read_Parameter_String
		0x0C40	Command Write_Parameter_String
	16 to 23	0...62	Slave address
	24 to 31	0	reserved

Parameters 0x120 to 0x12F: General status information

Parameter 0x120 ff contains general status information for the KL6201/KL6211 and the connected AS-i network.

Parameter	Bit	Description
0x120	0 to 15	Startup status (0: no error)
	16 to 31	Status of automatic project configuration (0: no error)
0x121 to 0x127	in each case 0 to 31	reserved
0x128 to 0x12F	in each case 0 to 31	reserved

Parameters 0x140 to 0x15F: Physical fault counter

Each AS-i slave has a counter that is incremented if a response from the associated AS-i slave had a start bit, stop bit or parity bit error (this parameter is read/write):

Parameter	Bit	Description
0x140	0 to 15	Physical fault counter, AS-i slave 0
	16 to 31	Physical fault counter, AS-i slave 1 (1A)
0x141	0 to 15	Physical fault counter, AS-i slave 2 (2A)
	16 to 31	Physical fault counter, AS-i slave 3 (3A)
0x142	0 to 15	Physical fault counter, AS-i slave 4 (4A)
	16 to 31	Physical fault counter, AS-i slave 5 (5A)
0x143	0 to 15	Physical fault counter, AS-i slave 6 (6A)
	16 to 31	Physical fault counter, AS-i slave 7 (7A)
0x144	0 to 15	Physical fault counter, AS-i slave 8 (8A)
	16 to 31	Physical fault counter, AS-i slave 9 (9A)
0x145	0 to 15	Physical fault counter, AS-i slave 10 (10A)
	16 to 31	Physical fault counter, AS-i slave 11 (11A)
0x146	0 to 15	Physical fault counter, AS-i slave 12 (12A)
	16 to 31	Physical fault counter, AS-i slave 13 (13A)
0x147	0 to 15	Physical fault counter, AS-i slave 14 (14A)
	16 to 31	Physical fault counter, AS-i slave 15 (15A)
0x148	0 to 15	Physical fault counter, AS-i slave 16 (16A)
	16 to 31	Physical fault counter, AS-i slave 17 (17A)

Parameter	Bit	Description
0x149	0 to 15	Physical fault counter, AS-i slave 18 (18A)
	16 to 31	Physical fault counter, AS-i slave 19 (19A)
0x14A	0 to 15	Physical fault counter, AS-i slave 20 (20A)
	16 to 31	Physical fault counter, AS-i slave 21 (21A)
0x14B	0 to 15	Physical fault counter, AS-i slave 22 (22A)
	16 to 31	Physical fault counter, AS-i slave 23 (23A)
0x14C	0 to 15	Physical fault counter, AS-i slave 24 (24A)
	16 to 31	Physical fault counter, AS-i slave 25 (25A)
0x14D	0 to 15	Physical fault counter, AS-i slave 26 (26A)
	16 to 31	Physical fault counter, AS-i slave 27 (27A)
0x14E	0 to 15	Physical fault counter, AS-i slave 28 (28A)
	16 to 31	Physical fault counter, AS-i slave 29 (29A)
0x14F	0 to 15	Physical fault counter, AS-i slave 30 (30A)
	16 to 31	Physical fault counter, AS-i slave 31 (31A)
0x150	0 to 15	Reserved (AS-i slave address 32 is not permitted)
	16 to 31	Physical fault counter, AS-i slave 33 (1A)
0x151	0 to 15	Physical fault counter, AS-i slave 34 (2A)
	16 to 31	Physical fault counter, AS-i slave 35 (3A)
0x152	0 to 15	Physical fault counter, AS-i slave 36 (4A)
	16 to 31	Physical fault counter, AS-i slave 37 (5A)
0x153	0 to 15	Physical fault counter, AS-i slave 38 (6A)
	16 to 31	Physical fault counter, AS-i slave 39 (7A)
0x154	0 to 15	Physical fault counter, AS-i slave 40 (8A)
	16 to 31	Physical fault counter, AS-i slave 41 (9A)
0x155	0 to 15	Physical fault counter, AS-i slave 42 (10A)
	16 to 31	Physical fault counter, AS-i slave 43 (11A)
0x156	0 to 15	Physical fault counter, AS-i slave 44 (12A)
	16 to 31	Physical fault counter, AS-i slave 45 (13A)
0x157	0 to 15	Physical fault counter, AS-i slave 46 (14A)
	16 to 31	Physical fault counter, AS-i slave 47 (15A)
0x158	0 to 15	Physical fault counter, AS-i slave 48 (16A)
	16 to 31	Physical fault counter, AS-i slave 49 (17A)
0x159	0 to 15	Physical fault counter, AS-i slave 50 (18A)
	16 to 31	Physical fault counter, AS-i slave 51 (19A)
0x15A	0 to 15	Physical fault counter, AS-i slave 52 (20A)
	16 to 31	Physical fault counter, AS-i slave 53 (21A)
0x15B	0 to 15	Physical fault counter, AS-i slave 54 (22A)
	16 to 31	Physical fault counter, AS-i slave 55 (23A)
0x15C	0 to 15	Physical fault counter, AS-i slave 56 (24A)
	16 to 31	Physical fault counter, AS-i slave 57 (25A)
0x15D	0 to 15	Physical fault counter, AS-i slave 58 (26A)
	16 to 31	Physical fault counter, AS-i slave 59 (27A)
0x15E	0 to 15	Physical fault counter, AS-i slave 60 (28A)
	16 to 31	Physical fault counter, AS-i slave 61 (29A)
0x15F	0 to 15	Physical fault counter, AS-i slave 62 (30A)
	16 to 31	Physical fault counter, AS-i slave 63 (31A)

Parameters 0x160 to 0x17F: Timeout counter

Each AS-i slave has a counter that is incremented if the associated AS-i slave has not responded (this parameter is read/write):

Parameter	Bit	Description
0x160	0 to 15	Timeout counter, AS-i slave 0
	16 to 31	Timeout counter, AS-i slave 1 (1A)
0x161	0 to 15	Timeout counter, AS-i slave 2 (2A)
	16 to 31	Timeout counter, AS-i slave 3 (3A)
0x162	0 to 15	Timeout counter, AS-i slave 4 (4A)
	16 to 31	Timeout counter, AS-i slave 5 (5A)
0x163	0 to 15	Timeout counter, AS-i slave 6 (6A)
	16 to 31	Timeout counter, AS-i slave 7 (7A)
0x164	0 to 15	Timeout counter, AS-i slave 8 (8A)
	16 to 31	Timeout counter, AS-i slave 9 (9A)
0x165	0 to 15	Timeout counter, AS-i slave 10 (10A)
	16 to 31	Timeout counter, AS-i slave 11 (11A)
0x166	0 to 15	Timeout counter, AS-i slave 12 (12A)
	16 to 31	Timeout counter, AS-i slave 13 (13A)
0x167	0 to 15	Timeout counter, AS-i slave 14 (14A)
	16 to 31	Timeout counter, AS-i slave 15 (15A)
0x168	0 to 15	Timeout counter, AS-i slave 16 (16A)
	16 to 31	Timeout counter, AS-i slave 17 (17A)
0x169	0 to 15	Timeout counter, AS-i slave 18 (18A)
	16 to 31	Timeout counter, AS-i slave 19 (19A)
0x16A	0 to 15	Timeout counter, AS-i slave 20 (20A)
	16 to 31	Timeout counter, AS-i slave 21 (21A)
0x16B	0 to 15	Timeout counter, AS-i slave 22 (22A)
	16 to 31	Timeout counter, AS-i slave 23 (23A)
0x16C	0 to 15	Timeout counter, AS-i slave 24 (24A)
	16 to 31	Timeout counter, AS-i slave 25 (25A)
0x16D	0 to 15	Timeout counter, AS-i slave 26 (26A)
	16 to 31	Timeout counter, AS-i slave 27 (27A)
0x16E	0 to 15	Timeout counter, AS-i slave 28 (28A)
	16 to 31	Timeout counter, AS-i slave 29 (29A)
0x16F	0 to 15	Timeout counter, AS-i slave 30 (30A)
	16 to 31	Timeout counter, AS-i slave 31 (31A)
0x170	0 to 15	Reserved (AS-i slave address 32 is not permitted)
	16 to 31	Timeout counter, AS-i slave 33 (1B)
0x171	0 to 15	Timeout counter, AS-i slave 34 (2B)
	16 to 31	Timeout counter, AS-i slave 35 (3B)
0x172	0 to 15	Timeout counter, AS-i slave 36 (4B)
	16 to 31	Timeout counter, AS-i slave 37 (5B)
0x173	0 to 15	Timeout counter, AS-i slave 38 (6B)
	16 to 31	Timeout counter, AS-i slave 39 (7B)
0x174	0 to 15	Timeout counter, AS-i slave 40 (8B)
	16 to 31	Timeout counter, AS-i slave 41 (9B)
0x175	0 to 15	Timeout counter, AS-i slave 42 (10B)
	16 to 31	Timeout counter, AS-i slave 43 (11B)
0x176	0 to 15	Timeout counter, AS-i slave 44 (12B)
	16 to 31	Timeout counter, AS-i slave 45 (13B)
0x177	0 to 15	Timeout counter, AS-i slave 46 (14B)
	16 to 31	Timeout counter, AS-i slave 47 (15B)
0x178	0 to 15	Timeout counter, AS-i slave 48 (16B)
	16 to 31	Timeout counter, AS-i slave 49 (17B)
0x179	0 to 15	Timeout counter, AS-i slave 50 (18B)
	16 to 31	Timeout counter, AS-i slave 51 (19B)

Parameter	Bit	Description
0x17A	0 to 15	Timeout counter, AS-i slave 52 (20B)
	16 to 31	Timeout counter, AS-i slave 53 (21B)
0x17B	0 to 15	Timeout counter, AS-i slave 54 (22B)
	16 to 31	Timeout counter, AS-i slave 55 (23B)
0x17C	0 to 15	Timeout counter, AS-i slave 56 (24B)
	16 to 31	Timeout counter, AS-i slave 57 (25B)
0x17D	0 to 15	Timeout counter, AS-i slave 58 (26B)
	16 to 31	Timeout counter, AS-i slave 59 (27B)
0x17E	0 to 15	Timeout counter, AS-i slave 60 (28B)
	16 to 31	Timeout counter, AS-i slave 61 (29B)
0x17F	0 to 15	Timeout counter, AS-i slave 62 (30B)
	16 to 31	Timeout counter, AS-i slave 63 (31B)

Parameters 0x180 to 0x19F: Response counter

Each AS-i slave has a counter that is incremented if the associated AS-i slave has responded correctly (this parameter is read/write):

Parameter	Bit	Description
0x180	0 to 15	Response counter, AS-i slave 0
	16 to 31	Response counter, AS-i slave 1 (1A)
0x181	0 to 15	Response counter, AS-i slave 2 (2A)
	16 to 31	Response counter, AS-i slave 3 (3A)
0x182	0 to 15	Response counter, AS-i slave 4 (4A)
	16 to 31	Response counter, AS-i slave 5 (5A)
0x183	0 to 15	Response counter, AS-i slave 6 (6A)
	16 to 31	Response counter, AS-i slave 7 (7A)
0x184	0 to 15	Response counter, AS-i slave 8 (8A)
	16 to 31	Response counter, AS-i slave 9 (9A)
0x185	0 to 15	Response counter, AS-i slave 10 (10A)
	16 to 31	Response counter, AS-i slave 11 (11A)
0x186	0 to 15	Response counter, AS-i slave 12 (12A)
	16 to 31	Response counter, AS-i slave 13 (13A)
0x187	0 to 15	Response counter, AS-i slave 14 (14A)
	16 to 31	Response counter, AS-i slave 15 (15A)
0x188	0 to 15	Response counter, AS-i slave 16 (16A)
	16 to 31	Response counter, AS-i slave 17 (17A)
0x189	0 to 15	Response counter, AS-i slave 18 (18A)
	16 to 31	Response counter, AS-i slave 19 (19A)
0x18A	0 to 15	Response counter, AS-i slave 20 (20A)
	16 to 31	Response counter, AS-i slave 21 (21A)
0x18B	0 to 15	Response counter, AS-i slave 22 (22A)
	16 to 31	Response counter, AS-i slave 23 (23A)
0x18C	0 to 15	Response counter, AS-i slave 24 (24A)
	16 to 31	Response counter, AS-i slave 25 (25A)
0x18D	0 to 15	Response counter, AS-i slave 26 (26A)
	16 to 31	Response counter, AS-i slave 27 (27A)
0x18E	0 to 15	Response counter, AS-i slave 28 (28A)
	16 to 31	Response counter, AS-i slave 29 (29A)
0x18F	0 to 15	Response counter, AS-i slave 30 (30A)
	16 to 31	Response counter, AS-i slave 31 (31A)
0x190	0 to 15	Reserved (AS-i slave address 32 is not permitted)
	16 to 31	Response counter, AS-i slave 33 (1B)
0x191	0 to 15	Response counter, AS-i slave 34 (2B)
	16 to 31	Response counter, AS-i slave 35 (3B)
0x192	0 to 15	Response counter, AS-i slave 36 (4B)
	16 to 31	Response counter, AS-i slave 37 (5B)

Parameter	Bit	Description
0x193	0 to 15	Response counter, AS-i slave 38 (6B)
	16 to 31	Response counter, AS-i slave 39 (7B)
0x194	0 to 15	Response counter, AS-i slave 40 (8B)
	16 to 31	Response counter, AS-i slave 41 (9B)
0x195	0 to 15	Response counter, AS-i slave 42 (10B)
	16 to 31	Response counter, AS-i slave 43 (11B)
0x196	0 to 15	Response counter, AS-i slave 44 (12B)
	16 to 31	Response counter, AS-i slave 45 (13B)
0x197	0 to 15	Response counter, AS-i slave 46 (14B)
	16 to 31	Response counter, AS-i slave 47 (15B)
0x198	0 to 15	Response counter, AS-i slave 48 (16B)
	16 to 31	Response counter, AS-i slave 49 (17B)
0x199	0 to 15	Response counter, AS-i slave 50 (18B)
	16 to 31	Response counter, AS-i slave 51 (19B)
0x19A	0 to 15	Response counter, AS-i slave 52 (20B)
	16 to 31	Response counter, AS-i slave 53 (21B)
0x19B	0 to 15	Response counter, AS-i slave 54 (22B)
	16 to 31	Response counter, AS-i slave 55 (23B)
0x19C	0 to 15	Response counter, AS-i slave 56 (24B)
	16 to 31	Response counter, AS-i slave 57 (25B)
0x19D	0 to 15	Response counter, AS-i slave 58 (26B)
	16 to 31	Response counter, AS-i slave 59 (27B)
0x19E	0 to 15	Response counter, AS-i slave 60 (28B)
	16 to 31	Response counter, AS-i slave 61 (29B)
0x19F	0 to 15	Response counter, AS-i slave 62 (30B)
	16 to 31	Response counter, AS-i slave 63 (31B)

Parameters 0x1A0 to 0x1BF: Leave data exchange counter

Each AS-i slave has a counter that is incremented if the associated AS-i slave was removed from the LAS, i.e. if it has not (or not correctly) responded three times in a row (this parameter is read/write):

Parameter	Bit	Description
0x1A0	0 to 15	Leave data exchange counter, AS-i slave 0
	16 to 31	Leave data exchange counter, AS-i slave 1 (1A)
0x1A1	0 to 15	Leave data exchange counter, AS-i slave 2 (2A)
	16 to 31	Leave data exchange counter, AS-i slave 3 (3A)
0x1A2	0 to 15	Leave data exchange counter, AS-i slave 4 (4A)
	16 to 31	Leave data exchange counter, AS-i slave 5 (5A)
0x1A3	0 to 15	Leave data exchange counter, AS-i slave 6 (6A)
	16 to 31	Leave data exchange counter, AS-i slave 7 (7A)
0x1A4	0 to 15	Leave data exchange counter, AS-i slave 8 (8A)
	16 to 31	Leave data exchange counter, AS-i slave 9 (9A)
0x1A5	0 to 15	Leave data exchange counter, AS-i slave 10 (10A)
	16 to 31	Leave data exchange counter, AS-i slave 11 (11A)
0x1A6	0 to 15	Leave data exchange counter, AS-i slave 12 (12A)
	16 to 31	Leave data exchange counter, AS-i slave 13 (13A)
0x1A7	0 to 15	Leave data exchange counter, AS-i slave 14 (14A)
	16 to 31	Leave data exchange counter, AS-i slave 15 (15A)
0x1A8	0 to 15	Leave data exchange counter, AS-i slave 16 (16A)
	16 to 31	Leave data exchange counter, AS-i slave 17 (17A)
0x1A9	0 to 15	Leave data exchange counter, AS-i slave 18 (18A)
	16 to 31	Leave data exchange counter, AS-i slave 19 (19A)
0x1AA	0 to 15	Leave data exchange counter, AS-i slave 20 (20A)
	16 to 31	Leave data exchange counter, AS-i slave 21 (21A)
0x1AB	0 to 15	Leave data exchange counter, AS-i slave 22 (22A)
	16 to 31	Leave data exchange counter, AS-i slave 23 (23A)

Parameter	Bit	Description
0x1AC	0 to 15	Leave data exchange counter, AS-i slave 24 (24A)
	16 to 31	Leave data exchange counter, AS-i slave 25 (25A)
0x1AD	0 to 15	Leave data exchange counter, AS-i slave 26 (26A)
	16 to 31	Leave data exchange counter, AS-i slave 27 (27A)
0x1AE	0 to 15	Leave data exchange counter, AS-i slave 28 (28A)
	16 to 31	Leave data exchange counter, AS-i slave 29 (29A)
0x1AF	0 to 15	Leave data exchange counter, AS-i slave 30 (30A)
	16 to 31	Leave data exchange counter, AS-i slave 31 (31A)
0x1B0	0 to 15	Reserved (AS-i slave address 32 is not permitted)
	16 to 31	Leave data exchange counter, AS-i slave 33 (1B)
0x1B1	0 to 15	Leave data exchange counter, AS-i slave 34 (2B)
	16 to 31	Leave data exchange counter, AS-i slave 35 (3B)
0x1B2	0 to 15	Leave data exchange counter, AS-i slave 36 (4B)
	16 to 31	Leave data exchange counter, AS-i slave 37 (5B)
0x1B3	0 to 15	Leave data exchange counter, AS-i slave 38 (6B)
	16 to 31	Leave data exchange counter, AS-i slave 39 (7B)
0x1B4	0 to 15	Leave data exchange counter, AS-i slave 40 (8B)
	16 to 31	Leave data exchange counter, AS-i slave 41 (9B)
0x1B5	0 to 15	Leave data exchange counter, AS-i slave 42 (10B)
	16 to 31	Leave data exchange counter, AS-i slave 43 (11B)
0x1B6	0 to 15	Leave data exchange counter, AS-i slave 44 (12B)
	16 to 31	Leave data exchange counter, AS-i slave 45 (13B)
0x1B7	0 to 15	Leave data exchange counter, AS-i slave 46 (14B)
	16 to 31	Leave data exchange counter, AS-i slave 47 (15B)
0x1B8	0 to 15	Leave data exchange counter, AS-i slave 48 (16B)
	16 to 31	Leave data exchange counter, AS-i slave 49 (17B)
0x1B9	0 to 15	Leave data exchange counter, AS-i slave 50 (18B)
	16 to 31	Leave data exchange counter, AS-i slave 51 (19B)
0x1BA	0 to 15	Leave data exchange counter, AS-i slave 52 (20B)
	16 to 31	Leave data exchange counter, AS-i slave 53 (21B)
0x1BB	0 to 15	Leave data exchange counter, AS-i slave 54 (22B)
	16 to 31	Leave data exchange counter, AS-i slave 55 (23B)
0x1BC	0 to 15	Leave data exchange counter, AS-i slave 56 (24B)
	16 to 31	Leave data exchange counter, AS-i slave 57 (25B)
0x1BD	0 to 15	Leave data exchange counter, AS-i slave 58 (26B)
	16 to 31	Leave data exchange counter, AS-i slave 59 (27B)
0x1BE	0 to 15	Leave data exchange counter, AS-i slave 60 (28B)
	16 to 31	Leave data exchange counter, AS-i slave 61 (29B)
0x1BF	0 to 15	Leave data exchange counter, AS-i slave 62 (30B)
	16 to 31	Leave data exchange counter, AS-i slave 63 (31B)

Parameters 0x1C0 to 0x1DF: DataExch failed counter

Each AS-i slave has a counter that is incremented if the associated AS-i slave has not (or not correctly) responded to a DataExchange telegram (this parameter is read/write):

Parameter	Bit	Description
0x1C0	0 to 15	DataExch failed counter, AS-i slave 0
	16 to 31	DataExch failed counter, AS-i slave 1 (1A)
0x1C1	0 to 15	DataExch failed counter, AS-i slave 2 (2A)
	16 to 31	DataExch failed counter, AS-i slave 3 (3A)
0x1C2	0 to 15	DataExch failed counter, AS-i slave 4 (4A)
	16 to 31	DataExch failed counter, AS-i slave 5 (5A)
0x1C3	0 to 15	DataExch failed counter, AS-i slave 6 (6A)
	16 to 31	DataExch failed counter, AS-i slave 7 (7A)
0x1C4	0 to 15	DataExch failed counter, AS-i slave 8 (8A)
	16 to 31	DataExch failed counter, AS-i slave 9 (9A)

Parameter	Bit	Description
0x1C5	0 to 15	DataExch failed counter, AS-i slave 10 (10A)
	16 to 31	DataExch failed counter, AS-i slave 11 (11A)
0x1C6	0 to 15	DataExch failed counter, AS-i slave 12 (12A)
	16 to 31	DataExch failed counter, AS-i slave 13 (13A)
0x1C7	0 to 15	DataExch failed counter, AS-i slave 14 (14A)
	16 to 31	DataExch failed counter, AS-i slave 15 (15A)
0x1C8	0 to 15	DataExch failed counter, AS-i slave 16 (16A)
	16 to 31	DataExch failed counter, AS-i slave 17 (17A)
0x1C9	0 to 15	DataExch failed counter, AS-i slave 18 (18A)
	16 to 31	DataExch failed counter, AS-i slave 19 (19A)
0x1CA	0 to 15	DataExch failed counter, AS-i slave 20 (20A)
	16 to 31	DataExch failed counter, AS-i slave 21 (21A)
0x1CB	0 to 15	DataExch failed counter, AS-i slave 22 (22A)
	16 to 31	DataExch failed counter, AS-i slave 23 (23A)
0x1CC	0 to 15	DataExch failed counter, AS-i slave 24 (24A)
	16 to 31	DataExch failed counter, AS-i slave 25 (25A)
0x1CD	0 to 15	DataExch failed counter, AS-i slave 26 (26A)
	16 to 31	DataExch failed counter, AS-i slave 27 (27A)
0x1CE	0 to 15	DataExch failed counter, AS-i slave 28 (28A)
	16 to 31	DataExch failed counter, AS-i slave 29 (29A)
0x1CF	0 to 15	DataExch failed counter, AS-i slave 30 (30A)
	16 to 31	DataExch failed counter, AS-i slave 31 (31A)
0x1C0	0 to 15	Reserved (AS-i slave address 32 is not permitted)
	16 to 31	DataExch failed counter, AS-i slave 33 (1B)
0x1D1	0 to 15	DataExch failed counter, AS-i slave 34 (2B)
	16 to 31	DataExch failed counter, AS-i slave 35 (3B)
0x1D2	0 to 15	DataExch failed counter, AS-i slave 36 (4B)
	16 to 31	DataExch failed counter, AS-i slave 37 (5B)
0x1D3	0 to 15	DataExch failed counter, AS-i slave 38 (6B)
	16 to 31	DataExch failed counter, AS-i slave 39 (7B)
0x1D4	0 to 15	DataExch failed counter, AS-i slave 40 (8B)
	16 to 31	DataExch failed counter, AS-i slave 41 (9B)
0x1D5	0 to 15	DataExch failed counter, AS-i slave 42 (10B)
	16 to 31	DataExch failed counter, AS-i slave 43 (11B)
0x1D6	0 to 15	DataExch failed counter, AS-i slave 44 (12B)
	16 to 31	DataExch failed counter, AS-i slave 45 (13B)
0x1D7	0 to 15	DataExch failed counter, AS-i slave 46 (14B)
	16 to 31	DataExch failed counter, AS-i slave 47 (15B)
0x1D8	0 to 15	DataExch failed counter, AS-i slave 48 (16B)
	16 to 31	DataExch failed counter, AS-i slave 49 (17B)
0x1D9	0 to 15	DataExch failed counter, AS-i slave 50 (18B)
	16 to 31	DataExch failed counter, AS-i slave 51 (19B)
0x1DA	0 to 15	DataExch failed counter, AS-i slave 52 (20B)
	16 to 31	DataExch failed counter, AS-i slave 53 (21B)
0x1DB	0 to 15	DataExch failed counter, AS-i slave 54 (22B)
	16 to 31	DataExch failed counter, AS-i slave 55 (23B)
0x1DC	0 to 15	DataExch failed counter, AS-i slave 56 (24B)
	16 to 31	DataExch failed counter, AS-i slave 57 (25B)
0x1DD	0 to 15	DataExch failed counter, AS-i slave 58 (26B)
	16 to 31	DataExch failed counter, AS-i slave 59 (27B)
0x1DE	0 to 15	DataExch failed counter, AS-i slave 60 (28B)
	16 to 31	DataExch failed counter, AS-i slave 61 (29B)
0x1DF	0 to 15	DataExch failed counter, AS-i slave 62 (30B)
	16 to 31	DataExch failed counter, AS-i slave 63 (31B)

Parameters 0x200 to 0x27F: Analog slave data

Parameter	Bit	Description				
		Channel	if analog output		if analog input	
			Write	Read	Read	Write
0x200	Bit 0 to 31	(Slave 0)	Since slave no. 0 is not designated for analog AS-i slaves, zeros are transferred to the process image in this instance.			
0x201	Bit 0 to 31					
0x202	Bit 0 to 31					
0x203	Bit 0 to 31					
0x204	Bit 0 to 15	Slave 1, channel 1	Analog value	-	Analog value	not possible
	Bit 16		V flag** (valid)	V flag (valid)	V flag (valid)	
	Bit 17		-	-	O flag (overflow)	
	Bit 21		-	No Response	No Response	
	Bit 22		-	Toggle timeout	Toggle timeout	
	Bit 23		-	Data exchange disabled*	Data exchange disabled*	
0x205	Bit 0 to 15	Slave 1, channel 2	Analog value	-	Analog value	not possible
	Bit 16		V flag** (valid)	V flag (valid)	V flag (valid)	
	Bit 17		-	-	O flag (overflow)	
	Bit 21		-	No Response	No Response	
	Bit 22		-	Toggle timeout	Toggle timeout	
	Bit 23		-	Data exchange disabled*	Data exchange disabled*	
0x206	Bit 0 to 15	Slave 1, channel 3	Analog value	-	Analog value	not possible
	Bit 16		V flag** (valid)	V flag (valid)	V flag (valid)	
	Bit 17		-	-	O flag (overflow)	
	Bit 21		-	No Response	No Response	
	Bit 22		-	Toggle timeout	Toggle timeout	
	Bit 23		-	Data exchange disabled*	Data exchange disabled*	
0x207	Bit 0 to 15	Slave 1, channel 4	Analog value	-	Analog value	not possible
	Bit 16		V flag** (valid)	V flag (valid)	V flag (valid)	
	Bit 17		-	-	O flag (overflow)	
	Bit 21		-	No Response	No Response	
	Bit 22		-	Toggle timeout	Toggle timeout	
	Bit 23		-	Data exchange disabled*	Data exchange disabled*	
...
0x27C	...	Slave 31, channel 1
0x27D	...	Slave 31, channel 2	...	(see mapping table ▶ 100)
0x27E	...	Slave 31, channel 3
0x27F	...	Slave 31, channel 4

*) if ASI control bit 3 = 0_{bin}

***) The V flag (valid) must be set by the controller in order for the AS-i slave to switch its outputs.

Parameter 0x300: Cycle times

Parameter	Bit	Description
0x300	Bits 0-15	current cycle time in μ s
	Bits 16-31	maximum cycle time in μ s

Parameter 0x310: Statistics

Parameter	Bit	Description
0x310	Bits 0-7	Max. number of data exchange errors per ASI cycle
	Bits 8-15	Timeouts/data exchange telegrams in %
	Bits 16-31	reserved

Parameters 0x320 to 0x32F: Timeout statistics for each AS-i slave

Parameter	Bit	Description
0x320	Bit 0 to 7	Timeouts/telegram in percent, AS-i slave 0
	Bit 8 to 15	Timeouts/telegram in percent, AS-i slave 1 (1A)
	Bit 16 to 23	Timeouts/telegram in percent, AS-i slave 2 (2A)
	Bit 24 to 31	Timeouts/telegram in percent, AS-i slave 3 (3A)
0x321	Bit 0 to 7	Timeouts/telegram in percent, AS-i slave 4 (4A)
	Bit 8 to 15	Timeouts/telegram in percent, AS-i slave 5 (5A)
	Bit 16 to 23	Timeouts/telegram in percent, AS-i slave 6 (6A)
	Bit 24 to 31	Timeouts/telegram in percent, AS-i slave 7 (7A)
0x322	Bit 0 to 7	Timeouts/telegram in percent, AS-i slave 8 (8A)
	Bit 8 to 15	Timeouts/telegram in percent, AS-i slave 9 (9A)
	Bit 16 to 23	Timeouts/telegram in percent, AS-i slave 10 (10A)
	Bit 24 to 31	Timeouts/telegram in percent, AS-i slave 11 (11A)
0x323	Bit 0 to 7	Timeouts/telegram in percent, AS-i slave 12 (12A)
	Bit 8 to 15	Timeouts/telegram in percent, AS-i slave 13 (13A)
	Bit 16 to 23	Timeouts/telegram in percent, AS-i slave 14 (14A)
	Bit 24 to 31	Timeouts/telegram in percent, AS-i slave 15 (15A)
0x324	Bit 0 to 7	Timeouts/telegram in percent, AS-i slave 16 (16A)
	Bit 8 to 15	Timeouts/telegram in percent, AS-i slave 17 (17A)
	Bit 16 to 23	Timeouts/telegram in percent, AS-i slave 18 (18A)
	Bit 24 to 31	Timeouts/telegram in percent, AS-i slave 19 (19A)
0x325	Bit 0 to 7	Timeouts/telegram in percent, AS-i slave 20 (20A)
	Bit 8 to 15	Timeouts/telegram in percent, AS-i slave 21 (21A)
	Bit 16 to 23	Timeouts/telegram in percent, AS-i slave 22 (22A)
	Bit 24 to 31	Timeouts/telegram in percent, AS-i slave 23 (23A)
0x326	Bit 0 to 7	Timeouts/telegram in percent, AS-i slave 24 (24A)
	Bit 8 to 15	Timeouts/telegram in percent, AS-i slave 25 (25A)
	Bit 16 to 23	Timeouts/telegram in percent, AS-i slave 26 (26A)
	Bit 24 to 31	Timeouts/telegram in percent, AS-i slave 27 (27A)
0x327	Bit 0 to 7	Timeouts/telegram in percent, AS-i slave 28 (28A)
	Bit 8 to 15	Timeouts/telegram in percent, AS-i slave 29 (29A)
	Bit 16 to 23	Timeouts/telegram in percent, AS-i slave 30 (30A)
	Bit 24 to 31	Timeouts/telegram in percent, AS-i slave 31 (31A)
0x328	Bit 0 to 7	Reserved (AS-i slave address 32 is not permitted)
	Bit 8 to 15	Timeouts/telegram in percent, AS-i slave 33 (1B)
	Bit 16 to 23	Timeouts/telegram in percent, AS-i slave 34 (2B)
	Bit 24 to 31	Timeouts/telegram in percent, AS-i slave 35 (3B)
0x329	Bit 0 to 7	Timeouts/telegram in percent, AS-i slave 36 (4B)
	Bit 8 to 15	Timeouts/telegram in percent, AS-i slave 37 (5B)
	Bit 16 to 23	Timeouts/telegram in percent, AS-i slave 38 (6B)
	Bit 24 to 31	Timeouts/telegram in percent, AS-i slave 39 (7B)
0x32A	Bit 0 to 7	Timeouts/telegram in percent, AS-i slave 40 (8B)
	Bit 8 to 15	Timeouts/telegram in percent, AS-i slave 41 (9B)
	Bit 16 to 23	Timeouts/telegram in percent, AS-i slave 42 (10B)
	Bit 24 to 31	Timeouts/telegram in percent, AS-i slave 43 (11B)
0x32B	Bit 0 to 7	Timeouts/telegram in percent, AS-i slave 44 (12B)
	Bit 8 to 15	Timeouts/telegram in percent, AS-i slave 45 (13B)
	Bit 16 to 23	Timeouts/telegram in percent, AS-i slave 46 (14B)
	Bit 24 to 31	Timeouts/telegram in percent, AS-i slave 47 (15B)
0x32C	Bit 0 to 7	Timeouts/telegram in percent, AS-i slave 48 (16B)
	Bit 8 to 15	Timeouts/telegram in percent, AS-i slave 49 (17B)
	Bit 16 to 23	Timeouts/telegram in percent, AS-i slave 50 (18B)
	Bit 24 to 31	Timeouts/telegram in percent, AS-i slave 51 (19B)
0x32D	Bit 0 to 7	Timeouts/telegram in percent, AS-i slave 52 (20B)
	Bit 8 to 15	Timeouts/telegram in percent, AS-i slave 53 (21B)
	Bit 16 to 23	Timeouts/telegram in percent, AS-i slave 54 (22B)
	Bit 24 to 31	Timeouts/telegram in percent, AS-i slave 55 (23B)

Parameter	Bit	Description
0x32E	Bit 0 to 7	Timeouts/telegram in percent, AS-i slave 56 (24B)
	Bit 8 to 15	Timeouts/telegram in percent, AS-i slave 57 (25B)
	Bit 16 to 23	Timeouts/telegram in percent, AS-i slave 58 (26B)
	Bit 24 to 31	Timeouts/telegram in percent, AS-i slave 59 (27B)
0x32F	Bit 0 to 7	Timeouts/telegram in percent, AS-i slave 60 (28B)
	Bit 8 to 15	Timeouts/telegram in percent, AS-i slave 61 (29B)
	Bit 16 to 23	Timeouts/telegram in percent, AS-i slave 62 (30B)
	Bit 24 to 31	Timeouts/telegram in percent, AS-i slave 63 (31B)

Parameters 0x340 to 0x35F: Data exchange repeat counter for each AS-i slave

There are 5 repeat counters, since the data exchange telegram is sent up to six times before the slave is removed from the LAS - the maximum number of repeats is therefore five. The counters indicate how often one, two, three, four or five repetitions were required:

- If, for example, the slave started responding after the 4th repetition, the repeat counter will have been incremented three times.
- If the slave does not respond six times, it is removed from the LAS, and none of the repeat counter is incremented.

The general command interface (parameter [0x108 \[► 87\]](#)) determines which of the 5 repeat counters is addressed via parameters 0x340 to 0x35F (switchover of x).

Parameter	Bit	Description
0x340	0 to 15	reserved
	16 to 31	Data exchange repeat counter x, AS-i slave 1 (1A)
0x341	0 to 15	Data exchange repeat counter x, AS-i slave 2 (2A)
	16 to 31	Data exchange repeat counter x, AS-i slave 3 (3A)
0x342	0 to 15	Data exchange repeat counter x, AS-i slave 4 (4A)
	16 to 31	Data exchange repeat counter x, AS-i slave 5 (5A)
0x343	0 to 15	Data exchange repeat counter x, AS-i slave 6 (6A)
	16 to 31	Data exchange repeat counter x, AS-i slave 7 (7A)
0x344	0 to 15	Data exchange repeat counter x, AS-i slave 8 (8A)
	16 to 31	Data exchange repeat counter x, AS-i slave 9 (9A)
0x345	0 to 15	Data exchange repeat counter x, AS-i slave 10 (10A)
	16 to 31	Data exchange repeat counter x, AS-i slave 11 (11A)
0x346	0 to 15	Data exchange repeat counter x, AS-i slave 12 (12A)
	16 to 31	Data exchange repeat counter x, AS-i slave 13 (13A)
0x347	0 to 15	Data exchange repeat counter x, AS-i slave 14 (14A)
	16 to 31	Data exchange repeat counter x, AS-i slave 15 (15A)
0x348	0 to 15	Data exchange repeat counter x, AS-i slave 16 (16A)
	16 to 31	Data exchange repeat counter x, AS-i slave 17 (17A)
0x349	0 to 15	Data exchange repeat counter x, AS-i slave 18 (18A)
	16 to 31	Data exchange repeat counter x, AS-i slave 19 (19A)
0x34A	0 to 15	Data exchange repeat counter x, AS-i slave 20 (20A)
	16 to 31	Data exchange repeat counter x, AS-i slave 21 (21A)
0x34B	0 to 15	Data exchange repeat counter x, AS-i slave 22 (22A)
	16 to 31	Data exchange repeat counter x, AS-i slave 23 (23A)
0x34C	0 to 15	Data exchange repeat counter x, AS-i slave 24 (24A)
	16 to 31	Data exchange repeat counter x, AS-i slave 25 (25A)
0x34D	0 to 15	Data exchange repeat counter x, AS-i slave 26 (26A)
	16 to 31	Data exchange repeat counter x, AS-i slave 27 (27A)
0x34E	0 to 15	Data exchange repeat counter x, AS-i slave 28 (28A)
	16 to 31	Data exchange repeat counter x, AS-i slave 29 (29A)
0x34F	0 to 15	Data exchange repeat counter x, AS-i slave 30 (30A)
	16 to 31	Data exchange repeat counter x, AS-i slave 31 (31A)

Parameter	Bit	Description
0x340	0 to 15	Reserved (AS-i slave address 32 is not permitted)
	16 to 31	Data exchange repeat counter x, AS-i slave 33 (1B)
0x351	0 to 15	Data exchange repeat counter x, AS-i slave 34 (2B)
	16 to 31	Data exchange repeat counter x, AS-i slave 35 (3B)
0x352	0 to 15	Data exchange repeat counter x, AS-i slave 36 (4B)
	16 to 31	Data exchange repeat counter x, AS-i slave 37 (5B)
0x353	0 to 15	Data exchange repeat counter x, AS-i slave 38 (6B)
	16 to 31	Data exchange repeat counter x, AS-i slave 39 (7B)
0x354	0 to 15	Data exchange repeat counter x, AS-i slave 40 (8B)
	16 to 31	Data exchange repeat counter x, AS-i slave 41 (9B)
0x355	0 to 15	Data exchange repeat counter x, AS-i slave 42 (10B)
	16 to 31	Data exchange repeat counter x, AS-i slave 43 (11B)
0x356	0 to 15	Data exchange repeat counter x, AS-i slave 44 (12B)
	16 to 31	Data exchange repeat counter x, AS-i slave 45 (13B)
0x357	0 to 15	Data exchange repeat counter x, AS-i slave 46 (14B)
	16 to 31	Data exchange repeat counter x, AS-i slave 47 (15B)
0x358	0 to 15	Data exchange repeat counter x, AS-i slave 48 (16B)
	16 to 31	Data exchange repeat counter x, AS-i slave 49 (17B)
0x359	0 to 15	Data exchange repeat counter x, AS-i slave 50 (18B)
	16 to 31	Data exchange repeat counter x, AS-i slave 51 (19B)
0x35A	0 to 15	Data exchange repeat counter x, AS-i slave 52 (20B)
	16 to 31	Data exchange repeat counter x, AS-i slave 53 (21B)
0x35B	0 to 15	Data exchange repeat counter x, AS-i slave 54 (22B)
	16 to 31	Data exchange repeat counter x, AS-i slave 55 (23B)
0x35C	0 to 15	Data exchange repeat counter x, AS-i slave 56 (24B)
	16 to 31	Data exchange repeat counter x, AS-i slave 57 (25B)
0x35D	0 to 15	Data exchange repeat counter x, AS-i slave 58 (26B)
	16 to 31	Data exchange repeat counter x, AS-i slave 59 (27B)
0x35E	0 to 15	Data exchange repeat counter x, AS-i slave 60 (28B)
	16 to 31	Data exchange repeat counter x, AS-i slave 61 (29B)
0x35F	0 to 15	Data exchange repeat counter x, AS-i slave 62 (30B)
	16 to 31	Data exchange repeat counter x, AS-i slave 63 (31B)

5.8 Access to AS-i parameters

The parameters of the KL6201/KL6211 AS-i master terminal can be accessed via the parameter data block. Write and read access are documented below, including examples.

Writing a parameter

The following sequence should be used for writing a parameter:

First check whether the previous access was fully completed. To do this, assess status byte 1: Bits 4 to 7 should be 0_{bin} . If this is not the case, control bytes 0 and 1 should be set to 0, until bits 4 to 7 in status byte 1 are set to 0_{bin} .

Write access (PLC->KL6201/KL6211): parameter data block

Byte	Byte 0	Byte 1	Byte 2	Byte 3	Byte 4	Byte 5
Name	Control byte 0	Control byte 1	ParaOut0	ParaOut1	ParaOut2	ParaOut3
Value	$01_{\text{bin}} A_5 A_4 A_3 A_2 A_1 A_0$	$0100_{\text{bin}} A_9 A_8 A_7 A_6$	$P_0 \dots P_7$	$P_8 \dots P_{15}$	$P_{16} \dots P_{23}$	$P_{24} \dots P_{31}$

A_0 to A_9 : bits of the parameter address

P_0 to P_{31} : bits of the parameter value

Response to write access (KL6201/KL6211->PLC): parameter data block

Byte	Byte 0	Byte 1	Byte 2	Byte 3	Byte 4	Byte 5
Name	Status byte 0	Status byte 1	ParaIn0	ParaIn1	ParaIn2	ParaIn3
Value	$xxxx\ xxxx_{\text{bin}}$	$01F1\ xxx1_{\text{bin}}$	Error code	Error code	Error code	Error code

x: Bits can take on any value

F: Error bit.

$F=0_{\text{bin}}$: Write access was successful.

$F=1_{\text{bin}}$: Write access was not successful. Bytes 2 to 5 contain an error code providing information about the cause of the error.

The write sequence is completed by setting the control bytes to zero:

Conclusion of write access (PLC->KL6201/KL6211): parameter data block

Byte	Byte 0	Byte 1	Byte 2	Byte 3	Byte 4	Byte 5
Name	Control byte 0	Control byte 1	ParaOut0	ParaOut1	ParaOut2	ParaOut3
Value	$0000\ 0000_{\text{bin}}$	$0000\ 0000_{\text{bin}}$	x	x	x	x

x: The parameter values are not evaluated if the control bytes are 0x00.

Example

The list of currently projected slaves (LPS) is to be written. The AS-i master is to communicate specifically with the AS-i slaves with node numbers 1, 2, 3, 4, 12, 16, 17 and 30. In other words, the value $0x4003101E$ ($0100\ 0000\ 0000\ 0011\ 0001\ 0000\ 0001\ 1110_{\text{bin}}$) is to be written to parameter $0xA8$ ($1010\ 1000_{\text{bin}}$).

Write access (PLC->KL6201/KL6211): parameter data block

Byte	Byte 0	Byte 1	Byte 2	Byte 3	Byte 4	Byte 5
Name	Control byte 0	Control byte 1	ParaOut0	ParaOut1	ParaOut2	ParaOut3
Value	$0110\ 1000_{\text{bin}}$ (0x68)	$0100\ 0010_{\text{bin}}$ (0x42)	0x1E	0x10	0x03	0x40

The byte order 0x68 42 1E 10 03 40 has to be written to parameter data block for the KL6201/KL6211.

The terminal responds with the following data:

Response to write access (KL6201/KL6211->PLC): parameter data block

Byte	Byte 0	Byte 1	Byte 2	Byte 3	Byte 4	Byte 5
Name	Status byte 0	Status byte 1	ParaIn0	ParaIn1	ParaIn2	ParaIn3
Value	xxxx xxxx _{bin}	0101 xxx1 _{bin}	0	0	0	0

The write sequence is completed with this byte sequence: 0x00 00 00 00 00 00

Reading a parameter

The following sequence should be used for reading a parameter:

First check whether the previous access was fully completed. This requires status 1 to be evaluated - bits 4 to 7 should be 0. If this is not the case, control bytes 0 and 1 should be set to 0, until bits 4 to 7 in status 1 are set to 0.

Read access (PLC->KL6201/KL6211): parameter data block

Byte	Byte 0	Byte 1	Byte 2	Byte 3	Byte 4	Byte 5
Name	Control byte 0	Control byte 1	ParaOut0	ParaOut1	ParaOut2	ParaOut3
Value	00 _{bin} A ₅ A ₄ A ₃ A ₂ A ₁ A ₀	0100 _{bin} A ₉ A ₈ A ₇ A ₆	x	x	x	x

A₀ to A₉: bits of the parameter address

x: The parameter values are not evaluated

Response to read access (KL6201/KL6211->PLC): parameter data block

Byte	Byte 0	Byte 1	Byte 2	Byte 3	Byte 4	Byte 5
Name	Status byte 0	Status byte 1	ParaIn0	ParaIn1	ParaIn2	ParaIn3
Value	xxxx xxxx _{bin}	01F1 xxx0 _{bin}	P ₀ ...P ₇	P ₈ ...P ₁₅	P ₁₆ ...P ₂₃	P ₂₄ ...P ₃₁

x: Bits can take on any value

F: Error bit.

F=0_{bin}: Read access was successful. Bytes 2 to 5 contain the parameter value.

F=1_{bin}: Read access was not successful. Bytes 2 to 5 contain an error code providing information about the cause of the error.

P₀ to P₃₁: bits of the parameter value or error code

The read sequence is completed by setting the control bytes to zero:

Conclusion of read access (PLC->KL6201/KL6211): parameter data block

Byte	Byte 0	Byte 1	Byte 2	Byte 3	Byte 4	Byte 5
Name	Control byte 0	Control byte 1	ParaOut0	ParaOut1	ParaOut2	ParaOut3
Value	0000 0000 _{bin}	0000 0000 _{bin}	x	x	x	x

x: The parameter values are not evaluated if the control bytes are 0x00.

Example

The list of detected slaves (LDS) is to be determined. This requires the parameter 0xB0 (1011 0000_{bin}) to be read.

Read access (PLC->KL6201/KL6211): parameter data block

Byte	Byte 0	Byte 1	Byte 2	Byte 3	Byte 4	Byte 5
Name	Control byte 0	Control byte 1	ParaOut0	ParaOut1	ParaOut2	ParaOut3
Value	0011 0000 _{bin} (0x30)	0100 0010 _{bin} (0x42)	0x00	0x00	0x00	0x00

The byte order 0x30 42 00 00 00 00 has to be written to parameter data block for the KL6201/KL6211. The terminal responds with the following data:

Response to write access (KL6201/KL6211->PLC): parameter data block

Byte	Byte 0	Byte 1	Byte 2	Byte 3	Byte 4	Byte 5
Name	Status byte 0	Status byte 1	ParaIn0	ParaIn1	ParaIn2	ParaIn3
Value	XXXX XXXX _{bin}	0101 xxx0 _{bin}	0x4C	0x02	0x80	0x83

In this example, the AS-i master is assumed to have detected the slaves with the node numbers 2, 3, 6, 9, 23, 24, 25 and 31. It therefore responds with the parameter data 0x8380024C (1000 0011 1000 0000 0000 0010 0100 1100_{bin})

The read sequence is completed with the byte sequence 0x00 00 00 00 00 00.

5.9 Mapping of analog AS-i slaves

The following table shows the assignment of the address areas to analog AS-i slaves,

- for register access (via [register communication \[► 61\]](#) or via the [KS2000 \[► 38\]](#) configuration software)
- for Profibus (access via [DPV1 \[► 104\]](#))

Addresses



Analog AS-i slaves support only address numbers 1 to 31!

Address numbers 33 (1B) to 63 (31B) are not supported by analog AS-i slaves!

*) Since AS-i address 0 is not designated for analog AS-i slaves, zeros are transferred to the process image for the areas identified with an asterisk.

register access		PROFIBUS		AS-i	AS-i slave		Data		
Register page	Register	DPV1 index	Byte	parameters	AS-i address	Channel			
0x20	32 and 33 *	0x40	0 to 3 *	0x200	(0)*	all zero*	4 bytes		
	34 and 35 *		4 to 7 *	0x201			4 bytes		
	36 and 37 *		8 to 11 *	0x202			4 bytes		
	38 and 39 *		12 to 15 *	0x203			4 bytes		
	40 and 41		16 to 19	0x204			1	Ch1	4 bytes
	42 and 43		20 to 23	0x205				Ch2	4 bytes
	44 and 45		24 to 27	0x206				Ch3	4 bytes
	46 and 47		28 to 31	0x207				Ch4	4 bytes
	48 and 49	0x41	0 to 3	0x208	2	Ch1	4 bytes		
	50 and 51		4 to 7	0x209		Ch2	4 bytes		
	52 and 53		8 to 11	0x20A		Ch3	4 bytes		
	54 and 55		12 to 15	0x20B		Ch4	4 bytes		
	56 and 57	0x41	16 to 19	0x20C	3	Ch1	4 bytes		
	58 and 59		20 to 23	0x20D		Ch2	4 bytes		
	60 and 61		24 to 27	0x20E		Ch3	4 bytes		
	62 and 63		28 to 31	0x20F		Ch4	4 bytes		

register access		PROFIBUS		AS-i	AS-i slave		Data
Register page	Register	DPV1 index	Byte	parameters	AS-i address	Channel	
0x21	32 and 33	0x42	0 to 3	0x210	4	Ch1	4 bytes
	34 and 35		4 to 7	0x211		Ch2	4 bytes
	36 and 37		8 to 11	0x212		Ch3	4 bytes
	38 and 39		12 to 15	0x213		Ch4	4 bytes
	40 and 41		16 to 19	0x214	5	Ch1	4 bytes
	42 and 43		20 to 23	0x215		Ch2	4 bytes
	44 and 45		24 to 27	0x216		Ch3	4 bytes
	46 and 47		28 to 31	0x217		Ch4	4 bytes
	48 and 49	0x43	0 to 3	0x218	6	Ch1	4 bytes
	50 and 51		4 to 7	0x219		Ch2	4 bytes
	52 and 53		8 to 11	0x21A		Ch3	4 bytes
	54 and 55		12 to 15	0x21B		Ch4	4 bytes
	56 and 57		16 to 19	0x21C	7	Ch1	4 bytes
	58 and 59		20 to 23	0x21D		Ch2	4 bytes
	60 and 61		24 to 27	0x21E		Ch3	4 bytes
	62 and 63		28 to 31	0x21F		Ch4	4 bytes
0x22	32 and 33	0x44	0 to 3	0x220	8	Ch1	4 bytes
	34 and 35		4 to 7	0x221		Ch2	4 bytes
	36 and 37		8 to 11	0x222		Ch3	4 bytes
	38 and 39		12 to 15	0x223		Ch4	4 bytes
	40 and 41		16 to 19	0x224	9	Ch1	4 bytes
	42 and 43		20 to 23	0x225		Ch2	4 bytes
	44 and 45		24 to 27	0x226		Ch3	4 bytes
	46 and 47		28 to 31	0x227		Ch4	4 bytes
	48 and 49	0x45	0 to 3	0x228	10	Ch1	4 bytes
	50 and 51		4 to 7	0x229		Ch2	4 bytes
	52 and 53		8 to 11	0x22A		Ch3	4 bytes
	54 and 55		12 to 15	0x22B		Ch4	4 bytes
	56 and 57		16 to 19	0x22C	11	Ch1	4 bytes
	58 and 59		20 to 23	0x22D		Ch2	4 bytes
	60 and 61		24 to 27	0x22E		Ch3	4 bytes
	62 and 63		28 to 31	0x22F		Ch4	4 bytes
0x23	32 and 33	0x46	0 to 3	0x230	12	Ch1	4 bytes
	34 and 35		4 to 7	0x231		Ch2	4 bytes
	36 and 37		8 to 11	0x232		Ch3	4 bytes
	38 and 39		12 to 15	0x233		Ch4	4 bytes
	40 and 41		16 to 19	0x234	13	Ch1	4 bytes
	42 and 43		20 to 23	0x235		Ch2	4 bytes
	44 and 45		24 to 27	0x236		Ch3	4 bytes
	46 and 47		28 to 31	0x237		Ch4	4 bytes
	48 and 49	0x47	0 to 3	0x238	14	Ch1	4 bytes
	50 and 51		4 to 7	0x239		Ch2	4 bytes
	52 and 53		8 to 11	0x23A		Ch3	4 bytes
	54 and 55		12 to 15	0x23B		Ch4	4 bytes
	56 and 57		16 to 19	0x23C	15	Ch1	4 bytes
	58 and 59		20 to 23	0x23D		Ch2	4 bytes
	60 and 61		24 to 27	0x23E		Ch3	4 bytes
	62 and 63		28 to 31	0x23F		Ch4	4 bytes

Register access		PROFIBUS		AS-i parameters	AS-i slave		Data
Register page	Register	DPV1 index	Byte		AS-i address	Channel	
0x24	32 and 33	0x48	0 to 3	0x240	16	Ch1	4 bytes
	34 and 35		4 to 7	0x241		Ch2	4 bytes
	36 and 37		8 to 11	0x242		Ch3	4 bytes
	38 and 39		12 to 15	0x243		Ch4	4 bytes
	40 and 41		16 to 19	0x244	17	Ch1	4 bytes
	42 and 43		20 to 23	0x245		Ch2	4 bytes
	44 and 45		24 to 27	0x246		Ch3	4 bytes
	46 and 47		28 to 31	0x247		Ch4	4 bytes
	48 and 49	0x49	0 to 3	0x248	18	Ch1	4 bytes
	50 and 51		4 to 7	0x249		Ch2	4 bytes
	52 and 53		8 to 11	0x24A		Ch3	4 bytes
	54 and 55		12 to 15	0x24B		Ch4	4 bytes
	56 and 57	16 to 19	0x24C	19	Ch1	4 bytes	
	58 and 59	20 to 23	0x24D		Ch2	4 bytes	
	60 and 61	24 to 27	0x24E		Ch3	4 bytes	
	62 and 63	28 to 31	0x24F		Ch4	4 bytes	
0x25	32 and 33	0x4A	0 to 3	0x250	20	Ch1	4 bytes
	34 and 35		4 to 7	0x251		Ch2	4 bytes
	36 and 37		8 to 11	0x252		Ch3	4 bytes
	38 and 39		12 to 15	0x253		Ch4	4 bytes
	40 and 41		16 to 19	0x254	21	Ch1	4 bytes
	42 and 43		20 to 23	0x255		Ch2	4 bytes
	44 and 45		24 to 27	0x256		Ch3	4 bytes
	46 and 47		28 to 31	0x257		Ch4	4 bytes
	48 and 49	0x4B	0 to 3	0x258	22	Ch1	4 bytes
	50 and 51		4 to 7	0x259		Ch2	4 bytes
	52 and 53		8 to 11	0x25A		Ch3	4 bytes
	54 and 55		12 to 15	0x25B		Ch4	4 bytes
	56 and 57		16 to 19	0x25C	23	Ch1	4 bytes
	58 and 59		20 to 23	0x25D		Ch2	4 bytes
	60 and 61		24 to 27	0x25E		Ch3	4 bytes
	62 and 63		28 to 31	0x25F		Ch4	4 bytes
0x26	32 and 33	0x4C	0 to 3	0x260	24	Ch1	4 bytes
	34 and 35		4 to 7	0x261		Ch2	4 bytes
	36 and 37		8 to 11	0x262		Ch3	4 bytes
	38 and 39		12 to 15	0x263		Ch4	4 bytes
	40 and 41		16 to 19	0x264	25	Ch1	4 bytes
	42 and 43		20 to 23	0x265		Ch2	4 bytes
	44 and 45		24 to 27	0x266		Ch3	4 bytes
	46 and 47		28 to 31	0x267		Ch4	4 bytes
	48 and 49	0x4D	0 to 3	0x268	26	Ch1	4 bytes
	50 and 51		4 to 7	0x269		Ch2	4 bytes
	52 and 53		8 to 11	0x26A		Ch3	4 bytes
	54 and 55		12 to 15	0x26B		Ch4	4 bytes
	56 and 57		16 to 19	0x26C	27	Ch1	4 bytes
	58 and 59		20 to 23	0x26D		Ch2	4 bytes
	60 and 61		24 to 27	0x26E		Ch3	4 bytes
	62 and 63		28 to 31	0x26F		Ch4	4 bytes

Register access		PROFIBUS		AS-i parameters	AS-i slave		Data
Register page	Register	DPV1 index	Byte		AS-i address	Channel	
0x27	32 and 33	0x4E	0 to 3	0x270	28	Ch1	4 bytes
	34 and 35		4 to 7	0x271		Ch2	4 bytes
	36 and 37		8 to 11	0x272		Ch3	4 bytes
	38 and 39		12 to 15	0x273		Ch4	4 bytes
	40 and 41		16 to 19	0x274	29	Ch1	4 bytes
	42 and 43		20 to 23	0x275		Ch2	4 bytes
	44 and 45		24 to 27	0x276		Ch3	4 bytes
	46 and 47		28 to 31	0x277		Ch4	4 bytes
	48 and 49	0x4F	0 to 3	0x278	30	Ch1	4 bytes
	50 and 51		4 to 7	0x279		Ch2	4 bytes
	52 and 53		8 to 11	0x27A		Ch3	4 bytes
	54 and 55		12 to 15	0x27B		Ch4	4 bytes
	56 and 57		16 to 19	0x27C	31	Ch1	4 bytes
	58 and 59		20 to 23	0x27D		Ch2	4 bytes
	60 and 61		24 to 27	0x27E		Ch3	4 bytes
	62 and 63		28 to 31	0x27F		Ch4	4 bytes

6 Operation at the fieldbus, overview

6.1 KL6201/KL6211 at PROFIBUS couplers

Chapter overview

This chapter comprises the following sections:

- Selecting the size of the process image
- Mapping of the process data
- Parameter access via DPV1 services
 - [DPV1 Read \[► 106\]](#)
 - [DPV1 Write \[► 108\]](#) (normal write)

Selecting the size of the process image

The size of the process image of the AS-i master terminal can be set to 6, 12, 22 or 38 bytes. In the PROFIBUS couplers (BK3120, BK3150, BK3500, BK3520) the process image is selected by selecting the corresponding modules in the DP configuration. This is done automatically by the Bus Coupler.

● Process Images

i If the 22-byte or 38-byte process image is to be used under PROFIBUS, the Bus Coupler may require a particular firmware version (see chapter [Firmware version \[► 116\]](#) of the Bus Coupler). The delivered firmware version is shown on the back of the Bus Coupler (see example below). If required, the firmware can be updated via the serial interface (KS2000 cable required) or via the PROFIBUS (using the FC3101 fieldbus card, if firmware version B8 is already loaded on the Bus Coupler).

The current firmware versions and the program for the firmware update can be found at <http://www.beckhoff.de>. BK3120 devices with KL6201/KL6211 are supported in TwinCAT from version 2.8 (build 739).



Fig. 31: Specification of the firmware version of the BK3120 PROFIBUS coupler

6-byte process image

Bytes 0 to 5 contain the parameter data block, bytes 6 to 11 contain the process data block. The following DP modules are available:

DP module	Hex code	Description
KL6201 - PRM PAB 6	0xF2, 0x35	Only the 6 bytes of parameter data block are transferred via DP.

12-byte process image

Bytes 0 to 5 contain the parameter data block, bytes 6 to 11 contain the process data block. The following DP modules are available:

DP module	Hex code	Description
KL6201 - PRM PAB 6	0xF2, 0x35	The full 12 bytes are transferred via DP (parameter data block and process data block)
KL6201 - PAB 6	0x35	Only the 6 bytes of the process data block are transferred. Parameter access only via DPV1.

22-byte process image

Bytes 0 to 5 contain the parameter data block, bytes 6 to 21 contain the process data block. The following DP modules are available:

DP module	Hex code	Description
KL6201 - PRM PAB 16	0xF2, 0x3F	The parameter data block and the process data block are transferred.
KL6201 - PAB 16	0x3F	Only the process data block is transferred. Parameter access only via DPV1.

38-byte process image

Bytes 0 to 5 contain the parameter data block, bytes 6 to 37 contain the process data block. The following DP modules are available:

DP module	Hex code	Description
KL6201 - PRM PAB 32	0xF2, 0xC0, 0x1F	The parameter data block and the process data block are transferred.
KL6201 - PAB 32	0xC0, 0x1F	Only the process data block is transferred. Parameter access only via DPV1.

Mapping of the process data

With PROFIBUS, the process data are mapped linearly to the process image, i.e. the process image interface of the KL6201/KL6211 is located in the process image of the PROFIBUS master in the order as described.

Parameter access via DPV1

The parameters of the AS-i master terminal [▶ 65] can be accessed via DPV1. The position of the terminal in the Terminal Bus should be specified as the slot number. The first non-digital terminal after the Bus Coupler is allocated slot number 1, the second non-digital terminal slot number 2, etc.

The parameters are addressed via the index. Up to 8 parameters are addressed as a group, i.e. the index is calculated from the parameter number divided by 8. Any length can be specified for reading (DPV1 read) of parameters. For writing (DPV1 write), parameters have to be specified as double words (length must be divisible by 4), or as 8 bytes for masked writing (length must be divisible by 8).

DPV1 Read

The following parameter can be read via DPV1:

Index	AS-i parameters	Length	Description
0x05	0x28 [▶ 67]	4 bytes	General Information (byte 0 corresponds to bit 0 to 7 of parameter 0x28)
0x08	0x40 to 0x47 [▶ 67]	32 bytes	Projected I/O IDs of all AS-i slaves (byte 0 corresponds to bit 0 to 7 of parameter 0x40)
0x09	0x48 to 0x4F [▶ 69]	32 bytes	Projected ID codes of all AS-i slaves (byte 0 corresponds to bit 0 to 7 of parameter 0x48)
0x0A	0x50 to 0x57 [▶ 70]	32 bytes	Activation parameters for the AS-i slaves (byte 0 corresponds to bit 0 to 7 of parameter 0x50)
0x0B	0x58 to 0x59 [▶ 72]	8 bytes	List of the AS-i slaves that are projected at the next start (byte 0 corresponds to bit 0 to 7 of parameter 0x58)
0x0C	0x60 to 0x61 [▶ 72]	8 bytes	List of I/O IDs of all AS-i slaves to be checked (byte 0 corresponds to bit 0 to 7 of parameter 0x60)
0x0D	0x68 to 0x69 [▶ 72]	8 bytes	List of ID codes of all AS-i slaves to be checked (byte 0 corresponds to bit 0 to 7 of parameter 0x68)
0x0E	0x70 to 0x71 [▶ 73]	8 bytes	List of extended ID codes 1 of all AS-i slaves to be checked (byte 0 corresponds to bit 0 to 7 of parameter 0x70)
0x0F	0x78 to 0x79 [▶ 73]	8 bytes	List of extended ID codes 2 of all AS-i slaves to be checked (byte 0 corresponds to bit 0 to 7 of parameter 0x78)
0x10	0x80 to 0x87 [▶ 73]	32 bytes	Digital inputs of all AS-i slaves (byte 0 corresponds to bit 0 to 7 of parameter 0x80)
0x12	0x90 to 0x97 [▶ 75]	32 bytes	Read I/O IDs of all AS-i slaves (byte 0 corresponds to bit 0 to 7 of parameter 0x90)
0x13	0x98 to 0x9F [▶ 76]	32 bytes	Read ID codes of all AS-i slaves (byte 0 corresponds to bit 0 to 7 of parameter 0x98)
0x14	0xA0 to 0xA7 [▶ 79]	32 bytes	Read status of all AS-i slaves (byte 0 corresponds to bit 0 to 7 of parameter 0xA0)
0x15	0xA8 to 0xA9 [▶ 79]	8 bytes	List of currently projected AS-i slaves (LPS) (byte 0 corresponds to bit 0 to 7 of parameter 0xA8)
0x16	0xB0 to 0xB1 [▶ 79]	8 bytes	List of detected AS-i slaves (LDS) (byte 0 corresponds to bit 0 to 7 of parameter 0xB0)
0x17	0xB8 to 0xB9 [▶ 80]	8 bytes	List of activated AS-i slaves (LAS) (byte 0 corresponds to bit 0 to 7 of parameter 0xB8)
0x18	0xC0 to 0xC1 [▶ 79]	8 bytes	List of slaves that support the extended ID codes (ID codes 1 and 2) (byte 0 corresponds to bit 0 to 7 of parameter 0xC0)
0x19	0xC8 [▶ 79]	4 bytes	List of slaves that support extended addressing (as B slaves with addresses greater than 32) (byte 0 corresponds to bits 0 to 7 of parameter 0xC8)
0x1A	0xD0 to 0xD7	32 bytes	Read extended ID codes 1 of all AS-i slaves (byte 0 corresponds to bit 0 to 7 of parameter 0xD0)
0x1B	0xD8 to 0xDF [▶ 81]	32 bytes	Read extended ID codes 2 of all AS-i slaves (byte 0 corresponds to bit 0 to 7 of parameter 0xD8)
0x1C	0xE0 to 0xE7 [▶ 83]	32 bytes	Currently projected extended ID codes 1 of all AS-i slaves (byte 0 corresponds to bit 0 to 7 of parameter 0xE0)
0x1D	0xE8 to 0xEF [▶ 84]	32 bytes	Currently projected extended ID codes 2 of all AS-i slaves (byte 0 corresponds to bit 0 to 7 of parameter 0xE8)
0x1E	0xF0 [▶ 85]	4 bytes	List of analog slaves (byte 0 corresponds to bit 0 to 7 of parameter 0xF0)
0x1F	0xF8 [▶ 85]	4 bytes	List of safety slaves (byte 0 corresponds to bit 0 to 7 of parameter 0xF8)
0x20	0x100 [▶ 85]	8 bytes	AS-i command interface, response (byte 0 corresponds to the response for parameter 0x100)
0x24	0x120 to 0x12F [▶ 87]	2 bytes	Startup status (0: no error)
		2 bytes	Status of automatic project configuration (0: no error)
	0x121 to 0x127 [▶ 87]	28 bytes	reserved
0x25	0x128 to 0x12F [▶ 87]	32 bytes	reserved
0x28	0x140 to 0x147 [▶ 87]	32 bytes	Physical fault counter, AS-i slave 0 to 15 (byte 0 corresponds to bit 0 to 7 of parameter 0x140)
0x29	0x148 to 0x14F [▶ 87]	32 bytes	Physical fault counter, AS-i slave 16 to 31 (byte 0 corresponds to bit 0 to 7 of parameter 0x148)
0x2A	0x150 to 0x157 [▶ 87]	32 bytes	Physical fault counter, AS-i slave 32 to 47 (byte 0 corresponds to bit 0 to 7 of parameter 0x150)

Index	AS-i parameters	Length	Description
0x2B	0x158 to 0x15F [▶ 87]	32 bytes	Physical fault counter, AS-i slave 48 to 63 (byte 0 corresponds to bit 0 to 7 of parameter 0x158)
0x2C	0x160 to 0x167 [▶ 89]	32 bytes	Timeout counter, AS-i slave 0 to 15 (byte 0 corresponds to bit 0 to 7 of parameter 0x160)
0x2D	0x168 to 0x16F [▶ 89]	32 bytes	Timeout counter, AS-i slave 16 to 31 (byte 0 corresponds to bit 0 to 7 of parameter 0x168)
0x2E	0x170 to 0x177 [▶ 89]	32 bytes	Timeout counter, AS-i slave 32 to 47 (byte 0 corresponds to bit 0 to 7 of parameter 0x170)
0x2F	0x178 to 0x17F [▶ 89]	32 bytes	Timeout counter, AS-i slave 48 to 63 (byte 0 corresponds to bit 0 to 7 of parameter 0x178)
0x30	0x180 to 0x187 [▶ 90]	32 bytes	Response counter, AS-i slave 0 to 15 (byte 0 corresponds to bit 0 to 7 of parameter 0x180)
0x31	0x188 to 0x18F [▶ 90]	32 bytes	Response counter, AS-i slave 16 to 31 (byte 0 corresponds to bit 0 to 7 of parameter 0x188)
0x32	0x190 to 0x197 [▶ 90]	32 bytes	Response counter, AS-i slave 32 to 47 (byte 0 corresponds to bit 0 to 7 of parameter 0x190)
0x33	0x198 to 0x19F [▶ 90]	32 bytes	Response counter, AS-i slave 48 to 63 (byte 0 corresponds to bit 0 to 7 of parameter 0x198)
0x34	0x1A0 to 0x1A7 [▶ 91]	32 bytes	Leave DataExch counter, AS-i slave 0 to 15 (byte 0 corresponds to bit 0 to 7 of parameter 0x1A0)
0x35	0x1A8 to 0x1AF [▶ 91]	32 bytes	Leave DataExch counter, AS-i slave 16 to 31 (byte 0 corresponds to bit 0 to 7 of parameter 0x1A8)
0x36	0x1B0 to 0x1B7 [▶ 91]	32 bytes	Leave DataExch counter, AS-i slave 32 to 47 (byte 0 corresponds to bit 0 to 7 of parameter 0x1B0)
0x37	0x1B8 to 0x1BF [▶ 91]	32 bytes	Leave DataExch counter, AS-i slave 48 to 63 (byte 0 corresponds to bit 0 to 7 of parameter 0x1B8)
0x38	0x1C0 to 0x1C7 [▶ 92]	32 bytes	DataExch failed counter, AS-i slave 0 to 15 (byte 0 corresponds to bit 0 to 7 of parameter 0x1C0)
0x39	0x1C8 to 0x1CF [▶ 92]	32 bytes	DataExch failed counter, AS-i slave 16 to 31 (byte 0 corresponds to bit 0 to 7 of parameter 0x1C8)
0x3A	0x1D0 to 0x1D7 [▶ 92]	32 bytes	DataExch failed counter, AS-i slave 32 to 47 (byte 0 corresponds to bit 0 to 7 of parameter 0x1D0)
0x3B	0x1D8 to 0x1DF [▶ 92]	32 bytes	DataExch failed counter, AS-i slave 48 to 63 (byte 0 corresponds to bit 0 to 7 of parameter 0x1D8)
0x40	0x200 to 0x207 [▶ 94]	32 bytes	16 empty bytes and input data of AS-i analog slave 1 (byte 0 corresponds to bit 0 to 7 of parameter 0x200)
0x41	0x208 to 0x20F [▶ 94]	32 bytes	Input data, AS-i analog slaves 1 and 2 (byte 0 corresponds to bit 0 to 7 of parameter 0x208)
...
0x4F	0x278 to 0x27F [▶ 94]	32 bytes	Input data, AS-i analog slaves 30 and 31 (byte 0 corresponds to bit 0 to 7 of parameter 0x278)
0x60	0x300 [▶ 94]	4 bytes	Cycle times (byte 0 corresponds to bit 0 to 7 of parameter 0x300)
0x62	0x310 [▶ 94]	8 bytes	Statistics (byte 0 corresponds to bit 0 to 7 of parameter 0x310)
0x64	0x320 to 0x327 [▶ 95]	32 bytes	Timeout statistics, AS-i slave 0 to 31 (byte 0 corresponds to bit 0 to 7 of parameter 0x320)
0x65	0x328 to 0x32F [▶ 95]	32 bytes	Timeout statistics, AS-i slave 32 to 63 (byte 0 corresponds to bit 0 to 7 of parameter 0x328)
0x68	0x340 to 0x347 [▶ 96]	32 bytes	Data exchange repeat counter, AS-i slave 0 to 15 (byte 0 corresponds to bit 0 to 7 of parameter 0x340)
0x69	0x348 to 0x34F [▶ 96]	32 bytes	Data exchange repeat counter, AS-i slave 16 to 31 (byte 0 corresponds to bit 0 to 7 of parameter 0x348)
0x6A	0x350 to 0x357 [▶ 96]	32 bytes	Data exchange repeat counter, AS-i slave 32 to 47 (byte 0 corresponds to bit 0 to 7 of parameter 0x350)
0x6B	0x358 to 0x35F [▶ 96]	32 bytes	Data exchange repeat counter, AS-i slave 48 to 63 (byte 0 corresponds to bit 0 to 7 of parameter 0x358)

see map-
ping table
[▶ 100]

DPV1 Write (normal write)

The following parameters can be written via DPV1:

Index	AS-i parameters	Length	Description
0x08	0x40 to 0x47 [► 67]	32 bytes	Projected I/O IDs of all AS-i slaves (byte 0 corresponds to bit 0 to 7 of parameter 0x40)
0x09	0x48 to 0x4F [► 69]	32 bytes	Projected ID codes of all AS-i slaves (byte 0 corresponds to bit 0 to 7 of parameter 0x48)
0x0A	0x50 to 0x57 [► 70]	32 bytes	Activation parameters for the AS-i slaves (byte 0 corresponds to bit 0 to 7 of parameter 0x50)
0x0B	0x58 to 0x59 [► 72]	8 bytes	List of the AS-i slaves that are projected at the next start (byte 0 corresponds to bit 0 to 7 of parameter 0x58)
0x0C	0x60 to 0x61 [► 72]	8 bytes	List of I/O IDs of all AS-i slaves to be checked (byte 0 corresponds to bit 0 to 7 of parameter 0x60)
0x0D	0x68 to 0x69 [► 72]	8 bytes	List of ID codes of all AS-i slaves to be checked (byte 0 corresponds to bit 0 to 7 of parameter 0x68)
0x0E	0x70 to 0x71 [► 73]	8 bytes	List of extended ID codes 1 of all AS-i slaves to be checked (byte 0 corresponds to bit 0 to 7 of parameter 0x70)
0x0F	0x78 to 0x79 [► 73]	8 bytes	List of extended ID codes 2 of all AS-i slaves to be checked (byte 0 corresponds to bit 0 to 7 of parameter 0x78)
0x10	0x80 to 0x87 [► 73]	32 bytes	Digital outputs of all AS-i slaves (byte 0 corresponds to bit 0 to 7 of parameter 0x80)
0x1C	0xE0 to 0xE7 [► 83]	32 bytes	List of extended ID codes 1 of all AS-i slaves to be checked (byte 0 corresponds to bit 0 to 7 of parameter 0xE0)
0x1D	0xE8 to 0xEF [► 84]	32 bytes	List of extended ID codes 2 of all AS-i slaves to be checked (byte 0 corresponds to bit 0 to 7 of parameter 0xE8)
0x20	0x100 [► 85]	4 bytes	AS-i command interface, request (byte 0 corresponds to the task for parameter 0x100)
0x21	0x108 [► 87]	4 bytes	General command interface (byte 0 corresponds to bit 0 to 7 of parameter 0x108)
0x28	0x140 to 0x147 [► 87]	32 bytes	Physical fault counter, AS-i slave 0 to 15 (byte 0 corresponds to bit 0 to 7 of parameter 0x140)
0x29	0x148 to 0x14F [► 87]	32 bytes	Physical fault counter, AS-i slave 16 to 31 (byte 0 corresponds to bit 0 to 7 of parameter 0x148)
0x2A	0x150 to 0x157 [► 87]	32 bytes	Physical fault counter, AS-i slave 32 to 47 (byte 0 corresponds to bit 0 to 7 of parameter 0x150)
0x2B	0x158 to 0x15F [► 87]	32 bytes	Physical fault counter, AS-i slave 48 to 63 (byte 0 corresponds to bit 0 to 7 of parameter 0x158)
0x2C	0x160 to 0x167 [► 89]	32 bytes	Timeout counter, AS-i slave 0 to 15 (byte 0 corresponds to bit 0 to 7 of parameter 0x160)
0x2D	0x168 to 0x16F [► 89]	32 bytes	Timeout counter, AS-i slave 16 to 31 (byte 0 corresponds to bit 0 to 7 of parameter 0x168)
0x2E	0x170 to 0x177 [► 89]	32 bytes	Timeout counter, AS-i slave 32 to 47 (byte 0 corresponds to bit 0 to 7 of parameter 0x170)
0x2F	0x178 to 0x17F [► 89]	32 bytes	Timeout counter, AS-i slave 48 to 4F (byte 0 corresponds to bit 0 to 7 of parameter 0x178)
0x30	0x180 to 0x187 [► 90]	32 bytes	Response counter, AS-i slave 0 to 15 (byte 0 corresponds to bit 0 to 7 of parameter 0x180)
0x31	0x188 to 0x18F [► 90]	32 bytes	Response counter, AS-i slave 16 to 31 (byte 0 corresponds to bit 0 to 7 of parameter 0x188)
0x32	0x190 to 0x197 [► 90]	32 bytes	Response counter, AS-i slave 32 to 47 (byte 0 corresponds to bit 0 to 7 of parameter 0x190)
0x33	0x198 to 0x19F [► 90]	32 bytes	Response counter, AS-i slave 48 to 63 (byte 0 corresponds to bit 0 to 7 of parameter 0x198)
0x34	0x1A0 to 0x1A7 [► 91]	32 bytes	Leave DataExch counter, AS-i slave 0 to 15 (byte 0 corresponds to bit 0 to 7 of parameter 0x1A0)
0x35	0x1A8 to 0x1AF [► 91]	32 bytes	Leave DataExch counter, AS-i slave 16 to 31 (byte 0 corresponds to bit 0 to 7 of parameter 0x1A8)
0x36	0x1B0 to 0x1B7 [► 91]	32 bytes	Leave DataExch counter, AS-i slave 32 to 47 (byte 0 corresponds to bit 0 to 7 of parameter 0x1B0)
0x37	0x1B8 to 0x1BF [► 91]	32 bytes	Leave DataExch counter, AS-i slave 48 to 63 (byte 0 corresponds to bit 0 to 7 of parameter 0x1B8)
0x38	0x1C0 to 0x1C7 [► 92]	32 bytes	DataExch failed counter, AS-i slave 0 to 15 (byte 0 corresponds to bit 0 to 7 of parameter 0x1C0)
0x39	0x1C8 to 0x1CF [► 92]	32 bytes	DataExch failed counter, AS-i slave 16 to 31 (byte 0 corresponds to bit 0 to 7 of parameter 0x1C8)

Index	AS-i parameters	Length	Description
0x3A	0x1D0 to 0x1D7 [► 92]	32 bytes	DataExch failed counter, AS-i slave 32 to 47 (byte 0 corresponds to bit 0 to 7 of parameter 0x1D0)
0x3B	0x1D8 to 0x1DF [► 92]	32 bytes	DataExch failed counter, AS-i slave 48 to 63 (byte 0 corresponds to bit 0 to 7 of parameter 0x1D8)
0x40	0x200 to 0x207 [► 94]	32 bytes	16 empty bytes and output data of AS-i analog slave 1 (byte 0 corresponds to bit 0 to 7 of parameter 0x200)
0x41	0x208 to 0x20F [► 94]	32 bytes	Output data, AS-i analog slaves 1 and 2 (byte 0 corresponds to bit 0 to 7 of parameter 0x208)
...
0x4F	0x278 to 0x27F [► 94]	32 bytes	Output data, AS-i analog slaves 30 and 31 (byte 0 corresponds to bit 0 to 7 of parameter 0x278)
0x60	0x300 [► 94]	4 bytes	Cycle times (byte 0 corresponds to bit 0 to 7 of parameter 0x300)
0x62	0x310 [► 94]	8 bytes	Statistics (byte 0 corresponds to bit 0 to 7 of parameter 0x310)
0x64	0x320 to 0x327 [► 95]	32 bytes	Timeout statistics, AS-i slave 0 to 31 (byte 0 corresponds to bit 0 to 7 of parameter 0x320)
0x65	0x328 to 0x32F [► 95]	32 bytes	Timeout statistics, AS-i slave 32 to 63 (byte 0 corresponds to bit 0 to 7 of parameter 0x328)
0x68	0x340 to 0x347 [► 96]	32 bytes	Data exchange repeat counter, AS-i slave 0 to 15 (byte 0 corresponds to bit 0 to 7 of parameter 0x340)
0x69	0x348 to 0x34F [► 96]	32 bytes	Data exchange repeat counter, AS-i slave 16 to 31 (byte 0 corresponds to bit 0 to 7 of parameter 0x348)
0x6A	0x350 to 0x357 [► 96]	32 bytes	Data exchange repeat counter, AS-i slave 32 to 47 (byte 0 corresponds to bit 0 to 7 of parameter 0x350)
0x6B	0x358 to 0x35F [► 96]	32 bytes	Data exchange repeat counter, AS-i slave 48 to 63 (byte 0 corresponds to bit 0 to 7 of parameter 0x358)

see [map-
ping table
\[► 100\]](#)

6.2 KL6201/KL6211 at CANopen couplers

Chapter overview

This chapter comprises the following sections:

- Selecting the size of the process image
- Mapping of the process data
 - 6-byte process image
 - 12-byte process image
 - 22-byte process image
 - 38-byte process image
- Accessing parameters

Selecting the size of the process image

The size of the process image of the AS-i master terminal can be set to 6, 12, 22 or 38 bytes. This can be done with the KS2000 configuration software or via the fieldbus. To this end, parameter 0x20 has to be modified via the parameter data block (see AS-i parameter [0x20 \[► 67\]](#)). The Bus Coupler must then be reset, after which it starts with the last selected process image size.

● Process Images

i If the 22-byte or 38-byte process image is to be used under CANopen, the Bus Coupler may require a particular firmware version (see chapter [Firmware version \[► 116\]](#) of the Bus Coupler). The delivered firmware version is shown on the back of the Bus Coupler (see example below). If required, the firmware can be updated via the serial interface (KS2000 cable required) or via CANopen (using the FC5101 fieldbus card, if firmware version C2 is already loaded on the Bus Coupler).

The current firmware versions and the program for the firmware update can be found at <http://www.beckhoff.de>. BK5120 devices with KL6201/KL6211 are supported in TwinCAT from version 2.8 (build 739).



Fig. 32: Specification of the firmware version of the BK5120 CANopen coupler

Mapping of the process data

Like for the CANopen Bus Couplers, the process image of the KL6201/KL6211 is mapped to several 8-byte data objects. The 8-byte data objects are located in the CANopen object directory at index 0x3000 (input data) or index 0x3100 (output data). The coupler automatically maps these objects to the first free PDO (from PDO3) during start-up.

6-byte process image

Parameter data block

The 6-byte process image only consists of the parameter data block, supplemented by 2 dummy bytes. This block is located at index 0x3000 and is fully mapped into a PDO.

In contrast to the other process images, the 6-byte process image does not support direct access to the process data of the AS-i slaves. The process data access must take place via the AS-i parameters [0x80 to 0x87](#) [[▶ 73](#)] (digital slaves) or [0x204 to 0x27F](#) [[▶ 94](#)] (analog slaves).

The TxPDO (KL6201/KL6211 -> PLC) with the input data (index 0x3000) has following structure:

Parameter data block [▶ 50]						Dummy bytes	
Byte 0	Byte 1	Byte 2	Byte 3	Byte 4	Byte 5	Byte 6	Byte 7
SB0	SB1	Para In 0	Para In 1	Para In 2	Para In 3	reserved	reserved

The RxPDO (PLC -> KL6201/KL6211) with the output data (index 0x3100) has following structure:

Parameter data block [▶ 50]						Dummy bytes	
Byte 0	Byte 1	Byte 2	Byte 3	Byte 4	Byte 5	Byte 6	Byte 7
CB0	CB1	Para Out 0	Para Out 1	Para Out 2	Para Out 3	reserved	reserved

Key

- SB n: status byte n
- CB n: control byte n
- Para Out n: Output parameter, byte n
- Para In n: Input parameter, byte n

12-byte process image

Parameter data block

The first 8-byte object contains the parameter data block, complemented by 2 dummy bytes. This block is located at index 0x3000 and is fully mapped into a PDO.

The TxPDO (KL6201/KL6211 -> PLC) with the input data (index 0x3000) has following structure:

Parameter data block [▶ 50]						Dummy bytes	
Byte 0	Byte 1	Byte 2	Byte 3	Byte 4	Byte 5	Byte 6	Byte 7
SB0	SB1	Para In 0	Para In 1	Para In 2	Para In 3	reserved	reserved

The RxPDO (PLC -> KL6201/KL6211) with the output data (index 0x3100) has following structure:

Parameter data block [▶ 50]						Dummy bytes	
Byte 0	Byte 1	Byte 2	Byte 3	Byte 4	Byte 5	Byte 6	Byte 7
CB0	CB1	Para Out 0	Para Out 1	Para Out 2	Para Out 3	reserved	reserved

Key

- SB n: status byte n
- CB n: control byte n
- Para Out n: Output parameter, byte n
- Para In n: Input parameter, byte n

Process data block

The next 8-byte object contains the [process data block](#) [[▶ 52](#)] with AS-i status nibble (ASI SN) and the AS-i input data. The next TxPDO (KL6201/KL6211 -> PLC) therefore has the following content:

Process data block						Dummy bytes	
Byte 0	Byte 1	Byte 2	Byte 3	Byte 4	Byte 5	Byte 6	Byte 7
ASiSN + ASiIn Slave 1	ASiIn Slave 2+3	ASiIn Slave 4+5	ASiIn Slave 6+7	ASiIn Slave 8+9	ASiIn Slave 10+11	reserved	reserved

The next RxPDO (PLC -> KL6201/KL6211) contains the AS-i command nibble (ASi CN) and the AS-i output data:

Process data block						Dummy bytes	
Byte 0	Byte 1	Byte 2	Byte 3	Byte 4	Byte 5	Byte 6	Byte 7
ASiCN + ASiOut Slave 1	ASiOut Slave 2+3	ASiOut Slave 4+5	ASiOut Slave 6+7	ASiOut Slave 8+9	ASiOut Slave 10+11	reserved	reserved

Key

- ASiSN: AS-i status nibble
- ASi CN: AS-i command nibble
- ASiIn Slave x+y: Input data of the AS-i slaves x and y (one nibble per slave)
- ASiOut Slave x+y: Output data of the AS-i slaves x and y (one nibble per slave)

For the 12-byte process image, the AS-i data are therefore mapped to the CANopen process data objects (PDOs) as follows:

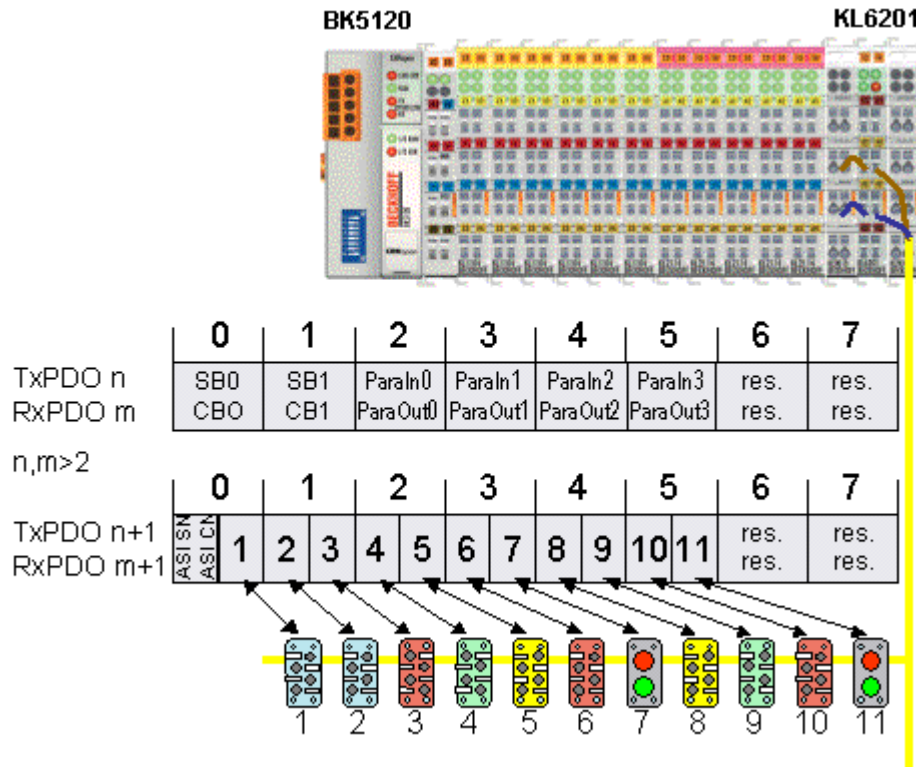

Fig. 33: Mapping of the AS-i data to the CANopen process data objects for the 12-byte process image

22-byte process image

Parameter data block

See 12-byte process image.

Process data block

If the 22-byte process image was selected (AS-i slave addresses > 11 in use), dummy bytes are used for further process data (slave addresses 12 to 31). Furthermore, one further 8-byte object with process data is created for the slaves from 16 to 31 in index 0x3000 or 0x3100 and mapped into the next free PDO.

Process data block							
Byte 0	Byte 1	Byte 2	Byte 3	Byte 4	Byte 5	...	Byte 15
ASiSN + ASiIn Slave 1	ASiIn Slave 2+3	ASiIn Slave 4+5	ASiIn Slave 6+7	ASiIn Slave 8+9	ASiIn Slave 10+11	...	ASiIn Slave 30+31

The next RxPDO (PLC -> KL6201/KL6211) contains the AS-i command nibble (ASi CN) and the AS-i output data:

Process data block							
Byte 0	Byte 1	Byte 2	Byte 3	Byte 4	Byte 5	...	Byte 15
ASiCN + ASi Out Slave 1	ASiOut Slave 2+3	ASiOut Slave 4+5	ASiOut Slave 6+7	ASiOut Slave 8+9	ASiOut Slave 10+11	...	ASiOut Slave 30+31

Key

See 12-byte process image.

Accordingly, in the 22-byte process image the AS-i data are mapped to the CANopen process data objects (PDO) as follows:

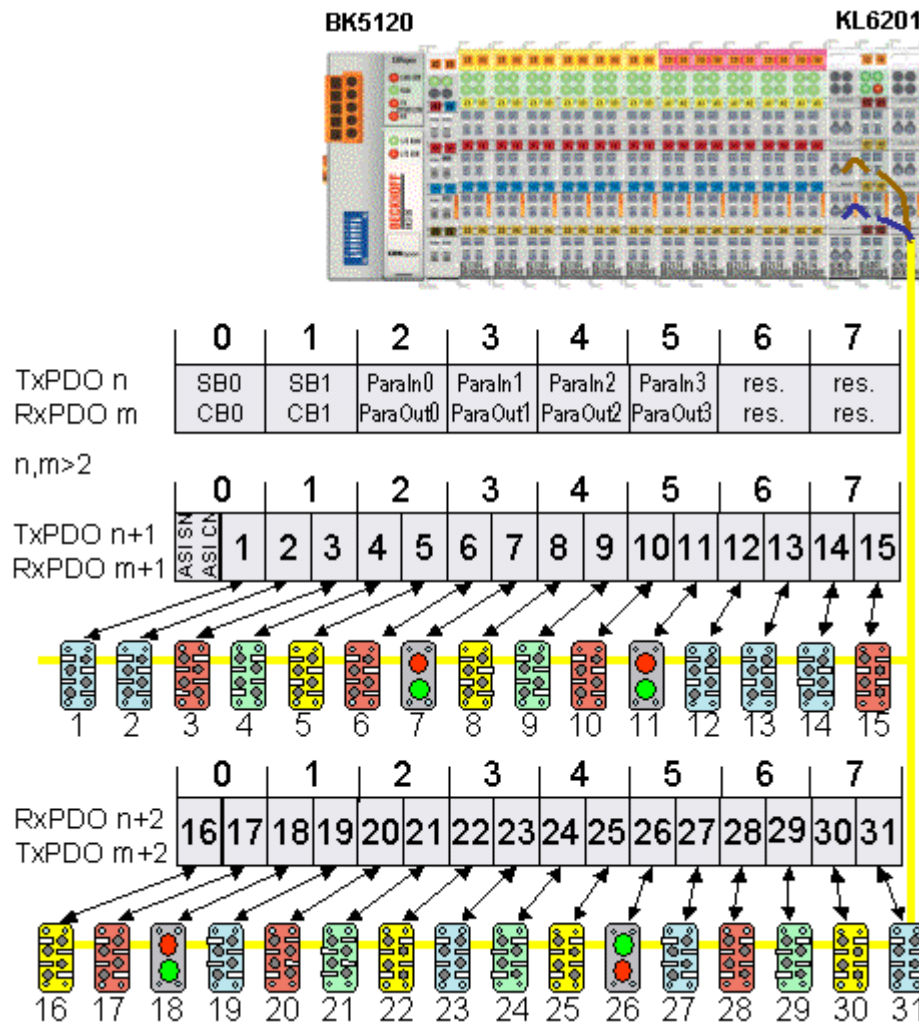

Fig. 34: Mapping of the AS-i data to the CANopen process data objects for the 22-byte process image

38-byte process image

Parameter data block

See 12-byte process image.

Process data block

If the 38-byte process image was selected (AS-i slave addresses > 32 are used), a further 8-byte object with process data for AS-i slaves 33 to 63 is created in index 0x3000 or 0x3100 and mapped to the next free PDO.

Mapping of the AS-i data for slave addresses greater than 32 to the additional CANopen PDO for the 38-byte process image looks as follows (PDO n, PDO n+1, PDO n+2 as for the 22-byte process image):

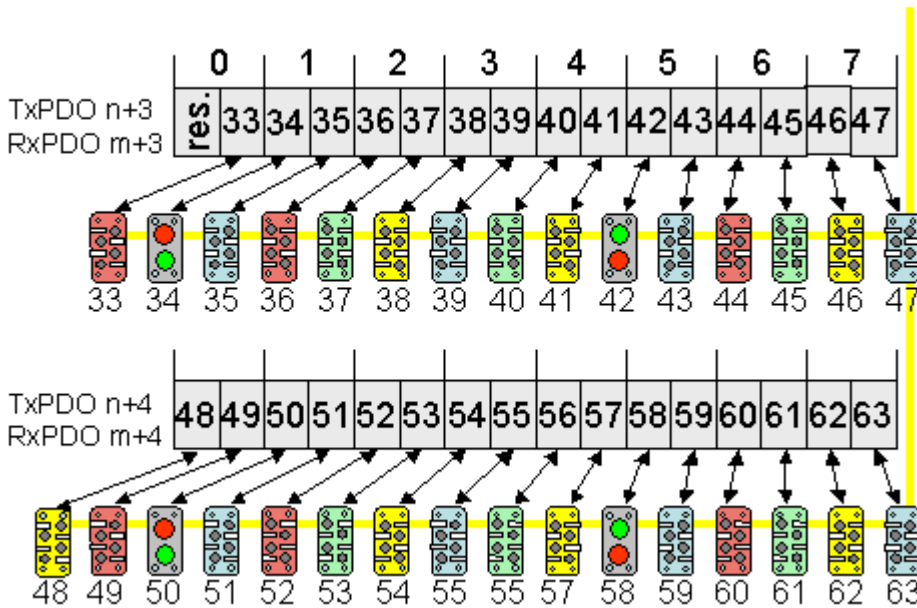

Fig. 35: Mapping of the AS-i data to the CANopen process data objects for the 38-byte process image

Mapping example

A BK5120 (Bus Coupler for CANopen) has

- 78 digital inputs and 48 digital outputs
- 6 analog inputs and 4 analog outputs
- a KL5001 (SSI encoder interface: 4 byte inputs by default)
- a KL6001 (serial interface: 4 byte inputs and 4 byte outputs by default)
- a KL5111 (incremental encoder interface) (6-byte inputs and 6-byte outputs)
- A KL6201/KL6211 AS-i master terminal with default setting (22-byte process image)

PDO	Data contents (mapping)	Object directory	PDO	Data contents (mapping)	Object directory
RxPDO1	5-byte digital outputs 1..48	0x6200, SI 1...5	TxPDO1	8-byte digital inputs 1...64	0x6000, SI 1...8
RxPDO2	8-byte analog outputs 1..4	0x6411, SI 1...4	TxPDO2	4-byte analog inputs 1...4	0x6401, SI 1...4
RxPDO3	4-byte serial interface	0x2900, SI 1	TxPDO3	2-byte digital inputs 65...78	0x6000, SI 9...10
RxPDO4	6-byte encoder outputs	0x2D00, SI 1	TxPDO4	analog inputs 5 and 6	0x6401, SI 5..6
RxPDO5	8-byte AS-i master 1: parameter data block	0x3100, SI 1	TxPDO5	8 bytes: 4-byte SSI and 4-byte serial interface	0x2800, SI 1...2
RxPDO6	8-byte AS-i master 1: Process data block outputs ASi slave 1...15	0x3100, SI 2	TxPDO6	6 bytes encoder input	0x2C00, SI 1
RxPDO7	8-byte AS-i master 1: Process data block outputs AS-i slave 16...31	0x3100, SI 3	TxPDO7	8-byte AS-i master 1: parameter data block	0x3000, SI 1
			TxPDO8	8-byte AS-i master 1: Process data block inputs AS-i slave 1...15	0x3000, SI 2
			TxPDO9	8-byte AS-i master 1: Process data block inputs AS-i slave 16...31	0x3000, SI 3

Access to the parameters of the KL6201/KL6211

The KL6201/KL6211 parameters [▶ 67] are accessible via the parameter data block in the first receive process data object (RxPDO) and transmit process data object (TxPDO).

General examples for parameter access can be found in Chapter [Access to AS-i parameters \[▶ 98\]](#).

6.3 Firmware version of the Bus Couplers

● Required firmware

i A particular firmware version may be required for operating the KL6201/KL6211 AS-i master terminals on the Bus Coupler / Bus Terminal Controller (see table below).

In delivery state the KL6201/KL6211 is set to a process image of 12 bytes. Most Bus Couplers and Bus Terminal Controllers listed in the table support the 6-byte and 12-byte process images.

Bus Couplers / Bus Terminal Controllers that are not listed

- require a terminal firmware version from B7 for operating the 6-byte or 12-byte process image on the KL6201/KL6211;
- are not yet prepared for operating the 22-byte or 38-byte process image.

The delivered firmware version is shown on the back of the Bus Coupler (see example below for CANopen).



Fig. 36: Specification of the firmware version on a Bus Coupler

If required, the firmware can be updated via the serial interface (KS2000 cable required) or - depending on the bus system - via the fieldbus. The current firmware versions and the program for the firmware update can be found on our home page at <http://www.beckhoff.de>.

Support of the different process images by the firmware versions of the Bus Couplers / Bus Terminals Controllers

Fieldbus system	Bus Coupler / Bus Terminal Controller	Firmware version required on the Bus Coupler / Bus Terminal Controller for the			
		6-byte process image (no direct access to AS-i slaves)	12-byte process image (AS-i slave addresses 1 to 11)	22-byte process image (AS-i slave addresses 1 to 31)	38-byte process image (AS-i slave addresses 1 to 62)
EtherCAT	BK1120	These Bus Couplers and Bus Terminal Controller support the 6-byte and 12-byte process image of the KL6201/KL6211.		from 08 (B8)	from 08 (B8)
	BK1250			all	all
Lightbus	BK2020			from B1	in preparation
PROFIBUS	BK3120			from B9	from BB
	BK3150			all	all
	BK3500			from B9	from BB
	BK3520			from B9	from BB
	BC3100			from C3	from C4
	BC3150			all	all
	BX3100			all	all
Interbus	BK4020			from B0	in preparation
	BC4000			from B3	in preparation
CANopen	BK5120			from C4	from C5
	BK5150			all	all
	BC5150			all	all
	BX5100			all	all
DeviceNet	BK5220			(from B3)*	in preparation
	BC5250			all	all
	BX5200			all	all
ControlNet	BK7000			from BC	from BC
Modbus	BK7300			from B2	from B4
Fip IO	BK7420			from B1	from B1
RS485	BK8000			from C2	in preparation
RS232	BK8100			from C2	in preparation
	BC8150			all	all
	BX8000			all	all
Ethernet	BK9000			from B7	from BA
	BK9100			from B1	from B1
	BC9000	from B9	from BB		
	BC9100	from B1	from B1		
	BC9050	all	all		
	BX9000	all	all		
PROFINET	BK9103	in preparation	in preparation	in preparation	
EtherNet/IP	BK9105	all	all	all	
USB	BK9500	This Bus Coupler supports the 6-byte and 12-byte process image of the KL6201/KL6211.	(from B1)*	in preparation	

*) only if the Bus Coupler is set to *complete mapping of the Bus Terminals* (e.g. via the KS2000 configuration software). On delivery, these Bus Couplers are set to *compact mapping of the Bus Terminals*.

7 Diagnostics

7.1 LEDs

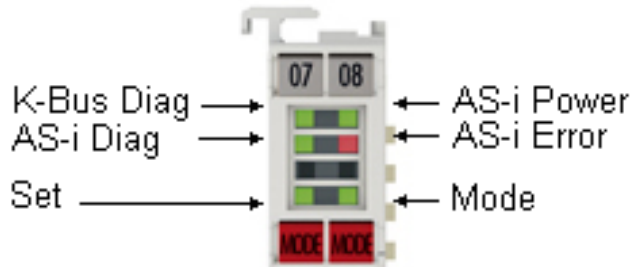

Fig. 37: LEDs

LED indicators - meanings

LED	Position	Color	Meaning
K-bus diag	1st LED left	green	This LED comes on during each K-bus cycle. During regular operation, it therefore flashes.
AS-i Diag	2nd LED left	green	This LED is on during the AS-i data exchange phase. During regular operation, it therefore flashes.
-	3rd LED left	green	reserved
Set	4th LED left	green	This LED is on as long as both set inputs are short-circuited.
AS-i Power	1st LED right	green	This LED is on as long as the AS-i power supply is connected and at least one AS-i slave was found.
AS-i Error	2nd LED right	red	This LED flashes in (<u>protected mode</u> [▶ 11]), if set and actual configuration do not match. Possible causes: <ul style="list-style-type: none"> AS-i ID code of one or several slaves does not match the currently projected values. The AS-i I/O code of one or several slaves does not match the currently projected values. The currently projected AS-i slave was not found.
-	3rd LED right	green	reserved
Mode	4th LED right	green	This LED is on as long as the two mode inputs are short-circuited.

8 Appendix

8.1 Support and Service

Beckhoff and their partners around the world offer comprehensive support and service, making available fast and competent assistance with all questions related to Beckhoff products and system solutions.

Beckhoff's branch offices and representatives

Please contact your Beckhoff branch office or representative for local support and service on Beckhoff products!

The addresses of Beckhoff's branch offices and representatives round the world can be found on her internet pages: <https://www.beckhoff.com>

You will also find further documentation for Beckhoff components there.

Beckhoff Support

Support offers you comprehensive technical assistance, helping you not only with the application of individual Beckhoff products, but also with other, wide-ranging services:

- support
- design, programming and commissioning of complex automation systems
- and extensive training program for Beckhoff system components

Hotline: +49 5246 963 157
Fax: +49 5246 963 9157
e-mail: support@beckhoff.com

Beckhoff Service

The Beckhoff Service Center supports you in all matters of after-sales service:

- on-site service
- repair service
- spare parts service
- hotline service

Hotline: +49 5246 963 460
Fax: +49 5246 963 479
e-mail: service@beckhoff.com

Beckhoff Headquarters

Beckhoff Automation GmbH & Co. KG

Huelshorstweg 20
33415 Verl
Germany

Phone: +49 5246 963 0
Fax: +49 5246 963 198
e-mail: info@beckhoff.com
web: <https://www.beckhoff.com>

Table of figures

Fig. 1	KL6201, KL6211	9
Fig. 2	Status machine overview	11
Fig. 3	Lists of the AS-i slaves in configuration and protected mode	12
Fig. 4	KL9528 - AS-i Power Supply Terminal	16
Fig. 5	KL9520 - AS-i potential feed terminal with filter	19
Fig. 6	Spring contacts of the Beckhoff I/O components.....	21
Fig. 7	Attaching on mounting rail	22
Fig. 8	Disassembling of terminal.....	23
Fig. 9	Power contact on left side.....	24
Fig. 10	Recommended distances for standard installation position	25
Fig. 11	Other installation positions	26
Fig. 12	Standard wiring.....	27
Fig. 13	Pluggable wiring	27
Fig. 14	High Density Terminals.....	28
Fig. 15	Connecting a cable on a terminal point	29
Fig. 16	Connection of the AS interface	30
Fig. 17	Wiring of the AS interface	31
Fig. 18	KS2000 configuration software.....	35
Fig. 19	Display of the fieldbus station in KS2000	37
Fig. 20	KS2000 branches for channel 1 of the KL6201	37
Fig. 21	Register view in KS2000.....	38
Fig. 22	Settings for the KL6201 in the KS2000 configuration software	39
Fig. 23	KS2000 - AS-i settings.....	40
Fig. 24	KS2000 - AS-i system overview	42
Fig. 25	KS2000 - AS-i slave parameters	43
Fig. 26	KS2000 - Process data.....	45
Fig. 27	KS2000 - Process data chart.....	45
Fig. 28	KS2000 - Current value of process data.....	45
Fig. 29	KS2000 - Output values.....	46
Fig. 30	KS2000 - Selecting the display format for process data.....	46
Fig. 31	Specification of the firmware version of the BK3120 PROFIBUS coupler	104
Fig. 32	Specification of the firmware version of the BK5120 CANopen coupler.....	110
Fig. 33	Mapping of the AS-i data to the CANopen process data objects for the 12-byte process image	112
Fig. 34	Mapping of the AS-i data to the CANopen process data objects for the 22-byte process image	113
Fig. 35	Mapping of the AS-i data to the CANopen process data objects for the 38-byte process image	114
Fig. 36	Specification of the firmware version on a Bus Coupler	116
Fig. 37	LEDs	118

More Information:
www.beckhoff.com/KL6201

Beckhoff Automation GmbH & Co. KG
Hülshorstweg 20
33415 Verl
Germany
Phone: +49 5246 9630
info@beckhoff.com
www.beckhoff.com

