

Documentation | EN

KM3701, KM3702, KM3712

Pressure Measuring Module

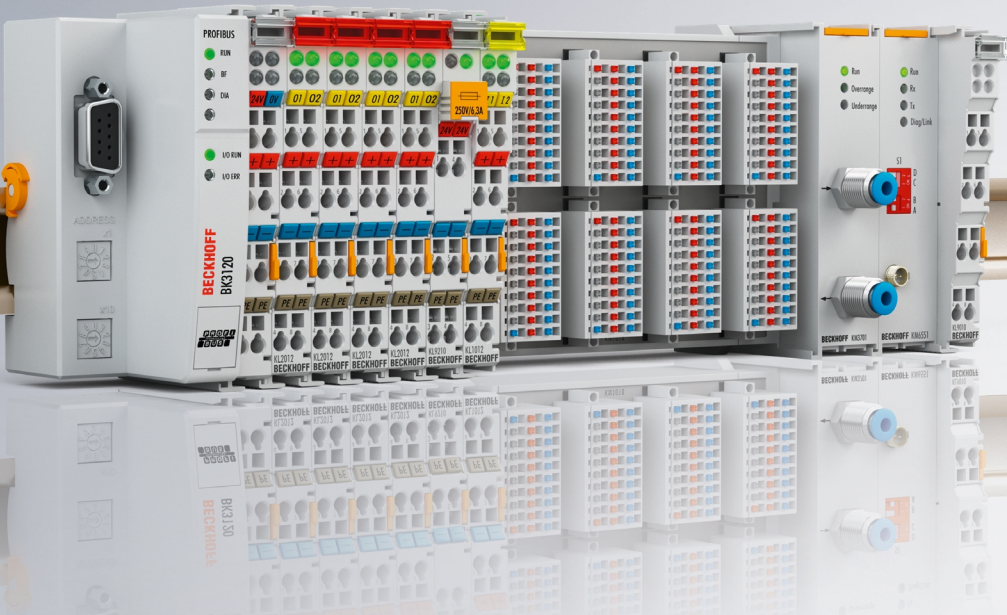

Table of contents

1 Foreword	5
1.1 Notes on the documentation	5
1.2 Safety instructions	6
1.3 Documentation issue status	7
2 Product overview	8
2.1 KM3701 - Introduction	8
2.2 KM3702 - Introduction	9
2.3 KM3712 - Introduction	10
2.4 Technical data	11
2.5 LED displays	12
2.6 Basic function principles.....	13
3 Mounting and wiring	15
3.1 Instructions for ESD protection	15
3.2 Mounting and demounting - top front unlocking	16
3.3 Disposal	17
3.4 Connection	17
4 Application examples	18
4.1 KM3701 - Application examples.....	18
4.2 KM3702 - Application example	20
4.3 KM3712 - Application example	21
5 KS2000 Configuration software	22
5.1 KS2000 - Introduction	22
5.2 Parameterization with KS2000	23
5.3 Register	25
5.4 Process Data.....	26
6 Data structures	28
6.1 KM3701 - Process image	28
6.2 KM3702, KM3712 - Process image	28
6.3 Control and Status Byte	29
6.3.1 Process data mode	29
6.3.2 Register communication.....	30
6.4 Register overview.....	31
6.5 Register description	32
6.6 Examples of Register Communication	35
6.6.1 Example 1: Reading the firmware version from register 9	35
6.6.2 Example 2: Writing to an user register	35
7 Appendix	39
7.1 Support and Service.....	39

1 Foreword

1.1 Notes on the documentation

Intended audience

This description is only intended for the use of trained specialists in control and automation engineering who are familiar with the applicable national standards.

It is essential that the documentation and the following notes and explanations are followed when installing and commissioning these components.

The qualified personnel is obliged to always use the currently valid documentation.

The responsible staff must ensure that the application or use of the products described satisfy all the requirements for safety, including all the relevant laws, regulations, guidelines and standards.

Disclaimer

The documentation has been prepared with care. The products described are, however, constantly under development.

We reserve the right to revise and change the documentation at any time and without prior announcement.

No claims for the modification of products that have already been supplied may be made on the basis of the data, diagrams and descriptions in this documentation.

Trademarks

Beckhoff®, TwinCAT®, TwinCAT/BSD®, TC/BSD®, EtherCAT®, EtherCAT G®, EtherCAT G10®, EtherCAT P®, Safety over EtherCAT®, TwinSAFE®, XFC®, XTS® and XPlanar® are registered trademarks of and licensed by Beckhoff Automation GmbH. Other designations used in this publication may be trademarks whose use by third parties for their own purposes could violate the rights of the owners.

Patent Pending

The EtherCAT Technology is covered, including but not limited to the following patent applications and patents: EP1590927, EP1789857, EP1456722, EP2137893, DE102015105702 with corresponding applications or registrations in various other countries.



EtherCAT® is registered trademark and patented technology, licensed by Beckhoff Automation GmbH, Germany.

Copyright

© Beckhoff Automation GmbH & Co. KG, Germany.

The reproduction, distribution and utilization of this document as well as the communication of its contents to others without express authorization are prohibited.

Offenders will be held liable for the payment of damages. All rights reserved in the event of the grant of a patent, utility model or design.

1.2 Safety instructions

Safety regulations

Please note the following safety instructions and explanations!
Product-specific safety instructions can be found on following pages or in the areas mounting, wiring, commissioning etc.

Exclusion of liability

All the components are supplied in particular hardware and software configurations appropriate for the application. Modifications to hardware or software configurations other than those described in the documentation are not permitted, and nullify the liability of Beckhoff Automation GmbH & Co. KG.

Personnel qualification

This description is only intended for trained specialists in control, automation and drive engineering who are familiar with the applicable national standards.

Signal words

The signal words used in the documentation are classified below. In order to prevent injury and damage to persons and property, read and follow the safety and warning notices.

Personal injury warnings

⚠ DANGER

Hazard with high risk of death or serious injury.

⚠ WARNING

Hazard with medium risk of death or serious injury.

⚠ CAUTION

There is a low-risk hazard that could result in medium or minor injury.

Warning of damage to property or environment

NOTICE

The environment, equipment, or data may be damaged.

Information on handling the product



This information includes, for example:
recommendations for action, assistance or further information on the product.

1.3 Documentation issue status

Version	Comment
2.2.0	<ul style="list-style-type: none"> Chapter "Recommended mounting rails" removed Chapter "Instructions for ESD protection" added
2.1.0	<ul style="list-style-type: none"> Chapter "Technical data" updated Document structure updated Chapter "Disposal" added New title page Revision status updated
2.0.0	<ul style="list-style-type: none"> Corrections First public issue as PDF
1.2.0	<ul style="list-style-type: none"> Technical data updated Installation and wiring extended Process data corrected KM3701-0340 added
1.1.1	Application examples update
1.1.0	Technical data updated
1.0.0	First release

Firmware and hardware versions

Documentation Version	KM3701-0000, KM3701-0340		KM3702-0000		KM3712-0000	
	Firmware	Hardware	Firmware	Hardware	Firmware	Hardware
2.2.0	1G	11	1D	08	1E	10
2.1.0	1G	11	1D	08	1E	10
2.0.0	1G	09	1D	07	1E	09
1.2.0	1C	01	1B	01	1B	01
1.1.1	1C	00	1B	00	1B	00
1.1.0	1B	00	1A	00	1A	00
1.0.0	1B	00	1A	00	1A	00

The firmware and hardware versions (delivery state) can be taken from the serial number printed on the side of the terminal module.

Syntax of the serial number

Structure of the serial number: WW YY FF HH

WW - week of production (calendar week)

YY - year of production

FF - firmware version

HH - hardware version

Example with serial number 35 05 00 01:

35 - week of production 35

05 - year of production 2005

00 - firmware version 00

01 - hardware version 01

2 Product overview

2.1 KM3701 - Introduction

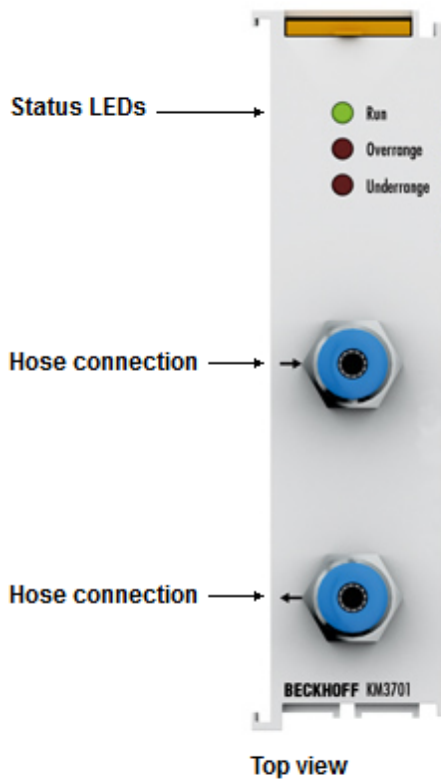

Fig. 1: KM3701

Single-channel differential pressure measuring module

The KM3701 differential pressure measuring module enables direct measurement of pressure differences between two hose connections. The pressure difference is available in the fieldbus with 16-bit resolution. The measuring range is between -100 hPa and +100 hPa (-100 mbar to +100 mbar). The status LEDs indicate proper function or errors such as range exceedance.

Two variants are available:

- KM3701-0000: Measuring range -100 to +100 hPa (-100 to +100 mbar)
- KM3701-0340: Measuring range -340 to +340 hPa (-340 to +340 mbar)

Quick links

- [Mounting and wiring \[▶ 15\]](#)
- [Access from the user program \[▶ 28\]](#)
- [Application examples \[▶ 18\]](#)

2.2 KM3702 - Introduction

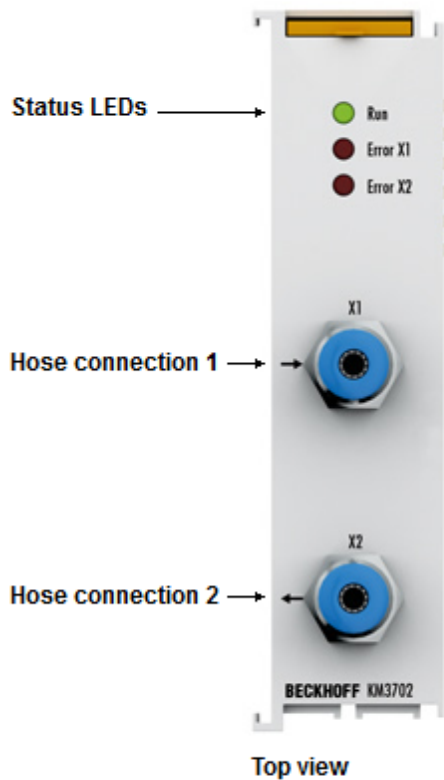

Fig. 2: KM3702

Two-channel relative pressure measuring module for 0 to 7500 hPa (0 to 7.5 bar)

The relative pressure measuring module KM3702 enables direct measurement of two pressure values at the hose connections. The pressure is determined as the difference to the environment of the KM3702 and is available in the fieldbus with 16 bit resolution. The status LEDs indicate proper function or errors such as range exceedance.

2.3 KM3712 - Introduction

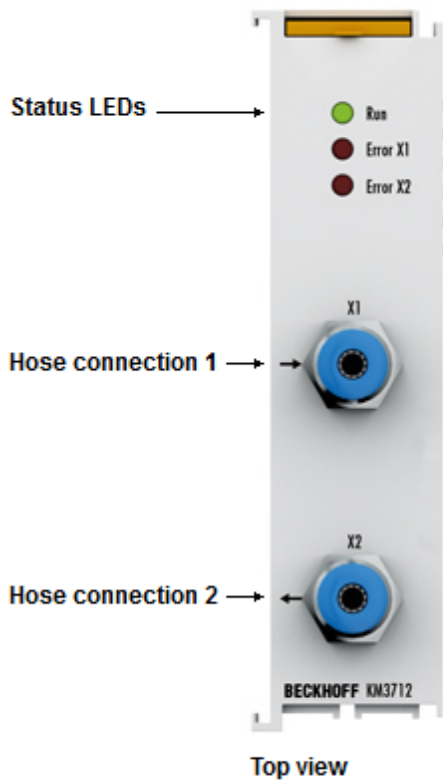

Fig. 3: KM3712

Dual channel relative pressure measuring module for -1,000 hPa to +1,000 hPa (-1 bar to +1 bar)

The relative pressure measuring module KM3712 allows the direct measurement of two negative pressure values on the hose connections. The pressure is determined as the difference to the environment of the KM3712 and is available in the fieldbus with 16 bit resolution. The status LEDs indicate proper function or errors such as range exceedance.

2.4 Technical data

Technical Data	KM3701-0000	KM3701-0340	KM3702-0000	KM3712-0000
Number of inputs	1 (differential pressure)		2	2
Measuring range	-100 to +100 hPa (-100 to +100 mbar)	-340 to +340 hPa (-340 to +340 mbar)	0 to 7500 hPa (0 to 7.5 bar)	-1000 to +1000 hPa (-1 to +1 bar)
Permissible overpressure	max. ±500 hPa differential max. +5000 hPa relative to ambient		+10000 hPa	+5000 hPa
permissible media	non-aggressive gases			
Resolution	0.1 hPa (0.1 mbar) per digit		1 hPa (1 mbar) per digit	1 hPa (1 mbar) per digit
Measuring accuracy	3% (of the full scale value)			
Measuring speed	typically 5 ms			
Pressure connectors	screwing plug [► 17] , M12 x 1			
Power supply for the electronics	via the K-bus			
Current consumption from the K-bus	typically 15 mA			
Width of a bus terminal block	Maximum 64 standard Bus Terminals or 80 cm (a KM37xx is equivalent to 2 standard Bus Terminals)			
Electrical isolation	500 V (K-bus/signal voltage)			
Bit width in the input process image	3 byte	3 byte	6 byte	6 byte
Bit width in the output process image	3 byte	3 byte	6 byte	6 byte
Dimensions without tubes (w x h x d)	approx. 26.5 mm x 100 mm x 69 mm (width aligned: 24 mm)			
Weight	approx. 100 g			
Permissible ambient temperature range during operation	0°C ... + 55°C			
Permissible ambient temperature range during storage	-25°C ... + 85°C			
Permissible relative air humidity	95 %, no condensation			
Mounting [► 16]	on a 35 mm mounting rail conforming to EN 60715			
Vibration / shock resistance	conforms to EN 60068-2-6 / EN 60068-2-27			
EMC immunity / emission	conforms to EN 61000-6-2 / EN 61000-6-4			
Protection class	IP20			
Installation position	variable			
Approvals / markings*	CE, UKCA, cULus, EAC			

*) Real applicable approvals/markings see type plate on the side (product marking).

2.5 LED displays

KM3701

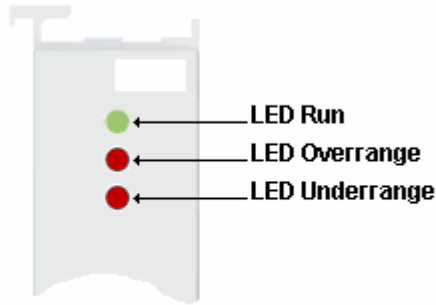

Fig. 4: KM3701 - LEDs

LED	Display	
Run (green)	off	Data transmission on the K-bus is not active
	on	Data transmission on the K-bus is active
Over-range (red)	on	The differential pressure is above the <u>permitted measuring range</u> [▶ 11]
Under-range (red)	on	The differential pressure is below the <u>permitted measuring range</u> [▶ 11]

KM3702, KM3712

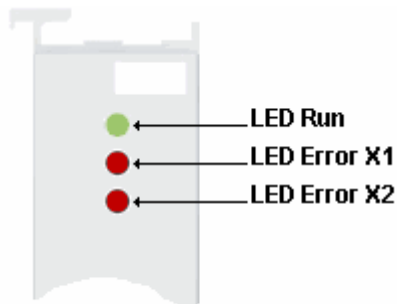

Fig. 5: KM3702, KM3712 - LEDs

LED	Display	
Run (green)	off	Data transmission on the K-bus is not active
	on	Data transmission on the K-bus is active
Error X1 (red)	on	The pressure at connection X1 is below (under-range) or above (over-range) the <u>permitted measuring range</u> [▶ 11]
Error X2 (red)	on	The pressure at connection X2 is below (under-range) or above (over-range) the <u>permitted measuring range</u> [▶ 11]

2.6 Basic function principles

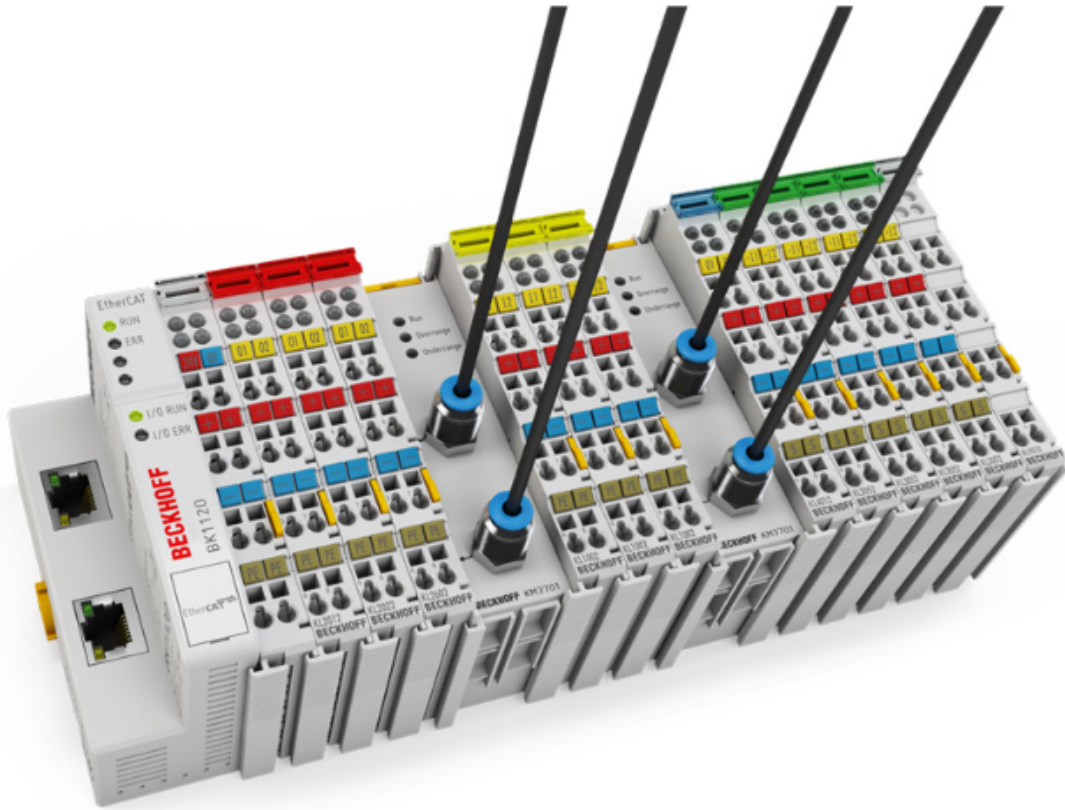

Fig. 6: Bus Terminal block with pressure measuring modules

The pressure measuring modules KM3701 and KM3712 directly record differential and relative pressures in non-aggressive gases. As in electronic signal acquisition the pressure measurement takes place via a terminal module. The pressure measuring modules convert the measured pressure into an electrical signal and make it available to the higher-level controller with a resolution of 16 bits. The measuring principle is based on the most up-to-date on-chip sensor technology. In addition to just measuring, the semiconductor also executes other functions, such as temperature compensation and avoidance of long-term drift. The status LEDs indicate proper function or errors such as range exceedance.

KM3701 single-channel differential pressure measuring module

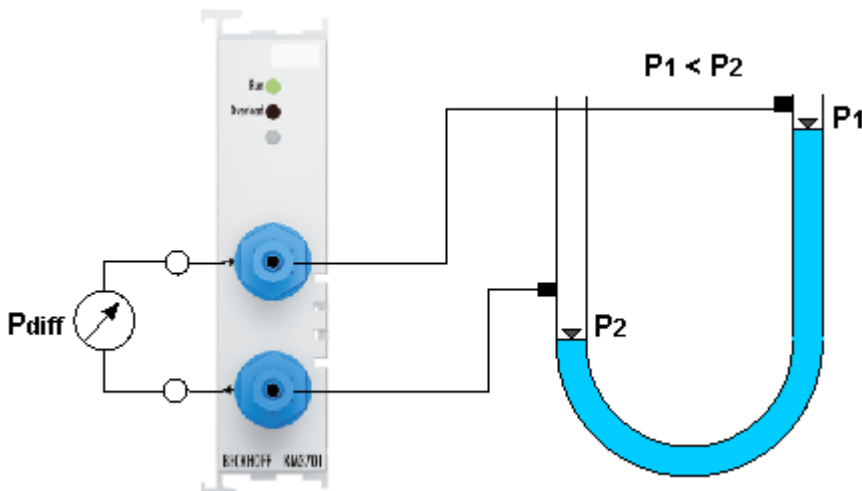

Fig. 7: KM3701 - Single-channel differential pressure measurement

The KM3701 terminal module can measure pressure differences between 0 and 100 hPa (0 and 100 mbar) between two hose connections. The differential pressure can be measured up to an ambient pressure of 7500 hPa (7 bar) between any points.

KM3702 - Two-channel relative pressure measuring module (0 hPa to 7500 hPa)

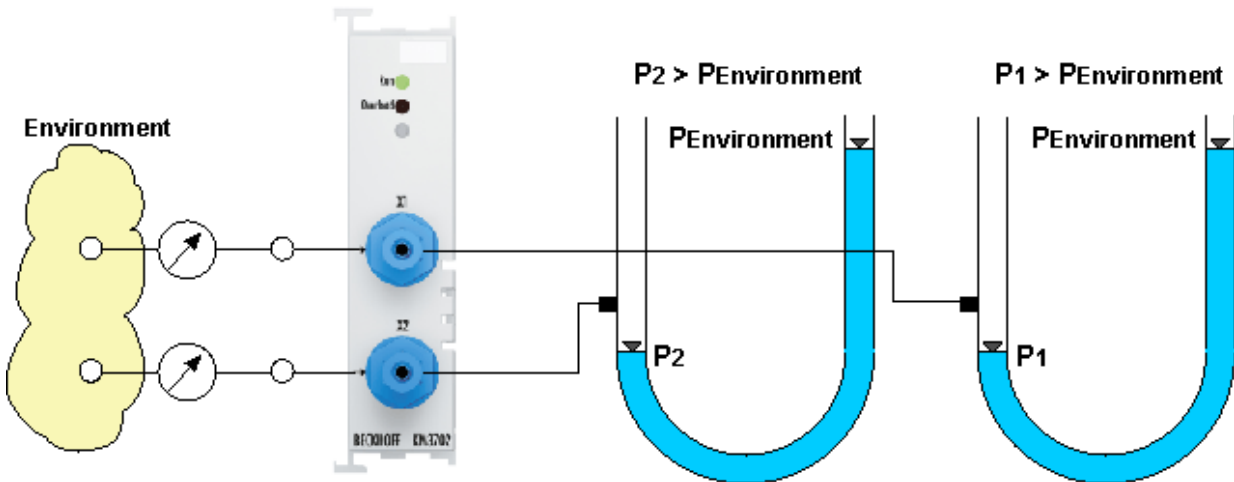

Fig. 8: KM3702 - Two-channel relative pressure measurement

The KM3702 terminal module can measure pressure values between 0 and 7000 hPa (0 and 7 bar) at each hose connection. Pressure measurement takes place relative to the actual current ambient pressure.

KM3712 - Two-channel relative pressure measuring module (-1000 hPa to +1000 hPa)

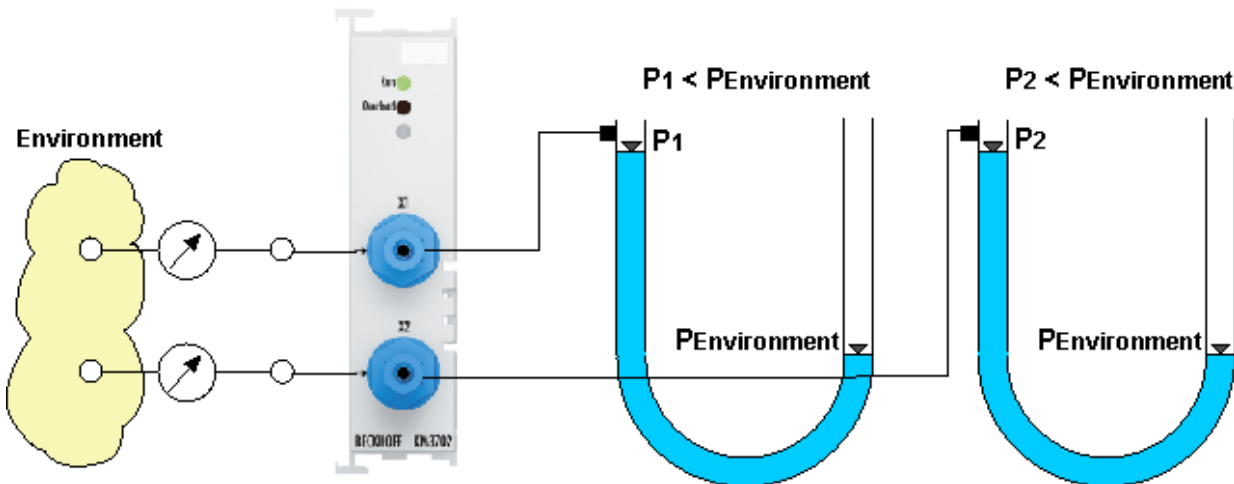

Fig. 9: KM3712 - Two-channel relative pressure measurement

The KM3712 terminal module can measure pressure values between -1000 hPa and +1000 hPa (-1 bar and +1 bar) at each hose connection. Pressure measurement takes place relative to the actual current ambient pressure.

Installation and connection technique

The pressure measuring terminal samples the pressure values directly. Additional measuring devices are unnecessary. This avoids connection systems and saves available space compared with the use of conventional measuring devices. The installation of the pressure measuring terminals is simple and fast and can be carried out without any additional mounting tools. The measuring hoses are connected directly to the quick couplings of the pressure measuring terminal. Standard commercial plastic hoses can be used as measuring hoses. In terms of connections and installation space the pressure measuring terminals are designed like a "normal" 24 mm Bus Terminal and can be installed with minimum space requirement directly in the Bus Terminal system.

3 Mounting and wiring

3.1 Instructions for ESD protection

NOTICE

Destruction of the devices by electrostatic discharge possible!

The devices contain components at risk from electrostatic discharge caused by improper handling.

- Please ensure you are electrostatically discharged and avoid touching the spring contacts (see fig.) of the device directly.
- Avoid contact with highly insulating materials (synthetic fibers, plastic film etc.).
- Surroundings (working place, packaging and personnel) should be grounded probably, when handling with the devices.
- Each assembly must be terminated at the right hand end with a KL9010 bus end terminal, to ensure the protection class and ESD protection.

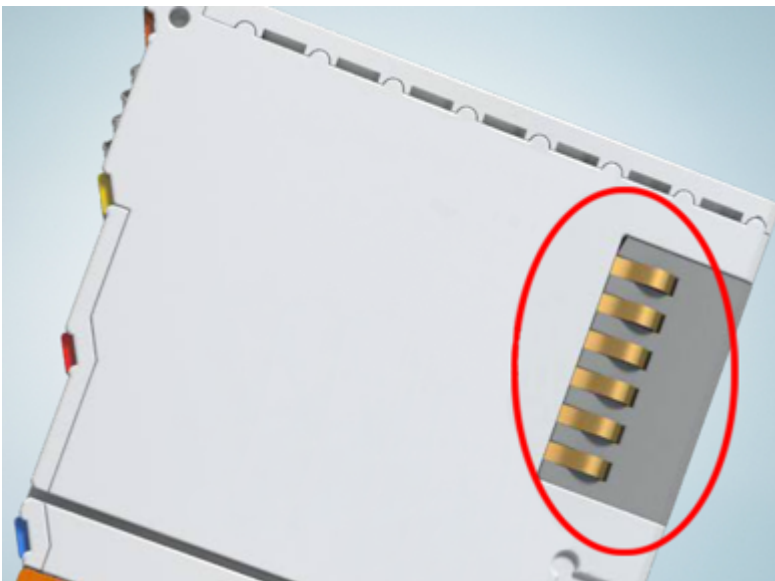

Fig. 10: Spring contacts of the Beckhoff I/O components

3.2 Mounting and demounting - top front unlocking

The terminal modules are fastened to the assembly surface with the aid of a 35 mm mounting rail (e. g. mounting rail TH 35-15).

● Fixing of mounting rails

i The locking mechanism of the terminals and couplers extends to the profile of the mounting rail. At the installation, the locking mechanism of the components must not come into conflict with the fixing bolts of the mounting rail. To mount the recommended mounting rails under the terminals and couplers, you should use flat mounting connections (e.g. countersunk screws or blind rivets).

⚠ WARNING

Risk of electric shock and damage of device!

Bring the bus terminal system into a safe, powered down state before starting installation, disassembly or wiring of the Bus Terminals!

Mounting

- Fit the mounting rail to the planned assembly location.

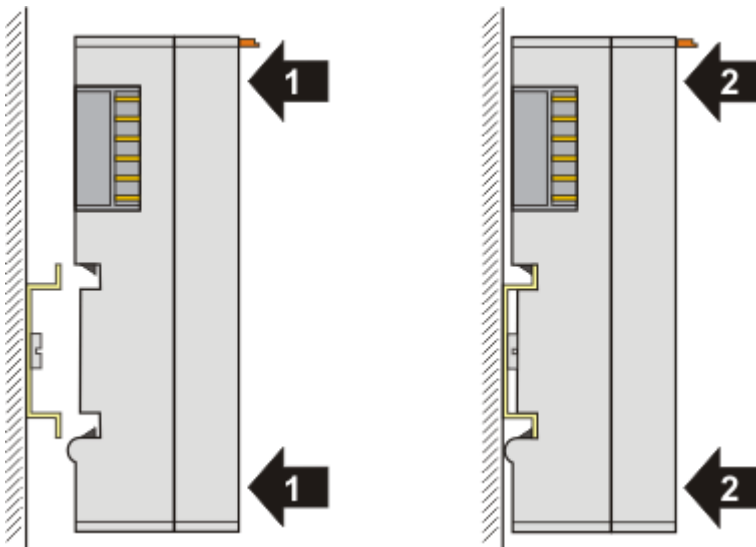

and press (1) the terminal module against the mounting rail until it latches in place on the mounting rail (2).

- Attach the cables.

Demounting

- Remove all the cables.
- Lever the unlatching hook back with thumb and forefinger (3). An internal mechanism pulls the two latching lugs (3a) from the top hat rail back into the terminal module.

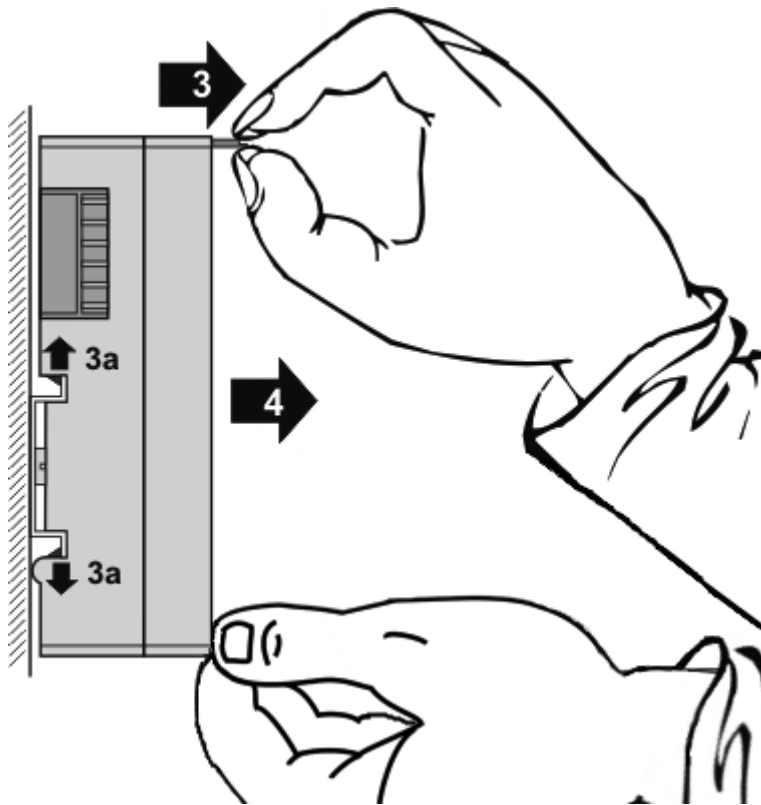

- Pull (4) the terminal module away from the mounting surface. Avoid canting of the module; you should stabilize the module with the other hand, if required.

3.3 Disposal



Products marked with a crossed-out wheeled bin shall not be discarded with the normal waste stream. The device is considered as waste electrical and electronic equipment. The national regulations for the disposal of waste electrical and electronic equipment must be observed.

3.4 Connection

The air hoses are connected to push-in fittings.

Technical Data	Threaded push-in fitting
Type	QSS-4-F
Outer hose diameter	4 mm
Nominal diameter	2.6 mm
Thread	M12 x 1
Width across flats	14 mm

4 Application examples

The pressure measuring modules can be used in any applications requiring logging and monitoring of differential and dynamic pressures in non-aggressive gases, e.g. pressure vessels, pressure cabins or pneumatic, filter, suction, packaging and positioning systems.

They measure operating pressures, monitor filters and sieves, check the seal tightness of tanks and assist in position testing of construction elements or monitoring the level of liquids. If flow rates are calculated from the measured pressures, then the pressure measuring terminals can also be used for flow measurement. They can therefore be applied in areas such as process engineering, systems engineering, building services and heating, ventilating and air conditioning.

- Application examples for [KM3701](#) [[▶ 18](#)]
- Application example for [KM3702](#) [[▶ 20](#)]
- Application example for [KM3712](#) [[▶ 21](#)]

4.1 KM3701 - Application examples

⚠ WARNING

Risk of injury through electric shock and damage to the device!

Bring the Bus Terminals system into a safe, de-energized state before starting mounting, disassembly or wiring of the Bus Terminals!

Tank systems

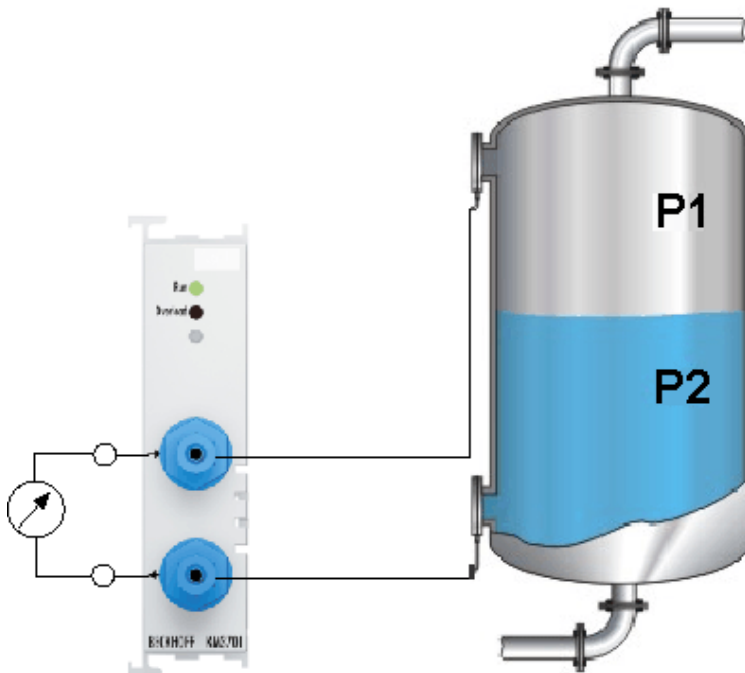

Fig. 11: KM3701 - Application example for the fill level of tanks

- Monitors tank filling levels and activates topping up when the level falls below a defined filling value
- The pressure difference is an indicator for the filling level
- No additional pressure gauges, switches and associated connection equipment are required

Filter systems, pipe constrictions

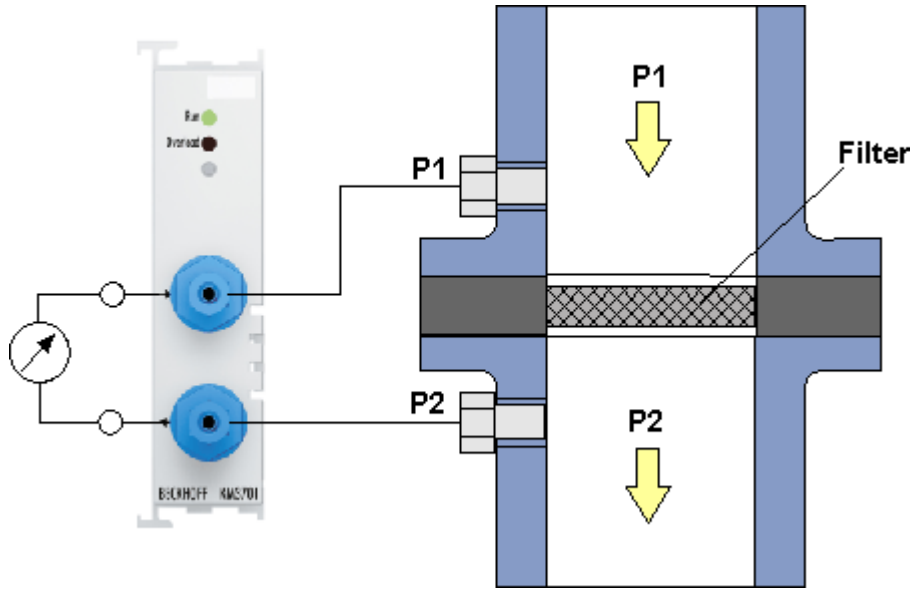

Fig. 12: KM3701 - Application example for filter systems, pipe restrictions

- Monitors the operating state of filters and screens
- The pressure difference indicates the level of contamination

4.2 KM3702 - Application example

⚠ WARNING

Risk of injury through electric shock and damage to the device!

Bring the Bus Terminals system into a safe, de-energized state before starting mounting, disassembly or wiring of the Bus Terminals!

Pneumatic systems

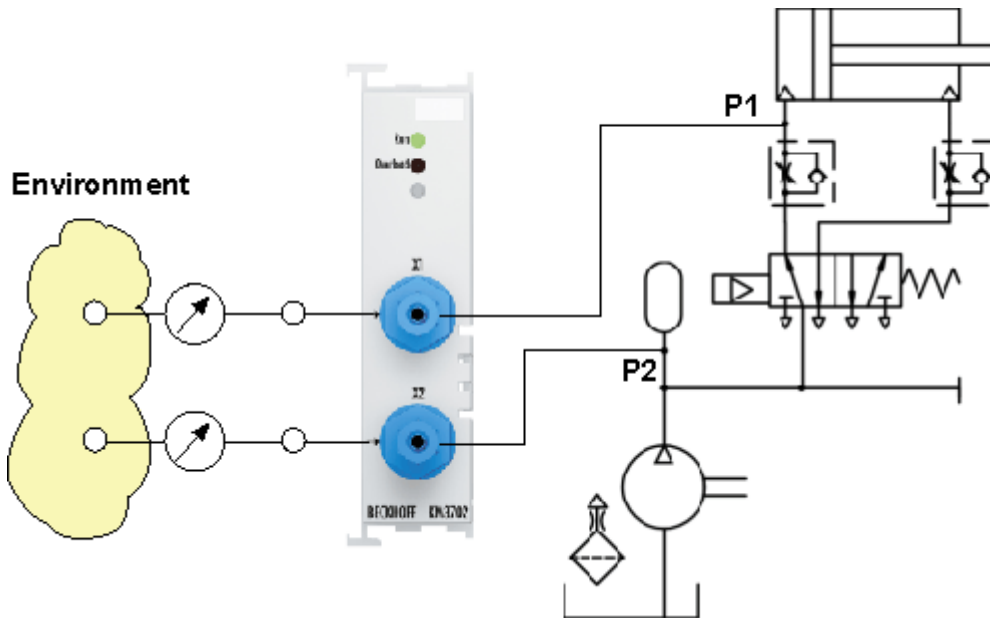

Fig. 13: KM3702 - Application example for pneumatic systems

- Checking the filling level of stores
- Monitoring the operating pressure of equipment
- enables monitoring and avoidance of overpressure

4.3 KM3712 - Application example

⚠ WARNING

Risk of injury through electric shock and damage to the device!

Bring the Bus Terminals system into a safe, de-energized state before starting mounting, disassembly or wiring of the Bus Terminals!

Packaging plant for eggs

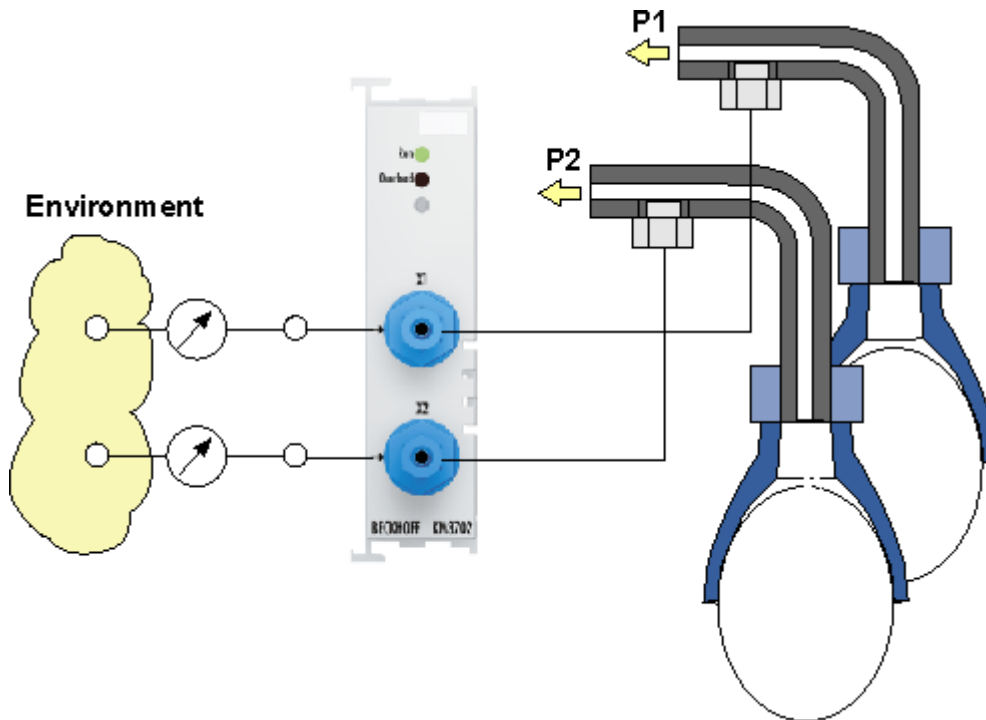

Fig. 14: EM3712 - Application example Packgng plant for eggs

- controls suction
- Pressure deviations indicate leakages or positioning inaccuracies

5 KS2000 Configuration software

5.1 KS2000 - Introduction

The KS2000 configuration software permits configuration, commissioning and parameterization of bus couplers, of the affiliated bus terminals and of Fieldbus Box Modules. The connection between bus coupler / Fieldbus Box Module and the PC is established by means of the serial configuration cable or the fieldbus.



Fig. 15: KS2000 configuration software

Configuration

You can configure the Fieldbus stations with the Configuration Software KS2000 offline. That means, setting up a terminal station with all settings on the couplers and terminals resp. the Fieldbus Box Modules can be prepared before the commissioning phase. Later on, this configuration can be transferred to the terminal station in the commissioning phase by means of a download. For documentation purposes, you are provided with the breakdown of the terminal station, a parts list of modules used and a list of the parameters you have modified. After an upload, existing fieldbus stations are at your disposal for further editing.

Parameterization

KS2000 offers simple access to the parameters of a fieldbus station: specific high-level dialogs are available for all bus couplers, all intelligent bus terminals and Fieldbus Box modules with the aid of which settings can be modified easily. Alternatively, you have full access to all internal registers of the bus couplers and intelligent terminals. Refer to the register description for the meanings of the registers.

Commissioning

The KS2000 software facilitates commissioning of machine components or their fieldbus stations: Configured settings can be transferred to the fieldbus modules by means of a download. After a *login* to the terminal station, it is possible to define settings in couplers, terminals and Fieldbus Box modules directly *online*. The same high-level dialogs and register access are available for this purpose as in the configuration phase.

The KS2000 offers access to the process images of the bus couplers and Fieldbus Box modules.

- Thus, the coupler's input and output images can be observed by monitoring.
- Process values can be specified in the output image for commissioning of the output modules.

All possibilities in the *online mode* can be used in parallel with the actual fieldbus mode of the terminal station. The fieldbus protocol always has the higher priority in this case.

5.2 Parameterization with KS2000

Connect the configuration interface of your Fieldbus Coupler with the serial interface of your PC via the configuration cable and start the *KS2000* Configuration Software.



Click on the *Login* button. The configuration software will now load the information for the connected fieldbus station.

In the example shown, this is

- a BK9000 Bus Coupler for Ethernet
- a KL1xx2 Digital Input Terminal
- a KM3701 differential pressure measuring module
- a KL9010 Bus End Terminal

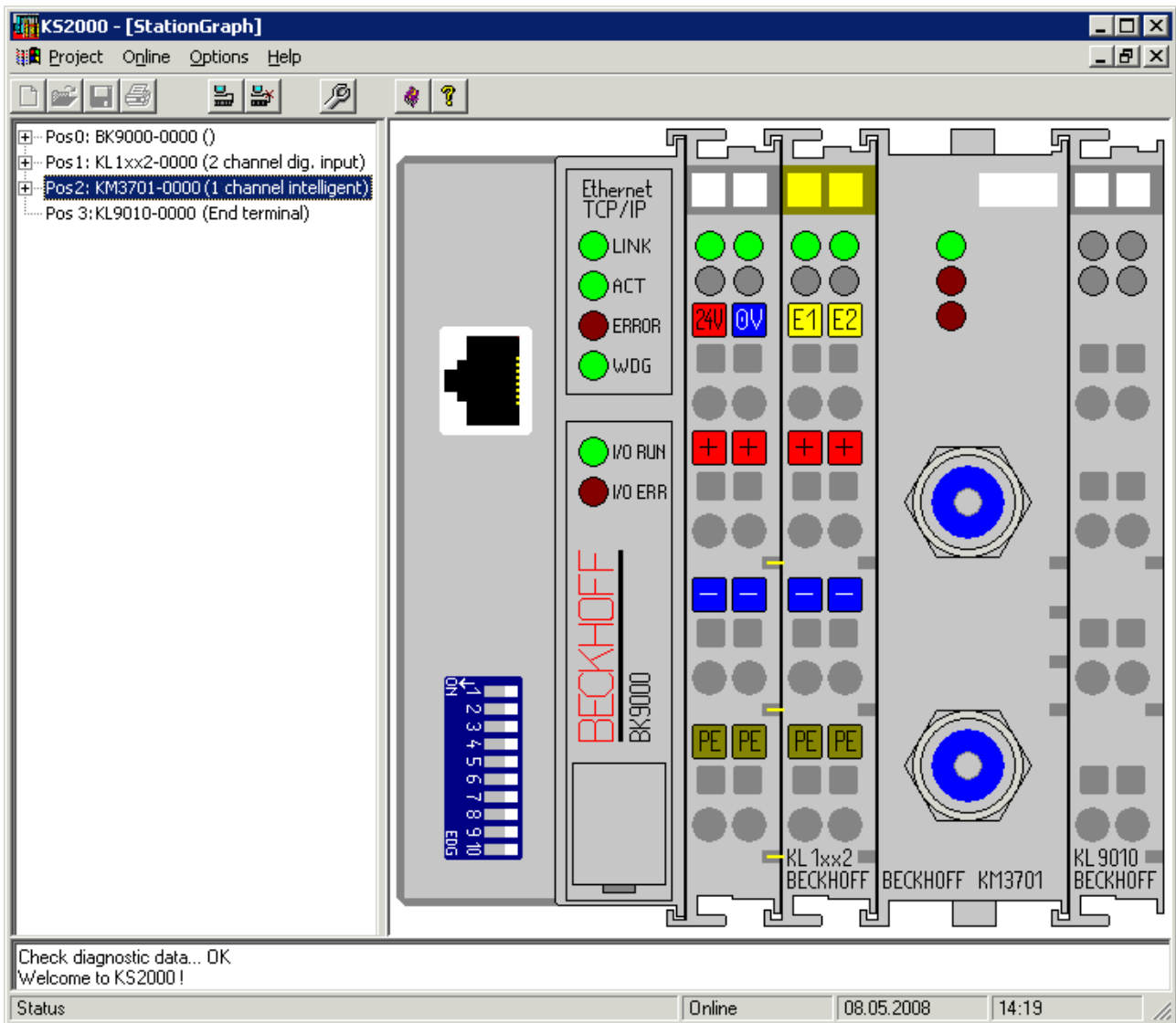

Fig. 16: Display of the fieldbus station in KS2000

The left-hand KS2000 window displays the terminals of the fieldbus station in a tree structure. The right-hand KS2000 window contains a graphic display of the fieldbus station terminals.

In the tree structure of the left-hand window, click on the plus-sign next to the module whose parameters you wish to change (pos. 2 in the example).

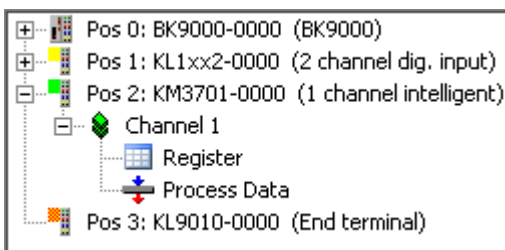

Fig. 17: KS2000 branch for channel 1 of the KM3701

For the KM3701, the branches *Register*, *Settings* and *ProcData* are displayed:

- [Register \[► 25\]](#) enables direct access to the KM3701 registers.
- [ProcData \[► 26\]](#) shows the process data of the KM3701.

5.3 Register

Under *Register* you can directly access the registers of the terminal module (KM3701 in this example). The meaning of the register is explained in the [Register Overview](#) [▶ 31].

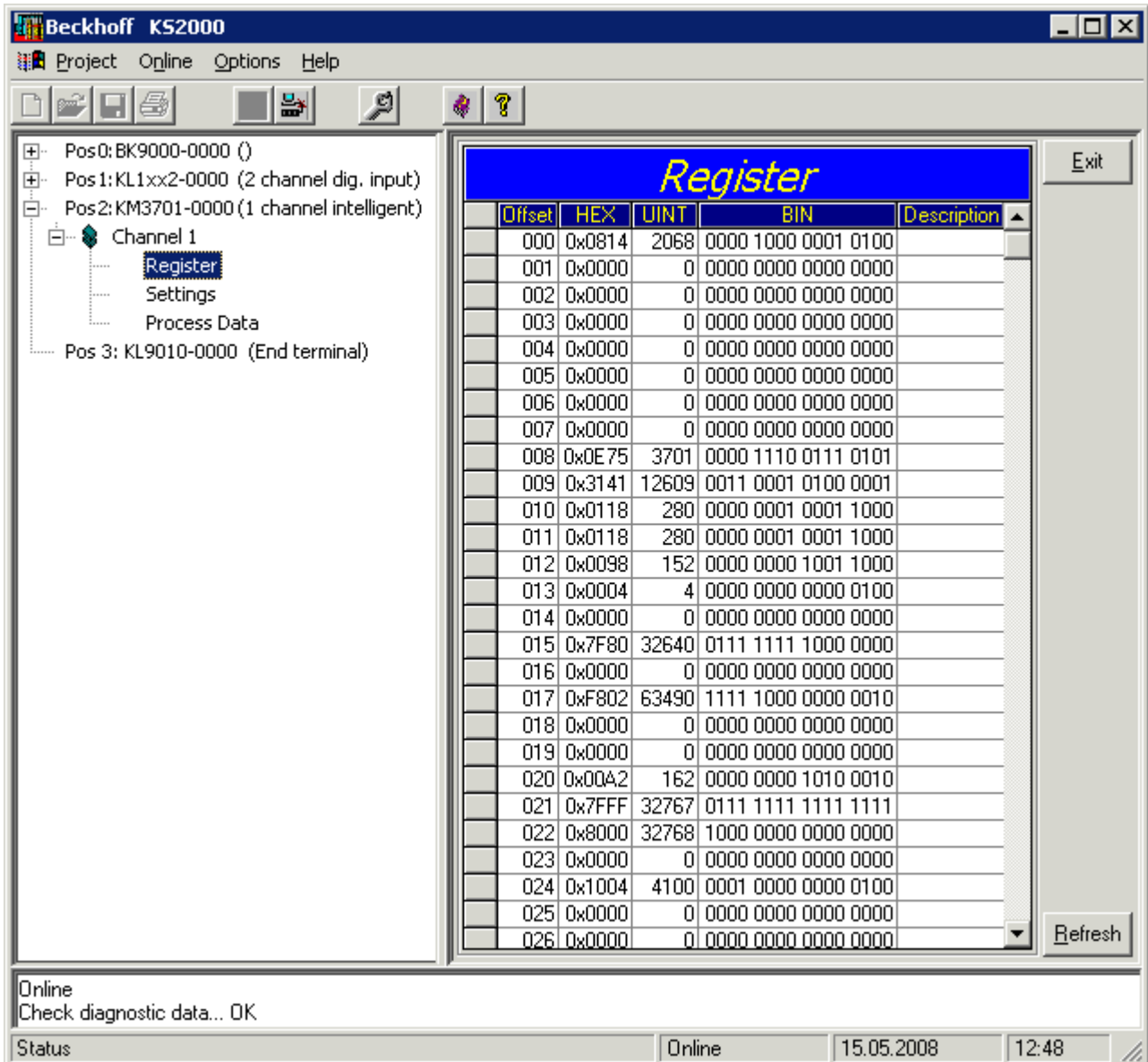

Fig. 18: Register view in KS2000

5.4 Process Data

The Status byte (Status), the Control byte (Ctrl) and the process data (Data) are displayed in a tree structure under *ProcData*.

Pos	Type	I-Address	Value	Bitsize	O-Address	Value	Bitsize
2	KM3701-0000						
	Channel 1						
	State	0.0	0x00	8			
	Data In	2.0	0x0018	16			
	Ctrl				0.0	0x00	8
	Data Out				2.0	0x0000	16

Fig. 19: Process Data field

The spectacles mark the data that are currently graphically displayed in the *History* field.

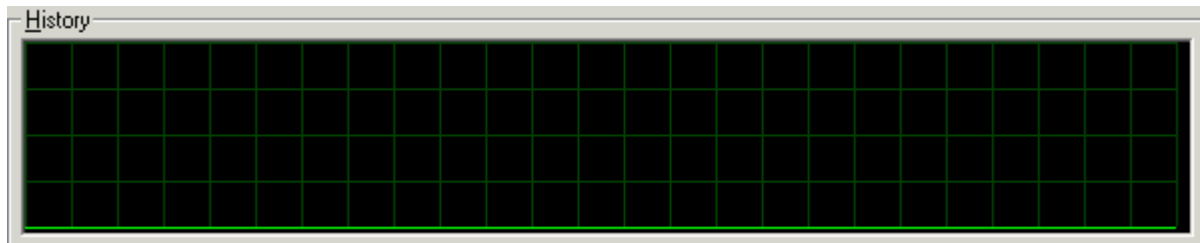

Fig. 20: History field

The current input value is displayed numerically in the *Value* field.

Fig. 21: Value field (input data)

Output values can be modified through direct input or by means of the fader control.

Fig. 22: Value field (output data)

⚠ CAUTION**Danger for persons, the environment or devices!**

Note that changing output values (forcing them) can have a direct effect on your automation application. Only modify these output values if you are certain that the state of your equipment permits it, and that there will be no risk to people or to the machine!

After pressing the *Settings* button you can set the format of the numerical display to hexadecimal, decimal or binary.

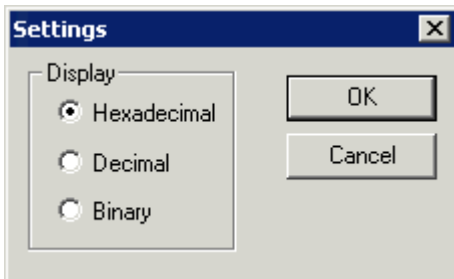

Fig. 23: Setting the display

6 Data structures

6.1 KM3701 - Process image

The KM3701 terminal module is represented in the process image with a maximum of 3 bytes of input data and 3 bytes of output data. These are organized as follows:

Format	Input data	Output data
Byte	SB [<u>▶</u> 29]	CB [<u>▶</u> 29]
Word	DataIN	DataOUT

Key

SB: Status byte

CB: Control byte

DataIN: Input data word

DataOUT: Output data word

- The meaning of the control and status bytes is explained in *Control and status bytes*.
- In process data mode, the analog value is transferred in the input data word DataIN. The output data word DataOUT is not used.

Representation of the analog values

The terminal module displays the analog input values as follows:

KM3701-0000

Differential pressure	Decimal	Hexadecimal
-100 hPa	-1000	0xFC18
0 hPa	0	0x0000
+100 hPa	+1000	0x03E8

KM3701-0340

Differential pressure	Decimal	Hexadecimal
-340 hPa	-3400	0xF2B8
0 hPa	0	0x0000
+340 hPa	+3400	0x0D48

6.2 KM3702, KM3712 - Process image

The KM3702 and KM3712 terminal modules are represented in the process image with a maximum of 6 bytes of input data and 6 bytes of output data. These are organized as follows:

Format	Input data	Output data
Byte	SB1 [<u>▶</u> 29]	CB1 [<u>▶</u> 29]
Word	DataIN1	DataOUT1
Byte	SB2	CB2
Word	DataIN2	DataOUT2

Key

SB n: Status byte for channel n

CB n: Control byte for channel n

DataIN n: Input data word channel n
 DataOUT n: Output data word channel n

- The meaning of the control and status bytes is explained in *Control and status bytes*.
- In process data mode the analog values are transferred in output data words DataIN1 and DataIN2. Input data words DataOUT1 and DataOUT2 are not used.

Representation of the analog values

The analog input values are represented by the terminal modules as follows:

KM3702-0000

Pressure	Decimal	Hexadecimal
0 hPa	0	0x0000
7500 hPa	7500	0x1D4C

KM3712-0000

Pressure	Decimal	Hexadecimal
-1000 hPa	-1000	0xFC18
0 hPa	0	0x0000
+1000 hPa	+1000	0x03E8

6.3 Control and Status Byte

Channels

The control and status bytes CB1 and SB1 of channel 1 in the process data mode and for register communication are described below.

The control and status bytes CB2 and SB2 of channel 2 (only KM3702 and KM3712) have the same structure as the control and status bytes of channel 1.

6.3.1 Process data mode

Control byte 1 (for process data mode)

Control byte 1 (CB1) is located in the output image, and is transmitted from the controller to the terminal module.

Bit	CB1.7	CB1.6	CB1.5	CB1.4	CB1.3	CB1.2	CB1.1	CB1.0
Name	RegAccess	-	-	-	-	-	-	-

Bit	Name	Description
CB1.7	RegAccess	0 _{bin} Register communication off (process data mode)
CB1.6 to CB1.1	-	0 _{bin} reserved
...
CB1.0	-	0 _{bin} reserved

Status byte 1 (for process data mode)

Status byte 1 (SB1) is located in the input image and is transmitted from terminal module to the controller.

Bit	SB1.7	SB1.6	SB1.5	SB1.4	SB1.3	SB1.2	SB1.1	SB1.0
Name	RegAccess	Error	StateThreshold2		StateThreshold1		Overload	Underload

Bit	Name	Description
SB1.7	RegAccess	0 _{bin} Acknowledgment for process data mode
SB1.6	Error	1 _{bin} an internal error has occurred (current process data is no longer valid)
SB1.5 / SB1.4	StateThreshold2	0 _{bin} Threshold 2 [▶ 34] is not enabled via bit R32.10 [▶ 33] of the feature register
		01 _{bin} Process data is greater than threshold 2
		10 _{bin} Process data is less than threshold 2
		11 _{bin} Process data equals threshold 2
SB1.3 / SB1.2	StateThreshold1	0 _{bin} Threshold 1 [▶ 34] is not enabled via bit R32.9 [▶ 33] of the feature register
		01 _{bin} Process data is greater than threshold 1
		10 _{bin} Process data is less than threshold 1
		11 _{bin} Process data equals threshold 1
SB1.1	Overload	1 _{bin} Process data is greater than specified in register R21 [▶ 33]. The red error LED of this channel is lit.
SB1.0	Underload	1 _{bin} Process data are less than specified in register R22 [▶ 33]. The red error LED of this channel is lit. (The calibration is active if SB1.0 and SB1.1 are set simultaneously).

6.3.2 Register communication

Control byte 1 (in register communication)

Control byte 1 (CB1) is located in the output image, and is transmitted from the controller to the terminal module.

Bit	CB1.7	CB1.6	CB1.5	CB1.4	CB1.3	CB1.2	CB1.1	CB1.0
Name	RegAccess	R/W	Reg. no.					

Bit	Name	Description
CB1.7	RegAccess	1 _{bin} Register communication switched on
CB1.6	R/W	0 _{bin} Read access
		1 _{bin} Write access
CB1.5 to CB1.0	Reg. no.	Register number: Enter the number of the register [▶ 31] that you - want to read with input data word DataIn or - want to write with output data word DataOut.

Status byte 1 (in register communication)

Status byte 1 (SB1) is located in the input image and is transmitted from terminal module to the controller.

Bit	SB1.7	SB1.6	SB1.5	SB1.4	SB1.3	SB1.2	SB1.1	SB1.0
Name	RegAccess	R/W	Reg. no.					

Bit	Name	Description
SB1.7	RegAccess	1 _{bin} Acknowledgment for register access
SB1.6	R	0 _{bin} Read access
SB1.5 to SB1.0	Reg. no.	Number of the register that was read or written.

6.4 Register overview

The registers are used for the parameterization of the Bus Terminals and are available for each channel. They can be read or written by means of [register communication](#) [▶ 35].

Register no.	Comment	Default value		R/W	Memory
R0 [▶ 32]	Raw ADC value	variable	variable	R	RAM
R1	reserved	0x0000	0 _{dec}	-	-
...
R5	reserved	0x0000	0 _{dec}	-	-
R6 [▶ 32]	Diagnostic register	0x0000	0 _{dec}	R	RAM
R7 [▶ 32]	Command register	0x0000	0 _{dec}	R/W	RAM
R8 [▶ 32]	Terminal type	KM3701:	0x0E75	R	ROM
		KM3702:	3701 _{dec}		
		KM3712:	3702 _{dec}		
R9 [▶ 32]	Firmware version	e.g. 0x3141	e.g. 1A _{ASCII}	R	ROM
R10	Multiplex shift register	0x0118	280 _{dec}	R	ROM
R11	Signal channels	0x0218	280 _{dec}	R	ROM
R12 [▶ 32]	minimum data length of a channel	0x0098	152 _{dec}	R	ROM
R13	Data structure	0x0000	0 _{dec}	R	ROM
R14	reserved	0x0000	0 _{dec}	-	-
R15	Alignment register	typically 0x7F80	typically 32640 _{dec}	R/W	RAM
R16 [▶ 33]	Hardware version number	e.g. 0x0000	e.g. 0 _{dec}	R/W	EEPROM
R17 [▶ 33]	Vendor calibration: Offset	KM3701, KM3712:	typically 0xF800	R/W	EEPROM
		KM3702:	typically 63488 _{dec}		
R18 [▶ 33]	Vendor calibration: Gain		typically 65126 _{dec}	R/W	EEPROM
R19 [▶ 33]	Manufacturer scaling: Offset	0x0000	0 _{dec}	R/W	EEPROM
R20 [▶ 33]	Manufacturer scaling: Gain	KM3701, KM3712:	0x00A2	R/W	EEPROM
		KM3702:	162 _{dec}		
R21 [▶ 33]	Overrange limit	KM3701, KM3712:	0x03E8	R/W	EEPROM
		KM3702:	539 _{dec}		
R22 [▶ 33]	Under range limit	KM3701, KM3712:	0x1D4C	R/W	EEPROM
		KM3702:	7500 _{dec}		
R23	internal use	KM3701, KM3712:	0xFC18	R/W	EEPROM
		KM3702:	-1000 _{dec}		
R24	internal use		-100 _{dec}	R/W	EEPROM
R25	reserved	0x0000	0 _{dec}	-	-
...	reserved	-	-	-	-
R30	reserved	0x0000	0 _{dec}	-	-
R31 [▶ 33]	Code word register	0x0000	0 _{dec}	R/W	RAM
R32 [▶ 33]	Feature register	0x0202	514 _{dec}	R/W	EEPROM
R33 [▶ 34]	User offset	0x0000	0 _{dec}	R/W	EEPROM
R34 [▶ 34]	User gain	0x0100	256 _{dec}	R/W	EEPROM
R35 [▶ 34]	Threshold 1	0x0000	0 _{dec}	R/W	EEPROM
R36 [▶ 34]	Threshold 2	0x0000	0 _{dec}	R/W	EEPROM
R37	reserved	-	-	-	-
...	reserved	-	-	-	-
R63	reserved	-	-	-	-

6.5 Register description

The registers are used for the parameterization of the Bus Terminals and are available for each channel. They can be read or written by means of register communication.

R0: Raw ADC value

Register R0 contains the raw value of the analog/digital converter. This is the unchanged analog value prior to any scaling.

R6: Diagnostic register

Status byte SB1 is placed into register R6.

R7: Command register

● User code word



For the following commands to be executed, it is first necessary for the user code word, 0x1235, to be entered into [register R31](#) |▶ [33](#)!

Command 0x7000: Restore Factory Settings

Entering 0x7000 in register R7 restores the factory settings for the following registers of both channels:

KM3701, KM3712:

R21: 0x03E8 (1000_{dec})
 R22: 0xFC18 (-1000_{dec})
 R32: 0x0202 (514_{dec})
 R33: 0x0000 (0_{dec})
 R34: 0x0100 (256_{dec})
 R35: 0x0000 (0_{dec})
 R36: 0x0000 (0_{dec})

KM3702:

R21: 0x1D4C (7500_{dec})
 R22: 0xFF9C (-100_{dec})
 R32: 0x0202 (514_{dec})
 R33: 0x0000 (0_{dec})
 R34: 0x0100 (256_{dec})
 R35: 0x0000 (0_{dec})
 R36: 0x0000 (0_{dec})

● Delivery state for all channels



The command Restore Factory Settings simultaneously resets all module channels to the delivery state, irrespective of which register set it is called from!

R8: Module ID

Register R8 contains the ID for the terminal module.

KM3701: 0x0C64 (3701_{dec})
 KM3702: 0x0C6E (3702_{dec})
 KM3712: 0xC3C (3712_{dec})

R9: Firmware version

Register R9 contains the ASCII coding of the terminal's firmware version, e.g. **0x3141** = '1A'. The '0x31' corresponds here to the ASCII character '1', while the '0x41' represents the ASCII character 'A'. This value cannot be changed.

R12: Minimum data length of a channel

Bits 0 to 6 of the high-order byte specify the minimum number of output data in bits: $000.0000_{bin} = 0_{dec}$, hence 0 bytes.

Bits 0 to 6 of the low-order byte specify the minimum number of input data in bits: $001.1000_{bin} = 24_{dec}$, hence 3 bytes.

The fact that bit 7 is set indicates that the control and status byte are not mandatory for the terminal function and are not transferred in compact mode.

R16: Hardware version number

Register R16 contains the hardware version of the terminal.

R17: Vendor calibration - offset

This register contains the vendor calibration offset (16 bit signed integer).

R18: Vendor calibration - gain

This register contains the vendor calibration gain (16 bit unsigned integer $\times 2^{-16} + 1$). Samples:
 0x0000 means factor 1
 0xFFFF means factor 2

R19: Manufacturer scaling - offset

This register contains the offset of the manufacturer scaling. Can be activated via [R32.1 \[► 33\]](#) in the feature register (16 bit signed integer).

R20: Manufacturer scaling - gain

This register contains the gain of the manufacturer scaling. Can be activated via [R32.1 \[► 33\]](#) in the feature register (16 bit unsigned integer $\times 2^{-8} + 1$). Samples:
 0x0100 means factor 1.
 0x0080 means factor 0.5

R21: Upper measuring range limit

This register contains the upper measuring range limit. It can be activated by [R32.8 \[► 33\]](#) in the feature register.

R22: Lower measuring range limit

This register contains the lower measuring range limit. It can be activated by [R32.8 \[► 33\]](#) in the feature register.

R31: Code word register

- If you write values into the user registers without first entering the user code word (0x1235) into the code word register, the terminal will not accept the supplied data.
- If you write values into the user registers and have previously entered the user code word (0x1235) in the code word register, these values are stored in the RAM registers and in the SEEPROM registers and are therefore retained if the terminal is restarted.

The code word is reset if the terminal is restarted.

R32: Feature register

The feature register defines the module configuration.

Bit	R32.15	R32.14	R32.13	R32.12	R32.11	R32.10	R32.9	R32.8
Name	-	-	-	-	enTh2	enTh1	enOverProt	-

Bit	R32.7	R32.6	R32.5	R32.4	R32.3	R32.2	R32.1	R32.0
Name	-	-	-	enSiemens Format	enAverage Format	disWdTimer	enManScal	enUsrScal

Bit	Name	Description	default	
R32.15	-	reserved	0 _{bin}	
...	
R32.12	-	reserved	0 _{bin}	
R32.11	enTh2	0 _{bin}	Threshold 2 not active	0 _{bin}
		1 _{bin}	Threshold 2 active	
R32.10	enTh1	0 _{bin}	Threshold 1 not active	0 _{bin}
		1 _{bin}	Threshold 1 active	
R32.9	enOverProt	0 _{bin}	Measuring range limitation not active	1 _{bin}
		1 _{bin}	Overrange protection active	
R32.8	-	reserved	0 _{bin}	
...	
R32.5	-	reserved	0 _{bin}	
R32.4	enSiemensFormat	0 _{bin}	Siemens output format not active	0 _{bin}
		1 _{bin}	Siemens output format active	
R32.3	enAverageFormat	0 _{bin}	Signed amount representation not active	0 _{bin}
		1 _{bin}	Signed amount representation active	
R32.2	disWdTimer	0 _{bin}	Watchdog timer is active (the watchdog is triggered if no process data are received for 100 ms)	0 _{bin}
		1 _{bin}	Watchdog timer is not active	
R32.1	enManScal	0 _{bin}	Manufacturer scaling is not active	1 _{bin}
		1 _{bin}	Manufacturer scaling is active	
R32.0	enUsrScal	0 _{bin}	User scaling is not active	0 _{bin}
		1 _{bin}	User scaling is active	

R33: User scaling - offset

This register contains the offset of the user scaling. The user scaling can be activated in the feature register through bit [R32.0 \[► 33\]](#) (16 bit signed integer).

R34: User scaling - gain

This register contains the gain of the user scaling. The user scaling can be activated in the feature register through bit [R32.0 \[► 33\]](#) (16 bit unsigned integer $\times 2^{-8} + 1$, 1_{dec} corresponds to 0x0100).

R35: Threshold 1

Threshold 1 is entered in register R35. The threshold can be activated in the feature register through bit [R32.10 \[► 33\]](#).

R36: Threshold 2

Threshold 2 is entered in register R36. The threshold can be activated in the feature register through bit [R32 \[► 33\].11](#).

6.6 Examples of Register Communication

The numbering of the bytes in the examples corresponds to the display without word alignment.

6.6.1 Example 1: Reading the firmware version from register 9

Output Data

Byte 0: Control byte	Byte 1: DataOUT1, high byte	Byte 2: DataOUT1, low byte
0x89 (1000 1001 _{bin})	0xXX	0xXX

Explanation:

- Bit 0.7 set means: Register communication switched on.
- Bit 0.6 not set means: reading the register.
- Bits 0.5 to 0.0 specify the register number 9 with 00 1001_{bin}.
- The output data word (byte 1 and byte 2) has no meaning during read access. To change a register, write the required value into the output word.

Input Data (answer of the Bus Terminal)

Byte 0: Status byte	Byte 1: DataIN1, high byte	Byte 2: DataIN1, low byte
0x89	0x33	0x41

Explanation:

- The terminal returns the value of the control byte as a receipt in the status byte.
- The terminal returns the firmware version 0x3341 in the input data word (byte 1 and byte 2). This is to be interpreted as an ASCII code:
 - ASCII code 0x33 represents the digit 3
 - ASCII code 0x41 represents the letter A
 The firmware version is thus 3A.

6.6.2 Example 2: Writing to an user register

● Code word

In normal mode all user registers are read-only with the exception of Register 31. In order to deactivate this write protection you must write the code word (0x1235) into Register 31. If a value other than 0x1235 is written into Register 31, write protection is reactivated. Please note that changes to a register only become effective after restarting the terminal (power-off/power-on).

I. Write the code word (0x1235) into register 31.

Output Data

Byte 0: Control byte	Byte 1: DataOUT1, high byte	Byte 2: DataOUT1, low byte
0xDF (1101 1111 _{bin})	0x12	0x35

Explanation:

- Bit 0.7 set means: Register communication switched on.
- Bit 0.6 set means: writing to the register.
- Bits 0.5 to 0.0 specify the register number 31 with 01 1111_{bin}.
- The output data word (byte 1 and byte 2) contains the code word (0x1235) for deactivating write protection.

Input Data (answer of the Bus Terminal)

Byte 0: Status byte	Byte 1: DataIN1, high byte	Byte 2: DataIN1, low byte
0x9F (1001 1111 _{bin})	0xXX	0xXX

Explanation:

- The terminal returns a value as a receipt in the status byte that differs only in bit 0.6 from the value of the control byte.
- The input data word (byte 1 and byte 2) is of no importance after the write access. Any values still displayed are invalid!

II. Read Register 31 (check the set code word)**Output Data**

Byte 0: Control byte	Byte 1: DataOUT1, high byte	Byte 2: DataOUT1, low byte
0x9F (1001 1111 _{bin})	0xXX	0xXX

Explanation:

- Bit 0.7 set means: Register communication switched on.
- Bit 0.6 not set means: reading the register.
- Bits 0.5 to 0.0 specify the register number 31 with 01 1111_{bin}.
- The output data word (byte 1 and byte 2) has no meaning during read access.

Input Data (answer of the Bus Terminal)

Byte 0: Status byte	Byte 1: DataIN1, high byte	Byte 2: DataIN1, low byte
0x9F (1001 1111 _{bin})	0x12	0x35

Explanation:

- The terminal returns the value of the control byte as a receipt in the status byte.
- The terminal returns the current value of the code word register in the input data word (byte 1 and byte 2).

III. Write to Register 32 (change contents of the feature register)**Output data**

Byte 0: Control byte	Byte 1: DataIN1, high byte	Byte 2: DataIN1, low byte
0xE0 (1110 0000 _{bin})	0x00	0x02

Explanation:

- Bit 0.7 set means: Register communication switched on.
- Bit 0.6 set means: writing to the register.
- Bits 0.5 to 0.0 indicate register number 32 with 10 0000_{bin}.
- The output data word (byte 1 and byte 2) contains the new value for the feature register.

⚠ CAUTION**Observe the register description!**

The value of 0x0002 given here is just an example!

The bits of the feature register change the properties of the terminal and have a different meaning, depending on the type of terminal. Refer to the description of the feature register of your terminal (chapter *Register description*) regarding the meaning of the individual bits before changing the values.

Input data (response from the Bus Terminal)

Byte 0: Status byte	Byte 1: DataIN1, high byte	Byte 2: DataIN1, low byte
0xA0 (1010 0000 _{bin})	0xXX	0xXX

Explanation:

- The terminal returns a value as a receipt in the status byte that differs only in bit 0.6 from the value of the control byte.
- The input data word (byte 1 and byte 2) is of no importance after the write access. Any values still displayed are invalid!

IV. Read register 32 (check changed feature register)

Output Data

Byte 0: Control byte	Byte 1: DataOUT1, high byte	Byte 2: DataOUT1, low byte
0xA0 (1010 0000 _{bin})	0xXX	0xXX

Explanation:

- Bit 0.7 set means: Register communication switched on.
- Bit 0.6 not set means: reading the register.
- Bits 0.5 to 0.0 indicate register number 32 with 10 0000_{bin}.
- The output data word (byte 1 and byte 2) has no meaning during read access.

Input Data (answer of the Bus Terminal)

Byte 0: Status byte	Byte 1: DataIN1, high byte	Byte 2: DataIN1, low byte
0xA0 (1010 0000 _{bin})	0x00	0x02

Explanation:

- The terminal returns the value of the control byte as a receipt in the status byte.
- The terminal returns the current value of the feature register in the input data word (byte 1 and byte 2).

V. Write register 31 (reset code word)

Output Data

Byte 0: Control byte	Byte 1: DataOUT1, high byte	Byte 2: DataOUT1, low byte
0xDF (1101 1111 _{bin})	0x00	0x00

Explanation:

- Bit 0.7 set means: Register communication switched on.
- Bit 0.6 set means: writing to the register.
- Bits 0.5 to 0.0 specify the register number 31 with 01 1111_{bin}.
- The output data word (byte 1 and byte 2) contains 0x0000 for reactivating write protection.

Input Data (answer of the Bus Terminal)

Byte 0: Status byte	Byte 1: DataIN1, high byte	Byte 2: DataIN1, low byte
0x9F (1001 1111 _{bin})	0xXX	0xXX

Explanation:

- The terminal returns a value as a receipt in the status byte that differs only in bit 0.6 from the value of the control byte.

- The input data word (byte 1 and byte 2) is of no importance after the write access. Any values still displayed are invalid!

7 Appendix

7.1 Support and Service

Beckhoff and their partners around the world offer comprehensive support and service, making available fast and competent assistance with all questions related to Beckhoff products and system solutions.

Beckhoff's branch offices and representatives

Please contact your Beckhoff branch office or representative for local support and service on Beckhoff products!

The addresses of Beckhoff's branch offices and representatives round the world can be found on her internet pages: www.beckhoff.com

You will also find further documentation for Beckhoff components there.

Support

The Beckhoff Support offers you comprehensive technical assistance, helping you not only with the application of individual Beckhoff products, but also with other, wide-ranging services:

- support
- design, programming and commissioning of complex automation systems
- and extensive training program for Beckhoff system components

Hotline: +49 5246 963 157
e-mail: support@beckhoff.com
web: www.beckhoff.com/support

Service

The Beckhoff Service Center supports you in all matters of after-sales service:

- on-site service
- repair service
- spare parts service
- hotline service

Hotline: +49 5246 963 460
e-mail: service@beckhoff.com
web: www.beckhoff.com/service

Headquarters Germany

Beckhoff Automation GmbH & Co. KG

Hülshorstweg 20
33415 Verl
Germany

Phone: +49 5246 963 0
e-mail: info@beckhoff.com
web: www.beckhoff.com

Table of figures

Fig. 1	KM3701.....	8
Fig. 2	KM3702.....	9
Fig. 3	KM3712.....	10
Fig. 4	KM3701 - LEDs.....	12
Fig. 5	KM3702, KM3712 - LEDs	12
Fig. 6	Bus Terminal block with pressure measuring modules.....	13
Fig. 7	KM3701 - Single-channel differential pressure measurement	13
Fig. 8	KM3702 - Two-channel relative pressure measurement	14
Fig. 9	KM3712 - Two-channel relative pressure measurement	14
Fig. 10	Spring contacts of the Beckhoff I/O components	15
Fig. 11	KM3701 - Application example for the fill level of tanks.....	18
Fig. 12	KM3701 - Application example for filter systems, pipe restrictions.....	19
Fig. 13	KM3702 - Application example for pneumatic systems	20
Fig. 14	EM3712 - Application example Packaging plant for eggs.....	21
Fig. 15	KS2000 configuration software	22
Fig. 16	Display of the fieldbus station in KS2000.....	24
Fig. 17	KS2000 branch for channel 1 of the KM3701	24
Fig. 18	Register view in KS2000	25
Fig. 19	Process Data field	26
Fig. 20	History field	26
Fig. 21	Value field (input data)	26
Fig. 22	Value field (output data).....	26
Fig. 23	Setting the display.....	27

More Information:
www.beckhoff.com/KM3xxx

Beckhoff Automation GmbH & Co. KG
Hülshorstweg 20
33415 Verl
Germany
Phone: +49 5246 9630
info@beckhoff.com
www.beckhoff.com

