

Documentation | EN

## EP1xxx

EtherCAT Box modules with digital inputs





# Table of contents

<b>1</b>	<b>Foreword</b> .....	<b>7</b>
1.1	Notes on the documentation .....	7
1.2	Safety instructions .....	8
1.3	Documentation issue status .....	9
<b>2</b>	<b>EtherCAT Box - Introduction</b> .....	<b>11</b>
<b>3</b>	<b>Product overview</b> .....	<b>13</b>
3.1	EP1008, EP1018.....	14
3.1.1	Introduction .....	14
3.1.2	Technical data - EP1008, EP1018 .....	16
3.1.3	Scope of supply - EP1008, EP1018.....	17
3.1.4	Process image - EP1008-000x .....	18
3.2	EP1008-0022 .....	19
3.2.1	Introduction .....	19
3.2.2	Technical data - EP1008-0022.....	20
3.2.3	Scope of supply - EP1008-0022 .....	21
3.2.4	Process image - EP1008-0022 .....	22
3.3	EP1098-0001 .....	23
3.3.1	Introduction .....	23
3.3.2	Technical data - EP1098-0001.....	24
3.3.3	Scope of supply - EP1098-0001 .....	26
3.3.4	Process image - EP1098-0001 .....	27
3.4	EP1258-000x .....	28
3.4.1	Introduction .....	28
3.4.2	Technical data - EP1258-000x.....	30
3.4.3	Scope of supply - EP1258-000x.....	32
3.4.4	Process image - EP1258-0001 .....	32
3.5	EP1809, EP1819.....	33
3.5.1	Introduction - EP1809-0021, EP1819-0021 .....	33
3.5.2	Introduction - EP1809-0022, EP1819-0022 .....	34
3.5.3	Technical data - EP1809, EP1819 .....	35
3.5.4	Scope of supply - EP1809, EP1819.....	36
3.5.5	Process image - EP1809-0021 .....	37
3.6	EP1809-0042 .....	38
3.6.1	Introduction .....	38
3.6.2	Technical data - EP1809-0042.....	39
3.6.3	Scope of supply - EP1809-0042 .....	40
3.6.4	Process image - EP1809-0042 .....	41
3.7	EP1816-0003 .....	42
3.7.1	Introduction .....	42
3.7.2	Technical data - EP1816-0003.....	43
3.7.3	Scope of supply - EP1816-0003 .....	44
3.7.4	Process image - EP1816-0003 .....	45
3.8	EP1816-x008 .....	46
3.8.1	Introduction .....	46

3.8.2	Technical data - EP1816-x008.....	48
3.8.3	Scope of supply - EP1816-000x.....	50
3.8.4	Process image - EP1816-0008.....	51
3.8.5	Process image - EP1816-1008.....	52
3.8.6	Process image - EP1816-3008.....	53
3.9	EP1819-0005.....	55
3.9.1	Introduction.....	55
3.9.2	Technical data - EP1819-0005.....	56
3.9.3	Scope of supply - EP1819-0005.....	57
3.9.4	Process image - EP1819-0005.....	58
3.10	EP1839-0042.....	59
3.10.1	Introduction.....	59
3.10.2	Technical data - EP1839-0042.....	61
3.10.3	Scope of supply - EP1839-0042.....	63
3.10.4	Process image - EP1839-0042.....	64
3.11	EP1859-0042.....	70
3.11.1	Introduction.....	70
3.11.2	Technical data - EP1859-0042.....	72
3.11.3	Scope of supply - EP1859-0042.....	74
3.11.4	Process image - EP1859-0042.....	75
<b>4</b>	<b>Mounting and connection.....</b>	<b>76</b>
4.1	Mounting.....	76
4.1.1	Dimensions EPxxxx-xx0x and EPxxxx-xx1x.....	76
4.1.2	Dimensions EPxxxx-xx2x.....	77
4.1.3	EPxxxx-xx42 dimensions.....	78
4.1.4	Fixing.....	79
4.1.5	Functional earth (FE).....	80
4.2	Connections.....	81
4.2.1	Tightening torques for plug connectors.....	81
4.2.2	Protective caps.....	81
4.2.3	EtherCAT.....	82
4.2.4	Supply voltages.....	84
4.2.5	Digital inputs.....	88
4.2.6	Digital outputs (EP1859-0042 only).....	105
4.3	UL Requirements.....	106
4.4	ATEX notes.....	107
4.4.1	ATEX - Special conditions.....	107
4.4.2	BG2000 - EtherCAT Box protection enclosures.....	108
4.4.3	ATEX Documentation.....	109
4.5	Disposal.....	110
<b>5</b>	<b>Commissioning and configuration.....</b>	<b>111</b>
5.1	Integrating into a TwinCAT project.....	111
5.2	Adapt process image (EP1819-0005, EP1839-0042).....	112
5.3	Configure inputs (EP1839-0042).....	114
5.3.1	Input filter.....	114

5.3.2	Pulse extension.....	116
5.3.3	Assignment of the connections .....	118
5.4	Configure sensor supply (EP1839-0042) .....	119
5.4.1	Switching outputs .....	119
5.4.2	Behavior on EtherCAT failure .....	120
5.5	Acceleration measurement (EP1816-3008) .....	122
5.5.1	Acceleration axes.....	122
5.5.2	Configuration.....	123
5.5.3	Interpretation of the measured values.....	125
5.6	Inclination measurement (EP1816-3008).....	126
5.6.1	Calculation in the Box .....	126
5.6.2	Calculation in the controller.....	128
5.6.3	Smoothing of measured values.....	131
5.7	Restore the delivery state .....	133
5.8	Decommissioning.....	134
<b>6</b>	<b>Diagnosis .....</b>	<b>135</b>
6.1	Antivalent sensors (EP1819-0005) .....	135
6.2	Wire break detection (EP1839-0042).....	136
<b>7</b>	<b>CoE parameters.....</b>	<b>137</b>
7.1	EP1816-0008 - Object Overview.....	137
7.2	EP1816-0008 - Object description and parameterization .....	139
7.3	EP1816-3008 - Object overview .....	144
7.4	EP1816-3008 - Object description and parameterization .....	149
7.4.1	Objects to be parameterized during commissioning .....	149
7.4.2	Standard objects (0x1000-0x1FFF) .....	152
7.4.3	Profile-specific objects (0x6000-0xFFFF) .....	157
7.5	EP1819-0005 - Object description and parameterization .....	159
7.5.1	Objects to be parameterized during commissioning .....	159
7.5.2	Standard objects (0x1000 to 0x1FFF).....	161
7.5.3	Profile-specific objects (0x6000 to 0xFFFF).....	165
7.6	EP1839-0042 - Object overview .....	169
7.7	EP1839-0042 - Object description and parameterization .....	178
7.7.1	Standard objects (0x1000-0x1FFF) .....	178
7.7.2	Profile-specific objects (0x6000-0xFFFF) .....	188
<b>8</b>	<b>Appendix.....</b>	<b>200</b>
8.1	General operating conditions .....	200
8.2	Accessories .....	201
8.3	Version identification of EtherCAT devices .....	202
8.3.1	General notes on marking.....	202
8.3.2	Version identification of IP67 modules .....	203
8.3.3	Beckhoff Identification Code (BIC).....	204
8.3.4	Electronic access to the BIC (eBIC).....	206
8.4	Support and Service.....	208



# 1 Foreword

## 1.1 Notes on the documentation

### Intended audience

This description is only intended for the use of trained specialists in control and automation engineering who are familiar with the applicable national standards.

It is essential that the documentation and the following notes and explanations are followed when installing and commissioning these components.

The qualified personnel is obliged to always use the currently valid documentation.

The responsible staff must ensure that the application or use of the products described satisfy all the requirements for safety, including all the relevant laws, regulations, guidelines and standards.

### Disclaimer

The documentation has been prepared with care. The products described are, however, constantly under development.

We reserve the right to revise and change the documentation at any time and without prior announcement.

No claims for the modification of products that have already been supplied may be made on the basis of the data, diagrams and descriptions in this documentation.

### Trademarks

Beckhoff®, TwinCAT®, TwinCAT/BSD®, TC/BSD®, EtherCAT®, EtherCAT G®, EtherCAT G10®, EtherCAT P®, Safety over EtherCAT®, TwinSAFE®, XFC®, XTS® and XPlanar® are registered trademarks of and licensed by Beckhoff Automation GmbH. Other designations used in this publication may be trademarks whose use by third parties for their own purposes could violate the rights of the owners.

### Patent Pending

The EtherCAT Technology is covered, including but not limited to the following patent applications and patents: EP1590927, EP1789857, EP1456722, EP2137893, DE102015105702 with corresponding applications or registrations in various other countries.



EtherCAT® is registered trademark and patented technology, licensed by Beckhoff Automation GmbH, Germany.

### Copyright

© Beckhoff Automation GmbH & Co. KG, Germany.

The reproduction, distribution and utilization of this document as well as the communication of its contents to others without express authorization are prohibited.

Offenders will be held liable for the payment of damages. All rights reserved in the event of the grant of a patent, utility model or design.

## 1.2 Safety instructions

### Safety regulations

Please note the following safety instructions and explanations!  
Product-specific safety instructions can be found on following pages or in the areas mounting, wiring, commissioning etc.

### Exclusion of liability

All the components are supplied in particular hardware and software configurations appropriate for the application. Modifications to hardware or software configurations other than those described in the documentation are not permitted, and nullify the liability of Beckhoff Automation GmbH & Co. KG.

### Personnel qualification

This description is only intended for trained specialists in control, automation and drive engineering who are familiar with the applicable national standards.

### Signal words

The signal words used in the documentation are classified below. In order to prevent injury and damage to persons and property, read and follow the safety and warning notices.

#### Personal injury warnings

**⚠ DANGER**

Hazard with high risk of death or serious injury.

**⚠ WARNING**

Hazard with medium risk of death or serious injury.

**⚠ CAUTION**

There is a low-risk hazard that could result in medium or minor injury.

#### Warning of damage to property or environment

**NOTICE**

The environment, equipment, or data may be damaged.

#### Information on handling the product



This information includes, for example:  
recommendations for action, assistance or further information on the product.



## 1.3 Documentation issue status

Version	Comment
3.7	<ul style="list-style-type: none"> <li>• Technical data updated</li> <li>• EP1111-0000 moved to separate documentation</li> </ul>
3.6	<ul style="list-style-type: none"> <li>• EP1819-0005 added</li> </ul>
3.5	<ul style="list-style-type: none"> <li>• Technical data updated</li> <li>• Chapter "Connections" &gt; "Digital inputs" updated</li> </ul>
3.4	<ul style="list-style-type: none"> <li>• Structure update</li> </ul>
3.3	<ul style="list-style-type: none"> <li>• EP1839-0042 added</li> <li>• Technical data updated</li> </ul>
3.2	<ul style="list-style-type: none"> <li>• Information on freedom from interference added: <ul style="list-style-type: none"> <li>◦ EP1809-0042</li> <li>◦ EP1859-0042</li> </ul> </li> <li>• Dimensions updated</li> </ul>
3.1	<ul style="list-style-type: none"> <li>• UL requirements updated</li> <li>• EP1816-3008: Chapter "Acceleration measurement" updated</li> <li>• EP1816-3008: Chapter "Inclination measurement" updated</li> </ul>
3.0	<ul style="list-style-type: none"> <li>• Front page updated</li> <li>• Scope of delivery added</li> </ul>
2.8	<ul style="list-style-type: none"> <li>• EP18x9-0042: Technical data and connections updated</li> </ul>
2.7	<ul style="list-style-type: none"> <li>• EP1809-0042 added</li> <li>• EP1816-0003 added</li> <li>• EP1819-0021 added</li> <li>• EP1859-0042 added</li> </ul>
2.6	<ul style="list-style-type: none"> <li>• Signal connection of EP1816-3008 corrected</li> <li>• BG2000-0010 protection enclosure supplemented</li> <li>• EP1098-0001 Introduction: 2-wire connection corrected</li> <li>• EP1816-1008 added</li> </ul>
2.5.0	<ul style="list-style-type: none"> <li>• EP1816-3008 added</li> </ul>
2.4.1	<ul style="list-style-type: none"> <li>• EP1111-0000 – technical data updated</li> </ul>
2.4.0	<ul style="list-style-type: none"> <li>• Nut torques for connectors updated</li> </ul>
2.3.0	<ul style="list-style-type: none"> <li>• <i>Torque wrench</i> diagram updated</li> <li>• Power Connection updated</li> </ul>
2.2.0	<ul style="list-style-type: none"> <li>• EP1008-0022 added</li> <li>• EP1819-0021 added</li> <li>• Cabling adjusted</li> </ul>
2.1.0	<ul style="list-style-type: none"> <li>• Nut torques for connectors extended</li> </ul>
2.0.0	<ul style="list-style-type: none"> <li>• Migration</li> <li>• Technical data updated</li> </ul>
1.4.0	<ul style="list-style-type: none"> <li>• Chapter <i>Accessories</i> added</li> <li>• Chapter on <i>Tightening torque for connectors</i> updated</li> <li>• Chapter <i>EtherCAT connection</i> updated</li> <li>• Chapter on <i>BG2000-0000 - protective housing for EtherCAT Box</i> updated</li> </ul>
1.3.0	<ul style="list-style-type: none"> <li>• EP1111-0000 added</li> <li>• EP1098-0001 and EP1098-0002 added</li> <li>• EP1809-0021, EP1809-0022 and EP1819-0022 updated</li> </ul>

Version	Modifications
1.2.0	<ul style="list-style-type: none"> <li>• ATEX notes added</li> <li>• Extended temperature range for activated modules documented</li> <li>• EP1809-0021, EP1809-0022 and EP1819-0022 added</li> <li>• Description of the power connection updated</li> <li>• Overview of EtherCAT cables extended</li> </ul>
1.1.0	<ul style="list-style-type: none"> <li>• Technical data: Current consumption values amended</li> <li>• Tightening torque for connectors added</li> </ul>
1.0.0	<ul style="list-style-type: none"> <li>• Process data description extended</li> </ul>
0.7	<ul style="list-style-type: none"> <li>• Description of status LEDs added</li> <li>• Signal connection extended</li> <li>• Explanation of the serial number adapted to the new standard</li> </ul>
0.6	<ul style="list-style-type: none"> <li>• Signal connection extended</li> </ul>
0.5	<ul style="list-style-type: none"> <li>• First preliminary version</li> </ul>

### Firmware and hardware versions

This documentation refers to the firmware and hardware version that was applicable at the time the documentation was written.

The module features are continuously improved and developed further. Modules having earlier production statuses cannot have the same properties as modules with the latest status. However, existing properties are retained and are not changed, so that older modules can always be replaced with new ones.

The firmware and hardware version (delivery state) can be found in the batch number (D-number) printed on the side of the EtherCAT Box.

### Syntax of the batch number (D-number)

D: WW YY FF HH

WW - week of production (calendar week)

YY - year of production

FF - firmware version

HH - hardware version

Example with D no. 29 10 02 01:

29 - week of production 29

10 - year of production 2010

02 - firmware version 02

01 - hardware version 01

Further information on this topic: [Version identification of EtherCAT devices \[► 202\]](#).

## 2 EtherCAT Box - Introduction

The EtherCAT system has been extended with EtherCAT Box modules with protection class IP67. Through the integrated EtherCAT interface the modules can be connected directly to an EtherCAT network without an additional Coupler Box. The high-performance of EtherCAT is thus maintained into each module.

The extremely low dimensions of only 126 x 30 x 26.5 mm (h x w x d) are identical to those of the Fieldbus Box extension modules. They are thus particularly suitable for use where space is at a premium. The small mass of the EtherCAT modules facilitates applications with mobile I/O interface (e.g. on a robot arm). The EtherCAT connection is established via screened M8 connectors.

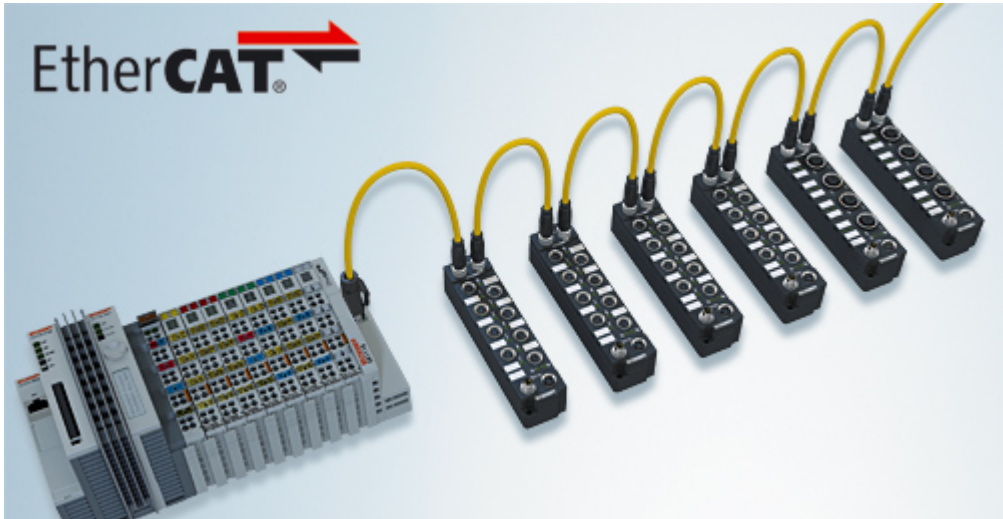

Fig. 1: EtherCAT Box Modules within an EtherCAT network

The robust design of the EtherCAT Box modules enables them to be used directly at the machine. Control cabinets and terminal boxes are now no longer required. The modules are fully sealed and therefore ideally prepared for wet, dirty or dusty conditions.

Pre-assembled cables significantly simplify EtherCAT and signal wiring. Very few wiring errors are made, so that commissioning is optimized. In addition to pre-assembled EtherCAT, power and sensor cables, field-configurable connectors and cables are available for maximum flexibility. Depending on the application, the sensors and actuators are connected through M8 or M12 connectors.

The EtherCAT modules cover the typical range of requirements for I/O signals with protection class IP67:

- digital inputs with different filters (3.0 ms or 10  $\mu$ s)
- digital outputs with 0.5 or 2 A output current
- analog inputs and outputs with 16 bit resolution
- Thermocouple and RTD inputs
- Stepper motor modules

XFC (eXtreme Fast Control Technology) modules, including inputs with time stamp, are also available.



Fig. 2: EtherCAT Box with M8 connections for sensors/actuators



Fig. 3: EtherCAT Box with M12 connections for sensors/actuators

---

● **Basic EtherCAT documentation**

**i** You will find a detailed description of the EtherCAT system in the Basic System Documentation for EtherCAT, which is available for download from our website ([www.beckhoff.com](http://www.beckhoff.com)) under Downloads.

---

### 3 Product overview

The following table shows the products described in this documentation and the main distinguishing features.

Module	Number inputs	Filter	Signal connection	EtherCAT connection	Comment
<a href="#">EP1008-0001 [▶ 14]</a>	8	3.0 ms	8x M8 socket	M8	
<a href="#">EP1008-0002 [▶ 14]</a>	8	3.0 ms	4x M12 socket	M8	
<a href="#">EP1008-0022 [▶ 19]</a>	8	3.0 ms	8x M12 socket	M8	
<a href="#">EP1018-0001 [▶ 14]</a>	8	10 µs	8x M8 socket	M8	
<a href="#">EP1018-0002 [▶ 14]</a>	8	10 µs	4x M12 socket	M8	
<a href="#">EP1098-0001 [▶ 23]</a>	8	10 µs	8x M8 socket	M8	ground switching
<a href="#">EP1258-0001 [▶ 28]</a>	8	10 µs	8x M8 socket	M8	2 inputs with timestamp
<a href="#">EP1258-0002 [▶ 28]</a>	8	10 µs	4x M12 socket	M8	2 inputs with timestamp
<a href="#">EP1809-0021 [▶ 33]</a>	16	3.0 ms	16x M8 socket	M8	
<a href="#">EP1809-0022 [▶ 34]</a>	16	3.0 ms	8x M12 socket	M8	
<a href="#">EP1809-0042 [▶ 38]</a>	16	3.0 ms	8x M12 socket	M12	
<a href="#">EP1816-0003 [▶ 42]</a>	16	10 µs	2x ZS2001	M8	Pluggable spring-loaded terminals
<a href="#">EP1816-0008 [▶ 46]</a>	16	10 µs	1x D-sub socket, 25-pin	M8	
<a href="#">EP1816-1008 [▶ 46]</a>	16	10 µs	1x D-sub socket, 25-pin	M8	Undervoltage detection
<a href="#">EP1816-3008 [▶ 46]</a>	16	10 µs	1x D-sub socket, 25-pin	M8	Undervoltage detection, accelerometers
<a href="#">EP1819-0005 [▶ 55]</a>	16	10 µs	8x M8 socket	M8	Evaluation of up to eight antivalent sensors.
<a href="#">EP1819-0021 [▶ 33]</a>	16	10 µs	16x M8 socket	M8	
<a href="#">EP1819-0022 [▶ 34]</a>	16	10 µs	8x M12 socket	M8	
<a href="#">EP1839-0042 [▶ 59]</a>	16	adjustable	8x M12 socket	M12	Switchable sensor power supply, extended diagnostics.
<a href="#">EP1859-0042 [▶ 70]</a>	8	3.0 ms	8x M12 socket	M12	8 digital outputs

### 3.1 EP1008, EP1018

#### 3.1.1 Introduction

##### EP1008-0001, EP1018-0001

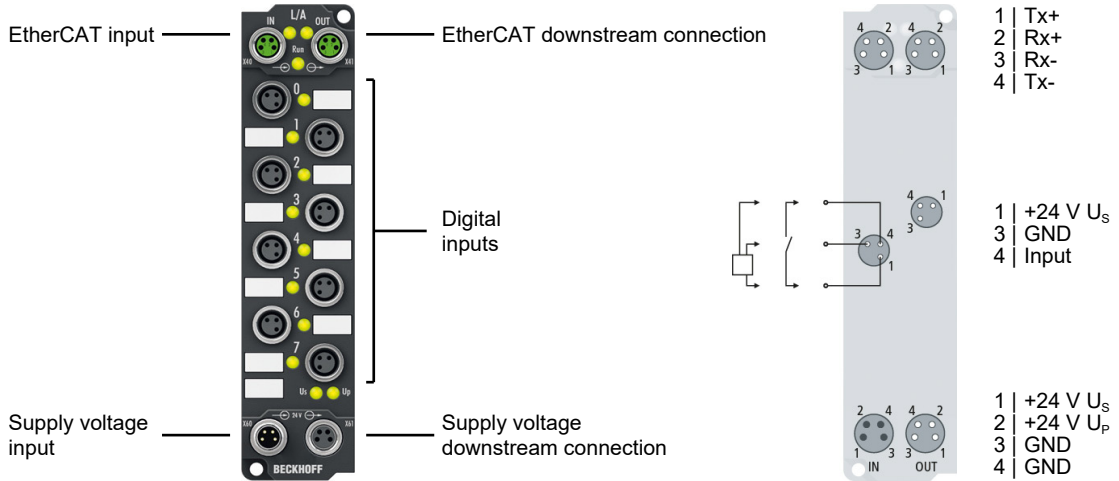

##### EP1008-0002, EP1018-0002

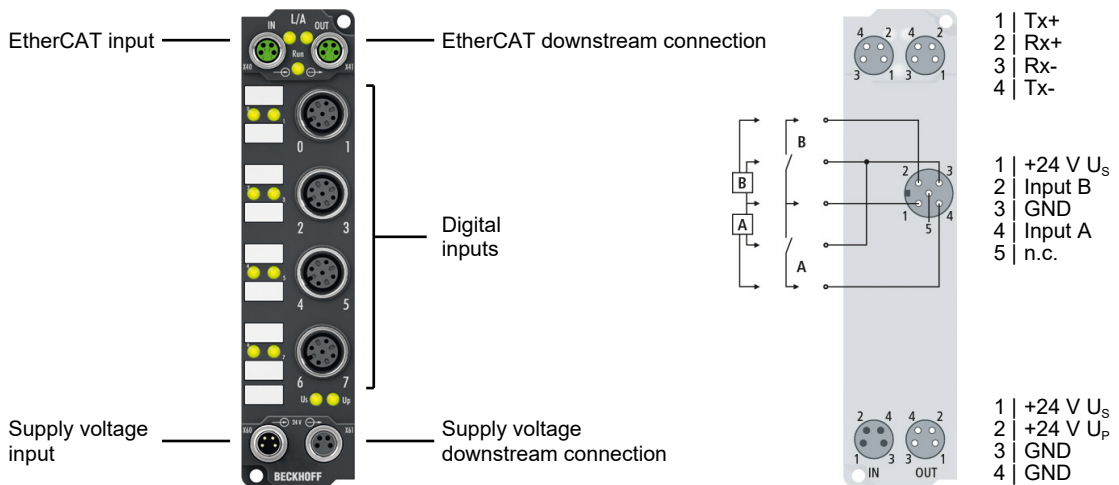

#### 8 digital inputs 24 V<sub>DC</sub>

The EP1008 and EP1018 EtherCAT Box modules with digital inputs acquire binary control signals from the process level, and transfer them, electrically isolated, to the controller.

The status of the signal is displayed by light emitting diodes; the signal connection is made optionally through M8 connectors (EP1008-0001, EP1018-0001) or M12 connectors (EP1008-0002, EP1018-0002, EP1008-0022). These versions have input filters of different speeds.

The sensors are supplied from the control voltage U<sub>s</sub>. The load voltage U<sub>p</sub> is not used in the input module, but may be connected in order to be relayed downstream.

**Quick links**

EP1008-0001:

[Technical data \[▶ 16\]](#)[Process image \[▶ 18\]](#)[Dimensions \[▶ 76\]](#)[Signal connection \[▶ 88\]](#)

EP1008-0002:

[Technical data \[▶ 16\]](#)[Process image \[▶ 18\]](#)[Dimensions \[▶ 76\]](#)[Signal connection \[▶ 92\]](#)

EP1018-0001:

[Technical data \[▶ 16\]](#)[Process image \[▶ 18\]](#)[Dimensions \[▶ 76\]](#)[Signal connection \[▶ 88\]](#)

EP1018-0002:

[Technical data \[▶ 16\]](#)[Process image \[▶ 18\]](#)[Dimensions \[▶ 76\]](#)[Signal connection \[▶ 92\]](#)

### 3.1.2 Technical data - EP1008, EP1018

All values are typical values over the entire temperature range, unless stated otherwise.

EtherCAT	
Connection	2 x M8 socket, 4-pin, A-coded, shielded
Electrical isolation	500 V

Supply voltages	
Connection	Input: M8 connector, 4-pin, A-coded Downstream connection: M8 socket, 4-pin, A-coded
$U_S$ nominal voltage	24 V <sub>DC</sub> (-15 % / +20 %)
$U_S$ sum current: $I_{S,sum}$	max. 4 A
Current consumption from $U_S$	120 mA + sensor power supply
$U_P$ nominal voltage	24 V <sub>DC</sub> (-15 % / +20 %)
$U_P$ sum current: $I_{P,sum}$	max. 4 A
Electrical isolation GND <sub>S</sub> / GND <sub>P</sub>	no

Digital inputs	EP1008-0001	EP1008-0002	EP1018-0001	EP1018-0002
Number of inputs	8			
Connection	8 x M8 socket, 3-pin, A-coded	4 x M12 socket, 5-pin, A-coded	8 x M8 socket, 3-pin, A-coded	4 x M12 socket, 5-pin, A-coded
Cable length	max. 30 m			
Characteristics	Type 3 according to EN 61131-2, compatible with type 1			
Nominal voltage	24 V <sub>DC</sub> (-15 % / +20 %)			
Input filter	3.0 ms	3.0 ms	10 μs	10 μs
Signal voltage "0"	-3 ... +5 V			
Signal voltage "1"	+11 ... +30 V			
Input current	3 mA			
Sensor power supply	24 V <sub>DC</sub> from $U_S$ max. 0.5 A, short-circuit proof in total			

Housing data	
Dimensions W x H x D	30 mm x 126 mm x 26.5 mm (without connectors)
Weight	approx. 165 g
Installation position	variable
Material	PA6 (polyamide)

Environmental conditions	
Ambient temperature during operation	-25 ... +60 °C -25 ... +55 °C according to cURus 0 ... +55 °C according to ATEX
Ambient temperature during storage	-40 ... +85 °C
Vibration resistance, shock resistance	conforms to EN 60068-2-6 / EN 60068-2-27 <a href="#">Additional tests [► 17]</a>
EMC immunity / emission	conforms to EN 61000-6-2 / EN 61000-6-4
Protection rating	IP65, IP66, IP67 (according to EN 60529)

Approvals / markings	
Approvals / markings <sup>*)</sup>	ATEX [ <a href="#">► 107</a> ], CE, cURus [ <a href="#">► 106</a> ]



\*) Real applicable approvals/markings see type plate on the side (product marking).

**Additional tests**

The devices have undergone the following additional tests:

Test	Explanation
Vibration	10 frequency sweeps in 3 axes
	5 Hz < f < 60 Hz displacement 0.35 mm, constant amplitude
	60.1 Hz < f < 500 Hz acceleration 5 g, constant amplitude
Shocks	1000 shocks in each direction, in 3 axes
	35 g, 11 ms

**3.1.3 Scope of supply - EP1008, EP1018**

Make sure that the following components are included in the scope of delivery:

- 1x EtherCAT Box
- 2x protective cap for EtherCAT socket, M8, green (pre-assembled)
- 1x protective cap for supply voltage input, M8, transparent (pre-assembled)
- 1x protective cap for supply voltage output, M8, black (pre-assembled)
- 10x labels, blank (1 strip of 10)

---

**i Pre-assembled protective caps do not ensure IP67 protection**

Protective caps are pre-assembled at the factory to protect connectors during transport. They may not be tight enough to ensure IP67 protection.

Ensure that the protective caps are correctly seated to ensure IP67 protection.

---

### 3.1.4 Process image - EP1008-000x

#### Channel 1 to Channel 8

You will find the 8 digital inputs to the module (here using the EP1008-0001 as an example) under **Channel 1 to Channel 8**.

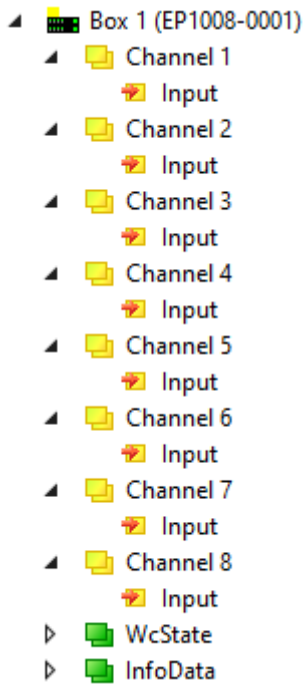
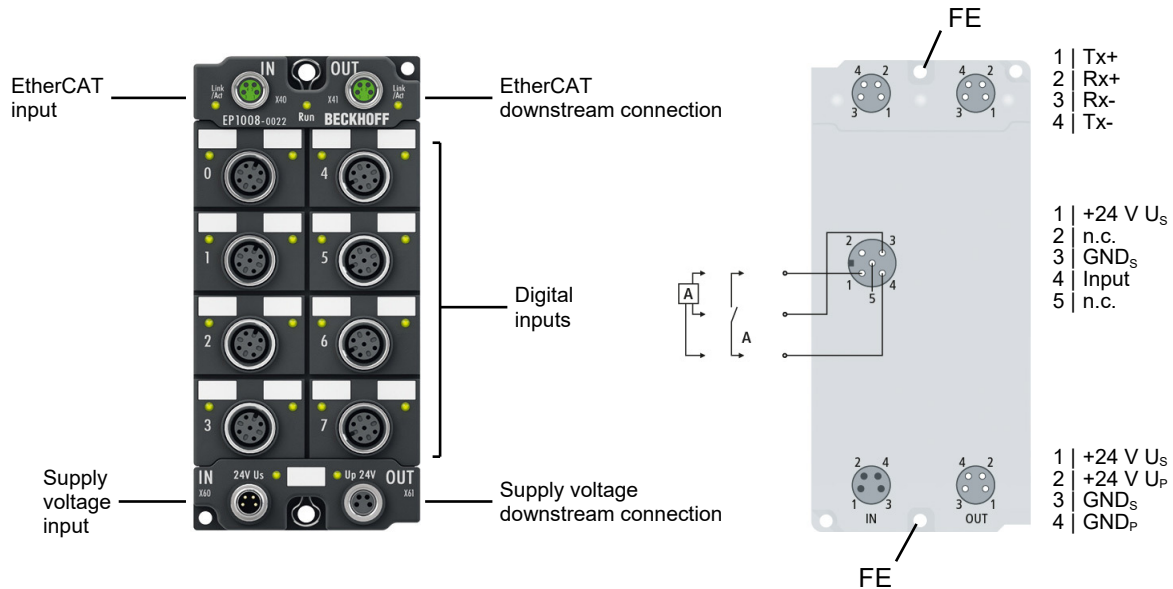

Fig. 4: EP1008-00xx, process image

## 3.2 EP1008-0022

### 3.2.1 Introduction



The EP1008-0022 EtherCAT Box with digital inputs acquires binary control signals from the process level and transfers them, with electrical isolation, to the controller. The signal state is displayed by LEDs; the signals are connected via screwable M12 connectors. One digital input is available for each M12 socket.

The sensors are supplied from the control voltage  $U_S$ . The load voltage  $U_P$  is not used in the input module, but it can optionally be connected for forwarding and is fed through to the next device.

The connected sensors are supplied via an internal, short-circuit proof driver block with a total of 0.5 A for all sensors.

Due to the input filter of 3.0 ms, the EP1008-0022 is particularly suitable for electronic and mechanical inputs, which undergo additional debouncing of the signal as a result.

#### Quick links

[Technical data](#) [▶ 20]

[Process image](#) [▶ 22]

[Dimensions](#) [▶ 77]

[Signal connection](#) [▶ 93]

### 3.2.2 Technical data - EP1008-0022

All values are typical values over the entire temperature range, unless stated otherwise.

EtherCAT	
Connection	2 x M8 socket, 4-pin, A-coded, shielded
Electrical isolation	500 V

Supply voltages	
Connection	Input: M8 connector, 4-pin, A-coded Downstream connection: M8 socket, 4-pin, A-coded
$U_S$ nominal voltage	24 V <sub>DC</sub> (-15 % / +20 %)
$U_S$ sum current: $I_{S,sum}$	max. 4 A
Current consumption from $U_S$	120 mA + sensor power supply
$U_P$ nominal voltage	24 V <sub>DC</sub> (-15 % / +20 %)
$U_P$ sum current: $I_{P,sum}$	max. 4 A
Electrical isolation GND <sub>S</sub> / GND <sub>P</sub>	yes

Digital inputs	
Number of inputs	8
Connection	4x M12 socket, 5-pin, A-coded
Cable length	max. 30 m
Characteristics	Type 3 according to EN 61131-2, compatible with type 1
Nominal voltage	24 V <sub>DC</sub> (-15 % / +20 %)
Input filter	3.0 ms
Signal voltage "0"	-3 ... +5 V
Signal voltage "1"	+11 ... +30 V
Input current	3 mA
Sensor power supply	24 V <sub>DC</sub> from $U_S$ max. 0.5 A, short-circuit proof in total

Housing data	
Dimensions W x H x D	60 mm x 126 mm x 26.5 mm (without plug connectors)
Weight	approx. 250 g
Installation position	variable
Material	PA6 (polyamide)

Environmental conditions	
Ambient temperature during operation	-25 ... +60 °C -25 ... +55 °C according to cURus
Ambient temperature during storage	-40 ... +85 °C
Vibration resistance, shock resistance	conforms to EN 60068-2-6 / EN 60068-2-27 Additional tests [► 21]
EMC immunity / emission	conforms to EN 61000-6-2 / EN 61000-6-4
Protection class	IP65, IP66, IP67 (conforms to EN 60529)

Approvals/markings	
Approvals/markings *)	CE, cURus [► 106]

\*) Real applicable approvals/markings see type plate on the side (product marking).

**Additional tests**

The devices have undergone the following additional tests:

Test	Explanation
Vibration	10 frequency sweeps in 3 axes
	5 Hz < f < 60 Hz displacement 0.35 mm, constant amplitude
	60.1 Hz < f < 500 Hz acceleration 5 g, constant amplitude
Shocks	1000 shocks in each direction, in 3 axes
	35 g, 11 ms

**3.2.3 Scope of supply - EP1008-0022**

Make sure that the following components are included in the scope of delivery:

- 1x EP1008-0022 EtherCAT Box
- 2x protective cap for EtherCAT socket, M8, green (pre-assembled)
- 1x protective cap for supply voltage input, M8, transparent (pre-assembled)
- 1x protective cap for supply voltage output, M8, black (pre-assembled)
- 10x labels, blank (1 strip of 10)

---

**● Pre-assembled protective caps do not ensure IP67 protection**

**i** Protective caps are pre-assembled at the factory to protect connectors during transport. They may not be tight enough to ensure IP67 protection.



















Ensure that the protective caps are correctly seated to ensure IP67 protection.

---

### 3.2.4 Process image - EP1008-0022

#### Channel 1 to Channel 8

Under "Channel 1" to "Channel 8" you will find the 8 digital inputs of the module.

- ▲  Box 1 (EP1008-0022)
  - ▲  Channel 1
    - ▲  Input
  - ▲  Channel 2
    - ▲  Input
  - ▲  Channel 3
    - ▲  Input
  - ▲  Channel 4
    - ▲  Input
  - ▲  Channel 5
    - ▲  Input
  - ▲  Channel 6
    - ▲  Input
  - ▲  Channel 7
    - ▲  Input
  - ▲  Channel 8
    - ▲  Input
  - ▶  WcState
  - ▶  InfoData

### 3.3 EP1098-0001

#### 3.3.1 Introduction

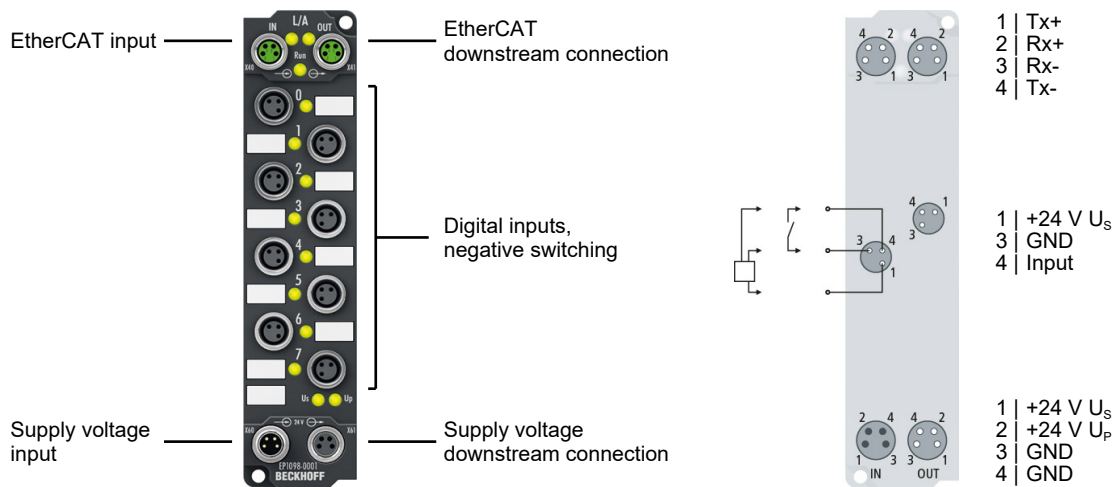

#### 8 digital inputs, 24 V<sub>DC</sub>, ground switching

The EP1098-0001 and EP1098-0002 EtherCAT Box modules with digital inputs acquire binary control signals from the process level, and transfer them, electrically isolated, to the controller. The signal state is displayed by light emitting diodes; the signal connection is made optionally through M8 connectors (EP1098-0001) or M12 connectors (EP1098-0002)

The sensors are supplied from the control voltage U<sub>S</sub>. The load voltage U<sub>P</sub> is not used in the input module, but it can optionally be connected for forwarding and is fed through to the next device.

#### Quick links

- [Technical data \[▶ 24\]](#)
- [Process image \[▶ 27\]](#)
- [Dimensions \[▶ 76\]](#)
- [Signal connection \[▶ 88\]](#)

### 3.3.2 Technical data - EP1098-0001

All values are typical values over the entire temperature range, unless stated otherwise.

EtherCAT	
Connection	2 x M8 socket, 4-pin, A-coded, shielded
Electrical isolation	500 V

Supply voltages	
Connection	Input: M8 connector, 4-pin, A-coded Downstream connection: M8 socket, 4-pin, A-coded
$U_S$ nominal voltage	24 V <sub>DC</sub> (-15 % / +20 %)
$U_S$ sum current: $I_{S,sum}$	max. 4 A
Current consumption from $U_S$	120 mA + sensor supply
Rated voltage $U_P$	24 V <sub>DC</sub> (-15 % / +20 %)
$U_P$ sum current: $I_{P,sum}$	max. 4 A
Current consumption from $U_P$	None. $U_P$ is only forwarded.
Electrical isolation GND <sub>S</sub> / GND <sub>P</sub>	no

Digital inputs, ground switching	
Number	8
Connection	8 x M8 socket, 3-pin, A-coded
Cable length	max. 30 m
Nominal input voltage	24 V <sub>DC</sub> (-15 %/+20 %)
Input filter	10 μs
Characteristics	ground switching
Signal voltage "0"	11 ... 30 V
Signal voltage "1"	0 ... 7 V
Input current	typically 3 mA (EN 61131-2, type 3)
Sensor power supply	24 V <sub>DC</sub> from $U_S$ max. 0.5 A, short-circuit proof in total

Housing data	
Dimensions W x H x D	30 mm x 126 mm x 26.5 mm (without connectors)
Weight	approx. 165 g
Installation position	variable
Material	PA6 (polyamide)

Environmental conditions	
Ambient temperature during operation	-25 ... +60 °C -25 ... +55 °C according to cURus
Ambient temperature during storage	-40 ... +85 °C
Vibration resistance, shock resistance	conforms to EN 60068-2-6 / EN 60068-2-27 Additional tests [► 25]
EMC immunity / emission	conforms to EN 61000-6-2 / EN 61000-6-4
Protection class	IP65, IP66, IP67 (conforms to EN 60529)

Approvals/markings	
Approvals/markings *)	CE, cURus [► 106]

\*) Real applicable approvals/markings see type plate on the side (product marking).



**Additional tests**

The devices have undergone the following additional tests:

Test	Explanation
Vibration	10 frequency sweeps in 3 axes
	5 Hz < f < 60 Hz displacement 0.35 mm, constant amplitude
	60.1 Hz < f < 500 Hz acceleration 5 g, constant amplitude
Shocks	1000 shocks in each direction, in 3 axes
	35 g, 11 ms

### 3.3.3 Scope of supply - EP1098-0001

Make sure that the following components are included in the scope of delivery:

- 1x EtherCAT Box EP1098-0001
- 2x protective cap for EtherCAT socket, M8, green (pre-assembled)
- 1x protective cap for supply voltage input, M8, transparent (pre-assembled)
- 1x protective cap for supply voltage output, M8, black (pre-assembled)
- 10x labels, blank (1 strip of 10)

---

● **Pre-assembled protective caps do not ensure IP67 protection**

**i** Protective caps are pre-assembled at the factory to protect connectors during transport. They may not be tight enough to ensure IP67 protection.

Ensure that the protective caps are correctly seated to ensure IP67 protection.

---

### 3.3.4 Process image - EP1098-0001

#### Channel 1 to Channel 8

You will find the 8 digital inputs to the module (here using the EP1098-0001 as an example) under **Channel 1 to Channel 8**.

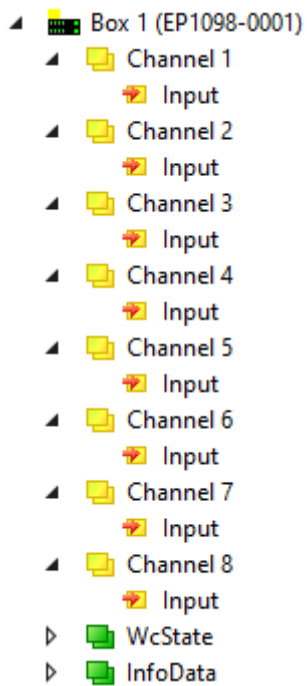
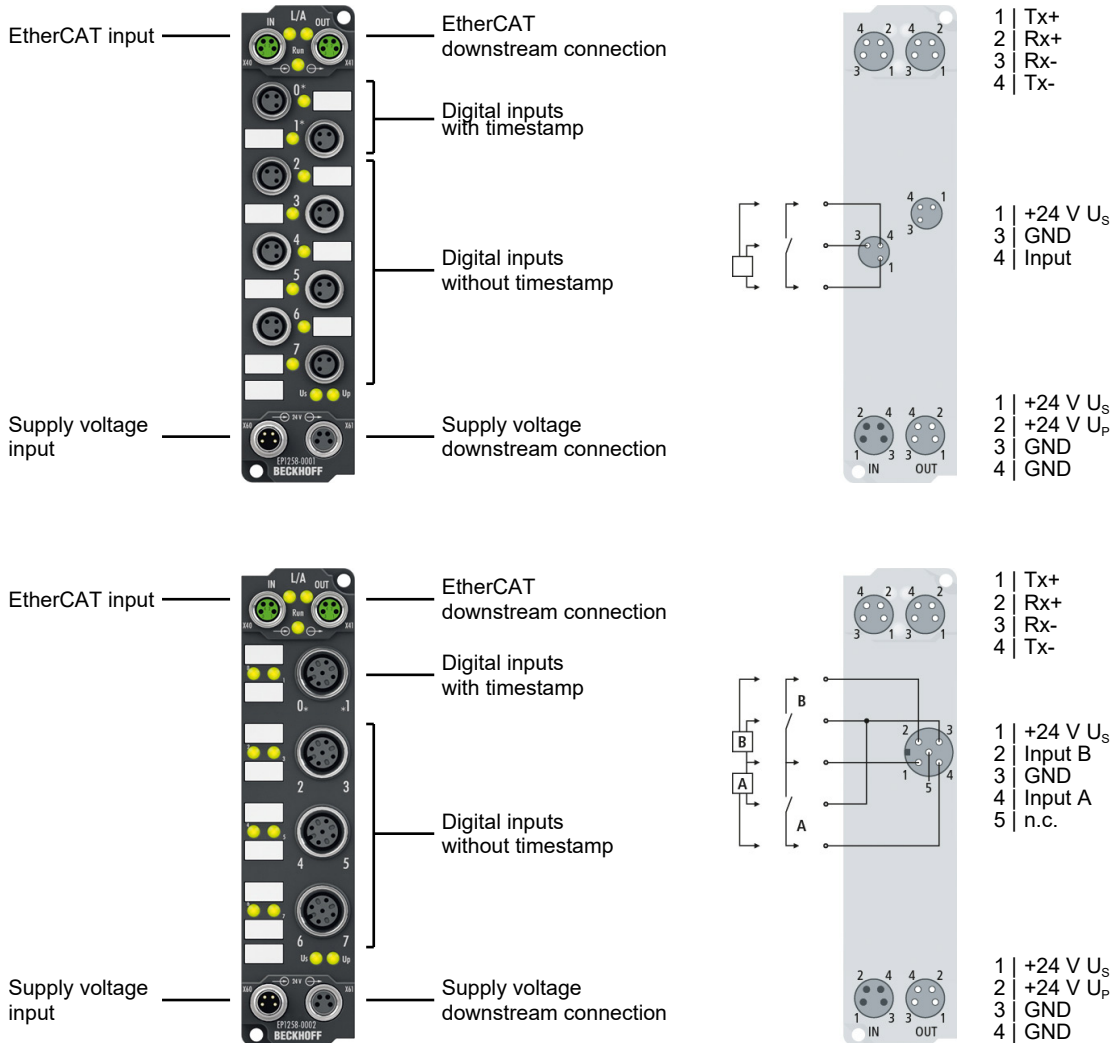

Fig. 5: EP1098-0001, Process image

### 3.4 EP1258-000x

#### 3.4.1 Introduction



#### 8 digital inputs 24 V<sub>DC</sub> (two channels with time stamp)

The EP1258 EtherCAT Box with digital inputs acquires fast binary control signals from the process level and transmits them, electrically isolated, to the controller.

The status of the signal is displayed by light emitting diodes; the signal connection is made optionally through M8 connectors (EP1258-0001) or M12 connectors (EP1258-0002). Both modules have 10 μs input filters.

The sensors are supplied from the control voltage  $U_s$ . The peripheral voltage  $U_p$  is not used in the input module, but may be connected in order to be relayed downstream.

#### Distributed Clocks

Channels 0 and 1 are assigned a time stamp that shows the time of the last edge change with a resolution of 1 ns. This technology enables signals to be traced exactly over time and synchronized with the clocks distributed across the system. With this technology, machine-wide parallel hardware wiring of digital inputs or encoder signals for synchronization purposes is often no longer required. As a result, equally timed reactions, independent of the bus cycle time, are to a large extent possible. Distributed Clocks in the EtherCAT system documentation.

**Quick links**

EP1258-0001

[Technical data \[▶ 30\]](#)[Dimensions \[▶ 76\]](#)[Signal connection \[▶ 88\]](#)

EP1258-0002

[Technical data \[▶ 30\]](#)[Dimensions \[▶ 76\]](#)[Signal connection \[▶ 92\]](#)

### 3.4.2 Technical data - EP1258-000x

All values are typical values over the entire temperature range, unless stated otherwise.

EtherCAT	
Connection	2 x M8 socket, 4-pin, A-coded, shielded
Electrical isolation	500 V
Distributed Clocks	yes

Supply voltages	
Connection	Input: M8 connector, 4-pin, A-coded Downstream connection: M8 socket, 4-pin, A-coded
$U_S$ nominal voltage	24 V <sub>DC</sub> (-15 % / +20 %)
$U_S$ sum current: $I_{S,sum}$	max. 4 A
Current consumption from $U_S$	120 mA + sensor supply
Rated voltage $U_P$	24 V <sub>DC</sub> (-15 % / +20 %)
$U_P$ sum current: $I_{P,sum}$	max. 4 A
Current consumption from $U_P$	None. $U_P$ is only forwarded.
Electrical isolation GND <sub>S</sub> / GND <sub>P</sub>	no

Digital inputs	EP1258-0001	EP1258-0002
Number	8, of which 2 are Timestamp inputs	
Connection	8 x M8 socket, 3-pin, A-coded	4 x M12 socket, 5-pin, A-coded
Cable length	max. 30 m	
Nominal input voltage	24 V <sub>DC</sub> (-15 %/+20 %)	
Input filter	10 μs	
Signal voltage "0"	-3 ... +5 V (similar to EN 61131-2, type 3)	
Signal voltage "1"	+11 ... +30 V (similar to EN 61131-2, type 3)	
Input current	typically 3 mA (similar to EN 61131-2, type 3)	
Sensor power supply	24 V <sub>DC</sub> from $U_S$ max. 0.5 A, short-circuit proof in total	
Timestamp resolution	1 ns (Channel 0/1)	
Precision of the timestamp	10 ns (+ input delay) (Channel 0/1)	
Precision of the distributed clocks	< 100 ns (Channel 0/1)	

Housing data	
Dimensions W x H x D	30 mm x 126 mm x 26.5 mm (without connectors)
Weight	approx. 165 g
Installation position	variable
Material	PA6 (polyamide)

Environmental conditions	
Ambient temperature during operation	-25 ... +60 °C -25 ... +55 °C according to cURus
Ambient temperature during storage	-40 ... +85 °C
Vibration resistance, shock resistance	conforms to EN 60068-2-6 / EN 60068-2-27 <a href="#">Additional tests [► 31]</a>
EMC immunity / emission	conforms to EN 61000-6-2 / EN 61000-6-4
Protection class	IP65, IP66, IP67 (conforms to EN 60529)

Approvals/markings	
Approvals/markings *)	CE, cURus [▶ 106]

\*) Real applicable approvals/markings see type plate on the side (product marking).

**Additional tests**

The devices have undergone the following additional tests:

Test	Explanation
Vibration	10 frequency sweeps in 3 axes
	5 Hz < f < 60 Hz displacement 0.35 mm, constant amplitude
	60.1 Hz < f < 500 Hz acceleration 5 g, constant amplitude
Shocks	1000 shocks in each direction, in 3 axes
	35 g, 11 ms

### 3.4.3 Scope of supply - EP1258-000x

Make sure that the following components are included in the scope of delivery:

- 1x EtherCAT Box EP1258-000x
- 2x protective cap for EtherCAT socket, M8, green (pre-assembled)
- 1x protective cap for supply voltage input, M8, transparent (pre-assembled)
- 1x protective cap for supply voltage output, M8, black (pre-assembled)
- 10x labels, blank (1 strip of 10)

#### ● Pre-assembled protective caps do not ensure IP67 protection

**I** Protective caps are pre-assembled at the factory to protect connectors during transport. They may not be tight enough to ensure IP67 protection.

Ensure that the protective caps are correctly seated to ensure IP67 protection.

### 3.4.4 Process image - EP1258-0001

#### Channel 1 to Channel 8

You will find the 8 digital inputs to the module (here using the EP1258-0001 as an example) under **Channel 1 to Channel 8**.

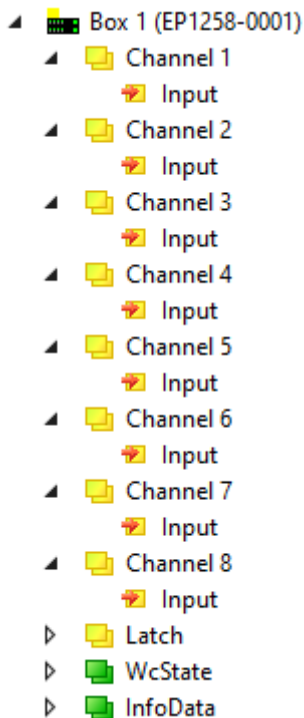
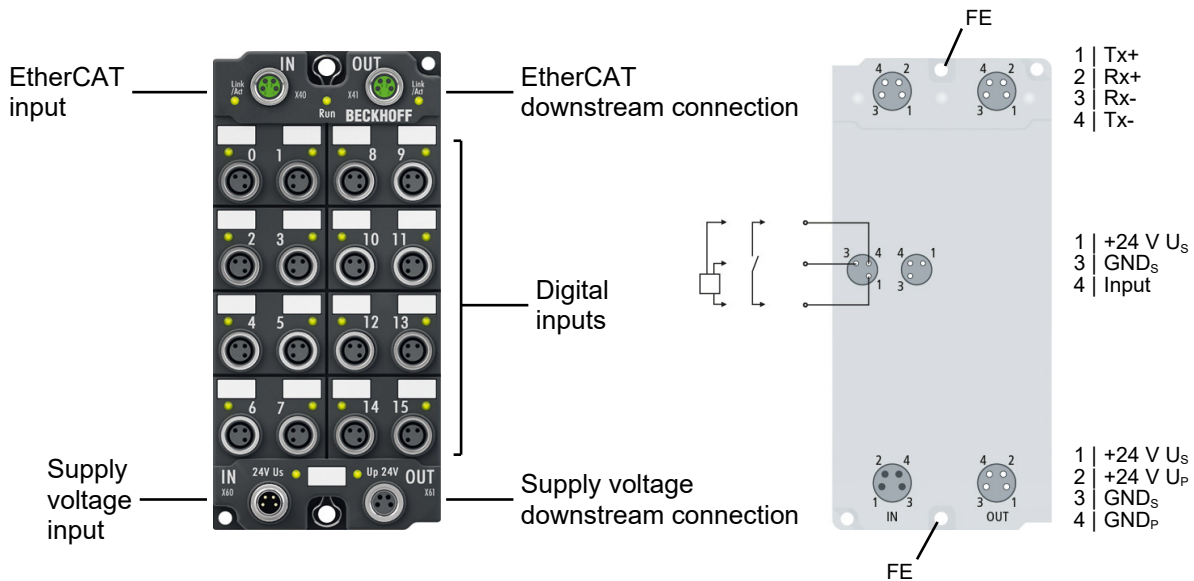

Fig. 6: EP1258-0001, Process image



### 3.5 EP1809, EP1819

#### 3.5.1 Introduction - EP1809-0021, EP1819-0021



#### 16 digital inputs 24 V<sub>DC</sub>

The EtherCAT modules EP1809-0021 and EP1819-0021 with digital inputs acquire binary control signals from the process level and transmit them, in an electrically isolated form, to the controller. The state of the signals is indicated by light emitting diodes. The signals are connected via M8 connectors.

The sensors are supplied from the box supply voltage  $U_S$ . The auxiliary voltage  $U_P$  is not used in the input module, but may be connected in order to be relayed downstream.

#### Quick links

- [Technical data \[▶ 35\]](#)
- [Process image \[▶ 37\]](#)
- [Dimensions \[▶ 77\]](#)
- [Functional earth \(FE\) \[▶ 80\]](#)
- [Signal connection \[▶ 88\]](#)

### 3.5.2 Introduction - EP1809-0022, EP1819-0022

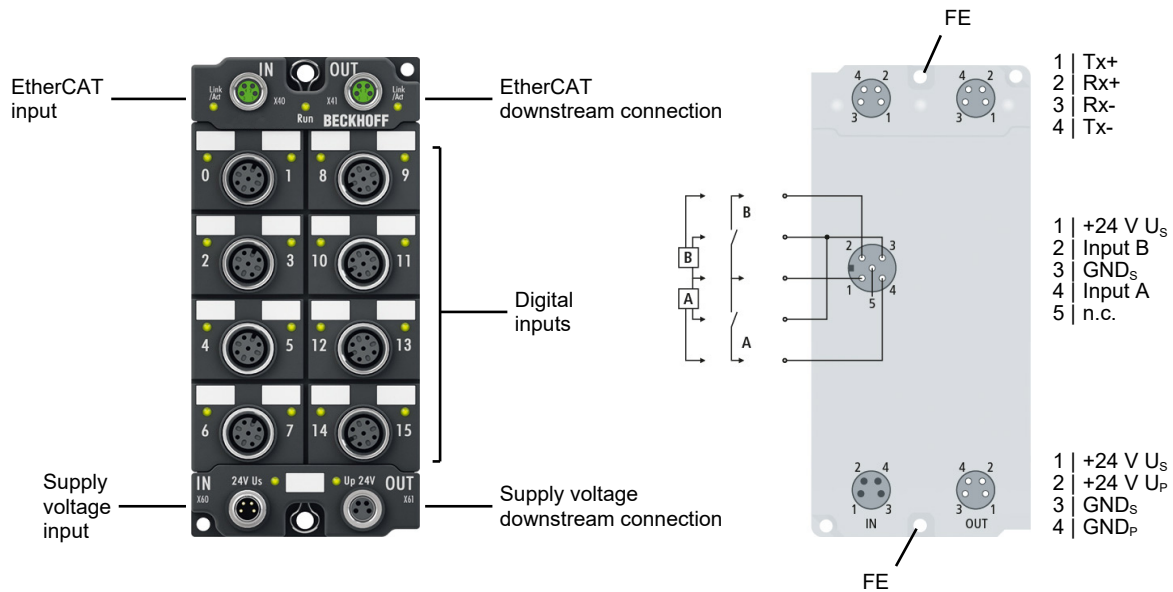

#### 16 digital inputs 24 V<sub>DC</sub>

The EP1809-0022 and EP1819-0022 modules with digital inputs acquire the binary control signals from the process level and transmit them, in an electrically isolated form, to the controller. The state of the signals is indicated by light emitting diodes. The signals are connected via M12 connectors. These versions are distinguished by input filters of different speeds.

The sensors are supplied from the box supply voltage  $U_S$ . The auxiliary voltage  $U_P$  is not used in the input module, but may be connected in order to be relayed downstream.

#### Quick links

[Technical data](#) [▶ 35]

[Process image](#) [▶ 37]

[Dimensions](#) [▶ 77]

[Functional earth \(FE\)](#) [▶ 80]

[Signal connection](#) [▶ 94]

### 3.5.3 Technical data - EP1809, EP1819

All values are typical values over the entire temperature range, unless stated otherwise.

EtherCAT	
Connection	2 x M8 socket, 4-pin, A-coded, shielded
Electrical isolation	500 V

Supply voltages	
Connection	Input: M8 connector, 4-pin, A-coded Downstream connection: M8 socket, 4-pin, A-coded
U <sub>S</sub> nominal voltage	24 V <sub>DC</sub> (-15 % / +20 %)
U <sub>S</sub> sum current: I <sub>S,sum</sub>	max. 4 A
Current consumption from U <sub>S</sub>	130 mA
Rated voltage U <sub>P</sub>	24 V <sub>DC</sub> (-15 % / +20 %)
U <sub>P</sub> sum current: I <sub>P,sum</sub>	max. 4 A
Current consumption from U <sub>P</sub>	None. U <sub>P</sub> is only forwarded.
Electrical isolation GND <sub>S</sub> / GND <sub>P</sub>	yes

Digital inputs	EP1809-0021	EP1809-0022	EP1819-0021	EP1819-0022
Number	16			
Input connections	16 x M8 socket, 3-pin, A-coded	8 x M12 socket, 5-pin, A-coded	16 x M8 socket, 3-pin, A-coded	8 x M12 socket, 5-pin, A-coded
Cable length	max. 30 m			
Nominal input voltage	24 V <sub>DC</sub> (-15 %/+20 %)			
Input filter	3 ms	3 ms	10 μs	10 μs
Signal voltage "0"	-3 ... +5 V (similar to EN 61131-2, type 3)			
Signal voltage "1"	+11 ... +30 V (similar to EN 61131-2, type 3)			
Input current	3 mA (similar to EN 61131-2, type 3)			
Sensor power supply	24 V <sub>DC</sub> from U <sub>S</sub> max. 0.5 A, short-circuit proof in total			

Housing data	
Dimensions W x H x D	60 mm x 126 mm x 26.5 mm (without plug connectors)
Weight	approx. 250 g
Installation position	variable
Material	PA6 (polyamide)

Environmental conditions	
Ambient temperature during operation	-25 ... +60 °C -25 ... +55 °C according to cURus
Ambient temperature during storage	-40 ... +85 °C
Vibration resistance, shock resistance	conforms to EN 60068-2-6 / EN 60068-2-27 <a href="#">Additional tests [► 36]</a>
EMC immunity / emission	conforms to EN 61000-6-2 / EN 61000-6-4
Protection class	IP65, IP66, IP67 (conforms to EN 60529)

Approvals/markings	
Approvals/markings <sup>1)</sup>	CE, cURus [ <a href="#">► 106</a> ]

\*) Real applicable approvals/markings see type plate on the side (product marking).

### Additional tests

The devices have undergone the following additional tests:

Test	Explanation
Vibration	10 frequency sweeps in 3 axes
	5 Hz < f < 60 Hz displacement 0.35 mm, constant amplitude
	60.1 Hz < f < 500 Hz acceleration 5 g, constant amplitude
Shocks	1000 shocks in each direction, in 3 axes
	35 g, 11 ms

### 3.5.4 Scope of supply - EP1809, EP1819

Make sure that the following components are included in the scope of delivery:

- 1x EtherCAT Box
- 2x protective cap for EtherCAT socket, M8, green (pre-assembled)
- 1x protective cap for supply voltage input, M8, transparent (pre-assembled)
- 1x protective cap for supply voltage output, M8, black (pre-assembled)
- 10x labels, blank (1 strip of 10)

#### **i** Pre-assembled protective caps do not ensure IP67 protection

Protective caps are pre-assembled at the factory to protect connectors during transport. They may not be tight enough to ensure IP67 protection.

Ensure that the protective caps are correctly seated to ensure IP67 protection.

### 3.5.5 Process image - EP1809-0021

#### Channel 1 to Channel 16

You will find the 16 digital inputs to the module (here using the EP1809-0021 as an example) under **Channel 1 to Channel 16**.





























- ▲  Box 1 (EP1809-0021)
  - ▲  Channel 1
    -  Input
  - ▲  Channel 2
    -  Input
  - ▲  Channel 3
    -  Input
  - ▲  Channel 4
    -  Input
  - ▲  Channel 5
    -  Input
  - ▲  Channel 6
    -  Input
  - ▲  Channel 7
    -  Input
  - ▲  Channel 8
    -  Input
  - ▲  Channel 9
    -  Input
  - ▶  Channel 10
  - ▶  Channel 11
  - ▶  Channel 12
  - ▶  Channel 13
  - ▶  Channel 14
  - ▶  Channel 15
  - ▶  Channel 16
  - ▶  WcState
  - ▶  InfoData

Fig. 7: EP1809-0021, Process image

## 3.6 EP1809-0042

### 3.6.1 Introduction

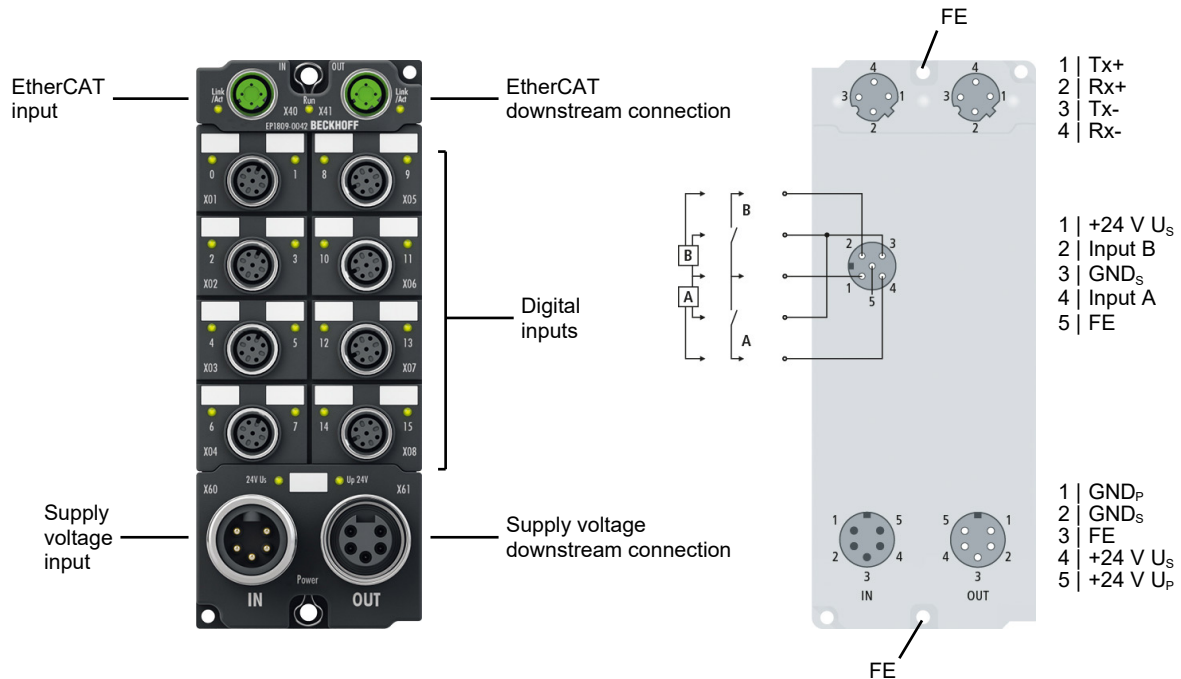

#### 16-channel digital input 24 V<sub>DC</sub>, 3.0 ms

The EP1809-0042 EtherCAT Box with digital inputs acquires the binary control signals from the process level and transmits them, in an electrically isolated form, to the controller. The state of the signals is indicated by light emitting diodes. The signals are connected via M12 screw type connectors.

The sensors are supplied from the box supply voltage  $U_S$ . The auxiliary voltage  $U_P$  is not used in the input module, but may be connected in order to be relayed downstream.

The EP1809-0042 is interference-free. You can use the EP1809-0042 instead of an interference-free standard terminal in accordance with the following chapter of the [TwinSAFE Application Guide](#):

- "All-pole disconnection of a potential group with downstream interference-free standard terminals (Category 4, PL e)"
- "Single-pole disconnection of a potential group with downstream interference-free standard terminals with fault exclusion (Category 4, PL e)"
- „EL2911 potential group with interference-free standard terminals (Category 4, PL e)"

#### Quick links

[Technical data](#) [▶ 39]

[Process image](#) [▶ 41]

[Dimensions](#) [▶ 78]

[Functional earth \(FE\)](#) [▶ 80]

[Signal connection](#) [▶ 95]

### 3.6.2 Technical data - EP1809-0042

All values are typical values over the entire temperature range, unless stated otherwise.

EtherCAT	
Connection	2 x M12 socket, 4-pin, D-coded, shielded
Electrical isolation	500 V

Supply voltages	
Connection	Input: 7/8" plug, 5-pin, 16-UN thread Downstream connection: 7/8" socket, 5-pin, 16-UN thread
U <sub>s</sub> nominal voltage	24 V <sub>DC</sub> (-15 % / +20 %)
U <sub>s</sub> sum current	max. 16 A at 40 °C
Current consumption from U <sub>s</sub>	130 mA + sensor supply
Rated voltage U <sub>p</sub>	24 V <sub>DC</sub> (-15 % / +20 %)
U <sub>p</sub> sum current	max. 16 A at 40 °C
Current consumption from U <sub>p</sub>	None. U <sub>p</sub> is only forwarded.
Electrical isolation GND <sub>s</sub> / GND <sub>p</sub>	yes

Digital inputs	
Number	16
Connection	8 x M12 socket, 5-pin, A-coded
Cable length	max. 30 m
Nominal input voltage	24 V <sub>DC</sub> (-15 %/+20 %)
Input filter	3 ms
Signal voltage "0"	-3 ... +5 V (similar to EN 61131-2, type 3)
Signal voltage "1"	+11 ... +30 V (similar to EN 61131-2, type 3)
Input current	6 mA (similar to EN 61131-2, type 3)
Supply of the module electronics	from the control voltage U <sub>s</sub>
Current consumption of the module electronics	130 mA
Sensor power supply	24 V <sub>DC</sub> from U <sub>s</sub> max. 0.5 A in total, short-circuit proof

Housing data	
Dimensions W x H x D	60 mm x 150 mm x 26,5 mm (without connectors)
Weight	approx. 440 g
Installation position	variable
Material	PA6 (polyamide)

Environmental conditions	
Ambient temperature during operation	-25 ... +60 °C
Ambient temperature during storage	-40 ... +85 °C
Vibration / shock resistance	conforms to EN 60068-2-6 / EN 60068-2-27
EMC immunity / emission	conforms to EN 61000-6-2 / EN 61000-6-4
Protection class	IP65, IP66, IP67 conforms to EN 60529

Approvals / markings	
Approvals / markings *)	CE, UL under preparation

\*) Real applicable approvals/markings see type plate on the side (product marking).

### Additional tests

The devices have undergone the following additional tests:

Test	Explanation
Vibration	10 frequency sweeps in 3 axes
	5 Hz < f < 60 Hz displacement 0.35 mm, constant amplitude
	60.1 Hz < f < 500 Hz acceleration 5 g, constant amplitude
Shocks	1000 shocks in each direction, in 3 axes
	35 g, 11 ms

### 3.6.3 Scope of supply - EP1809-0042

Make sure that the following components are included in the scope of delivery:

- 1x EtherCAT Box EP1809-0042
- 2x protective cap for EtherCAT socket, M12 (pre-assembled)
- 1x Protective cap for supply voltage output, 7/8", black (pre-fitted)
- 10x labels, blank (1 strip of 10)



#### **Pre-assembled protective caps do not ensure IP67 protection**

Protective caps are pre-assembled at the factory to protect connectors during transport. They may not be tight enough to ensure IP67 protection.

Ensure that the protective caps are correctly seated to ensure IP67 protection.



### 3.6.4 Process image - EP1809-0042

The process image contains a process data object for each digital input.

The name of each process data object contains the name of the socket and the pin number of the corresponding digital input.



































- ▲  Box 1 (EP1809-0042)
  - ▲  DI X01 Pin4
    -  Input
  - ▲  DI X01 Pin2
    -  Input
  - ▲  DI X02 Pin4
    -  Input
  - ▲  DI X02 Pin2
    -  Input
  - ▲  DI X03 Pin4
    -  Input
  - ▲  DI X03 Pin2
    -  Input
  - ▲  DI X04 Pin4
    -  Input
  - ▲  DI X04 Pin2
    -  Input
  - ▲  DI X05 Pin4
    -  Input
  - ▲  DI X05 Pin2
    -  Input
  - ▲  DI X06 Pin4
    -  Input
  - ▲  DI X06 Pin2
    -  Input
  - ▲  DI X07 Pin4
    -  Input
  - ▲  DI X07 Pin2
    -  Input
  - ▲  DI X08 Pin4
    -  Input
  - ▲  DI X08 Pin2
    -  Input
  - ▶  WcState
  - ▶  InfoData

Fig. 8: EP1809-0042 - Process image

### 3.7 EP1816-0003

#### 3.7.1 Introduction

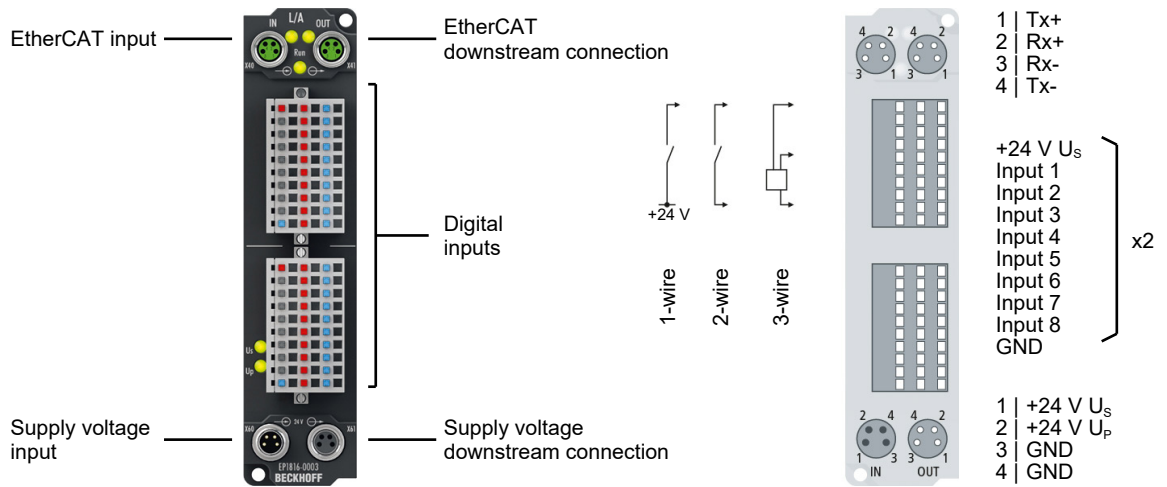

#### EP1816-0003 | 16-channel digital input 24 V DC

The EP1816-0003 EtherCAT Box with digital inputs acquires the binary control signals from the process level and transmits them, in an electrically isolated form, to the controller. The state of the signals is indicated by light emitting diodes. For the signal connection connectors with a spring-loaded system are used, optionally available with 1 or 3 pins. The module is supplied without connectors.

The sensors are supplied from the box supply voltage  $U_S$ . The auxiliary voltage  $U_P$  is not used in the input module, but may be connected in order to be relayed downstream.

#### Quick links

- [Technical data \[▶ 43\]](#)
- [Process image \[▶ 45\]](#)
- [Dimensions \[▶ 76\]](#)
- [Signal connection \[▶ 100\]](#)

### 3.7.2 Technical data - EP1816-0003

All values are typical values over the entire temperature range, unless stated otherwise.

EtherCAT	
Connection	2 x M8 socket, 4-pin, A-coded, shielded
Electrical isolation	500 V
Distributed Clocks	yes

Supply voltages	
Connection	Input: M8 connector, 4-pin, A-coded Downstream connection: M8 socket, 4-pin, A-coded
U <sub>S</sub> nominal voltage	24 V <sub>DC</sub> (-15 % / +20 %)
U <sub>S</sub> sum current: I <sub>S,sum</sub>	max. 4 A
Current consumption from U <sub>S</sub>	120 mA + sensor supply
Rated voltage U <sub>P</sub>	24 V <sub>DC</sub> (-15 % / +20 %)
U <sub>P</sub> sum current: I <sub>P,sum</sub>	max. 4 A
Current consumption from U <sub>P</sub>	None. U <sub>P</sub> is only forwarded.
Electrical isolation GND <sub>S</sub> / GND <sub>P</sub>	no

Digital inputs	
Number	16
Connection	2x pluggable spring-loaded terminal ZS2001 (not included)
Cable length	max. 30 m
Characteristics	Type 3 according to EN 61131-2, compatible with type 1
Nominal input voltage	24 V <sub>DC</sub> (-15 %/+20 %)
Input filter	10 μs
Signal voltage "0"	-3 ... +5 V
Signal voltage "1"	+11 ... +30 V
Input current	typically 6 mA
Sensor power supply	24 V <sub>DC</sub> from U <sub>S</sub> max. 0.5 A, short-circuit proof in total

Housing data	
Dimensions W x H x D	30 mm x 126 mm x 26.5 mm (without connectors)
Weight	approx. 165 g
Installation position	variable
Material	PA6 (polyamide)

Environmental conditions	
Ambient temperature during operation	-25...+60 °C -25...+55 °C according to cURus
Ambient temperature during storage	-40 ... +85 °C
Vibration resistance, shock resistance	conforms to EN 60068-2-6 / EN 60068-2-27 <a href="#">Additional tests [► 44]</a>
EMC immunity / emission	conforms to EN 61000-6-2 / EN 61000-6-4
Protection rating	IP20

Approvals/markings	
Approvals/markings <sup>1)</sup>	CE, cURus [ <a href="#">► 106</a> ]

\*) Real applicable approvals/markings see type plate on the side (product marking).

### Additional tests

The devices have undergone the following additional tests:

Test	Explanation
Vibration	10 frequency sweeps in 3 axes
	5 Hz < f < 60 Hz displacement 0.35 mm, constant amplitude
	60.1 Hz < f < 500 Hz acceleration 5 g, constant amplitude
Shocks	1000 shocks in each direction, in 3 axes
	35 g, 11 ms

### 3.7.3 Scope of supply - EP1816-0003

Make sure that the following components are included in the scope of delivery:

- 1x EtherCAT Box EP1816-0003
- 2x protective cap for EtherCAT socket, M8, green (pre-assembled)
- 1x protective cap for supply voltage input, M8, transparent (pre-assembled)
- 1x protective cap for supply voltage output, M8, black (pre-assembled)
- 10x labels, blank (1 strip of 10)

---

**● Female headers with spring connection not included in the scope of supply**  
**i** You can find suitable types in the chapter [Accessories](#) [▶ 201].

---



---

**● Pre-assembled protective caps do not ensure IP67 protection**  
**i** Protective caps are pre-assembled at the factory to protect connectors during transport. They may not be tight enough to ensure IP67 protection.  
 Ensure that the protective caps are correctly seated to ensure IP67 protection.

---

### 3.7.4 Process image - EP1816-0003

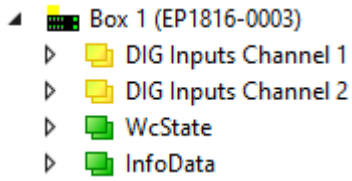
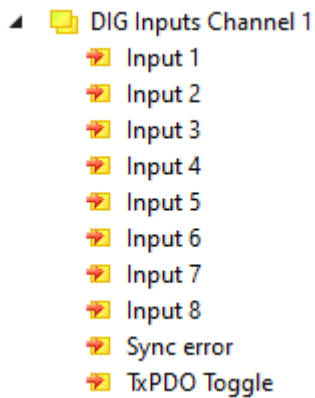



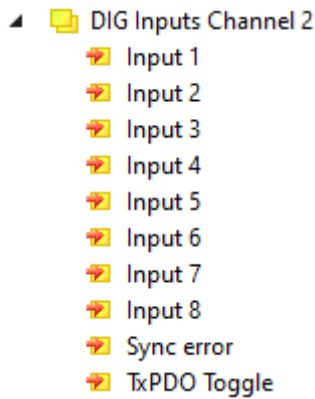

Fig. 9: EP1816-0003 Process image

#### DIG Inputs Channel *n*



-  Input x  
Digital inputs.
-  Sync error  
This bit is only relevant in Distributed Clocks mode.  
It is TRUE if a synchronization error occurred during the elapsed EtherCAT cycle.
-  TxPDO Toggle  
This bit is inverted each time the digital inputs are updated.



### 3.8 EP1816-x008

#### 3.8.1 Introduction

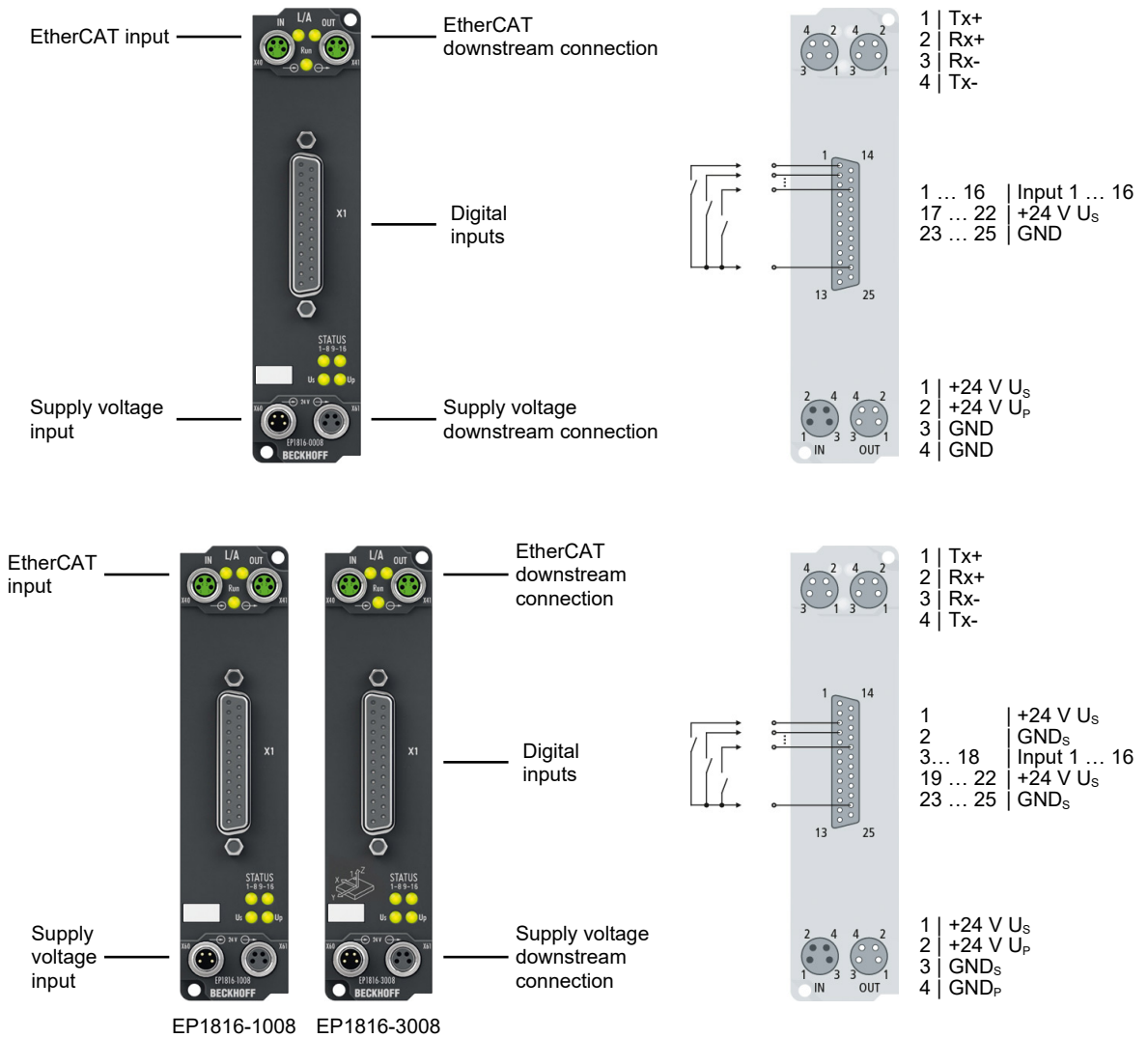

#### EP1816-x008 | 16-channel digital input

The EP1816-x008 EtherCAT Box with digital inputs acquires the binary control signals from the process level and transmits them, in an electrically isolated form, to the controller. The state of the signals is indicated by light emitting diodes. The signals are connected via 25-pin D-sub socket.

The sensors are supplied from the box supply voltage U<sub>S</sub>. The auxiliary voltage U<sub>P</sub> is not used in the input module, but may be connected in order to be relayed downstream.

EP1816-3008 has two internal 3-axis accelerometers with 16 bits and a selectable resolution of ±2 g, ±4 g, ±8 g and ±16 g. The sampling frequency is 1 Hz to 5 KHz. Possible applications include the recording of vibrations and shocks/oscillations, and furthermore inclination measurements in all three axes.

#### Quick links

[Technical data](#) [▶ 48]

[Process image](#) [▶ 51]

[Dimensions](#) [▶ 76]

[Signal connection \[►\\_102\]](#)

[Acceleration measurement \(EP1816-3008\) \[►\\_122\]](#)

[Inclination measurement \(EP1816-3008\) \[►\\_126\]](#)

### 3.8.2 Technical data - EP1816-x008

All values are typical values over the entire temperature range, unless stated otherwise.

EtherCAT	EP1816-0008	EP1816-1008	EP1816-3008
Connection	2 x M8 socket, 4-pin, A-coded, shielded		
Electrical isolation	500 V		
Distributed Clocks	yes		
Minimum cycle time	-	-	500 $\mu$ s

Supply voltages	EP1816-0008	EP1816-1008	EP1816-3008
Connection	Input: M8 connector, 4-pin, A-coded Downstream connection: M8 socket, 4-pin, A-coded		
$U_S$ nominal voltage	24 V <sub>DC</sub> (-15 % / +20 %)		
$U_S$ sum current: $I_{S,sum}$	max. 4 A		
Current consumption from $U_S$	120 mA + sensor power supply		
$U_P$ nominal voltage	24 V <sub>DC</sub> (-15 % / +20 %)		
$U_P$ sum current: $I_{P,sum}$	max. 4 A		
Current consumption from $U_P$	None. $U_P$ is only forwarded.		
Undervoltage detection	-	< 18 V for $U_S$ and $U_P$	< 18 V for $U_S$ and $U_P$
Electrical isolation GND <sub>S</sub> / GND <sub>P</sub>	no	yes	yes

Digital inputs	EP1816-0008	EP1816-1008	EP1816-3008
Number	16		
Connection	D-sub socket, 25-pin, UNC4-40 thread		
Cable length	max. 30 m		
Characteristics	Type 3 according to EN 61131-2, compatible with type 1		
Nominal input voltage	24 V <sub>DC</sub> (-15 %/+20 %)		
Input filter	10 $\mu$ s		
Signal voltage "0"	-3 ... +5 V		
Signal voltage "1"	+11 ... +30 V		
Input current	6 mA	3 mA	3 mA
Sensor power supply	24 V <sub>DC</sub> from $U_S$ max. 0.5 A, short-circuit proof in total		

Housing data	
Dimensions W x H x D	30 mm x 126 mm x 26.5 mm (without connectors)
Weight	approx. 165 g
Installation position	variable
Material	PA6 (polyamide)

Environmental conditions	
Ambient temperature during operation	-25 ... +60 °C -25 ... +55 °C according to cURus
Ambient temperature during storage	-40 ... +85 °C
Vibration resistance, shock resistance	conforms to EN 60068-2-6 / EN 60068-2-27 Additional tests [► 49]
EMC immunity / emission	conforms to EN 61000-6-2 / EN 61000-6-4
Protection class	IP65, IP66, IP67 (conforms to EN 60529)



Approvals/markings	
Approvals/markings <sup>*)</sup>	CE, cURus [▶ 106]

\*) Real applicable approvals/markings see type plate on the side (product marking).

**Additional tests**

The devices have undergone the following additional tests:

Test	Explanation
Vibration	10 frequency sweeps in 3 axes
	5 Hz < f < 60 Hz displacement 0.35 mm, constant amplitude
	60.1 Hz < f < 500 Hz acceleration 5 g, constant amplitude
Shocks	1000 shocks in each direction, in 3 axes
	35 g, 11 ms

**3.8.2.1 Accelerometers (EP1816-3008 only)**

Technical data	Accelerometers
Sensor type	Two 3-axis accelerometers, offset by 90°
Resolution of the measured acceleration values	10-bit When displayed in mg: 1 mg per LSB <sup>1)</sup>
Resolution of the measured inclination values	Depending on where the measured acceleration values are converted to angles of inclination: <ul style="list-style-type: none"> <li>• 1° when converted in EP1816-3008</li> <li>• &lt; 0.1° when converted in the controller</li> </ul>
Measuring range of the acceleration measurement	±2 g / ±4 g / ±8 g / ± 16 g adjustable <sup>1)</sup>
Special features	Self-test
Sampling rate	1 Hz to 5 kHz

<sup>1)</sup> 1 g is the acceleration of gravity, 9.81 m/s<sup>2</sup>.

**● i Maximum transfer rate**

Die EP1816-3008 reads sensors with sampling rates between 1 Hz and 5 kHz. Since the smallest cycle time is limited to 500 µs due to the internal processing, the resulting maximum transfer rate is 2.5 kHz.

### 3.8.3 Scope of supply - EP1816-000x

Make sure that the following components are included in the scope of delivery:

- 1x EtherCAT Box EP1816-000x
- 2x protective cap for EtherCAT socket, M8, green (pre-assembled)
- 1x protective cap for supply voltage input, M8, transparent (pre-assembled)
- 1x protective cap for supply voltage output, M8, black (pre-assembled)
- 10x labels, blank (1 strip of 10)

---

● **Pre-assembled protective caps do not ensure IP67 protection**

**i** Protective caps are pre-assembled at the factory to protect connectors during transport. They may not be tight enough to ensure IP67 protection.

Ensure that the protective caps are correctly seated to ensure IP67 protection.

---

### 3.8.4 Process image - EP1816-0008





- ▲  Box 1 (EP1816-0008)
  - ▷  DIG Inputs Channel 1
  - ▷  DIG Inputs Channel 2
  - ▷  WcState
  - ▷  InfoData

Fig. 10: EP1816-0008 Process image

#### DIG Inputs Channel 1

You will find the first 8 digital inputs of the module under **DIG Inputs Channel 1**.









- ▲  DIG Inputs Channel 1
  - ▶  Input 1
  - ▶  Input 2
  - ▶  Input 3
  - ▶  Input 4
  - ▶  Input 5
  - ▶  Input 6
  - ▶  Input 7
  - ▶  Input 8

Fig. 11: EP1816-0008 process image, DIG Inputs Channel 1

#### DIG Inputs Channel 2

You will find the second 8 digital inputs of the module under **DIG Inputs Channel 2**.









- ▲  DIG Inputs Channel 2
  - ▶  Input 1
  - ▶  Input 2
  - ▶  Input 3
  - ▶  Input 4
  - ▶  Input 5
  - ▶  Input 6
  - ▶  Input 7
  - ▶  Input 8

Fig. 12: EP1816-0008 process image, DIG Inputs Channel 2

### 3.8.5 Process image - EP1816-1008

- ▲ Box 1 (EP1816-1008)
  - ▷ DIG Inputs Channel 1
  - ▷ DIG Inputs Channel 2
  - ▷ DIG Inputs Device
  - ▷ WcState
  - ▷ InfoData

Fig. 13: EP1816-1008 Process image

#### DIG Inputs Channel 1

You will find the first 8 digital inputs of the module under **DIG Inputs Channel 1**.

- ▲ DIG Inputs Channel 1
  - ▶ Input 1
  - ▶ Input 2
  - ▶ Input 3
  - ▶ Input 4
  - ▶ Input 5
  - ▶ Input 6
  - ▶ Input 7
  - ▶ Input 8

Fig. 14: EP1816-1008 process image, DIG Inputs Channel 1

#### DIG Inputs Channel 2

You will find the second 8 digital inputs of the module under **DIG Inputs Channel 2**.

- ▲ DIG Inputs Channel 2
  - ▶ Input 1
  - ▶ Input 2
  - ▶ Input 3
  - ▶ Input 4
  - ▶ Input 5
  - ▶ Input 6
  - ▶ Input 7
  - ▶ Input 8

Fig. 15: EP1816-1008 process image, DIG Inputs Channel 2

#### DIG Inputs Device

The status bits can be found under **DIG Inputs Device**.

- ▲ DIG Inputs Device
  - ▶ Us Undervoltage
  - ▶ Up Undervoltage
  - ▶ Sync error
  - ▶ TxPDO Toggle

Fig. 16: EP1816-1008 process image, DIG Inputs Device

### 3.8.6 Process image - EP1816-3008

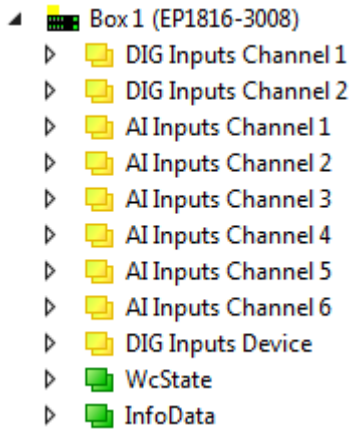

Fig. 17: EP1816-3008 Process image

#### DIG Inputs Channel 1

You will find the first 8 digital inputs of the module under **DIG Inputs Channel 1**.

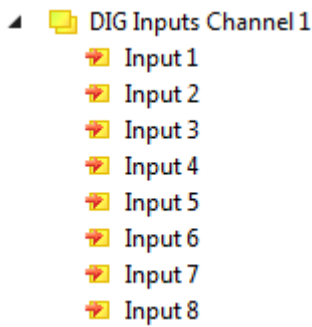

Fig. 18: EP1816-3008 process image, DIG Inputs Channel 1

#### DIG Inputs Channel 2

You will find the second 8 digital inputs of the module under **DIG Inputs Channel 2**.

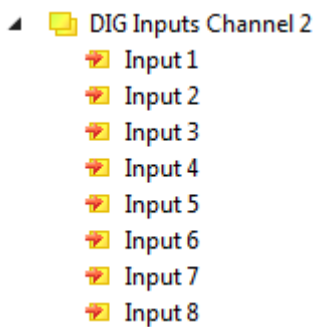

Fig. 19: EP1816-3008 process image, DIG Inputs Channel 2

## DIG Inputs Device

The status bits can be found under **DIG Inputs Device**.

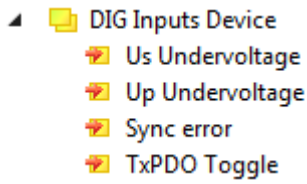

Fig. 20: EP1816-3008 process image, DIG Inputs Device

## AI Inputs Channel 1 to 6

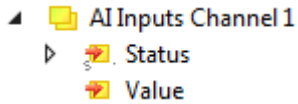

Fig. 21: EP1816-3008 process image, AI inputs

The data for the two accelerometers can be found under **AI inputs Channel**

- Status Error: error relating to the communication with the accelerometer
- Value: 16-bit acceleration value

[Assignment of the acceleration axes \[► 122\]](#)

### 3.9 EP1819-0005

#### 3.9.1 Introduction

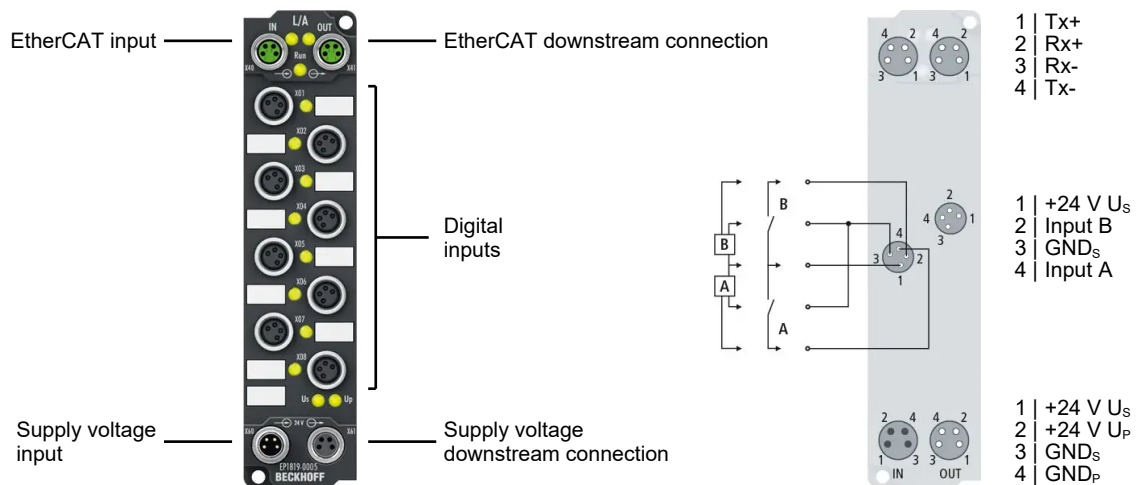

#### 16-channel digital input

The EP1819-0005 EtherCAT Box with digital inputs acquires binary control signals from the process level and transfers them electrically isolated to the controller. The signal state is indicated by means of LEDs. The signal connection is made via screwable 4-pin M8 connectors. This means that sensors with antivalent channels (NC/NO, change-over) can be connected directly using a 4-pin cable.

The sensors are supplied from the control voltage  $U_S$ . The load voltage  $U_P$  is not used in the input module, but it can optionally be connected for forwarding and is fed through to the next device.

The connected sensors are supplied via an internal, short-circuit proof driver block with a total of 0.5 A for all sensors.

Thanks to the input filter of 10  $\mu s$ , the EP1819-0005 is preferably suitable for electronic inputs that transmit to the controller with the shortest possible delay due to the short filter time. The use of antivalent sensors also enables the sensor to be diagnosed.

#### Quick links

[Technical data \[▶ 56\]](#)

[Process image \[▶ 58\]](#)

[Dimensions \[▶ 76\]](#)

[Signal interface \[▶ 89\]](#)

[Diagnostics for antivalent sensors \[▶ 135\]](#)

### 3.9.2 Technical data - EP1819-0005

All values are typical values over the entire temperature range, unless stated otherwise.

EtherCAT	
Connection	2 x M8 socket, 4-pin, A-coded, shielded
Electrical isolation	500 V

Supply voltages	
Connection	Input: M8 connector, 4-pin, A-coded Downstream connection: M8 socket, 4-pin, A-coded
$U_S$ nominal voltage	24 V <sub>DC</sub> (-15 % / +20 %)
$U_S$ sum current: $I_{S,sum}$	max. 4 A
Current consumption from $U_S$	100 mA + sensor power supply
$U_P$ nominal voltage	24 V <sub>DC</sub> (-15 % / +20 %)
$U_P$ sum current: $I_{P,sum}$	max. 4 A
Electrical isolation GND <sub>S</sub> / GND <sub>P</sub>	yes

Digital inputs	
Number of inputs	16
Connection	8 x M8 socket, 4-pin, A-coded
Cable length	max. 30 m
Characteristics	Type 3 according to EN 61131-2, compatible with type 1
Nominal voltage	24 V <sub>DC</sub> (-15 % / +20 %)
Input filter	10 μs
Signal voltage "0"	-3 ... +5 V
Signal voltage "1"	+11 ... +30 V
Input current	3 mA
Sensor power supply	24 V <sub>DC</sub> from $U_S$ max. 0.5 A, short-circuit proof in total

Housing data	
Dimensions W x H x D	30 mm x 126 mm x 26.5 mm (without connectors)
Weight	approx. 165 g
Installation position	variable
Material	PA6 (polyamide)

Environmental conditions	
Ambient temperature during operation	-25 ... +60 °C -25 ... +55 °C according to cURus
Ambient temperature during storage	-40 ... +85 °C
Vibration resistance, shock resistance	conforms to EN 60068-2-6 / EN 60068-2-27 Additional tests [► 57]
EMC immunity / emission	conforms to EN 61000-6-2 / EN 61000-6-4
Protection class	IP65, IP66, IP67 (conforms to EN 60529)

Approvals/markings	
Approvals/markings *)	CE, cURus [► 106]

\*) Real applicable approvals/markings see type plate on the side (product marking).



**Additional tests**

The devices have undergone the following additional tests:

Test	Explanation
Vibration	10 frequency sweeps in 3 axes
	5 Hz < f < 60 Hz displacement 0.35 mm, constant amplitude
	60.1 Hz < f < 500 Hz acceleration 5 g, constant amplitude
Shocks	1000 shocks in each direction, in 3 axes
	35 g, 11 ms

**3.9.3 Scope of supply - EP1819-0005**

Make sure that the following components are included in the scope of delivery:

- 1x EP1819-0005 EtherCAT Box
- 2x protective cap for EtherCAT socket, M8, green (pre-assembled)
- 1x protective cap for supply voltage input, M8, transparent (pre-assembled)
- 1x protective cap for supply voltage output, M8, black (pre-assembled)
- 10x labels, blank (1 strip of 10)

---

**● Pre-assembled protective caps do not ensure IP67 protection**

**i** Protective caps are pre-assembled at the factory to protect connectors during transport. They may not be tight enough to ensure IP67 protection.

Ensure that the protective caps are correctly seated to ensure IP67 protection.

---

### 3.9.4 Process image - EP1819-0005

- Channel 1 X01-4 Input
      - Channel 2 X01-2 Input
      - Channel 3 X02-4 Input
      - Channel 4 X02-2 Input
      - Channel 5 X03-4 Input
      - Channel 6 X03-2 Input
      - Channel 7 X04-4 Input
      - Channel 8 X04-2 Input
      - Channel 9 X05-4 Input
      - Channel 10 X05-2 Input
      - Channel 11 X06-4 Input
      - Channel 12 X06-2 Input
      - Channel 13 X07-4 Input
      - Channel 14 X07-2 Input
      - Channel 15 X08-4 Input
      - Channel 16 X08-2 Input
    - WcState
    - InfoData

"DIP Input" contains the input variables of the digital inputs. The variable names are structured as follows:

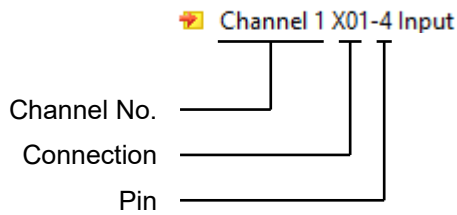

#### 3.9.4.1 Optional: "DIP Diagnosis" for diagnosing antivalent sensors

The process data object "DIP Diagnosis" contains status bits for diagnosing antivalent sensors.

- Channel 17 X01 Input Error
        - Channel 18 X02 Input Error
        - Channel 19 X03 Input Error
        - Channel 20 X04 Input Error
        - Channel 21 X05 Input Error
        - Channel 22 X06 Input Error
        - Channel 23 X07 Input Error
        - Channel 24 X08 Input Error
      - WcState
      - InfoData

Further information can be found in chapter [Antivalent sensors \(EP1819-0005\)](#) [▶ 135].

### 3.10 EP1839-0042

#### 3.10.1 Introduction

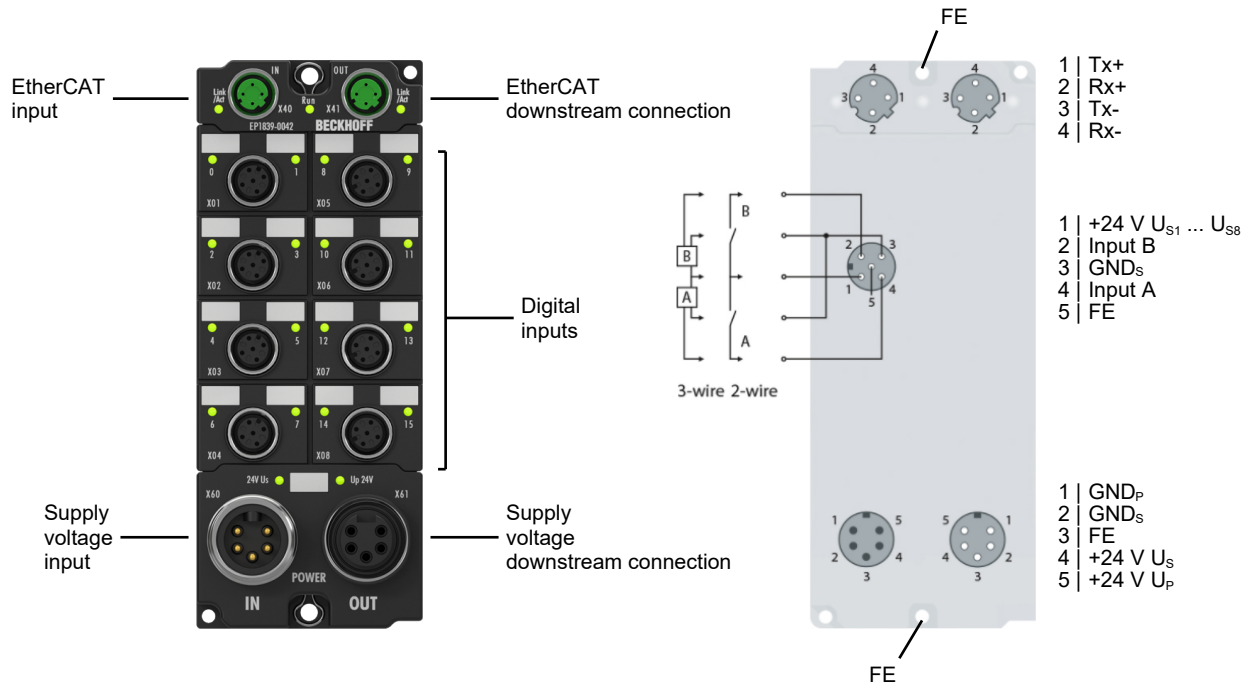

#### 16-channel digital input with diagnostics

The EP1839-0042 EtherCAT Box with 16 digital inputs acquires binary control signals from the process level and transfers them, with electrical isolation, to the controller. The signal state is displayed by LEDs; the signals are connected via screwable M12 connectors. A wire break detection can be enabled/disabled for each channel. The signal input filters are individually adjustable.

Each M12 socket has an independent 24 V DC/0.5 A short-circuit proof sensor supply from U<sub>S</sub> for the two connected sensors. This is monitored and any errors are reported to the controller via a diagnosis. Module-related undervoltage detection of the input voltage takes place.

The peripheral voltage U<sub>P</sub> is not used in the input module, but it can optionally be connected for forwarding and is fed through to the next device. Due to the adjustable input filter and the comprehensive supply and diagnostics logic, the EP1839-0042 is particularly suitable for applications in which a high system availability and thus fast fault-finding and troubleshooting are required.

The EP1839-0042 has M12 D-coded EtherCAT connections and 7/8" connectors for the power supply.

#### Special features:

- adjustable wire break detection per sensor
- Undervoltage detection of the sensor supply U<sub>S</sub>
- short-circuit proof sensor supply U<sub>S</sub> 0.5 A per M12 socket
- parameterizable input filters per signal

The EP1839-0042 is interference-free. You can use the EP1839-0042 instead of an interference-free standard terminal in accordance with the following chapters of the TwinSAFE Application Guide:

- "All-pole disconnection of a potential group with downstream interference-free standard terminals (Category 4, PL e)"
- "Single-pole disconnection of a potential group with downstream interference-free standard terminals with fault exclusion (Category 4, PL e)"

- „EL2911 potential group with interference-free standard terminals (Category 4, PL e)“

**Quick links**

[Technical data \[▶ 61\]](#)

[Process image \[▶ 64\]](#)

[Dimensions \[▶ 78\]](#)

[Signal connection and status LEDs \[▶ 97\]](#)

[Configure inputs \[▶ 114\]](#)

[Configure sensor supply \[▶ 119\]](#)

### 3.10.2 Technical data - EP1839-0042

All values are typical values over the entire temperature range, unless stated otherwise.

<b>EtherCAT</b>	
Connection	2 x M12 socket, 4-pin, D-coded, shielded
Electrical isolation	500 V
Distributed Clocks	yes

<b>Supply voltages</b>	
Connection input	7/8" plug, 5-pin, 16-UN thread
Downstream connection	7/8" socket, 5-pin, 16-UN thread
$U_S$ nominal voltage	24 V <sub>DC</sub> (-15 % / +20 %)
$U_S$ sum current: $I_{S,sum}$	max. 16 A at 40 °C
Current consumption from $U_S$	130 mA + sensor supply $U_{S1} \dots U_{S8}$
$U_P$ nominal voltage	24 V <sub>DC</sub> (-15 % / +20 %)
$U_P$ sum current: $I_{P,sum}$	max. 16 A at 40 °C
Current consumption from $U_P$	None. $U_P$ is only forwarded.
Electrical isolation GND <sub>S</sub> / GND <sub>P</sub>	yes
Diagnosis	$U_S$ undervoltage detection

<b>Digital inputs</b>	
Number	16
Connection	8 x M12 socket, 5-pin, A-coded
Cable length	max. 30 m
Characteristics	Type 3 according to EN 61131-2, compatible with type 1
Input filter	Adjustable: 0 ... 3 ms
Signal voltage "0"	-3 ... +5 V
Signal voltage "1"	+11 ... +30 V
Input current	3 mA
Sensor power supply $U_{S1} \dots U_{S8}$	24 V <sub>DC</sub> from $U_S$ . Max. 0.5 A per M12 socket, individually short-circuit proof.
Diagnosis	<ul style="list-style-type: none"> <li>• Wire break detection</li> <li>• Sensor power supply</li> </ul>

<b>Housing data</b>	
Dimensions W x H x D	60 mm x 150 mm x 26,5 mm (without connectors)
Weight	approx. 440 g
Installation position	variable
Material	PA6 (polyamide)

<b>Environmental conditions</b>	
Ambient temperature during operation	-25 ... +60 °C
Ambient temperature during storage	-40 ... +85 °C
Vibration / shock resistance	conforms to EN 60068-2-6 / EN 60068-2-27
EMC immunity / emission	conforms to EN 61000-6-2 / EN 61000-6-4
Protection class	IP65, IP66, IP67 conforms to EN 60529

**Approvals / markings**

Approvals / markings *)	CE, UL under preparation
-------------------------	--------------------------

\*) Real applicable approvals/markings see type plate on the side (product marking).

**Additional tests**

The devices have undergone the following additional tests:

Test	Explanation
Vibration	10 frequency sweeps in 3 axes
	5 Hz < f < 60 Hz displacement 0.35 mm, constant amplitude
	60.1 Hz < f < 500 Hz acceleration 5 g, constant amplitude
Shocks	1000 shocks in each direction, in 3 axes
	35 g, 11 ms

### 3.10.3 Scope of supply - EP1839-0042

Make sure that the following components are included in the scope of delivery:

- 1x EP1839-0042
- 2x protective cap for EtherCAT socket, M12 (pre-assembled)
- 1x Protective cap for supply voltage output, 7/8", black (pre-fitted)
- 10x labels, blank (1 strip of 10)



#### **Pre-assembled protective caps do not ensure IP67 protection**

Protective caps are pre-assembled at the factory to protect connectors during transport. They may not be tight enough to ensure IP67 protection.

Ensure that the protective caps are correctly seated to ensure IP67 protection.

---

### 3.10.4 Process image - EP1839-0042

You can choose between several predefined variants of the process image, the "Predefined PDO Assignments". The procedure for setting a Predefined PDO Assignment can be found in chapter [Adapt process image \(EP1819-0005, EP1839-0042\)](#) [▶ 112].

In the factory setting, the Predefined PDO Assignment "16 DI full diagnosis" is selected.

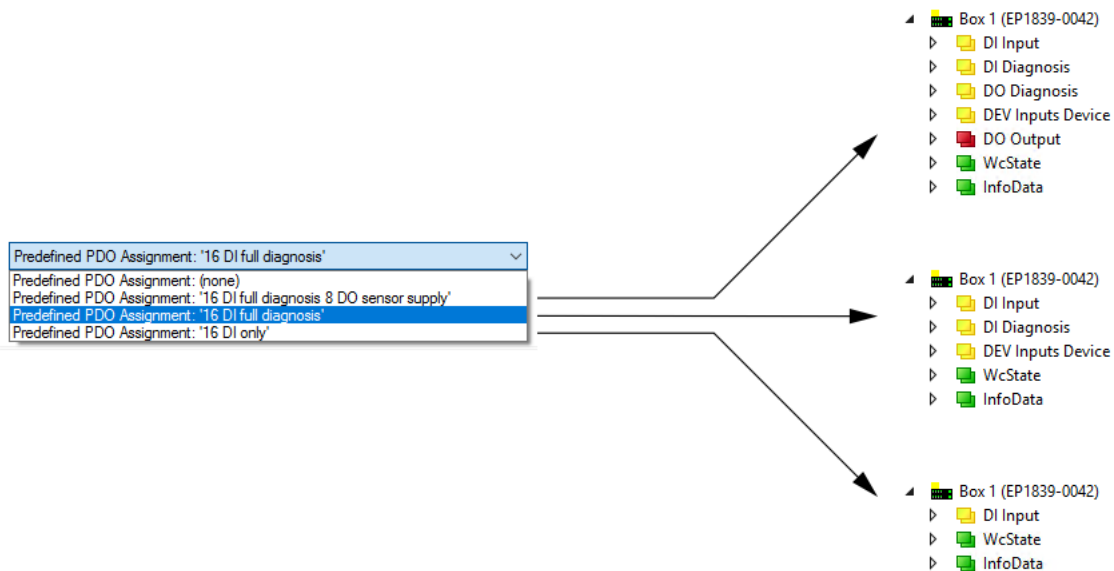







The individual process data objects are described in chapter [Process data objects](#) [▶ 65].



### 3.10.4.1 Process data objects

#### DEV Inputs Device

"DEV Inputs Device" contains status bits for diagnostic messages that affect the entire EP1839-0042 device.

- ▲  DEV Inputs Device
  -  Undervoltage Us
  -  Overtemperature
  -  Diag
  -  TxPDO State
  -  Input cycle counter

**Undervoltage Us**

Undervoltage of the supply voltage  $U_S$ .  
As a result, all sensor supply outputs are switched off.

**Overtemperature**

Internal overtemperature. All sensor supply outputs are deactivated.  
The bit is reset and the sensor supply outputs are automatically reactivated when the temperature has dropped again.

**Diag**

Without function. Reserved for future use.

**TxPDO State**

















Validity of the input data. This bit is set if the input data could not be read correctly due to an error.

**Input cycle counter**

A 2-bit counter. It is incremented each time the input data is updated in the process image. After it reaches its maximum value of 3, it jumps back to 0.

## DI Diagnosis

"DI Diagnosis" contains the status bits for the digital inputs. The status bits indicate a wire break. See chapter [Wire break detection \(EP1839-0042\)](#) [▶ 136].

- ▲  DI Diagnosis
  -  Channel 1 X01-4 Wirebreak
  -  Channel 2 X01-2 Wirebreak
  -  Channel 3 X02-4 Wirebreak
  -  Channel 4 X02-2 Wirebreak
  -  Channel 5 X03-4 Wirebreak
  -  Channel 6 X03-2 Wirebreak
  -  Channel 7 X04-4 Wirebreak
  -  Channel 8 X04-2 Wirebreak
  -  Channel 9 X05-4 Wirebreak
  -  Channel 10 X05-2 Wirebreak
  -  Channel 11 X06-4 Wirebreak
  -  Channel 12 X06-2 Wirebreak
  -  Channel 13 X07-4 Wirebreak
  -  Channel 14 X07-2 Wirebreak
  -  Channel 15 X08-4 Wirebreak
  -  Channel 16 X08-2 Wirebreak

The variable names are structured as follows:

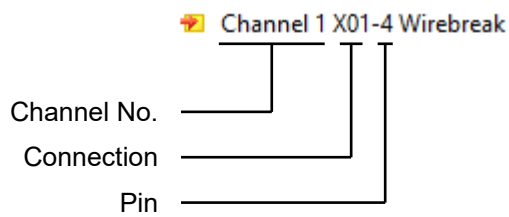

**DI Input**

"DI Input" contains the input variables of the digital inputs.

- ▶ ▶ DI Input
  - ▶ Channel 1 X01-4 Input
  - ▶ Channel 2 X01-2 Input
  - ▶ Channel 3 X02-4 Input
  - ▶ Channel 4 X02-2 Input
  - ▶ Channel 5 X03-4 Input
  - ▶ Channel 6 X03-2 Input
  - ▶ Channel 7 X04-4 Input
  - ▶ Channel 8 X04-2 Input
  - ▶ Channel 9 X05-4 Input
  - ▶ Channel 10 X05-2 Input
  - ▶ Channel 11 X06-4 Input
  - ▶ Channel 12 X06-2 Input
  - ▶ Channel 13 X07-4 Input
  - ▶ Channel 14 X07-2 Input
  - ▶ Channel 15 X08-4 Input
  - ▶ Channel 16 X08-2 Input



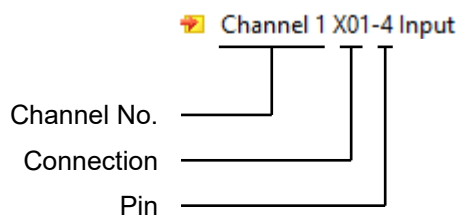





























The variable names are structured as follows:



## DO Diagnosis

"DO Diagnosis" contains the status bits for the sensor supply outputs.

This process data object is deactivated in the factory setting. You can enable it by setting the Predefined PDO Assignment "16 DI full diagnosis 8 DO sensor supply", see chapter [Adapt process image \(EP1819-0005, EP1839-0042\)](#) [► 112].

- ▲  DO Diagnosis
  -  Channel 1 X01-1 Overcurrent
  -  Channel 1 X01-1 Overload
  -  Channel 1 X01-1 Open load
  -  Channel 1 X01-1 Short to 24V
  -  Channel 2 X02-1 Overcurrent
  -  Channel 2 X02-1 Overload
  -  Channel 2 X02-1 Open load
  -  Channel 2 X02-1 Short to 24V
  -  Channel 3 X03-1 Overcurrent
  -  Channel 3 X03-1 Overload
  -  Channel 3 X03-1 Open load
  -  Channel 3 X03-1 Short to 24V
  -  Channel 4 X04-1 Overcurrent
  -  Channel 4 X04-1 Overload
  -  Channel 4 X04-1 Open load
  -  Channel 4 X04-1 Short to 24V
  -  Channel 5 X05-1 Overcurrent
  -  Channel 5 X05-1 Overload
  -  Channel 5 X05-1 Open load
  -  Channel 5 X05-1 Short to 24V
  -  Channel 6 X06-1 Overcurrent
  -  Channel 6 X06-1 Overload
  -  Channel 6 X06-1 Open load
  -  Channel 6 X06-1 Short to 24V
  -  Channel 7 X07-1 Overcurrent
  -  Channel 7 X07-1 Overload
  -  Channel 7 X07-1 Open load
  -  Channel 7 X07-1 Short to 24V
  -  Channel 8 X08-1 Overcurrent
  -  Channel 8 X08-1 Overload
  -  Channel 8 X08-1 Open load
  -  Channel 8 X08-1 Short to 24V









If an error is detected at a sensor supply output, the error is additionally signaled by the status LEDs at the corresponding connection. See chapter [EP1839-0042](#) [► 97].

See chapter [Configure sensor supply \(EP1839-0042\)](#) [► 119] for further information.

**DO Output**

"DO Output" contains the output variables of the digital outputs.

This process data object is deactivated in the factory setting. You can enable it by setting the Predefined PDO Assignment "16 DI full diagnosis 8 DO sensor supply", see chapter [Adapt process image \(EP1819-0005, EP1839-0042\)](#) [► 112].

- ▲  DO Output
  -  Channel 1 X01-1 Output
  -  Channel 2 X02-1 Output
  -  Channel 3 X03-1 Output
  -  Channel 4 X04-1 Output
  -  Channel 5 X05-1 Output
  -  Channel 6 X06-1 Output
  -  Channel 7 X07-1 Output
  -  Channel 8 X08-1 Output

The variable names are structured as follows:

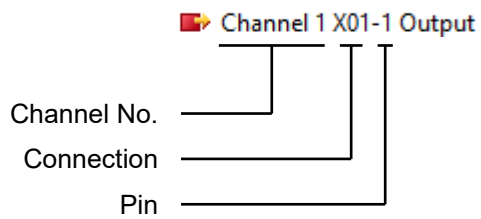

### 3.11 EP1859-0042

#### 3.11.1 Introduction

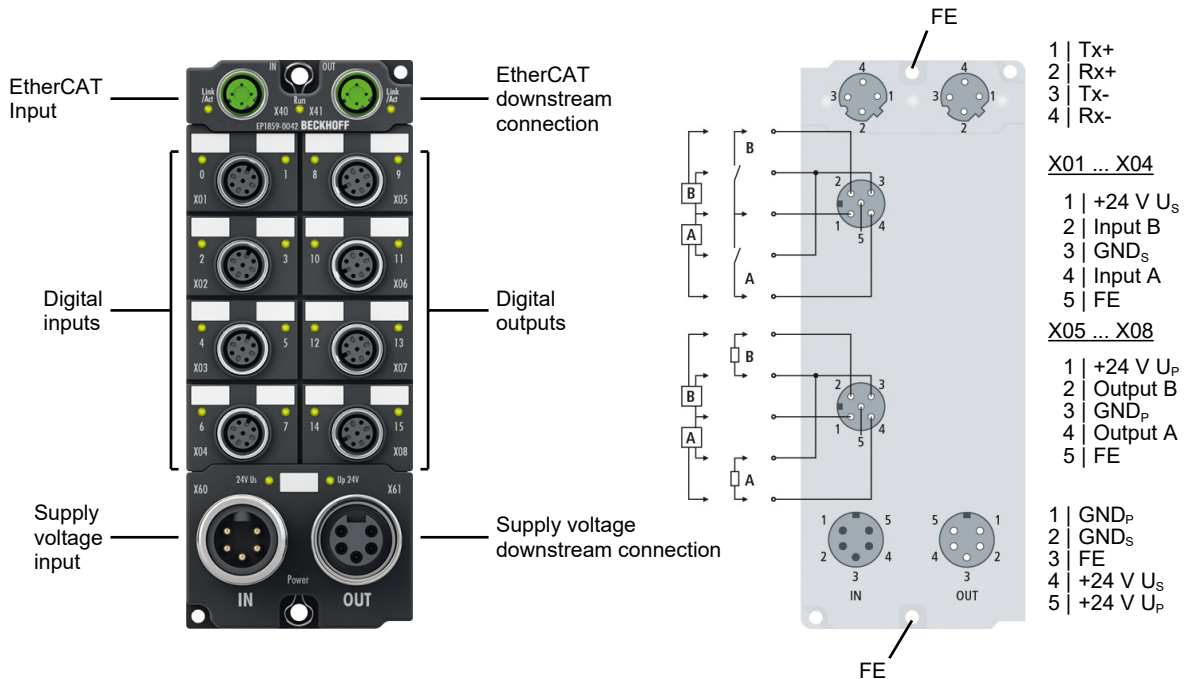

**8 x digital input + 8 x digital output 24 V<sub>DC</sub>, I<sub>max</sub> = 0.5 A, 3.0 ms**

The EP1859-0042 EtherCAT Box has eight digital inputs (four M12 sockets on the left) and eight digital outputs (four M12 sockets on the right).

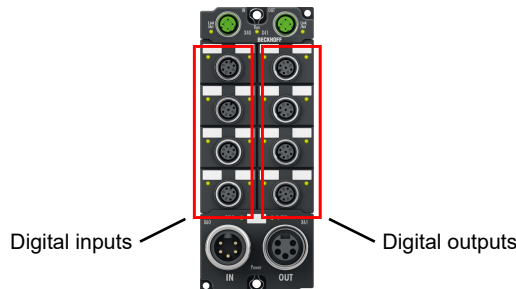

The inputs have a filter of 3.0 ms. The outputs process load currents up to 0.5 A, are short-circuit proof and protected against polarity reversal. The state of the signals is indicated by light emitting diodes. The signals are connected via M12 screw type connectors.

The sensors are supplied from the box supply voltage U<sub>S</sub>. The outputs are supplied via U<sub>P</sub>. The outputs are short-circuit proof and protected against inverse connection.

The EP1859-0042 is interference-free. You can use the EP1859-0042 instead of an interference-free standard terminal in accordance with the following chapters of the TwinSAFE Application Guide:

- "All-pole disconnection of a potential group with downstream interference-free standard terminals (Category 4, PL e)"
- "Single-pole disconnection of a potential group with downstream interference-free standard terminals with fault exclusion (Category 4, PL e)"
- „EL2911 potential group with interference-free standard terminals (Category 4, PL e)"

**Quick links**

[Technical data \[▶ 72\]](#)

[Process image \[▶ 75\]](#)

[Dimensions \[▶ 78\]](#)

[Functional earth \(FE\) \[▶ 80\]](#)

[Signal connection for inputs \[▶ 95\]: X01, X02, X03, X04](#)

[Signal connection for outputs \[▶ 105\]: X05, X06, X07, X08](#)

### 3.11.2 Technical data - EP1859-0042

All values are typical values over the entire temperature range, unless stated otherwise.

EtherCAT	
Connection	2 x M12 socket, 4-pin, D-coded, shielded
Electrical isolation	500 V

Supply voltages	
Connection	Input: 7/8" plug, 5-pin, 16-UN thread Downstream connection: 7/8" socket, 5-pin, 16-UN thread
$U_S$ nominal voltage	24 V <sub>DC</sub> (-15 % / +20 %)
$U_S$ sum current	max. 16 A at 40 °C
Current consumption from $U_S$	120 mA
Rated voltage $U_P$	24 V <sub>DC</sub> (-15 % / +20 %)
$U_P$ sum current	max. 16 A at 40 °C
Current consumption from $U_P$	20 mA + load
Electrical isolation GND <sub>S</sub> / GND <sub>P</sub>	yes

Digital inputs	
Number	8
Connection	4 x M12 socket, 5-pin, A-coded: X01, X02, X03, X04
Cable length	max. 30 m
Nominal input voltage	24 V <sub>DC</sub> (-15 %/+20 %)
Input filter	3 ms
Signal voltage "0"	-3 ... +5 V (similar to EN 61131-2, type 3)
Signal voltage "1"	+11 ... +30 V (similar to EN 61131-2, type 3)
Input current	6 mA (similar to EN 61131-2, type 3)
Sensor power supply	from $U_S$ , max. 0.5 A in total, short-circuit proof.

Digital outputs	
Number	8
Connection	4 x M12 socket, 5-pin, A-coded: X05, X06, X07, X08
Cable length	max. 30 m
Load type	Ohmic, inductive, lamp load
Output current	max. 0.5 A per channel, individually short-circuit proof
Short circuit current	1.5 A typ.
Changeover times	T <sub>ON</sub> : 50 µs typ., T <sub>OFF</sub> : 100 µs typ.
Auxiliary voltage output	from $U_P$ , max. 0.5 A in total, short-circuit proof.

Housing data	
Dimensions W x H x D	60 mm x 150 mm x 26,5 mm (without connectors)
Weight	approx. 440 g
Installation position	variable
Material	PA6 (polyamide)



<b>Environmental conditions</b>	
Ambient temperature during operation	-25 ... +60 °C
Ambient temperature during storage	-40 ... +85 °C
Vibration / shock resistance	conforms to EN 60068-2-6 / EN 60068-2-27
EMC immunity / emission	conforms to EN 61000-6-2 / EN 61000-6-4
Protection class	IP65, IP66, IP67 conforms to EN 60529

<b>Approvals / markings</b>	
Approvals / markings *)	CE, UL under preparation

\*) Real applicable approvals/markings see type plate on the side (product marking).

**Additional tests**

The devices have undergone the following additional tests:

<b>Test</b>	<b>Explanation</b>
Vibration	10 frequency sweeps in 3 axes
	5 Hz < f < 60 Hz displacement 0.35 mm, constant amplitude
	60.1 Hz < f < 500 Hz acceleration 5 g, constant amplitude
Shocks	1000 shocks in each direction, in 3 axes
	35 g, 11 ms

### 3.11.3 Scope of supply - EP1859-0042

Make sure that the following components are included in the scope of delivery:

- 1x EtherCAT Box EP1859-0042
- 2x protective cap for EtherCAT socket, M12 (pre-assembled)
- 1x Protective cap for supply voltage output, 7/8", black (pre-fitted)
- 10x labels, blank (1 strip of 10)



#### **Pre-assembled protective caps do not ensure IP67 protection**

Protective caps are pre-assembled at the factory to protect connectors during transport. They may not be tight enough to ensure IP67 protection.

Ensure that the protective caps are correctly seated to ensure IP67 protection.

---

### 3.11.4 Process image - EP1859-0042

The process image contains a process data object for each digital input.

The name of each process data object contains the name of the socket and the pin number of the corresponding digital input.

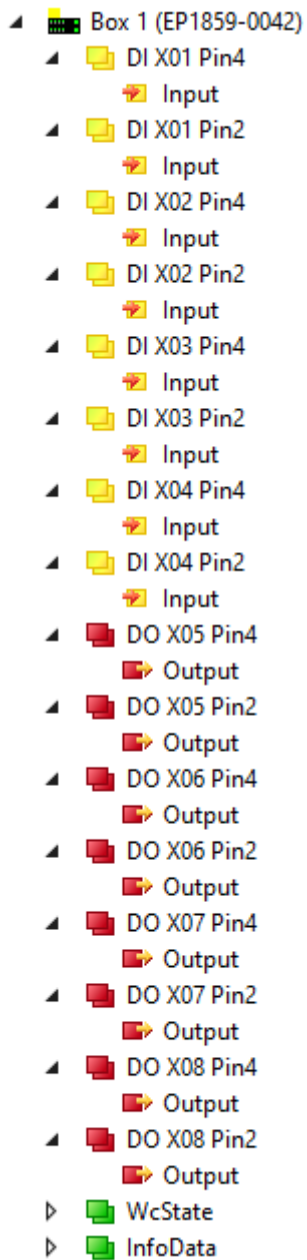
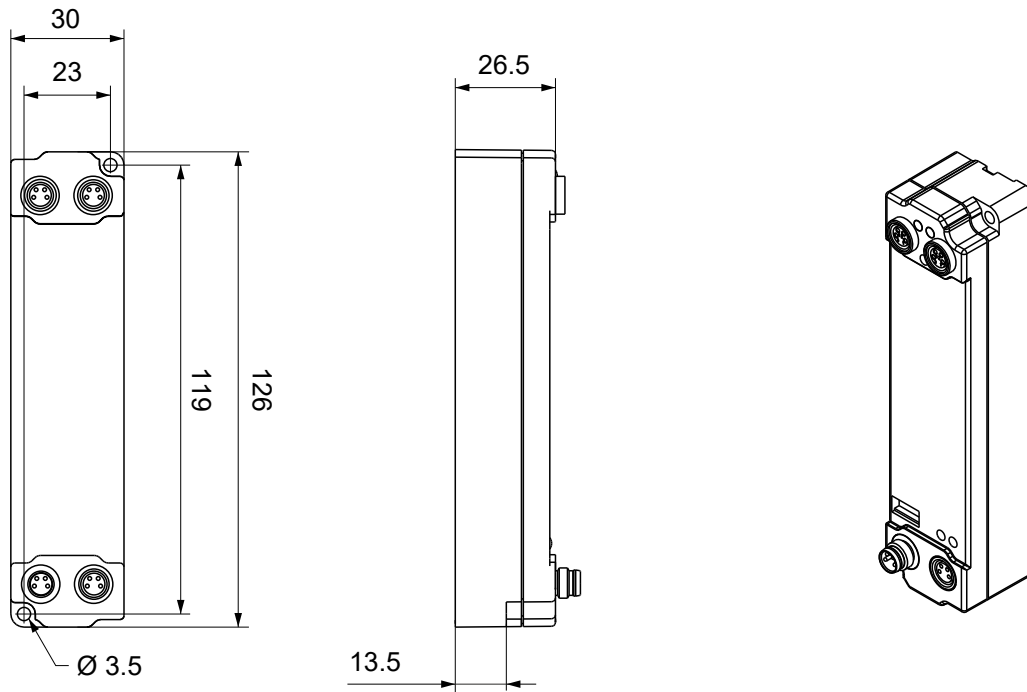

Fig. 22: EP1859-0042 - Process image

## 4 Mounting and connection

### 4.1 Mounting

#### 4.1.1 Dimensions EPxxxx-xx0x and EPxxxx-xx1x



All dimensions are given in millimeters.  
The drawing is not true to scale.

#### Housing features

Housing material	PA6 (polyamide)
Sealing compound	polyurethane
Mounting	two mounting holes Ø 3.5 mm for M3
Metal parts	brass, nickel-plated
Contacts	CuZn, gold-plated
Power feed through	max. 4 A
Installation position	variable
Protection class	IP65, IP66, IP67 (conforms to EN 60529) when screwed together
Dimensions (H x W x D)	approx. 126 x 30 x 26.5 mm (without connectors)

**4.1.2 Dimensions EPxxxx-xx2x**

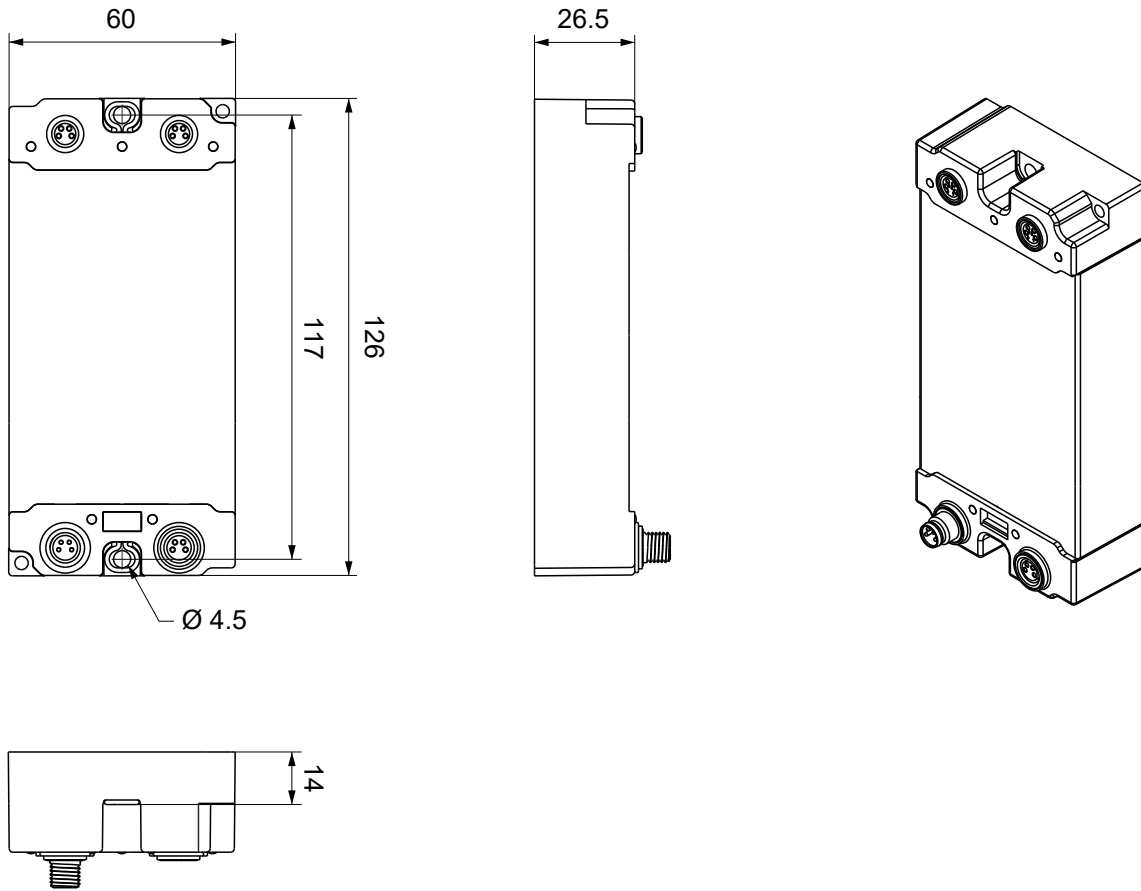

All dimensions are given in millimeters.  
The drawing is not true to scale.

**Housing features**

Housing material	PA6 (polyamide)
Sealing compound	polyurethane
Mounting	two mounting holes $\varnothing 4.5$ mm for M4
Metal parts	brass, nickel-plated
Contacts	CuZn, gold-plated
Installation position	variable
Protection class	IP65, IP66, IP67 (conforms to EN 60529) when screwed together
Dimensions (H x W x D)	approx. 126 x 60 x 26.5 mm (without connectors)

### 4.1.3 EPxxx-xx42 dimensions

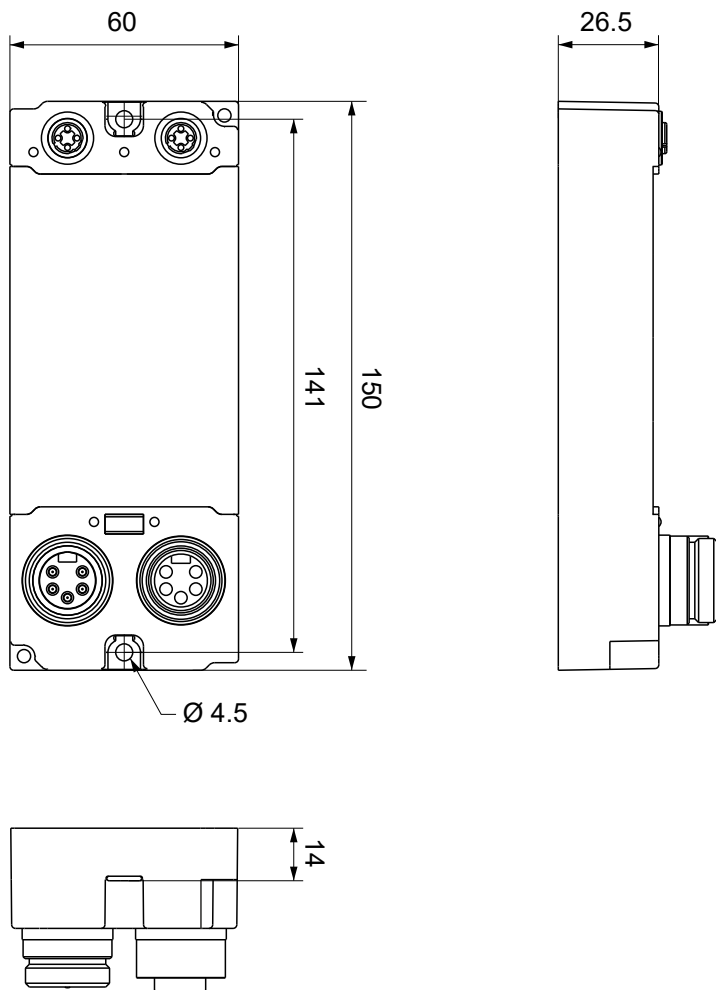

All dimensions are given in millimeters.  
The drawing is not true to scale.

#### Housing features

Housing material	PA6 (polyamide)
Sealing compound	polyurethane
Mounting	two mounting holes $\varnothing 4.5$ mm for M4
Metal parts	brass, nickel-plated
Contacts	CuZn, gold-plated
Power feed through	max. 16 A at 40°C (according to IEC 60512-3)
Installation position	variable
Protection class	IP65, IP66, IP67 (conforms to EN 60529) when screwed together
Dimensions (H x W x D)	approx. 150 x 60 x 26.5 mm (without connectors)

#### 4.1.4 Fixing

##### ● Protection of connectors against contamination!

**i** While mounting the modules, protect all connectors, against contamination! Only with connected cables or plugs the protection class IP67 is guaranteed! Unused connectors have to be protected with the right plugs! See for plug sets in the catalogue.

Modules with narrow housing are mounted with two M3 bolts.

Modules with wide housing are mounted with two M3 bolts to the mounting holes located at the corners or mounted with two M4 bolts to the mounting holes located centrally.

The bolts must be longer than 15 mm. The mounting holes of the modules are not threaded.

When assembling, remember that the fieldbus connectors increases the overall height. See chapter accessories.

##### Mounting Rail ZS5300-0001

The mounting rail ZS5300-0001 (500 mm x 129 mm) allows the time saving assembly of modules.

The rail is made of stainless steel, 1.5 mm thick, with already pre-made M3 threads for the modules. The rail has got 5.3 mm slots to mount it via M5 screws to the machine.

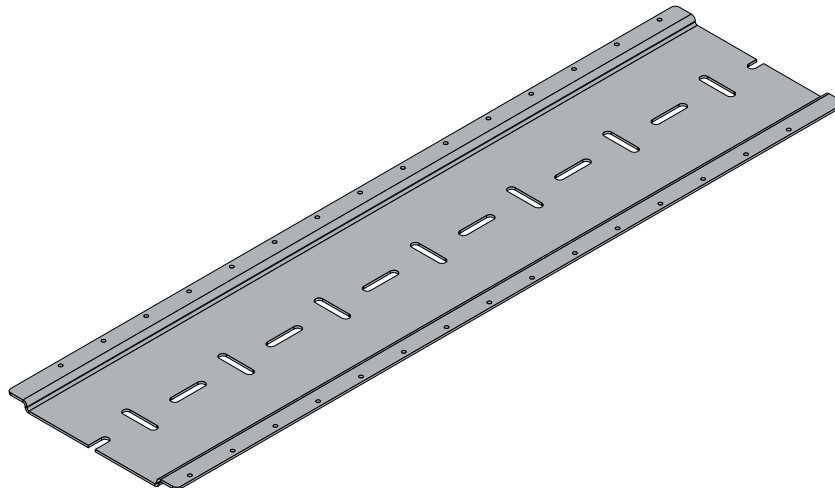

Fig. 23: Mounting Rail ZS5300-000

The mounting rail is 500 mm long, that way 15 narrow modules can be mounted with a distance of 2 mm between two modules. The rail can be cut to length for the application.

##### Mounting Rail ZS5300-0011

The mounting rail ZS5300-0011 (500 mm x 129 mm) has in addition to the M3 threads also pre-made M4 threads to fix 60 mm wide modules via their middle holes.

Up to 14 narrow or 7 wide modules may be mixed mounted.

### 4.1.5 Functional earth (FE)

EtherCAT Box modules of types EPxxxx-002x and EPxxxx-0042 must be grounded:

The Fixing also serve as connections for the functional earth (FE).

Make sure that the box is earthed with low impedance via both fastening screws. You can achieve this, for example, by mounting the box on a grounded machine bed.

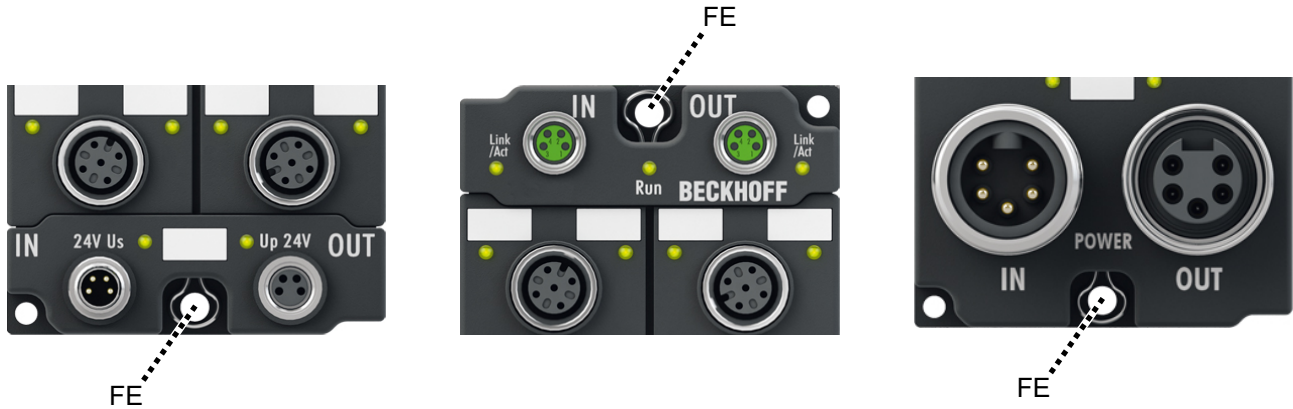

Fig. 24: Functional earth via the fastening holes



## 4.2 Connections

### 4.2.1 Tightening torques for plug connectors

Screw connectors tight with a torque wrench. (e.g. ZB8801 from Beckhoff)

Connector diameter	Tightening torque
M8	0.4 Nm
M12	0.6 Nm
7/8"	1.5 Nm

### 4.2.2 Protective caps

- Seal unused connectors with protective caps.
- Ensure the correct seating of pre-assembled protective caps.  
Protective caps are pre-assembled at the factory to protect connectors during transport. They may not be tight enough to ensure IP67 protection.

### 4.2.3 EtherCAT

#### 4.2.3.1 Connectors

**NOTICE**

**Risk of confusion: supply voltages and EtherCAT**

Defect possible through incorrect insertion.

- Observe the color coding of the connectors:  
 black: Supply voltages  
 green: EtherCAT

EtherCAT Box modules have two green M8 or M12 sockets for the incoming and outgoing EtherCAT connections.

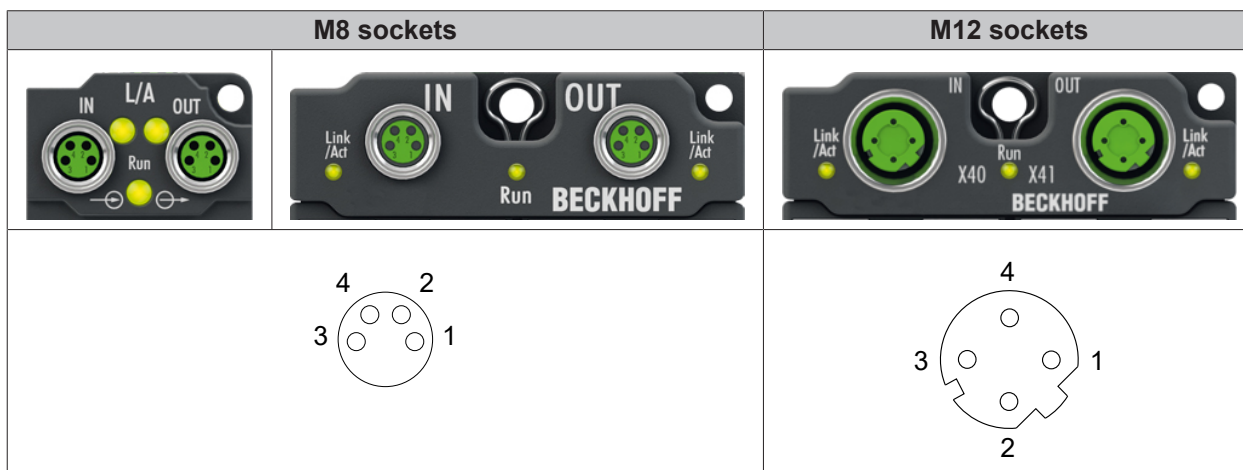

**Assignment**

There are various different standards for the assignment and colors of connectors and cables for EtherCAT.

EtherCAT	Plug connector			Cable		Standard
	M8	M12	RJ45 <sup>1</sup>	ZB9010, ZB9020, ZB9030, ZB9032, ZK1090-6292, ZK1090-3xxx-xxxx	ZB9031 and old versions of ZB9030, ZB9032, ZK1090-3xxx-xxxx	
Signal						TIA-568B
Tx +	Pin 1	Pin 1	Pin 1	yellow <sup>2</sup>	orange/white <sup>3</sup>	white/orange
Tx -	Pin 4	Pin 3	Pin 2	orange <sup>2</sup>	orange <sup>3</sup>	orange
Rx +	Pin 2	Pin 2	Pin 3	white <sup>2</sup>	blue/white <sup>3</sup>	white/green
Rx -	Pin 3	Pin 4	Pin 6	blue <sup>2</sup>	blue <sup>3</sup>	green
Shield	Housing		Shroud	Shield	Shield	Shield

<sup>1</sup>) colored markings according to EN 61918 in the four-pin RJ45 connector ZS1090-0003

<sup>2</sup>) wire colors according to EN 61918

<sup>3</sup>) wire colors

**i Assimilation of color coding for cable ZB9030, ZB9032 and ZK1090-3xxxx-xxxx (with M8 connectors)**

For unification, the prevalent cables ZB9030, ZB9032 and ZK1090-3xxx-xxxx were changed to the colors of EN61918 (yellow, orange, white, blue). So different color coding exists. But the electrical properties are absolutely identical.

**4.2.3.2 Status LEDs**



**L/A (Link/Act)**

A green LED labelled "L/A" is located next to each EtherCAT socket. The LED indicates the communication state of the respective socket:

LED	Meaning
off	no connection to the connected EtherCAT device
lit	LINK: connection to the connected EtherCAT device
flashes	ACT: communication with the connected EtherCAT device

**Run**

Each EtherCAT slave has a green LED labelled "Run". The LED signals the status of the slave in the EtherCAT network:

LED	Meaning
off	Slave is in "Init" state
flashes uniformly	Slave is in "Pre-Operational" state
flashes sporadically	Slave is in "Safe-Operational" state
lit	Slave is in "Operational" state

Description of the EtherCAT slave states

**4.2.3.3 Cables**

For connecting EtherCAT devices only shielded Ethernet cables that meet the requirements of at least category 5 (CAT5) according to EN 50173 or ISO/IEC 11801 should be used.

EtherCAT uses four wires for signal transmission.

Thanks to automatic line detection ("Auto MDI-X"), both symmetrical (1:1) or cross-over cables can be used between Beckhoff EtherCAT.

Detailed recommendations for the cabling of EtherCAT devices

## 4.2.4 Supply voltages

### ⚠ WARNING

#### Power supply from SELV/PELV power supply unit!

SELV/PELV circuits (Safety Extra Low Voltage, Protective Extra Low Voltage) according to IEC 61010-2-201 must be used to supply this device.

Notes:

- SELV/PELV circuits may give rise to further requirements from standards such as IEC 60204-1 et al, for example with regard to cable spacing and insulation.
- A SELV (Safety Extra Low Voltage) supply provides safe electrical isolation and limitation of the voltage without a connection to the protective conductor, a PELV (Protective Extra Low Voltage) supply also requires a safe connection to the protective conductor.

### ⚠ CAUTION

#### Observe the UL requirements

- When operating under UL conditions, observe the warnings in the chapter [UL Requirements](#) [▶ 106].

The EtherCAT Box has one input for two supply voltages:

- **Control voltage  $U_s$**   
The following sub-functions are supplied from the control voltage  $U_s$ :
  - the fieldbus
  - the processor logic
  - typically the inputs and the sensors if the EtherCAT Box has inputs.
- **Peripheral voltage  $U_p$**   
For EtherCAT Box modules with digital outputs the digital outputs are typically supplied from the peripheral voltage  $U_p$ .  $U_p$  can be supplied separately. If  $U_p$  is switched off, the fieldbus function, the function of the inputs and the supply of the sensors are maintained.

The exact assignment of  $U_s$  and  $U_p$  can be found in the pin assignment of the I/O connections.

#### Redirection of the supply voltages

The power IN and OUT connections are bridged in the module. Hence, the supply voltages  $U_s$  and  $U_p$  can be passed from EtherCAT Box to EtherCAT Box in a simple manner.

### NOTICE

#### Note the maximum current!

Ensure that the permitted current for the connectors is not exceeded when routing the supply voltages  $U_s$  and  $U_p$ :

M8 connector: max. 4 A  
7/8" connector: max 16 A

### NOTICE

#### Unintentional cancellation of the electrical isolation of $GND_s$ and $GND_p$ possible.

In some types of EtherCAT Box modules the ground potentials  $GND_s$  and  $GND_p$  are connected.

- If several EtherCAT Box modules are supplied with the same electrically isolated voltages, check whether there is an EtherCAT Box among them in which the ground potentials are connected.

**4.2.4.1 Connectors**

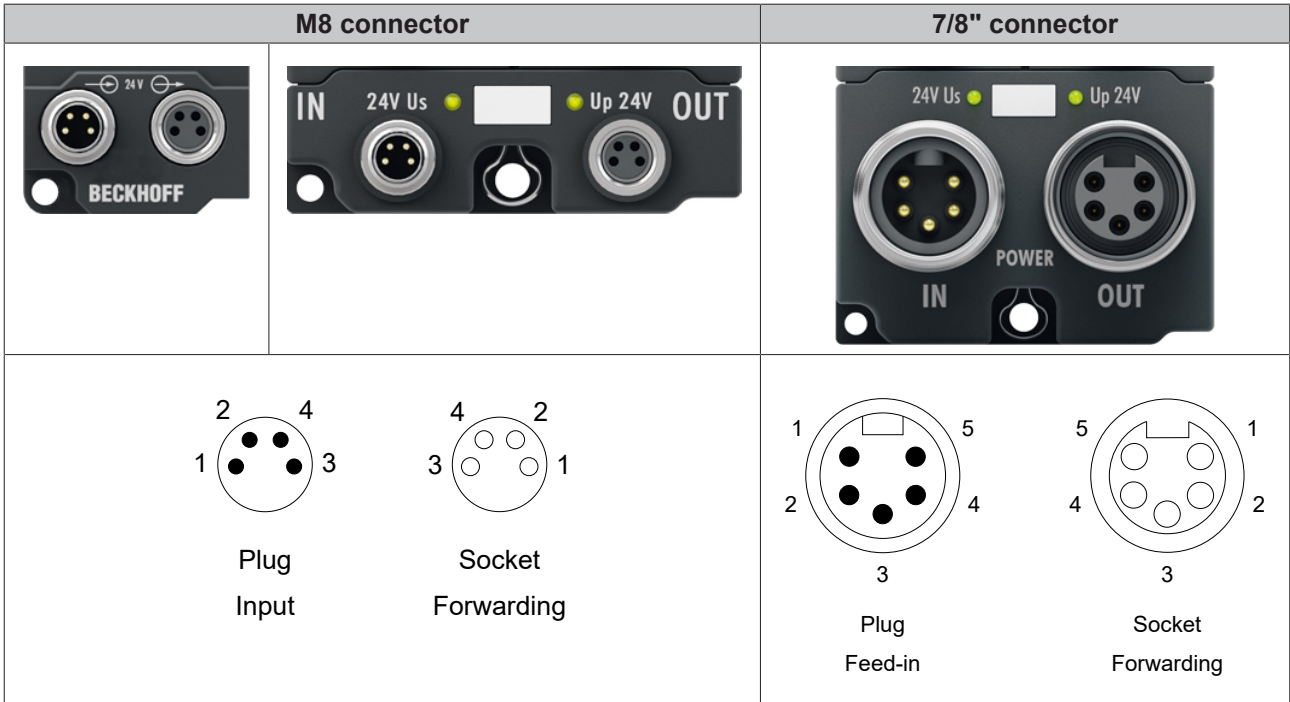

Function	M8	7/8"	Description	Core color <sup>1)</sup>
U <sub>s</sub>	1	4	Control voltage	Brown
U <sub>p</sub>	2	5	Peripheral voltage	White
GND <sub>s</sub>	3	2	GND to U <sub>s</sub>	Blue
GND <sub>p</sub>	4	1	GND to U <sub>p</sub>	Black
FE	-	3	Functional earth	Grey

<sup>1)</sup> The core colors apply to cables of the type: Beckhoff ZK2020-xxxx-xxxx

In some modules, GND<sub>s</sub> and GND<sub>p</sub> are connected, in others they are separate. See Technical data of the respective module.

**4.2.4.2 Status LEDs**



Fig. 25: Status LEDs for the supply voltages

LED	Display	Meaning
U <sub>s</sub> (control voltage)	off	The supply voltage U <sub>s</sub> is not available.
	green illuminated	The supply voltage U <sub>s</sub> is available.
	red illuminated	Red illumination of this LED has different meanings for different products: <ul style="list-style-type: none"> <li>• EP1839-0042: Undervoltage of the supply voltage U<sub>s</sub>.</li> <li>• Other products: Sensor supply overload.</li> </ul> In both cases all sensor supply outputs were switched off.
U <sub>p</sub> (peripheral voltage)	off	The supply voltage U <sub>p</sub> is not available.
	green illuminated	The supply voltage U <sub>p</sub> is available.
	red illuminated (EP1859-0042 only)	Due to overload (current > 0.5 A), the sensor supply generated from the supply voltage U <sub>p</sub> was switched off for all sensors supplied from it.

### 4.2.4.3 Conductor losses

Take into account the voltage drop on the supply line when planning a system. Avoid the voltage drop being so high that the supply voltage at the box lies below the minimum nominal voltage. Variations in the voltage of the power supply unit must also be taken into account.

#### Voltage drop on cables with M8 connectors

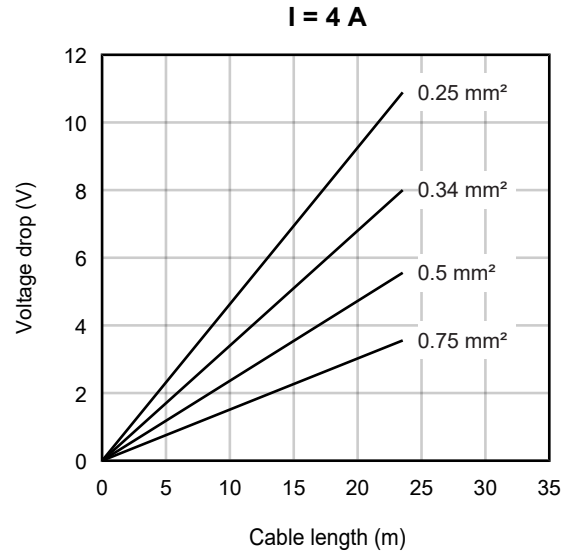
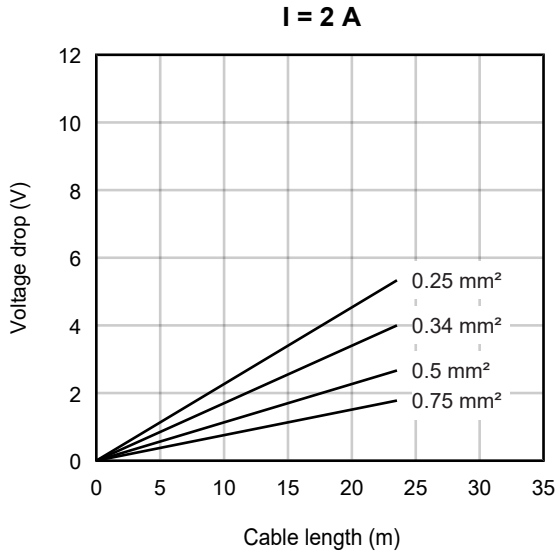

#### Voltage drop on cables with 7/8" connectors

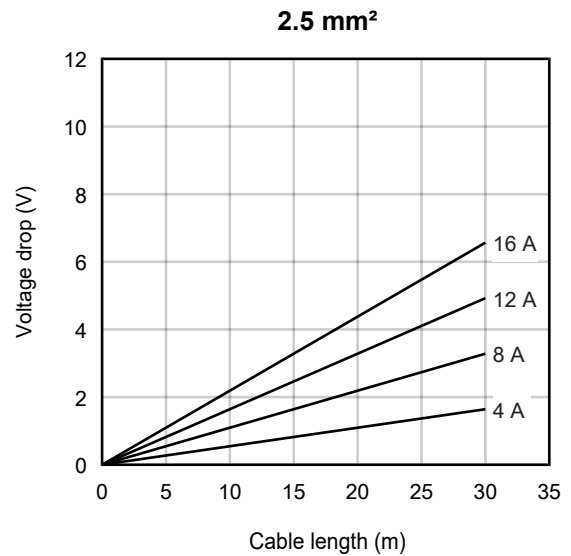
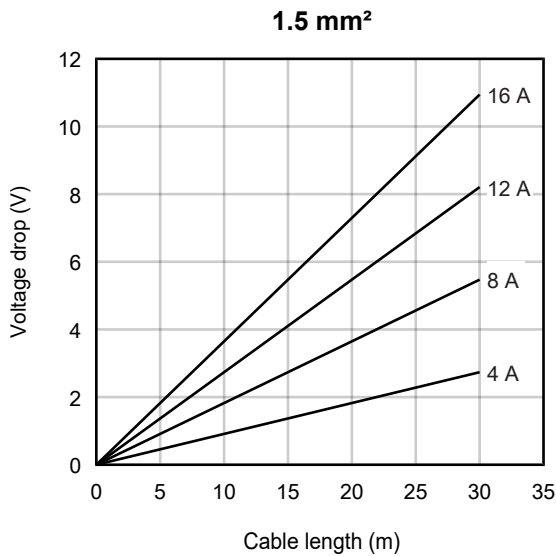

## 4.2.5 Digital inputs

### NOTICE

#### Incorrect signal levels due to electromagnetic interference

Digital inputs with a 10  $\mu$ s input filter are optimized for fast signal transmission and are therefore susceptible to electromagnetic interference.

Under the influence of electromagnetic interference, a false signal level can be detected.

- If necessary, use shielded signal lines.

### 4.2.5.1 M8 sockets, 3-pin

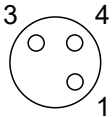

#### Pin assignment

Pin	Function	Wire color <sup>1)</sup>
1	$U_s$	brown
3	$GND_s$	blue
4	Input	black

<sup>1)</sup> The core colors apply to sensor cables from Beckhoff. See chapter [Accessories](#) [► 201].

#### Connection examples

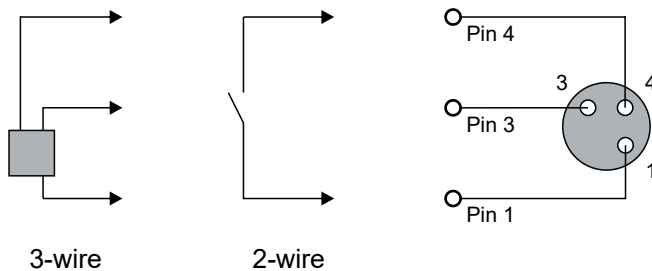

#### Status LEDs

There is a green LED next to each M8 socket. The LED lights up when a high level is detected at the digital input.





4.2.5.2 M8 sockets, 4-pin

**NOTICE**

**Incorrect signal levels due to electromagnetic interference**

The digital inputs are optimized for fast signal transmission and are therefore susceptible to electromagnetic interference.

Under the influence of electromagnetic interference, a false signal level can be detected.

- If necessary, use shielded signal lines.

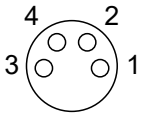

**Pin assignment**

Pin	Function
1	+24 V U <sub>S</sub>
2	Input B
3	GND <sub>S</sub>
4	Input A

**Connection example: An antivalent sensor**

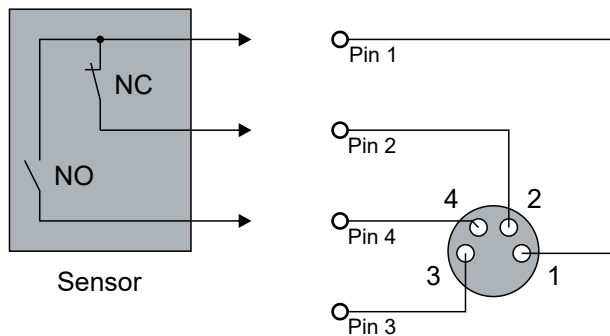

**i Diagnosis**

The EP1819-0005 has a diagnostic function for antivalent sensors. See chapter [Antivalent sensors \(EP1819-0005\)](#) [▶ 135].

**Connection example: Two non-antivalent sensors**

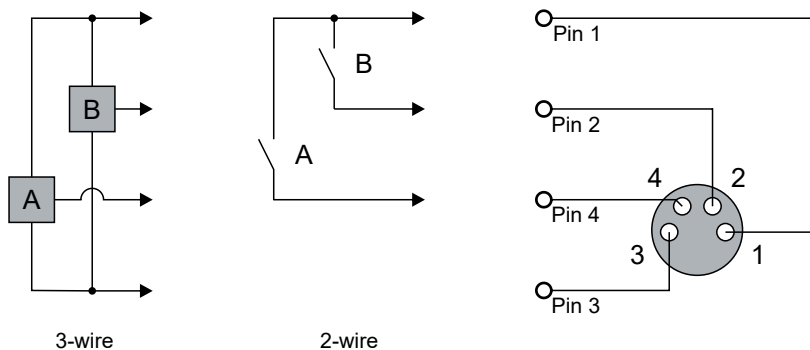

### Status LEDs

There is a green LED next to each M8 socket.



The behavior of the status LED depends on whether the diagnosis for antivalent sensors is enabled.

LED signal	Meaning with disabled diagnosis	Meaning with enabled diagnosis
off	Low level on pin 2 and pin 4.	No error. Low level on pin 4 and high level on pin 2.
green	High level on pin 2 and/or pin 4.	No error. High level on pin 4 and low level on pin 2.
red	n/a	Error

The procedure for enabling diagnosis can be found in the chapter [Antivalent sensors \(EP1819-0005\)](#) [▶ 135].

### 4.2.5.3 M12 sockets

Several EtherCAT Box modules with M12 sockets are described in this documentation. The M12 sockets of different EtherCAT Box modules have different pin assignments.

Select the correct EtherCAT Box from the following list:

[EP1008-0002](#) |▶ [92](#)]

[EP1008-0022](#) |▶ [93](#)]

[EP1018-0002](#) |▶ [92](#)]

[EP1258-0002](#) |▶ [92](#)]

[EP1809-0022](#) |▶ [94](#)]

[EP1809-0042](#) |▶ [95](#)]

[EP1819-0022](#) |▶ [96](#)]

[EP1839-0042](#) |▶ [97](#)]

[EP1859-0042](#) |▶ [99](#)]

**4.2.5.3.1 EP1xxx-0002**

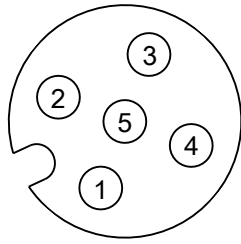
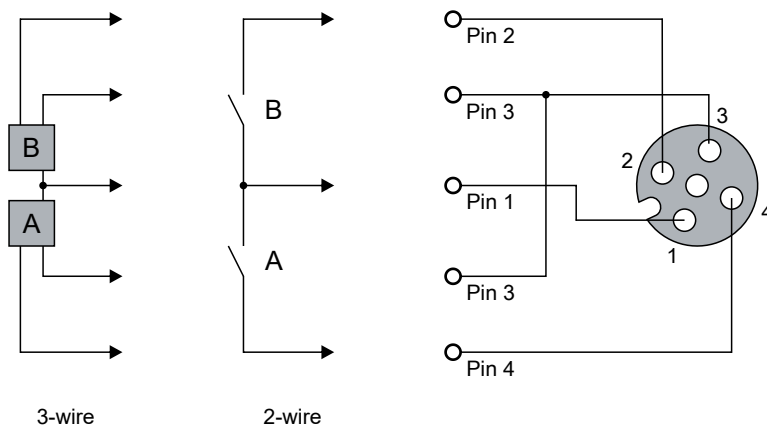

Fig. 26: M12 socket

Pin	Function	Wire color <sup>1)</sup>
1	U <sub>s</sub>	brown
2	Input B	white
3	GND <sub>s</sub>	blue
4	Input A	black
5	-	gray

<sup>1)</sup>The core colors apply to M12 cables from Beckhoff: ZK2000-5xxx, ZK2000-6xxx, ZK2000-7xxx

**Connection examples**



**Status LEDs**

Each M12 socket has two green LEDs. An LED lights up when a high level is detected at the respective input.

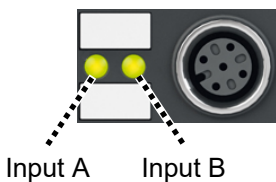

**4.2.5.3.2 EP1008-0022**

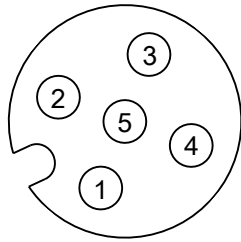
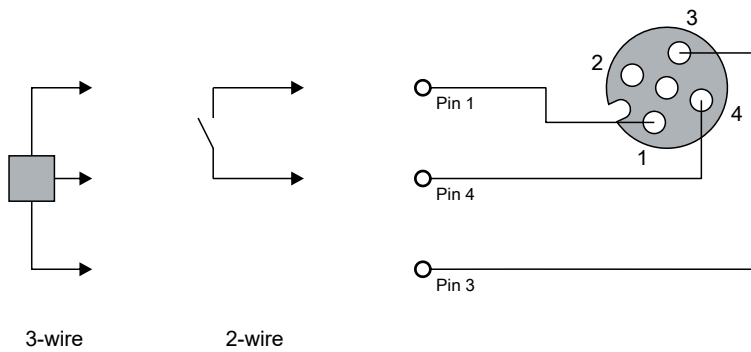

Fig. 27: M12 socket

Pin	Function	Wire color <sup>1)</sup>
1	U <sub>s</sub>	brown
2	-	white
3	GND <sub>s</sub>	blue
4	Input	black
5	-	gray

<sup>1)</sup>The core colors apply to M12 cables from Beckhoff: ZK2000-5xxx, ZK2000-6xxx, ZK2000-7xxx

**Connection examples**



**Status LEDs**

Each M12 socket has a green LED. The LED lights up when a high level is detected at the digital input.



Fig. 28: Status LED on an M12 socket for EP1008-0022

**4.2.5.3.3 EP1809-0022**

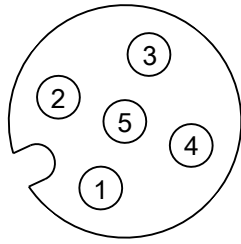
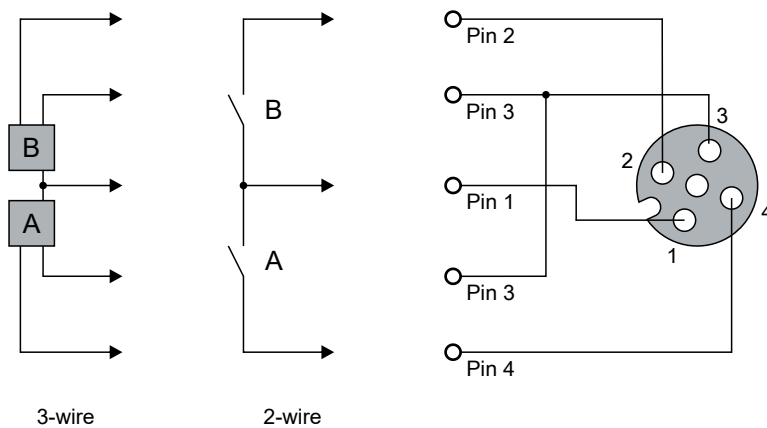

Fig. 29: M12 socket

Pin	Function	Wire color <sup>1)</sup>
1	U <sub>s</sub>	brown
2	Input B	white
3	GND <sub>s</sub>	blue
4	Input A	black
5	-	gray

<sup>1)</sup>The core colors apply to M12 cables from Beckhoff: ZK2000-5xxx, ZK2000-6xxx, ZK2000-7xxx

**Connection examples**



**Status LEDs**

Each M12 socket has two green LEDs. An LED lights up when a high level is detected at the respective input.



**4.2.5.3.4 EP1809-0042**

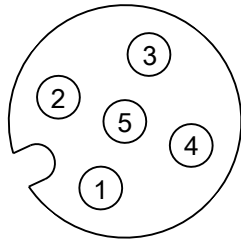
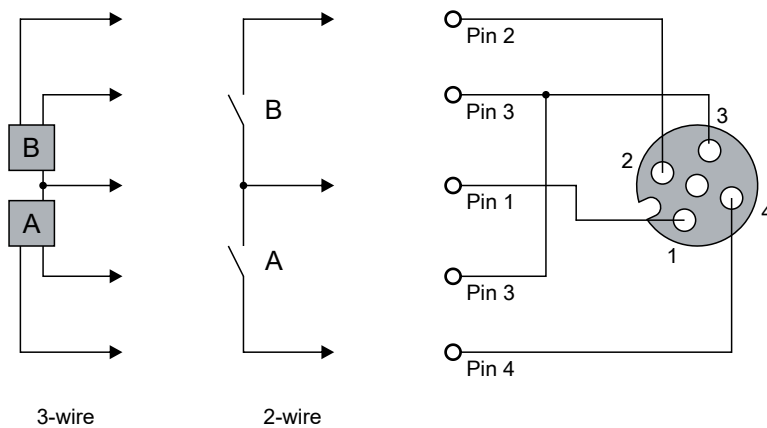

Fig. 30: M12 socket

Pin	Function	Wire color <sup>1)</sup>
1	U <sub>s</sub>	brown
2	Input B	white
3	GND <sub>s</sub>	blue
4	Input A	black
5	FE (Functional earth)	gray

<sup>1)</sup>The core colors apply to M12 cables from Beckhoff: ZK2000-5xxx, ZK2000-6xxx, ZK2000-7xxx

**Connection examples**



**Status LEDs**

Each M12 socket has two green LEDs. An LED lights up when a high level is detected at the respective input.



**4.2.5.3.5 EP1819-0022**

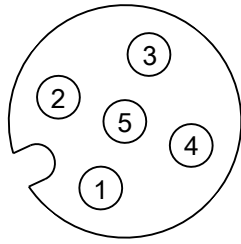
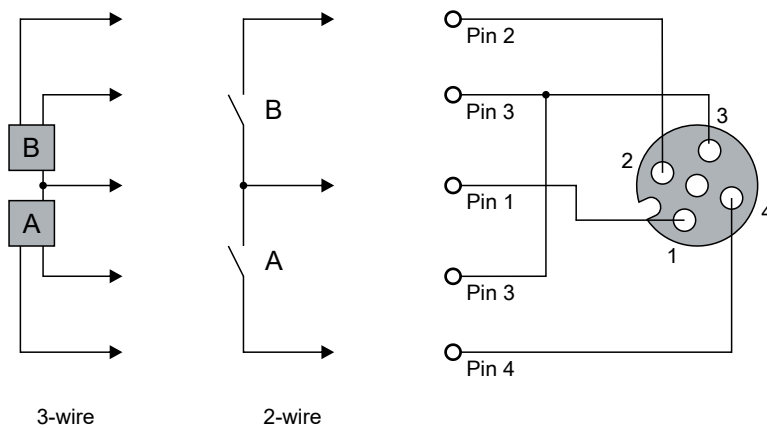

Fig. 31: M12 socket

Pin	Function	Wire color <sup>1)</sup>
1	U <sub>s</sub>	brown
2	Input B	white
3	GND <sub>s</sub>	blue
4	Input A	black
5	-	gray

<sup>1)</sup>The core colors apply to M12 cables from Beckhoff: ZK2000-5xxx, ZK2000-6xxx, ZK2000-7xxx

**Connection examples**



**Status LEDs**

Each M12 socket has two green LEDs. An LED lights up when a high level is detected at the respective input.





**4.2.5.3.6 EP1839-0042**

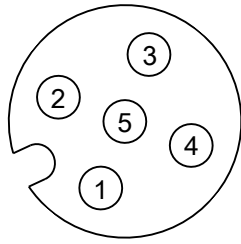

Fig. 32: M12 socket

Pin	Function	Wire color <sup>1)</sup>
1	$U_{S1} \dots U_{S8}$ <sup>2)</sup>	brown
2	Input B	white
3	$GND_S$	blue
4	Input A	black
5	FE (Functional earth)	gray

<sup>1)</sup>The core colors apply to M12 cables from Beckhoff: ZK2000-5xxx, ZK2000-6xxx, ZK2000-7xxx

<sup>2)</sup> Sensor supply: The output voltages  $U_{S1} \dots U_{S8}$  are branched off from the supply voltage  $U_S$ . Each output is independently short-circuit proof.

**Connection examples**

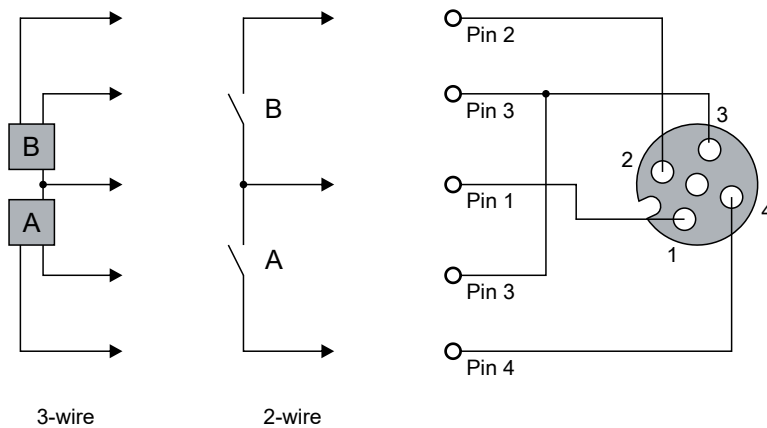

**Status LEDs**

Each M12 socket has two status LEDs.



Light signal of a status LED	Meaning
green illuminated	The input signal is logical high.
red illuminated	Wire breakage. See chapter <a href="#">Wire break detection (EP1839-0042)</a> [ <a href="#">▶ 136</a> ].
both LEDs light up red	Two possibilities: <ul style="list-style-type: none"><li>• Sensor supply error. See chapter <a href="#">Configure sensor supply (EP1839-0042)</a> [<a href="#">▶ 119</a>].</li><li>• Wire break at both inputs. See chapter <a href="#">Wire break detection (EP1839-0042)</a> [<a href="#">▶ 136</a>].</li></ul>

**4.2.5.3.7 EP1859-0042**

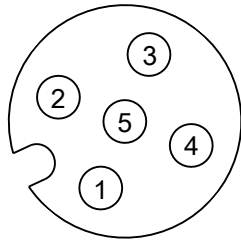
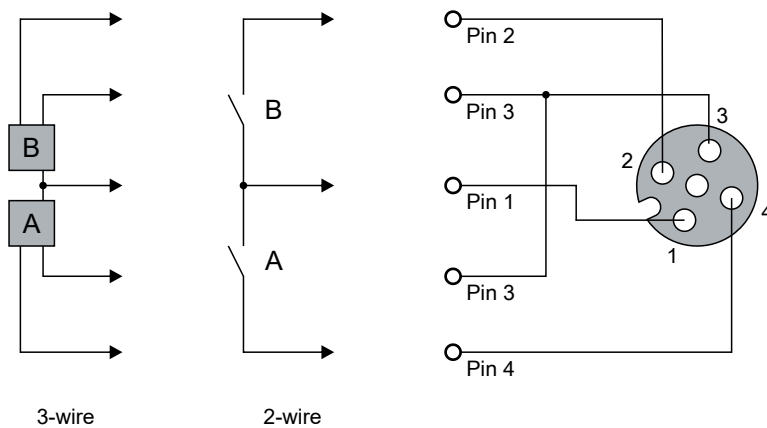

Fig. 33: M12 socket

Pin	Function	Wire color <sup>1)</sup>
1	U <sub>s</sub>	brown
2	Input B	white
3	GND <sub>s</sub>	blue
4	Input A	black
5	FE (Functional earth)	gray

<sup>1)</sup>The core colors apply to M12 cables from Beckhoff: ZK2000-5xxx, ZK2000-6xxx, ZK2000-7xxx

**Connection examples**



**Status LEDs**

Each M12 socket has two green LEDs. An LED lights up when a high level is detected at the respective input.



### 4.2.5.4 ZS2001: pluggable spring-loaded terminals

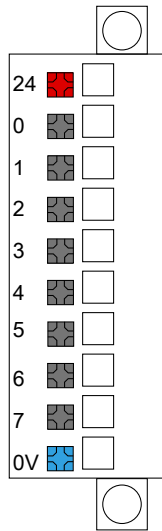

ZS2001-0001  
ZS2001-0002

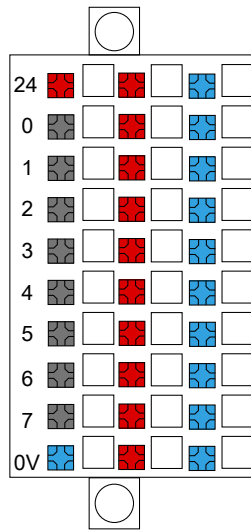

ZS2001-0004

#### Pin assignment

Contact	Function
0	Input 1
1	Input 2
2	Input 3
3	Input 4
4	Input 5
5	Input 6
6	Input 7
7	Input 8
"24"	$U_s$
"0V"	$GND_s$

ZS2001-0004 has three rows with ten terminal contacts each. The first row is occupied as shown in the table. The second and third rows are designed to distribute the supply voltage and ground. See connection examples:

**Connection examples**

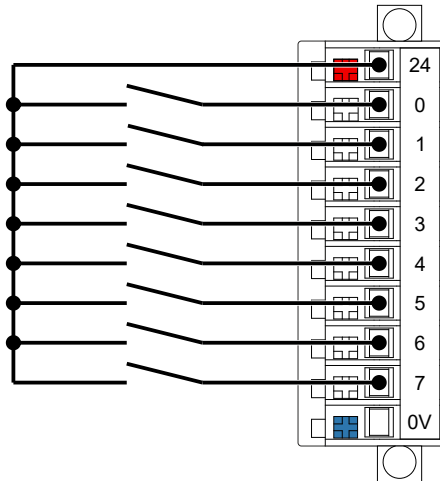

ZS2001-0001  
ZS2001-0002

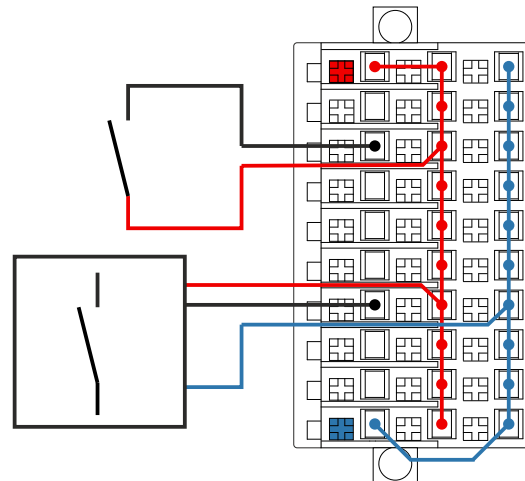

ZS2001-0004

The diagram shows the connection of 8 sensors in single-wire technology and one sensor each in two-wire and three-wire technology.

Please note for connector ZS2001-0004: two bridges (24 V and 0 V) are required to supply the terminal points for two-wire and three-wire connection technology.

**Status LEDs**

ZS2001-0002 and ZS2001-0004 have a green status LED for each digital input. An LED lights up when a high level is detected at the corresponding input.

### 4.2.5.5 D-sub sockets, 25-pin

#### Pin assignment

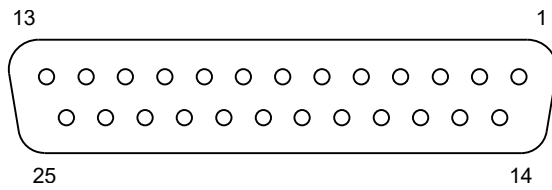

Fig. 34: D-sub socket, 25-pin

Pin	EP1816-0008	EP1816-1008	EP1816-3008
1	Channel 1, Input 1	$U_s$	$U_s$
2	Channel 1, Input 2	$GND_s$	$GND_s$
3	Channel 1, Input 3	Channel 1, Input 1	Channel 1, Input 1
4	Channel 1, Input 4	Channel 1, Input 2	Channel 1, Input 2
5	Channel 1, Input 5	Channel 1, Input 3	Channel 1, Input 3
6	Channel 1, Input 6	Channel 1, Input 4	Channel 1, Input 4
7	Channel 1, Input 7	Channel 1, Input 5	Channel 1, Input 5
8	Channel 1, Input 8	Channel 1, Input 6	Channel 1, Input 6
9	Channel 2, Input 1	Channel 1, Input 7	Channel 1, Input 7
10	Channel 2, Input 2	Channel 1, Input 8	Channel 1, Input 8
11	Channel 2, Input 3	Channel 2, Input 1	Channel 2, Input 1
12	Channel 2, Input 4	Channel 2, Input 2	Channel 2, Input 2
13	Channel 2, Input 5	Channel 2, Input 3	Channel 2, Input 3
14	Channel 2, Input 6	Channel 2, Input 4	Channel 2, Input 4
15	Channel 2, Input 7	Channel 2, Input 5	Channel 2, Input 5
16	Channel 2, Input 8	Channel 2, Input 6	Channel 2, Input 6
17	$U_s$	Channel 2, Input 7	Channel 2, Input 7
18	$U_s$	Channel 2, Input 8	Channel 2, Input 8
19	$U_s$	$U_s$	$U_s$
20	$U_s$	$U_s$	$U_s$
21	$U_s$	$U_s$	$U_s$
22	$U_s$	$U_s$	$U_s$
23	GND	$GND_s$	$GND_s$
24	GND	$GND_s$	$GND_s$
25	GND	$GND_s$	$GND_s$

<sup>1)</sup>  $U_{s1}$  serves as sensor supply voltage. It is branched off from the  $U_s$  supply voltage.

Connection examples

EP1816-0008

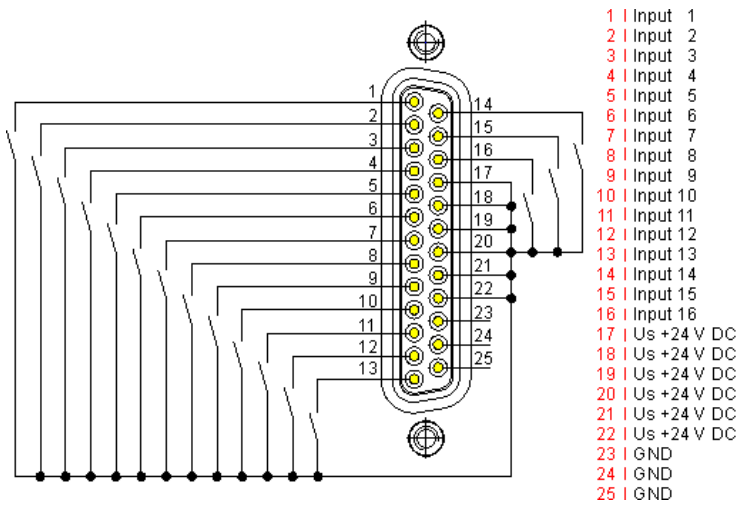

EP1816-1008

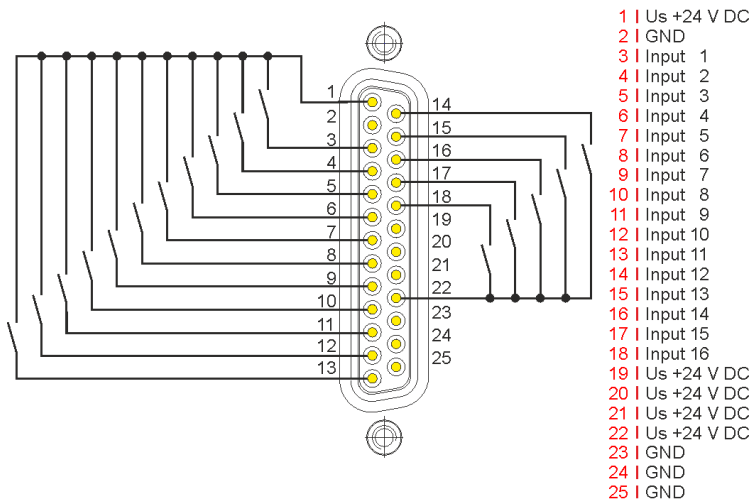

EP1816-3008

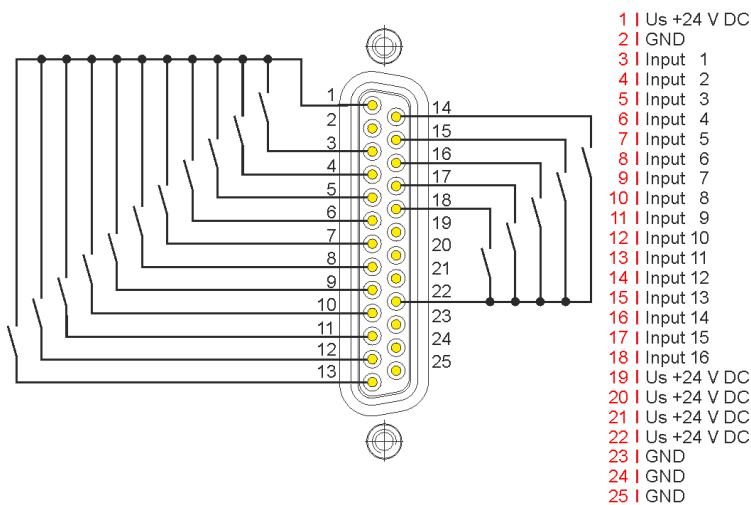

Fig. 35: Digital inputs D-sub, connection examples

**Status LEDs**

The D-sub socket has two green status LEDs.



Fig. 36: D-sub 25 status LEDs



## 4.2.6 Digital outputs (EP1859-0042 only)

### 4.2.6.1 M12 sockets

#### Pin assignment

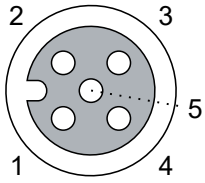
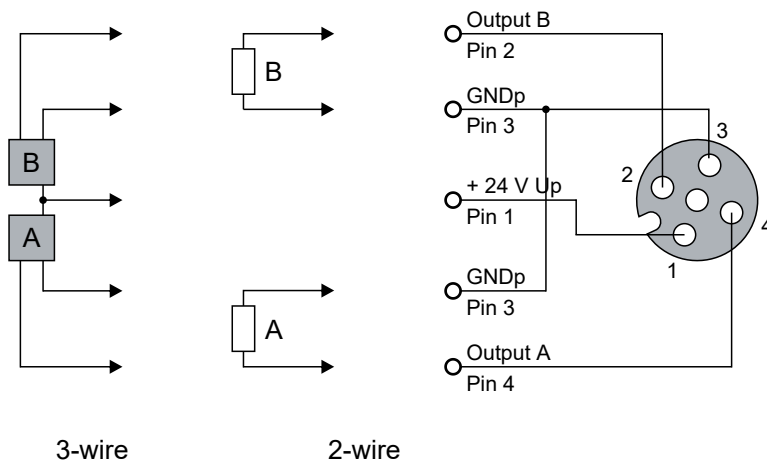

Fig. 37: M12 socket

Pin	Function	Wire color <sup>1)</sup>
1	+24 V U <sub>p</sub>	brown
2	Output B	white
3	GND <sub>p</sub>	blue
4	Output A	black
5	FE (Functional earth)	gray

<sup>1)</sup>The core colors apply to M12 cables from Beckhoff: ZK2000-5xxx, ZK2000-6xxx, ZK2000-7xxx

#### Connection examples



3-wire

2-wire

#### Status LEDs

LEDs indicate the signal state of the outputs.



## 4.3 UL Requirements

The installation of the EtherCAT Box Modules certified by UL has to meet the following requirements.

### Supply voltage

#### ⚠ CAUTION

##### CAUTION!

This UL requirements are valid for all supply voltages of all marked EtherCAT Box Modules!  
For the compliance of the UL requirements the EtherCAT Box Modules should only be supplied

- by a 24 V<sub>DC</sub> supply voltage, supplied by an isolating source and protected by means of a fuse (in accordance with UL248), rated maximum 4 Amp, or
- by a 24 V<sub>DC</sub> power source, that has to satisfy *NEC class 2*.  
A *NEC class 2* power supply shall not be connected in series or parallel with another (class 2) power source!

#### ⚠ CAUTION

##### CAUTION!

To meet the UL requirements, the EtherCAT Box Modules must not be connected to unlimited power sources!

### Networks

#### ⚠ CAUTION

##### CAUTION!

To meet the UL requirements, EtherCAT Box Modules must not be connected to telecommunication networks!

### Ambient temperature range

#### ⚠ CAUTION

##### CAUTION!

To meet the UL requirements, EtherCAT Box Modules has to be operated only at an ambient temperature range of -25 °C to +55 °C!

### Marking for UL

All EtherCAT Box Modules certified by UL (Underwriters Laboratories) are marked with the following label.



Fig. 38: UL label

## 4.4 ATEX notes

### 4.4.1 ATEX - Special conditions

#### ⚠ WARNING

**Observe the special conditions for the intended use of EtherCAT Box modules in potentially explosive areas – directive 94/9/EU.**

- The certified components are to be installed with a BG2000-0000 or BG2000-0010 protection enclosure [► 108] that guarantees a protection against mechanical hazards!
- If the temperatures during rated operation are higher than 70°C at the feed-in points of cables, lines or pipes, or higher than 80°C at the wire branching points, then cables must be selected whose temperature data correspond to the actual measured temperature values!
- Observe the permissible ambient temperature range of 0 to 55°C for the use of EtherCAT Box modules in potentially explosive areas!
- Measures must be taken to protect against the rated operating voltage being exceeded by more than 40% due to short-term interference voltages!
- The connections of the certified components may only be connected or disconnected if the supply voltage has been switched off or if a non-explosive atmosphere is ensured!

#### Standards

The fundamental health and safety requirements are fulfilled by compliance with the following standards:

- EN 60079-0: 2006
- EN 60079-15: 2005

#### Marking

The EtherCAT Box modules certified for potentially explosive areas bear the following marking:



II 3 G Ex nA II T4 DEKRA 11ATEX0080 X Ta: 0 - 55°C

or



II 3 G Ex nA nC IIC T4 DEKRA 11ATEX0080 X Ta: 0 - 55°C

#### Batch number (D number)

The EtherCAT Box modules bear a batch number (D number) that is structured as follows:

D: WW YY FF HH

WW - week of production (calendar week)

YY - year of production

FF - firmware version

HH - hardware version

Example with batch number 29 10 02 01:

29 - week of production 29

10 - year of production 2010

02 - firmware version 02

01 - hardware version 01

## 4.4.2 BG2000 - EtherCAT Box protection enclosures

### ⚠ WARNING

#### Risk of electric shock and damage of device!

Bring the EtherCAT system into a safe, powered down state before starting installation, disassembly or wiring of the modules!

### ATEX

### ⚠ WARNING

#### Mount a protection enclosure!

To fulfill the special conditions according to ATEX [▶ 107], a BG2000-0000 or BG2000-0010 protection enclosure has to be mounted over the EtherCAT Box.

### Installation

Put the cables for EtherCAT, power supply and sensors/actuators through the hole of the protection enclosure.

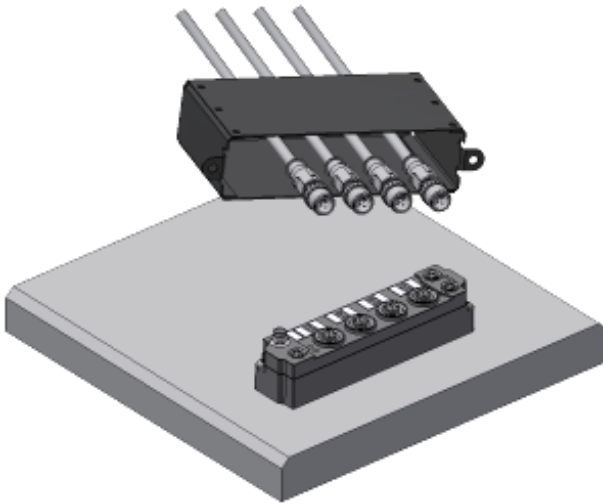

Fig. 39: BG2000 - putting the cables

Fix the wires for EtherCAT, power supply and sensors/actuators to the EtherCAT Box.

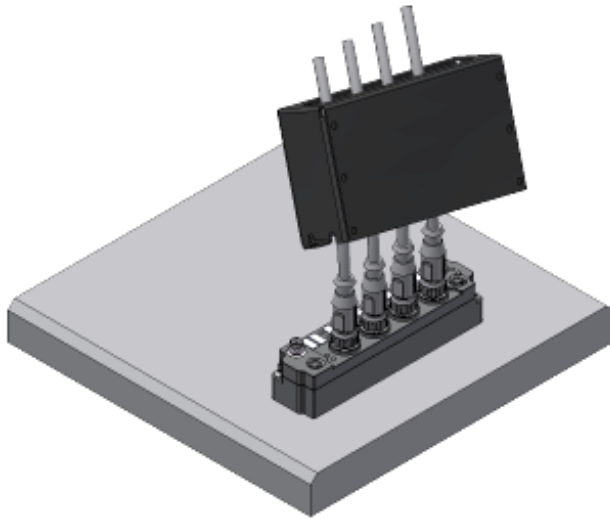

Fig. 40: BG2000 - fixing the cables

Mount the protection enclosure over the EtherCAT Box.

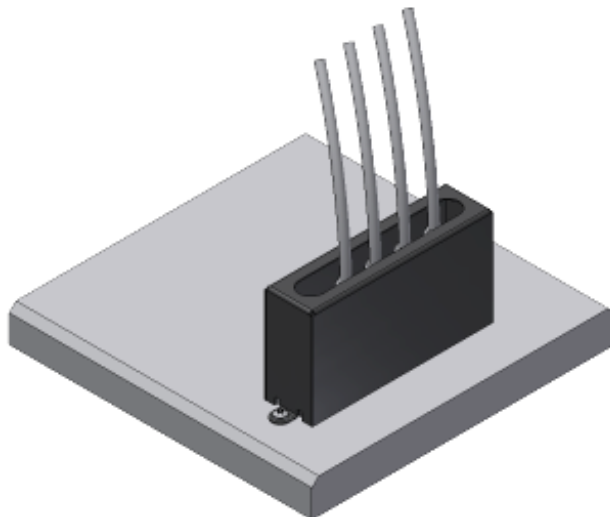

Fig. 41: BG2000 - mounting the protection enclosure

#### 4.4.3 ATEX Documentation



##### **Notes about operation of EtherCAT Box Modules (EPxxxx-xxxx) in potentially explosive areas (ATEX)**

Pay also attention to the continuative documentation Notes about operation of EtherCAT Box Modules (EPxxxx-xxxx) in potentially explosive areas (ATEX) that is available in the download area of the Beckhoff homepage <http://www.beckhoff.com>!

## 4.5 Disposal



Products marked with a crossed-out wheeled bin shall not be discarded with the normal waste stream. The device is considered as waste electrical and electronic equipment. The national regulations for the disposal of waste electrical and electronic equipment must be observed.

## **5 Commissioning and configuration**

### **5.1 Integrating into a TwinCAT project**

The procedure for integration in a TwinCAT project is described in this [Quick start guide](#).

## 5.2 Adapt process image (EP1819-0005, EP1839-0042)

You can set which process data objects are transferred in the process image of an EtherCAT device. Possible reasons to do this:

- Activate additional process data objects to control sub-functions that are not activated in the factory setting.
- Remove unused process data objects from the process image.

Recommendation: use the "Predefined PDO Assignments" for this purpose. "Predefined PDO Assignments" are useful predefined assemblies of process data objects.

An overview of the Predefined PDO Assignments and process data objects can be found in chapter [Process image - EP1839-0042](#) [▶ 64].

### Setting a Predefined PDO Assignment using EP1839-0042 as example

1. Double-click in the Solution Explorer on the EtherCAT device whose process image you want to change.

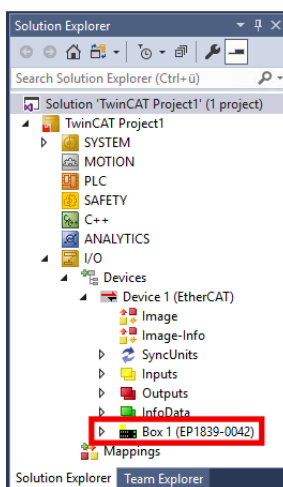

2. Click the "Process Data" tab.

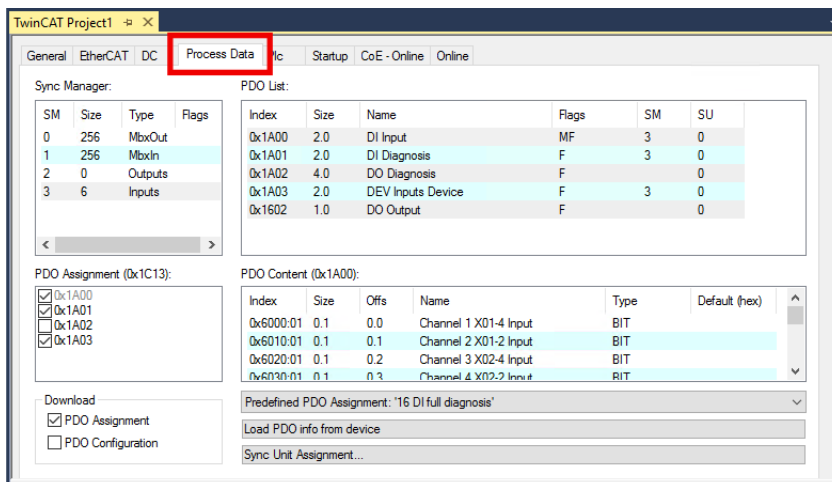



3. Select the desired entry in the drop-down menu "Predefined PDO Assignment".

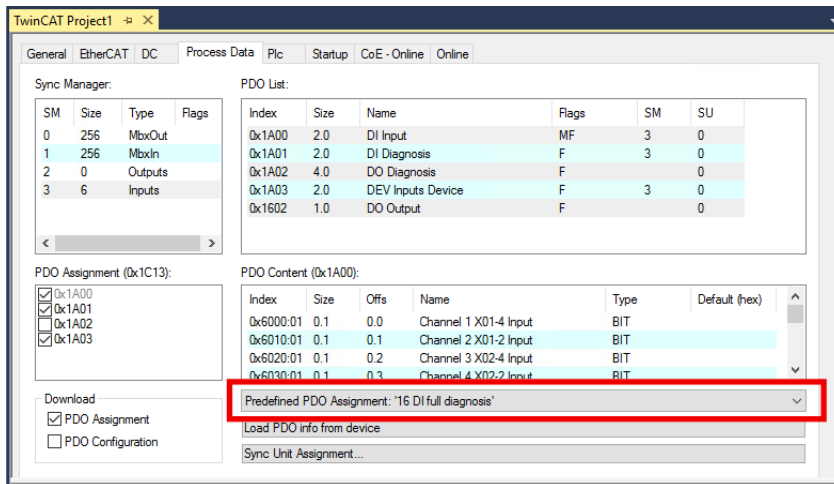

## 5.3 Configure inputs (EP1839-0042)

The input signal is digitally preprocessed. The following figure shows the signal flow of a digital input:

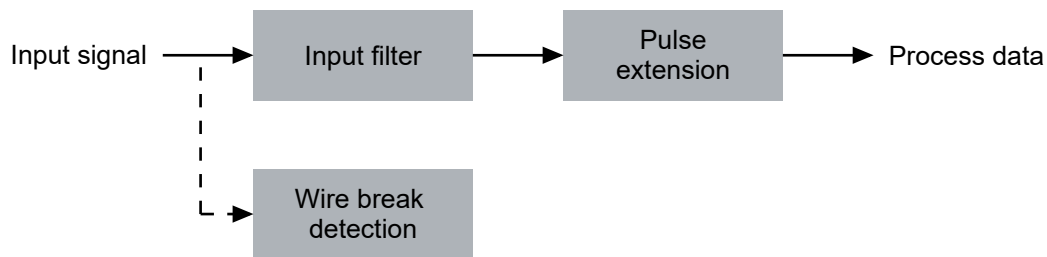

You can configure the sub-functions:

- [Input filter \[► 114\]](#)
- [Pulse extension \[► 116\]](#)
- [Wire break detection \(EP1839-0042\) \[► 136\]](#)

### 5.3.1 Input filter

The input filter is a digital filter. Pulses shorter than the filter time are filtered out. The input signal is passed on delayed by the filter time. See [Examples \[► 115\]](#).

You can set the filter time for each input individually in the CoE parameters  $80x00:11_{\text{hex}}$  "Filter time".

The screenshot shows the 'CoE - Online' tab in the configuration software. The parameter table is as follows:

Index	Name	Flags	Value	Unit
7120:0	DO Output Ch.03	RO	> 1 <	
7130:0	DO Output Ch.04	RO	> 1 <	
7140:0	DO Output Ch.05	RO	> 1 <	
7150:0	DO Output Ch.06	RO	> 1 <	
7160:0	DO Output Ch.07	RO	> 1 <	
7170:0	DO Output Ch.08	RO	> 1 <	
8000:0	DI Settings Ch.01	RW	> 18 <	
8000:01	Enable wirebreak detection	RW	FALSE	
8000:11	Filter time	RW	Filter off (0)	
8000:12	Signal extension time	RW	Extension off (0)	
8010:0	DI Settings Ch.02	RW	> 18 <	
8020:0	DI Settings Ch.03	RW	> 18 <	
8030:0	DI Settings Ch.04	RW	> 18 <	
8040:0	DI Settings Ch.05	RW	> 18 <	

The 'Set Value Dialog' box is open, showing the 'Enum' dropdown menu with the following options: Filter off, Filter off, 125µs, 250µs, 500µs, 750µs, 1ms, 3ms. The 'Filter off' option is selected.

The assignment of the CoE parameters to the connection designations can be found in the chapter [Assignment of the connections \[► 118\]](#).

**Example 1**

A positive pulse shorter than the filter time is filtered out.

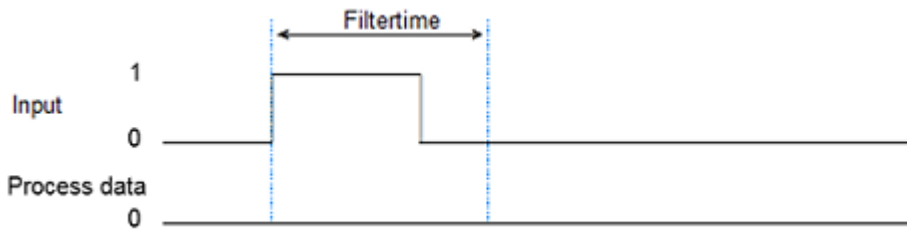

**Example 2**

A negative pulse shorter than the filter time is filtered out.

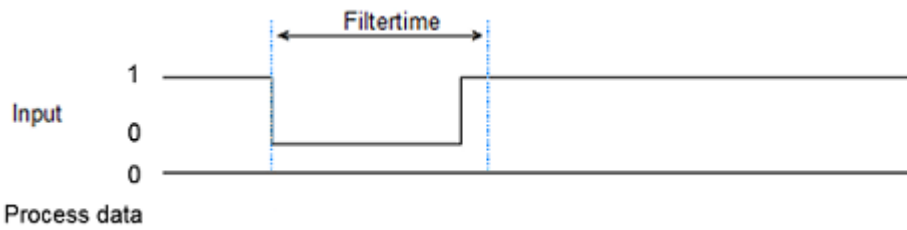

**Example 3**

A positive signal edge is delayed by the filter time.

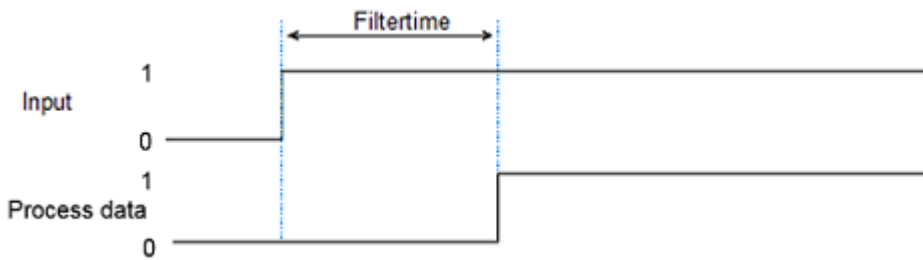

**Example 4**

A negative signal edge is delayed by the filter time.

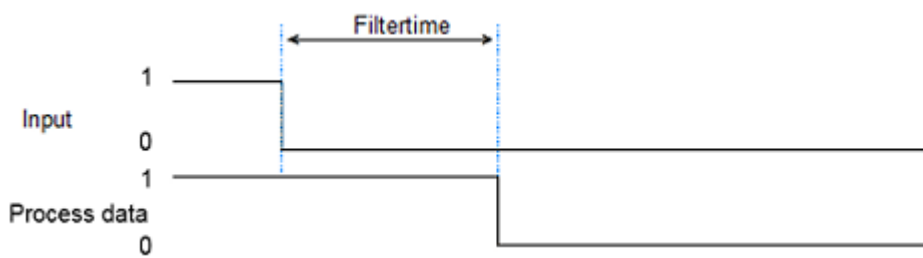

### 5.3.2 Pulse extension

The pulse extension extends short pulses to a minimum length. Pulses that occur while a previous pulse is being extended are ignored. Pulses can be positive or negative, i.e. jumps from 0 to 1 or from 1 to 0.

Pulse extension is located downstream of the input filter in the signal flow. Pulses shorter than the input filter time are therefore filtered out before they reach the pulse extension.

You can set the pulse extension time for each input individually in the CoE parameters 80x00:12<sub>hex</sub> "Signal extension time".

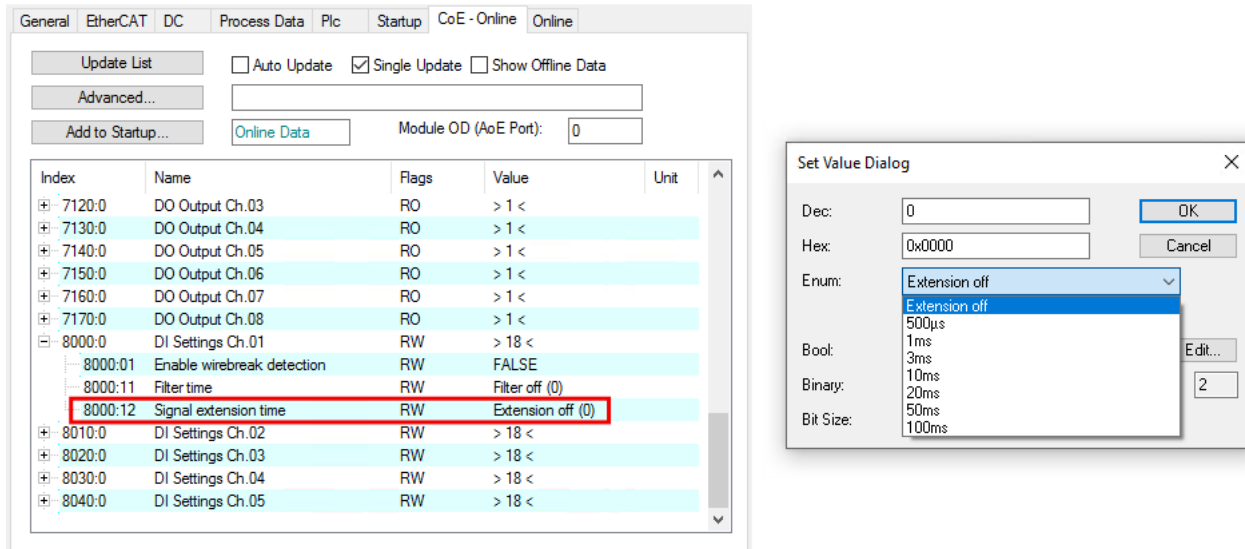

The assignment of the CoE parameters to the connection designations can be found in the chapter [Assignment of the connections \[► 118\]](#).

#### Example 1

A short positive pulse is extended to the pulse extension time.

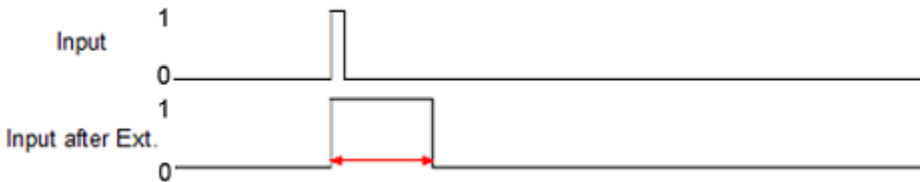

#### Example 2

A short negative pulse is extended to the pulse extension time.

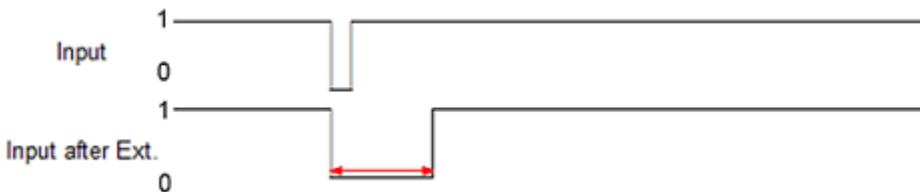

#### Example 3

A short pulse is extended to the pulse extension time. The second pulse is within the pulse extension time and is ignored.

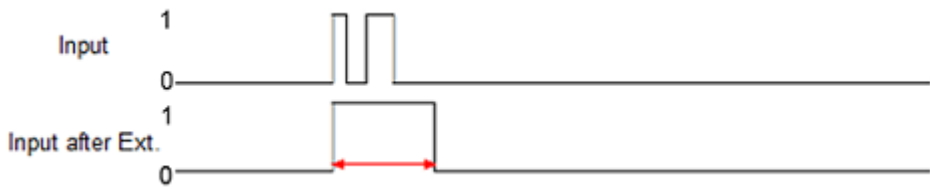

**Example 4**

A pulse that is longer than the pulse extension time is passed on unchanged.

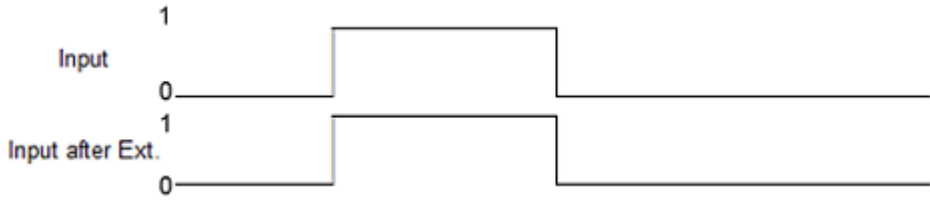

### 5.3.3 Assignment of the connections

The following table shows the assignment of the digital inputs to the CoE objects with which they are configured.

Connection	Channel No.	CoE object for configuration
X01, pin 4	1	8000 <sub>hex</sub>
X01, pin 2	2	8010 <sub>hex</sub>
X02, pin 4	3	8020 <sub>hex</sub>
X02, pin 2	4	8030 <sub>hex</sub>
X03, pin 4	5	8040 <sub>hex</sub>
X03, pin 2	6	8050 <sub>hex</sub>
X04, pin 4	7	8060 <sub>hex</sub>
X04, pin 2	8	8070 <sub>hex</sub>
X05, pin 4	9	8080 <sub>hex</sub>
X05, pin 2	10	8090 <sub>hex</sub>
X06, pin 4	11	80A0 <sub>hex</sub>
X06, pin 2	12	80B0 <sub>hex</sub>
X07, pin 4	13	80C0 <sub>hex</sub>
X07, pin 2	14	80D0 <sub>hex</sub>
X08, pin 4	15	80E0 <sub>hex</sub>
X08, pin 2	16	80F0 <sub>hex</sub>

## 5.4 Configure sensor supply (EP1839-0042)

In the factory setting, the sensor supply outputs behave like ordinary supply voltage outputs. They are switched on by default and output the supply voltage  $U_s$  to connected sensors.

### 5.4.1 Switching outputs

You can switch the sensor supply outputs like digital outputs.

#### Preparation

To be able to switch an output, set the corresponding CoE parameter 81x00:06 "Use output as power supply" to FALSE.

Connection	CoE parameters
X01	8100:06
X02	8110:06
X03	8120:06
X04	8130:06
X05	8140:06
X06	8150:06
X07	8160:06
X08	8170:06

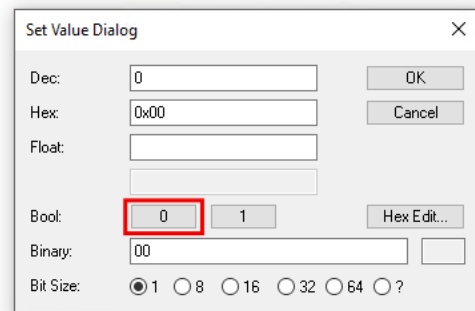
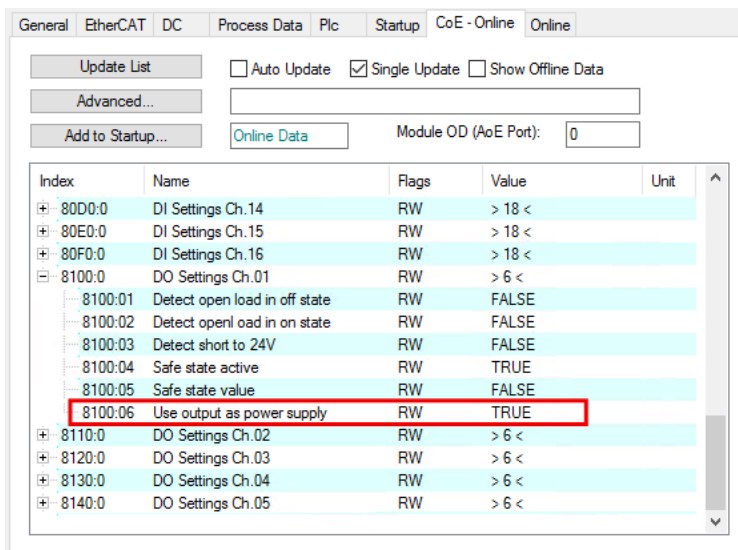

#### Process data

The variables for switching the outputs are located in the process data object [DO Output \[▶ 69\]](#).

This process data object is disabled in the factory settings. You can enable it by setting the Predefined PDO Assignment "16 DI full diagnosis 8 DO sensor supply". The procedure for setting a Predefined PDO Assignment can be found in chapter [Adapt process image \(EP1819-0005, EP1839-0042\) \[▶ 112\]](#).

### 5.4.2 Behavior on EtherCAT failure

You can define which switching state an output is to assume in the event of an EtherCAT failure. However, this only affects outputs that you have configured for switching, see chapter [Switching outputs](#) [▶ 119].

#### Functioning

If the EtherCAT state is not OP , the box switches all digital outputs to the switching state "Safe state value". This does not only happen in case of an EtherCAT failure, but also in the following cases, for example:

- EtherCAT start-up phase, e.g. shortly after switching on the supply voltage
- Manual change of the EtherCAT status by the EtherCAT master

#### Configure

In the factory setting the "Safe state value" of all outputs is the value FALSE. The outputs are therefore switched off if the EtherCAT communication fails.

You can set the value for each output individually in the CoE parameters  $80n00:05_{hex}$  "Safe state value".

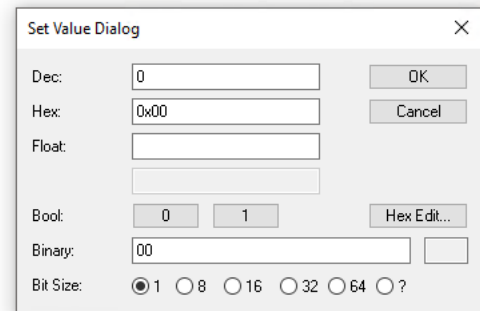
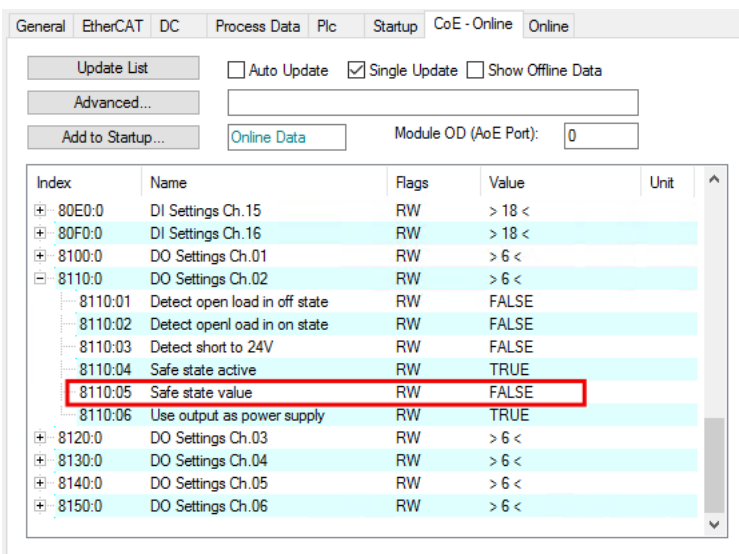

#### Deactivate

If you deactivate the function "Safe state", the respective channel retains the switching state it had before the communication failure after an EtherCAT failure

In the factory setting, the function "Safe state" is activated for all outputs. You can deactivate them individually for each output. To do this, set the CoE parameter  $80n00:04_{hex}$  "Safe state active" to FALSE.



General EtherCAT DC Process Data Plc Startup CoE - Online Online

Update List  Auto Update  Single Update  Show Offline Data

Advanced...

Add to Startup...  Module OD (AoE Port):

Index	Name	Flags	Value	Unit
80E0:0	DI Settings Ch.15	RW	> 18 <	
80F0:0	DI Settings Ch.16	RW	> 18 <	
8100:0	DO Settings Ch.01	RW	> 6 <	
8110:0	DO Settings Ch.02	RW	> 6 <	
8110:01	Detect open load in off state	RW	FALSE	
8110:02	Detect open load in on state	RW	FALSE	
8110:03	Detect short to 24V	RW	FALSE	
8110:04	Safe state active	RW	TRUE	
8110:05	Safe state value	RW	FALSE	
8110:06	Use output as power supply	RW	TRUE	
8120:0	DO Settings Ch.03	RW	> 6 <	
8130:0	DO Settings Ch.04	RW	> 6 <	
8140:0	DO Settings Ch.05	RW	> 6 <	
8150:0	DO Settings Ch.06	RW	> 6 <	

Set Value Dialog

Dec:

Hex:

Float:

Bool:  0  1

Binary:

Bit Size:  1  8  16  32  64  ?

## 5.5 Acceleration measurement (EP1816-3008)

EP1816-3008 has two accelerometers. Each accelerometer measures the acceleration in all three spatial directions.

The accelerometers are offset by 90°. This enables a plausibility check of the measured values.

By converting the measured acceleration values, it is also possible to measure the inclination. See chapter: [Inclination measurement \[► 126\]](#)

### 5.5.1 Acceleration axes

The following diagram shows the directions of the acceleration axes:

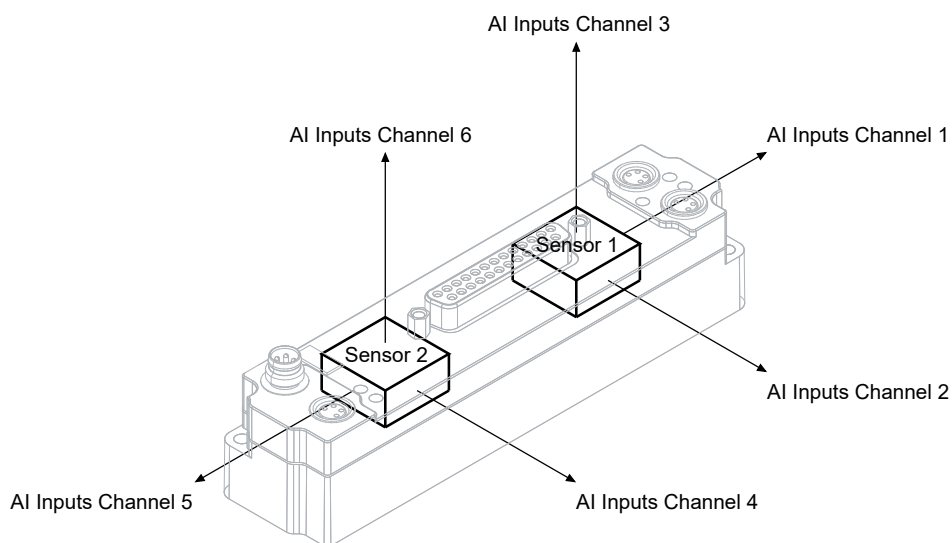

"AI Inputs Channel 1" to "AI Inputs Channel 6" are the process data objects that contain the measured values.

See chapter: ["Process Image", section "AI Inputs Channel 1 to 6" \[► 54\]](#).

## 5.5.2 Configuration

This chapter describes the parameters for acceleration measurement.

You can find the parameters in CoE object 8080<sub>hex</sub> "SAI settings".

### 5.5.2.1 Sampling rate

In the factory setting the sampling rate is set to 5 kHz. 5 kHz is the highest possible sampling rate.

You can change the sampling rate in parameter 8080:0D<sub>hex</sub> "Mode".

Recommendation: Leave the sampling rate at 5 kHz. A lower sampling rate has no advantages.

Index	Name	Flags	Value	Unit
8050:0	AI Settings Ch.4	RW	> 24 <	
805F:0	AI Vendor data Ch.4	RW	> 2 <	
8060:0	AI Settings Ch.5	RW	> 24 <	
806F:0	AI Vendor data Ch.5	RW	> 2 <	
8070:0	AI Settings Ch.6	RW	> 24 <	
807F:0	AI Vendor data Ch.6	RW	> 2 <	
8080:0	SAI Settings	RW	> 29 <	
8080:0D	Mode	RW	5000Hz (12)	
8080:11	Range	RW	+2G (3)	
8080:1D	Presentation	RW	Raw Values (3)	
F000:0	Modular device profile	RO	> 2 <	
F008	Code word	RW	0x00000000 (0)	
F010:0	Module list	RW	> 9 <	
F600:0	DIG Inputs	RO	> 16 <	

Set Value Dialog

Dec: 12

Hex: 0x000C

Enum: 5000Hz

Boot: 1Hz, 10Hz, 25Hz, 50Hz, 100Hz, 200Hz, 400Hz, 1600Hz, 5000Hz

Binary: 2

Bit Size: 2

### 5.5.2.2 Measuring range

In the factory setting the measuring range is ±2 g.

You can change the measuring range in parameter 8080:11<sub>hex</sub> "Range".

Index	Name	Flags	Value	Unit
8050:0	AI Settings Ch.4	RW	> 24 <	
805F:0	AI Vendor data Ch.4	RW	> 2 <	
8060:0	AI Settings Ch.5	RW	> 24 <	
806F:0	AI Vendor data Ch.5	RW	> 2 <	
8070:0	AI Settings Ch.6	RW	> 24 <	
807F:0	AI Vendor data Ch.6	RW	> 2 <	
8080:0	SAI Settings	RW	> 29 <	
8080:0D	Mode	RW	5000Hz (12)	
8080:11	Range	RW	+2G (3)	
8080:1D	Presentation	RW	Raw Values (3)	
F000:0	Modular device profile	RO	> 2 <	
F008	Code word	RW	0x00000000 (0)	
F010:0	Module list	RW	> 9 <	
F600:0	DIG Inputs	RO	> 16 <	

Set Value Dialog

Dec: 3

Hex: 0x0003

Enum: +2G

Boot: +2G, +4G, +8G, +16G

Binary: 03 00

Bit Size: 16

### 5.5.2.3 Display of the measured values

In the factory setting the measured values are displayed as raw values.

You can change the display in parameter 8080:1D<sub>hex</sub> "Presentation".

Index	Name	Flags	Value	Unit
8050:0	AI Settings Ch.4	RW	> 24 <	
805F:0	AI Vendor data Ch.4	RW	> 2 <	
8060:0	AI Settings Ch.5	RW	> 24 <	
806F:0	AI Vendor data Ch.5	RW	> 2 <	
8070:0	AI Settings Ch.6	RW	> 24 <	
807F:0	AI Vendor data Ch.6	RW	> 2 <	
8080:0	SAI Settings	RW	> 29 <	
8080:0D	Mode	RW	5000Hz (12)	
8080:11	Range	RW	+2G (3)	
8080:1D	Presentation	RW	Raw Values (3)	
F000:0	Modular device profile	RO	> 2 <	
F008	Code word	RW	0x00000000 (0)	
F010:0	Module list	RW	> 9 <	
F600:0	DIG Inputs	RO	> 16 <	

Set Value Dialog

Dec: 3

Hex: 0x0003

Enum: Raw Values

Boot: Horizontal Off-Axis Angle

Binary: 03 00

Bit Size: 1 8 16 32 64 ?

Select one of the following display types:

- "Raw Values": display as raw values
- "milli G": display as physical values with the unit mg.

The option "Horizontal Off-Axis Angle" does not apply for the display of the measured acceleration values. "Horizontal Off-Axis Angle" activates the [inclination measurement](#) [► 126].

Evaluate the measured values according to the selected display type. See chapter: [Interpretation of the measured values](#) [► 125]

The raw values have a higher resolution than the physical values.

### 5.5.3 Interpretation of the measured values

The measured acceleration values can be displayed in two different ways. See chapter [Display of the measured values](#) [► 124].

The interpretation of the measured values depends on the display type.

#### Interpretation of the raw values

The raw values are arranged in the most significant 10 bits of the variable "Value", which is 16 bits long:

<b>Bit:</b>	15	14	13	12	11	10	9	8	7	6	5	4	3	2	1	0
<b>Contents:</b>	Raw value										0	0	0	0	0	0

Recommendation: in the PLC program use the function `SHR()` to shift a raw value to the least significant 10 bits: `SHR(<measured value>, 6)`. After shifting the raw value is easier to process.

The raw values can range between -510 and +510:

- -510 is the lowest value of the measuring range.  
In the +/-2 g measuring range, the lowest value is -2 g.
- +510 corresponds to the full scale value.  
In the +/-2 g measuring range, the full scale value is +2 g.

Between -510 and +510 the raw values are linear. Use the following formula to convert a raw value to a physical quantity:

$$a = MBE \times \frac{n}{510}$$

*a*: Acceleration. Unit: g.  
1 g = 9.81 m/s<sup>2</sup>  
MBE: full scale value  
*n*: raw value

#### Interpretation of the physical values

The physical values have the unit mg.  
1 mg = 0.001 x 9.81 m/s<sup>2</sup>

## 5.6 Inclination measurement (EP1816-3008)

The inclination measurement determines the inclination of the Box in relation to the gravity. The angles of inclination are calculated from the measured acceleration values [► 122].

EP1816-3008 can calculate two angles of inclination with a resolution of 1°.

See chapter Calculation in the Box [► 126].

If a higher resolution is required, the calculation has to be implemented in the PLC program on the controller. Reason: calculation of the angles of inclination with higher resolutions is very computationally intensive.

See chapter Calculation in the controller [► 128]

### 5.6.1 Calculation in the Box

This chapter describes how to configure EP1816-3008 to calculate angles of inclination internally.

#### Configuration

1. Set the parameter 8080:11<sub>hex</sub> "Range" to any value except "+-16G".  
Recommended: "+-2G" (factory setting)

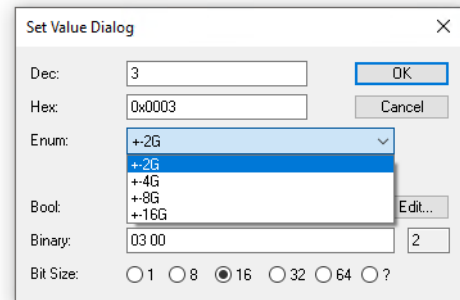
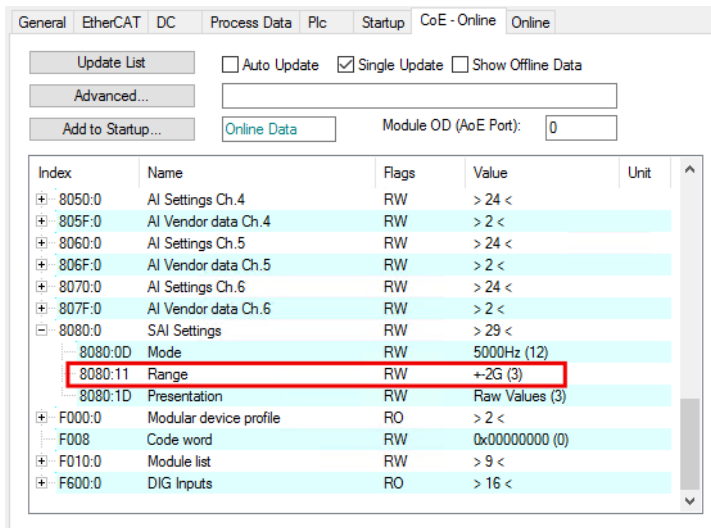

2. Set the parameter 8080:1D<sub>hex</sub> "Presentation" to the value "Horizontal Off-Axis Angle".

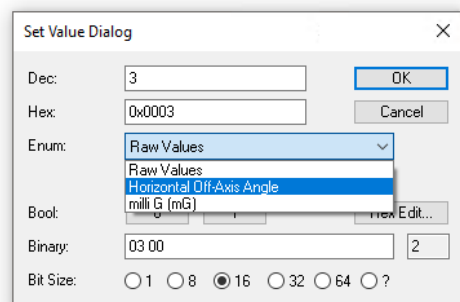
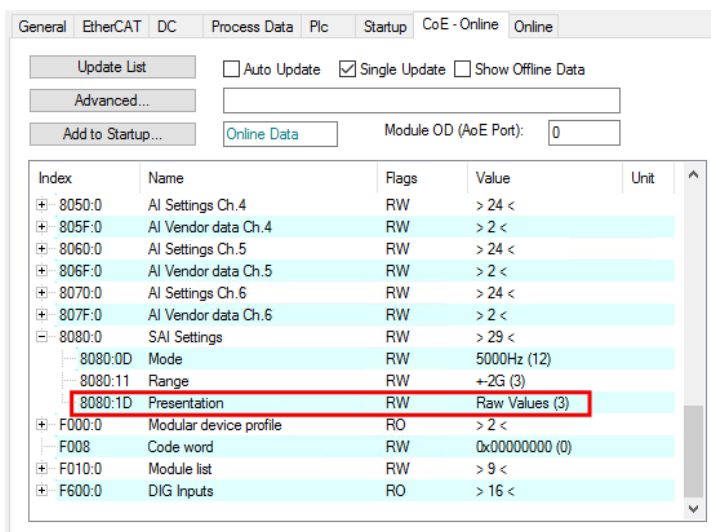

⇒ Internal calculation of the angles of inclination is activated.

**Evaluation**

Evaluate the variables in the process image according to the following diagram:

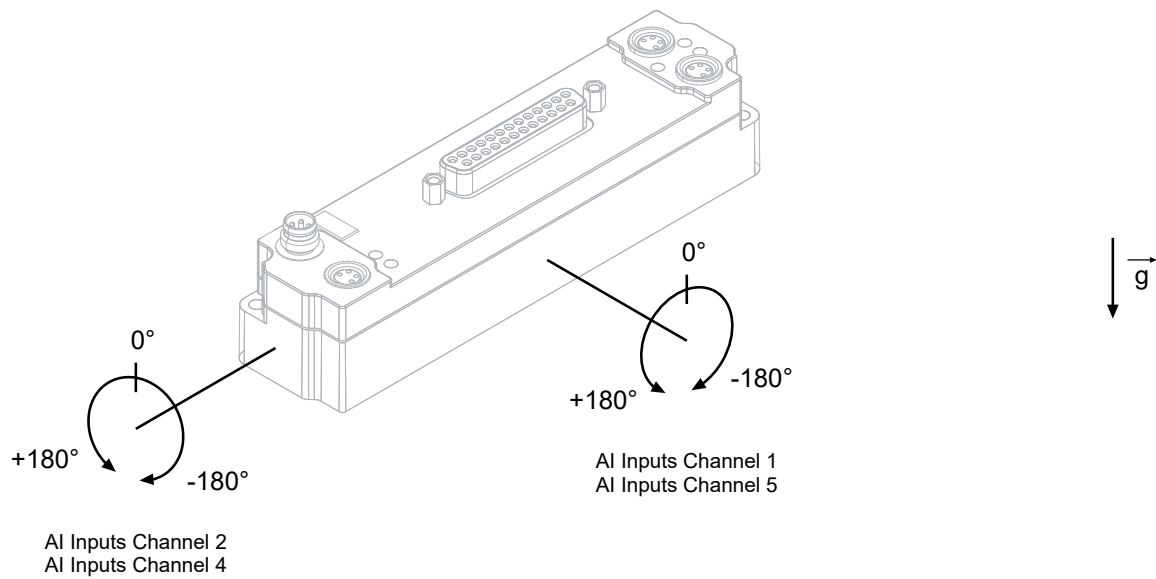

"AI Inputs Channel 1" to "AI Inputs Channel 5" are the process data objects that contain the calculated angles of inclination.

See chapter: ["Process Image", section "AI Inputs Channel 1 to 6" \[► 54\]](#).

The angles of inclination are output in the unit "1 degree per LSB".

## 5.6.2 Calculation in the controller

### Configuration

1. Set the parameter 8080:11<sub>hex</sub> "Range" to the value "+-2G".  
Explanation: this is the measuring range with the highest resolution.

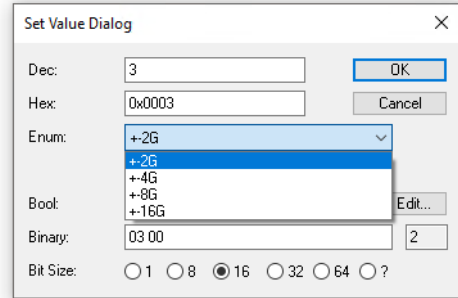
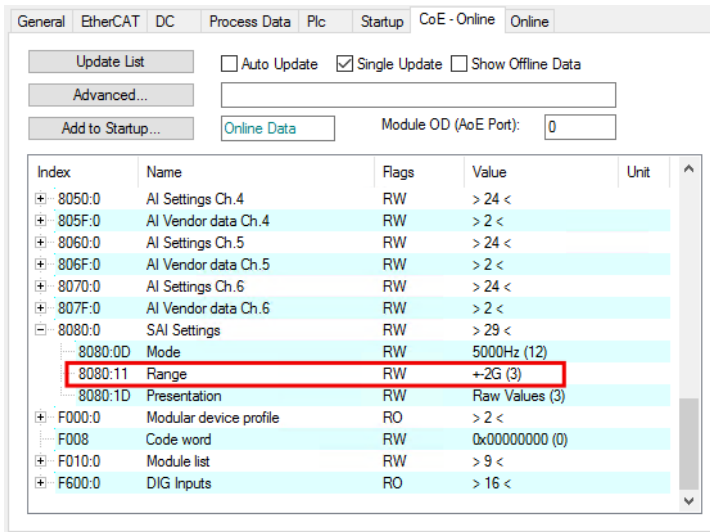

2. Set the parameter 8080:1D<sub>hex</sub> to the value "Raw Values".

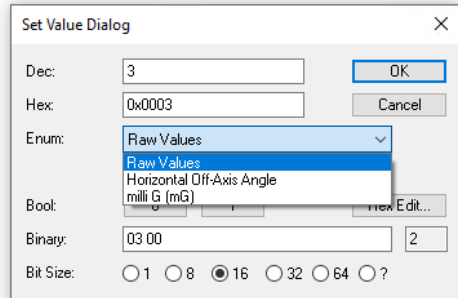
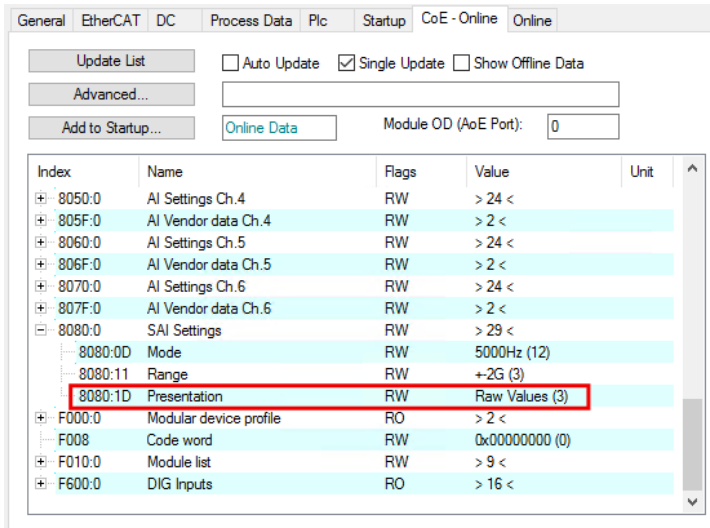

### Evaluation

You can calculate the angles of inclination using the following formulas:

$$\theta = \tan^{-1} \left( \frac{a_x}{\sqrt{a_y^2 + a_z^2}} \right) \times \frac{360^\circ}{2\pi}$$

$\theta$ : angle of inclination around the y-axis  
 $a_x, a_y, a_z$ : measured acceleration values  
 $\tan^{-1}$ : arc tangent

$$\psi = \tan^{-1} \left( \frac{a_y}{\sqrt{a_x^2 + a_z^2}} \right) \times \frac{360^\circ}{2\pi}$$

$\psi$ : angle of inclination around the x-axis  
 $a_x, a_y, a_z$ : measured acceleration values  
 $\tan^{-1}$ : arc tangent

The chapter "Example" [▶ 130] shows an example for the implementation of these formulas in TwinCAT.

- In the program code, make sure that the denominator never becomes zero.



- Use a software filter for smoothing the calculated angles of inclination. See chapter: [Smoothing of measured values](#) [▶ 131].

### 5.6.2.1 Example

This chapter shows an example for calculating an angle of inclination in a PLC program.

Requirement: the inclination measurement was configured as described in chapter [Calculation in the controller](#) [► 128].

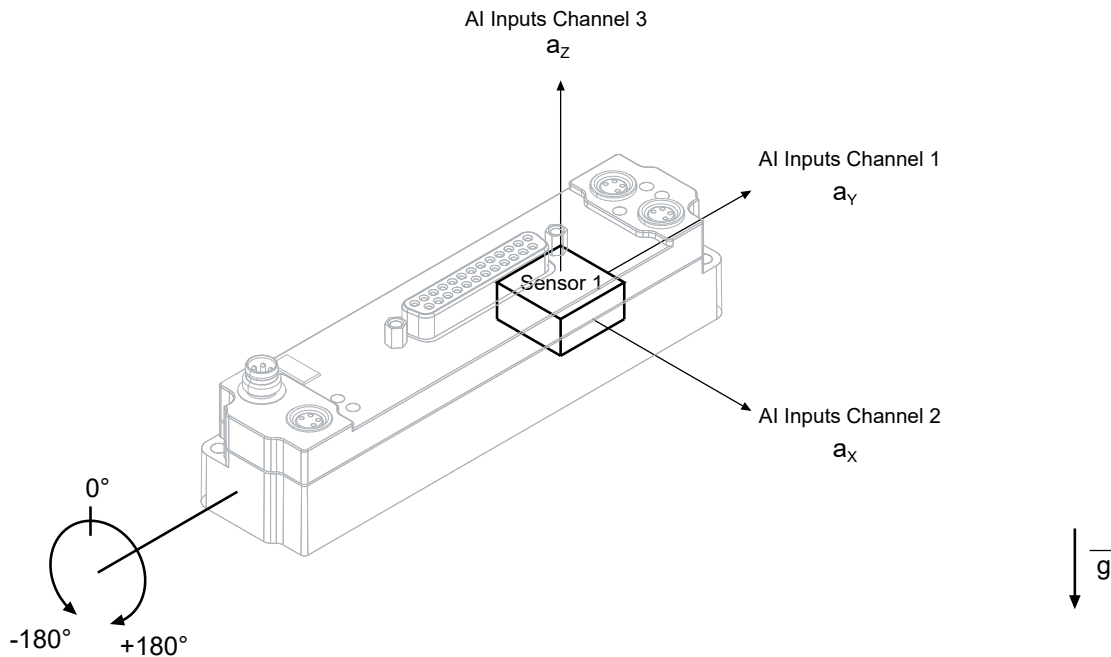

#### Variable links in TwinCAT

- "AI Inputs Channel 1" > "Value" is linked to  $a_y$
- "AI Inputs Channel 2" > "Value" is linked to  $a_x$
- "AI Inputs Channel 3" > "Value" is linked to  $a_z$

#### Program code

```
PROGRAM MAIN
VAR
  ax AT %I*   : INT;
  ay AT %I*   : INT;
  az AT %I*   : INT;
  Inclination : LREAL;
END_VAR

IF (ay <> 0 OR az <> 0) THEN (* Prevent division by 0 *)
  Inclination := ATAN( ax / SQRT( ay * ay + az * az ) ) * 360 / ( 2 * 3.14 );
END_IF

(* Compensate zero crossing of az *)
IF az > 0 THEN
  Inclination := 180 - Inclination;
END_IF

(* Insert offset to shift the measuring range from -90...270 to -180...+180 *)
IF Inclination > 180 THEN
  Inclination := Inclination - 360;
END_IF
```

### 5.6.3 Smoothing of measured values

The measured inclination angles are subject to significant noise.

Use software filters for smoothing the measured values. In the simplest case, use a sliding average filter.

#### Example 1

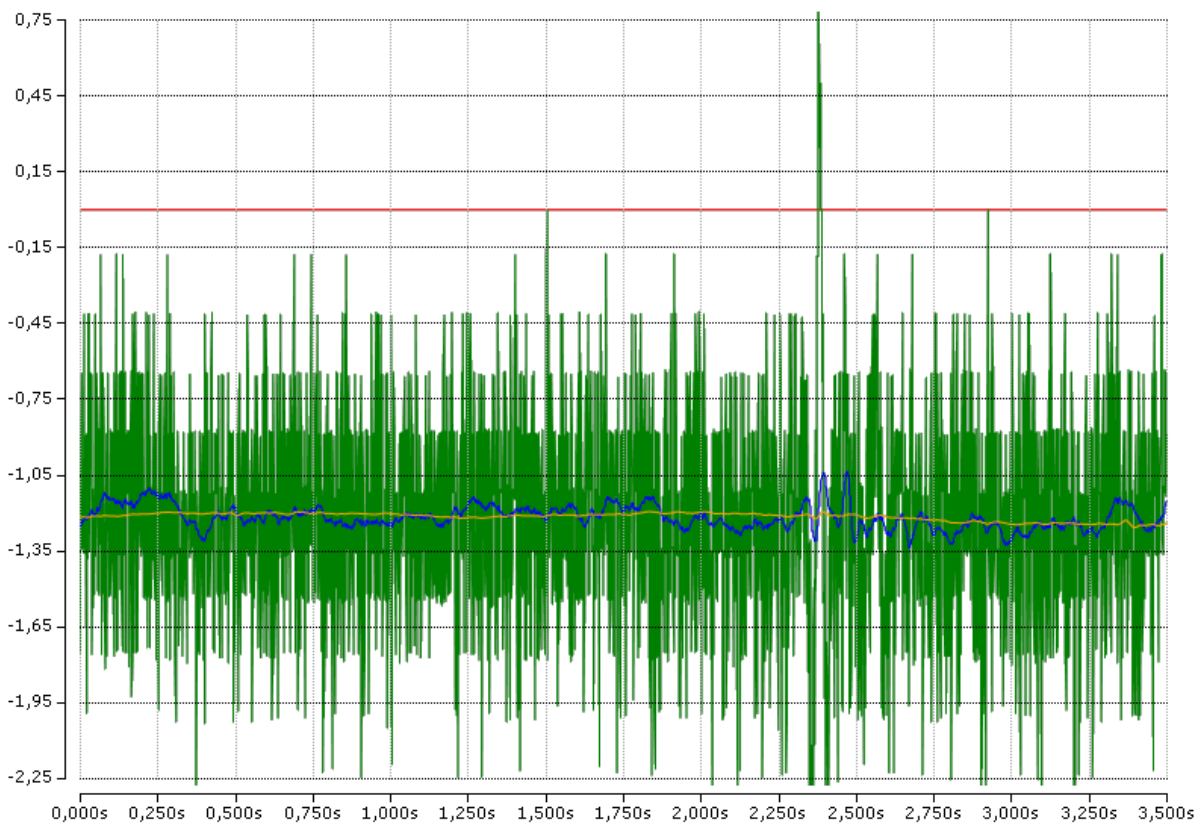

Line color	Meaning
red	Reference angle of inclination measured with an incremental encoder.
green	Measured angle of inclination, unfiltered.
blue	Measured angle of inclination filtered with a fast filter.
yellow	Measured angle of inclination filtered with a sliding average value over 1000 values.

**Example 2**

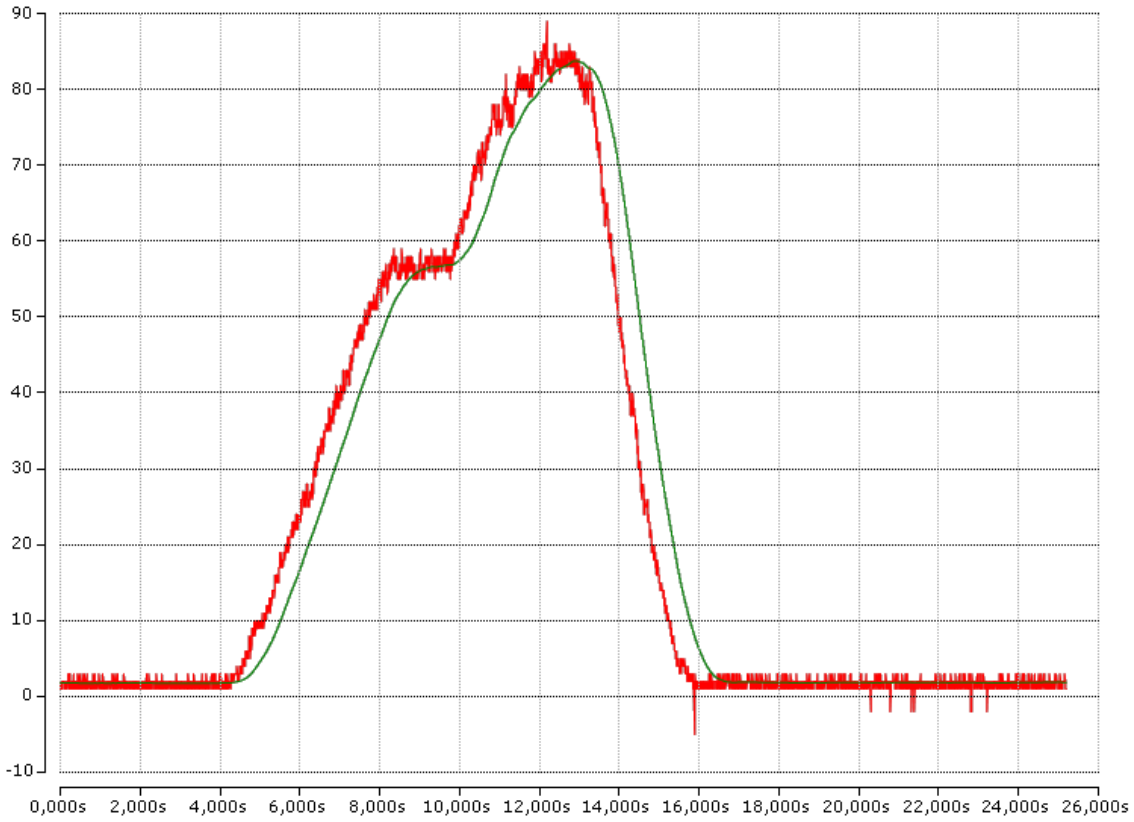

Red: measured angle of inclination, unfiltered.

Green: measured angle of inclination filtered with a sliding average value.

## 5.7 Restore the delivery state

You can restore the delivery state of the backup objects as follows:

1. Ensure that TwinCAT is running in Config mode.
2. In CoE object 1011:0 "Restore default parameters" select parameter 1011:01 "Subindex 001".

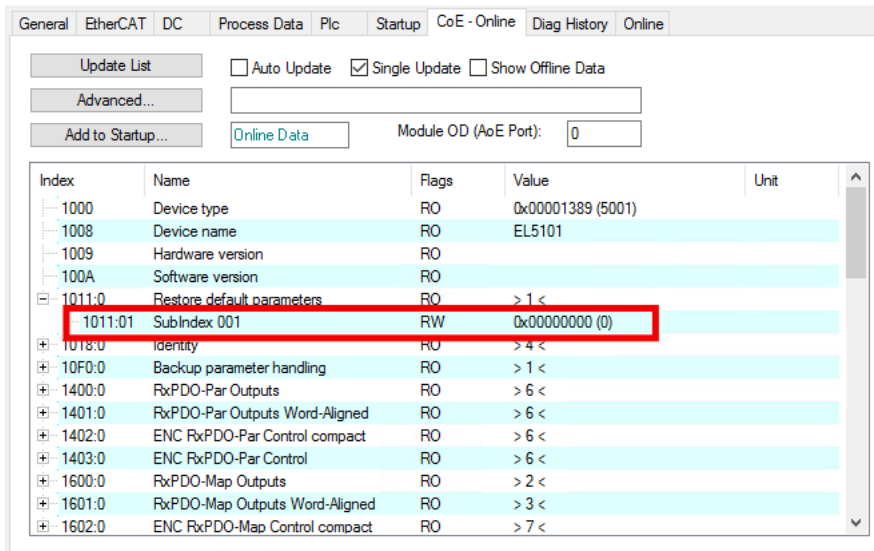

3. Double-click on "Subindex 001".  
⇒ The "Set Value Dialog" dialog box opens.
4. Enter the value 1684107116 in the "Dec" field.  
Alternatively: enter the value 0x64616F6C in the "Hex" field.

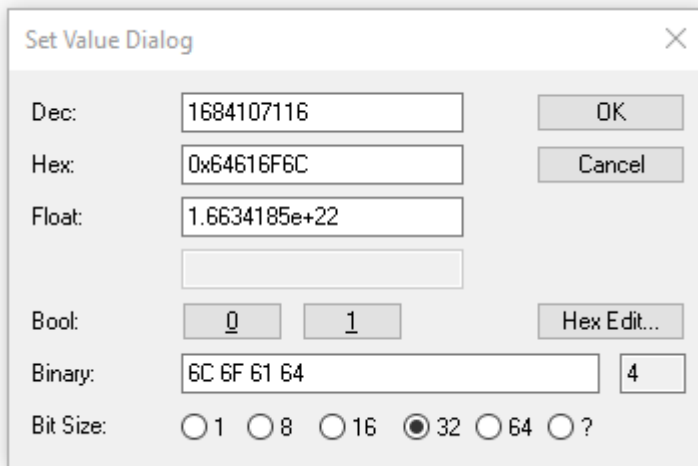

5. Confirm with "OK".  
⇒ All backup objects are reset to the delivery state.

### **i** Alternative restore value

With some older modules the backup objects can be changed with an alternative restore value:

Decimal value: 1819238756

Hexadecimal value: 0x6C6F6164

An incorrect entry for the restore value has no effect.

## 5.8 Decommissioning

**⚠ WARNING****Risk of electric shock!**

Bring the bus system into a safe, de-energized state before starting disassembly of the devices!

## 6 Diagnosis

### 6.1 Antivalent sensors (EP1819-0005)

The EP1819-0005 has a diagnostic function for antivalent sensors.

The diagnostic function is disabled in the factory setting.

#### Enable

1. Connect antivalent sensors as shown in the connection example in chapter [M8 sockets, 4-pin \[► 89\]](#).
2. Set the Predefined PDO Assignment "16DI with diagnostic".  
See chapter [Adapt process image \(EP1819-0005, EP1839-0042\) \[► 112\]](#).  
⇒ The process data object "DIP Diagnosis" is enabled.
3. Set the CoE parameters 81n0:03 "Enable antivalent input diagnostic" of the corresponding connections to TRUE. See the following table.

Connection	CoE parameter "Enable antivalent input diagnostic"
X01	8100:03
X02	8110:03
X03	8120:03
X04	8130:03
X05	8140:03
X06	8150:03
X07	8160:03
X08	8170:03

#### Evaluation

In error-free operation, the outputs of an antivalent sensor provide inverted signals. If both outputs of the sensor deliver the same value, this is interpreted as an error. An error is signaled in two ways:

- Status LEDs. See chapter [M8 sockets, 4-pin \[► 89\]](#), section "Status LEDs".
- Status bits in the process data. See chapter [Process image - EP1819-0005 \[► 58\]](#).

## 6.2 Wire break detection (EP1839-0042)

The wire break detection is deactivated in the factory setting. You can activate it for each channel individually with the CoE parameters  $80x00:01_{hex}$  "Enable wire break detection".

The screenshot shows the 'CoE - Online' tab in the software. A table lists parameters for various channels. The parameter '8000:01 Enable wirebreak detection' is highlighted in red. To the right, a 'Set Value Dialog' window is open, showing the 'Bool' field set to '1'.

Index	Name	Flags	Value	Unit
7120:0	DO Output Ch.03	RO	> 1 <	
7130:0	DO Output Ch.04	RO	> 1 <	
7140:0	DO Output Ch.05	RO	> 1 <	
7150:0	DO Output Ch.06	RO	> 1 <	
7160:0	DO Output Ch.07	RO	> 1 <	
7170:0	DO Output Ch.08	RO	> 1 <	
8000:0	DI Settings Ch.01	RW	> 18 <	
8000:01	Enable wirebreak detection	RW	FALSE	
8000:11	Filter time	RW	Filter off (0)	
8000:12	Signal extension time	RW	Extension off (0)	
8010:0	DI Settings Ch.02	RW	> 18 <	
8020:0	DI Settings Ch.03	RW	> 18 <	
8030:0	DI Settings Ch.04	RW	> 18 <	
8040:0	DI Settings Ch.05	RW	> 18 <	

The assignment of the CoE parameters to the connection designations can be found in the chapter [Assignment of the connections](#) [[▶ 118](#)].

### Wire break message

When wire break detection is enabled, a wire break is reported in two ways:

- In the process data object [DI Diagnosis](#) [[▶ 66](#)] the corresponding bit is set to TRUE.
- The status LED of the affected channel lights up red. See chapter [EP1839-0042](#) [[▶ 97](#)].

### Functioning

The wire break detection monitors the input current of the respective digital input. If the input current falls below the threshold value of approx. 47  $\mu$ A, this is interpreted as a wire break.

The box can detect a wire break even in the "off" state because the threshold value is so low that it is exceeded by the leakage current of usual sensors.

### Troubleshooting

Ideally, a wire break is only reported if there is actually a wire break in the sensor cable. However, there are other reasons for reporting wire break:

- The sensor cable is short-circuited to GND.
- No sensor is connected.
- The sensor is a mechanical switch.  
See section "Mechanical switches".

### Mechanical switches

A mechanical switch has no significant leakage current when it is open. If you use a mechanical switch as a sensor, a wire break is reported when the switch is open.

You have two options to solve this problem:

- Deactivate the wire break detection for the affected channel.
- Connect a resistance in parallel with the mechanical switch.  
The resistance must be dimensioned so that the current through the resistance exceeds the wire break detection threshold.



# 7 CoE parameters

## 7.1 EP1816-0008 - Object Overview

### **i** EtherCAT XML Device Description

The presentation matches that of the EtherCAT XML Device Description.

Recommendation: download the latest XML file from <https://www.beckhoff.com/> and install it according to the installation instructions.

Index	Name	Flags	Default value
1000 [▶ 139]	Device type	RO	0x01181389 (18355081 <sub>dec</sub> )
1008 [▶ 139]	Device name	RO	EP1816-0008
1009 [▶ 139]	Hardware version	RO	00
100A [▶ 140]	Software version	RO	01
1011	<b>Subindex</b> Restore default parameters	RO	0x01 (1 <sub>dec</sub> )
[▶ 139]:0	1011:01 SubIndex 001	RW	0x00000000 (0 <sub>dec</sub> )
1018	<b>Subindex</b> Identity	RO	0x04 (4 <sub>dec</sub> )
[▶ 140]:0	1018:01 Vendor ID	RO	0x00000002 (2 <sub>dec</sub> )
	1018:02 Product code	RO	0x07184052 (119029842 <sub>dec</sub> )
	1018:03 Revision	RO	0x00100008 (1048584 <sub>dec</sub> )
	1018:04 Serial number	RO	0x00000000 (0 <sub>dec</sub> )
10F0	<b>Subindex</b> Backup parameter handling	RO	0x01 (1 <sub>dec</sub> )
[▶ 140]:0	10F0:01 Checksum	RO	0x00000000 (0 <sub>dec</sub> )
1A00	<b>Subindex</b> DO TxPDO-Map Inputs Ch.1	RO	0x0B (11 <sub>dec</sub> )
[▶ 140]:0	1A00:01 SubIndex 001	RO	0x6000:01, 1
	1A00:02 SubIndex 002	RO	0x6000:02, 1
	1A00:03 SubIndex 003	RO	0x6000:03, 1
	1A00:04 SubIndex 004	RO	0x6000:04, 1
	1A00:05 SubIndex 005	RO	0x6000:05, 1
	1A00:06 SubIndex 006	RO	0x6000:06, 1
	1A00:07 SubIndex 007	RO	0x6000:07, 1
	1A00:08 SubIndex 008	RO	0x6000:08, 1
	1A00:09 SubIndex 009	RO	0x0000:00, 5
	1A00:0A SubIndex 010	RO	0x1C32:20, 1
	1A00:0B SubIndex 011	RO	0x0000:00, 2
1A01	<b>Subindex</b> DO TxPDO-Map Inputs Ch.2	RO	0x0B (11 <sub>dec</sub> )
[▶ 141]:0	1A01:01 SubIndex 001	RO	0x6010:01, 1
	1A01:02 SubIndex 002	RO	0x6010:02, 1
	1A01:03 SubIndex 003	RO	0x6010:03, 1
	1A01:04 SubIndex 004	RO	0x6010:04, 1
	1A01:05 SubIndex 005	RO	0x6010:05, 1
	1A01:06 SubIndex 006	RO	0x6010:06, 1
	1A01:07 SubIndex 007	RO	0x6010:07, 1
	1A01:08 SubIndex 008	RO	0x6010:08, 1
	1A01:09 SubIndex 009	RO	0x0000:00, 5
	1A01:0A SubIndex 010	RO	0x1C32:20, 1
	1A01:0B SubIndex 011	RO	0x0000:00, 2
1C00	<b>Subindex</b> Sync manager type	RO	0x04 (4 <sub>dec</sub> )
[▶ 141]:0	1C00:01 SubIndex 001	RO	0x01 (1 <sub>dec</sub> )
	1C00:02 SubIndex 002	RO	0x02 (2 <sub>dec</sub> )
	1C00:03 SubIndex 003	RO	0x03 (3 <sub>dec</sub> )
	1C00:04 SubIndex 004	RO	0x04 (4 <sub>dec</sub> )
1C12	<b>Subindex</b> RxPDO assign	RO	0x00 (0 <sub>dec</sub> )
[▶ 141]:0			

Index	Name	Flags	Default value
1C13	<b>Subindex</b> TxPDO assign	RO	0x02 (2 <sub>dec</sub> )
▶ 141]:0	1C13:01 SubIndex 001	RO	0x1A00 (6656 <sub>dec</sub> )
	1C13:02 SubIndex 002	RO	0x1A01 (6657 <sub>dec</sub> )
1C33	<b>Subindex</b> SM input parameter	RO	0x20 (32 <sub>dec</sub> )
▶ 142]:0	1C33:01 Sync mode	RW	0x0022 (34 <sub>dec</sub> )
	1C33:02 Cycle time	RW	0x000186A0 (100000 <sub>dec</sub> )
	1C33:03 Shift time	RO	0x00000000 (0 <sub>dec</sub> )
	1C33:04 Sync modes supported	RO	0xC007 (49159 <sub>dec</sub> )
	1C33:05 Minimum cycle time	RO	0x000124F8 (75000 <sub>dec</sub> )
	1C33:06 Calc and copy time	RO	0x00000000 (0 <sub>dec</sub> )
	1C33:08 Command	RW	0x0000 (0 <sub>dec</sub> )
	1C33:09 Delay time	RO	0x00000000 (0 <sub>dec</sub> )
	1C33:0B SM event missed counter	RO	0x0000 (0 <sub>dec</sub> )
	1C33:0C Cycle exceeded counter	RO	0x0000 (0 <sub>dec</sub> )
	1C33:0D Shift too short counter	RO	0x0000 (0 <sub>dec</sub> )
	1C33:20 Sync error	RO	0x00 (0 <sub>dec</sub> )
	6000	<b>Subindex</b> DO Inputs Ch.1	RO
▶ 143]:0	6000:01 Input 1	RO	0x00 (0 <sub>dec</sub> )
	6000:02 Input 2	RO	0x00 (0 <sub>dec</sub> )
	6000:03 Input 3	RO	0x00 (0 <sub>dec</sub> )
	6000:04 Input 4	RO	0x00 (0 <sub>dec</sub> )
	6000:05 Input 5	RO	0x00 (0 <sub>dec</sub> )
	6000:06 Input 6	RO	0x00 (0 <sub>dec</sub> )
	6000:07 Input 7	RO	0x00 (0 <sub>dec</sub> )
	6000:08 Input 8	RO	0x00 (0 <sub>dec</sub> )
	6000:0E Sync Error	RO	0x00 (0 <sub>dec</sub> )
6010	<b>Subindex</b> DO Inputs Ch.2	RO	0x0E (14 <sub>dec</sub> )
▶ 143]:0	6010:01 Input 1	RO	0x00 (0 <sub>dec</sub> )
	6010:02 Input 2	RO	0x00 (0 <sub>dec</sub> )
	6010:03 Input 3	RO	0x00 (0 <sub>dec</sub> )
	6010:04 Input 4	RO	0x00 (0 <sub>dec</sub> )
	6010:05 Input 5	RO	0x00 (0 <sub>dec</sub> )
	6010:06 Input 6	RO	0x00 (0 <sub>dec</sub> )
	6010:07 Input 7	RO	0x00 (0 <sub>dec</sub> )
	6010:08 Input 8	RO	0x00 (0 <sub>dec</sub> )
	6010:0E Sync Error	RO	0x00 (0 <sub>dec</sub> )
F000	<b>Subindex</b> Modular device profile	RO	0x02 (2 <sub>dec</sub> )
▶ 143]:0	F000:01 Module index distance	RO	0x0010 (16 <sub>dec</sub> )
	F000:02 Maximum number of modules	RO	0x0002 (2 <sub>dec</sub> )
F008 ▶ 143]	Code word	RW	0x00000000 (0 <sub>dec</sub> )
F010	<b>Subindex</b> Module list	RW	0x02 (2 <sub>dec</sub> )
▶ 143]:0	F010:01 SubIndex 001	RW	0x00000118 (280 <sub>dec</sub> )
	F010:02 SubIndex 002	RW	0x00000118 (280 <sub>dec</sub> )

## Legend

Flags:

RO ("Read Only"): this object can only be read.

RW ("Read/Write"): this object can be read and written.

## 7.2 EP1816-0008 - Object description and parameterization

### Parameterization

You can parameterize the box via the "CoE - Online" tab in TwinCAT.

### EtherCAT XML Device Description

The presentation matches that of the EtherCAT XML Device Description.

Recommendation: download the latest XML file from <https://www.beckhoff.com/> and install it according to the installation instructions.

### Introduction

The CoE overview contains objects for different intended applications:

- [Objects required for parameterization \[► 139\]](#) during commissioning
- [Objects intended for regular operation \[► 139\]](#), e.g. through ADS access
- [Objects for indicating internal settings \[► 139\]](#) (may be fixed)

The following section first describes the objects required for normal operation, followed by a complete overview of missing objects.

### Objects to be parameterized during commissioning

Objects to be parameterized during commissioning

#### Index 1011 Restore default parameters

Index	Name	Meaning	Data type	Flags	Default
1011:0	Restore default parameters	Restore default settings	UINT8	RO	0x01 (1 <sub>dec</sub> )
1011:01	SubIndex 001	If this object is set to <b>0x64616F6C</b> in the Set Value dialog, all backup objects are reset to their delivery state.	UINT32	RW	0x00000000 (0 <sub>dec</sub> )

### Objects for regular operation

The EP1816 has no such objects.

### Additional objects

#### Standard objects (0x1000-0x1FFF)

The standard objects have the same meaning for all EtherCAT slaves.

#### Index 1000 Device type

Index	Name	Meaning	Data type	Flags	Default
1000:0	Device type	Device type of the EtherCAT slave: the Lo-Word contains the used CoE profile (5001). The Hi-Word contains the module profile according to the modular device profile.	UINT32	RO	0x01181389 (18355081 <sub>dec</sub> )

#### Index 1008 Device name

Index	Name	Meaning	Data type	Flags	Default
1008:0	Device name	Device name of the EtherCAT slave	string	RO	EP1816-0008

#### Index 1009 Hardware version

Index	Name	Meaning	Data type	Flags	Default
1009:0	Hardware version	Hardware version of the EtherCAT slave	string	RO	00

**Index 100A Software version**

Index	Name	Meaning	Data type	Flags	Default
100A:0	Software version	Firmware version of the EtherCAT slave	string	RO	01

**Index 1018 Identity**

Index	Name	Meaning	Data type	Flags	Default
1018:0	Identity	Information for identifying the slave	UINT8	RO	0x04 (4 <sub>dec</sub> )
1018:01	Vendor ID	Vendor ID of the EtherCAT slave	UINT32	RO	0x00000002 (2 <sub>dec</sub> )
1018:02	Product code	Product code of the EtherCAT slave	UINT32	RO	0x07184052 (119029842 <sub>dec</sub> )
1018:03	Revision	Revision number of the EtherCAT slave; the Low Word (bit 0-15) indicates the special terminal number, the High Word (bit 16-31) refers to the device description	UINT32	RO	0x00100008 (1048584 <sub>dec</sub> )
1018:04	Serial number	Serial number of the EtherCAT slave; the Low Byte (bit 0-7) of the Low Word contains the year of production, the High Byte (bit 8-15) of the Low Word contains the week of production, the High Word (bit 16-31) is 0	UINT32	RO	0x00000000 (0 <sub>dec</sub> )

**Index 10F0 Backup parameter handling**

Index	Name	Meaning	Data type	Flags	Default
10F0:0	Backup parameter handling	Information for standardized loading and saving of backup entries	UINT8	RO	0x01 (1 <sub>dec</sub> )
10F0:01	Checksum	Checksum across all backup entries of the EtherCAT slave	UINT32	RO	0x00000000 (0 <sub>dec</sub> )

**Index 1A00 DO TxPDO-Map Inputs Ch.1**

Index	Name	Meaning	Data type	Flags	Default
1A00:0	DO TxPDO-Map Inputs Ch.1	PDO Mapping TxPDO 1	UINT8	RO	0x0B (11 <sub>dec</sub> )
1A00:01	SubIndex 001	1. PDO Mapping entry (object 0x6000 (DO Inputs Ch.1), entry 0x01 (Input 1))	UINT32	RO	0x6000:01, 1
1A00:02	SubIndex 002	2. PDO Mapping entry (object 0x6000 (DO Inputs Ch.1), entry 0x02 (Input 2))	UINT32	RO	0x6000:02, 1
1A00:03	SubIndex 003	3. PDO Mapping entry (object 0x6000 (DO Inputs Ch.1), entry 0x03 (Input 3))	UINT32	RO	0x6000:03, 1
1A00:04	SubIndex 004	4. PDO Mapping entry (object 0x6000 (DO Inputs Ch.1), entry 0x04 (Input 4))	UINT32	RO	0x6000:04, 1
1A00:05	SubIndex 005	5. PDO Mapping entry (object 0x6000 (DO Inputs Ch.1), entry 0x05 (Input 5))	UINT32	RO	0x6000:05, 1
1A00:06	SubIndex 006	6. PDO Mapping entry (object 0x6000 (DO Inputs Ch.1), entry 0x06 (Input 6))	UINT32	RO	0x6000:06, 1
1A00:07	SubIndex 007	7. PDO Mapping entry (object 0x6000 (DO Inputs Ch.1), entry 0x07 (Input 7))	UINT32	RO	0x6000:07, 1
1A00:08	SubIndex 008	8. PDO Mapping entry (object 0x6000 (DO Inputs Ch.1), entry 0x08 (Input 8))	UINT32	RO	0x6000:08, 1
1A00:09	SubIndex 009	9. PDO Mapping entry (5 bits align)	UINT32	RO	0x0000:00, 5
1A00:0A	SubIndex 010	10. PDO Mapping entry (object 0x1C32, entry 0x20)	UINT32	RO	0x1C32:20, 1
1A00:0B	SubIndex 011	11. PDO Mapping entry (2 bits align)	UINT32	RO	0x0000:00, 2

**Index 1A01 DO TxPDO-Map Inputs Ch.2**

Index	Name	Meaning	Data type	Flags	Default
1A01:0	DO TxPDO-Map Inputs Ch.2	PDO Mapping TxPDO 2	UINT8	RO	0x0B (11 <sub>dec</sub> )
1A01:01	SubIndex 001	1. PDO Mapping entry (object 0x6010 (DO Inputs Ch.2), entry 0x01 (Input 1))	UINT32	RO	0x6010:01, 1
1A01:02	SubIndex 002	2. PDO Mapping entry (object 0x6010 (DO Inputs Ch.2), entry 0x02 (Input 2))	UINT32	RO	0x6010:02, 1
1A01:03	SubIndex 003	3. PDO Mapping entry (object 0x6010 (DO Inputs Ch.2), entry 0x03 (Input 3))	UINT32	RO	0x6010:03, 1
1A01:04	SubIndex 004	4. PDO Mapping entry (object 0x6010 (DO Inputs Ch.2), entry 0x04 (Input 4))	UINT32	RO	0x6010:04, 1
1A01:05	SubIndex 005	5. PDO Mapping entry (object 0x6010 (DO Inputs Ch.2), entry 0x05 (Input 5))	UINT32	RO	0x6010:05, 1
1A01:06	SubIndex 006	6. PDO Mapping entry (object 0x6010 (DO Inputs Ch.2), entry 0x06 (Input 6))	UINT32	RO	0x6010:06, 1
1A01:07	SubIndex 007	7. PDO Mapping entry (object 0x6010 (DO Inputs Ch.2), entry 0x07 (Input 7))	UINT32	RO	0x6010:07, 1
1A01:08	SubIndex 008	8. PDO Mapping entry (object 0x6010 (DO Inputs Ch.2), entry 0x08 (Input 8))	UINT32	RO	0x6010:08, 1
1A01:09	SubIndex 009	9. PDO Mapping entry (5 bits align)	UINT32	RO	0x0000:00, 5
1A01:0A	SubIndex 010	10. PDO Mapping entry (object 0x1C32, entry 0x20)	UINT32	RO	0x1C32:20, 1
1A01:0B	SubIndex 011	11. PDO Mapping entry (2 bits align)	UINT32	RO	0x0000:00, 2

**Index 1C00 Sync manager type**

Index	Name	Meaning	Data type	Flags	Default
1C00:0	Sync manager type	Using the Sync Managers	UINT8	RO	0x04 (4 <sub>dec</sub> )
1C00:01	SubIndex 001	Sync-Manager Type Channel 1: Mailbox Write	UINT8	RO	0x01 (1 <sub>dec</sub> )
1C00:02	SubIndex 002	Sync-Manager Type Channel 2: Mailbox Read	UINT8	RO	0x02 (2 <sub>dec</sub> )
1C00:03	SubIndex 003	Sync-Manager Type Channel 3: Process Data Write (Outputs)	UINT8	RO	0x03 (3 <sub>dec</sub> )
1C00:04	SubIndex 004	Sync-Manager Type Channel 4: Process Data Read (Inputs)	UINT8	RO	0x04 (4 <sub>dec</sub> )

**Index 1C12 RxPDO assign**

Index	Name	Meaning	Data type	Flags	Default
1C12:0	RxPDO assign	PDO Assign Outputs	UINT8	RO	0x00 (0 <sub>dec</sub> )

**Index 1C13 TxPDO assign**

Index	Name	Meaning	Data type	Flags	Default
1C13:0	TxPDO assign	PDO Assign Inputs	UINT8	RO	0x02 (2 <sub>dec</sub> )
1C13:01	Subindex 001	1. allocated TxPDO (contains the index of the associated TxPDO mapping object)	UINT16	RO	0x1A00 (6656 <sub>dec</sub> )
1C13:02	Subindex 002	2. allocated TxPDO (contains the index of the associated TxPDO mapping object)	UINT16	RO	0x1A01 (6657 <sub>dec</sub> )

## Index 1C33 SM input parameter

Index	Name	Meaning	Data type	Flags	Default
1C33:0	SM input parameter	Synchronization parameters for the inputs	UINT8	RO	0x20 (32 <sub>dec</sub> )
1C33:01	Sync mode	Current synchronization mode: <ul style="list-style-type: none"> <li>0: Free Run</li> <li>1: Synchron with SM 3 event (no outputs available)</li> <li>2: DC - Synchron with SYNC0 Event</li> <li>3: DC - Synchron with SYNC1 Event</li> <li>34: Synchron with SM 2 event (outputs available)</li> </ul>	UINT16	RW	0x0022 (34 <sub>dec</sub> )
1C33:02	Cycle time	Cycle time (in ns): <ul style="list-style-type: none"> <li>Synchronous with SM 2 Event: cycle time of the master</li> <li>DC-Mode: SYNC0/SYNC1 Cycle Time</li> </ul>	UINT32	RW	0x000186A0 (100000 <sub>dec</sub> )
1C33:03	Shift time	Time between SYNC0 event and reading of the inputs (in ns, DC mode only)	UINT32	RO	0x00000000 (0 <sub>dec</sub> )
1C33:04	Sync modes supported	Supported synchronization modes: <ul style="list-style-type: none"> <li>Bit 0: Free Run is supported</li> <li>Bit 1: Synchron with SM 2 Event is supported (outputs available)</li> <li>Bit 1: Synchron with SM 3 Event is supported (no outputs available)</li> <li>Bit 2-3 = 01: DC-Mode is supported</li> <li>Bit 4-5 = 01: Input Shift through local event (outputs available)</li> <li>Bit 4-5 = 10: Input Shift with SYNC1 event (no outputs available)</li> <li>Bit 14 = 1: dynamic times (measurement through writing of 1C33:08 [▶ 142])</li> </ul>	UINT16	RO	0xC007 (49159 <sub>dec</sub> )
1C33:05	Minimum cycle time	Minimum cycle time (in ns)	UINT32	RO	0x000124F8 (75000 <sub>dec</sub> )
1C33:06	Calc and copy time	Time between reading of the inputs and availability of the inputs for the master (in ns, only DC mode)	UINT32	RO	0x00000000 (0 <sub>dec</sub> )
1C33:08	Command	<ul style="list-style-type: none"> <li>0: Measurement of the local cycle time is stopped</li> <li>1: Measurement of the local cycle time is started</li> </ul> <p>The entries 1C33:03 [▶ 142], 1C33:06 [▶ 142], 1C33:07, 1C33:09 [▶ 142] are updated with the maximum measured values. For a subsequent measurement the measured values are reset</p>	UINT16	RW	0x0000 (0 <sub>dec</sub> )
1C33:09	Delay time	Time between SYNC1 event and reading of the inputs (in ns, only DC mode)	UINT32	RO	0x00000000 (0 <sub>dec</sub> )
1C33:0B	SM event missed counter	Number of missed SM events in OPERATIONAL (DC mode only)	UINT16	RO	0x0000 (0 <sub>dec</sub> )
1C33:0C	Cycle exceeded counter	Number of occasions the cycle time was exceeded in OPERATIONAL (cycle was not completed in time or the next cycle began too early)	UINT16	RO	0x0000 (0 <sub>dec</sub> )
1C33:0D	Shift too short counter	Number of occasions that the interval between SYNC0 and SYNC1 event was too short (DC mode only)	UINT16	RO	0x0000 (0 <sub>dec</sub> )
1C33:20	Sync error	The synchronization was not correct in the last cycle (outputs were output too late; DC mode only)	boolean	RO	0x00 (0 <sub>dec</sub> )

## Profile-specific objects (0x6000-0xFFFF)

The profile-specific objects have the same meaning for all EtherCAT slaves that support the profile 5001.

**Index 6000 DO Inputs Ch.1**

Index	Name	Meaning	Data type	Flags	Default
6000:0	DO Inputs Ch.1		UINT8	RO	0x0E (14 <sub>dec</sub> )
6000:01	Input 1		boolean	RO	0x00 (0 <sub>dec</sub> )
6000:02	Input 2		boolean	RO	0x00 (0 <sub>dec</sub> )
6000:03	Input 3		boolean	RO	0x00 (0 <sub>dec</sub> )
6000:04	Input 4		boolean	RO	0x00 (0 <sub>dec</sub> )
6000:05	Input 5		boolean	RO	0x00 (0 <sub>dec</sub> )
6000:06	Input 6		boolean	RO	0x00 (0 <sub>dec</sub> )
6000:07	Input 7		boolean	RO	0x00 (0 <sub>dec</sub> )
6000:08	Input 8		boolean	RO	0x00 (0 <sub>dec</sub> )
6000:0E	Sync Error		boolean	RO	0x00 (0 <sub>dec</sub> )

**Index 6010 DO Inputs Ch.2**

Index	Name	Meaning	Data type	Flags	Default
6010:0	DO Inputs Ch.2		UINT8	RO	0x0E (14 <sub>dec</sub> )
6010:01	Input 1		boolean	RO	0x00 (0 <sub>dec</sub> )
6010:02	Input 2		boolean	RO	0x00 (0 <sub>dec</sub> )
6010:03	Input 3		boolean	RO	0x00 (0 <sub>dec</sub> )
6010:04	Input 4		boolean	RO	0x00 (0 <sub>dec</sub> )
6010:05	Input 5		boolean	RO	0x00 (0 <sub>dec</sub> )
6010:06	Input 6		boolean	RO	0x00 (0 <sub>dec</sub> )
6010:07	Input 7		boolean	RO	0x00 (0 <sub>dec</sub> )
6010:08	Input 8		boolean	RO	0x00 (0 <sub>dec</sub> )
6010:0E	Sync Error		boolean	RO	0x00 (0 <sub>dec</sub> )

**Index F000 Modular device profile**

Index	Name	Meaning	Data type	Flags	Default
F000:0	Modular device profile	General information for the modular device profile	UINT8	RO	0x02 (2 <sub>dec</sub> )
F000:01	Module index distance	Index distance of the objects of the individual channels	UINT16	RO	0x0010 (16 <sub>dec</sub> )
F000:02	Maximum number of modules	Number of channels	UINT16	RO	0x0002 (2 <sub>dec</sub> )

**Index F008 Code word**

Index	Name	Meaning	Data type	Flags	Default
F008:0	Code word		UINT32	RW	0x00000000 (0 <sub>dec</sub> )

**Index F010 Module list**

Index	Name	Meaning	Data type	Flags	Default
F010:0	Module list		UINT8	RW	0x02 (2 <sub>dec</sub> )
F010:01	SubIndex 001		UINT32	RW	0x00000118 (280 <sub>dec</sub> )
F010:02	SubIndex 002		UINT32	RW	0x00000118 (280 <sub>dec</sub> )

## 7.3 EP1816-3008 - Object overview

### **i** EtherCAT XML Device Description

The presentation matches that of the EtherCAT XML Device Description.

Recommendation: download the latest XML file from <https://www.beckhoff.com/> and install it according to the installation instructions.

Index (hex)	Name	Flags	Default value
1000 [▶ 152]	Device type	RO	0x00001389 (5001 <sub>dec</sub> )
1008 [▶ 152]	Device name	RO	EP1816-3008
1009 [▶ 152]	Hardware version	RO	
100A [▶ 152]	Software version	RO	03
1011:0 [▶ 152]	<b>Subindex</b> Restore default parameters	RO	0x01 (1 <sub>dec</sub> )
	0x1011:01 SubIndex 001	RW	0x00000000 (0 <sub>dec</sub> )
1018:0 [▶ 152]	<b>Subindex</b> Identity	RO	0x04 (4 <sub>dec</sub> )
	0x1018:01 Vendor ID	RO	0x00000002 (2 <sub>dec</sub> )
	0x1018:02 Product code	RO	0x05E44052 (98844754 <sub>dec</sub> )
	01018:03 Revision	RO	0x00000000 (0 <sub>dec</sub> )
	0x1018:04 Serial number	RO	0x00000000 (0 <sub>dec</sub> )
10F0:0 [▶ 152]	<b>Subindex</b> Backup parameter handling	RO	0x01 (1 <sub>dec</sub> )
	0x10F0:01 Checksum	RO	0x00000000 (0 <sub>dec</sub> )
1A00:0 [▶ 153]	<b>Subindex</b> DIG TxPDO-Map Inputs Ch.1	RO	0x09 (9 <sub>dec</sub> )
	0x1A00:01 SubIndex 001	RO	0x6000:01, 1
	0x1A00:02 SubIndex 002	RO	0x6000:02, 1
	0x1A00:03 SubIndex 003	RO	0x6000:03, 1
	0x1A00:04 SubIndex 004	RO	0x6000:04, 1
	0x1A00:05 SubIndex 005	RO	0x6000:05, 1
	0x1A00:06 SubIndex 006	RO	0x6000:06, 1
	0x1A00:07 SubIndex 007	RO	0x6000:07, 1
	0x1A00:08 SubIndex 008	RO	0x6000:08, 1
	0x1A00:09 SubIndex 009	RO	0x0000:00, 8
1A01:0 [▶ 153]	<b>Subindex</b> DIG TxPDO-Map Inputs Ch.2	RO	0x09 (9 <sub>dec</sub> )
	0x1A01:01 SubIndex 001	RO	0x6010:01, 1
	0x1A01:02 SubIndex 002	RO	0x6010:02, 1
	0x1A01:03 SubIndex 003	RO	0x6010:03, 1
	0x1A01:04 SubIndex 004	RO	0x6010:04, 1
	0x1A01:05 SubIndex 005	RO	0x6010:05, 1
	0x1A01:06 SubIndex 006	RO	0x6010:06, 1
	0x1A01:07 SubIndex 007	RO	0x6010:07, 1
	0x1A01:08 SubIndex 008	RO	0x6010:08, 1
	0x1A01:09 SubIndex 009	RO	0x0000:00, 8
1A02:0 [▶ 153]	<b>Subindex</b> AI TxPDO-Map Inputs Ch.1	RO	0x05 (5 <sub>dec</sub> )
	0x1A02:01 SubIndex 001	RO	0x0000:00, 6
	0x1A02:02 SubIndex 002	RO	0x6020:07, 1
	0x1A02:03 SubIndex 003	RO	0x0000:00, 8
	0x1A02:04 SubIndex 004	RO	0x6020:10, 1
	0x1A02:05 SubIndex 005	RO	0x6020:11, 16
1A03:0 [▶ 154]	<b>Subindex</b> AI TxPDO-Map Inputs Ch.2	RO	0x05 (5 <sub>dec</sub> )
	0x1A03:01 SubIndex 001	RO	0x0000:00, 6
	0x1A03:02 SubIndex 002	RO	0x6030:07, 1
	0x1A03:03 SubIndex 003	RO	0x0000:00, 8
	0x1A03:04 SubIndex 004	RO	0x6030:10, 1
	0x1A03:05 SubIndex 005	RO	0x6030:11, 16



Index (hex)	Name	Flags	Default value
<u>1A04:0</u>	<b>Subindex</b> AI TxPDO-Map Inputs Ch.3	RO	0x05 (5 <sub>dec</sub> )
<a href="#">▶ 154]</a>	0x1A04:01 SubIndex 001	RO	0x0000:00, 6
	0x1A04:02 SubIndex 002	RO	0x6040:07, 1
	0x1A04:03 SubIndex 003	RO	0x0000:00, 8
	0x1A04:04 SubIndex 004	RO	0x6040:10, 1
	0x1A04:05 SubIndex 005	RO	0x6040:11, 16
<u>1A05:0</u>	<b>Subindex</b> AI TxPDO-Map Inputs Ch.4	RO	0x05 (5 <sub>dec</sub> )
<a href="#">▶ 154]</a>	0x1A05:01 SubIndex 001	RO	0x0000:00, 6
	0x1A05:02 SubIndex 002	RO	0x6050:07, 1
	0x1A05:03 SubIndex 003	RO	0x0000:00, 8
	0x1A05:04 SubIndex 004	RO	0x6050:10, 1
	0x1A05:05 SubIndex 005	RO	0x6050:11, 16
<u>1A06:0</u>	<b>Subindex</b> AI TxPDO-Map Inputs Ch.5	RO	0x05 (5 <sub>dec</sub> )
<a href="#">▶ 154]</a>	0x1A06:01 SubIndex 001	RO	0x0000:00, 6
	0x1A06:02 SubIndex 002	RO	0x6060:07, 1
	0x1A06:03 SubIndex 003	RO	0x0000:00, 8
	0x1A06:04 SubIndex 004	RO	0x6060:10, 1
	0x1A06:05 SubIndex 005	RO	0x6060:11, 16
<u>1A07:0</u>	<b>Subindex</b> AI TxPDO-Map Inputs Ch.6	RO	0x05 (5 <sub>dec</sub> )
<a href="#">▶ 155]</a>	0x1A07:01 SubIndex 001	RO	0x0000:00, 6
	0x1A07:02 SubIndex 002	RO	0x6070:07, 1
	0x1A07:03 SubIndex 003	RO	0x0000:00, 8
	0x1A07:04 SubIndex 004	RO	0x6070:10, 1
	0x1A07:05 SubIndex 005	RO	0x6070:11, 16
<u>1A08:0</u>	<b>Subindex</b> DIG TxPDO-Map Inputs Device	RO	0x04 (4 <sub>dec</sub> )
<a href="#">▶ 155]</a>	0x1A08:01 SubIndex 001	RO	0xF600:01, 1
	0x1A08:02 SubIndex 002	RO	0xF600:02, 1
	0x1A08:03 SubIndex 003	RO	0x0000:00, 13
	0x1A08:04 SubIndex 004	RO	0xF600:10, 1
<u>1C00:0</u>	<b>Subindex</b> Sync manager type	RO	0x04 (4 <sub>dec</sub> )
<a href="#">▶ 155]</a>	0x1C00:01 SubIndex 001	RO	0x01 (1 <sub>dec</sub> )
	0x1C00:02 SubIndex 002	RO	0x02 (2 <sub>dec</sub> )
	0x1C00:03 SubIndex 003	RO	0x03 (3 <sub>dec</sub> )
	0x1C00:04 SubIndex 004	RO	0x04 (4 <sub>dec</sub> )
<u>1C12:0</u>	<b>Subindex</b> RxPDO assign	RO	0x00 (0 <sub>dec</sub> )
<a href="#">▶ 155]</a>			
<u>1C13:0</u>	<b>Subindex</b> TxPDO assign	RO	0x09 (9 <sub>dec</sub> )
<a href="#">▶ 155]</a>	0x1C13:01 SubIndex 001	RO	0x1A00 (6656 <sub>dec</sub> )
	0x1C13:02 SubIndex 002	RO	0x1A01 (6657 <sub>dec</sub> )
	0x1C13:03 SubIndex 003	RO	0x1A02 (6658 <sub>dec</sub> )
	0x1C13:04 SubIndex 004	RO	0x1A03 (6659 <sub>dec</sub> )
	0x1C13:05 SubIndex 005	RO	0x1A04 (6660 <sub>dec</sub> )
	0x1C13:06 SubIndex 006	RO	0x1A05 (6661 <sub>dec</sub> )
	0x1C13:07 SubIndex 007	RO	0x1A06 (6662 <sub>dec</sub> )
	0x1C13:08 SubIndex 008	RO	0x1A07 (6663 <sub>dec</sub> )
	0x1C13:09 SubIndex 009	RO	0x1A08 (6664 <sub>dec</sub> )
<u>1C33:0</u>	<b>Subindex</b> SM input parameter	RO	0x20 (32 <sub>dec</sub> )
<a href="#">▶ 156]</a>	0x1C33:01 Sync mode	RW	0x0022 (34 <sub>dec</sub> )
	0x1C33:02 Cycle time	RW	0x003D0900 (4000000 <sub>dec</sub> )
	0x1C33:03 Shift time	RO	0x00000000 (0 <sub>dec</sub> )
	0x1C33:04 Sync modes supported	RO	0xC007 (49159 <sub>dec</sub> )
	0x1C33:05 Minimum cycle time	RO	0x00030D40 (200000 <sub>dec</sub> )
	0x1C33:06 Calc and copy time	RO	0x00000000 (0 <sub>dec</sub> )
	0x1C33:07 Minimum delay time	RO	0x00000000 (0 <sub>dec</sub> )
	0x1C33:08 Command	RW	0x0000 (0 <sub>dec</sub> )
	0x1C33:09 Maximum delay time	RO	0x00000000 (0 <sub>dec</sub> )
	0x1C33:0B SM event missed counter	RO	0x0000 (0 <sub>dec</sub> )
	0x1C33:0C Cycle exceeded counter	RO	0x0000 (0 <sub>dec</sub> )

Index (hex)	Name	Flags	Default value	
	0x1C33:0D	Shift too short counter	RO	0x0000 (0 <sub>dec</sub> )
	0x1C33:20	Sync error	RO	0x00 (0 <sub>dec</sub> )
6000:0 ▶ 157]	<b>Subindex</b>	DIG Inputs Ch.1	RO	0x08 (8 <sub>dec</sub> )
	0x6000:01	Input 1	RO	0x00 (0 <sub>dec</sub> )
	0x6000:02	Input 2	RO	0x00 (0 <sub>dec</sub> )
	0x6000:03	Input 3	RO	0x00 (0 <sub>dec</sub> )
	0x6000:04	Input 4	RO	0x00 (0 <sub>dec</sub> )
	0x6000:05	Input 5	RO	0x00 (0 <sub>dec</sub> )
	0x6000:06	Input 6	RO	0x00 (0 <sub>dec</sub> )
	0x6000:07	Input 7	RO	0x00 (0 <sub>dec</sub> )
	0x6000:08	Input 8	RO	0x00 (0 <sub>dec</sub> )
6010:0 ▶ 157]	<b>Subindex</b>	DIG Inputs Ch.2	RO	0x08 (8 <sub>dec</sub> )
	0x6010:01	Input 1	RO	0x00 (0 <sub>dec</sub> )
	0x6010:02	Input 2	RO	0x00 (0 <sub>dec</sub> )
	0x6010:03	Input 3	RO	0x00 (0 <sub>dec</sub> )
	0x6010:04	Input 4	RO	0x00 (0 <sub>dec</sub> )
	0x6010:05	Input 5	RO	0x00 (0 <sub>dec</sub> )
	0x6010:06	Input 6	RO	0x00 (0 <sub>dec</sub> )
	0x6010:07	Input 7	RO	0x00 (0 <sub>dec</sub> )
	0x6010:08	Input 8	RO	0x00 (0 <sub>dec</sub> )
6020:0 ▶ 157]	<b>Subindex</b>	AI Inputs Ch.1	RO	0x11 (17 <sub>dec</sub> )
	0x6020:07	Error	RO	0x00 (0 <sub>dec</sub> )
	0x6020:10	TxPDO Toggle	RO	0x00 (0 <sub>dec</sub> )
	0x6020:11	Value	RO	0x0000 (0 <sub>dec</sub> )
6030:0 ▶ 157]	<b>Subindex</b>	AI Inputs Ch.2	RO	0x11 (17 <sub>dec</sub> )
	0x6030:07	Error	RO	0x00 (0 <sub>dec</sub> )
	0x6030:10	TxPDO Toggle	RO	0x00 (0 <sub>dec</sub> )
	0x6030:11	Value	RO	0x0000 (0 <sub>dec</sub> )
6040:0 ▶ 157]	<b>Subindex</b>	AI Inputs Ch.3	RO	0x11 (17 <sub>dec</sub> )
	0x6040:07	Error	RO	0x00 (0 <sub>dec</sub> )
	0x6040:10	TxPDO Toggle	RO	0x00 (0 <sub>dec</sub> )
	0x6040:11	Value	RO	0x0000 (0 <sub>dec</sub> )
6050:0 ▶ 157]	<b>Subindex</b>	AI Inputs Ch.4	RO	0x11 (17 <sub>dec</sub> )
	0x6050:07	Error	RO	0x00 (0 <sub>dec</sub> )
	0x6050:10	TxPDO Toggle	RO	0x00 (0 <sub>dec</sub> )
	0x6050:11	Value	RO	0x0000 (0 <sub>dec</sub> )
6060:0 ▶ 158]	<b>Subindex</b>	AI Inputs Ch.5	RO	0x11 (17 <sub>dec</sub> )
	0x6060:07	Error	RO	0x00 (0 <sub>dec</sub> )
	0x6060:10	TxPDO Toggle	RO	0x00 (0 <sub>dec</sub> )
	0x6060:11	Value	RO	0x0000 (0 <sub>dec</sub> )
6070:0 ▶ 158]	<b>Subindex</b>	AI Inputs Ch.6	RO	0x11 (17 <sub>dec</sub> )
	0x6070:07	Error	RO	0x00 (0 <sub>dec</sub> )
	0x6070:10	TxPDO Toggle	RO	0x00 (0 <sub>dec</sub> )
	0x6070:11	Value	RO	0x0000 (0 <sub>dec</sub> )
8020:0 ▶ 149]	<b>Subindex</b>	AI Settings Ch.1	RW	0x18 (24 <sub>dec</sub> )
	0x8020:01	Enable user scale	RW	0x00 (0 <sub>dec</sub> )
	0x8020:0A	Enable user calibration	RW	0x00 (0 <sub>dec</sub> )
	0x8020:0B	Enable vendor calibration	RW	0x00 (0 <sub>dec</sub> )
	0x8020:11	User scale offset	RW	0x0000 (0 <sub>dec</sub> )
	0x8020:12	User scale gain	RW	0x02A00000 (44040192 <sub>dec</sub> )
	0x8020:17	User calibration offset	RW	0x0000 (0 <sub>dec</sub> )
	0x8020:18	User calibration gain	RW	0x0000 (0 <sub>dec</sub> )
802F:0 ▶ 149]	<b>Subindex</b>	AI Vendor data Ch.1	RW	0x02 (2 <sub>dec</sub> )
	0x802F:01	Calibration Offset	RW	0x0000 (0 <sub>dec</sub> )
	0x802F:02	Calibration Gain	RW	0x0000 (0 <sub>dec</sub> )
8030:0 ▶ 149]	<b>Subindex</b>	AI Settings Ch.2	RW	0x18 (24 <sub>dec</sub> )
	0x8030:01	Enable user scale	RW	0x00 (0 <sub>dec</sub> )
	0x8030:0A	Enable user calibration	RW	0x00 (0 <sub>dec</sub> )

Index (hex)	Name	Flags	Default value	
	0x8030:0B	Enable vendor calibration	RW	0x00 (0 <sub>dec</sub> )
	0x8030:11	User scale offset	RW	0x0000 (0 <sub>dec</sub> )
	0x8030:12	User scale gain	RW	0x02A00000 (44040192 <sub>dec</sub> )
	0x8030:17	User calibration offset	RW	0x0000 (0 <sub>dec</sub> )
	0x8030:18	User calibration gain	RW	0x0000 (0 <sub>dec</sub> )
803F:0 ▶ 150]	<b>Subindex</b>	AI Vendor data Ch.2	RW	0x02 (2 <sub>dec</sub> )
	0x803F:01	Calibration Offset	RW	0x0000 (0 <sub>dec</sub> )
	0x803F:02	Calibration Gain	RW	0x0000 (0 <sub>dec</sub> )
8040:0 ▶ 150]	<b>Subindex</b>	AI Settings Ch.3	RW	0x18 (24 <sub>dec</sub> )
	0x8040:01	Enable user scale	RW	0x00 (0 <sub>dec</sub> )
	0x8040:0A	Enable user calibration	RW	0x00 (0 <sub>dec</sub> )
	0x8040:0B	Enable vendor calibration	RW	0x00 (0 <sub>dec</sub> )
	0x8040:11	User scale offset	RW	0x0000 (0 <sub>dec</sub> )
	0x8040:12	User scale gain	RW	0x02A00000 (44040192 <sub>dec</sub> )
	0x8040:17	User calibration offset	RW	0x0000 (0 <sub>dec</sub> )
	0x8040:18	User calibration gain	RW	0x0000 (0 <sub>dec</sub> )
804F:0 ▶ 150]	<b>Subindex</b>	AI Vendor data Ch.3	RW	0x02 (2 <sub>dec</sub> )
	0x804F:01	Calibration Offset	RW	0x0000 (0 <sub>dec</sub> )
	0x804F:02	Calibration Gain	RW	0x0000 (0 <sub>dec</sub> )
8050:0 ▶ 150]	<b>Subindex</b>	AI Settings Ch.4	RW	0x18 (24 <sub>dec</sub> )
	0x8050:01	Enable user scale	RW	0x00 (0 <sub>dec</sub> )
	0x8050:0A	Enable user calibration	RW	0x00 (0 <sub>dec</sub> )
	0x8050:0B	Enable vendor calibration	RW	0x00 (0 <sub>dec</sub> )
	0x8050:11	User scale offset	RW	0x0000 (0 <sub>dec</sub> )
	0x8050:12	User scale gain	RW	0x02A00000 (44040192 <sub>dec</sub> )
	0x8050:17	User calibration offset	RW	0x0000 (0 <sub>dec</sub> )
	0x8050:18	User calibration gain	RW	0x0000 (0 <sub>dec</sub> )
805F:0 ▶ 150]	<b>Subindex</b>	AI Vendor data Ch.4	RW	0x02 (2 <sub>dec</sub> )
	0x805F:01	Calibration Offset	RW	0x0000 (0 <sub>dec</sub> )
	0x805F:02	Calibration Gain	RW	0x0000 (0 <sub>dec</sub> )
8060:0 ▶ 151]	<b>Subindex</b>	AI Settings Ch.5	RW	0x18 (24 <sub>dec</sub> )
	0x8060:01	Enable user scale	RW	0x00 (0 <sub>dec</sub> )
	0x8060:0A	Enable user calibration	RW	0x00 (0 <sub>dec</sub> )
	0x8060:0B	Enable vendor calibration	RW	0x00 (0 <sub>dec</sub> )
	0x8060:11	User scale offset	RW	0x0000 (0 <sub>dec</sub> )
	0x8060:12	User scale gain	RW	0x02A00000 (44040192 <sub>dec</sub> )
	0x8060:17	User calibration offset	RW	0x0000 (0 <sub>dec</sub> )
	0x8060:18	User calibration gain	RW	0x0000 (0 <sub>dec</sub> )
806F:0 ▶ 151]	<b>Subindex</b>	AI Vendor data Ch.5	RW	0x02 (2 <sub>dec</sub> )
	0x806F:01	Calibration Offset	RW	0x0000 (0 <sub>dec</sub> )
	0x806F:02	Calibration Gain	RW	0x0000 (0 <sub>dec</sub> )
8070:0 ▶ 151]	<b>Subindex</b>	AI Settings Ch.6	RW	0x18 (24 <sub>dec</sub> )
	0x8070:01	Enable user scale	RW	0x00 (0 <sub>dec</sub> )
	0x8070:0A	Enable user calibration	RW	0x00 (0 <sub>dec</sub> )
	0x8070:0B	Enable vendor calibration	RW	0x00 (0 <sub>dec</sub> )
	0x8070:11	User scale offset	RW	0x0000 (0 <sub>dec</sub> )
	0x8070:12	User scale gain	RW	0x02A00000 (44040192 <sub>dec</sub> )
	0x8070:17	User calibration offset	RW	0x0000 (0 <sub>dec</sub> )
	0x8070:18	User calibration gain	RW	0x0000 (0 <sub>dec</sub> )
807F:0 ▶ 151]	<b>Subindex</b>	AI Vendor data Ch.6	RW	0x02 (2 <sub>dec</sub> )
	0x807F:01	Calibration Offset	RW	0x0000 (0 <sub>dec</sub> )
	0x807F:02	Calibration Gain	RW	0x0000 (0 <sub>dec</sub> )
8080:0 ▶ 151]	<b>Subindex</b>	SAI Settings	RW	0x11 (17 <sub>dec</sub> )
	0x8080:0D	Mode	RW	0x0000 (0 <sub>dec</sub> )
	0x8080:11	Range	RW	0x0000 (0 <sub>dec</sub> )
F000:0 ▶ 158]	<b>Subindex</b>	Modular device profile	RO	0x02 (2 <sub>dec</sub> )
	0xF000:01	Module index distance	RO	0x0010 (16 <sub>dec</sub> )
	0xF000:02	Maximum number of modules	RO	0x0009 (9 <sub>dec</sub> )

Index (hex)	Name	Flags	Default value
F008 [▶ 158]	Code word	RW	0x00000000 (0 <sub>dec</sub> )
F010:0 [▶ 158]	<b>Subindex</b> Module list	RW	0x09 (9 <sub>dec</sub> )
	0xF010:01 SubIndex 001	RW	0x00000118 (280 <sub>dec</sub> )
	0xF010:02 SubIndex 002	RW	0x00000118 (280 <sub>dec</sub> )
	0xF010:03 SubIndex 003	RW	0x0000012C (300 <sub>dec</sub> )
	0xF010:04 SubIndex 004	RW	0x0000012C (300 <sub>dec</sub> )
	0xF010:05 SubIndex 005	RW	0x0000012C (300 <sub>dec</sub> )
	0xF010:06 SubIndex 006	RW	0x0000012C (300 <sub>dec</sub> )
	0xF010:07 SubIndex 007	RW	0x0000012C (300 <sub>dec</sub> )
	0xF010:08 SubIndex 008	RW	0x0000012C (300 <sub>dec</sub> )
	0xF010:09 SubIndex 009	RW	0x00000168 (360 <sub>dec</sub> )
F600:0 [▶ 158]	<b>Subindex</b> DIG Inputs	RO	0x10 (16 <sub>dec</sub> )
	0xF600:01 Us Undervoltage	RO	0x00 (0 <sub>dec</sub> )
	0xF600:02 Up Undervoltage	RO	0x00 (0 <sub>dec</sub> )
	0xF600:10 TxPDO Toggle	RO	0x00 (0 <sub>dec</sub> )

### Legend

Flags:

RO ("Read Only"): this object can only be read.

RW ("Read/Write"): this object can be read and written.

## 7.4 EP1816-3008 - Object description and parameterization

### ● Parameterization

You can parameterize the box via the "CoE - Online" tab in TwinCAT.

### ● EtherCAT XML Device Description

The presentation matches that of the EtherCAT XML Device Description.

Recommendation: download the latest XML file from <https://www.beckhoff.com/> and install it according to the installation instructions.

### Introduction

The CoE overview contains objects for different intended applications:

- [Objects required for parameterization during \[▶ 149\] commissioning](#)
- [Objects for indicating internal settings \[▶ 152\] \(may be fixed\)](#)
- [Further profile-specific objects \[▶ 157\] indicating inputs, outputs and status information](#)

The following section first describes the objects required for normal operation, followed by a complete overview of missing objects.

### 7.4.1 Objects to be parameterized during commissioning

#### Index 8020 AI Settings Ch.1

Index (hex)	Name	Meaning	Data type	Flags	Default
8020:0	AI Settings Ch.1		UINT8	RO	0x18 (24 <sub>dec</sub> )
8020:01	Enable user scale		BOOLEAN	RW	0x00 (0 <sub>dec</sub> )
8020:0A	Enable user calibration		BOOLEAN	RW	0x00 (0 <sub>dec</sub> )
8020:0B	Enable vendor calibration		BOOLEAN	RW	0x00 (0 <sub>dec</sub> )
8020:11	User scale offset		INT16	RW	0x0000 (0 <sub>dec</sub> )
8020:12	User scale gain		INT32	RW	0x02A00000 (44040192 <sub>dec</sub> )
8020:17	User calibration offset		INT16	RW	0x0000 (0 <sub>dec</sub> )
8020:18	User calibration gain		INT16	RW	0x0000 (0 <sub>dec</sub> )

#### Index 802F AI Vendor data Ch.1

Index (hex)	Name	Meaning	Data type	Flags	Default
802F:0	AI Vendor data Ch.1		UINT8	RO	0x02 (2 <sub>dec</sub> )
802F:01	Calibration Offset		INT16	RW	0x0000 (0 <sub>dec</sub> )
802F:02	Calibration Gain		INT16	RW	0x0000 (0 <sub>dec</sub> )

#### Index 8030 AI Settings Ch.2

Index (hex)	Name	Meaning	Data type	Flags	Default
8030:0	AI Settings Ch.2		UINT8	RO	0x18 (24 <sub>dec</sub> )
8030:01	Enable user scale		BOOLEAN	RW	0x00 (0 <sub>dec</sub> )
8030:0A	Enable user calibration		BOOLEAN	RW	0x00 (0 <sub>dec</sub> )
8030:0B	Enable vendor calibration		BOOLEAN	RW	0x00 (0 <sub>dec</sub> )
8030:11	User scale offset		INT16	RW	0x0000 (0 <sub>dec</sub> )
8030:12	User scale gain		INT32	RW	0x02A00000 (44040192 <sub>dec</sub> )
8030:17	User calibration offset		INT16	RW	0x0000 (0 <sub>dec</sub> )
8030:18	User calibration gain		INT16	RW	0x0000 (0 <sub>dec</sub> )

**Index 803F AI Vendor data Ch.2**

Index (hex)	Name	Meaning	Data type	Flags	Default
803F:0	AI Vendor data Ch.2		UINT8	RO	0x02 (2 <sub>dec</sub> )
803F:01	Calibration Offset		INT16	RW	0x0000 (0 <sub>dec</sub> )
803F:02	Calibration Gain		INT16	RW	0x0000 (0 <sub>dec</sub> )

**Index 8040 AI Settings Ch.3**

Index (hex)	Name	Meaning	Data type	Flags	Default
8040:0	AI Settings Ch.3		UINT8	RO	0x18 (24 <sub>dec</sub> )
8040:01	Enable user scale		BOOLEAN	RW	0x00 (0 <sub>dec</sub> )
8040:0A	Enable user calibration		BOOLEAN	RW	0x00 (0 <sub>dec</sub> )
8040:0B	Enable vendor calibration		BOOLEAN	RW	0x00 (0 <sub>dec</sub> )
8040:11	User scale offset		INT16	RW	0x0000 (0 <sub>dec</sub> )
8040:12	User scale gain		INT32	RW	0x02A00000 (44040192 <sub>dec</sub> )
8040:17	User calibration offset		INT16	RW	0x0000 (0 <sub>dec</sub> )
8040:18	User calibration gain		INT16	RW	0x0000 (0 <sub>dec</sub> )

**Index 804F AI Vendor data Ch.3**

Index (hex)	Name	Meaning	Data type	Flags	Default
804F:0	AI Vendor data Ch.3		UINT8	RO	0x02 (2 <sub>dec</sub> )
804F:01	Calibration Offset		INT16	RW	0x0000 (0 <sub>dec</sub> )
804F:02	Calibration Gain		INT16	RW	0x0000 (0 <sub>dec</sub> )

**Index 8050 AI Settings Ch.4**

Index (hex)	Name	Meaning	Data type	Flags	Default
8050:0	AI Settings Ch.4		UINT8	RO	0x18 (24 <sub>dec</sub> )
8050:01	Enable user scale		BOOLEAN	RW	0x00 (0 <sub>dec</sub> )
8050:0A	Enable user calibration		BOOLEAN	RW	0x00 (0 <sub>dec</sub> )
8050:0B	Enable vendor calibration		BOOLEAN	RW	0x00 (0 <sub>dec</sub> )
8050:11	User scale offset		INT16	RW	0x0000 (0 <sub>dec</sub> )
8050:12	User scale gain		INT32	RW	0x02A00000 (44040192 <sub>dec</sub> )
8050:17	User calibration offset		INT16	RW	0x0000 (0 <sub>dec</sub> )
8050:18	User calibration gain		INT16	RW	0x0000 (0 <sub>dec</sub> )

**Index 805F AI Vendor data Ch.4**

Index (hex)	Name	Meaning	Data type	Flags	Default
805F:0	AI Vendor data Ch.4		UINT8	RO	0x02 (2 <sub>dec</sub> )
805F:01	Calibration Offset		INT16	RW	0x0000 (0 <sub>dec</sub> )
805F:02	Calibration Gain		INT16	RW	0x0000 (0 <sub>dec</sub> )

**Index 8060 AI Settings Ch.5**

Index (hex)	Name	Meaning	Data type	Flags	Default
8060:0	AI Settings Ch.5		UINT8	RO	0x18 (24 <sub>dec</sub> )
8060:01	Enable user scale		BOOLEAN	RW	0x00 (0 <sub>dec</sub> )
8060:0A	Enable user calibration		BOOLEAN	RW	0x00 (0 <sub>dec</sub> )
8060:0B	Enable vendor calibration		BOOLEAN	RW	0x00 (0 <sub>dec</sub> )
8060:11	User scale offset		INT16	RW	0x0000 (0 <sub>dec</sub> )
8060:12	User scale gain		INT32	RW	0x02A00000 (44040192 <sub>dec</sub> )
8060:17	User calibration offset		INT16	RW	0x0000 (0 <sub>dec</sub> )
8060:18	User calibration gain		INT16	RW	0x0000 (0 <sub>dec</sub> )

**Index 806F AI Vendor data Ch.5**

Index (hex)	Name	Meaning	Data type	Flags	Default
806F:0	AI Vendor data Ch.5		UINT8	RO	0x02 (2 <sub>dec</sub> )
806F:01	Calibration Offset		INT16	RW	0x0000 (0 <sub>dec</sub> )
806F:02	Calibration Gain		INT16	RW	0x0000 (0 <sub>dec</sub> )

**Index 8070 AI Settings Ch.6**

Index (hex)	Name	Meaning	Data type	Flags	Default
8070:0	AI Settings Ch.6		UINT8	RO	0x18 (24 <sub>dec</sub> )
8070:01	Enable user scale		BOOLEAN	RW	0x00 (0 <sub>dec</sub> )
8070:0A	Enable user calibration		BOOLEAN	RW	0x00 (0 <sub>dec</sub> )
8070:0B	Enable vendor calibration		BOOLEAN	RW	0x00 (0 <sub>dec</sub> )
8070:11	User scale offset		INT16	RW	0x0000 (0 <sub>dec</sub> )
8070:12	User scale gain		INT32	RW	0x02A00000 (44040192 <sub>dec</sub> )
8070:17	User calibration offset		INT16	RW	0x0000 (0 <sub>dec</sub> )
8070:18	User calibration gain		INT16	RW	0x0000 (0 <sub>dec</sub> )

**Index 807F AI Vendor data Ch.6**

Index (hex)	Name	Meaning	Data type	Flags	Default
807F:0	AI Vendor data Ch.6		UINT8	RO	0x02 (2 <sub>dec</sub> )
807F:01	Calibration Offset		INT16	RW	0x0000 (0 <sub>dec</sub> )
807F:02	Calibration Gain		INT16	RW	0x0000 (0 <sub>dec</sub> )

**Index 8080 SAI Settings**

Index (hex)	Name	Meaning	Data type	Flags	Default	
8080:0	SAI Settings		UINT8	RO	0x11 (17 <sub>dec</sub> )	
8080:0D	Mode	permitted values:	UINT16	RW	0x0000 (0 <sub>dec</sub> )	
		4				1 Hz
		5				10 Hz
		6				25 Hz
		7				50 Hz
		8				100 Hz
		9				200 Hz
		10				400 Hz
		11				1600 Hz
		12				5000 Hz
8080:11	Range	permitted values:	UINT16	RW	0x0000 (0 <sub>dec</sub> )	
		3				+/- 2G
		4				+/- 4G
		5				+/- 8G
		6	+/-16G			

## 7.4.2 Standard objects (0x1000-0x1FFF)

The standard objects have the same meaning for all EtherCAT slaves.

### Index 1000 Device type

Index (hex)	Name	Meaning	Data type	Flags	Default
1000:0	Device type	Device type of the EtherCAT slave: The Lo-Word contains the CoE profile used (5001). The Hi-Word contains the module profile according to the modular device profile.	UINT32	RO	0x00001389 (5001 <sub>dec</sub> )

### Index 1008 Device name

Index (hex)	Name	Meaning	Data type	Flags	Default
1008:0	Device name	Device name of the EtherCAT slave	STRING	RO	EP1816-3008

### Index 1009 Hardware version

Index (hex)	Name	Meaning	Data type	Flags	Default
1009:0	Hardware version	Hardware version of the EtherCAT slave	STRING	RO	

### Index 100A Software version

Index (hex)	Name	Meaning	Data type	Flags	Default
100A:0	Software version	Firmware version of the EtherCAT slave	STRING	RO	03

### Index 1011 Restore default parameters

Index (hex)	Name	Meaning	Data type	Flags	Default
1011:0	Restore default parameters		UINT8	RO	0x01 (1 <sub>dec</sub> )
1011:01	SubIndex 001		UINT32	RW	0x00000000 (0 <sub>dec</sub> )

### Index 1018 Identity

Index (hex)	Name	Meaning	Data type	Flags	Default
1018:0	Identity	Information for identifying the slave	UINT8	RO	0x04 (4 <sub>dec</sub> )
1018:01	Vendor ID	Vendor ID of the EtherCAT slave	UINT32	RO	0x00000002 (2 <sub>dec</sub> )
1018:02	Product code	Product code of the EtherCAT slave	UINT32	RO	0x05E44052 (98844754 <sub>dec</sub> )
1018:03	Revision	Revision number of the EtherCAT slave; the low word (bit 0-15) indicates the special terminal number, the high word (bit 16-31) refers to the device description	UINT32	RO	0x00000000 (0 <sub>dec</sub> )
1018:04	Serial number	Serial number of the EtherCAT slave; the low byte (bit 0-7) of the low word contains the year of production, the high byte (bit 8-15) of the low word contains the week of production, the high word (bit 16-31) is 0	UINT32	RO	0x00000000 (0 <sub>dec</sub> )

### Index 10F0 Backup parameter handling

Index (hex)	Name	Meaning	Data type	Flags	Default
10F0:0	Backup parameter handling		UINT8	RO	0x01 (1 <sub>dec</sub> )
10F0:01	Checksum		UINT32	RO	0x00000000 (0 <sub>dec</sub> )



**Index 1A00 DIG TxPDO-Map Inputs Ch.1**

Index (hex)	Name	Meaning	Data type	Flags	Default
1A00:0	DIG TxPDO-Map Inputs Ch.1	PDO Mapping TxPDO 1	UINT8	RO	0x09 (9 <sub>dec</sub> )
1A00:01	SubIndex 001	1. PDO Mapping entry (object 0x6000 (DIG Inputs Ch.1), entry 0x01 (Input 1))	UINT32	RO	0x6000:01, 1
1A00:02	SubIndex 002	2. PDO Mapping entry (object 0x6000 (DIG Inputs Ch.1), entry 0x02 (Input 2))	UINT32	RO	0x6000:02, 1
1A00:03	SubIndex 003	3. PDO Mapping entry (object 0x6000 (DIG Inputs Ch.1), entry 0x03 (Input 3))	UINT32	RO	0x6000:03, 1
1A00:04	SubIndex 004	4. PDO Mapping entry (object 0x6000 (DIG Inputs Ch.1), entry 0x04 (Input 4))	UINT32	RO	0x6000:04, 1
1A00:05	SubIndex 005	5. PDO Mapping entry (object 0x6000 (DIG Inputs Ch.1), entry 0x05 (Input 5))	UINT32	RO	0x6000:05, 1
1A00:06	SubIndex 006	6. PDO Mapping entry (object 0x6000 (DIG Inputs Ch.1), entry 0x06 (Input 6))	UINT32	RO	0x6000:06, 1
1A00:07	SubIndex 007	7. PDO Mapping entry (object 0x6000 (DIG Inputs Ch.1), entry 0x07 (Input 7))	UINT32	RO	0x6000:07, 1
1A00:08	SubIndex 008	8. PDO Mapping entry (object 0x6000 (DIG Inputs Ch.1), entry 0x08 (Input 8))	UINT32	RO	0x6000:08, 1
1A00:09	SubIndex 009	9. PDO Mapping entry (5 bits align)	UINT32	RO	0x0000:00, 8

**Index 1A01 DIG TxPDO-Map Inputs Ch.2**

Index (hex)	Name	Meaning	Data type	Flags	Default
1A01:0	DIG TxPDO-Map Inputs Ch.2	PDO Mapping TxPDO 2	UINT8	RO	0x09 (9 <sub>dec</sub> )
1A01:01	SubIndex 001	1. PDO Mapping entry (object 0x6010 (DIG Inputs Ch.2), entry 0x01 (Input 1))	UINT32	RO	0x6010:01, 1
1A01:02	SubIndex 002	2. PDO Mapping entry (object 0x6010 (DIG Inputs Ch.2), entry 0x02 (Input 2))	UINT32	RO	0x6010:02, 1
1A01:03	SubIndex 003	3. PDO Mapping entry (object 0x6010 (DIG Inputs Ch.2), entry 0x03 (Input 3))	UINT32	RO	0x6010:03, 1
1A01:04	SubIndex 004	4. PDO Mapping entry (object 0x6010 (DIG Inputs Ch.2), entry 0x04 (Input 4))	UINT32	RO	0x6010:04, 1
1A01:05	SubIndex 005	5. PDO Mapping entry (object 0x6010 (DIG Inputs Ch.2), entry 0x05 (Input 5))	UINT32	RO	0x6010:05, 1
1A01:06	SubIndex 006	6. PDO Mapping entry (object 0x6010 (DIG Inputs Ch.2), entry 0x06 (Input 6))	UINT32	RO	0x6010:06, 1
1A01:07	SubIndex 007	7. PDO Mapping entry (object 0x6010 (DIG Inputs Ch.2), entry 0x07 (Input 7))	UINT32	RO	0x6010:07, 1
1A01:08	SubIndex 008	8. PDO Mapping entry (object 0x6010 (DIG Inputs Ch.2), entry 0x08 (Input 8))	UINT32	RO	0x6010:08, 1
1A01:09	SubIndex 009	9. PDO Mapping entry (5 bits align)	UINT32	RO	0x0000:00, 8

**Index 1A02 AI TxPDO-Map Inputs Ch.1**

Index (hex)	Name	Meaning	Data type	Flags	Default
1A02:0	AI TxPDO-Map Inputs Ch.1	PDO Mapping TxPDO 3	UINT8	RO	0x05 (5 <sub>dec</sub> )
1A02:01	SubIndex 001	1. PDO Mapping entry (13 bits align)	UINT32	RO	0x0000:00, 6
1A02:02	SubIndex 002	2. PDO Mapping entry (object 0x1C33 (SM input parameter), entry 0x20 (Sync error))	UINT32	RO	0x6020:07, 1
1A02:03	SubIndex 003	3. PDO Mapping entry (1 bits align)	UINT32	RO	0x0000:00, 8
1A02:04	SubIndex 004	4. PDO Mapping entry (object 0x6020 (AI Inputs Ch.1), entry 0x10 (TxPDO Toggle))	UINT32	RO	0x6020:10, 1
1A02:05	SubIndex 005	5. PDO Mapping entry (object 0x6020 (AI Inputs Ch.1), entry 0x11 (Value))	UINT32	RO	0x6020:11, 16

**Index 1A03 AI TxPDO-Map Inputs Ch.2**

Index (hex)	Name	Meaning	Data type	Flags	Default
1A03:0	AI TxPDO-Map Inputs Ch.2	PDO Mapping TxPDO 4	UINT8	RO	0x05 (5 <sub>dec</sub> )
1A03:01	SubIndex 001	1. PDO Mapping entry (13 bits align)	UINT32	RO	0x0000:00, 6
1A03:02	SubIndex 002	2. PDO Mapping entry (object 0x1C33 (SM input parameter), entry 0x20 (Sync error))	UINT32	RO	0x6030:07, 1
1A03:03	SubIndex 003	3. PDO Mapping entry (1 bits align)	UINT32	RO	0x0000:00, 8
1A03:04	SubIndex 004	4. PDO Mapping entry (object 0x6030 (AI Inputs Ch.2), entry 0x10 (TxPDO Toggle))	UINT32	RO	0x6030:10, 1
1A03:05	SubIndex 005	5. PDO Mapping entry (object 0x6030 (AI Inputs Ch.2), entry 0x11 (Value))	UINT32	RO	0x6030:11, 16

**Index 1A04 AI TxPDO-Map Inputs Ch.3**

Index (hex)	Name	Meaning	Data type	Flags	Default
1A04:0	AI TxPDO-Map Inputs Ch.3	PDO Mapping TxPDO 5	UINT8	RO	0x05 (5 <sub>dec</sub> )
1A04:01	SubIndex 001	1. PDO Mapping entry (13 bits align)	UINT32	RO	0x0000:00, 6
1A04:02	SubIndex 002	2. PDO Mapping entry (object 0x1C33 (SM input parameter), entry 0x20 (Sync error))	UINT32	RO	0x6040:07, 1
1A04:03	SubIndex 003	3. PDO Mapping entry (1 bits align)	UINT32	RO	0x0000:00, 8
1A04:04	SubIndex 004	4. PDO Mapping entry (object 0x6040 (AI Inputs Ch.3), entry 0x10 (TxPDO Toggle))	UINT32	RO	0x6040:10, 1
1A04:05	SubIndex 005	5. PDO Mapping entry (object 0x6040 (AI Inputs Ch.3), entry 0x11 (Value))	UINT32	RO	0x6040:11, 16

**Index 1A05 AI TxPDO-Map Inputs Ch.4**

Index (hex)	Name	Meaning	Data type	Flags	Default
1A05:0	AI TxPDO-Map Inputs Ch.4	PDO Mapping TxPDO 6	UINT8	RO	0x05 (5 <sub>dec</sub> )
1A05:01	SubIndex 001	1. PDO Mapping entry (13 bits align)	UINT32	RO	0x0000:00, 6
1A05:02	SubIndex 002	2. PDO Mapping entry (object 0x1C33 (SM input parameter), entry 0x20 (Sync error))	UINT32	RO	0x6050:07, 1
1A05:03	SubIndex 003	3. PDO Mapping entry (1 bits align)	UINT32	RO	0x0000:00, 8
1A05:04	SubIndex 004	4. PDO Mapping entry (object 0x6050 (AI Inputs Ch.4), entry 0x10 (TxPDO Toggle))	UINT32	RO	0x6050:10, 1
1A05:05	SubIndex 005	5. PDO Mapping entry (object 0x6050 (AI Inputs Ch.4), entry 0x11 (Value))	UINT32	RO	0x6050:11, 16

**Index 1A06 AI TxPDO-Map Inputs Ch.5**

Index (hex)	Name	Meaning	Data type	Flags	Default
1A06:0	AI TxPDO-Map Inputs Ch.5	PDO Mapping TxPDO 7	UINT8	RO	0x05 (5 <sub>dec</sub> )
1A06:01	SubIndex 001	1. PDO Mapping entry (13 bits align)	UINT32	RO	0x0000:00, 6
1A06:02	SubIndex 002	2. PDO Mapping entry (object 0x1C33 (SM input parameter), entry 0x20 (Sync error))	UINT32	RO	0x6060:07, 1
1A06:03	SubIndex 003	3. PDO Mapping entry (1 bits align)	UINT32	RO	0x0000:00, 8
1A06:04	SubIndex 004	4. PDO Mapping entry (object 0x6060 (AI Inputs Ch.5), entry 0x10 (TxPDO Toggle))	UINT32	RO	0x6060:10, 1
1A06:05	SubIndex 005	5. PDO Mapping entry (object 0x6060 (AI Inputs Ch.5), entry 0x11 (Value))	UINT32	RO	0x6060:11, 16

**Index 1A07 AI TxPDO-Map Inputs Ch.6**

Index (hex)	Name	Meaning	Data type	Flags	Default
1A07:0	AI TxPDO-Map Inputs Ch.6	PDO Mapping TxPDO 8	UINT8	RO	0x05 (5 <sub>dec</sub> )
1A07:01	SubIndex 001	1. PDO Mapping entry (13 bits align)	UINT32	RO	0x0000:00, 6
1A07:02	SubIndex 002	2. PDO Mapping entry (object 0x1C33 (SM input parameter), entry 0x20 (Sync error))	UINT32	RO	0x6070:07, 1
1A07:03	SubIndex 003	3. PDO Mapping entry (1 bits align)	UINT32	RO	0x0000:00, 8
1A07:04	SubIndex 004	4. PDO Mapping entry (object 0x6070 (AI Inputs Ch.6), entry 0x10 (TxPDO Toggle))	UINT32	RO	0x6070:10, 1
1A07:05	SubIndex 005	5. PDO Mapping entry (object 0x6070 (AI Inputs Ch.6), entry 0x11 (Value))	UINT32	RO	0x6070:11, 16

**Index 1A08 DIG TxPDO-Map Inputs Device**

Index (hex)	Name	Meaning	Data type	Flags	Default
1A08:0	DIG TxPDO-Map Inputs Device	PDO Mapping TxPDO 9	UINT8	RO	0x04 (4 <sub>dec</sub> )
1A08:01	SubIndex 001	1. PDO Mapping entry (object 0xF600 (DIG Inputs), entry 0x01 (Us Undervoltage))	UINT32	RO	0xF600:01, 1
1A08:02	SubIndex 002	2. PDO Mapping entry (object 0xF600 (DIG Inputs), entry 0x02 (Up Undervoltage))	UINT32	RO	0xF600:02, 1
1A08:03	SubIndex 003	3. PDO Mapping entry (11 bits align)	UINT32	RO	0x0000:00, 13
1A08:04	SubIndex 004	4. PDO Mapping entry (object 0xF600 (DIG Inputs), entry 0x0E (Sync error))	UINT32	RO	0xF600:10, 1

**Index 1C00 Sync manager type**

Index (hex)	Name	Meaning	Data type	Flags	Default
1C00:0	Sync manager type	Using the sync managers	UINT8	RO	0x04 (4 <sub>dec</sub> )
1C00:01	SubIndex 001	Sync-Manager Type Channel 1: Mailbox Write	UINT8	RO	0x01 (1 <sub>dec</sub> )
1C00:02	SubIndex 002	Sync-Manager Type Channel 2: Mailbox Read	UINT8	RO	0x02 (2 <sub>dec</sub> )
1C00:03	SubIndex 003	Sync-Manager Type Channel 3: Process Data Write (Outputs)	UINT8	RO	0x03 (3 <sub>dec</sub> )
1C00:04	SubIndex 004	Sync-Manager Type Channel 4: Process Data Read (Inputs)	UINT8	RO	0x04 (4 <sub>dec</sub> )

**Index 1C12 RxPDO assign**

Index (hex)	Name	Meaning	Data type	Flags	Default
1C12:0	RxPDO assign	PDO Assign Outputs	UINT8	RO	0x00 (0 <sub>dec</sub> )

**Index 1C13 TxPDO assign**

Index (hex)	Name	Meaning	Data type	Flags	Default
1C13:0	TxPDO assign	PDO Assign Inputs	UINT8	RO	0x09 (9 <sub>dec</sub> )
1C13:01	Subindex 001	1. allocated TxPDO (contains the index of the associated TxPDO mapping object)	UINT16	RO	0x1A00 (6656 <sub>dec</sub> )
1C13:02	Subindex 002	2. allocated TxPDO (contains the index of the associated TxPDO mapping object)	UINT16	RO	0x1A01 (6657 <sub>dec</sub> )
1C13:03	Subindex 003	3. allocated TxPDO (contains the index of the associated TxPDO mapping object)	UINT16	RO	0x1A02 (6658 <sub>dec</sub> )
1C13:04	Subindex 004	4. allocated TxPDO (contains the index of the associated TxPDO mapping object)	UINT16	RO	0x1A03 (6659 <sub>dec</sub> )
1C13:05	Subindex 005	5. allocated TxPDO (contains the index of the associated TxPDO mapping object)	UINT16	RO	0x1A04 (6660 <sub>dec</sub> )
1C13:06	Subindex 006	6. allocated TxPDO (contains the index of the associated TxPDO mapping object)	UINT16	RO	0x1A05 (6661 <sub>dec</sub> )
1C13:07	Subindex 007	7. allocated TxPDO (contains the index of the associated TxPDO mapping object)	UINT16	RO	0x1A06 (6662 <sub>dec</sub> )
1C13:08	Subindex 008	8. allocated TxPDO (contains the index of the associated TxPDO mapping object)	UINT16	RO	0x1A07 (6663 <sub>dec</sub> )
1C13:09	Subindex 009	9. allocated TxPDO (contains the index of the associated TxPDO mapping object)	UINT16	RO	0x1A08 (6664 <sub>dec</sub> )

## Index 1C33SM input parameter

Index (hex)	Name	Meaning	Data type	Flags	Default
1C33:0	SM input parameter	Synchronization parameters for the inputs	UINT8	RO	0x20 (32 <sub>dec</sub> )
1C33:01	Sync mode	Current synchronization mode: <ul style="list-style-type: none"> <li>• 0: Free Run</li> <li>• 1: Synchronous with SM 3 Event (no outputs available)</li> <li>• 2: DC - Synchron with SYNC0 Event</li> <li>• 3: DC - Synchron with SYNC1 Event</li> <li>• 34: Synchronous with SM 2 Event (outputs available)</li> </ul>	UINT16	RW	0x0022 (34 <sub>dec</sub> )
1C33:02	Cycle time	as 0x1C32:02	UINT32	RW	0x003D0900 (4000000 <sub>dec</sub> )
1C33:03	Shift time	Time between SYNC0 event and reading of the inputs (in ns, only DC mode)	UINT32	RO	0x00000000 (0 <sub>dec</sub> )
1C33:04	Sync modes supported	Supported synchronization modes: <ul style="list-style-type: none"> <li>• Bit 0: free run is supported</li> <li>• Bit 1: Synchronous with SM 2 Event is supported (outputs available)</li> <li>• Bit 1: Synchronous with SM 3 Event is supported (no outputs available)</li> <li>• Bit 2-3 = 01: DC mode is supported</li> <li>• Bit 4-5 = 01: Input shift through local event (outputs available)</li> <li>• Bit 4-5 = 10: Input shift with SYNC1 event (no outputs available)</li> <li>• Bit 14 = 1: dynamic times (measurement through writing of 0x1C32:08 or 0x1C33:08)</li> </ul>	UINT16	RO	0xC007 (49159 <sub>dec</sub> )
1C33:05	Minimum cycle time	as 0x1C32:05	UINT32	RO	0x00030D40 (200000 <sub>dec</sub> )
1C33:06	Calc and copy time	Time between reading of the inputs and availability of the inputs for the master (in ns, only DC mode)	UINT32	RO	0x00000000 (0 <sub>dec</sub> )
1C33:07	Minimum delay time		UINT32	RO	0x00000000 (0 <sub>dec</sub> )
1C33:08	Command	as 0x1C32:08	UINT16	RW	0x0000 (0 <sub>dec</sub> )
1C33:09	Maximum delay time	Time between SYNC1 event and reading of the inputs (in ns, only DC mode)	UINT32	RO	0x00000000 (0 <sub>dec</sub> )
1C33:0B	SM event missed counter	as 0x1C32:11	UINT16	RO	0x0000 (0 <sub>dec</sub> )
1C33:0C	Cycle exceeded counter	as 0x1C32:12	UINT16	RO	0x0000 (0 <sub>dec</sub> )
1C33:0D	Shift too short counter	as 0x1C32:13	UINT16	RO	0x0000 (0 <sub>dec</sub> )
1C33:20	Sync error	as 0x1C32:32	BOOLEAN	RO	0x00 (0 <sub>dec</sub> )

### 7.4.3 Profile-specific objects (0x6000-0xFFFF)

The profile-specific objects have the same meaning for all EtherCAT slaves that support the profile 5001.

#### Index 6000 DIG Inputs Ch.1

Index (hex)	Name	Meaning	Data type	Flags	Default
6000:0	DIG Inputs Ch.1		UINT8	RO	0x08 (8 <sub>dec</sub> )
6000:01	Input 1		BOOLEAN	RO	0x00 (0 <sub>dec</sub> )
6000:02	Input 2		BOOLEAN	RO	0x00 (0 <sub>dec</sub> )
6000:03	Input 3		BOOLEAN	RO	0x00 (0 <sub>dec</sub> )
6000:04	Input 4		BOOLEAN	RO	0x00 (0 <sub>dec</sub> )
6000:05	Input 5		BOOLEAN	RO	0x00 (0 <sub>dec</sub> )
6000:06	Input 6		BOOLEAN	RO	0x00 (0 <sub>dec</sub> )
6000:07	Input 7		BOOLEAN	RO	0x00 (0 <sub>dec</sub> )
6000:08	Input 8		BOOLEAN	RO	0x00 (0 <sub>dec</sub> )

#### Index 6010 DIG Inputs Ch.2

Index (hex)	Name	Meaning	Data type	Flags	Default
6010:0	DIG Inputs Ch.2		UINT8	RO	0x08 (8 <sub>dec</sub> )
6010:01	Input 1		BOOLEAN	RO	0x00 (0 <sub>dec</sub> )
6010:02	Input 2		BOOLEAN	RO	0x00 (0 <sub>dec</sub> )
6010:03	Input 3		BOOLEAN	RO	0x00 (0 <sub>dec</sub> )
6010:04	Input 4		BOOLEAN	RO	0x00 (0 <sub>dec</sub> )
6010:05	Input 5		BOOLEAN	RO	0x00 (0 <sub>dec</sub> )
6010:06	Input 6		BOOLEAN	RO	0x00 (0 <sub>dec</sub> )
6010:07	Input 7		BOOLEAN	RO	0x00 (0 <sub>dec</sub> )
6010:08	Input 8		BOOLEAN	RO	0x00 (0 <sub>dec</sub> )

#### Index 6020 AI Inputs Ch.1

Index (hex)	Name	Meaning	Data type	Flags	Default
6020:0	AI Inputs Ch.1		UINT8	RO	0x11 (17 <sub>dec</sub> )
6020:07	Error		BOOLEAN	RO	0x00 (0 <sub>dec</sub> )
6020:10	TxPDO Toggle		BOOLEAN	RO	0x00 (0 <sub>dec</sub> )
6020:11	Value		INT16	RO	0x0000 (0 <sub>dec</sub> )

#### Index 6030 AI Inputs Ch.2

Index (hex)	Name	Meaning	Data type	Flags	Default
6030:0	AI Inputs Ch.2		UINT8	RO	0x11 (17 <sub>dec</sub> )
6030:07	Error		BOOLEAN	RO	0x00 (0 <sub>dec</sub> )
6030:10	TxPDO Toggle		BOOLEAN	RO	0x00 (0 <sub>dec</sub> )
6030:11	Value		INT16	RO	0x0000 (0 <sub>dec</sub> )

#### Index 6040 AI Inputs Ch.3

Index (hex)	Name	Meaning	Data type	Flags	Default
6040:0	AI Inputs Ch.3		UINT8	RO	0x11 (17 <sub>dec</sub> )
6040:07	Error		BOOLEAN	RO	0x00 (0 <sub>dec</sub> )
6040:10	TxPDO Toggle		BOOLEAN	RO	0x00 (0 <sub>dec</sub> )
6040:11	Value		INT16	RO	0x0000 (0 <sub>dec</sub> )

#### Index 6050 AI Inputs Ch.4

Index (hex)	Name	Meaning	Data type	Flags	Default
6050:0	AI Inputs Ch.4		UINT8	RO	0x11 (17 <sub>dec</sub> )
6050:07	Error		BOOLEAN	RO	0x00 (0 <sub>dec</sub> )
6050:10	TxPDO Toggle		BOOLEAN	RO	0x00 (0 <sub>dec</sub> )
6050:11	Value		INT16	RO	0x0000 (0 <sub>dec</sub> )

**Index 6060 AI Inputs Ch.5**

Index (hex)	Name	Meaning	Data type	Flags	Default
6060:0	AI Inputs Ch.5		UINT8	RO	0x11 (17 <sub>dec</sub> )
6060:07	Error		BOOLEAN	RO	0x00 (0 <sub>dec</sub> )
6060:10	TxPDO Toggle		BOOLEAN	RO	0x00 (0 <sub>dec</sub> )
6060:11	Value		INT16	RO	0x0000 (0 <sub>dec</sub> )

**Index 6070 AI Inputs Ch.6**

Index (hex)	Name	Meaning	Data type	Flags	Default
6070:0	AI Inputs Ch.6		UINT8	RO	0x11 (17 <sub>dec</sub> )
6070:07	Error		BOOLEAN	RO	0x00 (0 <sub>dec</sub> )
6070:10	TxPDO Toggle		BOOLEAN	RO	0x00 (0 <sub>dec</sub> )
6070:11	Value		INT16	RO	0x0000 (0 <sub>dec</sub> )

**Index F000 Modular device profile**

Index (hex)	Maximum number of modules>Name	Meaning	UINT16>Data type	RO>Flags	0x0009 (9 <sub>dec</sub> )>Default
F000:0	Modular device profile	General information for the modular device profile	UINT8	RO	0x02 (2 <sub>dec</sub> )
F000:01	Module index distance		UINT16	RO	0x0010 (16 <sub>dec</sub> )
F000:02	Maximum number of modules		UINT16	RO	0x0009 (9 <sub>dec</sub> )

**Index F008 Code word**

Index (hex)	Name	Meaning	Data type	Flags	Default
F008:0	Code word		UINT32	RW	0x00000000 (0 <sub>dec</sub> )

**Index F010 Module list**

Index (hex)	Name	Meaning	Data type	Flags	Default
F010:0	Module list		UINT8	RW	0x09 (9 <sub>dec</sub> )
F010:01	SubIndex 001		UINT32	RW	0x00000118 (280 <sub>dec</sub> )
F010:02	SubIndex 002		UINT32	RW	0x00000118 (280 <sub>dec</sub> )
F010:03	SubIndex 003		UINT32	RW	0x0000012C (300 <sub>dec</sub> )
F010:04	SubIndex 004		UINT32	RW	0x0000012C (300 <sub>dec</sub> )
F010:05	SubIndex 005		UINT32	RW	0x0000012C (300 <sub>dec</sub> )
F010:06	SubIndex 006		UINT32	RW	0x0000012C (300 <sub>dec</sub> )
F010:07	SubIndex 007		UINT32	RW	0x0000012C (300 <sub>dec</sub> )
F010:08	SubIndex 008		UINT32	RW	0x0000012C (300 <sub>dec</sub> )
F010:09	SubIndex 009		UINT32	RW	0x00000168 (360 <sub>dec</sub> )

**Index F600 DIG Inputs**

Index (hex)	Name	Meaning	Data type	Flags	Default
F600:0	DIG Inputs		UINT8	RO	0x10 (16 <sub>dec</sub> )
F600:01	Us Undervoltage		BOOLEAN	RO	0x00 (0 <sub>dec</sub> )
F600:02	Up Undervoltage		BOOLEAN	RO	0x00 (0 <sub>dec</sub> )
F600:10	TxPDO Toggle		BOOLEAN	RO	0x00 (0 <sub>dec</sub> )

## 7.5 EP1819-0005 - Object description and parameterization

### 7.5.1 Objects to be parameterized during commissioning

#### Index 8100 DIP Settings Ch.17

Index (hex)	Name	Meaning	Data type	Flags	Default
8100:0	DIP Settings Ch.17		UINT8	RO	0x03 (3 <sub>dec</sub> )
8100:03	Enable Antivalent Input Diagnostic	Enable antivalent diagnostic on the inputs	BOOLEAN	RW	0x00 (0 <sub>dec</sub> )

#### Index 8110 DIP Settings Ch.18

Index (hex)	Name	Meaning	Data type	Flags	Default
8110:0	DIP Settings Ch.18		UINT8	RO	0x03 (3 <sub>dec</sub> )
8110:03	Enable Antivalent Input Diagnostic	Enable antivalent diagnostic on the inputs	BOOLEAN	RW	0x00 (0 <sub>dec</sub> )

#### Index 8120 DIP Settings Ch.19

Index (hex)	Name	Meaning	Data type	Flags	Default
8120:0	DIP Settings Ch.19		UINT8	RO	0x03 (3 <sub>dec</sub> )
8120:03	Enable Antivalent Input Diagnostic	Enable antivalent diagnostic on the inputs	BOOLEAN	RW	0x00 (0 <sub>dec</sub> )

#### Index 8130 DIP Settings Ch.20

Index (hex)	Name	Meaning	Data type	Flags	Default
8130:0	DIP Settings Ch.20		UINT8	RO	0x03 (3 <sub>dec</sub> )
8130:03	Enable Antivalent Input Diagnostic	Enable antivalent diagnostic on the inputs	BOOLEAN	RW	0x00 (0 <sub>dec</sub> )

#### Index 8140 DIP Settings Ch.21

Index (hex)	Name	Meaning	Data type	Flags	Default
8140:0	DIP Settings Ch.21		UINT8	RO	0x03 (3 <sub>dec</sub> )
8140:03	Enable Antivalent Input Diagnostic	Enable antivalent diagnostic on the inputs	BOOLEAN	RW	0x00 (0 <sub>dec</sub> )

#### Index 8150 DIP Settings Ch.22

Index (hex)	Name	Meaning	Data type	Flags	Default
8150:0	DIP Settings Ch.22		UINT8	RO	0x03 (3 <sub>dec</sub> )
8150:03	Enable Antivalent Input Diagnostic	Enable antivalent diagnostic on the inputs	BOOLEAN	RW	0x00 (0 <sub>dec</sub> )

#### Index 8160 DIP Settings Ch.23

Index (hex)	Name	Meaning	Data type	Flags	Default
8160:0	DIP Settings Ch.23		UINT8	RO	0x03 (3 <sub>dec</sub> )
8160:03	Enable Antivalent Input Diagnostic	Enable antivalent diagnostic on the inputs	BOOLEAN	RW	0x00 (0 <sub>dec</sub> )

**Index 8170 DIP Settings Ch.24**

Index (hex)	Name	Meaning	Data type	Flags	Default
8170:0	DIP Settings Ch.24		UINT8	RO	0x03 (3 <sub>dec</sub> )
8170:03	Enable Antivalent Input Diagnostic	Enable antivalent diagnostic on the inputs	BOOLEAN	RW	0x00 (0 <sub>dec</sub> )



## 7.5.2 Standard objects (0x1000 to 0x1FFF)

### Index 1000 Device type

Index (hex)	Name	Meaning	Data type	Flags	Default
1000:0	Device type	Device type of the EtherCAT slave: the Lo-Word contains the used CoE profile (5001). The Hi-Word contains the module profile according to the modular device profile.	UINT32	RO	0x00651389 (6624137 <sub>dec</sub> )

### Index 1008 Device name

Index (hex)	Name	Meaning	Data type	Flags	Default
1008:0	Device name	Device name of the EtherCAT slave	STRING	RO	EP1819-0005

### Index 1009 Hardware version

Index (hex)	Name	Meaning	Data type	Flags	Default
1009:0	Hardware version	Hardware version of the EtherCAT slave	STRING	RO	

### Index 100A Software version

Index (hex)	Name	Meaning	Data type	Flags	Default
100A:0	Software version	Firmware version of the EtherCAT slave	STRING	RO	00

### Index 100B Bootloader version

Index (hex)	Name	Meaning	Data type	Flags	Default
100B:0	Bootloader version		STRING	RO	N/A

### Index 1011 Restore default parameters

Index (hex)	Name	Meaning	Data type	Flags	Default
1011:0	Restore default parameters	Restore default parameters	UINT8	RO	0x01 (1 <sub>dec</sub> )
1011:01	SubIndex 001	If this object is set to "0x64616F6C" in the set value dialog, all backup objects are reset to their delivery state.	UINT32	RW	0x00000000 (0 <sub>dec</sub> )

### Index 1018 Identity

Index (hex)	Name	Meaning	Data type	Flags	Default
1018:0	Identity	Information for identifying the slave	UINT8	RO	0x04 (4 <sub>dec</sub> )
1018:01	Vendor ID	Vendor ID of the EtherCAT slave	UINT32	RO	0x00000002 (2 <sub>dec</sub> )
1018:02	Product code	Product code of the EtherCAT slave	UINT32	RO	0x071B4052 (119226450 <sub>dec</sub> )
1018:03	Revision	Revision number of the EtherCAT slave; the Low Word (bit 0-15) indicates the special terminal number, the High Word (bit 16-31) refers to the device description	UINT32	RO	0x00000000 (0 <sub>dec</sub> )
1018:04	Serial number	Serial number of the EtherCAT slave; the Low Byte (bit 0-7) of the Low Word contains the year of production, the High Byte (bit 8-15) of the Low Word contains the week of production, the High Word (bit 16-31) is 0	UINT32	RO	0x00000000 (0 <sub>dec</sub> )

**Index 10E2 Manufacturer-specific Identification Code**

Index (hex)	Name	Meaning	Data type	Flags	Default
10E2:0	Manufacturer-specific Identification Code		UINT8	RO	0x01 (1 <sub>dec</sub> )
10E2:01	SubIndex 001		STRING	RO	

**Index 10F0 Backup parameter handling**

Index (hex)	Name	Meaning	Data type	Flags	Default
10F0:01	Checksum	Checksum across all backup entries of the EtherCAT slave	UINT32	RO	0x00000000 (0 <sub>dec</sub> )

**Index 1A00 DIP TxPDO-Map Input**

Index (hex)	Name	Meaning	Data type	Flags	Default
1A00:0	DIP TxPDO-Map Input	PDO Mapping TxPDO 1	UINT8	RO	0x10 (16 <sub>dec</sub> )
1A00:01	SubIndex 001	1. PDO Mapping entry (object 0x6000 (DIS Input Ch.1), entry 0x01 (Input))	UINT32	RO	0x6000:01, 1
1A00:02	SubIndex 002	2. PDO Mapping entry (object 0x6010 (DIS Input Ch.2), entry 0x01 (Input))	UINT32	RO	0x6010:01, 1
1A00:03	SubIndex 003	3. PDO Mapping entry (object 0x6020 (DIS Input Ch.3), entry 0x01 (Input))	UINT32	RO	0x6020:01, 1
1A00:04	SubIndex 004	4. PDO Mapping entry (object 0x6030 (DIS Input Ch.4), entry 0x01 (Input))	UINT32	RO	0x6030:01, 1
1A00:05	SubIndex 005	5. PDO Mapping entry (object 0x6040 (DIS Input Ch.5), entry 0x01 (Input))	UINT32	RO	0x6040:01, 1
1A00:06	SubIndex 006	6. PDO Mapping entry (object 0x6050 (DIS Input Ch.6), entry 0x01 (Input))	UINT32	RO	0x6050:01, 1
1A00:07	SubIndex 007	7. PDO Mapping entry (object 0x6060 (DIS Input Ch.7), entry 0x01 (Input))	UINT32	RO	0x6060:01, 1
1A00:08	SubIndex 008	8. PDO Mapping entry (object 0x6070 (DIS Input Ch.8), entry 0x01 (Input))	UINT32	RO	0x6070:01, 1
1A00:09	SubIndex 009	9. PDO Mapping entry (object 0x6080 (DIP Input Ch.09), entry 0x01 (Input))	UINT32	RO	0x6080:01, 1
1A00:0A	SubIndex 010	10. PDO Mapping entry (object 0x6090 (DIP Input Ch.10), entry 0x01 (Input))	UINT32	RO	0x6090:01, 1
1A00:0B	SubIndex 011	11. PDO Mapping entry (object 0x60A0 (DIP Input Ch.11), entry 0x01 (Input))	UINT32	RO	0x60A0:01, 1
1A00:0C	SubIndex 012	12. PDO Mapping entry (object 0x60B0 (DIP Input Ch.12), entry 0x01 (Input))	UINT32	RO	0x60B0:01, 1
1A00:0D	SubIndex 013	13. PDO Mapping entry (object 0x60C0 (DIP Input Ch.13), entry 0x01 (Input))	UINT32	RO	0x60C0:01, 1
1A00:0E	SubIndex 014	14. PDO Mapping entry (object 0x60D0 (DIP Input Ch.14), entry 0x01 (Input))	UINT32	RO	0x60D0:01, 1
1A00:0F	SubIndex 015	15. PDO Mapping entry (object 0x60E0 (DIP Input Ch.15), entry 0x01 (Input))	UINT32	RO	0x60E0:01, 1
1A00:10	SubIndex 016	16. PDO Mapping entry (object 0x60F0 (DIP Input Ch.16), entry 0x01 (Input))	UINT32	RO	0x60F0:01, 1

**Index 1A01 DIP TxPDO-Map Diagnosis**

Index (hex)	Name	Meaning	Data type	Flags	Default
1A01:0	DIP TxPDO-Map Diagnosis	PDO Mapping TxPDO 2	UINT8	RO	0x08 (8 <sub>dec</sub> )
1A01:01	SubIndex 001	1. PDO Mapping entry (object 0x6000 (DIP Input Ch.1), entry 0x01 (Input))	UINT32	RO	0x6101:02, 1
1A01:02	SubIndex 002	2. PDO Mapping entry (object 0x6000 (DIP Input Ch.1), entry 0x02 (Input 2))	UINT32	RO	0x6111:02, 1
1A01:03	SubIndex 003	3. PDO Mapping entry (object 0x6010 (DIP Input Ch.2), entry 0x01 (Input))	UINT32	RO	0x6121:02, 1
1A01:04	SubIndex 004	4. PDO Mapping entry (object 0x6010 (DIP Input Ch.2), entry 0x02 (Input 2))	UINT32	RO	0x6131:02, 1
1A01:05	SubIndex 005	5. PDO Mapping entry (object 0x6020 (DIP Input Ch.3), entry 0x01 (Input))	UINT32	RO	0x6141:02, 1
1A01:06	SubIndex 006	6. PDO Mapping entry (object 0x6020 (DIP Input Ch.3), entry 0x02 (Input 2))	UINT32	RO	0x6151:02, 1
1A01:07	SubIndex 007	7. PDO Mapping entry (object 0x6030 (DIP Input Ch.4), entry 0x01 (Input))	UINT32	RO	0x6161:02, 1
1A01:08	SubIndex 008	8. PDO Mapping entry (object 0x6030 (DIP Input Ch.4), entry 0x02 (Input 2))	UINT32	RO	0x6171:02, 1

**Index 1C00 Sync manager type**

Index (hex)	Name	Meaning	Data type	Flags	Default
1C00:0	Sync manager type	Using the Sync Managers	UINT8	RO	0x04 (4 <sub>dec</sub> )
1C00:01	SubIndex 001	Sync-Manager Type Channel 1: Mailbox Write	UINT8	RO	0x01 (1 <sub>dec</sub> )
1C00:02	SubIndex 002	Sync-Manager Type Channel 2: Mailbox Read	UINT8	RO	0x02 (2 <sub>dec</sub> )
1C00:03	SubIndex 003	Sync-Manager Type Channel 3: Process Data Write (Outputs)	UINT8	RO	0x03 (3 <sub>dec</sub> )
1C00:04	SubIndex 004	Sync-Manager Type Channel 4: Process Data Read (Inputs)	UINT8	RO	0x04 (4 <sub>dec</sub> )

**Index 1C12 RxPDO assign**

Index (hex)	Name	Meaning	Data type	Flags	Default
1C12:0	RxPDO assign	PDO Assign Outputs	UINT8	RO	0x00 (0 <sub>dec</sub> )

**Index 1C13 TxPDO assign**

Index (hex)	Name	Meaning	Data type	Flags	Default
1C13:0	TxPDO assign	PDO Assign Inputs	UINT8	RW	0x01 (1 <sub>dec</sub> )
1C13:01	Subindex 001	1. allocated TxPDO (contains the index of the associated TxPDO mapping object)	UINT16	RW	0x1A00 (6656 <sub>dec</sub> )
1C13:02	Subindex 002	2. allocated TxPDO (contains the index of the associated TxPDO mapping object)	UINT16	RW	0x0000 (0 <sub>dec</sub> )

## Index 1C33 SM input parameter

Index (hex)	Name	Meaning	Data type	Flags	Default
1C33:0	SM input parameter	Synchronization parameters for the inputs	UINT8	RO	0x20 (32 <sub>dec</sub> )
1C33:01	Sync mode	Current synchronization mode: <ul style="list-style-type: none"> <li>• 0: Free Run</li> <li>• 1: Synchron with SM 3 Event (no outputs available)</li> <li>• 2: DC - Synchron with SYNC0 Event</li> <li>• 3: DC - Synchron with SYNC1 Event</li> <li>• 34: Synchron with SM 2 Event (outputs available)</li> </ul>	UINT16	RW	0x0001 (1 <sub>dec</sub> )
1C33:02	Cycle time	as 1C32:02	UINT32	RW	0x000F4240 (100000 <sub>dec</sub> )
1C33:03	Shift time	Time between SYNC0 event and reading of the inputs (in ns, DC mode only)	UINT32	RO	0x000249F0 (150000 <sub>dec</sub> )
1C33:04	Sync modes supported	Supported synchronization modes: <ul style="list-style-type: none"> <li>• Bit 0: Free Run is supported</li> <li>• Bit 1: Synchron with SM 2 Event is supported (outputs available)</li> <li>• Bit 1: Synchron with SM 3 Event is supported (no outputs available)</li> <li>• Bit 2-3 = 01: DC-Mode is supported</li> <li>• Bit 4-5 = 01: Input Shift through local event (outputs available)</li> <li>• Bit 4-5 = 10: Input Shift with SYNC1 Event (no outputs available)</li> <li>• Bit 14 = 1: dynamic times (measurement through writing of 1C32:08 or 1C33:08)</li> </ul>	UINT16	RO	0x440B (17419 <sub>dec</sub> )
1C33:05	Minimum cycle time	as 1C32:05	UINT32	RO	0x000249F0 (150000 <sub>dec</sub> )
1C33:06	Calc and copy time	Time between reading of the inputs and availability of the inputs for the master (in ns, only DC mode)	UINT32	RO	0x00000000 (0 <sub>dec</sub> )
1C33:07	Minimum delay time		UINT32	RO	0x00000000 (0 <sub>dec</sub> )
1C33:08	Get Cycle Time	as 1C32:08	UINT16	RW	0x0000 (0 <sub>dec</sub> )
1C33:09	Maximum delay time	Time between SYNC1 event and reading of the inputs (in ns, only DC mode)	UINT32	RO	0x00000000 (0 <sub>dec</sub> )
1C33:0B	SM event missed counter	as 1C32:11	UINT16	RO	0x0000 (0 <sub>dec</sub> )
1C33:0C	Cycle exceeded counter	as 1C32:12	UINT16	RO	0x0000 (0 <sub>dec</sub> )
1C33:0D	Shift too short counter	as 1C32:13	UINT16	RO	0x0000 (0 <sub>dec</sub> )
1C33:20	Sync error	as 1C32:32	BOOLEAN	RO	0x00 (0 <sub>dec</sub> )

### 7.5.3 Profile-specific objects (0x6000 to 0xFFFF)

#### Index 6000 DIP Input Ch.01

Index (hex)	Name	Meaning	Data type	Flags	Default
6000:0	DIP Input Ch.01		UINT8	RO	0x01 (1 <sub>dec</sub> )
6000:01	Input	Input value	BOOLEAN	RO	0x00 (0 <sub>dec</sub> )

#### Index 6010 DIP Input Ch.02

Index (hex)	Name	Meaning	Data type	Flags	Default
6010:0	DIP Input Ch.02		UINT8	RO	0x01 (1 <sub>dec</sub> )
6010:01	Input	Input value	BOOLEAN	RO	0x00 (0 <sub>dec</sub> )

#### Index 6020 DIP Input Ch.03

Index (hex)	Name	Meaning	Data type	Flags	Default
6020:0	DIP Input Ch.03		UINT8	RO	0x01 (1 <sub>dec</sub> )
6020:01	Input	Input value	BOOLEAN	RO	0x00 (0 <sub>dec</sub> )

#### Index 6030 DIP Input Ch.04

Index (hex)	Name	Meaning	Data type	Flags	Default
6030:0	DIP Input Ch.04		UINT8	RO	0x01 (1 <sub>dec</sub> )
6030:01	Input	Input value	BOOLEAN	RO	0x00 (0 <sub>dec</sub> )

#### Index 6040 DIP Input Ch.05

Index (hex)	Name	Meaning	Data type	Flags	Default
6040:0	DIP Input Ch.05		UINT8	RO	0x01 (1 <sub>dec</sub> )
6040:01	Input	Input value	BOOLEAN	RO	0x00 (0 <sub>dec</sub> )

#### Index 6050 DIP Input Ch.06

Index (hex)	Name	Meaning	Data type	Flags	Default
6050:0	DIP Input Ch.06		UINT8	RO	0x01 (1 <sub>dec</sub> )
6050:01	Input	Input value	BOOLEAN	RO	0x00 (0 <sub>dec</sub> )

#### Index 6060 DIP Input Ch.07

Index (hex)	Name	Meaning	Data type	Flags	Default
6060:0	DIP Input Ch.07		UINT8	RO	0x01 (1 <sub>dec</sub> )
6060:01	Input	Input value	BOOLEAN	RO	0x00 (0 <sub>dec</sub> )

#### Index 6070 DIP Input Ch.08

Index (hex)	Name	Meaning	Data type	Flags	Default
6070:0	DIP Input Ch.08		UINT8	RO	0x01 (1 <sub>dec</sub> )
6070:01	Input	Input value	BOOLEAN	RO	0x00 (0 <sub>dec</sub> )

#### Index 6080 DIP Input Ch.09

Index (hex)	Name	Meaning	Data type	Flags	Default
6080:0	DIP Input Ch.09		UINT8	RO	0x01 (1 <sub>dec</sub> )
6080:01	Input	Input value	BOOLEAN	RO	0x00 (0 <sub>dec</sub> )

**Index 6090 DIP Input Ch.10**

Index (hex)	Name	Meaning	Data type	Flags	Default
6090:0	DIP Input Ch.10		UINT8	RO	0x01 (1 <sub>dec</sub> )
6090:01	Input	Input value	BOOLEAN	RO	0x00 (0 <sub>dec</sub> )

**Index 60A0 DIP Input Ch.11**

Index (hex)	Name	Meaning	Data type	Flags	Default
60A0:0	DIP Input Ch.11		UINT8	RO	0x01 (1 <sub>dec</sub> )
60A0:01	Input	Input value	BOOLEAN	RO	0x00 (0 <sub>dec</sub> )

**Index 60B0 DIP Input Ch.12**

Index (hex)	Name	Meaning	Data type	Flags	Default
60B0:0	DIP Input Ch.12		UINT8	RO	0x01 (1 <sub>dec</sub> )
60B0:01	Input	Input value	BOOLEAN	RO	0x00 (0 <sub>dec</sub> )

**Index 60C0 DIP Input Ch.13**

Index (hex)	Name	Meaning	Data type	Flags	Default
60C0:0	DIP Input Ch.13		UINT8	RO	0x01 (1 <sub>dec</sub> )
60C0:01	Input	Input value	BOOLEAN	RO	0x00 (0 <sub>dec</sub> )

**Index 60D0 DIP Input Ch.14**

Index (hex)	Name	Meaning	Data type	Flags	Default
60D0:0	DIP Input Ch.14		UINT8	RO	0x01 (1 <sub>dec</sub> )
60D0:01	Input	Input value	BOOLEAN	RO	0x00 (0 <sub>dec</sub> )

**Index 60E0 DIP Input Ch.15**

Index (hex)	Name	Meaning	Data type	Flags	Default
60E0:0	DIP Input Ch.15		UINT8	RO	0x01 (1 <sub>dec</sub> )
60E0:01	Input	Input value	BOOLEAN	RO	0x00 (0 <sub>dec</sub> )

**Index 60F0 DIP Input Ch.16**

Index (hex)	Name	Meaning	Data type	Flags	Default
60F0:0	DIP Input Ch.16		UINT8	RO	0x01 (1 <sub>dec</sub> )
60F0:01	Input	Input value	BOOLEAN	RO	0x00 (0 <sub>dec</sub> )

**Index 6101 DIP Diagnosis Ch.17**

Index (hex)	Name	Meaning	Data type	Flags	Default
6101:0	DIP Diagnosis Ch.17		UINT8	RO	0x02 (2 <sub>dec</sub> )
6101:02	Input Error	Input validation fails. E.g. antivalent inputs are reading implausible values. Check sensor and wiring.	BOOLEAN	RO	0x00 (0 <sub>dec</sub> )

**Index 6111 DIP Diagnosis Ch.18**

Index (hex)	Name	Meaning	Data type	Flags	Default
6111:0	DIP Diagnosis Ch.18		UINT8	RO	0x02 (2 <sub>dec</sub> )
6111:02	Input Error	Input validation fails. E.g. antivalent inputs are reading implausible values. Check sensor and wiring.	BOOLEAN	RO	0x00 (0 <sub>dec</sub> )

**Index 6121 DIP Diagnosis Ch.19**

Index (hex)	Name	Meaning	Data type	Flags	Default
6121:0	DIP Diagnosis Ch.19		UINT8	RO	0x02 (2 <sub>dec</sub> )
6121:02	Input Error	Input validation fails. E.g. antivalent inputs are reading implausible values. Check sensor and wiring.	BOOLEAN	RO	0x00 (0 <sub>dec</sub> )

**Index 6131 DIP Diagnosis Ch.20**

Index (hex)	Name	Meaning	Data type	Flags	Default
6131:0	DIP Diagnosis Ch.20		UINT8	RO	0x02 (2 <sub>dec</sub> )
6131:02	Input Error	Input validation fails. E.g. antivalent inputs are reading implausible values. Check sensor and wiring.	BOOLEAN	RO	0x00 (0 <sub>dec</sub> )

**Index 6141 DIP Diagnosis Ch.21**

Index (hex)	Name	Meaning	Data type	Flags	Default
6141:0	DIP Diagnosis Ch.21		UINT8	RO	0x02 (2 <sub>dec</sub> )
6141:02	Input Error	Input validation fails. E.g. antivalent inputs are reading implausible values. Check sensor and wiring.	BOOLEAN	RO	0x00 (0 <sub>dec</sub> )

**Index 6151 DIP Diagnosis Ch.22**

Index (hex)	Name	Meaning	Data type	Flags	Default
6151:0	DIP Diagnosis Ch.22		UINT8	RO	0x02 (2 <sub>dec</sub> )
6151:02	Input Error	Input validation fails. E.g. antivalent inputs are reading implausible values. Check sensor and wiring.	BOOLEAN	RO	0x00 (0 <sub>dec</sub> )

**Index 6161 DIP Diagnosis Ch.23**

Index (hex)	Name	Meaning	Data type	Flags	Default
6161:0	DIP Diagnosis Ch.23		UINT8	RO	0x02 (2 <sub>dec</sub> )
6161:02	Input Error	Input validation fails. E.g. antivalent inputs are reading implausible values. Check sensor and wiring.	BOOLEAN	RO	0x00 (0 <sub>dec</sub> )

**Index 6171 DIP Diagnosis Ch.24**

Index (hex)	Name	Meaning	Data type	Flags	Default
6171:0	DIP Diagnosis Ch.24		UINT8	RO	0x02 (2 <sub>dec</sub> )
6171:02	Input Error	Input validation fails. E.g. antivalent inputs are reading implausible values. Check sensor and wiring.	BOOLEAN	RO	0x00 (0 <sub>dec</sub> )

**Index F000 Modular Device Profile**

Index (hex)	Name	Meaning	Data type	Flags	Default
F000:0	Modular Device Profile		UINT8	RO	0x02 (2 <sub>dec</sub> )
F000:01	Index distance		UINT16	RO	0x0010 (16 <sub>dec</sub> )
F000:02	Maximum number of modules		UINT16	RO	0x0018 (24 <sub>dec</sub> )

**Index F008 Code word**

Index (hex)	Name	Meaning	Data type	Flags	Default
F008:0	Code word		UINT32	RW	0x00000000 (0 <sub>dec</sub> )

**Index FB00 DEV Command**

Index (hex)	Name	Meaning	Data type	Flags	Default
FB00:0	DEV Command		UINT8	RO	0x03 (3 <sub>dec</sub> )
FB00:01	Request		OCTET-STRING[2]	RW	{0}
FB00:02	Status		UINT8	RO	0x00 (0 <sub>dec</sub> )
FB00:03	Response		OCTET-STRING[8]	RO	{0}



## 7.6 EP1839-0042 - Object overview

Index	Name	Flags	Default value
1000 [▶ 178]	Device type	RO	0x00001389 (5001 <sub>dec</sub> )
1008 [▶ 178]	Device name	RO	EP1839-0042
1009 [▶ 178]	Hardware version	RO	
100A [▶ 178]	Software version	RO	02
100B [▶ 178]	Bootloader version	RO	N/A
1011:0 [▶ 178]	SubIndex	RO	0x01 (1 <sub>dec</sub> )
	1011:01	RW	0x00000000 (0 <sub>dec</sub> )
1018:0 [▶ 178]	SubIndex	RO	0x04 (4 <sub>dec</sub> )
	1018:01	RO	0x00000002 (2 <sub>dec</sub> )
	1018:02	RO	0x072F4052 (120537170 <sub>dec</sub> )
	1018:03	RO	0x00000000 (0 <sub>dec</sub> )
	1018:04	RO	0x00000000 (0 <sub>dec</sub> )
10E2:0 [▶ 178]	SubIndex	RO	0x01 (1 <sub>dec</sub> )
	10E2:01	RO	
10F0:0 [▶ 179]	SubIndex	RO	0x01 (1 <sub>dec</sub> )
	10F0:01	RO	0x00000000 (0 <sub>dec</sub> )
10F3:0 [▶ 179]	SubIndex	RO	0x15 (21 <sub>dec</sub> )
	10F3:01	RO	0x00 (0 <sub>dec</sub> )
	10F3:02	RO	0x00 (0 <sub>dec</sub> )
	10F3:03	RW	0x00 (0 <sub>dec</sub> )
	10F3:04	RO	0x00 (0 <sub>dec</sub> )
	10F3:05	RW	0x0000 (0 <sub>dec</sub> )
	10F3:06	RO	{0}
	10F3:07	RO	{0}
	10F3:08	RO	{0}
	10F3:09	RO	{0}
	10F3:0A	RO	{0}
	10F3:0B	RO	{0}
	10F3:0C	RO	{0}
	10F3:0D	RO	{0}
	10F3:0E	RO	{0}
	10F3:0F	RO	{0}
	10F3:10	RO	{0}
	10F3:11	RO	{0}
	10F3:12	RO	{0}
	10F3:13	RO	{0}
	10F3:14	RO	{0}
	10F3:15	RO	{0}
10F8 [▶ 179]	Timestamp Object	RO	
10F9:0 [▶ 179]	SubIndex	RO	0x01 (1 <sub>dec</sub> )
	10F9:01	RW	

Index		Name	Flags	Default value
1602:0 [▶ 179]	SubIndex	DO RxPDO-Map Output	RO	0x08 (8 <sub>dec</sub> )
	1602:01	SubIndex 001	RO	0x7100:01, 1
	1602:02	SubIndex 002	RO	0x7110:01, 1
	1602:03	SubIndex 003	RO	0x7120:01, 1
	1602:04	SubIndex 004	RO	0x7130:01, 1
	1602:05	SubIndex 005	RO	0x7140:01, 1
	1602:06	SubIndex 006	RO	0x7150:01, 1
	1602:07	SubIndex 007	RO	0x7160:01, 1
	1602:08	SubIndex 008	RO	0x7170:01, 1
1A00:0 [▶ 180]	SubIndex	DI TxPDO-Map Input	RO	0x10 (16 <sub>dec</sub> )
	1A00:01	SubIndex 001	RO	0x6000:01, 1
	1A00:02	SubIndex 002	RO	0x6010:01, 1
	1A00:03	SubIndex 003	RO	0x6020:01, 1
	1A00:04	SubIndex 004	RO	0x6030:01, 1
	1A00:05	SubIndex 005	RO	0x6040:01, 1
	1A00:06	SubIndex 006	RO	0x6050:01, 1
	1A00:07	SubIndex 007	RO	0x6060:01, 1
	1A00:08	SubIndex 008	RO	0x6070:01, 1
	1A00:09	SubIndex 009	RO	0x6080:01, 1
	1A00:0A	SubIndex 010	RO	0x6090:01, 1
	1A00:0B	SubIndex 011	RO	0x60A0:01, 1
	1A00:0C	SubIndex 012	RO	0x60B0:01, 1
	1A00:0D	SubIndex 013	RO	0x60C0:01, 1
	1A00:0E	SubIndex 014	RO	0x60D0:01, 1
	1A00:0F	SubIndex 015	RO	0x60E0:01, 1
	1A00:10	SubIndex 016	RO	0x60F0:01, 1
1A01 [▶ 181]:0	SubIndex	DI TxPDO-Map Diagnosis	RO	0x10 (16 <sub>dec</sub> )
	1A01:01	SubIndex 001	RO	0x6001:01, 1
	1A01:02	SubIndex 002	RO	0x6011:01, 1
	1A01:03	SubIndex 003	RO	0x6021:01, 1
	1A01:04	SubIndex 004	RO	0x6031:01, 1
	1A01:05	SubIndex 005	RO	0x6041:01, 1
	1A01:06	SubIndex 006	RO	0x6051:01, 1
	1A01:07	SubIndex 007	RO	0x6061:01, 1
	1A01:08	SubIndex 008	RO	0x6071:01, 1
	1A01:09	SubIndex 009	RO	0x6081:01, 1
	1A01:0A	SubIndex 010	RO	0x6091:01, 1
	1A01:0B	SubIndex 011	RO	0x60A1:01, 1
	1A01:0C	SubIndex 012	RO	0x60B1:01, 1
	1A01:0D	SubIndex 013	RO	0x60C1:01, 1
	1A01:0E	SubIndex 014	RO	0x60D1:01, 1
	1A01:0F	SubIndex 015	RO	0x60E1:01, 1
	1A01:10	SubIndex 016	RO	0x60F1:01, 1
1A02:0 [▶ 182]	SubIndex	DO TxPDO-Map Diagnosis	RO	0x20 (32 <sub>dec</sub> )
	1A02:01	SubIndex 001	RO	0x6102:01, 1
	1A02:02	SubIndex 002	RO	0x6102:02, 1
	1A02:03	SubIndex 003	RO	0x6102:03, 1
	1A02:04	SubIndex 004	RO	0x6102:04, 1
	1A02:05	SubIndex 005	RO	0x6112:01, 1
	1A02:06	SubIndex 006	RO	0x6112:02, 1
	1A02:07	SubIndex 007	RO	0x6112:03, 1
	1A02:08	SubIndex 008	RO	0x6112:04, 1
	1A02:09	SubIndex 009	RO	0x6122:01, 1
	1A02:0A	SubIndex 010	RO	0x6122:02, 1
	1A02:0B	SubIndex 011	RO	0x6122:03, 1
	1A02:0C	SubIndex 012	RO	0x6122:04, 1
	1A02:0D	SubIndex 013	RO	0x6132:01, 1
	1A02:0E	SubIndex 014	RO	0x6132:02, 1

Index	Name	Flags	Default value	
	1A02:0F	SubIndex 015	RO	0x6132:03, 1
	1A02:10	SubIndex 016	RO	0x6132:04, 1
	1A02:11	SubIndex 017	RO	0x6142:01, 1
	1A02:12	SubIndex 018	RO	0x6142:02, 1
	1A02:13	SubIndex 019	RO	0x6142:03, 1
	1A02:14	SubIndex 020	RO	0x6142:04, 1
	1A02:15	SubIndex 021	RO	0x6152:01, 1
	1A02:16	SubIndex 022	RO	0x6152:02, 1
	1A02:17	SubIndex 023	RO	0x6152:03, 1
	1A02:18	SubIndex 024	RO	0x6152:04, 1
	1A02:19	SubIndex 025	RO	0x6162:01, 1
	1A02:1A	SubIndex 026	RO	0x6162:02, 1
	1A02:1B	SubIndex 027	RO	0x6162:03, 1
	1A02:1C	SubIndex 028	RO	0x6162:04, 1
	1A02:1D	SubIndex 029	RO	0x6172:01, 1
	1A02:1E	SubIndex 030	RO	0x6172:02, 1
	1A02:1F	SubIndex 031	RO	0x6172:03, 1
	1A02:20	SubIndex 032	RO	0x6172:04, 1
1A03:0 [▶ 183]	SubIndex	DEV TxPDO-Map Inputs Device	RO	0x07 (7 <sub>dec</sub> )
	1A03:01	SubIndex 001	RO	0xF600:01, 1
	1A03:02	SubIndex 002	RO	0x0000:00, 1
	1A03:03	SubIndex 003	RO	0xF600:03, 1
	1A03:04	SubIndex 004	RO	0x0000:00, 9
	1A03:05	SubIndex 005	RO	0xF600:0D, 1
	1A03:06	SubIndex 006	RO	0xF600:0E, 1
	1A03:07	SubIndex 007	RO	0xF600:0F, 2
1C00:0 [▶ 183]	SubIndex	Sync manager type	RO	0x04 (4 <sub>dec</sub> )
	1C00:01	SubIndex 001	RO	0x01 (1 <sub>dec</sub> )
	1C00:02	SubIndex 002	RO	0x02 (2 <sub>dec</sub> )
	1C00:03	SubIndex 003	RO	0x03 (3 <sub>dec</sub> )
	1C00:04	SubIndex 004	RO	0x04 (4 <sub>dec</sub> )
1C12:0 [▶ 183]	SubIndex	RxPDO assign	RW	0x01 (1 <sub>dec</sub> )
	1C12:01	SubIndex 001	RW	0x1602 (5634 <sub>dec</sub> )
	1C12:02	SubIndex 002	RW	0x0000 (0 <sub>dec</sub> )
	1C12:03	SubIndex 003	RW	0x0000 (0 <sub>dec</sub> )
	1C12:04	SubIndex 004	RW	0x0000 (0 <sub>dec</sub> )
	1C12:05	SubIndex 005	RW	0x0000 (0 <sub>dec</sub> )
	1C12:06	SubIndex 006	RW	0x0000 (0 <sub>dec</sub> )
	1C12:07	SubIndex 007	RW	0x0000 (0 <sub>dec</sub> )
	1C12:08	SubIndex 008	RW	0x0000 (0 <sub>dec</sub> )
1C13:0 [▶ 184]	SubIndex	TxPDO assign	RW	0x04 (4 <sub>dec</sub> )
	1C13:01	SubIndex 001	RW	0x1A00 (6656 <sub>dec</sub> )
	1C13:02	SubIndex 002	RW	0x1A01 (6657 <sub>dec</sub> )
	1C13:03	SubIndex 003	RW	0x1A02 (6658 <sub>dec</sub> )
	1C13:04	SubIndex 004	RW	0x1A03 (6659 <sub>dec</sub> )
	1C13:05	SubIndex 005	RW	0x0000 (0 <sub>dec</sub> )
	1C13:06	SubIndex 006	RW	0x0000 (0 <sub>dec</sub> )
	1C13:07	SubIndex 007	RW	0x0000 (0 <sub>dec</sub> )
	1C13:08	SubIndex 008	RW	0x0000 (0 <sub>dec</sub> )
	1C13:09	SubIndex 009	RW	0x0000 (0 <sub>dec</sub> )
	1C13:0A	SubIndex 010	RW	0x0000 (0 <sub>dec</sub> )
	1C13:0B	SubIndex 011	RW	0x0000 (0 <sub>dec</sub> )
	1C13:0C	SubIndex 012	RW	0x0000 (0 <sub>dec</sub> )
	1C13:0D	SubIndex 013	RW	0x0000 (0 <sub>dec</sub> )
	1C13:0E	SubIndex 014	RW	0x0000 (0 <sub>dec</sub> )
	1C13:0F	SubIndex 015	RW	0x0000 (0 <sub>dec</sub> )
	1C13:10	SubIndex 016	RW	0x0000 (0 <sub>dec</sub> )
	1C13:11	SubIndex 017	RW	0x0000 (0 <sub>dec</sub> )

Index	Name	Flags	Default value	
	1C13:12	SubIndex 018	RW	0x0000 (0 <sub>dec</sub> )
	1C13:13	SubIndex 019	RW	0x0000 (0 <sub>dec</sub> )
	1C13:14	SubIndex 020	RW	0x0000 (0 <sub>dec</sub> )
	1C13:15	SubIndex 021	RW	0x0000 (0 <sub>dec</sub> )
	1C13:16	SubIndex 022	RW	0x0000 (0 <sub>dec</sub> )
	1C13:17	SubIndex 023	RW	0x0000 (0 <sub>dec</sub> )
	1C13:18	SubIndex 024	RW	0x0000 (0 <sub>dec</sub> )
	1C13:19	SubIndex 025	RW	0x0000 (0 <sub>dec</sub> )
	1C13:1A	SubIndex 026	RW	0x0000 (0 <sub>dec</sub> )
	1C13:1B	SubIndex 027	RW	0x0000 (0 <sub>dec</sub> )
	1C13:1C	SubIndex 028	RW	0x0000 (0 <sub>dec</sub> )
	1C13:1D	SubIndex 029	RW	0x0000 (0 <sub>dec</sub> )
	1C13:1E	SubIndex 030	RW	0x0000 (0 <sub>dec</sub> )
	1C13:1F	SubIndex 031	RW	0x0000 (0 <sub>dec</sub> )
	1C13:20	SubIndex 032	RW	0x0000 (0 <sub>dec</sub> )
	1C13:21	SubIndex 033	RW	0x0000 (0 <sub>dec</sub> )
	1C13:22	SubIndex 034	RW	0x0000 (0 <sub>dec</sub> )
	1C13:23	SubIndex 035	RW	0x0000 (0 <sub>dec</sub> )
	1C13:24	SubIndex 036	RW	0x0000 (0 <sub>dec</sub> )
	1C13:25	SubIndex 037	RW	0x0000 (0 <sub>dec</sub> )
	1C13:26	SubIndex 038	RW	0x0000 (0 <sub>dec</sub> )
	1C13:27	SubIndex 039	RW	0x0000 (0 <sub>dec</sub> )
	1C13:28	SubIndex 040	RW	0x0000 (0 <sub>dec</sub> )
	1C13:29	SubIndex 041	RW	0x0000 (0 <sub>dec</sub> )
1C32:0 <a href="#">▶ 186</a>	SubIndex	SM output parameter	RO	0x20 (32 <sub>dec</sub> )
	1C32:01	Sync mode	RW	0x0001 (1 <sub>dec</sub> )
	1C32:02	Cycle time	RW	0x000F4240 (1000000 <sub>dec</sub> )
	1C32:03	Shift time	RO	0x00000000 (0 <sub>dec</sub> )
	1C32:04	Sync modes supported	RO	0x440B (17419 <sub>dec</sub> )
	1C32:05	Minimum cycle time	RO	0x000249F0 (150000 <sub>dec</sub> )
	1C32:06	Calc and copy time	RO	0x00000000 (0 <sub>dec</sub> )
	1C32:07	Minimum delay time	RO	0x00000000 (0 <sub>dec</sub> )
	1C32:08	Get Cycle Time	RW	0x0000 (0 <sub>dec</sub> )
	1C32:09	Maximum delay time	RO	0x00000000 (0 <sub>dec</sub> )
	1C32:0B	SM event missed counter	RO	0x0000 (0 <sub>dec</sub> )
	1C32:0C	Cycle exceeded counter	RO	0x0000 (0 <sub>dec</sub> )
	1C32:0D	Shift too short counter	RO	0x0000 (0 <sub>dec</sub> )
	1C32:20	Sync error	RO	0x00 (0 <sub>dec</sub> )
1C33:0 <a href="#">▶ 187</a>	SubIndex	SM input parameter	RO	0x20 (32 <sub>dec</sub> )
	1C33:01	Sync mode	RW	0x0022 (34 <sub>dec</sub> )
	1C33:02	Cycle time	RW	0x000F4240 (1000000 <sub>dec</sub> )
	1C33:03	Shift time	RO	0x000249F0 (150000 <sub>dec</sub> )
	1C33:04	Sync modes supported	RO	0x440B (17419 <sub>dec</sub> )
	1C33:05	Minimum cycle time	RO	0x000249F0 (150000 <sub>dec</sub> )
	1C33:06	Calc and copy time	RO	0x00000000 (0 <sub>dec</sub> )
	1C33:07	Minimum delay time	RO	0x00000000 (0 <sub>dec</sub> )
	1C33:08	Get Cycle Time	RW	0x0000 (0 <sub>dec</sub> )
	1C33:09	Maximum delay time	RO	0x00000000 (0 <sub>dec</sub> )
	1C33:0B	SM event missed counter	RO	0x0000 (0 <sub>dec</sub> )
	1C33:0C	Cycle exceeded counter	RO	0x0000 (0 <sub>dec</sub> )
	1C33:0D	Shift too short counter	RO	0x0000 (0 <sub>dec</sub> )
	1C33:20	Sync error	RO	0x00 (0 <sub>dec</sub> )
6000:0 <a href="#">▶ 188</a>	SubIndex	DI Input Ch.01	RO	0x01 (1 <sub>dec</sub> )
	6000:01▲	Input	RO	0x00 (0 <sub>dec</sub> )
6001:0 <a href="#">▶ 188</a>	SubIndex	DI Diagnosis Ch.01	RO	0x01 (1 <sub>dec</sub> )
	6001:01	Wirebreak	RO	0x00 (0 <sub>dec</sub> )
6010:0 <a href="#">▶ 188</a>	SubIndex	DI Input Ch.02	RO	0x01 (1 <sub>dec</sub> )
	6010:01	Input	RO	0x00 (0 <sub>dec</sub> )

Index		Name	Flags	Default value
6011:0 [▶ 188]	SubIndex	DI Diagnosis Ch.02	RO	0x01 (1 <sub>dec</sub> )
	6011:01	Wirebreak	RO	0x00 (0 <sub>dec</sub> )
6020:0 [▶ 188]	SubIndex	DI Input Ch.03	RO	0x01 (1 <sub>dec</sub> )
	6020:01	Input	RO	0x00 (0 <sub>dec</sub> )
6021:0 [▶ 188]	SubIndex	DI Diagnosis Ch.03	RO	0x01 (1 <sub>dec</sub> )
	6021:01	Wirebreak	RO	0x00 (0 <sub>dec</sub> )
6030:0 [▶ 188]	SubIndex	DI Input Ch.04	RO	0x01 (1 <sub>dec</sub> )
	6030:01	Input	RO	0x00 (0 <sub>dec</sub> )
6031:0 [▶ 188]	SubIndex	DI Diagnosis Ch.04	RO	0x01 (1 <sub>dec</sub> )
	6031:01	Wirebreak	RO	0x00 (0 <sub>dec</sub> )
6040:0 [▶ 188]	SubIndex	DI Input Ch.05	RO	0x01 (1 <sub>dec</sub> )
	6040:01	Input	RO	0x00 (0 <sub>dec</sub> )
6041:0 [▶ 188]	SubIndex	DI Diagnosis Ch.05	RO	0x01 (1 <sub>dec</sub> )
	6041:01	Wirebreak	RO	0x00 (0 <sub>dec</sub> )
6050:0 [▶ 188]	SubIndex	DI Input Ch.06	RO	0x01 (1 <sub>dec</sub> )
	6050:01	Input	RO	0x00 (0 <sub>dec</sub> )
6051:0 [▶ 188]	SubIndex	DI Diagnosis Ch.06	RO	0x01 (1 <sub>dec</sub> )
	6051:01	Wirebreak	RO	0x00 (0 <sub>dec</sub> )
6060:0 [▶ 189]	SubIndex	DI Input Ch.07	RO	0x01 (1 <sub>dec</sub> )
	6060:01	Input	RO	0x00 (0 <sub>dec</sub> )
6061:0 [▶ 189]	SubIndex	DI Diagnosis Ch.07	RO	0x01 (1 <sub>dec</sub> )
	6061:01	Wirebreak	RO	0x00 (0 <sub>dec</sub> )
6070:0 [▶ 189]	SubIndex	DI Input Ch.08	RO	0x01 (1 <sub>dec</sub> )
	6070:01	Input	RO	0x00 (0 <sub>dec</sub> )
6071:0 [▶ 189]	SubIndex	DI Diagnosis Ch.08	RO	0x01 (1 <sub>dec</sub> )
	6071:01	Wirebreak	RO	0x00 (0 <sub>dec</sub> )
6080:0 [▶ 189]	SubIndex	DI Input Ch.09	RO	0x01 (1 <sub>dec</sub> )
	6080:01	Input	RO	0x00 (0 <sub>dec</sub> )
6081:0 [▶ 189]	SubIndex	DI Diagnosis Ch.09	RO	0x01 (1 <sub>dec</sub> )
	6081:01	Wirebreak	RO	0x00 (0 <sub>dec</sub> )
6090:0 [▶ 189]	SubIndex	DI Input Ch.10	RO	0x01 (1 <sub>dec</sub> )
	6090:01	Input	RO	0x00 (0 <sub>dec</sub> )
6091:0 [▶ 189]	SubIndex	DI Diagnosis Ch.10	RO	0x01 (1 <sub>dec</sub> )
	6091:01	Wirebreak	RO	0x00 (0 <sub>dec</sub> )
60A0:0 [▶ 189]	SubIndex	DI Input Ch.11	RO	0x01 (1 <sub>dec</sub> )
	60A0:01	Input	RO	0x00 (0 <sub>dec</sub> )
60A1:0 [▶ 189]	SubIndex	DI Diagnosis Ch.11	RO	0x01 (1 <sub>dec</sub> )
	60A1:01	Wirebreak	RO	0x00 (0 <sub>dec</sub> )
60B0:0 [▶ 189]	SubIndex	DI Input Ch.12	RO	0x01 (1 <sub>dec</sub> )
	60B0:01	Input	RO	0x00 (0 <sub>dec</sub> )
60B1:0 [▶ 189]	SubIndex	DI Diagnosis Ch.12	RO	0x01 (1 <sub>dec</sub> )
	60B1:01	Wirebreak	RO	0x00 (0 <sub>dec</sub> )
60C0:0 [▶ 189]	SubIndex	DI Input Ch.13	RO	0x01 (1 <sub>dec</sub> )
	60C0:01	Input	RO	0x00 (0 <sub>dec</sub> )
60C1 [▶ 190]:0	SubIndex	DI Diagnosis Ch.13	RO	0x01 (1 <sub>dec</sub> )
	60C1:01	Wirebreak	RO	0x00 (0 <sub>dec</sub> )
60D0:0 [▶ 190]	SubIndex	DI Input Ch.14	RO	0x01 (1 <sub>dec</sub> )
	60D0:01	Input	RO	0x00 (0 <sub>dec</sub> )
60D1:0 [▶ 190]	SubIndex	DI Diagnosis Ch.14	RO	0x01 (1 <sub>dec</sub> )
	60D1:01	Wirebreak	RO	0x00 (0 <sub>dec</sub> )
60E0 [▶ 190]:0	SubIndex	DI Input Ch.15	RO	0x01 (1 <sub>dec</sub> )
	60E0:01	Input	RO	0x00 (0 <sub>dec</sub> )
60E1 [▶ 190]:0	SubIndex	DI Diagnosis Ch.15	RO	0x01 (1 <sub>dec</sub> )
	60E1:01	Wirebreak	RO	0x00 (0 <sub>dec</sub> )
60F0 [▶ 190]:0	SubIndex	DI Input Ch.16	RO	0x01 (1 <sub>dec</sub> )
	60F0:01	Input	RO	0x00 (0 <sub>dec</sub> )
60F1 [▶ 190]:0	SubIndex	DI Diagnosis Ch.16	RO	0x01 (1 <sub>dec</sub> )
	60F1:01	Wirebreak	RO	0x00 (0 <sub>dec</sub> )

Index		Name	Flags	Default value
6102  190]:0	SubIndex	DO Diagnosis Ch.01	RO	0x04 (4 <sub>dec</sub> )
	6102:01	Overcurrent	RO	0x00 (0 <sub>dec</sub> )
	6102:02	Overload	RO	0x00 (0 <sub>dec</sub> )
	6102:03	Open load	RO	0x00 (0 <sub>dec</sub> )
	6102:04	Short to 24V	RO	0x00 (0 <sub>dec</sub> )
6112  190]:0	SubIndex	DO Diagnosis Ch.02	RO	0x04 (4 <sub>dec</sub> )
	6112:01	Overcurrent	RO	0x00 (0 <sub>dec</sub> )
	6112:02	Overload	RO	0x00 (0 <sub>dec</sub> )
	6112:03	Open load	RO	0x00 (0 <sub>dec</sub> )
	6112:04	Short to 24V	RO	0x00 (0 <sub>dec</sub> )
6122  190]:0	SubIndex	DO Diagnosis Ch.03	RO	0x04 (4 <sub>dec</sub> )
	6122:01	Overcurrent	RO	0x00 (0 <sub>dec</sub> )
	6122:02	Overload	RO	0x00 (0 <sub>dec</sub> )
	6122:03	Open load	RO	0x00 (0 <sub>dec</sub> )
	6122:04	Short to 24V	RO	0x00 (0 <sub>dec</sub> )
6132  191]:0	SubIndex	DO Diagnosis Ch.04	RO	0x04 (4 <sub>dec</sub> )
	6132:01	Overcurrent	RO	0x00 (0 <sub>dec</sub> )
	6132:02	Overload	RO	0x00 (0 <sub>dec</sub> )
	6132:03	Open load	RO	0x00 (0 <sub>dec</sub> )
	6132:04	Short to 24V	RO	0x00 (0 <sub>dec</sub> )
6142  191]:0	SubIndex	DO Diagnosis Ch.05	RO	0x04 (4 <sub>dec</sub> )
	6142:01	Overcurrent	RO	0x00 (0 <sub>dec</sub> )
	6142:02	Overload	RO	0x00 (0 <sub>dec</sub> )
	6142:03	Open load	RO	0x00 (0 <sub>dec</sub> )
	6142:04	Short to 24V	RO	0x00 (0 <sub>dec</sub> )
6152  191]:0	SubIndex	DO Diagnosis Ch.06	RO	0x04 (4 <sub>dec</sub> )
	6152:01	Overcurrent	RO	0x00 (0 <sub>dec</sub> )
	6152:02	Overload	RO	0x00 (0 <sub>dec</sub> )
	6152:03	Open load	RO	0x00 (0 <sub>dec</sub> )
	6152:04	Short to 24V	RO	0x00 (0 <sub>dec</sub> )
6162  191]:0	SubIndex	DO Diagnosis Ch.07	RO	0x04 (4 <sub>dec</sub> )
	6162:01	Overcurrent	RO	0x00 (0 <sub>dec</sub> )
	6162:02	Overload	RO	0x00 (0 <sub>dec</sub> )
	6162:03	Open load	RO	0x00 (0 <sub>dec</sub> )
	6162:04	Short to 24V	RO	0x00 (0 <sub>dec</sub> )
6172  191]:0	SubIndex	DO Diagnosis Ch.08	RO	0x04 (4 <sub>dec</sub> )
	6172:01	Overcurrent	RO	0x00 (0 <sub>dec</sub> )
	6172:02	Overload	RO	0x00 (0 <sub>dec</sub> )
	6172:03	Open load	RO	0x00 (0 <sub>dec</sub> )
	6172:04	Short to 24V	RO	0x00 (0 <sub>dec</sub> )
7100  191]:0	SubIndex	DO Output Ch.01	RO	0x01 (1 <sub>dec</sub> )
	7100:01	Output	RO	0x00 (0 <sub>dec</sub> )
7110  191]:0	SubIndex	DO Output Ch.02	RO	0x01 (1 <sub>dec</sub> )
	7110:01	Output	RO	0x00 (0 <sub>dec</sub> )
7120  191]:0	SubIndex	DO Output Ch.03	RO	0x01 (1 <sub>dec</sub> )
	7120:01	Output	RO	0x00 (0 <sub>dec</sub> )
7130  191]:0	SubIndex	DO Output Ch.04	RO	0x01 (1 <sub>dec</sub> )
	7130:01	Output	RO	0x00 (0 <sub>dec</sub> )
7140  192]:0	SubIndex	DO Output Ch.05	RO	0x01 (1 <sub>dec</sub> )
	7140:01	Output	RO	0x00 (0 <sub>dec</sub> )
7150  192]:0	SubIndex	DO Output Ch.06	RO	0x01 (1 <sub>dec</sub> )
	7150:01	Output	RO	0x00 (0 <sub>dec</sub> )
7160  192]:0	SubIndex	DO Output Ch.07	RO	0x01 (1 <sub>dec</sub> )
	7160:01	Output	RO	0x00 (0 <sub>dec</sub> )
7170  192]:0	SubIndex	DO Output Ch.08	RO	0x01 (1 <sub>dec</sub> )
	7170:01	Output	RO	0x00 (0 <sub>dec</sub> )
8000:0  192]	SubIndex	DI Settings Ch.01	RW	0x12 (18 <sub>dec</sub> )
	8000:01	Enable open load detection	RW	0x00 (0 <sub>dec</sub> )

Index		Name	Flags	Default value
	8000:11	Filter time	RW	0x0000 (0 <sub>dec</sub> )
	8000:12	Signal extension time	RW	0x0000 (0 <sub>dec</sub> )
8010:0 [▶ 192]	SubIndex	DI Settings Ch.02	RW	0x12 (18 <sub>dec</sub> )
	8010:01	Enable open load detection	RW	0x00 (0 <sub>dec</sub> )
	8010:11	Filter time	RW	0x0000 (0 <sub>dec</sub> )
	8010:12	Signal extension time	RW	0x0000 (0 <sub>dec</sub> )
8020:0 [▶ 192]	SubIndex	DI Settings Ch.03	RW	0x12 (18 <sub>dec</sub> )
	8020:01	Enable open load detection	RW	0x00 (0 <sub>dec</sub> )
	8020:11	Filter time	RW	0x0000 (0 <sub>dec</sub> )
	8020:12	Signal extension time	RW	0x0000 (0 <sub>dec</sub> )
8030:0 [▶ 193]	SubIndex	DI Settings Ch.04	RW	0x12 (18 <sub>dec</sub> )
	8030:01	Enable open load detection	RW	0x00 (0 <sub>dec</sub> )
	8030:11	Filter time	RW	0x0000 (0 <sub>dec</sub> )
	8030:12	Signal extension time	RW	0x0000 (0 <sub>dec</sub> )
8040:0 [▶ 193]	SubIndex	DI Settings Ch.05	RW	0x12 (18 <sub>dec</sub> )
	8040:01	Enable open load detection	RW	0x00 (0 <sub>dec</sub> )
	8040:11	Filter time	RW	0x0000 (0 <sub>dec</sub> )
	8040:12	Signal extension time	RW	0x0000 (0 <sub>dec</sub> )
8050:0 [▶ 193]	SubIndex	DI Settings Ch.06	RW	0x12 (18 <sub>dec</sub> )
	8050:01	Enable open load detection	RW	0x00 (0 <sub>dec</sub> )
	8050:11	Filter time	RW	0x0000 (0 <sub>dec</sub> )
	8050:12	Signal extension time	RW	0x0000 (0 <sub>dec</sub> )
8060:0 [▶ 193]	SubIndex	DI Settings Ch.07	RW	0x12 (18 <sub>dec</sub> )
	8060:01	Enable open load detection	RW	0x00 (0 <sub>dec</sub> )
	8060:11	Filter time	RW	0x0000 (0 <sub>dec</sub> )
	8060:12	Signal extension time	RW	0x0000 (0 <sub>dec</sub> )
8070:0 [▶ 193]	SubIndex	DI Settings Ch.08	RW	0x12 (18 <sub>dec</sub> )
	8070:01	Enable open load detection	RW	0x00 (0 <sub>dec</sub> )
	8070:11	Filter time	RW	0x0000 (0 <sub>dec</sub> )
	8070:12	Signal extension time	RW	0x0000 (0 <sub>dec</sub> )
8080:0 [▶ 194]	SubIndex	DI Settings Ch.09	RW	0x12 (18 <sub>dec</sub> )
	8080:01	Enable open load detection	RW	0x00 (0 <sub>dec</sub> )
	8080:11	Filter time	RW	0x0000 (0 <sub>dec</sub> )
	8080:12	Signal extension time	RW	0x0000 (0 <sub>dec</sub> )
8090:0 [▶ 194]	SubIndex	DI Settings Ch.10	RW	0x12 (18 <sub>dec</sub> )
	8090:01	Enable open load detection	RW	0x00 (0 <sub>dec</sub> )
	8090:11	Filter time	RW	0x0000 (0 <sub>dec</sub> )
	8090:12	Signal extension time	RW	0x0000 (0 <sub>dec</sub> )
80A0:0 [▶ 194]	SubIndex	DI Settings Ch.11	RW	0x12 (18 <sub>dec</sub> )
	80A00:01	Enable open load detection	RW	0x00 (0 <sub>dec</sub> )
	80A00:11	Filter time	RW	0x0000 (0 <sub>dec</sub> )
	80A00:12	Signal extension time	RW	0x0000 (0 <sub>dec</sub> )
80B0:0 [▶ 194]	SubIndex	DI Settings Ch.12	RW	0x12 (18 <sub>dec</sub> )
	80B00:01	Enable open load detection	RW	0x00 (0 <sub>dec</sub> )
	80B00:11	Filter time	RW	0x0000 (0 <sub>dec</sub> )
	80B00:12	Signal extension time	RW	0x0000 (0 <sub>dec</sub> )
80C0:0 [▶ 194]	SubIndex	DI Settings Ch.13	RW	0x12 (18 <sub>dec</sub> )
	80C00:01	Enable open load detection	RW	0x00 (0 <sub>dec</sub> )
	80C00:11	Filter time	RW	0x0000 (0 <sub>dec</sub> )
	80C00:12	Signal extension time	RW	0x0000 (0 <sub>dec</sub> )
80D0:0 [▶ 195]	SubIndex	DI Settings Ch.14	RW	0x12 (18 <sub>dec</sub> )
	80D00:01	Enable open load detection	RW	0x00 (0 <sub>dec</sub> )
	80D00:11	Filter time	RW	0x0000 (0 <sub>dec</sub> )
	80D00:12	Signal extension time	RW	0x0000 (0 <sub>dec</sub> )
80E0:0 [▶ 195]	SubIndex	DI Settings Ch.15	RW	0x12 (18 <sub>dec</sub> )
	80E00:01	Enable open load detection	RW	0x00 (0 <sub>dec</sub> )
	80E00:11	Filter time	RW	0x0000 (0 <sub>dec</sub> )
	80E00:12	Signal extension time	RW	0x0000 (0 <sub>dec</sub> )

Index		Name	Flags	Default value
80F0:0 [▶ 195]	SubIndex	DI Settings Ch.16	RW	0x12 (18 <sub>dec</sub> )
	80F00:01	Enable open load detection	RW	0x00 (0 <sub>dec</sub> )
	80F00:11	Filter time	RW	0x0000 (0 <sub>dec</sub> )
	80F00:12	Signal extension time	RW	0x0000 (0 <sub>dec</sub> )
8100:0 [▶ 195]	SubIndex	DO Settings Ch.01	RW	0x06 (6 <sub>dec</sub> )
	8100:01	Detect openload in off state	RW	0x00 (0 <sub>dec</sub> )
	8100:02	Detect openload in on state	RW	0x00 (0 <sub>dec</sub> )
	8100:03	Detect short to 24V	RW	0x00 (0 <sub>dec</sub> )
	8100:04	Safe state active	RW	0x01 (1 <sub>dec</sub> )
	8100:05	Safe state value	RW	0x00 (0 <sub>dec</sub> )
8110:0 [▶ 196]	SubIndex	DO Settings Ch.02	RW	0x06 (6 <sub>dec</sub> )
	8110:01	Detect openload in off state	RW	0x00 (0 <sub>dec</sub> )
	8110:02	Detect openload in on state	RW	0x00 (0 <sub>dec</sub> )
	8110:03	Detect short to 24V	RW	0x00 (0 <sub>dec</sub> )
	8110:04	Safe state active	RW	0x01 (1 <sub>dec</sub> )
	8110:05	Safe state value	RW	0x00 (0 <sub>dec</sub> )
8120:0 [▶ 196]	SubIndex	DO Settings Ch.03	RW	0x06 (6 <sub>dec</sub> )
	8120:01	Detect openload in off state	RW	0x00 (0 <sub>dec</sub> )
	8120:02	Detect openload in on state	RW	0x00 (0 <sub>dec</sub> )
	8120:03	Detect short to 24V	RW	0x00 (0 <sub>dec</sub> )
	8120:04	Safe state active	RW	0x01 (1 <sub>dec</sub> )
	8120:05	Safe state value	RW	0x00 (0 <sub>dec</sub> )
8130:0 [▶ 196]	SubIndex	DO Settings Ch.04	RW	0x06 (6 <sub>dec</sub> )
	8130:01	Detect openload in off state	RW	0x00 (0 <sub>dec</sub> )
	8130:02	Detect openload in on state	RW	0x00 (0 <sub>dec</sub> )
	8130:03	Detect short to 24V	RW	0x00 (0 <sub>dec</sub> )
	8130:04	Safe state active	RW	0x01 (1 <sub>dec</sub> )
	8130:05	Safe state value	RW	0x00 (0 <sub>dec</sub> )
8140:0 [▶ 197]	SubIndex	DO Settings Ch.05	RW	0x06 (6 <sub>dec</sub> )
	8140:01	Detect openload in off state	RW	0x00 (0 <sub>dec</sub> )
	8140:02	Detect openload in on state	RW	0x00 (0 <sub>dec</sub> )
	8140:03	Detect short to 24V	RW	0x00 (0 <sub>dec</sub> )
	8140:04	Safe state active	RW	0x01 (1 <sub>dec</sub> )
	8140:05	Safe state value	RW	0x00 (0 <sub>dec</sub> )
8150:0 [▶ 197]	SubIndex	DO Settings Ch.06	RW	0x06 (6 <sub>dec</sub> )
	8150:01	Detect openload in off state	RW	0x00 (0 <sub>dec</sub> )
	8150:02	Detect openload in on state	RW	0x00 (0 <sub>dec</sub> )
	8150:03	Detect short to 24V	RW	0x00 (0 <sub>dec</sub> )
	8150:04	Safe state active	RW	0x01 (1 <sub>dec</sub> )
	8150:05	Safe state value	RW	0x00 (0 <sub>dec</sub> )
8160:0 [▶ 197]	SubIndex	DO Settings Ch.07	RW	0x06 (6 <sub>dec</sub> )
	8160:01	Detect openload in off state	RW	0x00 (0 <sub>dec</sub> )
	8160:02	Detect openload in on state	RW	0x00 (0 <sub>dec</sub> )
	8160:03	Detect short to 24V	RW	0x00 (0 <sub>dec</sub> )
	8160:04	Safe state active	RW	0x01 (1 <sub>dec</sub> )
	8160:05	Safe state value	RW	0x00 (0 <sub>dec</sub> )
8170:0 [▶ 198]	SubIndex	DO Settings Ch.08	RW	0x06 (6 <sub>dec</sub> )
	8170:01	Detect openload in off state	RW	0x00 (0 <sub>dec</sub> )
	8170:02	Detect openload in on state	RW	0x00 (0 <sub>dec</sub> )
	8170:03	Detect short to 24V	RW	0x00 (0 <sub>dec</sub> )
	8170:04	Safe state active	RW	0x01 (1 <sub>dec</sub> )



Index	Name	Flags	Default value
	8170:05	RW	0x00 (0 <sub>dec</sub> )
	8170:06	RW	0x01 (1 <sub>dec</sub> )
F000:0 [▶ 198]	SubIndex	RO	0x02 (2 <sub>dec</sub> )
	F000:01	RO	0x0010 (16 <sub>dec</sub> )
	F000:02	RO	0x0018 (24 <sub>dec</sub> )
F008 [▶ 198]	Code word	RW	0x00000000 (0 <sub>dec</sub> )
F010:0 [▶ 199]	SubIndex	RO	0x18 (24 <sub>dec</sub> )
	F010:01	RO	0x00000064 (100 <sub>dec</sub> )
	F010:02	RO	0x00000064 (100 <sub>dec</sub> )
	F010:03	RO	0x00000064 (100 <sub>dec</sub> )
	F010:04	RO	0x00000064 (100 <sub>dec</sub> )
	F010:05	RO	0x00000064 (100 <sub>dec</sub> )
	F010:06	RO	0x00000064 (100 <sub>dec</sub> )
	F010:07	RO	0x00000064 (100 <sub>dec</sub> )
	F010:08	RO	0x00000064 (100 <sub>dec</sub> )
	F010:09	RO	0x00000064 (100 <sub>dec</sub> )
	F010:0A	RO	0x00000064 (100 <sub>dec</sub> )
	F010:0B	RO	0x00000064 (100 <sub>dec</sub> )
	F010:0C	RO	0x00000064 (100 <sub>dec</sub> )
	F010:0D	RO	0x00000064 (100 <sub>dec</sub> )
	F010:0E	RO	0x00000064 (100 <sub>dec</sub> )
	F010:0F	RO	0x00000064 (100 <sub>dec</sub> )
	F010:10	RO	0x00000064 (100 <sub>dec</sub> )
	F010:11	RO	0x000000C8 (200 <sub>dec</sub> )
	F010:12	RO	0x000000C8 (200 <sub>dec</sub> )
	F010:13	RO	0x000000C8 (200 <sub>dec</sub> )
	F010:14	RO	0x000000C8 (200 <sub>dec</sub> )
	F010:15	RO	0x000000C8 (200 <sub>dec</sub> )
	F010:16	RO	0x000000C8 (200 <sub>dec</sub> )
	F010:17	RO	0x000000C8 (200 <sub>dec</sub> )
	F010:18	RO	0x000000C8 (200 <sub>dec</sub> )
F600:0 [▶ 199]	SubIndex	RO	0x0F (15 <sub>dec</sub> )
	F600:01	RO	0x00 (0 <sub>dec</sub> )
	F600:03	RO	0x00 (0 <sub>dec</sub> )
	F600:0D	RO	0x00 (0 <sub>dec</sub> )
	F600:0E	RO	0x00 (0 <sub>dec</sub> )
	F600:0F	RO	0x00 (0 <sub>dec</sub> )
F900:0 [▶ 199]	SubIndex	RO	0x04 (4 <sub>dec</sub> )
	F900:02	RO	0x00 (0 <sub>dec</sub> )
	F900:04	RO	0x0000 (0 <sub>dec</sub> )
FB00:0 [▶ 199]	SubIndex	RO	0x03 (3 <sub>dec</sub> )
	FB00:01	RW	{0}
	FB00:02	RO	0x00 (0 <sub>dec</sub> )
	FB00:03	RO	{0}

**Key**

**Flags:**

RO (Read Only): this object can only be read

RW (Read/Write): this object can be read and written to

## 7.7 EP1839-0042 - Object description and parameterization

### Parameterization

You can parameterize the box via the "CoE - Online" tab in TwinCAT.

### EtherCAT XML Device Description

The presentation matches that of the EtherCAT XML Device Description.

Recommendation: download the latest XML file from <https://www.beckhoff.com/> and install it according to the installation instructions.

### 7.7.1 Standard objects (0x1000-0x1FFF)

The standard objects have the same meaning for all EtherCAT slaves.

Index (hex)	Name	Meaning	Data type	Flags	Default
1000:0	Device type	Device type of the EtherCAT device: the Lo-Word contains the used CoE profile (5001). The Hi-Word contains the module profile according to the modular device profile.	UINT32	RO	0x00001389 (5001 <sub>dec</sub> )

Index (hex)	Name	Meaning	Data type	Flags	Default
1008:0	Device name	Name of the EtherCAT device	STRING	RO	EP1839-0042

Index (hex)	Name	Meaning	Data type	Flags	Default
1009:0	Hardware version	Hardware version of the EtherCAT device	STRING	RO	

Index (hex)	Name	Meaning	Data type	Flags	Default
100A:0	Software version	Firmware version of the EtherCAT device	STRING	RO	02

Index (hex)	Name	Meaning	Data type	Flags	Default
100B:0	Bootloader version	Bootloader version of the EtherCAT device	STRING	RO	N/A

Index (hex)	Name	Meaning	Data type	Flags	Default
1011:0	Restore default parameters	Restore default settings	UINT8	RO	0x01 (1 <sub>dec</sub> )
1011:01	SubIndex 001	If this object is set to " <b>0x64616F6C</b> " in the set value dialog, all backup objects are reset to their delivery state.	UINT32	RW	0x00000000 (0 <sub>dec</sub> )

Index (hex)	Name	Meaning	Data type	Flags	Default
1018:0	Identity	Information for identifying the slave	UINT8	RO	0x04 (4 <sub>dec</sub> )
1018:01	Vendor ID	Vendor ID of the EtherCAT slave	UINT32	RO	0x00000002 (2 <sub>dec</sub> )
1018:02	Product code	Product code of the EtherCAT slave	UINT32	RO	0x072F4052 (120537170 <sub>dec</sub> )
1018:03	Revision	Revision number of the EtherCAT slave; the Low Word (bit 0-15) indicates the special terminal number, the High Word (bit 16-31) refers to the device description	UINT32	RO	0x00000000 (0 <sub>dec</sub> )
1018:04	Serial number	Serial number of the EtherCAT slave; the Low Byte (bit 0-7) of the Low Word contains the year of production, the High Byte (bit 8-15) of the Low Word contains the week of production, the High Word (bit 16-31) is 0	UINT32	RO	0x00000000 (0 <sub>dec</sub> )

Index (hex)	Name	Meaning	Data type	Flags	Default
10E2:0	Manufacturer-specific Identification Code	Maximum subindex	UINT8	RO	0x01 (1 <sub>dec</sub> )
10E2:01	SubIndex 001	reserved	STRING	RO	

Index (hex)	Name	Meaning	Data type	Flags	Default
10F0:0	Backup parameter handling	Information for standardized loading and saving of backup entries	UINT8	RO	0x01 (1 <sub>dec</sub> )
10F00:01	Checksum	Checksum across all backup entries of the EtherCAT slave	UINT32	RO	0x00000000 (0 <sub>dec</sub> )

**Index 10F3 Diagnosis History**

Index (hex)	Name	Meaning	Data type	Flags	Default
10F3:0	Diagnosis History	Maximum subindex	UINT8	RO	0x15 (21 <sub>dec</sub> )
10F3:01	Maximum Messages	Maximum number of stored messages A maximum of 16 messages can be stored	UINT8	RO	0x00 (0 <sub>dec</sub> )
10F3:02	Newest Message	Subindex of the latest message	UINT8	RO	0x00 (0 <sub>dec</sub> )
10F3:03	Newest Acknowledged Message	Subindex of the last confirmed message	UINT8	RW	0x00 (0 <sub>dec</sub> )
10F3:04	New Messages Available	Indicates that a new message is available	BOOLEAN	RO	0x00 (0 <sub>dec</sub> )
10F3:05	Flags	not used	UINT16	RW	0x0000 (0 <sub>dec</sub> )
10F3:06	Diagnosis Message 001	Message 1	OCTET-STRING[20]	RO	{0}
...	...	..	...	...	...
10F3:15	Diagnosis Message 016	Message 16	OCTET-STRING[20]	RO	{0}

Index (hex)	Name	Meaning	Data type	Flags	Default
10F8:0	Timestamp Object	Timestamp	UINT64	RO	

Index (hex)	Name	Meaning	Data type	Flags	Default
10F9:0	Time Distribution Object	Maximum subindex	UINT8	RO	0x01 (1 <sub>dec</sub> )
10F9:01	Distributed Time Value	Object for time distribution by the EtherCAT master.	UINT64	RW	

Index (hex)	Name	Meaning	Data type	Flags	Default
1602:0	DO 1 RxPDO-Map Output	PDO Mapping RxPDO 3	UINT8	RO	0x08 (8 <sub>dec</sub> )
1602:01	SubIndex 001	1. PDO Mapping entry (object 0x7100 (DO Output Ch.01), entry 0x01 (Output))	UINT32	RO	0x7100:01, 1
1602:02	SubIndex 002	2. PDO Mapping entry (object 0x7110 (DO Output Ch.02), entry 0x01 (Output))	UINT32	RO	0x7110:01, 1
1602:03	SubIndex 003	3. PDO Mapping entry (object 0x7120 (DO Output Ch.03), entry 0x01 (Output))	UINT32	RO	0x7120:01, 1
1602:04	SubIndex 004	4. PDO Mapping entry (object 0x7130 (DO Output Ch.04), entry 0x01 (Output))	UINT32	RO	0x7130:01, 1
1602:05	SubIndex 005	5. PDO Mapping entry (object 0x7140 (DO Output Ch.05), entry 0x01 (Output))	UINT32	RO	0x7140:01, 1
1602:06	SubIndex 006	6. PDO Mapping entry (object 0x7150 (DO Output Ch.06), entry 0x01 (Output))	UINT32	RO	0x7150:01, 1
1602:07	SubIndex 007	7. PDO Mapping entry (object 0x7160 (DO Output Ch.07), entry 0x01 (Output))	UINT32	RO	0x7160:01, 1
1602:08	SubIndex 008	8. PDO Mapping entry (object 0x7170 (DO Output Ch.08), entry 0x01 (Output))	UINT32	RO	0x7170:01, 1

Index (hex)	Name	Meaning	Data type	Flags	Default
1A00:0	DI TxPDO-Map Input	PDO Mapping TxPDO 1	UINT8	RO	0x10 (16 <sub>dec</sub> )
1A00:01	SubIndex 001	1. PDO Mapping entry (object 0x6000 (Input Ch.01), entry 0x00 (Input Ch.01))	UINT32	RO	0x6000:01, 1
1A00:02	SubIndex 002	2. PDO Mapping entry (object 0x6010 (DI Input Ch.02), entry 0x01 (Input))	UINT32	RO	0x6010:01, 1
1A00:03	SubIndex 003	3. PDO Mapping entry (object 0x6020 (DI Input Ch.03), entry 0x01 (Input))	UINT32	RO	0x6020:01, 1
1A00:04	SubIndex 004	4. PDO Mapping entry (object 0x6030 (DI Input Ch.04), entry 0x01 (Input))	UINT32	RO	0x6030:01, 1
1A00:05	SubIndex 005	5. PDO Mapping entry (object 0x6040 (DI Input Ch.05), entry 0x01 (Input))	UINT32	RO	0x6040:01, 1
1A00:06	SubIndex 006	6. PDO Mapping entry (object 0x6050 (DI Input Ch.06), entry 0x01 (Input))	UINT32	RO	0x6050:01, 1
1A00:07	SubIndex 007	7. PDO Mapping entry (object 0x6060 (DI Input Ch.07), entry 0x01 (Input))	UINT32	RO	0x6060:01, 1
1A00:08	SubIndex 008	8. PDO Mapping entry (object 0x6070 (DI Input Ch.08), entry 0x01 (Input))	UINT32	RO	0x6070:01, 1
1A00:09	SubIndex 009	9. PDO Mapping entry (object 0x6080 (DI Input Ch.09), entry 0x01 (Input))	UINT32	RO	0x6080:01, 1
1A00:0A	SubIndex 010	10. PDO Mapping entry (object 0x6090 (DI Input Ch.10), entry 0x01 (Input))	UINT32	RO	0x6090:01, 1
1A00:0B	SubIndex 011	11. PDO Mapping entry (object 0x60A0 (DI Input Ch.11), entry 0x01 (Input))	UINT32	RO	0x60A0:01, 1
1A00:0C	SubIndex 012	12. PDO Mapping entry (object 0x60B0 (DI Input Ch.12), entry 0x01 (Input))	UINT32	RO	0x60B0:01, 1
1A00:0D	SubIndex 013	13. PDO Mapping entry (object 0x60C0 (DI Input Ch.13), entry 0x01 (Input))	UINT32	RO	0x60C0:01, 1
1A00:0E	SubIndex 014	14. PDO Mapping entry (object 0x60D0 (DI Input Ch.14), entry 0x01 (Input))	UINT32	RO	0x60D0:01, 1
1A00:0F	SubIndex 015	15. PDO Mapping entry (object 0x60E0 (DI Input Ch.15), entry 0x01 (Input))	UINT32	RO	0x60E0:01, 1
1A00:10	SubIndex 016	16. PDO Mapping entry (object 0x60F0 (DI Input Ch.16), entry 0x01 (Input))	UINT32	RO	0x60F0:01, 1

Index (hex)	Name	Meaning	Data type	Flags	Default
1A01:0	DI TxPDO-Map Diagnosis	PDO Mapping TxPDO 2	UINT8	RO	0x10 (16 <sub>dec</sub> )
1A01:01	SubIndex 001	1. PDO Mapping entry (object 0x6000 (Input Ch.01), entry 0x00 (Input Ch.01))	UINT32	RO	0x6001:01, 1
1A01:02	SubIndex 002	2. PDO Mapping entry (object 0x6001 (Wirebreak Ch.01), entry 0x00 (Wirebreak Ch.01))	UINT32	RO	0x6011:01, 1
1A01:03	SubIndex 003	3. PDO Mapping entry (object 0x6021 (DI Diagnosis Ch.03), entry 0x01 (Wirebreak))	UINT32	RO	0x6021:01, 1
1A01:04	SubIndex 004	4. PDO Mapping entry (object 0x6031 (DI Diagnosis Ch.04), entry 0x01 (Wirebreak))	UINT32	RO	0x6031:01, 1
1A01:05	SubIndex 005	5. PDO Mapping entry (object 0x6041 (DI Diagnosis Ch.05), entry 0x01 (Wirebreak))	UINT32	RO	0x6041:01, 1
1A01:06	SubIndex 006	6. PDO Mapping entry (object 0x6051 (DI Diagnosis Ch.06), entry 0x01 (Wirebreak))	UINT32	RO	0x6051:01, 1
1A01:07	SubIndex 007	7. PDO Mapping entry (object 0x6061 (DI Diagnosis Ch.07), entry 0x01 (Wirebreak))	UINT32	RO	0x6061:01, 1
1A01:08	SubIndex 008	8. PDO Mapping entry (object 0x6071 (DI Diagnosis Ch.08), entry 0x01 (Wirebreak))	UINT32	RO	0x6071:01, 1
1A01:09	SubIndex 009	9. PDO Mapping entry (object 0x6081 (DI Diagnosis Ch.09), entry 0x01 (Wirebreak))	UINT32	RO	0x6081:01, 1
1A01:0A	SubIndex 010	10. PDO Mapping entry (object 0x6091 (DI Diagnosis Ch.10), entry 0x01 (Wirebreak))	UINT32	RO	0x6091:01, 1
1A01:0B	SubIndex 011	11. PDO Mapping entry (object 0x60A1 (DI Diagnosis Ch.11), entry 0x01 (Wirebreak))	UINT32	RO	0x60A1:01, 1
1A01:0C	SubIndex 012	12. PDO Mapping entry (object 0x60B1 (DI Diagnosis Ch.12), entry 0x01 (Wirebreak))	UINT32	RO	0x60B1:01, 1
1A01:0D	SubIndex 013	13. PDO Mapping entry (object 0x60C1 (DI Diagnosis Ch.13), entry 0x01 (Wirebreak))	UINT32	RO	0x60C1:01, 1
1A01:0E	SubIndex 014	14. PDO Mapping entry (object 0x60D1 (DI Diagnosis Ch.14), entry 0x01 (Wirebreak))	UINT32	RO	0x60D1:01, 1
1A01:0F	SubIndex 015	15. PDO Mapping entry (object 0x60E1 (DI Diagnosis Ch.15), entry 0x01 (Wirebreak))	UINT32	RO	0x60E1:01, 1
1A01:10	SubIndex 016	16. PDO Mapping entry (object 0x60F1 (DI Diagnosis Ch.16), entry 0x01 (Wirebreak))	UINT32	RO	0x60F1:01, 1

Index (hex)	Name	Meaning	Data type	Flags	Default
1A02:0	DO TxPDO-Map Diagnosis	PDO Mapping TxPDO 3	UINT8	RO	0x20 (32 <sub>dec</sub> )
1A02:01	SubIndex 001	1. PDO Mapping entry (object 0x6102 (DO Diagnosis Ch.01), entry 0x01 (Overcurrent))	UINT32	RO	0x6102:01, 1
1A02:02	SubIndex 002	2. PDO Mapping entry (object 0x6102 (DO Diagnosis Ch.01), entry 0x02 (Overload))	UINT32	RO	0x6102:02, 1
1A02:03	SubIndex 003	3. PDO Mapping entry (object 0x6102 (DO Diagnosis Ch.01), entry 0x03 (Open load))	UINT32	RO	0x6102:03, 1
1A02:04	SubIndex 004	4. PDO Mapping entry (object 0x6102 (DO Diagnosis Ch.01), entry 0x04 (Short to 24V))	UINT32	RO	0x6102:04, 1
1A02:05	SubIndex 005	5. PDO Mapping entry (object 0x6112 (DO Diagnosis Ch.02), entry 0x01 (Overcurrent))	UINT32	RO	0x6112:01, 1
1A02:06	SubIndex 006	6. PDO Mapping entry (object 0x6112 (DO Diagnosis Ch.02), entry 0x02 (Overload))	UINT32	RO	0x6112:02, 1
1A02:07	SubIndex 007	7. PDO Mapping entry (object 0x6112 (DO Diagnosis Ch.02), entry 0x03 (Open load))	UINT32	RO	0x6112:03, 1
1A02:08	SubIndex 008	8. PDO Mapping entry (object 0x6112 (DO Diagnosis Ch.02), entry 0x04 (Short to 24V))	UINT32	RO	0x6112:04, 1
1A02:09	SubIndex 009	9. PDO Mapping entry (object 0x6122 (DO Diagnosis Ch.03), entry 0x01 (Overcurrent))	UINT32	RO	0x6122:01, 1
1A02:0A	SubIndex 010	10. PDO Mapping entry (object 0x6122 (DO Diagnosis Ch.03), entry 0x02 (Overload))	UINT32	RO	0x6122:02, 1
1A02:0B	SubIndex 011	11. PDO Mapping entry (object 0x6122 (DO Diagnosis Ch.03), entry 0x03 (Open load))	UINT32	RO	0x6122:03, 1
1A02:0C	SubIndex 012	12. PDO Mapping entry (object 0x6122 (DO Diagnosis Ch.03), entry 0x04 (Short to 24V))	UINT32	RO	0x6122:04, 1
1A02:0D	SubIndex 013	13. PDO Mapping entry (object 0x6132 (DO Diagnosis Ch.04), entry 0x01 (Overcurrent))	UINT32	RO	0x6132:01, 1
1A02:0E	SubIndex 014	14. PDO Mapping entry (object 0x6132 (DO Diagnosis Ch.04), entry 0x02 (Overload))	UINT32	RO	0x6132:02, 1
1A02:0F	SubIndex 015	15. PDO Mapping entry (object 0x6132 (DO Diagnosis Ch.04), entry 0x03 (Open load))	UINT32	RO	0x6132:03, 1
1A02:10	SubIndex 016	16. PDO Mapping entry (object 0x6132 (DO Diagnosis Ch.04), entry 0x04 (Short to 24V))	UINT32	RO	0x6132:04, 1
1A02:11	SubIndex 017	17. PDO Mapping entry (object 0x6142 (DO Diagnosis Ch.05), entry 0x01 (Overcurrent))	UINT32	RO	0x6142:01, 1
1A02:12	SubIndex 018	18. PDO Mapping entry (object 0x6142 (DO Diagnosis Ch.05), entry 0x02 (Overload))	UINT32	RO	0x6142:02, 1
1A02:13	SubIndex 019	19. PDO Mapping entry (object 0x6142 (DO Diagnosis Ch.05), entry 0x03 (Open load))	UINT32	RO	0x6142:03, 1
1A02:14	SubIndex 020	20. PDO Mapping entry (object 0x6142 (DO Diagnosis Ch.05), entry 0x04 (Short to 24V))	UINT32	RO	0x6142:04, 1
1A02:15	SubIndex 021	21. PDO Mapping entry (object 0x6152 (DO Diagnosis Ch.06), entry 0x01 (Overcurrent))	UINT32	RO	0x6152:01, 1
1A02:16	SubIndex 022	22. PDO Mapping entry (object 0x6152 (DO Diagnosis Ch.06), entry 0x02 (Overload))	UINT32	RO	0x6152:02, 1
1A02:17	SubIndex 023	23. PDO Mapping entry (object 0x6152 (DO Diagnosis Ch.06), entry 0x03 (Open load))	UINT32	RO	0x6152:03, 1
1A02:18	SubIndex 024	24. PDO Mapping entry (object 0x6152 (DO Diagnosis Ch.06), entry 0x04 (Short to 24V))	UINT32	RO	0x6152:04, 1
1A02:19	SubIndex 025	25. PDO Mapping entry (object 0x6162 (DO Diagnosis Ch.07), entry 0x01 (Overcurrent))	UINT32	RO	0x6162:01, 1
1A02:1A	SubIndex 026	26. PDO Mapping entry (object 0x6162 (DO Diagnosis Ch.07), entry 0x02 (Overload))	UINT32	RO	0x6162:02, 1
1A02:1B	SubIndex 027	27. PDO Mapping entry (object 0x6162 (DO Diagnosis Ch.07), entry 0x03 (Open load))	UINT32	RO	0x6162:03, 1
1A02:1C	SubIndex 028	28. PDO Mapping entry (object 0x6162 (DO Diagnosis Ch.07), entry 0x04 (Short to 24V))	UINT32	RO	0x6162:04, 1
1A02:1D	SubIndex 029	29. PDO Mapping entry (object 0x6172 (DO Diagnosis Ch.08), entry 0x01 (Overcurrent))	UINT32	RO	0x6172:01, 1
1A02:1E	SubIndex 030	30. PDO Mapping entry (object 0x6172 (DO Diagnosis Ch.08), entry 0x02 (Overload))	UINT32	RO	0x6172:02, 1
1A02:1F	SubIndex 031	31. PDO Mapping entry (object 0x6172 (DO Diagnosis Ch.08), entry 0x03 (Open load))	UINT32	RO	0x6172:03, 1
1A02:20	SubIndex 032	32. PDO Mapping entry (object 0x6172 (DO Diagnosis Ch.08), entry 0x04 (Short to 24V))	UINT32	RO	0x6172:04, 1

Index (hex)	Name	Meaning	Data type	Flags	Default
1A03:0	DEV TxPDO-Map Inputs Device	PDO Mapping TxPDO 4	UINT8	RO	0x07 (7 <sub>dec</sub> )
1A03:01	SubIndex 001	1. PDO Mapping entry (object 0xF600 (DEV Inputs), entry 0x01 (Undervoltage Us))	UINT32	RO	0xF600:01, 1
1A03:02	SubIndex 002	2. PDO Mapping entry (1 bits align)	UINT32	RO	0x0000:00, 1
1A03:03	SubIndex 003	3. PDO Mapping entry (object 0xF600 (DEV Inputs), entry 0x03 (Overttemperature))	UINT32	RO	0xF600:03, 1
1A03:04	SubIndex 004	4. PDO Mapping entry (9 bits align)	UINT32	RO	0x0000:00, 9
1A03:05	SubIndex 005	5. PDO Mapping entry (object 0xF600 (DEV Inputs), entry 0x0D (Diag))	UINT32	RO	0xF600:0D, 1
1A03:06	SubIndex 006	6. PDO Mapping entry (object 0xF600 (DEV Inputs), entry 0x0E (TxPDO State))	UINT32	RO	0xF600:0E, 1
1A03:07	SubIndex 007	7. PDO Mapping entry (object 0xF600 (DEV Inputs), entry 0x0F (Input cycle counter))	UINT32	RO	0xF600:0F, 2

Index (hex)	Name	Meaning	Data type	Flags	Default
1C00:0	Sync manager type	Using the Sync Managers	UINT8	RO	0x04 (4 <sub>dec</sub> )
1C00:01	SubIndex 001	Sync-Manager Type Channel 1: Mailbox Write	UINT8	RO	0x01 (1 <sub>dec</sub> )
1C00:02	SubIndex 002	Sync-Manager Type Channel 2: Mailbox Read	UINT8	RO	0x02 (2 <sub>dec</sub> )
1C00:03	SubIndex 003	Sync-Manager Type Channel 3: Process Data Write (Outputs)	UINT8	RO	0x03 (3 <sub>dec</sub> )
1C00:04	SubIndex 004	Sync-Manager Type Channel 4: Process Data Read (Inputs)	UINT8	RO	0x04 (4 <sub>dec</sub> )

Index (hex)	Name	Meaning	Data type	Flags	Default
1C12:0	RxPDO assign	PDO Assign Outputs	UINT8	RW	0x01 (1 <sub>dec</sub> )
1C12:01	Subindex 001	1. allocated RxPDO (contains the index of the associated RxPDO Mapping object)	UINT16	RW	0x1602 (5634 <sub>dec</sub> )
1C12:02	Subindex 002	2. allocated RxPDO (contains the index of the associated RxPDO Mapping object)	UINT16	RW	0x0000 (0 <sub>dec</sub> )
1C12:03	Subindex 003	3. allocated RxPDO (contains the index of the associated RxPDO Mapping object)	UINT16	RW	0x0000 (0 <sub>dec</sub> )
1C12:04	Subindex 004	4. allocated RxPDO (contains the index of the associated RxPDO Mapping object)	UINT16	RW	0x0000 (0 <sub>dec</sub> )
1C12:05	Subindex 005	5. allocated RxPDO (contains the index of the associated RxPDO Mapping object)	UINT16	RW	0x0000 (0 <sub>dec</sub> )
1C12:06	Subindex 006	6. allocated RxPDO (contains the index of the associated RxPDO Mapping object)	UINT16	RW	0x0000 (0 <sub>dec</sub> )
1C12:07	Subindex 007	7. allocated RxPDO (contains the index of the associated RxPDO Mapping object)	UINT16	RW	0x0000 (0 <sub>dec</sub> )
1C12:08	Subindex 008	8. allocated RxPDO (contains the index of the associated RxPDO Mapping object)	UINT16	RW	0x0000 (0 <sub>dec</sub> )

Index (hex)	Name	Meaning	Data type	Flags	Default
1C13:0	TxPDO assign	PDO Assign Inputs	UINT8	RW	0x04 (4 <sub>dec</sub> )
1C13:01	Subindex 001	1. allocated TxPDO (contains the index of the associated TxPDO mapping object)	UINT16	RW	0x1A00 (6656 <sub>dec</sub> )
1C13:02	Subindex 002	2. allocated TxPDO (contains the index of the associated TxPDO mapping object)	UINT16	RW	0x1A01 (6657 <sub>dec</sub> )
1C13:03	Subindex 003	3. allocated TxPDO (contains the index of the associated TxPDO mapping object)	UINT16	RW	0x1A02 (6658 <sub>dec</sub> )
1C13:04	Subindex 004	4. allocated TxPDO (contains the index of the associated TxPDO mapping object)	UINT16	RW	0x1A03 (6659 <sub>dec</sub> )
1C13:05	Subindex 005	5. allocated TxPDO (contains the index of the associated TxPDO mapping object)	UINT16	RW	0x0000 (0 <sub>dec</sub> )
1C13:06	Subindex 006	6. allocated TxPDO (contains the index of the associated TxPDO mapping object)	UINT16	RW	0x0000 (0 <sub>dec</sub> )
1C13:07	Subindex 007	7. allocated TxPDO (contains the index of the associated TxPDO mapping object)	UINT16	RW	0x0000 (0 <sub>dec</sub> )
1C13:08	Subindex 008	8. allocated TxPDO (contains the index of the associated TxPDO mapping object)	UINT16	RW	0x0000 (0 <sub>dec</sub> )
1C13:09	Subindex 009	9. allocated TxPDO (contains the index of the associated TxPDO mapping object)	UINT16	RW	0x0000 (0 <sub>dec</sub> )
1C13:0A	Subindex 010	10. allocated TxPDO (contains the index of the associated TxPDO mapping object)	UINT16	RW	0x0000 (0 <sub>dec</sub> )
1C13:0B	Subindex 011	11. allocated TxPDO (contains the index of the associated TxPDO mapping object)	UINT16	RW	0x0000 (0 <sub>dec</sub> )
1C13:0C	Subindex 012	12. allocated TxPDO (contains the index of the associated TxPDO mapping object)	UINT16	RW	0x0000 (0 <sub>dec</sub> )
1C13:0D	Subindex 013	13. allocated TxPDO (contains the index of the associated TxPDO mapping object)	UINT16	RW	0x0000 (0 <sub>dec</sub> )
1C13:0E	Subindex 014	14. allocated TxPDO (contains the index of the associated TxPDO mapping object)	UINT16	RW	0x0000 (0 <sub>dec</sub> )
1C13:0F	Subindex 015	15. allocated TxPDO (contains the index of the associated TxPDO mapping object)	UINT16	RW	0x0000 (0 <sub>dec</sub> )
1C13:10	Subindex 016	16. allocated TxPDO (contains the index of the associated TxPDO mapping object)	UINT16	RW	0x0000 (0 <sub>dec</sub> )
1C13:11	Subindex 017	17. allocated TxPDO (contains the index of the associated TxPDO mapping object)	UINT16	RW	0x0000 (0 <sub>dec</sub> )
1C13:12	Subindex 018	18. allocated TxPDO (contains the index of the associated TxPDO mapping object)	UINT16	RW	0x0000 (0 <sub>dec</sub> )
1C13:13	Subindex 019	19. allocated TxPDO (contains the index of the associated TxPDO mapping object)	UINT16	RW	0x0000 (0 <sub>dec</sub> )
1C13:14	Subindex 020	20. allocated TxPDO (contains the index of the associated TxPDO mapping object)	UINT16	RW	0x0000 (0 <sub>dec</sub> )
1C13:15	Subindex 021	21. allocated TxPDO (contains the index of the associated TxPDO mapping object)	UINT16	RW	0x0000 (0 <sub>dec</sub> )
1C13:16	Subindex 022	22. allocated TxPDO (contains the index of the associated TxPDO mapping object)	UINT16	RW	0x0000 (0 <sub>dec</sub> )
1C13:17	Subindex 023	23. allocated TxPDO (contains the index of the associated TxPDO mapping object)	UINT16	RW	0x0000 (0 <sub>dec</sub> )
1C13:18	Subindex 024	24. allocated TxPDO (contains the index of the associated TxPDO mapping object)	UINT16	RW	0x0000 (0 <sub>dec</sub> )
1C13:19	Subindex 025	25. allocated TxPDO (contains the index of the associated TxPDO mapping object)	UINT16	RW	0x0000 (0 <sub>dec</sub> )
1C13:1A	Subindex 026	26. allocated TxPDO (contains the index of the associated TxPDO mapping object)	UINT16	RW	0x0000 (0 <sub>dec</sub> )
1C13:1B	Subindex 027	27. allocated TxPDO (contains the index of the associated TxPDO mapping object)	UINT16	RW	0x0000 (0 <sub>dec</sub> )
1C13:1C	Subindex 028	28. allocated TxPDO (contains the index of the associated TxPDO mapping object)	UINT16	RW	0x0000 (0 <sub>dec</sub> )
1C13:1D	Subindex 029	29. allocated TxPDO (contains the index of the associated TxPDO mapping object)	UINT16	RW	0x0000 (0 <sub>dec</sub> )
1C13:1E	Subindex 030	30. allocated TxPDO (contains the index of the associated TxPDO mapping object)	UINT16	RW	0x0000 (0 <sub>dec</sub> )
1C13:1F	Subindex 031	31. allocated TxPDO (contains the index of the associated TxPDO mapping object)	UINT16	RW	0x0000 (0 <sub>dec</sub> )
1C13:20	Subindex 032	32. allocated TxPDO (contains the index of the associated TxPDO mapping object)	UINT16	RW	0x0000 (0 <sub>dec</sub> )



Index (hex)	Name	Meaning	Data type	Flags	Default
1C13:21	Subindex 033	33. allocated TxPDO (contains the index of the associated TxPDO mapping object)	UINT16	RW	0x0000 (0 <sub>dec</sub> )
1C13:22	Subindex 034	34. allocated TxPDO (contains the index of the associated TxPDO mapping object)	UINT16	RW	0x0000 (0 <sub>dec</sub> )
1C13:23	Subindex 035	35. allocated TxPDO (contains the index of the associated TxPDO mapping object)	UINT16	RW	0x0000 (0 <sub>dec</sub> )
1C13:24	Subindex 036	36. allocated TxPDO (contains the index of the associated TxPDO mapping object)	UINT16	RW	0x0000 (0 <sub>dec</sub> )
1C13:25	Subindex 037	37. allocated TxPDO (contains the index of the associated TxPDO mapping object)	UINT16	RW	0x0000 (0 <sub>dec</sub> )
1C13:26	Subindex 038	38. allocated TxPDO (contains the index of the associated TxPDO mapping object)	UINT16	RW	0x0000 (0 <sub>dec</sub> )
1C13:27	Subindex 039	39. allocated TxPDO (contains the index of the associated TxPDO mapping object)	UINT16	RW	0x0000 (0 <sub>dec</sub> )
1C13:28	Subindex 040	40. allocated TxPDO (contains the index of the associated TxPDO mapping object)	UINT16	RW	0x0000 (0 <sub>dec</sub> )
1C13:29	Subindex 041	41. allocated TxPDO (contains the index of the associated TxPDO mapping object)	UINT16	RW	0x0000 (0 <sub>dec</sub> )

Index (hex)	Name	Meaning	Data type	Flags	Default
1C32:0	SM output parameter	Synchronization parameters for the outputs	UINT8	RO	0x20 (32 <sub>dec</sub> )
1C32:01	Sync mode	Current synchronization mode: 0: Free Run 1: Synchron with SM 2 Event 2: DC-Mode - Synchron with SYNC0 Event 3: DC-Mode - Synchron with SYNC1 Event	UINT16	RW	0x0001 (1 <sub>dec</sub> )
1C32:02	Cycle time	Cycle time (in ns): Free Run: cycle time of the local timer Synchronous with SM 2 Event: cycle time of the master DC-Mode: SYNC0/SYNC1 Cycle Time	UINT32	RW	0x000F4240 (1000000 <sub>dec</sub> )
1C32:03	Shift time	Time between SYNC0 event and output of the outputs (in ns, DC mode only)	UINT32	RO	0x00000000 (0 <sub>dec</sub> )
1C32:04	Sync modes supported	Supported synchronization modes: Bit 0 = 1: Free Run is supported Bit 1 = 1: Synchron with SM 2 Event is supported Bit 2-3 = 01: DC-Mode is supported Bit 4-5 = 10: Output Shift with SYNC1 event (only DC mode) Bit 14 = 1: dynamic times (measurement through writing of 1C32:08)	UINT16	RO	0x440B (17419 <sub>dec</sub> )
1C32:05	Minimum cycle time	Minimum cycle time (in ns)	UINT32	RO	0x000249F0 (150000 <sub>dec</sub> )
1C32:06	Calc and copy time	Minimum time between SYNC0 and SYNC1 event (in ns, DC mode only)	UINT32	RO	0x00000000 (0 <sub>dec</sub> )
1C32:07	Minimum delay time		UINT32	RO	0x00000000 (0 <sub>dec</sub> )
1C32:08	Get Cycle Time	0: Measurement of the local cycle time is stopped 1: Measurement of the local cycle time is started The entries 1C32:03, 1C32:05, 1C32:06, 1C32:09, 1C33:03, 1C33:06, 1C33:09 are updated with the maximum measured values. For a subsequent measurement the measured values are reset	UINT16	RW	0x0000 (0 <sub>dec</sub> )
1C32:09	Maximum delay time	Time between SYNC1 event and output of the outputs (in ns, DC mode only)	UINT32	RO	0x00000000 (0 <sub>dec</sub> )
1C32:0B	SM event missed counter	Number of missed SM events in OPERATIONAL (DC mode only)	UINT16	RO	0x0000 (0 <sub>dec</sub> )
1C32:0C	Cycle exceeded counter	Number of occasions the cycle time was exceeded in OPERATIONAL (cycle was not completed in time or the next cycle began too early)	UINT16	RO	0x0000 (0 <sub>dec</sub> )
1C32:0D	Shift too short counter	Number of occasions that the interval between SYNC0 and SYNC1 event was too short (DC mode only)	UINT16	RO	0x0000 (0 <sub>dec</sub> )
1C32:20	Sync error	The synchronization was not correct in the last cycle (outputs were output too late; DC mode only)	BOOLEAN	RO	0x00 (0 <sub>dec</sub> )

Index (hex)	Name	Meaning	Data type	Flags	Default
1C33:0	SM input parameter	Synchronization parameters for the inputs	UINT8	RO	0x20 (32 <sub>dec</sub> )
1C33:01	Sync mode	Current synchronization mode: 0: Free Run 1: Synchron with SM 3 event (no outputs available) 2: DC - Synchron with SYNC0 Event 3: DC - Synchron with SYNC1 Event 34: Synchron with SM 2 event (outputs available)	UINT16	RW	0x0022 (34 <sub>dec</sub> )
1C33:02	Cycle time	as 1C32:02	UINT32	RW	0x000F4240 (1000000 <sub>dec</sub> )
1C33:03	Shift time	Time between SYNC0 event and reading of the inputs (in ns, only DC mode)	UINT32	RO	0x000249F0 (150000 <sub>dec</sub> )
1C33:04	Sync modes supported	Supported synchronization modes: Bit 0: Free Run is supported Bit 1: Synchron with SM 2 Event is supported (outputs available) Bit 1: Synchron with SM 3 Event is supported (no outputs available) Bit 2-3 = 01: DC-Mode is supported Bit 4-5 = 01: Input Shift through local event (outputs available) Bit 4-5 = 10: Input Shift with SYNC1 event (no outputs available) Bit 14 = 1: dynamic times (measurement through writing of 1C32:08 or 1C33:08)	UINT16	RO	0x440B (17419 <sub>dec</sub> )
1C33:05	Minimum cycle time	as 1C32:05	UINT32	RO	0x000249F0 (150000 <sub>dec</sub> )
1C33:06	Calc and copy time	Time between reading of the inputs and availability of the inputs for the master (in ns, only DC mode)	UINT32	RO	0x00000000 (0 <sub>dec</sub> )
1C33:07	Minimum delay time		UINT32	RO	0x00000000 (0 <sub>dec</sub> )
1C33:08	Get Cycle Time	as 1C32:08	UINT16	RW	0x0000 (0 <sub>dec</sub> )
1C33:09	Maximum delay time	Time between SYNC1 event and reading of the inputs (in ns, only DC mode)	UINT32	RO	0x00000000 (0 <sub>dec</sub> )
1C33:0B	SM event missed counter	as 1C32:11	UINT16	RO	0x0000 (0 <sub>dec</sub> )
1C33:0C	Cycle exceeded counter	as 1C32:12	UINT16	RO	0x0000 (0 <sub>dec</sub> )
1C33:0D	Shift too short counter	as 1C32:13	UINT16	RO	0x0000 (0 <sub>dec</sub> )
1C33:20	Sync error	as 1C32:32	BOOLEAN	RO	0x00 (0 <sub>dec</sub> )

## 7.7.2 Profile-specific objects (0x6000-0xFFFF)

The profile-specific objects have the same meaning for all EtherCAT slaves that support the profile 5001.

Index (hex)	Name	Meaning	Data type	Flags	Default
6000:0	DI Input Ch.01	Process data	UINT8	RO	0x01 (1 <sub>dec</sub> )
6000:01	Input		BOOLEAN	RO	0x00 (0 <sub>dec</sub> )

Index (hex)	Name	Meaning	Data type	Flags	Default
6001:0	DI Diagnosis Ch.01	Process data	UINT8	RO	0x01 (1 <sub>dec</sub> )
6001:01	Wirebreak		BOOLEAN	RO	0x00 (0 <sub>dec</sub> )

Index (hex)	Name	Meaning	Data type	Flags	Default
6010:0	DI Input Ch.02	Process data	UINT8	RO	0x01 (1 <sub>dec</sub> )
6010:01	Input		BOOLEAN	RO	0x00 (0 <sub>dec</sub> )

Index (hex)	Name	Meaning	Data type	Flags	Default
6011:0	DI Diagnosis Ch.02	Process data	UINT8	RO	0x01 (1 <sub>dec</sub> )
6011:01	Wirebreak		BOOLEAN	RO	0x00 (0 <sub>dec</sub> )

Index (hex)	Name	Meaning	Data type	Flags	Default
6020:0	DI Input Ch.03	Process data	UINT8	RO	0x01 (1 <sub>dec</sub> )
6020:01	Input		BOOLEAN	RO	0x00 (0 <sub>dec</sub> )

Index (hex)	Name	Meaning	Data type	Flags	Default
6021:0	DI Diagnosis Ch.03	Process data	UINT8	RO	0x01 (1 <sub>dec</sub> )
6021:01	Wirebreak		BOOLEAN	RO	0x00 (0 <sub>dec</sub> )

Index (hex)	Name	Meaning	Data type	Flags	Default
6030:0	DI Input Ch.04	Process data	UINT8	RO	0x01 (1 <sub>dec</sub> )
6030:01	Input		BOOLEAN	RO	0x00 (0 <sub>dec</sub> )

Index (hex)	Name	Meaning	Data type	Flags	Default
6031:0	DI Diagnosis Ch.04	Process data	UINT8	RO	0x01 (1 <sub>dec</sub> )
6031:01	Wirebreak		BOOLEAN	RO	0x00 (0 <sub>dec</sub> )

Index (hex)	Name	Meaning	Data type	Flags	Default
6040:0	DI Input Ch.05	Process data	UINT8	RO	0x01 (1 <sub>dec</sub> )
6040:01	Input		BOOLEAN	RO	0x00 (0 <sub>dec</sub> )

Index (hex)	Name	Meaning	Data type	Flags	Default
6041:0	DI Diagnosis Ch.05	Process data	UINT8	RO	0x01 (1 <sub>dec</sub> )
6041:01	Wirebreak		BOOLEAN	RO	0x00 (0 <sub>dec</sub> )

Index (hex)	Name	Meaning	Data type	Flags	Default
6050:0	DI Input Ch.06	Process data	UINT8	RO	0x01 (1 <sub>dec</sub> )
6050:01	Input		BOOLEAN	RO	0x00 (0 <sub>dec</sub> )

Index (hex)	Name	Meaning	Data type	Flags	Default
6051:0	DI Diagnosis Ch.06	Process data	UINT8	RO	0x01 (1 <sub>dec</sub> )
6051:01	Wirebreak		BOOLEAN	RO	0x00 (0 <sub>dec</sub> )

Index (hex)	Name	Meaning	Data type	Flags	Default
6060:0	DI Input Ch.07	Process data	UINT8	RO	0x01 (1 <sub>dec</sub> )
6060:01	Input		BOOLEAN	RO	0x00 (0 <sub>dec</sub> )

Index (hex)	Name	Meaning	Data type	Flags	Default
6061:0	DI Diagnosis Ch.07	Process data	UINT8	RO	0x01 (1 <sub>dec</sub> )
6061:01	Wirebreak		BOOLEAN	RO	0x00 (0 <sub>dec</sub> )

Index (hex)	Name	Meaning	Data type	Flags	Default
6070:0	DI Input Ch.08	Process data	UINT8	RO	0x01 (1 <sub>dec</sub> )
6070:01	Input		BOOLEAN	RO	0x00 (0 <sub>dec</sub> )

Index (hex)	Name	Meaning	Data type	Flags	Default
6071:0	DI Diagnosis Ch.08	Process data	UINT8	RO	0x01 (1 <sub>dec</sub> )
6071:01	Wirebreak		BOOLEAN	RO	0x00 (0 <sub>dec</sub> )

Index (hex)	Name	Meaning	Data type	Flags	Default
6080:0	DI Input Ch.09	Process data	UINT8	RO	0x01 (1 <sub>dec</sub> )
6080:01	Input		BOOLEAN	RO	0x00 (0 <sub>dec</sub> )

Index (hex)	Name	Meaning	Data type	Flags	Default
6081:0	DI Diagnosis Ch.09	Process data	UINT8	RO	0x01 (1 <sub>dec</sub> )
6081:01	Wirebreak		BOOLEAN	RO	0x00 (0 <sub>dec</sub> )

Index (hex)	Name	Meaning	Data type	Flags	Default
6090:0	DI Input Ch.10	Process data	UINT8	RO	0x01 (1 <sub>dec</sub> )
6090:01	Input		BOOLEAN	RO	0x00 (0 <sub>dec</sub> )

Index (hex)	Name	Meaning	Data type	Flags	Default
6091:0	DI Diagnosis Ch.10	Process data	UINT8	RO	0x01 (1 <sub>dec</sub> )
6091:01	Wirebreak		BOOLEAN	RO	0x00 (0 <sub>dec</sub> )

Index (hex)	Name	Meaning	Data type	Flags	Default
60A0:0	DI Input Ch.11	Process data	UINT8	RO	0x01 (1 <sub>dec</sub> )
60A00:01	Input		BOOLEAN	RO	0x00 (0 <sub>dec</sub> )

Index (hex)	Name	Meaning	Data type	Flags	Default
60A1:0	DI Diagnosis Ch.11	Process data	UINT8	RO	0x01 (1 <sub>dec</sub> )
60A1:01	Wirebreak		BOOLEAN	RO	0x00 (0 <sub>dec</sub> )

Index (hex)	Name	Meaning	Data type	Flags	Default
60B0:0	DI Input Ch.12	Process data	UINT8	RO	0x01 (1 <sub>dec</sub> )
60B00:01	Input		BOOLEAN	RO	0x00 (0 <sub>dec</sub> )

Index (hex)	Name	Meaning	Data type	Flags	Default
60B1:0	DI Diagnosis Ch.12	Process data	UINT8	RO	0x01 (1 <sub>dec</sub> )
60B1:01	Wirebreak		BOOLEAN	RO	0x00 (0 <sub>dec</sub> )

Index (hex)	Name	Meaning	Data type	Flags	Default
60C0:0	DI Input Ch.13	Process data	UINT8	RO	0x01 (1 <sub>dec</sub> )
60C00:01	Input		BOOLEAN	RO	0x00 (0 <sub>dec</sub> )

Index (hex)	Name	Meaning	Data type	Flags	Default
60C1:0	DI Diagnosis Ch.13	Process data	UINT8	RO	0x01 (1 <sub>dec</sub> )
60C1:01	Wirebreak		BOOLEAN	RO	0x00 (0 <sub>dec</sub> )

Index (hex)	Name	Meaning	Data type	Flags	Default
60D0:0	DI Input Ch.14	Process data	UINT8	RO	0x01 (1 <sub>dec</sub> )
60D00:01	Input		BOOLEAN	RO	0x00 (0 <sub>dec</sub> )

Index (hex)	Name	Meaning	Data type	Flags	Default
60D1:0	DI Diagnosis Ch.14	Process data	UINT8	RO	0x01 (1 <sub>dec</sub> )
60D1:01	Wirebreak		BOOLEAN	RO	0x00 (0 <sub>dec</sub> )

Index (hex)	Name	Meaning	Data type	Flags	Default
60E0:0	DI Input Ch.15	Process data	UINT8	RO	0x01 (1 <sub>dec</sub> )
60E00:01	Input		BOOLEAN	RO	0x00 (0 <sub>dec</sub> )

Index (hex)	Name	Meaning	Data type	Flags	Default
60E1:0	DI Diagnosis Ch.15	Process data	UINT8	RO	0x01 (1 <sub>dec</sub> )
60E1:01	Wirebreak		BOOLEAN	RO	0x00 (0 <sub>dec</sub> )

Index (hex)	Name	Meaning	Data type	Flags	Default
60F0:0	DI Input Ch.16	Process data	UINT8	RO	0x01 (1 <sub>dec</sub> )
60F00:01	Input		BOOLEAN	RO	0x00 (0 <sub>dec</sub> )

Index (hex)	Name	Meaning	Data type	Flags	Default
60F1:0	DI Diagnosis Ch.16	Process data	UINT8	RO	0x01 (1 <sub>dec</sub> )
60F1:01	Wirebreak		BOOLEAN	RO	0x00 (0 <sub>dec</sub> )

Index (hex)	Name	Meaning	Data type	Flags	Default
6102:0	DO Diagnosis Ch.01	Process data	UINT8	RO	0x04 (4 <sub>dec</sub> )
6102:01	Overcurrent		BOOLEAN	RO	0x00 (0 <sub>dec</sub> )
6102:02	Overload		BOOLEAN	RO	0x00 (0 <sub>dec</sub> )
6102:03	Open load		BOOLEAN	RO	0x00 (0 <sub>dec</sub> )
6102:04	Short to 24V		BOOLEAN	RO	0x00 (0 <sub>dec</sub> )

Index (hex)	Name	Meaning	Data type	Flags	Default
6112:0	DO Diagnosis Ch.02	Process data	UINT8	RO	0x04 (4 <sub>dec</sub> )
6112:01	Overcurrent		BOOLEAN	RO	0x00 (0 <sub>dec</sub> )
6112:02	Overload		BOOLEAN	RO	0x00 (0 <sub>dec</sub> )
6112:03	Open load		BOOLEAN	RO	0x00 (0 <sub>dec</sub> )
6112:04	Short to 24V		BOOLEAN	RO	0x00 (0 <sub>dec</sub> )

Index (hex)	Name	Meaning	Data type	Flags	Default
6122:0	DO Diagnosis Ch.03	Process data	UINT8	RO	0x04 (4 <sub>dec</sub> )
6122:01	Overcurrent		BOOLEAN	RO	0x00 (0 <sub>dec</sub> )
6122:02	Overload		BOOLEAN	RO	0x00 (0 <sub>dec</sub> )
6122:03	Open load		BOOLEAN	RO	0x00 (0 <sub>dec</sub> )
6122:04	Short to 24V		BOOLEAN	RO	0x00 (0 <sub>dec</sub> )

Index (hex)	Name	Meaning	Data type	Flags	Default
6132:0	DO Diagnosis Ch.04	Process data	UINT8	RO	0x04 (4 <sub>dec</sub> )
6132:01	Overcurrent		BOOLEAN	RO	0x00 (0 <sub>dec</sub> )
6132:02	Overload		BOOLEAN	RO	0x00 (0 <sub>dec</sub> )
6132:03	Open load		BOOLEAN	RO	0x00 (0 <sub>dec</sub> )
6132:04	Short to 24V		BOOLEAN	RO	0x00 (0 <sub>dec</sub> )

Index (hex)	Name	Meaning	Data type	Flags	Default
6142:0	DO Diagnosis Ch.05	Process data	UINT8	RO	0x04 (4 <sub>dec</sub> )
6142:01	Overcurrent		BOOLEAN	RO	0x00 (0 <sub>dec</sub> )
6142:02	Overload		BOOLEAN	RO	0x00 (0 <sub>dec</sub> )
6142:03	Open load		BOOLEAN	RO	0x00 (0 <sub>dec</sub> )
6142:04	Short to 24V		BOOLEAN	RO	0x00 (0 <sub>dec</sub> )

Index (hex)	Name	Meaning	Data type	Flags	Default
6152:0	DO Diagnosis Ch.06	Process data	UINT8	RO	0x04 (4 <sub>dec</sub> )
6152:01	Overcurrent		BOOLEAN	RO	0x00 (0 <sub>dec</sub> )
6152:02	Overload		BOOLEAN	RO	0x00 (0 <sub>dec</sub> )
6152:03	Open load		BOOLEAN	RO	0x00 (0 <sub>dec</sub> )
6152:04	Short to 24V		BOOLEAN	RO	0x00 (0 <sub>dec</sub> )

Index (hex)	Name	Meaning	Data type	Flags	Default
6162:0	DO Diagnosis Ch.07	Process data	UINT8	RO	0x04 (4 <sub>dec</sub> )
6162:01	Overcurrent		BOOLEAN	RO	0x00 (0 <sub>dec</sub> )
6162:02	Overload		BOOLEAN	RO	0x00 (0 <sub>dec</sub> )
6162:03	Open load		BOOLEAN	RO	0x00 (0 <sub>dec</sub> )
6162:04	Short to 24V		BOOLEAN	RO	0x00 (0 <sub>dec</sub> )

Index (hex)	Name	Meaning	Data type	Flags	Default
6172:0	DO Diagnosis Ch.08	Process data	UINT8	RO	0x04 (4 <sub>dec</sub> )
6172:01	Overcurrent		BOOLEAN	RO	0x00 (0 <sub>dec</sub> )
6172:02	Overload		BOOLEAN	RO	0x00 (0 <sub>dec</sub> )
6172:03	Open load		BOOLEAN	RO	0x00 (0 <sub>dec</sub> )
6172:04	Short to 24V		BOOLEAN	RO	0x00 (0 <sub>dec</sub> )

Index (hex)	Name	Meaning	Data type	Flags	Default
7100:0	DO Output Ch.01	Process data	UINT8	RO	0x01 (1 <sub>dec</sub> )
7100:01	Output		BOOLEAN	RO	0x00 (0 <sub>dec</sub> )

Index (hex)	Name	Meaning	Data type	Flags	Default
7110:0	DO Output Ch.02	Process data	UINT8	RO	0x01 (1 <sub>dec</sub> )
7110:01	Output		BOOLEAN	RO	0x00 (0 <sub>dec</sub> )

Index (hex)	Name	Meaning	Data type	Flags	Default
7120:0	DO Output Ch.03	Process data	UINT8	RO	0x01 (1 <sub>dec</sub> )
7120:01	Output		BOOLEAN	RO	0x00 (0 <sub>dec</sub> )

Index (hex)	Name	Meaning	Data type	Flags	Default
7130:0	DO Output Ch.04	Process data	UINT8	RO	0x01 (1 <sub>dec</sub> )
7130:01	Output		BOOLEAN	RO	0x00 (0 <sub>dec</sub> )

Index (hex)	Name	Meaning	Data type	Flags	Default
7140:0	DO Output Ch.05	Process data	UINT8	RO	0x01 (1 <sub>dec</sub> )
7140:01	Output		BOOLEAN	RO	0x00 (0 <sub>dec</sub> )

Index (hex)	Name	Meaning	Data type	Flags	Default
7150:0	DO Output Ch.06	Process data	UINT8	RO	0x01 (1 <sub>dec</sub> )
7150:01	Output		BOOLEAN	RO	0x00 (0 <sub>dec</sub> )

Index (hex)	Name	Meaning	Data type	Flags	Default
7160:0	DO Output Ch.07	Process data	UINT8	RO	0x01 (1 <sub>dec</sub> )
7160:01	Output		BOOLEAN	RO	0x00 (0 <sub>dec</sub> )

Index (hex)	Name	Meaning	Data type	Flags	Default
7170:0	DO Output Ch.08	Process data	UINT8	RO	0x01 (1 <sub>dec</sub> )
7170:01	Output		BOOLEAN	RO	0x00 (0 <sub>dec</sub> )

Index (hex)	Name	Meaning	Data type	Flags	Default
8000:0	DI Settings Ch.01	Parameters for the digital input channel 1: Connection X01, Pin 4 / Input A.	UINT8	RO	0x12 (18 <sub>dec</sub> )
8000:01	Enable open load detection	Enable wire break detection. See chapter <a href="#">Wire break detection (EP1839-0042)</a> [▶ 136].	BOOLEAN	RW	0
8000:11	Filter time	Set input filter time. See chapter <a href="#">Input filter</a> [▶ 114].	UINT16	RW	0
8000:12	Signal extension time	Set pulse extension. See chapter <a href="#">Pulse extension</a> [▶ 116].	UINT16	RW	0

Index (hex)	Name	Meaning	Data type	Flags	Default
8010:0	DI Settings Ch.02	Parameters for the digital input channel 2: Connection X01, Pin 2 / Input B.	UINT8	RO	0x12 (18 <sub>dec</sub> )
8010:01	Enable open load detection	Enable wire break detection. See chapter <a href="#">Wire break detection (EP1839-0042)</a> [▶ 136].	BOOLEAN	RW	0
8010:11	Filter time	Set input filter time. See chapter <a href="#">Input filter</a> [▶ 114].	UINT16	RW	0
8010:12	Signal extension time	Set pulse extension. See chapter <a href="#">Pulse extension</a> [▶ 116].	UINT16	RW	0

Index (hex)	Name	Meaning	Data type	Flags	Default
8020:0	DI Settings Ch.03	Parameters for the digital input channel 3: Connection X02, Pin 4 / Input A.	UINT8	RO	0x12 (18 <sub>dec</sub> )
8020:01	Enable open load detection	Enable wire break detection. See chapter <a href="#">Wire break detection (EP1839-0042)</a> [▶ 136].	BOOLEAN	RW	0
8020:11	Filter time	Set input filter time. See chapter <a href="#">Input filter</a> [▶ 114].	UINT16	RW	0
8020:12	Signal extension time	Set pulse extension. See chapter <a href="#">Pulse extension</a> [▶ 116].	UINT16	RW	0



Index (hex)	Name	Meaning	Data type	Flags	Default
8030:0	DI Settings Ch.04	Parameters for the digital input channel 4: Connection X02, Pin 2 / Input B.	UINT8	RO	0x12 (18 <sub>dec</sub> )
8030:01	Enable open load detection	Enable wire break detection. See chapter <a href="#">Wire break detection (EP1839-0042)</a> [▶ 136].	BOOLEAN	RW	0
8030:11	Filter time	Set input filter time. See chapter <a href="#">Input filter</a> [▶ 114].	UINT16	RW	0
8030:12	Signal extension time	Set pulse extension. See chapter <a href="#">Pulse extension</a> [▶ 116].	UINT16	RW	0

Index (hex)	Name	Meaning	Data type	Flags	Default
8040:0	DI Settings Ch.05	Parameters for the digital input channel 5: Connection X03, Pin 4 / Input A.	UINT8	RO	0x12 (18 <sub>dec</sub> )
8040:01	Enable open load detection	Enable wire break detection. See chapter <a href="#">Wire break detection (EP1839-0042)</a> [▶ 136].	BOOLEAN	RW	0
8040:11	Filter time	Set input filter time. See chapter <a href="#">Input filter</a> [▶ 114].	UINT16	RW	0
8040:12	Signal extension time	Set pulse extension. See chapter <a href="#">Pulse extension</a> [▶ 116].	UINT16	RW	0

Index (hex)	Name	Meaning	Data type	Flags	Default
8050:0	DI Settings Ch.06	Parameters for the digital input channel 6: Connection X03, Pin 2 / Input B.	UINT8	RO	0x12 (18 <sub>dec</sub> )
8050:01	Enable open load detection	Enable wire break detection. See chapter <a href="#">Wire break detection (EP1839-0042)</a> [▶ 136].	BOOLEAN	RW	0
8050:11	Filter time	Set input filter time. See chapter <a href="#">Input filter</a> [▶ 114].	UINT16	RW	0
8050:12	Signal extension time	Set pulse extension. See chapter <a href="#">Pulse extension</a> [▶ 116].	UINT16	RW	0

Index (hex)	Name	Meaning	Data type	Flags	Default
8060:0	DI Settings Ch.07	Parameters for the digital input channel 7: Connection X04, Pin 4 / Input A.	UINT8	RO	0x12 (18 <sub>dec</sub> )
8060:01	Enable open load detection	Enable wire break detection. See chapter <a href="#">Wire break detection (EP1839-0042)</a> [▶ 136].	BOOLEAN	RW	0
8060:11	Filter time	Set input filter time. See chapter <a href="#">Input filter</a> [▶ 114].	UINT16	RW	0
8060:12	Signal extension time	Set pulse extension. See chapter <a href="#">Pulse extension</a> [▶ 116].	UINT16	RW	0

Index (hex)	Name	Meaning	Data type	Flags	Default
8070:0	DI Settings Ch.08	Parameters for the digital input channel 8: Connection X04, Pin 2 / Input B.	UINT8	RO	0x12 (18 <sub>dec</sub> )
8070:01	Enable open load detection	Enable wire break detection. See chapter <a href="#">Wire break detection (EP1839-0042)</a> [▶ 136].	BOOLEAN	RW	0
8070:11	Filter time	Set input filter time. See chapter <a href="#">Input filter</a> [▶ 114].	UINT16	RW	0
8070:12	Signal extension time	Set pulse extension. See chapter <a href="#">Pulse extension</a> [▶ 116].	UINT16	RW	0

Index (hex)	Name	Meaning	Data type	Flags	Default
8080:0	DI Settings Ch.09	Parameters for the digital input channel 9: Connection X05, Pin 4 / Input A.	UINT8	RO	0x12 (18 <sub>dec</sub> )
8080:01	Enable open load detection	Enable wire break detection. See chapter <a href="#">Wire break detection (EP1839-0042)</a> [▶ 136].	BOOLEAN	RW	0
8080:11	Filter time	Set input filter time. See chapter <a href="#">Input filter</a> [▶ 114].	UINT16	RW	0
8080:12	Signal extension time	Set pulse extension. See chapter <a href="#">Pulse extension</a> [▶ 116].	UINT16	RW	0

Index (hex)	Name	Meaning	Data type	Flags	Default
8090:0	DI Settings Ch.10	Parameters for the digital input channel 10: Connection X05, Pin 2 / Input B.	UINT8	RO	0x12 (18 <sub>dec</sub> )
8090:01	Enable open load detection	Enable wire break detection. See chapter <a href="#">Wire break detection (EP1839-0042)</a> [▶ 136].	BOOLEAN	RW	0
8090:11	Filter time	Set input filter time. See chapter <a href="#">Input filter</a> [▶ 114].	UINT16	RW	0
8090:12	Signal extension time	Set pulse extension. See chapter <a href="#">Pulse extension</a> [▶ 116].	UINT16	RW	0

Index (hex)	Name	Meaning	Data type	Flags	Default
80A0:0	DI Settings Ch.11	Parameters for the digital input channel 11: Connection X06, Pin 4 / Input A.	UINT8	RO	0x12 (18 <sub>dec</sub> )
80A00:01	Enable open load detection	Enable wire break detection. See chapter <a href="#">Wire break detection (EP1839-0042)</a> [▶ 136].	BOOLEAN	RW	0
80A00:11	Filter time	Set input filter time. See chapter <a href="#">Input filter</a> [▶ 114].	UINT16	RW	0
80A00:12	Signal extension time	Set pulse extension. See chapter <a href="#">Pulse extension</a> [▶ 116].	UINT16	RW	0

Index (hex)	Name	Meaning	Data type	Flags	Default
80B0:0	DI Settings Ch.12	Parameters for the digital input channel 12: Connection X06, Pin 2 / Input B.	UINT8	RO	0x12 (18 <sub>dec</sub> )
80B00:01	Enable open load detection	Enable wire break detection. See chapter <a href="#">Wire break detection (EP1839-0042)</a> [▶ 136].	BOOLEAN	RW	0
80B00:11	Filter time	Set input filter time. See chapter <a href="#">Input filter</a> [▶ 114].	UINT16	RW	0
80B00:12	Signal extension time	Set pulse extension. See chapter <a href="#">Pulse extension</a> [▶ 116].	UINT16	RW	0

Index (hex)	Name	Meaning	Data type	Flags	Default
80C0:0	DI Settings Ch.13	Parameters for the digital input channel 13: Connection X07, Pin 4 / Input A.	UINT8	RO	0x12 (18 <sub>dec</sub> )
80C00:01	Enable open load detection	Enable wire break detection. See chapter <a href="#">Wire break detection (EP1839-0042)</a> [▶ 136].	BOOLEAN	RW	0
80C00:11	Filter time	Set input filter time. See chapter <a href="#">Input filter</a> [▶ 114].	UINT16	RW	0
80C00:12	Signal extension time	Set pulse extension. See chapter <a href="#">Pulse extension</a> [▶ 116].	UINT16	RW	0

Index (hex)	Name	Meaning	Data type	Flags	Default
80D0:0	DI Settings Ch.14	Parameters for the digital input channel 14: Connection X07, Pin 2 / Input B.	UINT8	RO	0x12 (18 <sub>dec</sub> )
80D00:01	Enable open load detection	Enable wire break detection. See chapter <a href="#">Wire break detection (EP1839-0042)</a> [► 136].	BOOLEAN	RW	0
80D00:11	Filter time	Set input filter time. See chapter <a href="#">Input filter</a> [► 114].	UINT16	RW	0
80D00:12	Signal extension time	Set pulse extension. See chapter <a href="#">Pulse extension</a> [► 116].	UINT16	RW	0

Index (hex)	Name	Meaning	Data type	Flags	Default
80E0:0	DI Settings Ch.15	Parameters for the digital input channel 15: Connection X08, Pin 4 / Input A.	UINT8	RO	0x12 (18 <sub>dec</sub> )
80E00:01	Enable open load detection	Enable wire break detection. See chapter <a href="#">Wire break detection (EP1839-0042)</a> [► 136].	BOOLEAN	RW	0
80E00:11	Filter time	Set input filter time. See chapter <a href="#">Input filter</a> [► 114].	UINT16	RW	0
80E00:12	Signal extension time	Set pulse extension. See chapter <a href="#">Pulse extension</a> [► 116].	UINT16	RW	0

Index (hex)	Name	Meaning	Data type	Flags	Default
80F0:0	DI Settings Ch.16	Parameters for the digital input channel 16: Connection X08, Pin 2 / Input B.	UINT8	RO	0x12 (18 <sub>dec</sub> )
80F00:01	Enable open load detection	Enable wire break detection. See chapter <a href="#">Wire break detection (EP1839-0042)</a> [► 136].	BOOLEAN	RW	0
80F00:11	Filter time	Set input filter time. See chapter <a href="#">Input filter</a> [► 114].	UINT16	RW	0
80F00:12	Signal extension time	Set pulse extension. See chapter <a href="#">Pulse extension</a> [► 116].	UINT16	RW	0

Index (hex)	Name	Meaning	Data type	Flags	Default
8100:0	DO Settings Ch.01	Parameters for the sensor supply output at connection X01. See chapter <a href="#">Configure sensor supply (EP1839-0042)</a> [► 119].	UINT8	RO	0x06 (6 <sub>dec</sub> )
8100:01	Detect openload in off state	Enable wire break detection for the "off" state. See chapter <a href="#">Diagnostics</a> .	BOOLEAN	RW	0
8100:02	Detect openload in on state	Enable wire break detection for the "on" state. See chapter <a href="#">Diagnostics</a> .	BOOLEAN	RW	0
8100:03	Detect short to 24V	Enable 24 V short-circuit detection. See chapter <a href="#">Diagnostics</a> .	BOOLEAN	RW	0
8100:04	Safe state active	Enable the function "Safe state". See chapter <a href="#">Behavior on EtherCAT failure</a> [► 120].	BOOLEAN	RW	1
8100:05	Safe state value	Default of Safe state. See chapter <a href="#">Behavior on EtherCAT failure</a> [► 120].	BOOLEAN	RW	0
8100:06	Use output as power supply	0: The output can be switched via the process data. 1: The output is permanently switched on. See chapter <a href="#">Switching outputs</a> [► 119].	BOOLEAN	RW	1

Index (hex)	Name	Meaning	Data type	Flags	Default
8110:0	DO Settings Ch.02	Parameters for the sensor supply output at connection X02.  See chapter <a href="#">Configure sensor supply (EP1839-0042)</a> [► 119].	UINT8	RO	0x06 (6 <sub>dec</sub> )
8110:01	Detect openload in off state	Enable wire break detection for the "off" state. See chapter <a href="#">Diagnostics</a> .	BOOLEAN	RW	0
8110:02	Detect openload in on state	Enable wire break detection for the "on" state. See chapter <a href="#">Diagnostics</a> .	BOOLEAN	RW	0
8110:03	Detect short to 24V	Enable 24 V short-circuit detection. See chapter <a href="#">Diagnostics</a> .	BOOLEAN	RW	0
8110:04	Safe state active	Enable the function "Safe state". See chapter <a href="#">Behavior on EtherCAT failure</a> [► 120].	BOOLEAN	RW	1
8110:05	Safe state value	Default of Safe state. See chapter <a href="#">Behavior on EtherCAT failure</a> [► 120].	BOOLEAN	RW	0
8110:06	Use output as power supply	0: The output can be switched via the process data. 1: The output is permanently switched on.  See chapter <a href="#">Switching outputs</a> [► 119].	BOOLEAN	RW	1

Index (hex)	Name	Meaning	Data type	Flags	Default
8120:0	DO Settings Ch.03	Parameters for the sensor supply output at connection X03.  See chapter <a href="#">Configure sensor supply (EP1839-0042)</a> [► 119].	UINT8	RO	0x06 (6 <sub>dec</sub> )
8120:01	Detect openload in off state	Enable wire break detection for the "off" state. See chapter <a href="#">Diagnostics</a> .	BOOLEAN	RW	0
8120:02	Detect openload in on state	Enable wire break detection for the "on" state. See chapter <a href="#">Diagnostics</a> .	BOOLEAN	RW	0
8120:03	Detect short to 24V	Enable 24 V short-circuit detection. See chapter <a href="#">Diagnostics</a> .	BOOLEAN	RW	0
8120:04	Safe state active	Enable the function "Safe state". See chapter <a href="#">Behavior on EtherCAT failure</a> [► 120].	BOOLEAN	RW	1
8120:05	Safe state value	Default of Safe state. See chapter <a href="#">Behavior on EtherCAT failure</a> [► 120].	BOOLEAN	RW	0
8120:06	Use output as power supply	0: The output can be switched via the process data. 1: The output is permanently switched on.  See chapter <a href="#">Switching outputs</a> [► 119].	BOOLEAN	RW	1

Index (hex)	Name	Meaning	Data type	Flags	Default
8130:0	DO Settings Ch.04	Parameters for the sensor supply output at connection X04.  See chapter <a href="#">Configure sensor supply (EP1839-0042)</a> [► 119].	UINT8	RO	0x06 (6 <sub>dec</sub> )
8130:01	Detect openload in off state	Enable wire break detection for the "off" state. See chapter <a href="#">Diagnostics</a> .	BOOLEAN	RW	0
8130:02	Detect openload in on state	Enable wire break detection for the "on" state. See chapter <a href="#">Diagnostics</a> .	BOOLEAN	RW	0
8130:03	Detect short to 24V	Enable 24 V short-circuit detection. See chapter <a href="#">Diagnostics</a> .	BOOLEAN	RW	0
8130:04	Safe state active	Enable the function "Safe state". See chapter <a href="#">Behavior on EtherCAT failure</a> [► 120].	BOOLEAN	RW	1
8130:05	Safe state value	Default of Safe state. See chapter <a href="#">Behavior on EtherCAT failure</a> [► 120].	BOOLEAN	RW	0
8130:06	Use output as power supply	0: The output can be switched via the process data. 1: The output is permanently switched on.  See chapter <a href="#">Switching outputs</a> [► 119].	BOOLEAN	RW	1

Index (hex)	Name	Meaning	Data type	Flags	Default
8140:0	DO Settings Ch.05	Parameters for the sensor supply output at connection X05. See chapter <a href="#">Configure sensor supply (EP1839-0042)</a> [► 119].	UINT8	RO	0x06 (6 <sub>dec</sub> )
8140:01	Detect openload in off state	Enable wire break detection for the "off" state. See chapter Diagnostics.	BOOLEAN	RW	0
8140:02	Detect openload in on state	Enable wire break detection for the "on" state. See chapter Diagnostics.	BOOLEAN	RW	0
8140:03	Detect short to 24V	Enable 24 V short-circuit detection. See chapter Diagnostics.	BOOLEAN	RW	0
8140:04	Safe state active	Enable the function "Safe state". See chapter <a href="#">Behavior on EtherCAT failure</a> [► 120].	BOOLEAN	RW	1
8140:05	Safe state value	Default of Safe state. See chapter <a href="#">Behavior on EtherCAT failure</a> [► 120].	BOOLEAN	RW	0
8140:06	Use output as power supply	0: The output can be switched via the process data. 1: The output is permanently switched on. See chapter <a href="#">Switching outputs</a> [► 119].	BOOLEAN	RW	1

Index (hex)	Name	Meaning	Data type	Flags	Default
8150:0	DO Settings Ch.06	Parameters for the sensor supply output at connection X06. See chapter <a href="#">Configure sensor supply (EP1839-0042)</a> [► 119].	UINT8	RO	0x06 (6 <sub>dec</sub> )
8150:01	Detect openload in off state	Enable wire break detection for the "off" state. See chapter Diagnostics.	BOOLEAN	RW	0
8150:02	Detect openload in on state	Enable wire break detection for the "on" state. See chapter Diagnostics.	BOOLEAN	RW	0
8150:03	Detect short to 24V	Enable 24 V short-circuit detection. See chapter Diagnostics.	BOOLEAN	RW	0
8150:04	Safe state active	Enable the function "Safe state". See chapter <a href="#">Behavior on EtherCAT failure</a> [► 120].	BOOLEAN	RW	1
8150:05	Safe state value	Default of Safe state. See chapter <a href="#">Behavior on EtherCAT failure</a> [► 120].	BOOLEAN	RW	0
8150:06	Use output as power supply	0: The output can be switched via the process data. 1: The output is permanently switched on. See chapter <a href="#">Switching outputs</a> [► 119].	BOOLEAN	RW	1

Index (hex)	Name	Meaning	Data type	Flags	Default
8160:0	DO Settings Ch.07	Parameters for the sensor supply output at connection X07. See chapter <a href="#">Configure sensor supply (EP1839-0042)</a> [► 119].	UINT8	RO	0x06 (6 <sub>dec</sub> )
8160:01	Detect openload in off state	Enable wire break detection for the "off" state. See chapter Diagnostics.	BOOLEAN	RW	0
8160:02	Detect openload in on state	Enable wire break detection for the "on" state. See chapter Diagnostics.	BOOLEAN	RW	0
8160:03	Detect short to 24V	Enable 24 V short-circuit detection. See chapter Diagnostics.	BOOLEAN	RW	0
8160:04	Safe state active	Enable the function "Safe state". See chapter <a href="#">Behavior on EtherCAT failure</a> [► 120].	BOOLEAN	RW	1
8160:05	Safe state value	Default of Safe state. See chapter <a href="#">Behavior on EtherCAT failure</a> [► 120].	BOOLEAN	RW	0
8160:06	Use output as power supply	0: The output can be switched via the process data. 1: The output is permanently switched on. See chapter <a href="#">Switching outputs</a> [► 119].	BOOLEAN	RW	1

Index (hex)	Name	Meaning	Data type	Flags	Default
8170:0	DO Settings Ch.08	Parameters for the sensor supply output at connection X08.  See chapter <a href="#">Configure sensor supply (EP1839-0042)</a> [► 119].	UINT8	RO	0x06 (6 <sub>dec</sub> )
8170:01	Detect openload in off state	Enable wire break detection for the "off" state.  See chapter <a href="#">Diagnostics</a> .	BOOLEAN	RW	0
8170:02	Detect openload in on state	Enable wire break detection for the "on" state.  See chapter <a href="#">Diagnostics</a> .	BOOLEAN	RW	0
8170:03	Detect short to 24V	Enable 24 V short-circuit detection.  See chapter <a href="#">Diagnostics</a> .	BOOLEAN	RW	0
8170:04	Safe state active	Enable the function "Safe state".  See chapter <a href="#">Behavior on EtherCAT failure</a> [► 120].	BOOLEAN	RW	1
8170:05	Safe state value	Default of Safe state.  See chapter <a href="#">Behavior on EtherCAT failure</a> [► 120].	BOOLEAN	RW	0
8170:06	Use output as power supply	0: The output can be switched via the process data. 1: The output is permanently switched on.  See chapter <a href="#">Switching outputs</a> [► 119].	BOOLEAN	RW	1

Index (hex)	Name	Meaning	Data type	Flags	Default
F000:0	Modular Device Profile	General information for the modular device profile	UINT8	RO	0x02 (2 <sub>dec</sub> )
F000:01	Index distance	Index distance of the objects of the individual channels	UINT16	RO	0x0010 (16 <sub>dec</sub> )
F000:02	Maximum number of modules	Number of channels	UINT16	RO	0x0018 (24 <sub>dec</sub> )

Index (hex)	Name	Meaning	Data type	Flags	Default
F008:0	Code word	reserved	UINT32	RW	0x00000000 (0 <sub>dec</sub> )

Index (hex)	Name	Meaning	Data type	Flags	Default
F010:0	Module Profile List	Maximum subindex	UINT8	RO	0x18 (24 <sub>dec</sub> )
F010:01	SubIndex 001	reserved	UINT32	RO	0x00000064 (100 <sub>dec</sub> )
F010:02	SubIndex 002	reserved	UINT32	RO	0x00000064 (100 <sub>dec</sub> )
F010:03	SubIndex 003	reserved	UINT32	RO	0x00000064 (100 <sub>dec</sub> )
F010:04	SubIndex 004	reserved	UINT32	RO	0x00000064 (100 <sub>dec</sub> )
F010:05	SubIndex 005	reserved	UINT32	RO	0x00000064 (100 <sub>dec</sub> )
F010:06	SubIndex 006	reserved	UINT32	RO	0x00000064 (100 <sub>dec</sub> )
F010:07	SubIndex 007	reserved	UINT32	RO	0x00000064 (100 <sub>dec</sub> )
F010:08	SubIndex 008	reserved	UINT32	RO	0x00000064 (100 <sub>dec</sub> )
F010:09	SubIndex 009	reserved	UINT32	RO	0x00000064 (100 <sub>dec</sub> )
F010:0A	SubIndex 010	reserved	UINT32	RO	0x00000064 (100 <sub>dec</sub> )
F010:0B	SubIndex 011	reserved	UINT32	RO	0x00000064 (100 <sub>dec</sub> )
F010:0C	SubIndex 012	reserved	UINT32	RO	0x00000064 (100 <sub>dec</sub> )
F010:0D	SubIndex 013	reserved	UINT32	RO	0x00000064 (100 <sub>dec</sub> )
F010:0E	SubIndex 014	reserved	UINT32	RO	0x00000064 (100 <sub>dec</sub> )
F010:0F	SubIndex 015	reserved	UINT32	RO	0x00000064 (100 <sub>dec</sub> )
F010:10	SubIndex 016	reserved	UINT32	RO	0x00000064 (100 <sub>dec</sub> )
F010:11	SubIndex 017	reserved	UINT32	RO	0x000000C8 (200 <sub>dec</sub> )
F010:12	SubIndex 018	reserved	UINT32	RO	0x000000C8 (200 <sub>dec</sub> )
F010:13	SubIndex 019	reserved	UINT32	RO	0x000000C8 (200 <sub>dec</sub> )
F010:14	SubIndex 020	reserved	UINT32	RO	0x000000C8 (200 <sub>dec</sub> )
F010:15	SubIndex 021	reserved	UINT32	RO	0x000000C8 (200 <sub>dec</sub> )
F010:16	SubIndex 022	reserved	UINT32	RO	0x000000C8 (200 <sub>dec</sub> )
F010:17	SubIndex 023	reserved	UINT32	RO	0x000000C8 (200 <sub>dec</sub> )
F010:18	SubIndex 024	reserved	UINT32	RO	0x000000C8 (200 <sub>dec</sub> )

Index (hex)	Name	Meaning	Data type	Flags	Default
F600:0	DEV Inputs	Process data	UINT8	RO	0x0F (15 <sub>dec</sub> )
F600:01	Undervoltage Us		BOOLEAN	RO	0x00 (0 <sub>dec</sub> )
F600:03	Overtemperature		BOOLEAN	RO	0x00 (0 <sub>dec</sub> )
F600:0D	Diag		BOOLEAN	RO	0x00 (0 <sub>dec</sub> )
F600:0E	TxPDO State		BOOLEAN	RO	0x00 (0 <sub>dec</sub> )
F600:0F	Input cycle counter		BIT2	RO	0x00 (0 <sub>dec</sub> )

Index (hex)	Name	Meaning	Data type	Flags	Default
F900:0	DEV Info data	Maximum subindex	UINT8	RO	0x04 (4 <sub>dec</sub> )
F900:02	Internal Temperature	Internal temperature	INT8	RO	0x00 (0 <sub>dec</sub> )
F900:04	Voltage Us	Measured value of the supply voltage U <sub>s</sub>	UINT16	RO	0x0000 (0 <sub>dec</sub> )

Index (hex)	Name	Meaning	Data type	Flags	Default
FB00:0	DEV Command	Command interface	UINT8	RO	0x03 (3 <sub>dec</sub> )
FB00:01	Request	Request	OCTET-STRING[2]	RW	{0}
FB00:02	Status	Status	UINT8	RO	0x00 (0 <sub>dec</sub> )
FB00:03	Response	Response	OCTET-STRING[8]	RO	{0}

## 8 Appendix

### 8.1 General operating conditions

#### Protection rating according to IP code

The degrees of protection are defined and divided into different classes in the IEC 60529 standard (EN 60529). Degrees of protection are designated by the letters "IP" and two numerals: **IPxy**

- Numeral x: Dust protection and contact protection
- Numeral y: Protection against water

x	Meaning
0	Not protected
1	Protected against access to dangerous parts with the back of the hand. Protected against solid foreign objects of 50 mm Ø
2	Protected against access to dangerous parts with a finger. Protected against solid foreign objects of 12.5 mm Ø
3	Protected against access to dangerous parts with a tool. Protected against solid foreign objects of 2.5 mm Ø
4	Protected against access to dangerous parts with a wire. Protected against solid foreign objects of 1 mm Ø
5	Protection against access to dangerous parts with a wire. Dust-protected. Ingress of dust is not prevented completely, although the quantity of dust able to penetrate is limited to such an extent that the proper function of the device and safety are not impaired
6	Protection against access to dangerous parts with a wire. Dust-tight. No ingress of dust

y	Meaning
0	Not protected
1	Protection against vertically falling water drops
2	Protection against vertically falling water drops when enclosure tilted up to 15°
3	Protection against spraying water. Water sprayed at an angle of up to 60° on either side of the vertical shall have no harmful effects
4	Protection against splashing water. Water splashed against the enclosure from any direction shall have no harmful effects
5	Protection against water jets.
6	Protection against powerful water jets.
7	Protected against the effects of temporary immersion in water. Ingress of water in quantities causing harmful effects shall not be possible when the enclosure is immersed in water at a depth of 1 m for 30 minutes

#### Chemical resistance

The resistance refers to the housing of the IP67 modules and the metal parts used. In the table below you will find some typical resistances.

Type	Resistance
Water vapor	unstable at temperatures > 100 °C
Sodium hydroxide solution (ph value > 12)	stable at room temperature unstable > 40 °C
Acetic acid	unstable
Argon (technically pure)	stable

#### Key

- resistant: Lifetime several months
- non inherently resistant: Lifetime several weeks
- not resistant: Lifetime several hours resp. early decomposition



## 8.2 Accessories

### Mounting

Ordering information	Description	Link
ZS5300-0011	Mounting rail	<a href="#">Website</a>

### Cables

A complete overview of pre-assembled cables for fieldbus components can be found [here](#).

Ordering information	Description	Link
ZK1090-3xxx-xxxx	EtherCAT cable M8, green	<a href="#">Website</a>
ZK1093-3xxx-xxxx	EtherCAT cable M8, yellow	<a href="#">Website</a>
ZK1090-6xxx-xxxx	EtherCAT cable M12, green	<a href="#">Website</a>
ZK2000-2xxx-xxxx	Sensor cable M8, 3-pin	<a href="#">Website</a>
ZK2000-3xxx-xxxx	Sensor cable M8, 4-pin	<a href="#">Website</a>
ZK2000-6xxx-xxxx	Sensor cable M12, 4-pin	<a href="#">Website</a>
ZK2000-7xxx-0xxx	Sensor cable M12, 4-pin + shield	<a href="#">Website</a>
ZK2020-3xxx-xxxx	Power cable M8, 4-pin	<a href="#">Website</a>
ZK203x-xxxx-xxxx	Power cable 7/8", 5-pin	<a href="#">Website</a>

### Labeling material, protective caps

Ordering information	Description
ZS5000-0010	Protective cap for M8 sockets, IP67 (50 pieces)
ZS5000-0020	Protective cap for M12 sockets, IP67 (50 pcs.)
ZS5100-0000	Inscription labels, unprinted, 4 strips of 10
ZS5000-xxxx	Printed inscription labels on enquiry

### Tools

Ordering information	Description
ZB8801-0000	Torque wrench for plugs, 0.4...1.0 Nm
ZB8801-0001	Torque cable key for M8 / wrench size 9 for ZB8801-0000
ZB8801-0002	Torque cable key for M12 / wrench size 13 for ZB8801-0000
ZB8801-0003	Torque cable key for M12 field assembly / wrench size 18 for ZB8801-0000



#### Further accessories

Further accessories can be found in the price list for fieldbus components from Beckhoff and online at <https://www.beckhoff.com>.

## 8.3 Version identification of EtherCAT devices

### 8.3.1 General notes on marking

#### Designation

A Beckhoff EtherCAT device has a 14-digit designation, made up of

- family key
- type
- version
- revision

Example	Family	Type	Version	Revision
EL3314-0000-0016	EL terminal 12 mm, non-pluggable connection level	3314 4-channel thermocouple terminal	0000 basic type	0016
ES3602-0010-0017	ES terminal 12 mm, pluggable connection level	3602 2-channel voltage measurement	0010 high-precision version	0017
CU2008-0000-0000	CU device	2008 8-port fast ethernet switch	0000 basic type	0000

#### Notes

- The elements mentioned above result in the **technical designation**. EL3314-0000-0016 is used in the example below.
- EL3314-0000 is the order identifier, in the case of “-0000” usually abbreviated to EL3314. “-0016” is the EtherCAT revision.
- The **order identifier** is made up of
  - family key (EL, EP, CU, ES, KL, CX, etc.)
  - type (3314)
  - version (-0000)
- The **revision** -0016 shows the technical progress, such as the extension of features with regard to the EtherCAT communication, and is managed by Beckhoff.  
In principle, a device with a higher revision can replace a device with a lower revision, unless specified otherwise, e.g. in the documentation.  
Associated and synonymous with each revision there is usually a description (ESI, EtherCAT Slave Information) in the form of an XML file, which is available for download from the Beckhoff web site.  
From 2014/01 the revision is shown on the outside of the IP20 terminals, see Fig. “EL5021 EL terminal, standard IP20 IO device with batch number and revision ID (since 2014/01)”.
- The type, version and revision are read as decimal numbers, even if they are technically saved in hexadecimal.

### 8.3.2 Version identification of IP67 modules

The serial number/ data code for Beckhoff IO devices is usually the 8-digit number printed on the device or on a sticker. The serial number indicates the configuration in delivery state and therefore refers to a whole production batch, without distinguishing the individual modules of a batch.

Structure of the serial number: **KK YY FF HH**

KK - week of production (CW, calendar week)  
 YY - year of production  
 FF - firmware version  
 HH - hardware version

Example with serial number 12 06 3A 02:

12 - production week 12  
 06 - production year 2006  
 3A - firmware version 3A  
 02 - hardware version 02

Exceptions can occur in the **IP67 area**, where the following syntax can be used (see respective device documentation):

Syntax: D ww yy x y z u

D - prefix designation  
 ww - calendar week  
 yy - year  
 x - firmware version of the bus PCB  
 y - hardware version of the bus PCB  
 z - firmware version of the I/O PCB  
 u - hardware version of the I/O PCB

Example: D.22081501 calendar week 22 of the year 2008 firmware version of bus PCB: 1 hardware version of bus PCB: 5 firmware version of I/O PCB: 0 (no firmware necessary for this PCB) hardware version of I/O PCB: 1

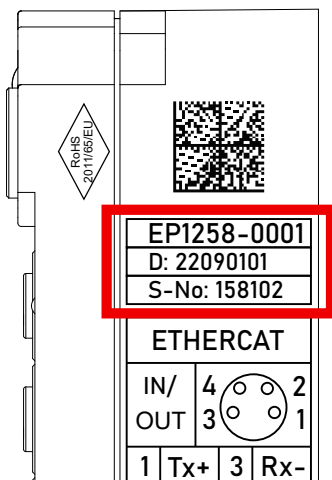

Fig. 42: EP1258-00001 IP67 EtherCAT Box with batch number/DateCode 22090101 and unique serial number 158102

### 8.3.3 Beckhoff Identification Code (BIC)

The Beckhoff Identification Code (BIC) is increasingly being applied to Beckhoff products to uniquely identify the product. The BIC is represented as a Data Matrix Code (DMC, code scheme ECC200), the content is based on the ANSI standard MH10.8.2-2016.



Fig. 43: BIC as data matrix code (DMC, code scheme ECC200)

The BIC will be introduced step by step across all product groups.

Depending on the product, it can be found in the following places:

- on the packaging unit
- directly on the product (if space suffices)
- on the packaging unit and the product

The BIC is machine-readable and contains information that can also be used by the customer for handling and product management.

Each piece of information can be uniquely identified using the so-called data identifier (ANSI MH10.8.2-2016). The data identifier is followed by a character string. Both together have a maximum length according to the table below. If the information is shorter, spaces are added to it.

Following information is possible, positions 1 to 4 are always present, the other according to need of production:

Position	Type of information	Explanation	Data identifier	Number of digits incl. data identifier	Example
1	Beckhoff order number	<b>Beckhoff order number</b>	1P	8	<b>1P</b> 072222
2	Beckhoff Traceability Number (BTN)	<b>Unique serial number, see note below</b>	SBTN	12	<b>S</b> BTNk4p562d7
3	Article description	<b>Beckhoff article description, e.g. EL1008</b>	1K	32	<b>1K</b> EL1809
4	Quantity	<b>Quantity in packaging unit, e.g. 1, 10, etc.</b>	Q	6	<b>Q</b> 1
5	Batch number	Optional: Year and week of production	2P	14	<b>2P</b> 401503180016
6	ID/serial number	Optional: Present-day serial number system, e.g. with safety products	51S	12	<b>51S</b> 678294
7	Variant number	Optional: Product variant number on the basis of standard products	30P	32	<b>30P</b> F971, 2*K183
...					

Further types of information and data identifiers are used by Beckhoff and serve internal processes.

**Structure of the BIC**

Example of composite information from positions 1 to 4 and with the above given example value on position 6. The data identifiers are highlighted in bold font:

**1P**072222**S**BTNk4p562d7**1K**EL1809 **Q**1 **51S**678294

Accordingly as DMC:



Fig. 44: Example DMC **1P**072222**S**BTNk4p562d7**1K**EL1809 **Q**1 **51S**678294

**BTN**

An important component of the BIC is the Beckhoff Traceability Number (BTN, position 2). The BTN is a unique serial number consisting of eight characters that will replace all other serial number systems at Beckhoff in the long term (e.g. batch designations on IO components, previous serial number range for safety products, etc.). The BTN will also be introduced step by step, so it may happen that the BTN is not yet coded in the BIC.

**NOTICE**

This information has been carefully prepared. However, the procedure described is constantly being further developed. We reserve the right to revise and change procedures and documentation at any time and without prior notice. No claims for changes can be made from the information, illustrations and descriptions in this information.

## 8.3.4 Electronic access to the BIC (eBIC)

### Electronic BIC (eBIC)

The Beckhoff Identification Code (BIC) is applied to the outside of Beckhoff products in a visible place. If possible, it should also be electronically readable.

Decisive for the electronic readout is the interface via which the product can be electronically addressed.

### K-bus devices (IP20, IP67)

Currently, no electronic storage and readout is planned for these devices.

### EtherCAT devices (IP20, IP67)

All Beckhoff EtherCAT devices have a so-called ESI-EEPROM, which contains the EtherCAT identity with the revision number. Stored in it is the EtherCAT slave information, also colloquially known as ESI/XML configuration file for the EtherCAT master. See the corresponding chapter in the EtherCAT system manual ([Link](#)) for the relationships.

The eBIC is also stored in the ESI-EEPROM. The eBIC was introduced into the Beckhoff I/O production (terminals, box modules) from 2020; widespread implementation is expected in 2021.

The user can electronically access the eBIC (if existent) as follows:

- With all EtherCAT devices, the EtherCAT master (TwinCAT) can read the eBIC from the ESI-EEPROM
  - From TwinCAT 3.1 build 4024.11, the eBIC can be displayed in the online view.
  - To do this, check the checkbox "Show Beckhoff Identification Code (BIC)" under EtherCAT → Advanced Settings → Diagnostics:
  - The BTN and its contents are then displayed:
  - Note: as can be seen in the illustration, the production data HW version, FW version and production date, which have been programmed since 2012, can also be displayed with "Show Production Info".
  - Access from the PLC: From TwinCAT 3.1. build 4024.24 the functions *FB\_EcReadBIC* and *FB\_EcReadBTN* are available in the Tc2\_EtherCAT Library from v3.3.19.0 for reading into the PLC..
- In the case of EtherCAT devices with CoE directory, the object 0x10E2:01 can additionally be used to display the device's own eBIC; the PLC can also simply access the information here:
  - The device must be in PREOP/SAFEOP/OP for access:
  - The object 0x10E2 will be introduced into stock products in the course of a necessary firmware revision.
  - From TwinCAT 3.1. build 4024.24 the functions *FB\_EcCoEReadBIC* and *FB\_EcCoEReadBTN* are available in the Tc2\_EtherCAT Library from v3.3.19.0 for reading into the PLC.
- For processing the BIC/BTN data in the PLC, the following auxiliary functions are available in *Tc2\_Uutilities* from TwinCAT 3.1 build 4024.24 onwards
  - *F\_SplitBIC*: The function splits the Beckhoff Identification Code (BIC) sBICValue into its components based on known identifiers and returns the recognized partial strings in a structure *ST\_SplitBIC* as return value.
  - *BIC\_TO\_BTN*: The function extracts the BTN from the BIC and returns it as a value.
- Note: in the case of electronic further processing, the BTN is to be handled as a string(8); the identifier "SBTN" is not part of the BTN.
- Technical background  
The new BIC information is additionally written as a category in the ESI-EEPROM during the device production. The structure of the ESI content is largely dictated by the ETG specifications, therefore the

additional vendor-specific content is stored with the help of a category according to ETG.2010. ID 03 indicates to all EtherCAT masters that they must not overwrite these data in case of an update or restore the data after an ESI update.

The structure follows the content of the BIC, see there. This results in a memory requirement of approx. 50..200 bytes in the EEPROM.

- Special cases
  - If multiple, hierarchically arranged ESCs are installed in a device, only the top-level ESC carries the eBIC Information.
  - If multiple, non-hierarchically arranged ESCs are installed in a device, all ESCs carry the eBIC Information.
  - If the device consists of several sub-devices with their own identity, but only the top-level device is accessible via EtherCAT, the eBIC of the top-level device is located in the CoE object directory 0x10E2:01 and the eBICs of the sub-devices follow in 0x10E2:nn.

#### **PROFIBUS, PROFINET, DeviceNet devices etc.**

Currently, no electronic storage and readout is planned for these devices.

## 8.4 Support and Service

Beckhoff and their partners around the world offer comprehensive support and service, making available fast and competent assistance with all questions related to Beckhoff products and system solutions.

### Beckhoff's branch offices and representatives

Please contact your Beckhoff branch office or representative for local support and service on Beckhoff products!

The addresses of Beckhoff's branch offices and representatives round the world can be found on her internet pages: [www.beckhoff.com](http://www.beckhoff.com)

You will also find further documentation for Beckhoff components there.

### Support

The Beckhoff Support offers you comprehensive technical assistance, helping you not only with the application of individual Beckhoff products, but also with other, wide-ranging services:

- support
- design, programming and commissioning of complex automation systems
- and extensive training program for Beckhoff system components

Hotline: +49 5246 963 157  
e-mail: [support@beckhoff.com](mailto:support@beckhoff.com)  
web: [www.beckhoff.com/support](http://www.beckhoff.com/support)

### Service

The Beckhoff Service Center supports you in all matters of after-sales service:

- on-site service
- repair service
- spare parts service
- hotline service

Hotline: +49 5246 963 460  
e-mail: [service@beckhoff.com](mailto:service@beckhoff.com)  
web: [www.beckhoff.com/service](http://www.beckhoff.com/service)

### Headquarters Germany

Beckhoff Automation GmbH & Co. KG

Hülshorstweg 20  
33415 Verl  
Germany

Phone: +49 5246 963 0  
e-mail: [info@beckhoff.com](mailto:info@beckhoff.com)  
web: [www.beckhoff.com](http://www.beckhoff.com)





Beckhoff Automation GmbH & Co. KG  
Hülshorstweg 20  
33415 Verl  
Germany  
Phone: +49 5246 9630  
[info@beckhoff.com](mailto:info@beckhoff.com)  
[www.beckhoff.com](http://www.beckhoff.com)