

Documentation | EN

EPP4314-1002

2-channel analog input + 2-channel analog output



Table of contents

1 Foreword	5
1.1 Safety instructions.....	5
1.2 Notes on the documentation	6
1.3 Documentation Issue Status	7
2 Product group: EtherCAT P Box modules	8
3 Product overview	9
3.1 Introduction	10
3.2 Technical data.....	11
3.2.1 Digital inputs.....	12
3.2.2 Analog inputs	12
3.2.3 Analog outputs	13
3.2.4 Measuring ranges	14
3.2.5 Output signal ranges.....	20
3.3 Scope of supply.....	23
3.4 Process image	24
4 Mounting and connections	26
4.1 Mounting	26
4.1.1 Dimensions	26
4.1.2 Fixing.....	27
4.1.3 Functional earth (FE)	27
4.2 Connections	28
4.2.1 Connector overview	28
4.2.2 EtherCAT P	29
4.2.3 Signal inputs and outputs.....	33
4.3 UL Requirements	37
4.4 Disposal	38
5 Commissioning and configuration	39
5.1 Integrating into a TwinCAT project.....	39
5.2 Analog inputs	40
5.2.1 Signal flow.....	40
5.2.2 Measuring range	41
5.2.3 Filter	46
5.2.4 Limit value monitoring	48
5.2.5 Calibration and scaling.....	49
5.3 Analog outputs	52
5.3.1 Signal flow.....	52
5.3.2 Output signal range.....	53
5.3.3 Diagnosis	54
5.3.4 Behavior in case of a communication interruption: Watchdog	55
5.3.5 Calibration and scaling.....	58
5.4 Restore the delivery state	61
6 CoE parameters	62
6.1 Object directory	62

6.2	Object description	64
6.2.1	Objects for parameterization	64
6.2.2	Standard objects	66
6.2.3	Profile-specific objects	72
7	Appendix	76
7.1	General operating conditions	76
7.2	Accessories	77
7.3	Continuative documentation for I/O components with analog in and outputs	78
7.4	Version identification of EtherCAT devices	79
7.4.1	General notes on marking	79
7.4.2	Version identification of IP67 modules	80
7.4.3	Beckhoff Identification Code (BIC)	81
7.4.4	Electronic access to the BIC (eBIC)	83
7.5	Support and Service	85

1 Foreword

1.1 Safety instructions

Safety regulations

Please note the following safety instructions and explanations!
Product-specific safety instructions can be found on following pages or in the areas mounting, wiring, commissioning etc.

Exclusion of liability

All the components are supplied in particular hardware and software configurations appropriate for the application. Modifications to hardware or software configurations other than those described in the documentation are not permitted, and nullify the liability of Beckhoff Automation GmbH & Co. KG.

Personnel qualification

This description is only intended for trained specialists in control, automation and drive engineering who are familiar with the applicable national standards.

Signal words

The signal words used in the documentation are classified below. In order to prevent injury and damage to persons and property, read and follow the safety and warning notices.

Personal injury warnings

DANGER

Hazard with high risk of death or serious injury.

WARNING

Hazard with medium risk of death or serious injury.

CAUTION

There is a low-risk hazard that could result in medium or minor injury.

Warning of damage to property or environment

NOTICE

The environment, equipment, or data may be damaged.

Information on handling the product



This information includes, for example:
recommendations for action, assistance or further information on the product.

1.2 Notes on the documentation

Intended audience

This description is only intended for the use of trained specialists in control and automation engineering who are familiar with the applicable national standards.

It is essential that the documentation and the following notes and explanations are followed when installing and commissioning these components.

The qualified personnel is obliged to always use the currently valid documentation.

The responsible staff must ensure that the application or use of the products described satisfy all the requirements for safety, including all the relevant laws, regulations, guidelines and standards.

Disclaimer

The documentation has been prepared with care. The products described are, however, constantly under development.

We reserve the right to revise and change the documentation at any time and without prior announcement.

No claims for the modification of products that have already been supplied may be made on the basis of the data, diagrams and descriptions in this documentation.

Trademarks

Beckhoff®, TwinCAT®, TwinCAT/BSD®, TC/BSD®, EtherCAT®, EtherCAT G®, EtherCAT G10®, EtherCAT P®, Safety over EtherCAT®, TwinSAFE®, XFC®, XTS® and XPlanar® are registered trademarks of and licensed by Beckhoff Automation GmbH. Other designations used in this publication may be trademarks whose use by third parties for their own purposes could violate the rights of the owners.

Patent Pending

The EtherCAT Technology is covered, including but not limited to the following patent applications and patents: EP1590927, EP1789857, EP1456722, EP2137893, DE102015105702 with corresponding applications or registrations in various other countries.



EtherCAT® is registered trademark and patented technology, licensed by Beckhoff Automation GmbH, Germany.

Copyright

© Beckhoff Automation GmbH & Co. KG, Germany.

The reproduction, distribution and utilization of this document as well as the communication of its contents to others without express authorization are prohibited.

Offenders will be held liable for the payment of damages. All rights reserved in the event of the grant of a patent, utility model or design.

1.3 Documentation Issue Status

Version	Comment
1.3	<ul style="list-style-type: none">EPP4314-1002 added
1.2	<ul style="list-style-type: none">EtherCAT P status LEDs updated
1.1	<ul style="list-style-type: none">Technical data updatedStructure update
1.0	<ul style="list-style-type: none">First release

Firmware and hardware versions

This documentation refers to the firmware and hardware version that was applicable at the time the documentation was written.

The module features are continuously improved and developed further. Modules having earlier production statuses cannot have the same properties as modules with the latest status. However, existing properties are retained and are not changed, so that older modules can always be replaced with new ones.

The firmware and hardware version (delivery state) can be found in the batch number (D-number) printed on the side of the EtherCAT Box.

Syntax of the batch number (D-number)

D: WW YY FF HH

WW - week of production (calendar week)

YY - year of production

FF - firmware version

HH - hardware version

Example with D no. 29 10 02 01:

29 - week of production 29

10 - year of production 2010

02 - firmware version 02

01 - hardware version 01

Further information on this topic: [Version identification of EtherCAT devices \[► 79\]](#).

2 Product group: EtherCAT P Box modules

EtherCAT P

EtherCAT P supplements the EtherCAT technology with a process in which communication and supply voltages are transmitted on a common line. All EtherCAT properties are retained with this process.

Two supply voltages are transmitted per EtherCAT P line. The supply voltages are electrically isolated from each other and can therefore be switched individually. The nominal supply voltage for both is $24 V_{DC}$.

EtherCAT P uses the same cable structure as EtherCAT: a 4-core Ethernet cable with M8 connectors. The connectors are mechanically coded so that EtherCAT connectors and EtherCAT P connectors cannot be interchanged.

EtherCAT P Box modules

EtherCAT P Box modules are EtherCAT P slaves with degree of protection IP67. They are designed for operation in wet, dirty or dusty industrial environments.

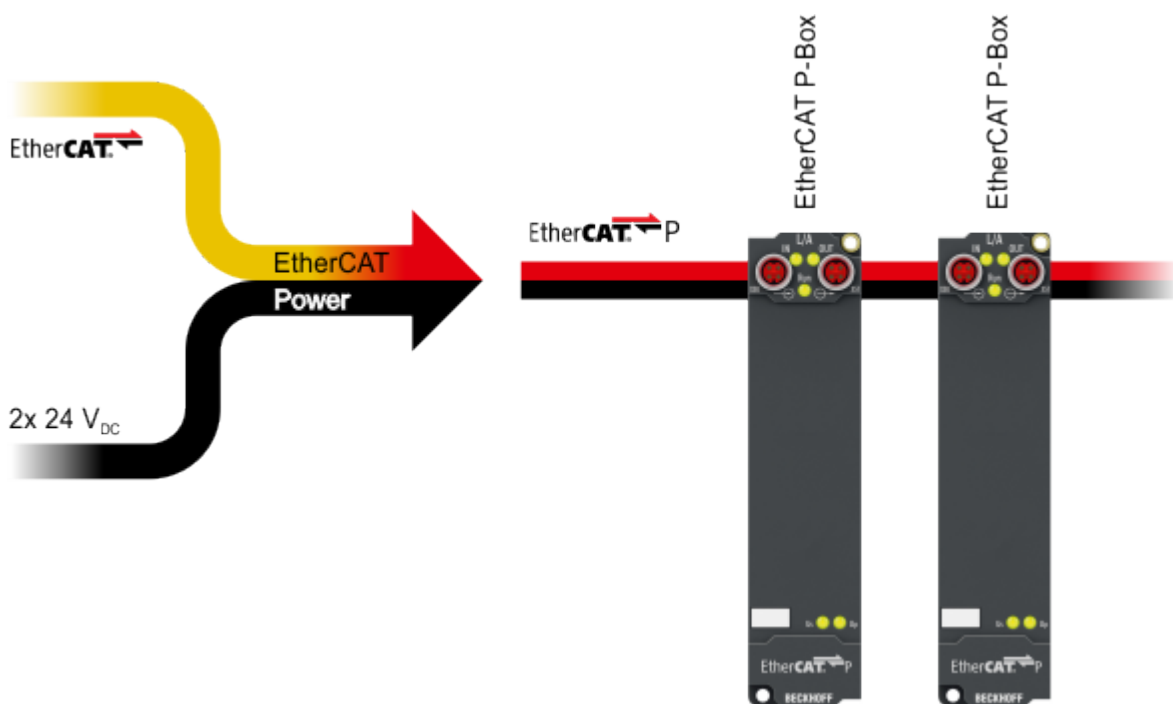

i EtherCAT basics

A detailed description of the EtherCAT system can be found in the [EtherCAT system documentation](#).

3 Product overview

Module	Measured variable and output value
EPP4304-1002	Voltage
EPP4314-1002	Current

3.1 Introduction

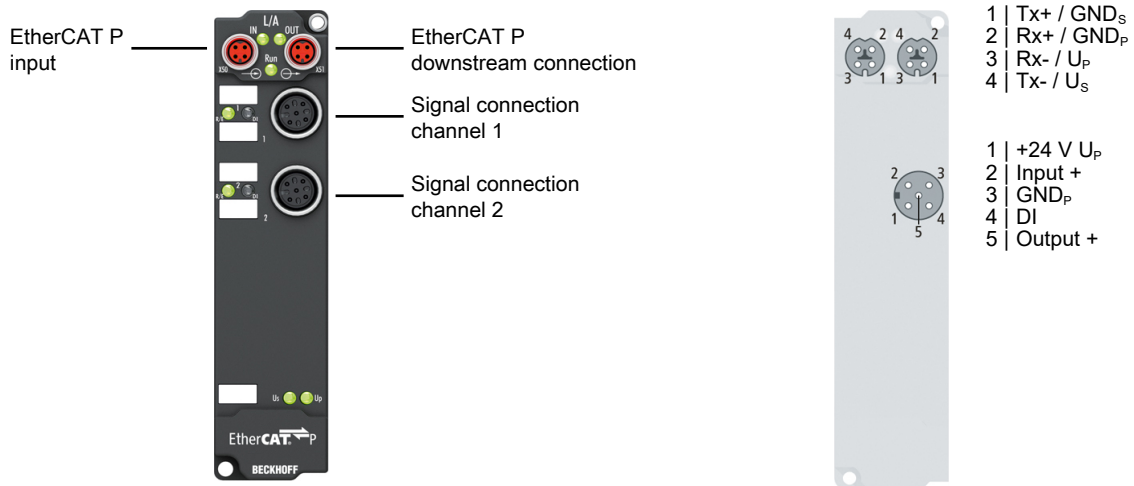

2-channel analog input + 2-channel analog output, parameterizable, 16-bit

The EPP43x4-1002 EtherCAT P Box modules have two analog inputs, two analog outputs and two digital inputs. The analog inputs and outputs can be parameterized individually. The following measuring ranges and output ranges are available:

- EPP4304-1002: ± 10 V
- EPP4314-1002: ± 10 mA or ± 20 mA

The resolution of the measuring signals and output signals is 16 bit. The two output channels have a common ground potential with the supply voltage $24 V_{DC}$ U_P.

A digital type 3 input with 10 μ s input filter time and an analog input and an analog output are arranged on one M12 socket each. Since the digital input as well as the analog inputs and outputs are arranged together on one M12 socket each, complex end devices can be controlled with one connection cable. This saves additional costs, cable channels and installation work.

i Misinterpretation of the measured values possible

In the factory setting the "Extended Range" mode is enabled.

In "Extended Range" mode the measuring range is slightly larger than the nominal measuring range. The value 0x7FFF corresponds to approximately 107% of the full scale value.

- Take the increased measuring range into account when evaluating the measured values. See chapter [Measuring ranges](#) [► 14].

-or-

- Set the "Legacy Range" mode. See chapter: [Nominal and technical measuring range](#) [► 43]

Quick links

[Technical data](#) [► 11]

[Dimensions](#) [► 26]

[Connections](#) [► 28]

3.2 Technical data

All values are typical values over the entire temperature range, unless stated otherwise.

EtherCAT P	
Connection	2 x M8 socket, 4-pin, P-coded, red
Distributed Clocks	yes

Supply voltages	
Connection	See EtherCAT P connection
U_S nominal voltage	24 V _{DC} (-15 % / +20 %)
U_S sum current: $I_{S,sum}$	max. 3 A
Current consumption from U_S	100 mA
Rated voltage U_P	24 V _{DC} (-15 % / +20 %)
U_P sum current: $I_{P,sum}$	max. 3 A
Current consumption from U_P	Current consumption of connected sensors and actuators

Signal inputs and outputs	
Connection	2x M12 socket, 5-pin, A-coded
Cable length	max. 30 m
Reference ground	GND _P (ground potential of the peripheral voltage U_P)
Sensor power supply	24 V _{DC} from the peripheral voltage U_P max. 0.5 A in total, short-circuit proof
Further specifications	Digital inputs [► 12] Analog inputs [► 12] Analog outputs [► 13]

Environmental conditions	
Ambient temperature during operation	-25 ... +60 °C -25 ... +55 °C according to cULus
Ambient temperature during storage	-40 ... +85 °C
Vibration resistance, shock resistance	conforms to EN 60068-2-6 / EN 60068-2-27 Additional tests [► 11]
EMC immunity / emission	conforms to EN 61000-6-2 / EN 61000-6-4
Protection class	IP65, IP66, IP67 (conforms to EN 60529)

Housing data	
Dimensions W x H x D	30 mm x 126 mm x 26.5 mm (without connectors)
Weight	approx. 165 g
Installation position	variable
Material	PA6 (polyamide)

Approvals / markings	
Approvals / markings *)	CE, cULus [► 37]

*) Real applicable approvals/markings see type plate on the side (product marking).

Additional tests

The devices have undergone the following additional tests:

Test	Explanation
Vibration	10 frequency sweeps in 3 axes
	5 Hz < f < 60 Hz displacement 0.35 mm, constant amplitude
	60.1 Hz < f < 500 Hz acceleration 5 g, constant amplitude
Shocks	1000 shocks in each direction, in 3 axes
	35 g, 11 ms

3.2.1 Digital inputs

Technical data	Digital inputs
Number	2
Characteristics	Type 3 according to EN 61131-2, compatible with type 1
Nominal voltage high level	24 V
Switching threshold	9.5 V
Input current	2.2 mA at 24 V
Input filter	10 μ s
Electrical isolation	Yes

3.2.2 Analog inputs

Technical data	EPP4304-1002	EPP4314-1002
Number	2	2
Measuring ranges	<ul style="list-style-type: none"> • -10 ... +10 V [▶ 14] • 0 ... 10 V [▶ 15] 	<ul style="list-style-type: none"> • -10 ... +10 mA [▶ 16] • -20 ... +20 mA [▶ 17] • 0 ... 20 mA [▶ 18] • 4 ... 20 mA [▶ 19]
Input type	Single-ended	
Input resistance	> 200 k Ω	85 Ω typ.
Dielectric strength	max. 30 V _{DC}	
Digital resolution	16 bit, including sign	
Measurement uncertainty	< 0.3 % of full scale value	
Largest short-term deviation during a specified electrical interference test	100 % of full scale value	
Analog input filter: cut-off frequency	5 kHz	

3.2.3 Analog outputs

Technical data	EPP4304-1002	EPP4314-1002
Number	2	2
Output signal ranges	<ul style="list-style-type: none"> • -10 ... +10 V [► 20] • 0 ... 10 V [► 20] 	<ul style="list-style-type: none"> • -10 ... +10 mA [► 21] • -20 ... +20 mA [► 21] • 0 ... 20 mA [► 22] • 4 ... 20 mA [► 22]
Digital resolution	16 bit, including sign	16 bit, including sign
Output error	< 0.1 % of the full scale value of the signal range	<p>< 0.1 % of full scale value of the signal range at an ambient temperature of 0 ... +55 °C.</p> <p>< 0.2 % of full scale value of the signal range at an ambient temperature < 0 °C or > 55 °C</p>
Load resistor / load	> 5 kΩ	max. 500 Ω
Short-circuit proof	Yes	Yes
Largest short-term deviation during a specified electrical interference test	5 % of the full scale value of the signal range	1.5 % of the full scale value of the signal range

3.2.4 Measuring ranges

3.2.4.1 Measuring range -10 ... +10 V

Technical data	Measuring range
Measuring range, nominal	-10...+10 V
Measuring range, end value (full scale value)	10 V
Measuring range, technically usable	-10.737...+10.737 V
PDO resolution	16-bit, including sign
PDO LSB (Extended Range)	327.68 μ V
PDO LSB (Legacy Range)	305.19 μ V

Factory setting: "Extended Range" mode

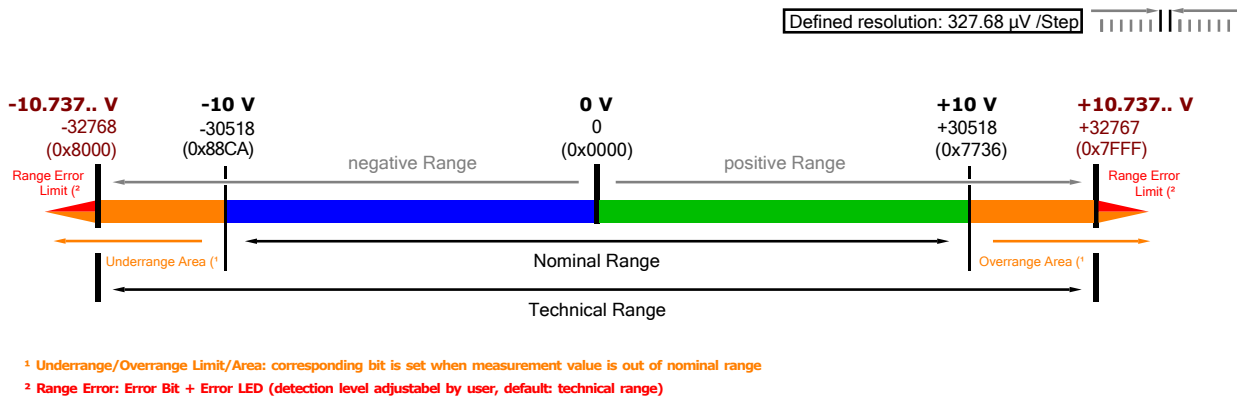

Optional: "Legacy Range" mode

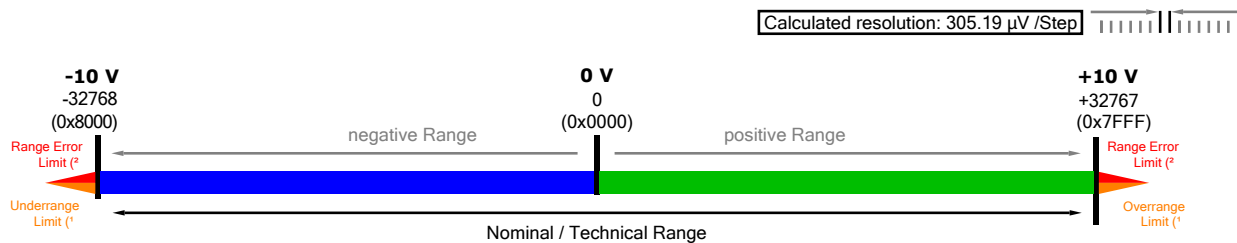

3.2.4.2 Measuring range 0 ... 10 V

Technical data	Measuring range
Measuring range, nominal	0...10 V
Measuring range, end value (full scale value)	10 V
Measuring range, technically usable	-0.093...+10.737 V
PDO resolution	16-bit, including sign
PDO LSB (Extended Range)	327.68 μ V
PDO LSB (Legacy Range)	305.19 μ V

Factory setting: "Extended Range" mode

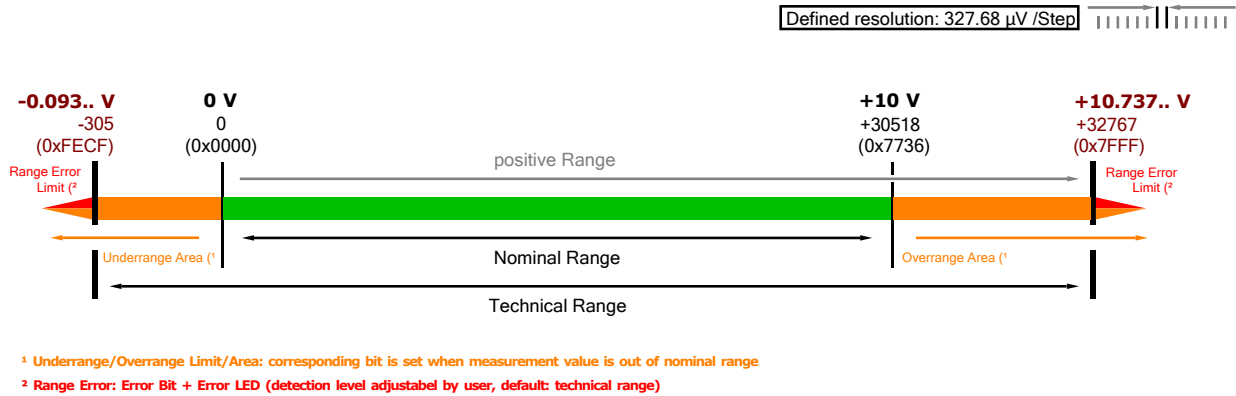

Optional: "Legacy Range" mode

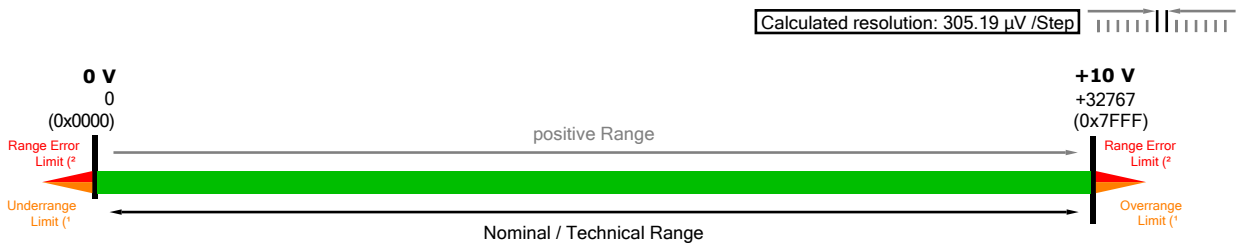

3.2.4.3 Measuring range -10 ... +10 mA

Technical data	Measuring range
Measuring range, nominal	-10...+10 mA
Measuring range, end value (full scale value)	10 mA
Measuring range, technically usable	-10.737...+10.737 mA, overcurrent-protected
Fuse protection	Internal overload limiting, continuous current resistant
PDO resolution	16-bit, including sign
PDO LSB (Extended Range)	327.68 nA
PDO LSB (Legacy Range)	305.19 nA

Factory setting: "Extended Range" mode

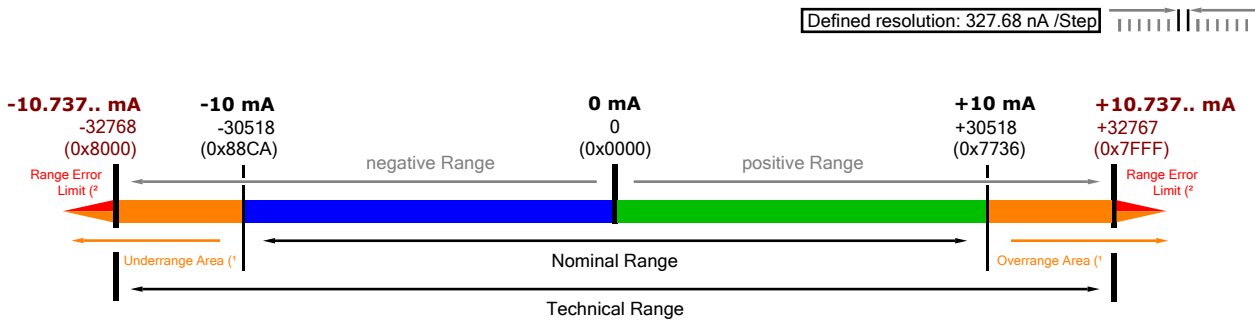

- ¹ Underrange/Overrange Limit/Area: corresponding bit is set when measurement value is out of nominal range
- ² Range Error: Error Bit + Error LED (detection level adjustable by user, default: technical range)

Optional: "Legacy Range" mode

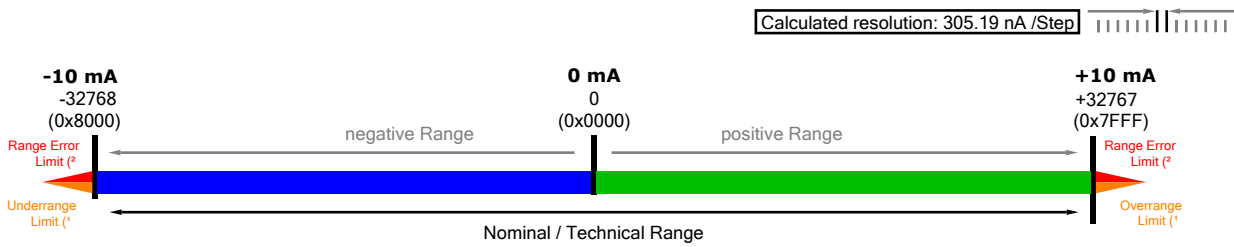

3.2.4.4 Measuring range -20 ... +20 mA

Technical data	Measuring range
Measuring range, nominal	-20...+20 mA
Measuring range, end value (full scale value)	20 mA
Measuring range, technically usable	-21.474...+21.474 mA, overcurrent-protected
Fuse protection	Internal overload limiting, continuous current resistant
PDO resolution	16-bit, including sign
PDO LSB (Extended Range)	655.35 nA
PDO LSB (Legacy Range)	610.37 nA

Factory setting: "Extended Range" mode

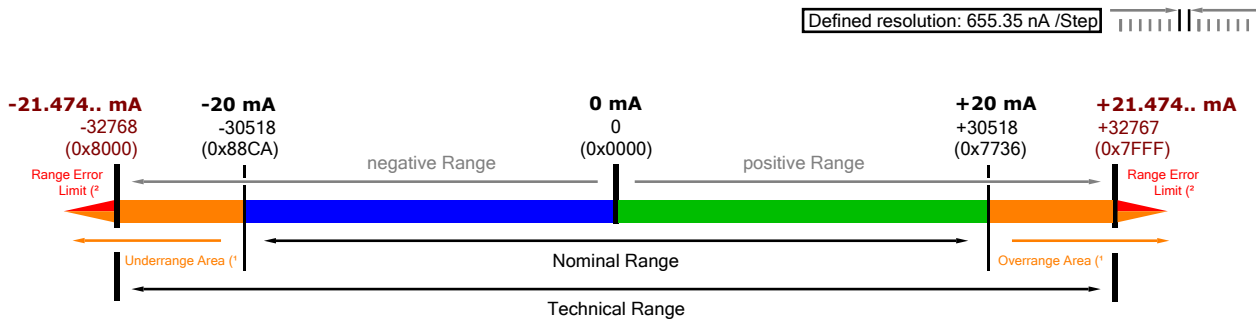

- ¹ Underrange/Overrange Limit/Area: corresponding bit is set when measurement value is out of nominal range
- ² Range Error: Error Bit + Error LED (detection level adjustable by user, default: technical range)

Optional: "Legacy Range" mode

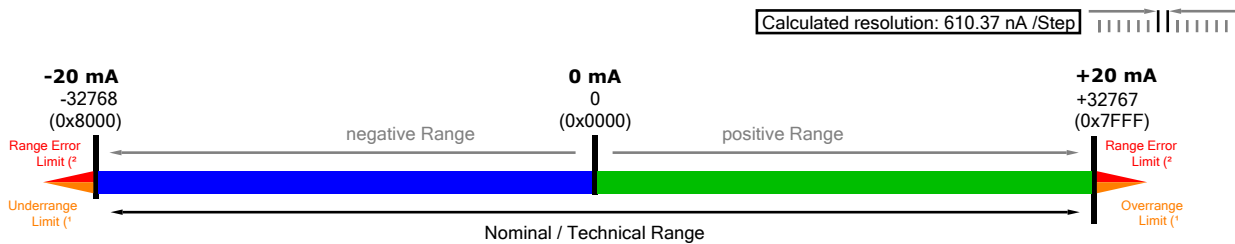

3.2.4.5 Measuring range 0 ... 20 mA

Technical data	Measuring range 0...20 mA
Measuring range, nominal	0...20 mA
Measuring range, end value (full scale value)	20 mA
Measuring range, technically usable	-0.186...+21.474 mA, overcurrent-protected
Fuse protection	Internal overload limiting, continuous current resistant
PDO resolution	16-bit, including sign
PDO LSB (Extended Range)	655.35 nA
PDO LSB (Legacy Range)	610.37 nA

Factory setting: "Extended Range" mode

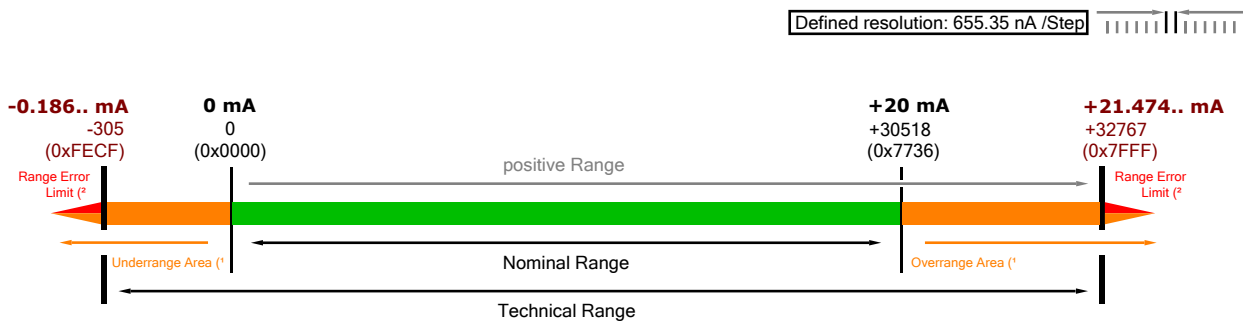

- ¹ Underrange/Overrange Limit/Area: corresponding bit is set when measurement value is out of nominal range
- ² Range Error: Error Bit + Error LED (detection level adjustable by user, default: technical range)

Optional: "Legacy Range" mode

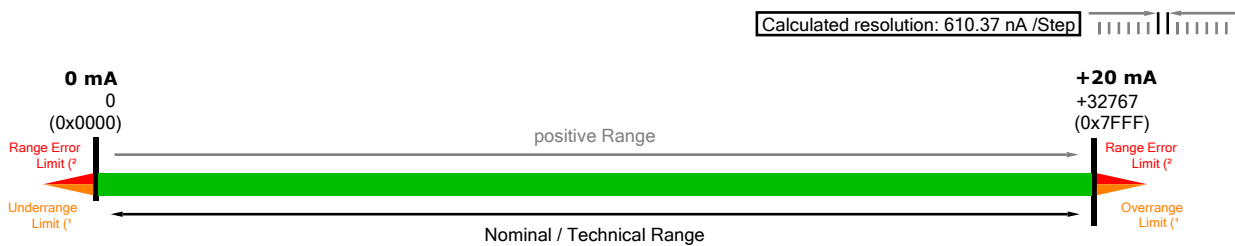

3.2.4.6 Measuring range 4 ... 20 mA

Technical data	Measuring range 4...20 mA
Measuring range, nominal	4...20 mA
Measuring range, end value (full scale value)	20 mA
Measuring range, technically usable	0...+21.179 mA, overcurrent-protected
Fuse protection	Internal overload limiting, continuous current resistant
PDO resolution	16-bit, including sign
PDO LSB (Extended Range)	524.28 nA
PDO LSB (Legacy Range)	488.30 nA

Factory setting: "Extended Range" mode

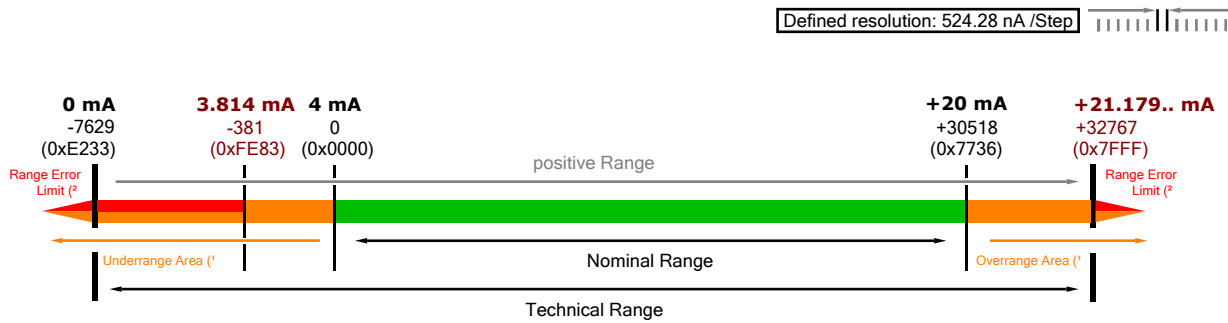

- ¹ Underrange/Overrange Limit/Area: corresponding bit is set when measurement value is out of nominal range
- ² Range Error: Error Bit + Error LED (detection level adjustable by user, default: technical range)

Optional: "Legacy Range" mode

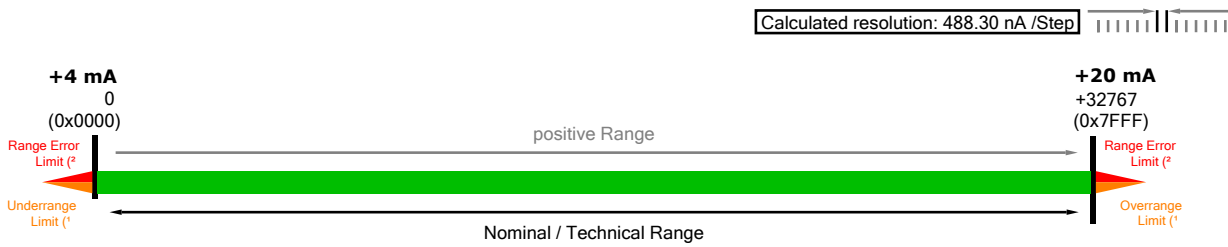

3.2.5 Output signal ranges

3.2.5.1 Output signal range -10 ... +10 V

Technical data	Output signal range -10...+10 V
Full scale value of the signal range	10 V
PDO resolution	16-bit, including sign
PDO LSB	305.19 μ V

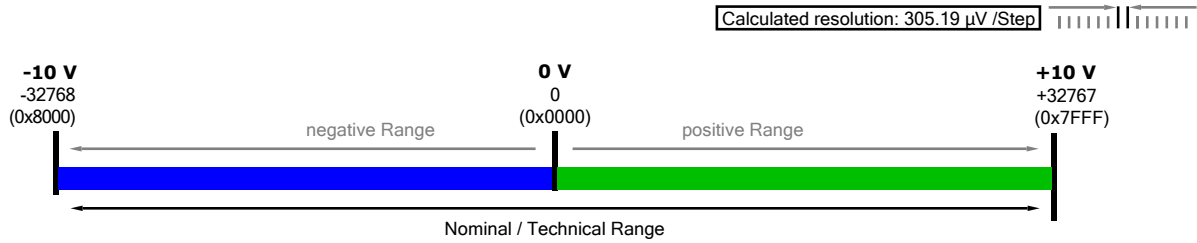

3.2.5.2 Output signal range 0 ... 10 V

Technical data	Output signal range 0...10 V
Full scale value of the signal range	10 V
PDO resolution	16-bit, including sign
PDO LSB	305.19 μ V

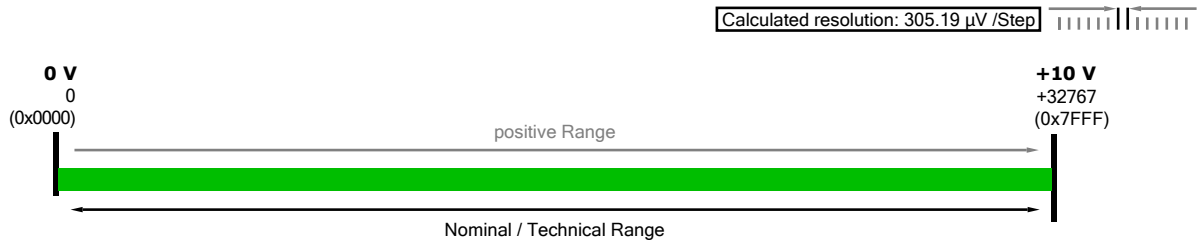

3.2.5.3 Output signal range -10 ... +10 mA

Technical data	Output signal range -10...+10 mA
Full scale value of the signal range	10 mA
PDO resolution	16-bit, including sign
PDO LSB	305.18 nA

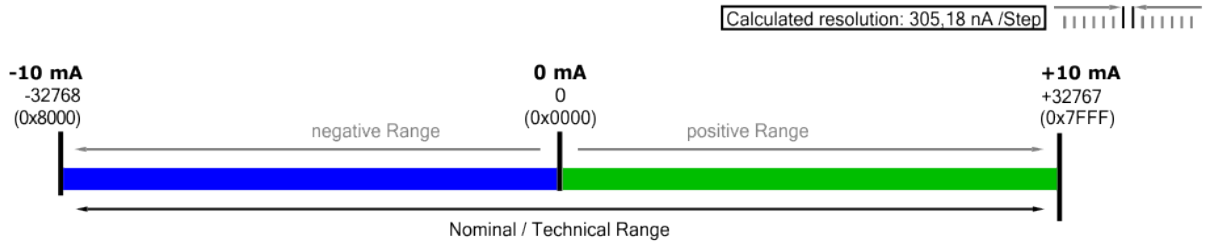

3.2.5.4 Output signal range -20 ... +20 mA

Technical data	Output signal range 4...20 mA
Full scale value of the signal range	20 mA
PDO resolution	16-bit, including sign
PDO LSB	610.37 nA

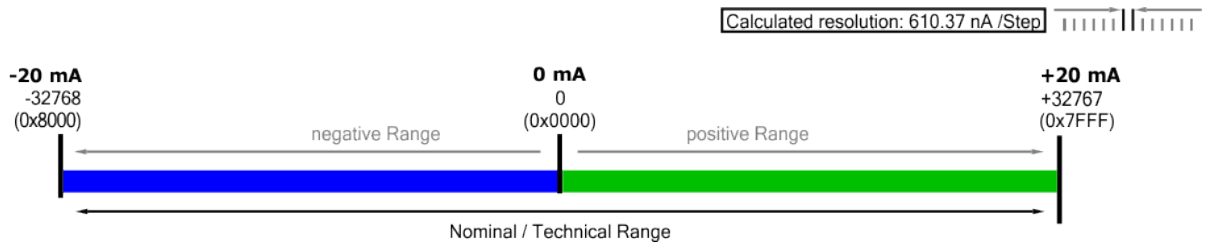

3.2.5.5 Output signal range 0 ... 20 mA

Technical data	Output signal range 0...20 mA
Full scale value of the signal range	20 mA
PDO resolution	16-bit, including sign
PDO LSB	610.37 nA

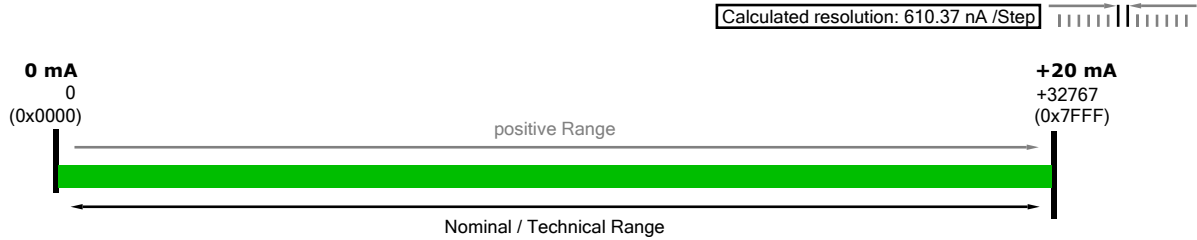

3.2.5.6 Output signal range 4 ... 20 mA

Technical data	Output signal range 4...20 mA
Full scale value of the signal range	20 mA
PDO resolution	16-bit, including sign
PDO LSB	488.30 nA

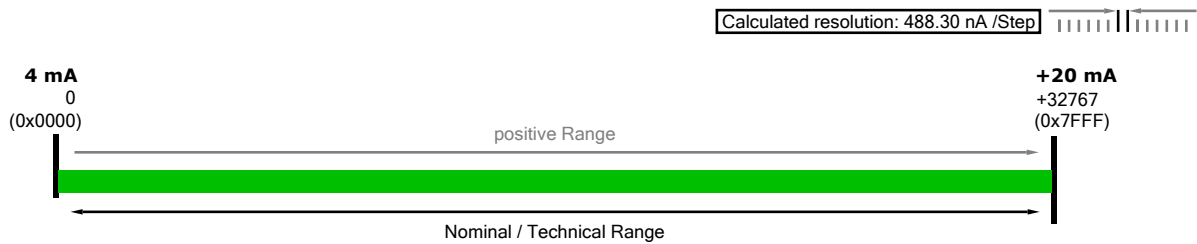

3.3 Scope of supply

Make sure that the following components are included in the scope of delivery:

- 1x EPP43x4-1002 EtherCAT P Box
- 2x protective cap for EtherCAT P socket, M8, red (pre-assembled)
- 10x labels, blank (1 strip of 10)

● Pre-assembled protective caps do not ensure IP67 protection

i Protective caps are pre-assembled at the factory to protect connectors during transport. They may not be tight enough to ensure IP67 protection.





Ensure that the protective caps are correctly seated to ensure IP67 protection.

3.4 Process image

In the following sections, the letter *n* serves as a placeholder for the channel number.

Screenshots showing process data objects of channel 1 are used as examples for both channels. The process data objects of channel 1 and channel 2 have the same content structure.

DI Inputs

- ▲  DIInputs
 -  Input 1
 -  Input 2
 -  TxPDO State
 -  TxPDO Toggle

➤  Input 1
Digital input, channel 1











➤  Input 2
Digital input, channel 2

➤  TxPDO State
If this bit is TRUE:

- The digital inputs could not be read correctly due to an error.
- The current values of the variables "Input 1" and "Input 2" are invalid.

➤  TxPDO Toggle
This bit is inverted each time an input data update occurs.

AI Standard Channel *n*



- ▲  AI Standard Channel 1
 - ▲  Status
 -  Underrange
 -  Overrange
 -  Limit 1
 -  Limit 2
 -  Error
 -  TxPDO State
 -  TxPDO Toggle
 -  Value

➤  State

- "Underrange"
The current measured value is smaller than the smallest value of the nominal measuring range. See [Measuring range monitoring \[► 44\]](#).
- "Overrange"
The current measured value is greater than the full scale value. See [Measuring range monitoring \[► 44\]](#).
- "Limit 1"
Status bit of the [Limit value monitoring \[► 48\]](#)
- "Limit 2"
Status bit of the [Limit value monitoring \[► 48\]](#)
- "Error"
Status bit of [Measuring range monitoring \[► 44\]](#).
This bit is coupled with the [LED "R/E" \[► 36\]](#): if the bit is TRUE, the LED lights up red.
- "TxPDO State"
If this bit is TRUE:
 - The measured value could not be read correctly due to an error.
 - The current value of the variable "Value" is invalid.
- "TxPDO Toggle"
This bit is inverted each time the measured value is updated.

➤  Value
The current measured value. Data type: INT



AO Standard Channel *n*

- ▲  AO Standard Channel 1
 -  Analog output

 Analog output
Analog output. Data type: INT



AO Inputs Channel *n*

EPP4304-1002:

- ▲  AO Inputs Channel 1
 -  Load Impedance too Low
 -  Error

This process data object is disabled in the factory settings. Activation and evaluation are described in the chapter [Diagnosis \[► 54\]](#).

EPP4314-1002:

- ▲  AO Inputs Channel 1
 -  Load Impedance too High
 -  Error

4 Mounting and connections

4.1 Mounting

4.1.1 Dimensions

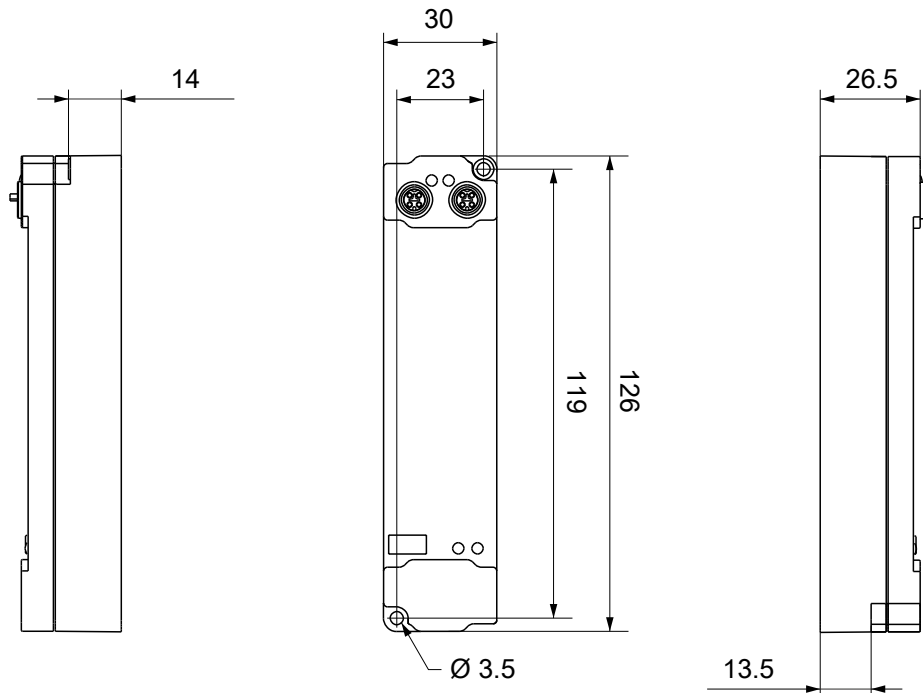

All dimensions are given in millimeters.
The drawing is not true to scale.

Housing features

Housing material	PA6 (polyamide)
Sealing compound	polyurethane
Mounting	two mounting holes $\text{Ø } 3.5$ mm for M3
Metal parts	brass, nickel-plated
Contacts	CuZn, gold-plated
Installation position	variable
Protection class	IP65, IP66, IP67 (conforms to EN 60529) when screwed together
Dimensions (H x W x D)	approx. 126 x 30 x 26.5 mm (without connectors)

4.1.2 Fixing

NOTICE

Dirt during assembly

Dirty connectors can lead to malfunctions. Protection class IP67 can only be guaranteed if all cables and connectors are connected.

- Protect the plug connectors against dirt during the assembly.

Mount the module with two M3 screws on the mounting holes in the corners of the module. The mounting holes have no thread.

4.1.3 Functional earth (FE)

The upper mounting holes also serves as a connection for functional earth (FE).

Make sure that the box is grounded to low impedance via the functional earth (FE) connection. You can achieve this, for example, by mounting the box on a grounded machine bed.



Fig. 1: Connection for functional earth (FE)

4.2 Connections

4.2.1 Connector overview

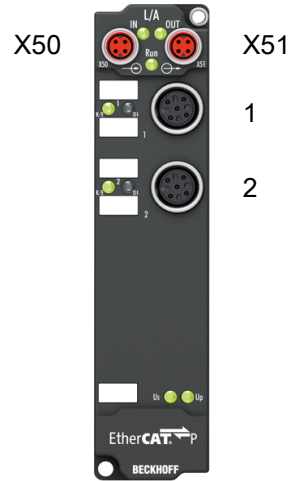

Name	Function	Connector type	Tightening torque
1	Signal inputs and outputs, channel 1 [► 33]	M12 socket	0.6 Nm ¹⁾
2	Signal inputs and outputs, channel 2 [► 33]	M12 socket	0.6 Nm ¹⁾
X50	EtherCAT P input [► 29]	M8 socket, p-coded	0.4 Nm ¹⁾
X51	EtherCAT P downstream connection [► 29]	M8 socket, p-coded	0.4 Nm ¹⁾

¹⁾ Mount plugs on these connectors using a torque wrench, e.g. ZB8801 from Beckhoff.

Protective caps

- Seal unused connectors with protective caps.
- Ensure the correct seating of pre-assembled protective caps.
Protective caps are pre-assembled at the factory to protect connectors during transport. They may not be tight enough to ensure IP67 protection.

4.2.2 EtherCAT P

⚠ WARNING

Power supply from SELV/PELV power supply unit!

SELV/PELV circuits (Safety Extra Low Voltage, Protective Extra Low Voltage) according to IEC 61010-2-201 must be used to supply the EtherCAT P Power Sourcing Device (PSD).

Notes:

- SELV/PELV circuits may give rise to further requirements from standards such as IEC 60204-1 et al, for example with regard to cable spacing and insulation.
- A SELV (Safety Extra Low Voltage) supply provides safe electrical isolation and limitation of the voltage without a connection to the protective conductor, a PELV (Protective Extra Low Voltage) supply also requires a safe connection to the protective conductor.

⚠ CAUTION

Observe the UL requirements

- When operating under UL conditions, observe the warnings in the chapter [UL Requirements](#) [▶ 37].

EtherCAT P transmits two supply voltages:

- **Control voltage U_s**
The following sub-functions are supplied from the control voltage U_s :
 - the fieldbus
 - the processor logic
 - typically the inputs and the sensors if the EtherCAT P Box has inputs.
- **Peripheral voltage U_p**
The digital outputs are typically supplied from the peripheral voltage U_p for EtherCAT P Box modules with digital outputs. U_p can be supplied separately. If U_p is switched off, the fieldbus function, the function of the inputs and the supply of the sensors are maintained.

The exact assignment of U_s and U_p can be found in the pin assignment of the I/O connections.

Redirection of the supply voltages

The supply voltages are passed on internally from the "IN" connection to the "OUT" connection. Hence, the supply voltages U_s and U_p can be passed from one EtherCAT P Box to the next EtherCAT P Box in a simple manner.

NOTICE

Note the maximum current.

Ensure that the maximum permitted current of 3 A for the M8 connectors is not exceeded when redirecting EtherCAT P.

4.2.2.1 Connectors

NOTICE

Risk of damage to the device!

Bring the EtherCAT/EtherCAT P system into a safe, powered down state before starting installation, disassembly or wiring of the modules!

Two M8 sockets at the upper end of the modules are provided for supply and downstream connection of EtherCAT P:

- IN: left M8 socket for EtherCAT P supply
- OUT: right M8 socket for downstream connection of EtherCAT P

The metal threads of the M8 EtherCAT P sockets are internally linked to the FE connection via high impedance RC combination. See chapter [Functional earth \(FE\)](#) [▶ 27].



Fig. 2: Connectors for EtherCAT P

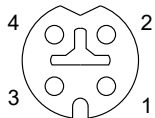

Fig. 3: M8 socket, p-coded

Contact	Signal	Voltage	Core color ¹⁾
1	Tx +	GND _S	yellow
2	Rx +	GND _P	white
3	Rx -	U _P : peripheral voltage, +24 V _{DC}	blue
4	Tx -	U _S : control voltage, +24 V _{DC}	orange
Housing	Shield	Shield	Shield

¹⁾ The core colors apply to EtherCAT P cables and ECP cables from Beckhoff.

4.2.2.2 Status LEDs

4.2.2.2.1 Supply voltages



EtherCAT P Box modules indicate the status of the supply voltages via two status LEDs. The status LEDs are labeled with the designations of the supply voltages: U_s and U_p.

LED	Display	Meaning
U _s (control voltage)	off	The supply voltage U _s is not available.
	green illuminated	The supply voltage U _s is available.
U _p (peripheral voltage)	off	The supply voltage U _p is not available.
	green illuminated	The supply voltage U _p is available.

4.2.2.2.2 EtherCAT



L/A (Link/Act)

A green LED labeled "L/A" or "Link/Act" is located next to each EtherCAT/EtherCAT P socket. The LED indicates the communication state of the respective socket:

LED	Meaning
off	no connection to the connected EtherCAT device
lit	LINK: connection to the connected EtherCAT device
flashes	ACT: communication with the connected EtherCAT device

Run

Each EtherCAT slave has a green LED labelled "Run". The LED signals the status of the slave in the EtherCAT network:

LED	Meaning
off	Slave is in "Init" state
flashes uniformly	Slave is in "Pre-Operational" state
flashes sporadically	Slave is in "Safe-Operational" state
lit	Slave is in "Operational" state

Description of the EtherCAT slave states

4.2.2.3 Conductor losses

Take into account the voltage drop on the supply line when planning a system. Avoid the voltage drop being so high that the supply voltage at the box lies below the minimum nominal voltage. Variations in the voltage of the power supply unit must also be taken into account.

i Planning tool for EtherCAT P

You can plan cable lengths, voltages and currents of your EtherCAT P system using TwinCAT 3. The requirement for this is TwinCAT 3 Build 4020 or higher.

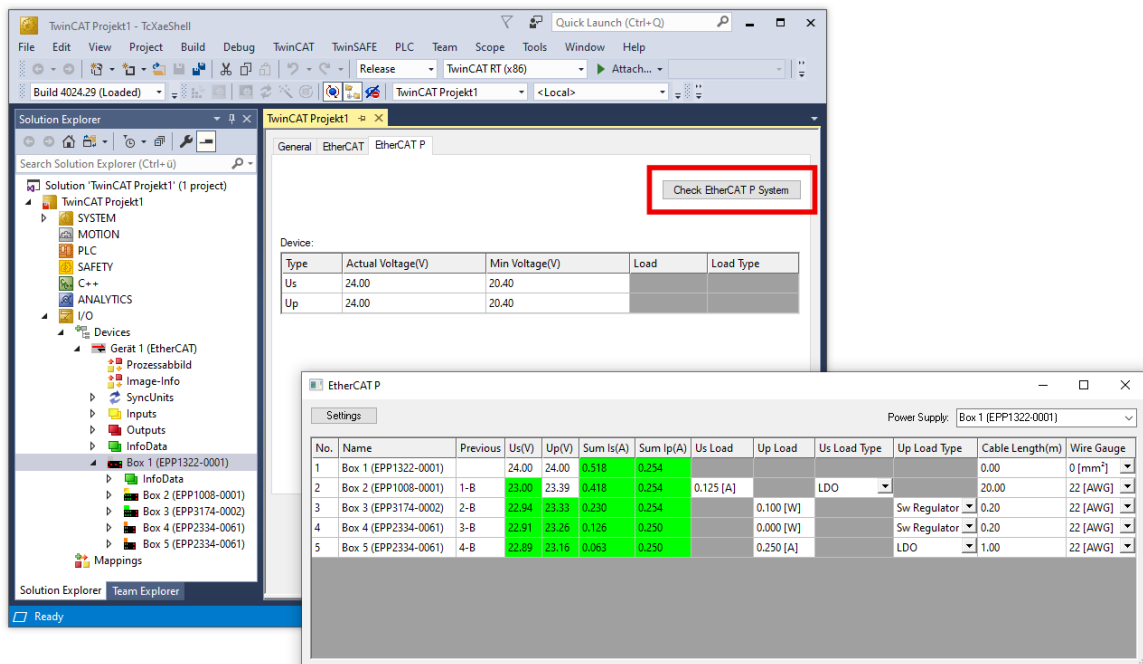

Further information can be found in the quick start guide [IO configuration in TwinCAT](#) in chapter "Configuration of EtherCAT P via TwinCAT".

Voltage drop on the supply line

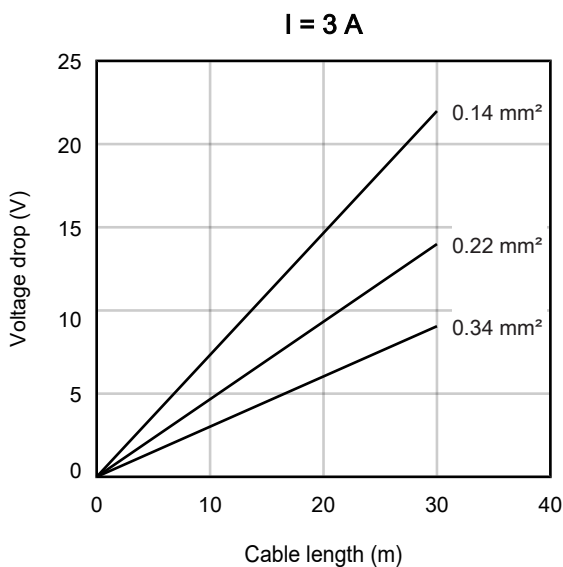

4.2.3 Signal inputs and outputs

NOTICE

Analog inputs and outputs must be parameterized before wiring

Defect possible due to incorrect measuring ranges and output signal ranges.

- Adjust the measuring ranges and output signal ranges before connecting sensors and actuators.

4.2.3.1 Connectors

i EMC shield clamp

Depending on the application it may be necessary to additionally attach the shield of the sensor cables at the signal inputs of the box with shield clamps ZB8513-0002.

See Chapter: "Accessories", section "Cables" [▶ 77].

M12 sockets

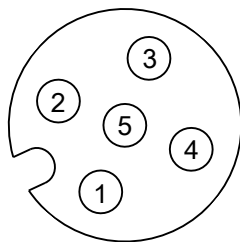

Pin	Wire color	Symbol	Description
1	brown	+24 V Up	Sensor supply voltage
2	white	Input +	Analog input
3	blue	GNDp	Ground
4	black	DI	Digital input
5	gray	Output +	Analog output

GND_p on pin 3 is the reference ground for all inputs and outputs.

4.2.3.2 Connection examples

4.2.3.2.1 Analog sensors

Two-wire connection

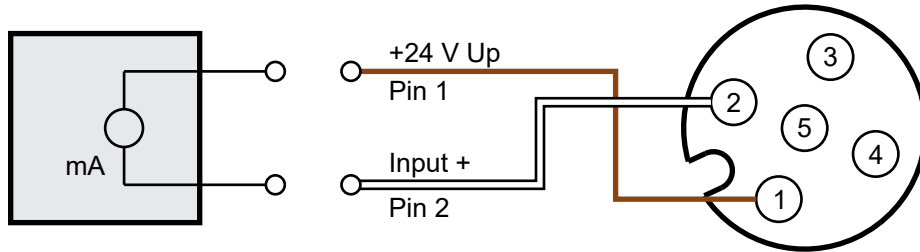

Three-wire connection

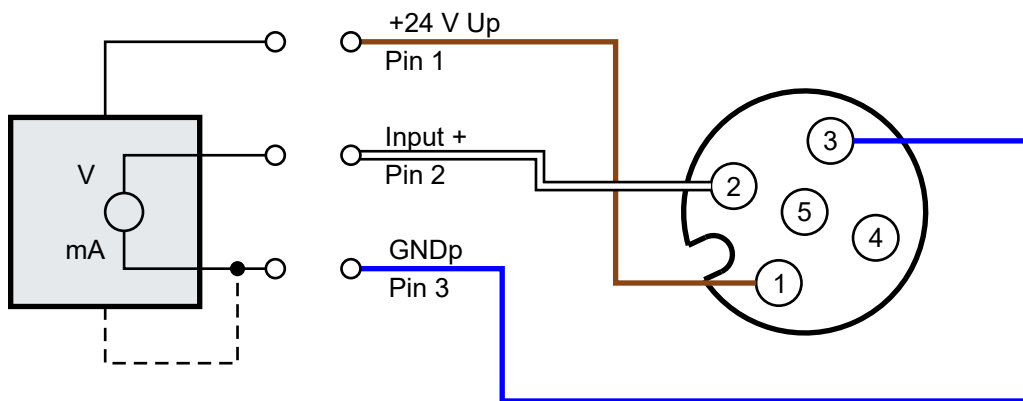

4.2.3.2.2 Analog actuators

Three-wire connection

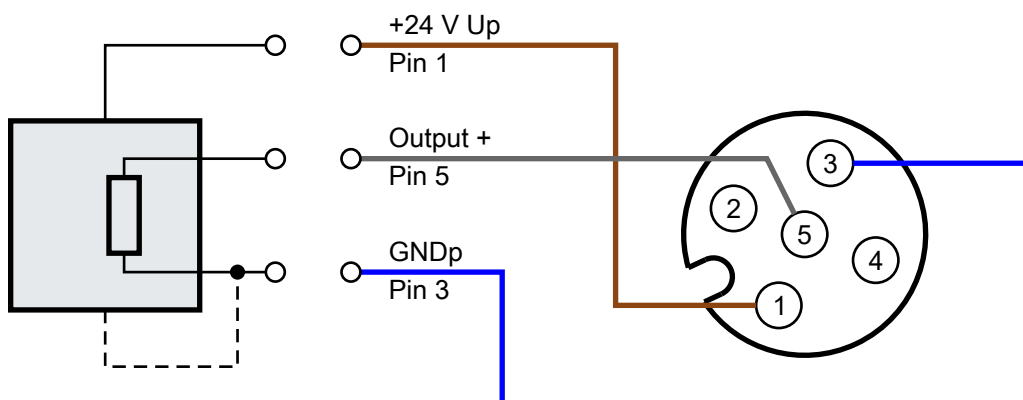

4.2.3.2.3 Digital sensors

Two-wire connection

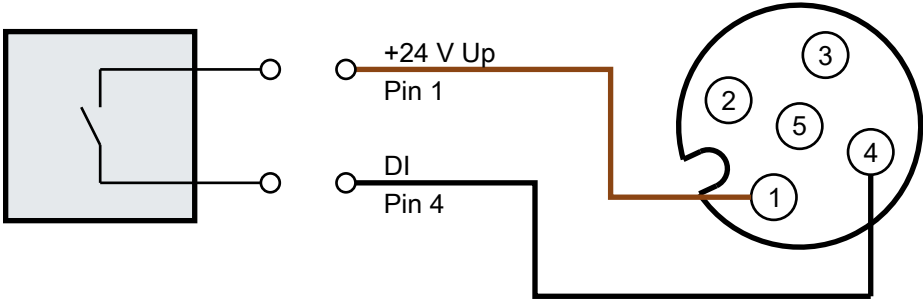

4.2.3.3 Status LEDs

Each connector has two status LEDs for signal inputs and outputs.



LED "R/E" (left)

The LED "R/E" signals the status of the analog input and analog output. In the event of an error, the LED lights up red.

Check the "Error" status bit of the corresponding input to determine whether the error occurred at the input or at the output.

LED "R/E"	Status bit "Error"	Meaning
off	x	The analog output is disabled. You can activate the analog output by not setting the output signal range [► 53] to "disabled".
green	x	The analog output is enabled.
red	1	The measured value of the analog input is outside of the error thresholds [► 45] .
red	0	EPP4304-1002: The analog output cannot maintain the voltage. EPP4314-1002: The analog output cannot drive the specified current. See chapter Diagnosis [► 54] .

x = no meaning

LED "DI" (right)

LED "DI" indicates the status of the digital input. It lights green when the digital input detects a high level.

4.3 UL Requirements

The installation of the EtherCAT Box Modules certified by UL has to meet the following requirements.

Supply voltage

⚠ CAUTION

CAUTION!

This UL requirements are valid for all supply voltages of all marked EtherCAT Box Modules!
For the compliance of the UL requirements the EtherCAT Box Modules should only be supplied

- by a 24 V_{DC} supply voltage, supplied by an isolating source and protected by means of a fuse (in accordance with UL248), rated maximum 4 Amp, or
- by a 24 V_{DC} power source, that has to satisfy *NEC class 2*.
A *NEC class 2* power supply shall not be connected in series or parallel with another (class 2) power source!

⚠ CAUTION

CAUTION!

To meet the UL requirements, the EtherCAT Box Modules must not be connected to unlimited power sources!

Networks

⚠ CAUTION

CAUTION!

To meet the UL requirements, EtherCAT Box Modules must not be connected to telecommunication networks!

Ambient temperature range

⚠ CAUTION

CAUTION!

To meet the UL requirements, EtherCAT Box Modules has to be operated only at an ambient temperature range of -25 °C to +55 °C!

Marking for UL

All EtherCAT Box Modules certified by UL (Underwriters Laboratories) are marked with the following label.



Fig. 4: UL label

4.4 Disposal



Products marked with a crossed-out wheeled bin shall not be discarded with the normal waste stream. The device is considered as waste electrical and electronic equipment. The national regulations for the disposal of waste electrical and electronic equipment must be observed.

5 Commissioning and configuration

5.1 Integrating into a TwinCAT project

The procedure for integration in a TwinCAT project is described in these [Quick start guide](#).

5.2 Analog inputs

5.2.1 Signal flow

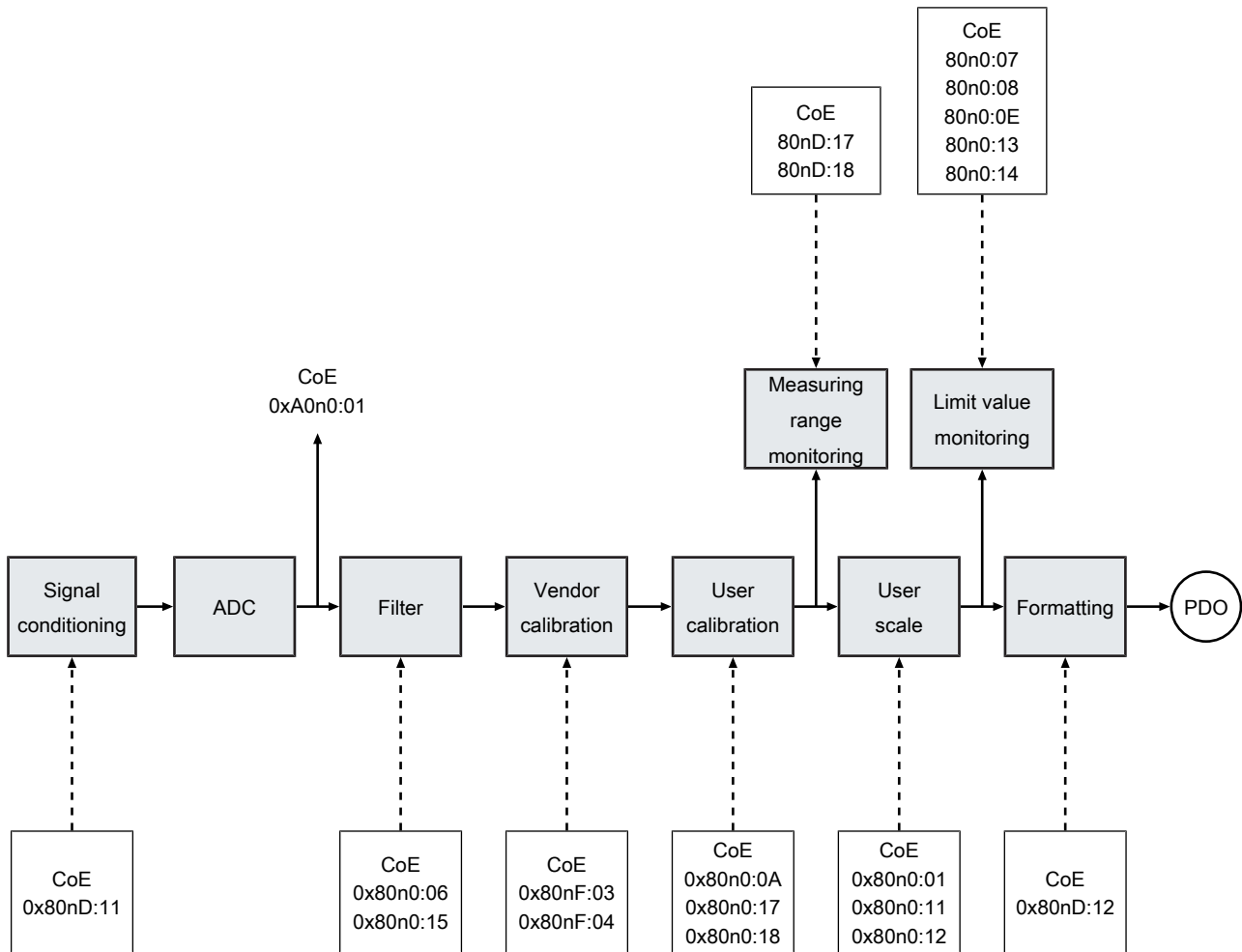

5.2.2 Measuring range

i Misinterpretation of the measured values possible

In the factory setting the "Extended Range" mode is enabled.

In "Extended Range" mode the measuring range is slightly larger than the nominal measuring range. The value 0x7FFF corresponds to approximately 107% of the full scale value.

- Take the increased measuring range into account when evaluating the measured values. See chapter [Measuring ranges](#) [▶ 14].

-or-

- Set the "Legacy Range" mode. See chapter: [Nominal and technical measuring range](#) [▶ 43]

The measuring range can be selected individually for each analog input.

Set the measuring range in the CoE parameters "Input Type":

Channel	"Input Type"
1	0x801D:11
2	0x802D:11

Possible values for EPP4304-1002

Value	Measuring range
2 _{dec} (factory setting)	U ±10V
14 _{dec}	U 0-10V

Possible values for EPP4314-1002

Value	Measuring range
16 _{dec}	I ±10 mA
17 _{dec} (factory setting)	I ±20 mA
18 _{dec}	I 0-20 mA
19 _{dec}	I 4-20 mA

The specifications for the individual measuring ranges can be found in the chapter [Analog inputs](#) [▶ 12].

Example

The screenshot shows a software interface with several tabs: General, EtherCAT, Process Data, Startup, CoE - Online, and Online. The 'Online' tab is active. At the top, there are buttons for 'Update List', 'Advanced...', and 'Add to Startup...'. Below these are checkboxes for 'Auto Update', 'Single Update', and 'Show Offline Data'. A text field for 'Module OD (AoE Port):' contains the value '0'. The main area is a table with columns: Index, Name, Flags, Value, and Unit. A red arrow points to the row with Index '801D:11' and Name 'Input Type'. A 'Set Value Dialog' window is open over the table, showing fields for Dec (17), Hex (0x0011), Enum (I ±20mA), Bool (I 0-20mA), Binary (11 00), and Bit Size (16 selected).

Index	Name	Flags	Value	Unit
7030:0	AO Outputs Ch.1	RO	> 1 <	
7040:0	AO Outputs Ch.2	RO	> 1 <	
8010:0	AI Settings Ch.1	RW	> 24 <	
801D:0	AI Advanced Settings Ch.1	RW	> 24 <	
801D:11	Input Type	RW	I ±20mA (17)	
801D:12	Scaler	RW	Extended Range (0)	
801D:17	Low Range Error	RW	-32768	
801D:18	High Range Error	RW	32767	
801F:0	AI Vendor data Ch.1	RW	> 4 <	
8020:0	AI Settings Ch.2	RW	> 24 <	
802D:0	AI Advanced Settings Ch.2	RW	> 24 <	
802F:0	AI Vendor data Ch.2	RW	> 4 <	
8030:0	AO Settings Ch.1	RW	> 22 <	
803D:0	AO Advanced Settings Ch.1	RW	> 17 <	
803F:0	AO Vendor data Ch.1	RW	> 10 <	
8040:0	AO Settings Ch.2	RW	> 22 <	
804D:0	AO Advanced Settings Ch.2	RW	> 17 <	
804F:0	AO Vendor data Ch.2	RW	> 10 <	
A010:0	AI Diag data Ch.1	RO	> 1 <	
A020:0	AI Diag data Ch.2	RO	> 1 <	
A030:0	AO Diag data Ch.1	RO	> 1 <	
A040:0	AO Diag data Ch.2	RO	> 1 <	
F000:0	Modular device profile	RO	> 2 <	
F008	Code word	RW	0x00000000 (0)	
F010:0	Module list	RO	> 7 <	
FB00:0	Command	RO	> 3 <	

Set Value Dialog

Dec: 17

Hex: 0x0011

Enum: I ±20mA
 I ±10mA
 I ±20mA
 I 0-20mA
 I 4-20mA

Bool: 0-20mA 4-20mA

Binary: 11 00

Bit Size: 1 8 16 32 64 ?

5.2.2.1 Nominal and technical measuring range

The technical measuring range is approx. 7 ... 8 % larger than the nominal measuring range. See chapter [Measuring ranges](#) [► 14].

You can choose whether the technical measuring range or the nominal measuring range is displayed. Irrespective of that, the specified measuring error is guaranteed only for measured values within the nominal measuring range.

Select the measuring range to be displayed in the CoE parameters "Scaler":

Channel	"Scaler"
1	0x801D:12
2	0x802D:12

Possible values

Value	Enum	Description
0 (factory setting)	„Extended Range“	Measuring range = technical measuring range
3	„Legacy Range“	Measuring range = nominal measuring range

Example

The screenshot shows the Beckhoff CoE Online configuration tool. The 'CoE - Online' tab is active, and the 'Online Data' section is expanded. A red arrow points to the parameter 801D:12, 'Scaler', which has a value of 'Extended Range (0)'. A 'Set Value Dialog' window is open over the parameter, showing the 'Enum' dropdown menu with 'Extended Range' selected. Other options in the dropdown include 'Legacy Range'. The dialog also shows 'Dec: 0', 'Hex: 0x0000', and 'Bit Size: 16'.

5.2.2.2 Measuring range monitoring: Status bits

NOTICE

Malfunction of the measuring range monitoring after incorrect user calibration

The measuring range monitoring is located after the [user calibration \[► 50\]](#) in the [signal flow \[► 40\]](#). Incorrect coefficients (offset, gain) in the user calibration can lead to the measuring range monitoring not functioning as expected.

Three Status bits signal whether the current measured value of an analog input lies outside of the measuring range. See Process data for the analog inputs.

Status bit "Overrange"

If the Status bit "Overrange" is set:

- The current measured value is larger than the full scale value of the measuring range.
- The measuring error specified in the technical data is not guaranteed for the current measured value.
- If "Legacy range" is set, the variable Value does currently not correspond to the measured value. The current measured value is larger than the largest displayable value in the "Legacy range".

Status bit "Underrange"

If the Status bit "Underrange" is set:

- The current measured value is smaller than the smallest value of the nominal measuring range.
- The measuring error specified in the technical data is not guaranteed for the current measured value.
- If "Legacy range" is set, the variable Value does currently not correspond to the measured value. The current measured value is smaller than the smallest displayable value in the "Legacy range".

Status bit "Error"

If the status bit "Error" is set:

- The current measured value is smaller than the lower [error threshold \[► 45\]](#) or larger than the upper [error threshold \[► 45\]](#).
- The LED "R/E" lights up red. It is linked to the status bit "Error".

5.2.2.2.1 Error thresholds

In the factory setting, the error thresholds lie at the smallest and largest displayable values of the technical measuring range ("Extended range").

The exceeding of the error thresholds is signaled for each channel in two ways:

- The status bit "Error" [▶ 24] is TRUE.
- The status LED "R/E" [▶ 36] lights up red.

The error thresholds can be set via CoE parameters.

Recommendation: adapt the error thresholds to the output signal range of the sensor.

Channel	Lower error threshold: "Low Range Error"	Upper error threshold: "High Range Error"
1	0x801D:17	0x801D:18
2	0x802D:17	0x802D:18

5.2.3 Filter

The measured value of each analog input can be filtered with a digital filter.

NOTICE

Measured value jumps when enabling or disabling filters

When filters are enabled or disabled, short-term measured value jumps can occur in the process data that do not correspond to the physical values.

i Filters influence the EtherCAT synchronization mode

If one or more filters are activated, the device will automatically run in "Free Run" synchronization mode.

All filters are disabled in the factory setting.

You can enable the filter for each input individually by setting the corresponding CoE parameter "Enable filter" to TRUE:

Channel	"Enable filter"
1	0x8010:06
2	0x8020:06

Example

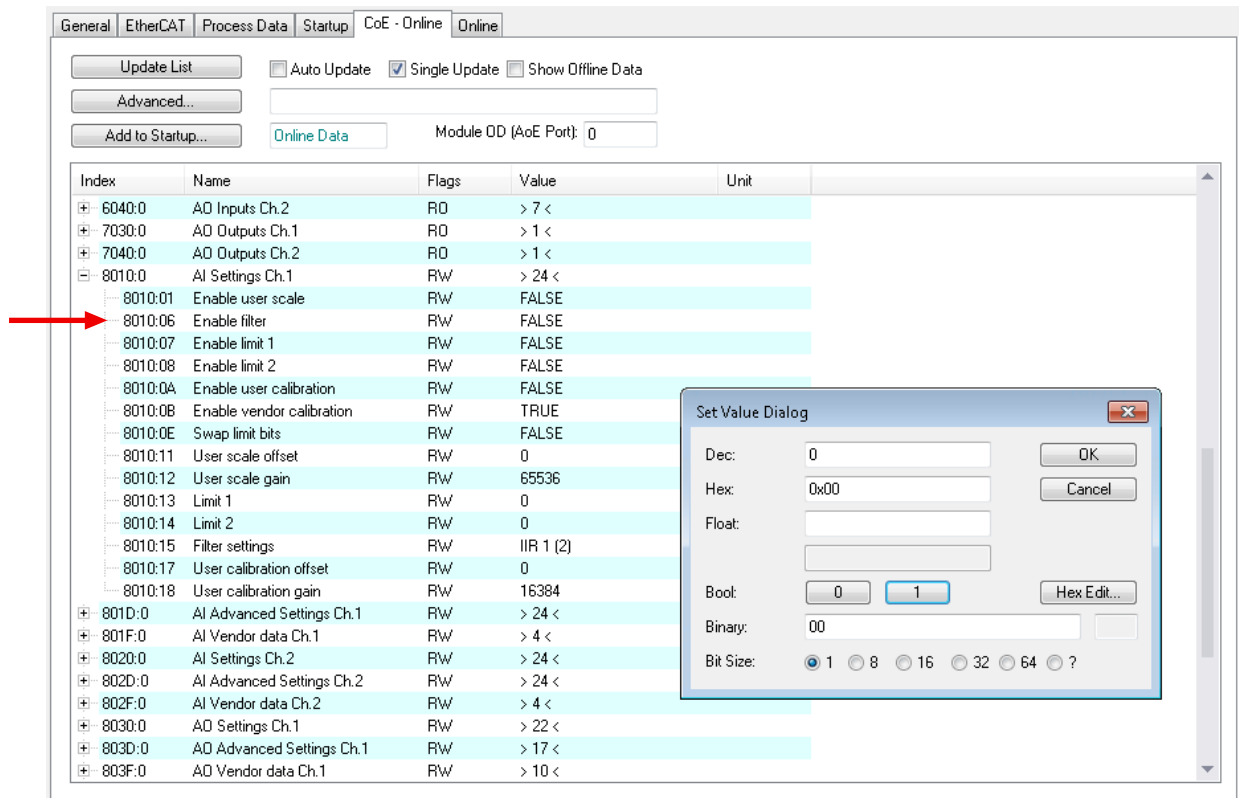

Select filter type

The factory setting of the filter type is "IIR 1".

You can select the filter type for each input individually in the CoE parameters "Filter Settings":

Channel	"Filter Settings"
1	0x8010:15
2	0x8020:15

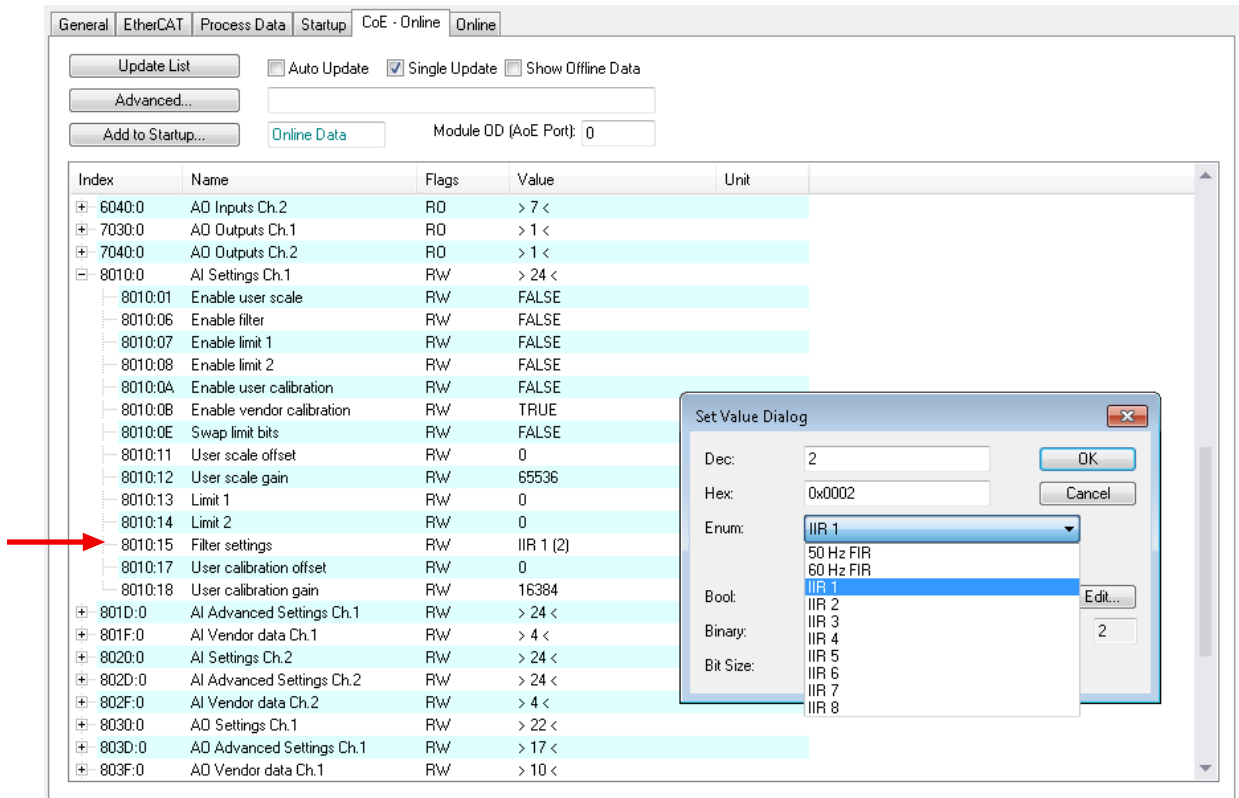

There is a choice of two filter types. Use the following description to select a suitable filter type for your application.

FIR filter

The filter works as a notch filter and determines the conversion time of the module. The higher the filter frequency, the faster the conversion time. A 50 Hz and a 60 Hz filter are available.

Notch filter means that the filter has zeros (notches) in the frequency response at the filter frequency and multiples thereof, i.e. it attenuates the amplitude at these frequencies.

The FIR filter operates as a non-recursive filter.

IIR filter

The filter with IIR characteristics is a discrete time, linear, time invariant filter that can be set to eight levels (level 1 = weak recursive filter, up to level 8 = strong recursive filter)

The IIR can be understood to be a moving average value calculation after a low-pass filter.

5.2.4 Limit value monitoring

You can define two limit values for each analog input:

- Limit 1
- Limit 2

For each limit value there is a variable of the same name in the process data. See chapter [Process image](#) [► 24]. The variable shows whether the current measured value lies above or below the limit value.

Defining a limit value

Enter your limits in the corresponding CoE parameter "Limit 1" and "Limit 2".

The permissible value range is -32768 to +32767 (0x8000 ... 0x7FFF).

Channel	"Limit 1"	"Limit 2"
1	0x8010:13	0x8010:14
2	0x8020:13	0x8020:14

Activating the limit value monitoring

In the factory setting, the limit value monitoring is disabled.

You can enable limit monitoring for each input individually by setting the corresponding CoE parameter "Enable Limit 1/2" to TRUE:

Channel	"Enable limit 1"	"Enable limit 2"
1	0x8010:07	0x8010:08
2	0x8020:07	0x8020:08

Evaluation

Evaluate the variables "Limit 1" and "Limit 2" in the process data in accordance with the following table:

Value	Meaning	
	For "Swap limit bits" ¹⁾ = FALSE	For "Swap limit bits" ¹⁾ = TRUE
0	Monitoring is not activated for this limit value.	
1	The measured value is smaller than the limit value.	The measured value is greater than the limit value.
2	The measured value is greater than the limit value.	The measured value is smaller than the limit value.
3	The measured value is exactly the same size as the limit value.	

¹⁾ "Swap limit bits" is a CoE parameter. "Swap limit bits" is FALSE in the factory setting.

Channel	"Swap limit bits"
1	0x8010:0E
2	0x8020:0E

5.2.5 Calibration and scaling

5.2.5.1 Vendor calibration

Each analog input is calibrated in the factory. The results of the calibration are the coefficients of a correction function. The correction function is:

$$Y_v = G_v * (X_v - O_v)$$

Y_v : Measured value after the vendor calibration

X_v : Measured value before the vendor calibration

G_v : Gain of the vendor calibration

O_v : Offset of the vendor calibration

The coefficients G_v and O_v cannot be changed by the user. If you wish to carry out a calibration yourself, use the user calibration.

You will find the coefficients for the different measuring ranges in the following CoE objects:

Channel	CoE object (read only)	
1	801F _{hex}	AI Vendor data Ch.1
2	802F _{hex}	AI Vendor data Ch.2

Disabling the vendor calibration

NOTICE

Measuring error with disabled vendor calibration

The measuring error specified in the technical data is no longer guaranteed if you disable the vendor calibration.

If you use the user calibration, it may be a good idea to disable the vendor calibration.

Set the CoE parameter "Enable vendor calibration" to FALSE to disable the vendor calibration for the respective input.

Channel	"Enable vendor calibration"
1	0x8010:0B
2	0x8020:0B

5.2.5.2 User calibration

NOTICE

The user calibration affects the measuring range monitoring.

Incorrect calibration coefficients can lead to the Status bits and Status LEDs no longer behaving as expected; see Measuring range monitoring.

The intended purpose of the user calibration is to calibrate the device, for example, in a smaller measuring range than that calibrated by the vendor. As a result, a higher accuracy can be achieved in the smaller measuring range.

The correction function has the same form as the correction function of the vendor calibration:

$$Y_U = G_U * (X_U - O_U)$$

Y_U : Measured value after the user calibration

X_U : Measured value before the user calibration

G_U : Gain

O_U : Offset

Enabling the user calibration

The user calibration is disabled in the factory setting. It can be enabled individually for each input. To do this, set the corresponding CoE parameter "Enable user calibration" to TRUE:

Channel	Index of "Enable user calibration"
1	0x8010:0A
2	0x8020:0A

Setting the calibration coefficients

Set the calibration coefficients via the CoE parameters "User calibration offset" and "User calibration gain":

Channel	"User calibration offset"	"User calibration gain"
1	0x8010:17	0x8010:18
2	0x8020:17	0x8020:18

5.2.5.3 User scaling

The transfer function of the user scaling for the analog inputs is as follows:

$$Y_S = G_S * (X_S - O_S)$$

Y_S : Measured value after the user scaling

X_S : Measured value before the user scaling

G_S : Gain

O_S : Offset

Enabling user scaling

The user scaling is disabled in the factory. It can be enabled individually for each channel. To do this, set the corresponding CoE parameter "Enable user scale" to TRUE:

Channel	"Enable user scale"
1	0x8010:01
2	0x8020:01

Setting the scaling coefficients

Set the scaling coefficients via the CoE parameters "User scale offset" and "User scale gain":

Channel	"User scale offset"	"User scale gain"
1	0x8010:11	0x8010:12
2	0x8020:11	0x8020:12

5.3 Analog outputs

5.3.1 Signal flow

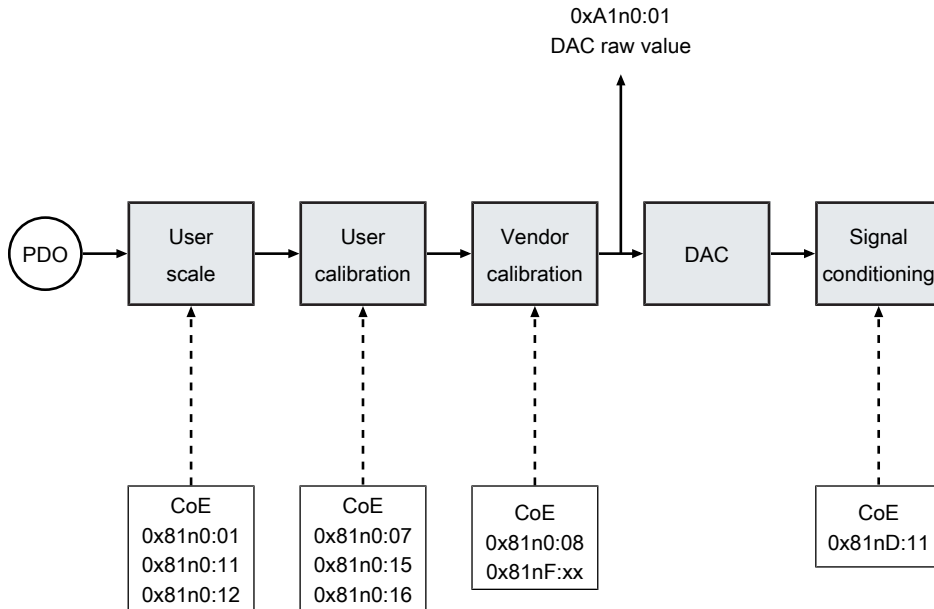

5.3.2 Output signal range

The output signal range can be selected individually for each analog output.

Set the output signal ranges in the CoE parameters "Input Type":

Channel	"Output Type"
1	0x803D:11
2	0x804D:11

Possible values for EPP4304-1002

Value	Output signal range
2 _{dec} (factory setting)	U ±10V
14 _{dec}	U 0-10V
65535 _{dec}	Disabled

Possible values for EPP4314-1002

Value	Output signal range
16 _{dec}	I ±10 mA
17 _{dec} (factory setting)	I ±20 mA
18 _{dec}	I 0-20 mA
19 _{dec}	I 4-20 mA
65535 _{dec}	Disabled

Example

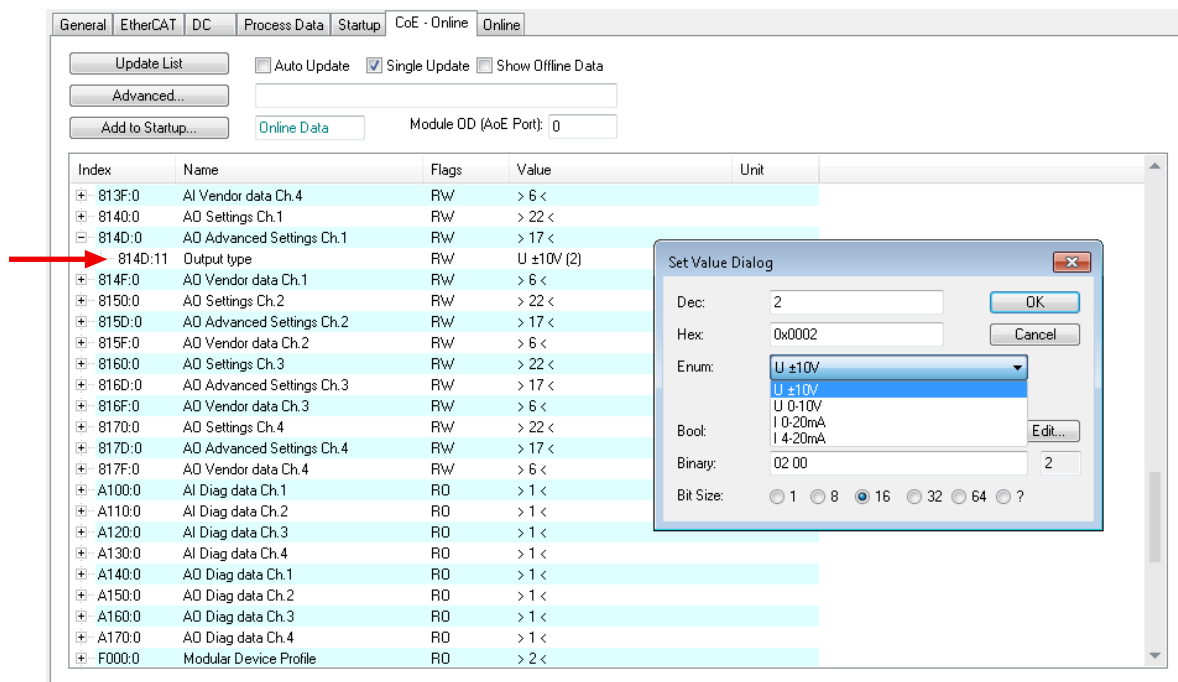

5.3.3 Diagnosis

The process data objects "AO Inputs Channel 1" and "AO Inputs Channel 2" contain variables for the diagnosis of the analog outputs.

These process data objects are disabled in the factory settings.

Enable

You can enable the process data objects as follows:

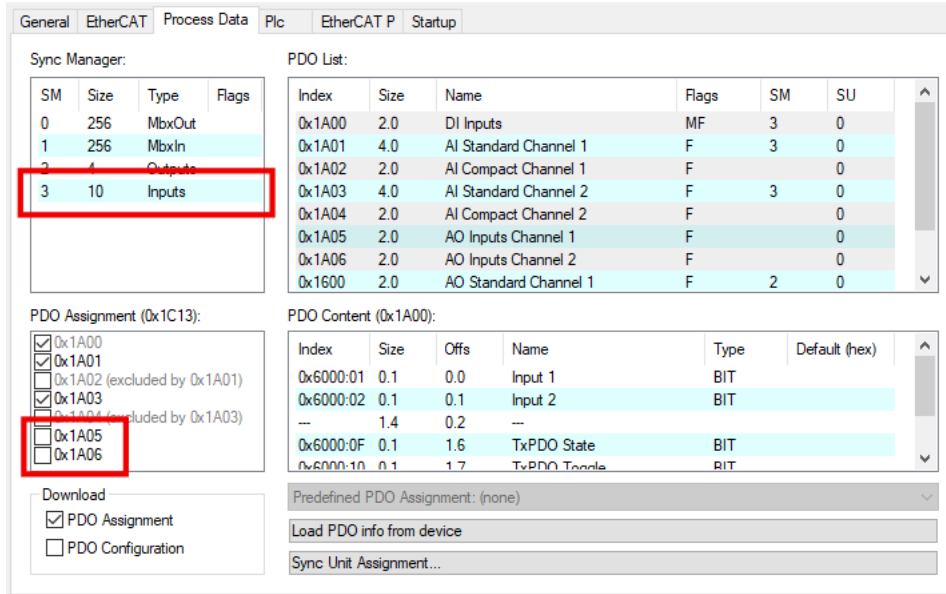

1. Open the "Process Data" tab.
2. In the field "Sync Manager" select "Inputs".
3. In the field "PDO Assignment (0x1C13)" activate the checkboxes "0x1A05" and/or "0x1A06".

Index	Process data object
0x1A05	AO Inputs Channel 1
0x1A06	AO Inputs Channel 2

Evaluation

The process data objects "AO Inputs Channel 1" and "AO Inputs Channel 2" each contain two status bits:

- "Load Impedance too Low" (EPP4304-1002)
"Load Impedance too High" (EPP4314-1002)
- "Error"

"Error" always has the same value as "Load Impedance too Low/High". The following table shows the meaning of the values of the status bits.

Value	Meaning	
	EPP4304-1002	EPP4314-1002
0	Normal operation	Normal operation
1	The analog output cannot drive the specified current. Possible causes: <ul style="list-style-type: none"> • Wire break. • The load is too high. Permissible load: see Technical data of the analog outputs [▶ 13]. 	The analog output cannot maintain the voltage. Possible causes: <ul style="list-style-type: none"> • The load resistor is too small. See Technical data of the analog outputs [▶ 13]

5.3.4 Behavior in case of a communication interruption: Watchdog

If the communication between the PLC and the analog outputs is interrupted, the analog outputs no longer receive any preset values. Watchdogs monitor the communication and can take over control of the analog outputs if the communication is interrupted.

There are two Watchdogs:

- The "SM Watchdog" monitors the EtherCAT communication.
- The "PDI Watchdog" monitors the communication inside the module.

Both Watchdogs are disabled in the factory setting.

5.3.4.1 Enabling Watchdog

⚠ CAUTION

Actuators may start to move unexpectedly if a Watchdog is active
Injuries are possible.

1. Select the "EtherCAT" tab.
2. Click the "Advanced Settings" button.
3. Click the menu item "Behaviour"
4. Check the checkbox next to "Set PDI Watchdog" and/or "Set SM Watchdog".

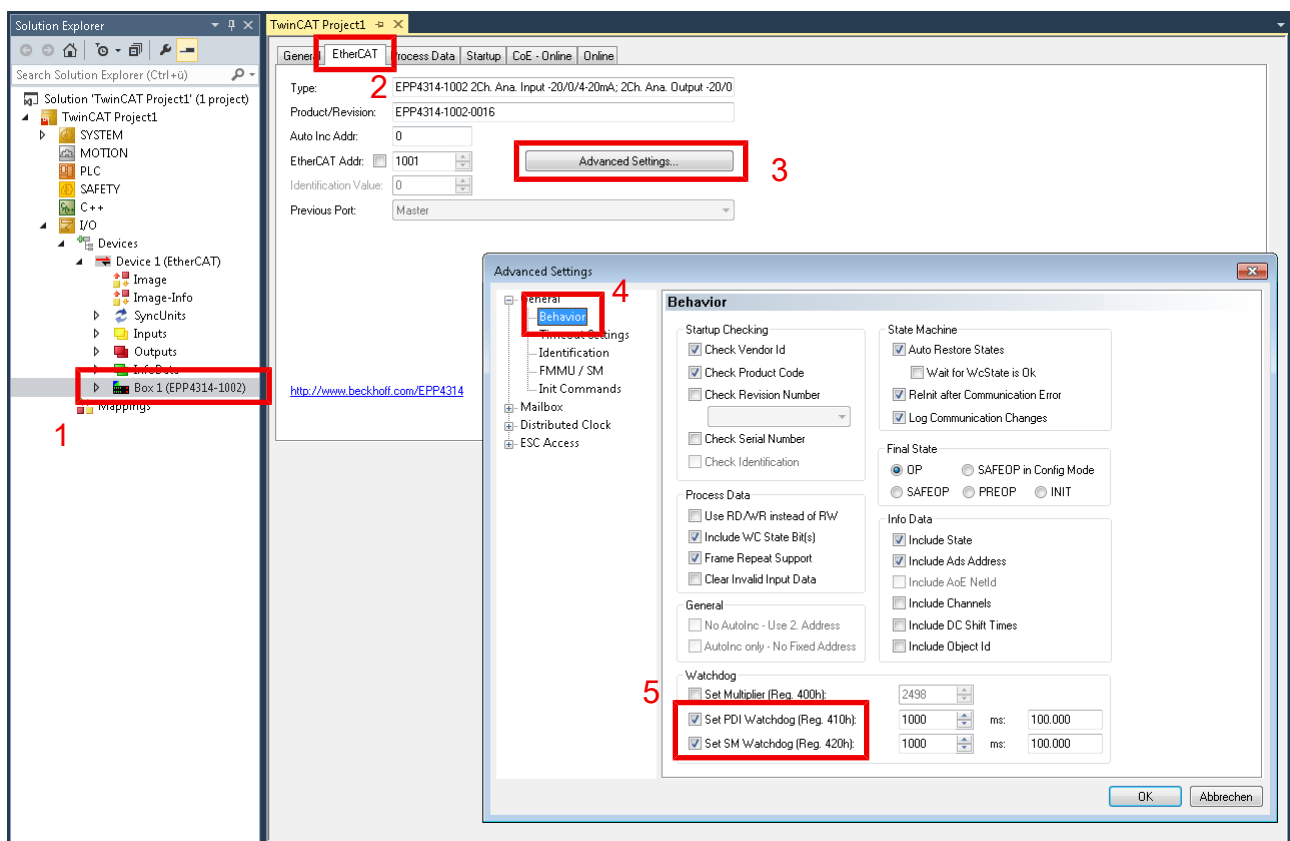

5.3.4.2 Setting the reaction time

The reaction time is the time between detecting a communication interruption and the reaction of the watchdog: If a watchdog detects a communication interruption, it waits for the reaction time to elapse before taking control of the analog outputs.

You can set the reaction time individually for each watchdog.

Select reaction times that are long enough to prevent the watchdogs from reacting even to very short, temporary communication interruptions.

The reaction times are calculated with this equation:

$$t_r = m_w \times \frac{(m_b + 2)}{25 \text{ MHz}}$$

t_r : Reaction time of a watchdog

m_w : Watchdog multiplier

m_b : Base multiplier (factory setting: 2498_{dec})

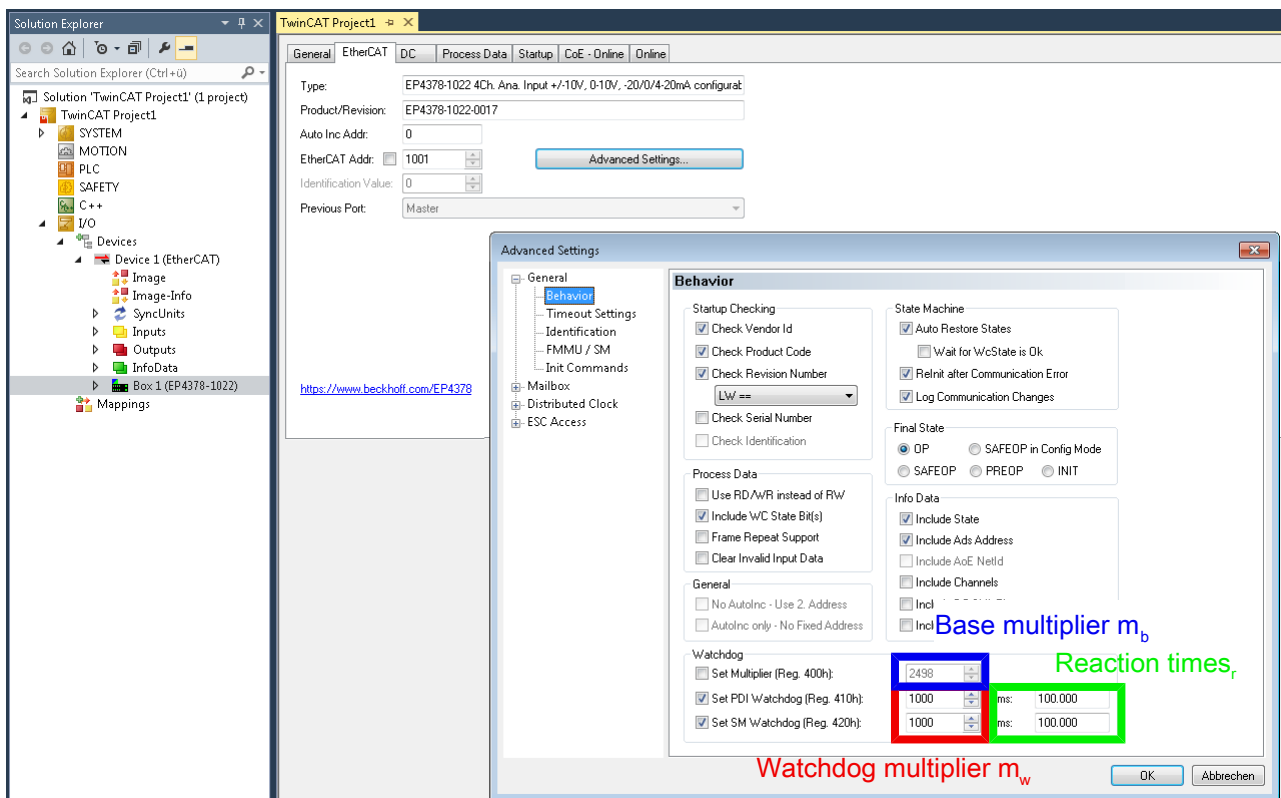

5.3.4.3 Setting the behavior

You can set the behavior of each analog output in case of a communication interruption in the CoE parameters "Watchdog":

Channel	"Watchdog"
1	0x8030:05
2	0x8040:05

Possible values

Value	Enum	Description
0 (factory setting)	"Default watchdog value"	If the reaction time has elapsed, the watchdog immediately sets the output to the default value (see below).
1	"Watchdog ramp"	Linear ramp to the default value (see below).
2	"Last output value"	Freezing the value: The output outputs the last value that was received by the controller before the communication was interrupted.

Setting the default value

You can define the default value in the CoE parameters "Default output":

Channel	"Default output"
1	8030:13
2	8040:13

Ramp

You can define the time to reach the default value when the watchdog behavior is set to the value 1 "Watchdog ramp".

$$t = \frac{|n_{current} - n_{default}|}{v_{ramp}}$$

t: time in ms until the default value is reached.

$n_{current}$: the last output value that was received by the controller before the communication interruption.

$n_{default}$: default value (CoE parameter 80n00:13).

v_{ramp} : ramp velocity in digits/ms (CoE parameter 80n00:14).

5.3.5 Calibration and scaling

5.3.5.1 Vendor calibration

Each analog output is calibrated in the factory. The results of the calibration are the coefficients of a correction function. The correction function is:

$$Y_v = G_v * X_v + O_v$$

Y_v : Output value after vendor calibration

X_v : Output value before vendor calibration

G_v : Gain of the vendor calibration

O_v : Offset of the vendor calibration

The coefficients G_v and O_v cannot be changed by the user. If you wish to carry out a calibration yourself, use the user calibration.

You will find the coefficients for the different output signal ranges in the following CoE objects:

Channel	CoE object (read only)	
1	803F _{hex}	AO Vendor data Ch.1
2	804F _{hex}	AO Vendor data Ch.2

Disabling the vendor calibration

NOTICE

Output error with disabled vendor calibration

The output error specified in the technical data is no longer guaranteed if you disable the vendor calibration.

If you use the user calibration, it may be a good idea to disable the vendor calibration.

Set the CoE parameter "Enable vendor calibration" to FALSE to disable the vendor calibration for the respective output.

Channel	"Enable vendor calibration"
1	0x8030:08
2	0x8040:08

5.3.5.2 User calibration

The intended purpose of the user calibration is to calibrate the device, for example, in a smaller output signal range than that calibrated by the vendor. As a result, a higher accuracy can be attained for the smaller output signal range.

The correction function has the same form as the correction function of the vendor calibration:

$$Y_U = G_U * X_U + O_U$$

Y_U : Output value after user calibration

X_U : Output value before user calibration

G_U : Gain

O_U : Offset

Enabling the user calibration

The user calibration is disabled in the factory. It can be enabled individually for each output. To do this, set the corresponding CoE parameter "Enable user calibration" to TRUE:

Connection	"Enable user calibration"
1	0x8030:07
2	0x8040:07

Setting the calibration coefficients

Set the calibration coefficients via the CoE parameters "User calibration offset" and "User calibration gain":

Connection	"User calibration offset"	"User calibration gain"
1	0x8030:15	0x8030:16
2	0x8040:15	0x8040:16

5.3.5.3 User scaling

The transfer function of the user scaling for the analog outputs is as follows:

$$Y_S = G_S * X_S + O_S$$

Y_S : Output value after the user scaling

X_S : Output value before the user scaling

G_S : Gain

O_S : Offset

Enabling user scaling

The user scaling is disabled in the factory. It can be enabled individually for each channel. To do this, set the corresponding CoE parameter "Enable user scale" to TRUE:

Channel	"Enable user scale"
1	8030:01
2	8040:01

Setting the scaling coefficients

Set the scaling coefficients via the CoE parameters "User scale offset" and "User scale gain":

Channel	"User scale offset"	"User scale gain"
1	0x8030:11	8030:12
2	0x8040:11	8040:12

5.4 Restore the delivery state

You can restore the delivery state of the backup objects as follows:

1. Ensure that TwinCAT is running in Config mode.
2. In CoE object 1011:0 "Restore default parameters" select parameter 1011:01 "Subindex 001".

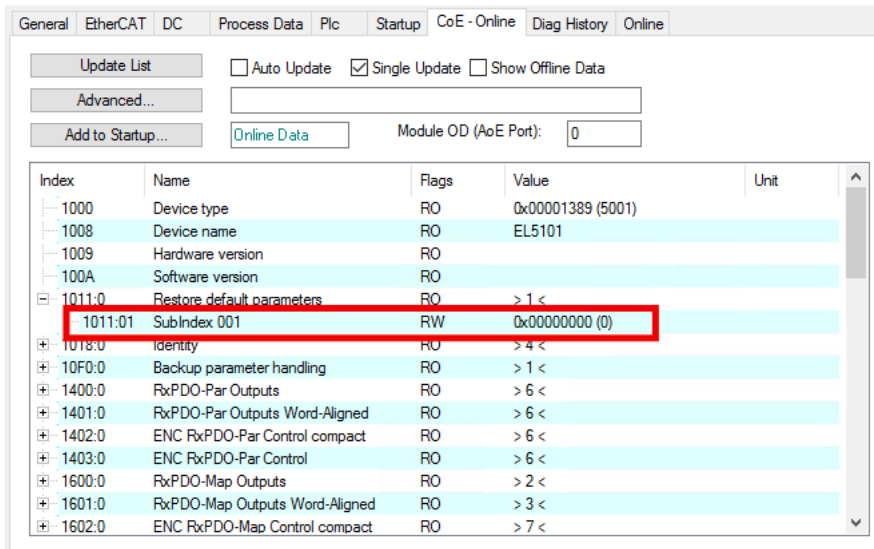

3. Double-click on "Subindex 001".
⇒ The "Set Value Dialog" dialog box opens.
4. Enter the value 1684107116 in the "Dec" field.
Alternatively: enter the value 0x64616F6C in the "Hex" field.

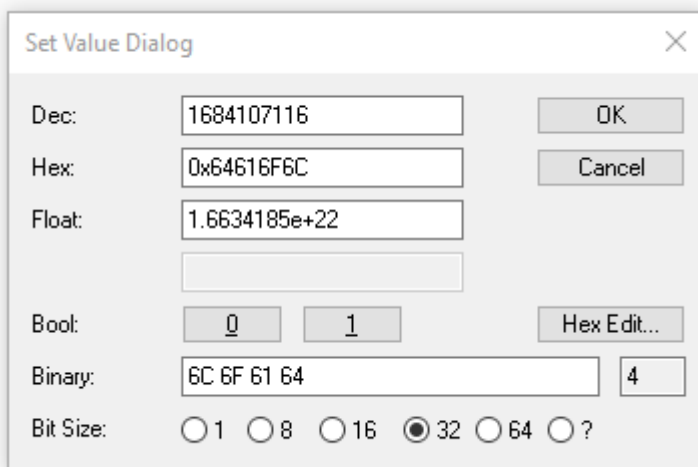

5. Confirm with "OK".
⇒ All backup objects are reset to the delivery state.

i Alternative restore value

With some older modules the backup objects can be changed with an alternative restore value:

Decimal value: 1819238756

Hexadecimal value: 0x6C6F6164

An incorrect entry for the restore value has no effect.

6 CoE parameters

6.1 Object directory

Index (hex)	Name
1000	Device type [▶ 66]
1008	Device name [▶ 66]
1009	Hardware version [▶ 66]
100A	Software version [▶ 66]
100B	Bootloader version [▶ 66]
1011	Restore default parameters [▶ 66]
1018	Identity [▶ 66]
10E2	Manufacturer-specific identification code [▶ 67]
10F0	Backup parameter handling [▶ 67]
1600	AO RxPDO-Map Standard Ch.1 [▶ 67]
1601	AO RxPDO-Map Standard Ch.2 [▶ 67]
1801	AI TxPDO-Par Standard Ch.1 [▶ 67]
1802	AI TxPDO-Par Compact Ch.1 [▶ 67]
1803	AI TxPDO-Par Standard Ch.2 [▶ 67]
1804	AI TxPDO-Par Compact Ch.2 [▶ 67]
1A00	DI TxPDO-Map Inputs [▶ 68]
1A01	AI TxPDO-Map Standard Ch.1 [▶ 68]
1A02	AI TxPDO Map Compact Ch.1 [▶ 68]
1A03	AI TxPDO-Map Standard Ch.2 [▶ 68]
1A04	AI TxPDO Map Compact Ch.2 [▶ 69]
1A05	AO TxPDO Map Inputs Ch.1 [▶ 69]
1A06	AO TxPDO Map Inputs Ch.2 [▶ 69]
1C00	Sync manager type [▶ 69]
1C12	RxPDO assign [▶ 69]
1C13	TxPDO assign [▶ 70]
1C32	SM output parameter [▶ 70]
1C33	SM input parameter [▶ 71]
6000	DI Inputs [▶ 72]
6010	AI Inputs Ch.1 [▶ 72]
6020	AI Inputs Ch.2 [▶ 72]
6030	AO Inputs Ch.1
6040	AO Inputs Ch.2
7030	AO Outputs Ch.1 [▶ 73]
7040	AO Outputs Ch.2 [▶ 73]

Index (hex)	Name
8010	AI Settings Ch.1 [▶ 64]
801D	AI Advanced Settings Ch.1 [▶ 64]
801F	AI Vendor data Ch.1 [▶ 73]
8020	AI Settings Ch.2 [▶ 64]
802D	AI Advanced Settings Ch.2 [▶ 64]
802F	AI Vendor data Ch.2 [▶ 73]
8030	AO Settings Ch.1 [▶ 65]
803D	AO Advanced Settings Ch.1 [▶ 65]
803F	AO Vendor data Ch.1 [▶ 74]
8040	AO Settings Ch.2 [▶ 65]
804D	AO Advanced Settings Ch.2 [▶ 65]
804F	AO Vendor data Ch.2 [▶ 74]
A010	AI Diag data Ch.1 [▶ 74]
A020	AI Diag data Ch.2 [▶ 75]
A030	AO Diag data Ch.1 [▶ 75]
A040	AO Diag data Ch.2 [▶ 75]
F000	Modular device profile [▶ 75]
F008	Code word [▶ 75]
F010	Module list [▶ 75]
FB00	Command [▶ 75]

6.2 Object description

6.2.1 Objects for parameterization

Index 8010, 8020 AI Settings Ch.n

- Index 8010 AI Settings Ch.1: Analog input at connection 1
- Index 8020 AI Settings Ch.2: Analog input at connection 2

Index (hex)	Name	Description	Data type	Flags	Default
80n0:01	Enable user scale	Enabling user scaling . [► 51]	BOOL	RW	FALSE
80n0:06	Enable filter	Enabling digital filter [► 46].	BOOL	RW	FALSE
80n0:07	Enable limit 1	Activate limit value monitoring [► 48] for limit value 1.	BOOL	RW	FALSE
80n0:08	Enable limit 2	Activate limit value monitoring [► 48] for limit value 2.	BOOL	RW	FALSE
80n0:0A	Enable user calibration	Enabling the user calibration . [► 50]	BOOL	RW	FALSE
80n0:0B	Enable vendor calibration	Enabling vendor calibration [► 49].	BOOL	RW	TRUE
80n0:0E	Swap limit bits	Invert comparison operation of the limit value monitoring [► 48].	BOOL	RW	FALSE
80n0:11	User scale offset	Offset value for the user scaling [► 51].	INT16	RW	0
80n0:12	User scale gain	Gain value for the user scaling [► 51].	INT32	RW	65536 _{dec}
80n0:13	Limit 1	Limit value 1 of limit value monitoring [► 48].	INT16	RW	0
80n0:14	Limit 2	Limit value 2 of limit value monitoring [► 48].	INT16	RW	0
80n0:15	Filter settings	Digital filter [► 46] type.	UINT16	RW	2
80n0:17	User calibration offset	Offset value for the user calibration [► 50].	INT16	RW	0
80n0:18	User calibration gain	Gain value for the user calibration [► 50].	INT16	RW	16384 _{dec}

Index 801D, 802D: AI Advanced Settings Ch.n

- 801D_{hex} AI Advanced Settings Ch.1: Analog input at connection 1
- 802D_{hex} AI Advanced Settings Ch.2: Analog input at connection 2

Index (hex)	Name	Description	Data type	Flags	Default
80nD:11	Input Type	Select measuring range [► 41].	UINT16	RW	2
80nD:12	Scaler	Select nominal or technical measuring range [► 43].	UINT16	RW	0
80nD:17	Low Range Error	Lower error threshold [► 45].	INT32	RW	-32768 _{dec}
80nD:18	High Range Error	Lower error threshold [► 45].	INT32	RW	32767 _{dec}

Index 8030, 8040 AO Settings Ch.n

- Index 8030 AO Settings Ch.1: Analog output at connection 1
- Index 8040 AO Settings Ch.2: Analog output at connection 2

Index (hex)	Name	Description	Data type	Flags	Default
80n0:01	Enable user scale	Enabling user scaling . [► 60]	BOOL	RW	FALSE
80n0:05	Watchdog	Set the behavior of the watchdog . [► 57].	BIT2	RW	0
80n0:07	Enable user calibration	Enabling the user calibration . [► 59]	BOOL	RW	FALSE
80n0:08	Enable vendor calibration	Enabling vendor calibration [► 58].	BOOL	RW	TRUE
80n0:11	User scale offset	Offset value for the user scaling . [► 60].	INT16	RW	0
80n0:12	User scale gain	Gain value for the user scaling [► 60].	INT32	RW	65535 _{dec}
80n0:13	Default output	Set the "Default watchdog value" . [► 57].	INT16	RW	0
80n0:14	Default output ramp	Set the rate of change of the output value for "Watchdog ramp" . [► 57].	UINT16	RW	65535 _{dec}
80n0:15	User calibration offset	Set the offset value for the User synchronization [► 59].	INT16	RW	0
80n0:16	User calibration gain	Set the gain value for the User synchronization [► 59].	INT16	RW	16384 _{dec}

Index 803D, 804D AO Advanced Settings Ch.n

- Index 803D AO Advanced Settings Ch.1: Analog output at connection 1
- Index 804D AO Advanced Settings Ch.2: Analog output at connection 2

Index (hex)	Name	Description	Data type	Flags	Default
80nD:11	Output type	Set the Output signal range [► 53].	UINT16	RW	17 _{dec}

6.2.2 Standard objects

Index 1000 Device type

Access rights: read only

Index (hex)	Name	Description	Data type	Flags	Value
1000:0	Device type	Bit 0 .. 15: Device profile number Bit 16 .. 31: Module profile number (Device profile number 5001: Modular Device Profile MDP)	UINT32	RO	5001 _{dec}

Index 1008 Device name

Access rights: read only

Subindex (hex)	Name	Description	Unit	Data type	Value
-	Device name	Name of the EtherCAT device	-	STRING	EPP4304-1002 / EPP4314-1002

Index 1009 Hardware version

Access rights: read only

Index (hex)	Name	Description	Data type	Flags	Default
1008:0	Hardware version	Hardware version [► 7]	STRING	RO	-

Index 100A Software version

Access rights: read only

Index (hex)	Name	Description	Data type	Flags	Default
100A:0	Software version	Firmware version [► 7]	STRING	RO	-

Index 100B Bootloader version

Index	Name	Meaning	Data type	Flags	Default
100B:0	Bootloader version		STRING	RO	N/A

Index 1011 Restore default parameters

Index	Name	Meaning	Data type	Flags	Default
1011:0	Restore default parameters	Restore default parameters	UINT8	RO	0x01 (1 _{dec})
1011:01	SubIndex 001	If this object is set to "0x64616F6C" in the set value dialog, all backup objects are reset to their delivery state.	UINT32	RW	0x00000000 (0 _{dec})

Index 1018 Identity

Access rights: read only

Index (hex)	Name	Description	Data type	Flags	Value
1018:01	Vendor ID	Vendor identifier (2: Beckhoff Automation)	UINT32	RO	2 _{dec}
1018:02	Product code	Product code	UINT32	RO	0x6476d309 (EPP4304-1002) 0x6476d3a9 (EPP4314-1002)
1018:03	Revision	Bit 0 ... 15: Index number of the product version Bit 16 ... 31: Revision of the device description (ESI)	UINT32	RO	Bit 0 ... 15: 1002 _{dec}
1018:04	Serial number	Reserved	UINT32	RO	0

Index 10E2 Manufacturer-specific Identification Code

Index	Name	Meaning	Data type	Flags	Default
10E2:0	Manufacturer-specific identification code		UINT8	RO	0x01 (1dec)
10E2:01	SubIndex 001		STRING	RO	

Index 10F0 Backup parameter handling

Index	Name	Meaning	Data type	Flags	Default
10F0:0	Backup parameter handling	Information for standardized loading and saving of backup entries	UINT8	RO	0x01 (1dec)
10F0:01	Checksum	Checksum across all backup entries of the EtherCAT slave	UINT32	RO	0x00000000 (0dec)

Index 1600 AO RxPDO-Map Standard Ch.1

Index	Name	Meaning	Data type	Flags	Default
1600:0	AO RxPDO-Map Standard Ch.1	PDO Mapping RxPDO 1	UINT8	RO	0x01 (1dec)
1600:01	SubIndex 001	1. PDO Mapping entry (object 0x7030 (AO Outputs Ch.1), entry 0x01 (Analog output))	UINT32	RO	0x7030:01, 16

Index 1601 AO RxPDO-Map Standard Ch.2

Index	Name	Meaning	Data type	Flags	Default
1601:0	AO RxPDO-Map Standard Ch.2	PDO Mapping RxPDO 2	UINT8	RO	0x01 (1dec)
1601:01	SubIndex 001	1. PDO Mapping entry (object 0x7040 (AO Outputs Ch.2), entry 0x01 (Analog output))	UINT32	RO	0x7040:01, 16

Index 1801 AI TxPDO-Par Standard Ch.1

Index	Name	Meaning	Data type	Flags	Default
1801:0	AI TxPDO-Par Standard Ch.1	PDO parameter TxPDO 2	UINT8	RO	0x06 (6dec)
1801:06	Exclude TxPDOs	Specifies the TxPDOs (index of TxPDO mapping objects) that must not be transferred together with TxPDO 2	OCTET-STRING[2]	RO	02 1A

Index 1802 AI TxPDO-Par Compact Ch. 1

Index	Name	Meaning	Data type	Flags	Default
1802:0	AI TxPDO-Par Compact Ch.1	PDO parameter TxPDO 3	UINT8	RO	0x06 (6dec)
1802:06	Exclude TxPDOs	Specifies the TxPDOs (index of TxPDO mapping objects) that must not be transferred together with TxPDO 3	OCTET-STRING[2]	RO	01 1A

Index 1803 AI TxPDO-Par Standard Ch.2

Index	Name	Meaning	Data type	Flags	Default
1803:0	AI TxPDO-Par Standard Ch.2	PDO parameter TxPDO 4	UINT8	RO	0x06 (6dec)
1803:06	Exclude TxPDOs	Specifies the TxPDOs (index of TxPDO mapping objects) that must not be transferred together with TxPDO 4	OCTET-STRING[2]	RO	04 1A

Index 1804 AI TxPDO-Par Compact Ch. 2

Index	Name	Meaning	Data type	Flags	Default
1804:0	AI TxPDO-Par Compact Ch.2	PDO parameter TxPDO 5	UINT8	RO	0x06 (6dec)
1804:06	Exclude TxPDOs	Specifies the TxPDOs (index of TxPDO mapping objects) that must not be transferred together with TxPDO 5	OCTET-STRING[2]	RO	03 1A

Index 1A00 DI TxPDO-Map Inputs

Index	Name	Meaning	Data type	Flags	Default
1A00:0	DI TxPDO-Map Inputs	PDO Mapping TxPDO 1	UINT8	RO	0x05 (5dec)
1A00:01	SubIndex 001	1. PDO Mapping entry (object 0x6000 (DI Inputs), entry 0x01 (Input 1))	UINT32	RO	0x6000:01, 1
1A00:02	SubIndex 002	2. PDO Mapping entry (object 0x6000 (DI Inputs), entry 0x02 (Input 2))	UINT32	RO	0x6000:02, 1
1A00:03	SubIndex 003	3. PDO Mapping entry (12 bits align)	UINT32	RO	0x0000:00, 12
1A00:04	SubIndex 004	4. PDO Mapping entry (object 0x6000 (DI Inputs), entry 0x0F (TxPDO State))	UINT32	RO	0x6000:0F, 1
1A00:05	SubIndex 005	5. PDO Mapping entry (object 0x6000 (DI Inputs), entry 0x10 (TxPDO Toggle))	UINT32	RO	0x6000:10, 1

Index 1A01 AI TxPDO-Map Standard Ch.1

Index	Name	Meaning	Data type	Flags	Default
1A01:0	AI TxPDO-Map Standard Ch.1	PDO Mapping TxPDO 2	UINT8	RO	0x09 (9dec)
1A01:01	SubIndex 001	1. PDO Mapping entry (object 0x6010 (AI Inputs Ch.1), entry 0x01 (Underrange))	UINT32	RO	0x6010:01, 1
1A01:02	SubIndex 002	2. PDO Mapping entry (object 0x6010 (AI Inputs Ch.1), entry 0x02 (Overrange))	UINT32	RO	0x6010:02, 1
1A01:03	SubIndex 003	3. PDO Mapping entry (object 0x6010 (AI Inputs Ch.1), entry 0x03 (Limit 1))	UINT32	RO	0x6010:03, 2
1A01:04	SubIndex 004	4. PDO Mapping entry (object 0x6010 (AI Inputs Ch.1), entry 0x05 (Limit 2))	UINT32	RO	0x6010:05, 2
1A01:05	SubIndex 005	5. PDO Mapping entry (object 0x6010 (AI Inputs Ch.1), entry 0x07 (Error))	UINT32	RO	0x6010:07, 1
1A01:06	SubIndex 006	6. PDO Mapping entry (7 bits align)	UINT32	RO	0x0000:00, 7
1A01:07	SubIndex 007	7. PDO Mapping entry (object 0x6010 (AI Inputs Ch.1), entry 0x0F (TxPDO State))	UINT32	RO	0x6010:0F, 1
1A01:08	SubIndex 008	8. PDO Mapping entry (object 0x6010 (AI Inputs Ch.1), entry 0x10 (TxPDO Toggle))	UINT32	RO	0x6010:10, 1
1A01:09	SubIndex 009	9. PDO Mapping entry (object 0x6010 (AI Inputs Ch.1), entry 0x11 (Value))	UINT32	RO	0x6010:11, 16

Index 1A02 AI TxPDO-Map Compact Ch.1

Index	Name	Meaning	Data type	Flags	Default
1A02:0	AI TxPDO Map Compact Ch.1	PDO Mapping TxPDO 3	UINT8	RO	0x01 (1dec)
1A02:01	SubIndex 001	1. PDO Mapping entry (object 0x6010 (AI Inputs Ch.1), entry 0x11 (Value))	UINT32	RO	0x6010:11, 16

Index 1A03 AI TxPDO-Map Standard Ch.2

Index	Name	Meaning	Data type	Flags	Default
1A03:0	AI TxPDO-Map Standard Ch.2	PDO Mapping TxPDO 4	UINT8	RO	0x09 (9dec)
1A03:01	SubIndex 001	1. PDO Mapping entry (object 0x6020 (AI Inputs Ch.2), entry 0x01 (Underrange))	UINT32	RO	0x6020:01, 1
1A03:02	SubIndex 002	2. PDO Mapping entry (object 0x6020 (AI Inputs Ch.2), entry 0x02 (Overrange))	UINT32	RO	0x6020:02, 1
1A03:03	SubIndex 003	3. PDO Mapping entry (object 0x6020 (AI Inputs Ch.2), entry 0x03 (Limit 1))	UINT32	RO	0x6020:03, 2
1A03:04	SubIndex 004	4. PDO Mapping entry (object 0x6020 (AI Inputs Ch.2), entry 0x05 (Limit 2))	UINT32	RO	0x6020:05, 2
1A03:05	SubIndex 005	5. PDO Mapping entry (object 0x6020 (AI Inputs Ch.2), entry 0x07 (Error))	UINT32	RO	0x6020:07, 1
1A03:06	SubIndex 006	6. PDO Mapping entry (7 bits align)	UINT32	RO	0x0000:00, 7
1A03:07	SubIndex 007	7. PDO Mapping entry (object 0x6020 (AI Inputs Ch.2), entry 0x0F (TxPDO State))	UINT32	RO	0x6020:0F, 1
1A03:08	SubIndex 008	8. PDO Mapping entry (object 0x6020 (AI Inputs Ch.2), entry 0x10 (TxPDO Toggle))	UINT32	RO	0x6020:10, 1
1A03:09	SubIndex 009	9. PDO Mapping entry (object 0x6020 (AI Inputs Ch.2), entry 0x11 (Value))	UINT32	RO	0x6020:11, 16

Index 1A04 AI TxPDO-Map Compact Ch.2

Index	Name	Meaning	Data type	Flags	Default
1A04:0	AI TxPDO Map Compact Ch.2	PDO Mapping TxPDO 5	UINT8	RO	0x01 (1dec)
1A04:01	SubIndex 001	1. PDO Mapping entry (object 0x6020 (AI Inputs Ch.2), entry 0x11 (Value))	UINT32	RO	0x6020:11, 16

Index 1A05 AO TxPDO-Map Inputs Ch.1

Index	Name	Meaning	Data type	Flags	Default
1A05:0	AO TxPDO Map Inputs Ch.1	PDO Mapping TxPDO 6	UINT8	RO	0x04 (4dec)
1A05:01	SubIndex 001	1. PDO Mapping entry (object 0x6030 (AO Inputs Ch.1), entry 0x01 (Load Impedance too High))	UINT32	RO	0x6030:01, 1
1A05:02	SubIndex 002	2. PDO Mapping entry (5 bits align)	UINT32	RO	0x0000:00, 5
1A05:03	SubIndex 003	3. PDO Mapping entry (object 0x6030 (AO Inputs Ch.1), entry 0x07 (Error))	UINT32	RO	0x6030:07, 1
1A05:04	SubIndex 004	4. PDO Mapping entry (9 bits align)	UINT32	RO	0x0000:00, 9

Index 1A06 AO TxPDO-Map Inputs Ch.2

Index	Name	Meaning	Data type	Flags	Default
1A06:0	AO TxPDO Map Inputs Ch.2	PDO Mapping TxPDO 7	UINT8	RO	0x04 (4dec)
1A06:01	SubIndex 001	1. PDO Mapping entry (object 0x6040 (AO Inputs Ch.2), entry 0x01 (Load Impedance too High))	UINT32	RO	0x6040:01, 1
1A06:02	SubIndex 002	2. PDO Mapping entry (5 bits align)	UINT32	RO	0x0000:00, 5
1A06:03	SubIndex 003	3. PDO Mapping entry (object 0x6040 (AO Inputs Ch.2), entry 0x07 (Error))	UINT32	RO	0x6040:07, 1
1A06:04	SubIndex 004	4. PDO Mapping entry (9 bits align)	UINT32	RO	0x0000:00, 9

Index 1C00 Sync manager type

Index	Name	Meaning	Data type	Flags	Default
1C00:0	Sync manager type	Using the Sync Managers	UINT8	RO	0x04 (4dec)
1C00:01	SubIndex 001	Sync-Manager Type Channel 1: Mailbox Write	UINT8	RO	0x01 (1dec)
1C00:02	SubIndex 002	Sync-Manager Type Channel 2: Mailbox Read	UINT8	RO	0x02 (2dec)
1C00:03	SubIndex 003	Sync-Manager Type Channel 3: Process Data Write (Outputs)	UINT8	RO	0x03 (3dec)
1C00:04	SubIndex 004	Sync-Manager Type Channel 4: Process Data Read (Inputs)	UINT8	RO	0x04 (4dec)

Index 1C12 RxPDO assign

Index	Name	Meaning	Data type	Flags	Default
1C12:0	RxPDO assign	PDO Assign Outputs	UINT8	RW	0x02 (2dec)
1C12:01	SubIndex 001	1. allocated RxPDO (contains the index of the associated RxPDO mapping object)	UINT16	RW	0x1600 (5632dec)
1C12:02	SubIndex 002	2. allocated RxPDO (contains the index of the associated RxPDO mapping object)	UINT16	RW	0x1601 (5633dec)
1C12:03	SubIndex 003	3. allocated RxPDO (contains the index of the associated RxPDO mapping object)	UINT16	RW	0x0000 (0dec)
1C12:04	SubIndex 004	4. allocated RxPDO (contains the index of the associated RxPDO mapping object)	UINT16	RW	0x0000 (0dec)

Index 1C13 TxPDO assign

Index	Name	Meaning	Data type	Flags	Default
1C13:0	TxPDO assign	PDO Assign Inputs	UINT8	RW	0x03 (3dec)
1C13:01	SubIndex 001	1. allocated TxPDO (contains the index of the associated TxPDO mapping object)	UINT16	RW	0x1A00 (6656dec)
1C13:02	SubIndex 002	2. allocated TxPDO (contains the index of the associated TxPDO mapping object)	UINT16	RW	0x1A01 (6657dec)
1C13:03	SubIndex 003	3. allocated TxPDO (contains the index of the associated TxPDO mapping object)	UINT16	RW	0x1A03 (6659dec)
1C13:04	SubIndex 004	4. allocated TxPDO (contains the index of the associated TxPDO mapping object)	UINT16	RW	0x0000 (0dec)
1C13:05	SubIndex 005	5. allocated TxPDO (contains the index of the associated TxPDO mapping object)	UINT16	RW	0x0000 (0dec)
1C13:06	SubIndex 006	6. allocated TxPDO (contains the index of the associated TxPDO mapping object)	UINT16	RW	0x0000 (0dec)
1C13:07	SubIndex 007	7. allocated TxPDO (contains the index of the associated TxPDO mapping object)	UINT16	RW	0x0000 (0dec)

Index 1C32 SM output parameter

Index	Name	Meaning	Data type	Flags	Default
1C32:0	SM output parameter	Synchronization parameters for the outputs	UINT8	RO	0x20 (32dec)
1C32:01	Sync mode	Current synchronization mode: 0: Free Run 1: Synchron with SM 2 Event 2: DC-Mode - Synchron with SYNC0 Event 3: DC-Mode - Synchron with SYNC1 Event	UINT16	RW	0x0001 (1dec)
1C32:02	Cycle time	Cycle time (in ns): Free Run: Cycle time of the local timer Synchron with SM 2 Event: Master cycle time DC mode: SYNC0/SYNC1 Cycle Time	UINT32	RW	0x000F4240 (1000000dec)
1C32:03	Shift time	Time between SYNC0 event and output of the outputs (in ns, DC mode only)	UINT32	RO	0x00000384 (900dec)
1C32:04	Sync modes supported	Supported synchronization modes: Bit 0 = 1: free run is supported Bit 1 = 1: Synchron with SM 2 Event is supported Bit 2-3 = 01: DC mode is supported Bit 4-5 = 10: Output Shift with SYNC1 event (only DC mode) Bit 14 = 1: dynamic times (measurement through writing of 1C32:08)	UINT16	RO	0x4003 (16387dec)
1C32:05	Minimum cycle time	Minimum cycle time (in ns)	UINT32	RO	0x0003D090 (250000dec)
1C32:06	Calc and copy time	Minimum time between SYNC0 and SYNC1 event (in ns, DC mode only)	UINT32	RO	0x00000000 (0dec)
1C32:07	Minimum delay time		UINT32	RO	0x00000384 (900dec)
1C32:08	Get Cycle Time	0: Measurement of the local cycle time is stopped 1: Measurement of the local cycle time is started Entries 1C32:03, 1C32:05, 1C32:06, 1C32:09, 1C33:03, 1C33:06, 1C33:09 are updated with the maximum measured values. For a subsequent measurement the measured values are reset	UINT16	RW	0x0000 (0dec)
1C32:09	Maximum delay time	Time between SYNC1 event and output of the outputs (in ns, DC mode only)	UINT32	RO	0x00000384 (900dec)
1C32:0B	SM event missed counter	Number of missed SM events in OPERATIONAL (DC mode only)	UINT16	RO	0x0000 (0dec)

Index	Name	Meaning	Data type	Flags	Default
1C32:0C	Cycle exceeded counter	Number of occasions the cycle time was exceeded in OPERATIONAL (cycle was not completed in time or the next cycle began too early)	UINT16	RO	0x0000 (0dec)
1C32:0D	Shift too short counter	Number of occasions that the interval between SYNC0 and SYNC1 event was too short (DC mode only)	UINT16	RO	0x0000 (0dec)
1C32:14	Frame repeat time		UINT32	RW	0x00000000 (0dec)
1C32:20	Sync error	The synchronization was not correct in the last cycle (outputs were output too late; DC mode only)	BOOLEAN	RO	0x00 (0dec)

Index 1C33 SM input parameter

Index	Name	Meaning	Data type	Flags	Default
1C33:0	SM input parameter	Synchronization parameters for the inputs	UINT8	RO	0x20 (32dec)
1C33:01	Sync mode	Current synchronization mode: 0: Free Run 1: Synchron with SM 3 event (no outputs available) 2: DC - Synchron with SYNC0 Event 3: DC - Synchron with SYNC1 Event 34: Synchron with SM 2 event (outputs available)	UINT16	RW	0x0022 (34dec)
1C33:02	Cycle time	as 1C32:02	UINT32	RW	0x000F4240 (1000000dec)
1C33:03	Shift time	Time between SYNC0 event and reading of the inputs (in ns, only DC mode)	UINT32	RO	0x00000000 (0dec)
1C33:04	Sync modes supported	Supported synchronization modes: Bit 0: free run is supported Bit 1: Synchron with SM 2 Event is supported (outputs available) Bit 1: Synchron with SM 3 Event is supported (no outputs available) Bit 2-3 = 01: DC mode is supported Bit 4-5 = 01: Input Shift through local event (outputs available) Bit 4-5 = 10: Input Shift with SYNC1 event (no outputs available) Bit 14 = 1: dynamic times (measurement through writing of 1C32:08 or 1C33:08)	UINT16	RO	0x4003 (16387dec)
1C33:05	Minimum cycle time	as 1C32:05	UINT32	RO	0x0003D090 (250000dec)
1C33:06	Calc and copy time	Time between reading of the inputs and availability of the inputs for the master (in ns, only DC mode)	UINT32	RO	0x00000000 (0dec)
1C33:07	Minimum delay time		UINT32	RO	0x00000384 (900dec)
1C33:08	Get Cycle Time	as 1C32:08	UINT16	RW	0x0000 (0dec)
1C33:09	Maximum delay time	Time between SYNC1 event and reading of the inputs (in ns, only DC mode)	UINT32	RO	0x00000384 (900dec)
1C33:0B	SM event missed counter	as 1C32:11	UINT16	RO	0x0000 (0dec)
1C33:0C	Cycle exceeded counter	as 1C32:12	UINT16	RO	0x0000 (0dec)
1C33:0D	Shift too short counter	as 1C32:13	UINT16	RO	0x0000 (0dec)
1C33:14	Frame repeat time		UINT32	RW	0x00000000 (0dec)
1C33:20	Sync error	as 1C32:32	BOOLEAN	RO	0x00 (0dec)

6.2.3 Profile-specific objects

Index 6000 DI Inputs

Index	Name	Meaning	Data type	Flags	Default
6000:0	DI Inputs		UINT8	RO	0x10 (16 _{dec})
6000:01	Input 1		BOOLEAN	RO	0x00 (0 _{dec})
6000:02	Input 2		BOOLEAN	RO	0x00 (0 _{dec})
6000:0F	TxPDO State		BOOLEAN	RO	0x00 (0 _{dec})
6000:10	TxPDO Toggle		BOOLEAN	RO	0x00 (0 _{dec})

Index 6010 AI Inputs Ch.1

Index	Name	Meaning	Data type	Flags	Default
6010:0	AI Inputs Ch. 1		UINT8	RO	0x11 (17 _{dec})
6010:01	Underrange	Underrange event active	BOOLEAN	RO	0x00 (0 _{dec})
6010:02	Overrange	Overrange event active	BOOLEAN	RO	0x00 (0 _{dec})
6010:03	Limit 1	Bit0: Value greater than Limit1 Bit1: Value smaller than Limit1	BIT2	RO	0x00 (0 _{dec})
6010:05	Limit 2	Bit0: Value greater than Limit2 Bit1: Value smaller than Limit2	BIT2	RO	0x00 (0 _{dec})
6010:07	Error	Bit set when Over- or Underrange	BOOLEAN	RO	0x00 (0 _{dec})
6010:0F	TxPDO State		BOOLEAN	RO	0x00 (0 _{dec})
6010:10	TxPDO Toggle		BOOLEAN	RO	0x00 (0 _{dec})
6010:11	Value		INT16	RO	0x0000 (0 _{dec})

Index 6020 AI Inputs Ch.2

Index	Name	Meaning	Data type	Flags	Default
6020:0	AI Inputs Ch.2		UINT8	RO	0x11 (17 _{dec})
6020:01	Underrange	Underrange event active	BOOLEAN	RO	0x00 (0 _{dec})
6020:02	Overrange	Overrange event active	BOOLEAN	RO	0x00 (0 _{dec})
6020:03	Limit 1	Bit0: Value greater than Limit1 Bit1: Value smaller than Limit1	BIT2	RO	0x00 (0 _{dec})
6020:05	Limit 2	Bit0: Value greater than Limit2 Bit1: Value smaller than Limit2	BIT2	RO	0x00 (0 _{dec})
6020:07	Error	Bit set when Over- or Underrange	BOOLEAN	RO	0x00 (0 _{dec})
6020:0F	TxPDO State		BOOLEAN	RO	0x00 (0 _{dec})
6020:10	TxPDO Toggle		BOOLEAN	RO	0x00 (0 _{dec})
6020:11	Value		INT16	RO	0x0000 (0 _{dec})

Index 6030 AO Inputs Ch.1

Index	Name	Meaning	Data type	Flags	Default
6030:0	AO Inputs Ch. 1		UINT8	RO	0x07 (7 _{dec})
6030:01	Load Impedance too Low (EPP4304-1002)		BOOLEAN	RO	0x00 (0 _{dec})
	Load Impedance too High (EPP4314-1002)				
6030:07	Error		BOOLEAN	RO	0x00 (0 _{dec})

Index 6040 AO Inputs Ch.2

Index	Name	Meaning	Data type	Flags	Default
6040:0	AO Inputs Ch.2		UINT8	RO	0x07 (7 _{dec})
6040:01	Load Impedance too Low (EPP4304-1002)		BOOLEAN	RO	0x00 (0 _{dec})
	Load Impedance too High (EPP4314-1002)				
6040:07	Error		BOOLEAN	RO	0x00 (0 _{dec})

Index 7030 AO Outputs Ch.1

Index	Name	Meaning	Data type	Flags	Default
7030:0	AO Outputs Ch.1		UINT8	RO	0x01 (1 _{dec})
7030:01	Analog output		INT16	RO	0x0000 (0 _{dec})

Index 7040 AO Outputs Ch.2

Index	Name	Meaning	Data type	Flags	Default
7040:0	AO Outputs Ch.2		UINT8	RO	0x01 (1 _{dec})
7040:01	Analog output		INT16	RO	0x0000 (0 _{dec})

Index 801F AI Vendor data Ch.1

Index	Name	Meaning	Data type	Flags	Default
801F:0	AI Vendor data Ch.1		UINT8	RO	0x04 (4 _{dec})
801F:03	Calibration offset voltage (EPP4304-1002)		INT16	RW	0x0000 (0 _{dec})
	Calibration offset current (EPP4314-1002)				
801F:04	Calibration gain voltage (EPP4304-1002)		INT16	RW	0x0000 (0 _{dec})
	Calibration gain current (EPP4314-1002)				

Index 802F AI Vendor data Ch.2

Index	Name	Meaning	Data type	Flags	Default
802F:0	AI Vendor data Ch.2		UINT8	RO	0x04 (4 _{dec})
802F:03	Calibration offset voltage (EPP4304-1002)		INT16	RW	0x0000 (0 _{dec})
	Calibration offset current (EPP4314-1002)				
802F:04	Calibration gain voltage (EPP4304-1002)		INT16	RW	0x0000 (0 _{dec})
	Calibration gain current (EPP4314-1002)				

Index 803F AO Vendor data Ch.1 (EPP4304-1002)

Index	Name	Meaning	Data type	Flags	Default
803F:0	AO Vendor data Ch.1		UINT8	RO	0x0A (10 _{dec})
803F:01	Calibration offset voltage		INT16	RW	0x0000 (0 _{dec})
803F:02	Calibration gain voltage		INT16	RW	0x4000 (16384 _{dec})
803F:03	Calibration offset diag		INT16	RW	0x0000 (0 _{dec})
803F:04	Calibration gain diag		INT16	RW	0x0000 (0 _{dec})
803F:07	Error detection threshold		INT16	RW	0x0000 (0 _{dec})

Index 803F AO Vendor data Ch.1 (EPP4314-1002)

Index	Name	Meaning	Data type	Flags	Default
803F:0	AO Vendor data Ch.1		UINT8	RO	0x0A (10 _{dec})
803F:03	Calibration offset current		INT16	RW	0x0000 (0 _{dec})
803F:04	Calibration gain current		INT16	RW	0x0000 (0 _{dec})
803F:07	Calibration offset current negative		INT16	RW	0x0000 (0 _{dec})
803F:08	Calibration gain current negative		INT16	RW	0x0000 (0 _{dec})
803F:09	Amplifier Saturation High Value		INT16	RW	0x0000 (0 _{dec})
803F:0A	Amplifier Saturation Low Value		INT16	RW	0x0000 (0 _{dec})

Index 804F AO Vendor data Ch.2 (EPP4304-1002)

Index	Name	Meaning	Data type	Flags	Default
804F:0	AO Vendor data Ch.2		UINT8	RO	0x0A (10 _{dec})
804F:01	Calibration offset voltage		INT16	RW	0x0000 (0 _{dec})
804F:02	Calibration gain voltage		INT16	RW	0x4000 (16384 _{dec})
804F:03	Calibration offset diag		INT16	RW	0x0000 (0 _{dec})
804F:04	Calibration gain diag		INT16	RW	0x0000 (0 _{dec})
804F:07	Error detection threshold		INT16	RW	0x0000 (0 _{dec})

Index 804F AO Vendor data Ch.2 (EPP4314-1002)

Index	Name	Meaning	Data type	Flags	Default
804F:0	AO Vendor data Ch.2		UINT8	RO	0x0A (10 _{dec})
804F:03	Calibration offset current		INT16	RW	0x0000 (0 _{dec})
804F:04	Calibration gain current		INT16	RW	0x0000 (0 _{dec})
804F:07	Calibration offset current negative		INT16	RW	0x0000 (0 _{dec})
804F:08	Calibration gain current negative		INT16	RW	0x0000 (0 _{dec})
804F:09	Amplifier Saturation High Value		INT16	RW	0x0000 (0 _{dec})
804F:0A	Amplifier Saturation Low Value		INT16	RW	0x0000 (0 _{dec})

Index A010 AI Diag data Ch.1

Index	Name	Meaning	Data type	Flags	Default
A010:0	AI Diag data Ch.1		UINT8	RO	0x01 (1 _{dec})
A010:01	ADC raw value		INT16	RO	0x0000 (0 _{dec})

Index A020 AI Diag data Ch.2

Index	Name	Meaning	Data type	Flags	Default
A020:0	AI Diag data Ch.2		UINT8	RO	0x01 (1 _{dec})
A020:01	ADC raw value		INT16	RO	0x0000 (0 _{dec})

Index A030 AO Diag data Ch.1

Index	Name	Meaning	Data type	Flags	Default
A030:0	AO Diag data Ch.1		UINT8	RO	0x01 (1 _{dec})
A030:01	DAC Raw Value		UINT16	RO	0x0000 (0 _{dec})

Index A040 AO Diag data Ch.2

Index	Name	Meaning	Data type	Flags	Default
A040:0	AO Diag data Ch.2		UINT8	RO	0x01 (1 _{dec})
A040:01	DAC Raw Value		UINT16	RO	0x0000 (0 _{dec})

Index F000 Modular Device Profile

Index	Name	Meaning	Data type	Flags	Default
F000:0	Modular Device Profile	General information for the modular device profile	UINT8	RO	0x02 (2 _{dec})
F000:01	Index distance	Index distance of the objects of the individual channels	UINT16	RO	0x0010 (16 _{dec})
F000:02	Maximum number of modules	Number of channels	UINT16	RO	0x0005 (5 _{dec})

Index F008 Code word

Index	Name	Meaning	Data type	Flags	Default
F008:0	Code word		UINT32	RW	0x00000000 (0 _{dec})

Index F010 Module Profile List

Index	Name	Meaning	Data type	Flags	Default
F010:0	Module Profile List		UINT8	RO	0x05 (5 _{dec})
F010:01	SubIndex 001		UINT32	RO	0x00000064 (100 _{dec})
F010:02	SubIndex 002		UINT32	RO	0x0000012C (300 _{dec})
F010:03	SubIndex 003		UINT32	RO	0x0000012C (300 _{dec})
F010:04	SubIndex 004		UINT32	RO	0x00000190 (400 _{dec})
F010:05	SubIndex 005		UINT32	RO	0x00000190 (400 _{dec})

Index FB00 command

Index	Name	Meaning	Data type	Flags	Default
FB00:0	Command		UINT8	RO	0x03 (3 _{dec})
FB00:01	Request		OCTET-STRING[2]	RW	{0}
FB00:02	Status		UINT8	RO	0x00 (0 _{dec})
FB00:03	Response		OCTET-STRING[6]	RO	{0}

7 Appendix

7.1 General operating conditions

Protection rating according to IP code

The degrees of protection are defined and divided into different classes in the IEC 60529 standard (EN 60529). Degrees of protection are designated by the letters "IP" and two numerals: **IPxy**

- Numeral x: Dust protection and contact protection
- Numeral y: Protection against water

x	Meaning
0	Not protected
1	Protected against access to dangerous parts with the back of the hand. Protected against solid foreign objects of 50 mm Ø
2	Protected against access to dangerous parts with a finger. Protected against solid foreign objects of 12.5 mm Ø
3	Protected against access to dangerous parts with a tool. Protected against solid foreign objects of 2.5 mm Ø
4	Protected against access to dangerous parts with a wire. Protected against solid foreign objects of 1 mm Ø
5	Protection against access to dangerous parts with a wire. Dust-protected. Ingress of dust is not prevented completely, although the quantity of dust able to penetrate is limited to such an extent that the proper function of the device and safety are not impaired
6	Protection against access to dangerous parts with a wire. Dust-tight. No ingress of dust

y	Meaning
0	Not protected
1	Protection against vertically falling water drops
2	Protection against vertically falling water drops when enclosure tilted up to 15°
3	Protection against spraying water. Water sprayed at an angle of up to 60° on either side of the vertical shall have no harmful effects
4	Protection against splashing water. Water splashed against the enclosure from any direction shall have no harmful effects
5	Protection against water jets.
6	Protection against powerful water jets.
7	Protected against the effects of temporary immersion in water. Ingress of water in quantities causing harmful effects shall not be possible when the enclosure is immersed in water at a depth of 1 m for 30 minutes

Chemical resistance

The resistance refers to the housing of the IP67 modules and the metal parts used. In the table below you will find some typical resistances.

Type	Resistance
Water vapor	unstable at temperatures > 100 °C
Sodium hydroxide solution (ph value > 12)	stable at room temperature unstable > 40 °C
Acetic acid	unstable
Argon (technically pure)	stable

Key

- resistant: Lifetime several months
- non inherently resistant: Lifetime several weeks
- not resistant: Lifetime several hours resp. early decomposition

7.2 Accessories

Mounting

Ordering information	Description	Link
ZS5300-0011	Mounting rail	Website

Cables

A complete overview of pre-assembled cables for fieldbus components can be found [here](#).

Ordering information	Description	Link
ZB8513-0002	EMC shield clamp for M12 connectors	Data sheet
ZK2000-5152-1xxx	Sensor cable M12, 5-pin, shielded	Website
ZK700x-xxxx-xxxx	EtherCAT P cable M8	Website

Labeling material, protective caps

Ordering information	Description
ZS5000-0010	Protective cap for M8 sockets, IP67 (50 pieces)
ZS5000-0020	Protective cap for M12 sockets, IP67 (50 pcs.)
ZS5100-0000	Inscription labels, unprinted, 4 strips of 10
ZS5000-xxxx	Printed inscription labels on enquiry

Tools

Ordering information	Description
ZB8801-0000	Torque wrench for plugs, 0.4...1.0 Nm
ZB8801-0001	Torque cable key for M8 / wrench size 9 for ZB8801-0000
ZB8801-0002	Torque cable key for M12 / wrench size 13 for ZB8801-0000
ZB8801-0003	Torque cable key for M12 field assembly / wrench size 18 for ZB8801-0000



Further accessories

Further accessories can be found in the price list for fieldbus components from Beckhoff and online at <https://www.beckhoff.com>.

7.3 Continuative documentation for I/O components with analog in and outputs

NOTICE



Continuative documentation for I/O components with analog in and outputs

Pay also attention to the continuative documentation

I/O Analog Manual

Notes on I/O components with analog inputs and outputs,

which is available in the Beckhoff [Information-System](#) and for [download](#) on the Beckhoff homepage www.beckhoff.com on the respective product pages!

It explains the basics of sensor technology and contains notes on analog measured values.

7.4 Version identification of EtherCAT devices

7.4.1 General notes on marking

Designation

A Beckhoff EtherCAT device has a 14-digit designation, made up of

- family key
- type
- version
- revision

Example	Family	Type	Version	Revision
EL3314-0000-0016	EL terminal 12 mm, non-pluggable connection level	3314 4-channel thermocouple terminal	0000 basic type	0016
ES3602-0010-0017	ES terminal 12 mm, pluggable connection level	3602 2-channel voltage measurement	0010 high-precision version	0017
CU2008-0000-0000	CU device	2008 8-port fast ethernet switch	0000 basic type	0000

Notes

- The elements mentioned above result in the **technical designation**. EL3314-0000-0016 is used in the example below.
- EL3314-0000 is the order identifier, in the case of “-0000” usually abbreviated to EL3314. “-0016” is the EtherCAT revision.
- The **order identifier** is made up of
 - family key (EL, EP, CU, ES, KL, CX, etc.)
 - type (3314)
 - version (-0000)
- The **revision** -0016 shows the technical progress, such as the extension of features with regard to the EtherCAT communication, and is managed by Beckhoff.
 In principle, a device with a higher revision can replace a device with a lower revision, unless specified otherwise, e.g. in the documentation.
 Associated and synonymous with each revision there is usually a description (ESI, EtherCAT Slave Information) in the form of an XML file, which is available for download from the Beckhoff web site.
 From 2014/01 the revision is shown on the outside of the IP20 terminals, see Fig. “EL5021 EL terminal, standard IP20 IO device with batch number and revision ID (since 2014/01)”.
- The type, version and revision are read as decimal numbers, even if they are technically saved in hexadecimal.

7.4.2 Version identification of IP67 modules

The serial number/ data code for Beckhoff IO devices is usually the 8-digit number printed on the device or on a sticker. The serial number indicates the configuration in delivery state and therefore refers to a whole production batch, without distinguishing the individual modules of a batch.

Structure of the serial number: **KK YY FF HH**

KK - week of production (CW, calendar week)

YY - year of production

FF - firmware version

HH - hardware version

Example with serial number 12 06 3A 02:

12 - production week 12

06 - production year 2006

3A - firmware version 3A

02 - hardware version 02

Exceptions can occur in the **IP67 area**, where the following syntax can be used (see respective device documentation):

Syntax: D ww yy x y z u

D - prefix designation

ww - calendar week

yy - year

x - firmware version of the bus PCB

y - hardware version of the bus PCB

z - firmware version of the I/O PCB

u - hardware version of the I/O PCB

Example: D.22081501 calendar week 22 of the year 2008 firmware version of bus PCB: 1 hardware version of bus PCB: 5 firmware version of I/O PCB: 0 (no firmware necessary for this PCB) hardware version of I/O PCB: 1

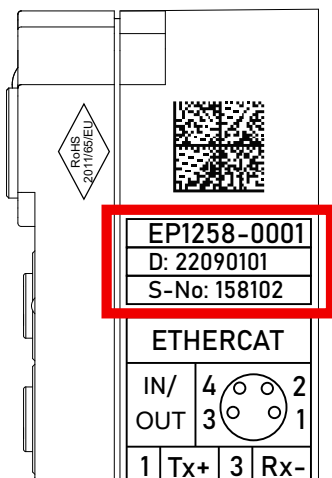

Fig. 5: EP1258-00001 IP67 EtherCAT Box with batch number/DateCode 22090101 and unique serial number 158102

7.4.3 Beckhoff Identification Code (BIC)

The Beckhoff Identification Code (BIC) is increasingly being applied to Beckhoff products to uniquely identify the product. The BIC is represented as a Data Matrix Code (DMC, code scheme ECC200), the content is based on the ANSI standard MH10.8.2-2016.

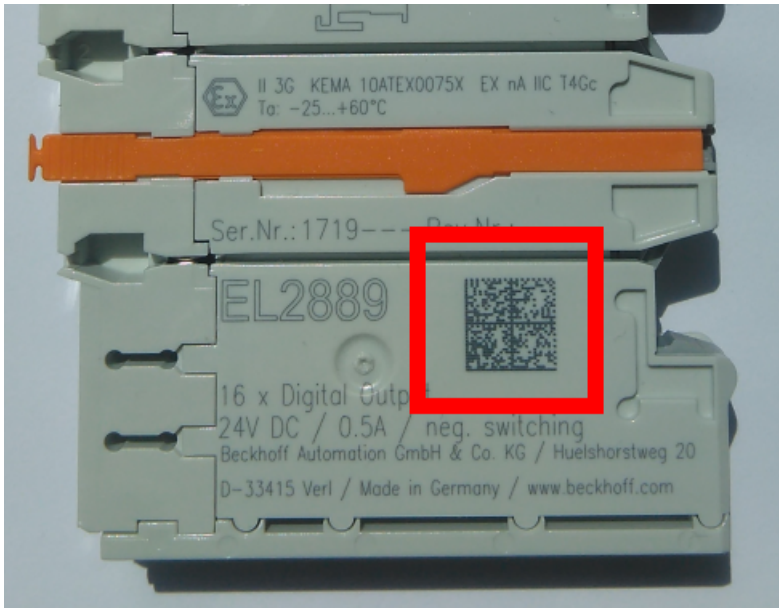

Fig. 6: BIC as data matrix code (DMC, code scheme ECC200)

The BIC will be introduced step by step across all product groups.

Depending on the product, it can be found in the following places:

- on the packaging unit
- directly on the product (if space suffices)
- on the packaging unit and the product

The BIC is machine-readable and contains information that can also be used by the customer for handling and product management.

Each piece of information can be uniquely identified using the so-called data identifier (ANSI MH10.8.2-2016). The data identifier is followed by a character string. Both together have a maximum length according to the table below. If the information is shorter, spaces are added to it.

Following information is possible, positions 1 to 4 are always present, the other according to need of production:

Position	Type of information	Explanation	Data identifier	Number of digits incl. data identifier	Example
1	Beckhoff order number	Beckhoff order number	1P	8	1P 072222
2	Beckhoff Traceability Number (BTN)	Unique serial number, see note below	SBTN	12	S BTNk4p562d7
3	Article description	Beckhoff article description, e.g. EL1008	1K	32	1K EL1809
4	Quantity	Quantity in packaging unit, e.g. 1, 10, etc.	Q	6	Q 1
5	Batch number	Optional: Year and week of production	2P	14	2P 401503180016
6	ID/serial number	Optional: Present-day serial number system, e.g. with safety products	51S	12	51S 678294
7	Variant number	Optional: Product variant number on the basis of standard products	30P	32	30P F971, 2*K183
...					

Further types of information and data identifiers are used by Beckhoff and serve internal processes.

Structure of the BIC

Example of composite information from positions 1 to 4 and with the above given example value on position 6. The data identifiers are highlighted in bold font:

1P072222**S**BTNk4p562d7**1K**EL1809 **Q**1 **51S**678294

Accordingly as DMC:



Fig. 7: Example DMC **1P**072222**S**BTNk4p562d7**1K**EL1809 **Q**1 **51S**678294

BTN

An important component of the BIC is the Beckhoff Traceability Number (BTN, position 2). The BTN is a unique serial number consisting of eight characters that will replace all other serial number systems at Beckhoff in the long term (e.g. batch designations on IO components, previous serial number range for safety products, etc.). The BTN will also be introduced step by step, so it may happen that the BTN is not yet coded in the BIC.

NOTICE

This information has been carefully prepared. However, the procedure described is constantly being further developed. We reserve the right to revise and change procedures and documentation at any time and without prior notice. No claims for changes can be made from the information, illustrations and descriptions in this information.

7.4.4 Electronic access to the BIC (eBIC)

Electronic BIC (eBIC)

The Beckhoff Identification Code (BIC) is applied to the outside of Beckhoff products in a visible place. If possible, it should also be electronically readable.

Decisive for the electronic readout is the interface via which the product can be electronically addressed.

K-bus devices (IP20, IP67)

Currently, no electronic storage and readout is planned for these devices.

EtherCAT devices (IP20, IP67)

All Beckhoff EtherCAT devices have a so-called ESI-EEPROM, which contains the EtherCAT identity with the revision number. Stored in it is the EtherCAT slave information, also colloquially known as ESI/XML configuration file for the EtherCAT master. See the corresponding chapter in the EtherCAT system manual ([Link](#)) for the relationships.

The eBIC is also stored in the ESI-EEPROM. The eBIC was introduced into the Beckhoff I/O production (terminals, box modules) from 2020; widespread implementation is expected in 2021.

The user can electronically access the eBIC (if existent) as follows:

- With all EtherCAT devices, the EtherCAT master (TwinCAT) can read the eBIC from the ESI-EEPROM
 - From TwinCAT 3.1 build 4024.11, the eBIC can be displayed in the online view.
 - To do this, check the checkbox "Show Beckhoff Identification Code (BIC)" under EtherCAT → Advanced Settings → Diagnostics:

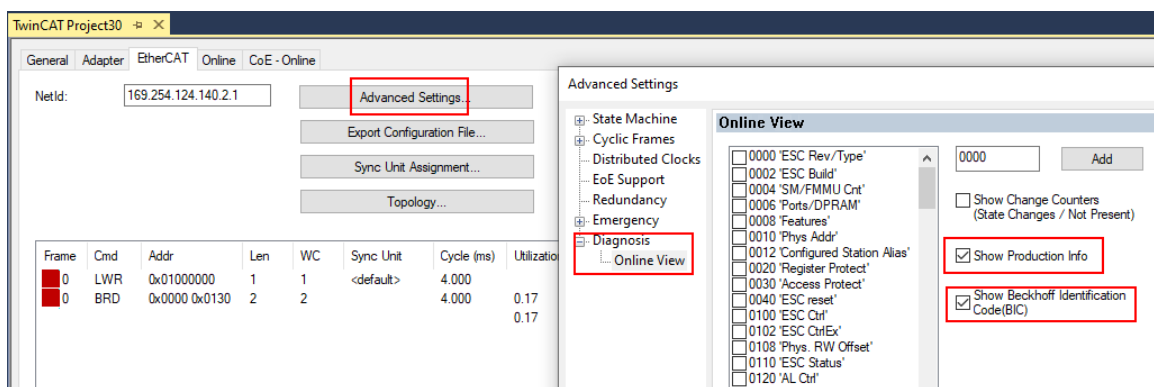

- The BTN and its contents are then displayed:

No	Addr	Name	State	CRC	Fw	Hw	Production Data	ItemNo	BTN	Description	Quantity	BatchNo	SerialNo
1	1001	Term 1 (EK1100)	OP	0.0	0	0	---						
2	1002	Term 2 (EL1018)	OP	0.0	0	0	2020 KW36 Fr	072222	k4p562d7	EL1809	1		678294
3	1003	Term 3 (EL3204)	OP	0.0	7	6	2012 KW24 Sa						
4	1004	Term 4 (EL2004)	OP	0.0	0	0	---	072223	k4p562d7	EL2004	1		678295
5	1005	Term 5 (EL1008)	OP	0.0	0	0	---						
6	1006	Term 6 (EL2008)	OP	0.0	0	12	2014 KW14 Mo						
7	1007	Term 7 (EK1110)	OP	0	1	8	2012 KW25 Mo						

- Note: as can be seen in the illustration, the production data HW version, FW version and production date, which have been programmed since 2012, can also be displayed with "Show Production Info".
- Access from the PLC: From TwinCAT 3.1. build 4024.24 the functions *FB_EcReadBIC* and *FB_EcReadBTN* are available in the Tc2_EtherCAT Library from v3.3.19.0 for reading into the PLC..
- In the case of EtherCAT devices with CoE directory, the object 0x10E2:01 can additionally be used to display the device's own eBIC; the PLC can also simply access the information here:

- The device must be in PREOP/SAFEOP/OP for access:

Index	Name	Flags	Value
1000	Device type	RO	0x015E1389 (22942601)
1008	Device name	RO	ELM3704-0000
1009	Hardware version	RO	00
100A	Software version	RO	01
100B	Bootloader version	RO	J0.1.27.0
1011:0	Restore default parameters	RO	> 1 <
1018:0	Identity	RO	> 4 <
10E2:0	Manufacturer-specific Identification C...	RO	> 1 <
10E2:01	SubIndex 001	RO	1P158442SBTN0008jckp1KELM3704 Q1 2P482001000016
10F0:0	Backup parameter handling	RO	> 1 <
10F3:0	Diagnosis History	RO	> 21 <
10F8	Actual Time Stamp	RO	0x170bfb277e

- The object 0x10E2 will be introduced into stock products in the course of a necessary firmware revision.
- From TwinCAT 3.1. build 4024.24 the functions *FB_EcCoEReadBIC* and *FB_EcCoEReadBTN* are available in the *Tc2_EtherCAT Library* from v3.3.19.0 for reading into the PLC.
- For processing the BIC/BTN data in the PLC, the following auxiliary functions are available in *Tc2_Uilities* from TwinCAT 3.1 build 4024.24 onwards
 - *F_SplitBIC*: The function splits the Beckhoff Identification Code (BIC) *sBICValue* into its components based on known identifiers and returns the recognized partial strings in a structure *ST_SplitBIC* as return value.
 - *BIC_TO_BTN*: The function extracts the BTN from the BIC and returns it as a value.
- Note: in the case of electronic further processing, the BTN is to be handled as a string(8); the identifier "SBTN" is not part of the BTN.
- Technical background
The new BIC information is additionally written as a category in the ESI-EEPROM during the device production. The structure of the ESI content is largely dictated by the ETG specifications, therefore the additional vendor-specific content is stored with the help of a category according to ETG.2010. ID 03 indicates to all EtherCAT masters that they must not overwrite these data in case of an update or restore the data after an ESI update.
The structure follows the content of the BIC, see there. This results in a memory requirement of approx. 50..200 bytes in the EEPROM.
- Special cases
 - If multiple, hierarchically arranged ESCs are installed in a device, only the top-level ESC carries the eBIC Information.
 - If multiple, non-hierarchically arranged ESCs are installed in a device, all ESCs carry the eBIC Information.
 - If the device consists of several sub-devices with their own identity, but only the top-level device is accessible via EtherCAT, the eBIC of the top-level device is located in the CoE object directory 0x10E2:01 and the eBICs of the sub-devices follow in 0x10E2:nn.

PROFIBUS, PROFINET, DeviceNet devices etc.

Currently, no electronic storage and readout is planned for these devices.

7.5 Support and Service

Beckhoff and their partners around the world offer comprehensive support and service, making available fast and competent assistance with all questions related to Beckhoff products and system solutions.

Beckhoff's branch offices and representatives

Please contact your Beckhoff branch office or representative for local support and service on Beckhoff products!

The addresses of Beckhoff's branch offices and representatives round the world can be found on her internet pages: www.beckhoff.com

You will also find further documentation for Beckhoff components there.

Support

The Beckhoff Support offers you comprehensive technical assistance, helping you not only with the application of individual Beckhoff products, but also with other, wide-ranging services:

- support
- design, programming and commissioning of complex automation systems
- and extensive training program for Beckhoff system components

Hotline: +49 5246 963 157
e-mail: support@beckhoff.com
web: www.beckhoff.com/support

Service

The Beckhoff Service Center supports you in all matters of after-sales service:

- on-site service
- repair service
- spare parts service
- hotline service

Hotline: +49 5246 963 460
e-mail: service@beckhoff.com
web: www.beckhoff.com/service

Headquarters Germany

Beckhoff Automation GmbH & Co. KG

Hülshorstweg 20
33415 Verl
Germany

Phone: +49 5246 963 0
e-mail: info@beckhoff.com
web: www.beckhoff.com

Beckhoff Automation GmbH & Co. KG
Hülshorstweg 20
33415 Verl
Germany
Phone: +49 5246 9630
info@beckhoff.com
www.beckhoff.com