

Operating manual | EN

EPX1058-0022

Eight channel, digital EtherCAT Box for NAMUR sensors, Ex i



Table of contents

1 Foreword	5
1.1 Notes on the documentation	5
1.2 Safety instructions	6
1.3 Documentation Issue Status	7
1.4 Marking of EPX modules.....	8
2 Product overview	10
2.1 EPX1058-0022 - Introduction	10
2.2 EPX1058-0022 - Technical data	11
2.3 Intended use	13
3 Mounting and connection	14
3.1 Special conditions for EPX EtherCAT Box modules	14
3.2 Installation notes for EPX EtherCAT Box Modules	14
3.3 Mounting	16
3.3.1 Dimensions	16
3.3.2 Mounting	17
3.3.3 Functional earth (FE)	17
3.3.4 Disposal	17
3.4 Connection	18
3.4.1 Connector.....	18
3.4.2 EtherCAT	19
3.4.3 Power supply.....	21
3.4.4 Signal inputs.....	23
3.4.5 Shielding and potential separation.....	24
4 Appendix	26
4.1 EtherCAT AL Status Codes	26
4.2 UL notice	26
4.3 Support and Service.....	27

1 Foreword

1.1 Notes on the documentation

Intended audience

This description is only intended for the use of trained specialists in control and automation engineering who are familiar with the applicable national standards.

It is essential that the documentation and the following notes and explanations are followed when installing and commissioning these components.

It is the duty of the technical personnel to use the documentation published at the respective time of each installation and commissioning.

The responsible staff must ensure that the application or use of the products described satisfy all the requirements for safety, including all the relevant laws, regulations, guidelines and standards.

Disclaimer

The documentation has been prepared with care. The products described are, however, constantly under development.

We reserve the right to revise and change the documentation at any time and without prior announcement.

No claims for the modification of products that have already been supplied may be made on the basis of the data, diagrams and descriptions in this documentation.

Trademarks

Beckhoff®, TwinCAT®, TwinCAT/BSD®, TC/BSD®, EtherCAT®, EtherCAT G®, EtherCAT G10®, EtherCAT P®, Safety over EtherCAT®, TwinSAFE®, XFC®, XTS® and XPlanar® are registered trademarks of and licensed by Beckhoff Automation GmbH. Other designations used in this publication may be trademarks whose use by third parties for their own purposes could violate the rights of the owners.

Patent Pending

The EtherCAT Technology is covered, including but not limited to the following patent applications and patents: EP1590927, EP1789857, EP1456722, EP2137893, DE102015105702 with corresponding applications or registrations in various other countries.

The logo for EtherCAT, featuring the word "EtherCAT" in a bold, black, sans-serif font. A red arrow points from the top of the "A" towards the right, ending above the "T". A registered trademark symbol (®) is located to the right of the "T".

EtherCAT® is registered trademark and patented technology, licensed by Beckhoff Automation GmbH, Germany.

Copyright

© Beckhoff Automation GmbH & Co. KG, Germany.

The reproduction, distribution and utilization of this document as well as the communication of its contents to others without express authorization are prohibited.

Offenders will be held liable for the payment of damages. All rights reserved in the event of the grant of a patent, utility model or design.

1.2 Safety instructions

Safety regulations

Please note the following safety instructions and explanations!
Product-specific safety instructions can be found on following pages or in the areas mounting, wiring, commissioning etc.

Exclusion of liability

All the components are supplied in particular hardware and software configurations appropriate for the application. Modifications to hardware or software configurations other than those described in the documentation are not permitted, and nullify the liability of Beckhoff Automation GmbH & Co. KG.

Personnel qualification

This description is only intended for trained specialists in control, automation and drive engineering who are familiar with the applicable national standards.

Description of instructions

In this documentation the following instructions are used.
These instructions must be read carefully and followed without fail!

DANGER

Serious risk of injury!

Failure to follow this safety instruction directly endangers the life and health of persons.

WARNING

Risk of injury!

Failure to follow this safety instruction endangers the life and health of persons.

CAUTION

Personal injuries!

Failure to follow this safety instruction can lead to injuries to persons.

NOTE

Damage to environment/equipment or data loss

Failure to follow this instruction can lead to environmental damage, equipment damage or data loss.



Tip or pointer

This symbol indicates information that contributes to better understanding.

1.3 Documentation Issue Status

Version	Comment
1.0.0	<ul style="list-style-type: none">• Ex marking and name plates updated• Certificate numbers updated• Chapter <i>Special conditions for EPX EtherCAT Box Modules</i> updated
0.3	<ul style="list-style-type: none">• Chapter <i>Marking of EPX modules</i> updated• Technical data updated• Chapter <i>Mounting and connection</i> updated
0.2	<ul style="list-style-type: none">• Product images updated• Chapter <i>Marking of EPX modules</i> updated• Product overview updated• Technical data updated• Mounting and connection updated• New title page
0.1	<ul style="list-style-type: none">• First draft

1.4 Marking of EPX modules

Name

An EPX EtherCAT Box has a 15-digit technical designation, composed of

- Family key
- Type
- Version
- Revision

Example	Family	Type	Version	Revision
EPX1058-0022-0001	EPX EtherCAT Box	1058: 8-channel digital EtherCAT Box for NAMUR sensors, Ex i	0022: 60 mm width, M12	0001

Notes

- the elements mentioned above result in the **technical designation**. EPX1058-0022-0001 is used in the example below.
- "EPX1058-0022" is the order identifier, "0001" is the EtherCAT revision.
- The **order identifier** is composed of
 - family key (EPX)
 - type (1058)
 - version (0022)
- The **revision** 0001 reflects the technical progress such as feature enhancement with regard to EtherCAT communication and is managed by Beckhoff.
In principle, a device with a higher revision can replace a device with a lower revision, unless otherwise specified, e.g. in the documentation.
Associated and synonymous with each revision there is usually a description (ESI, EtherCAT Slave Information) in the form of an XML file, which is available for download from the Beckhoff website.
The revision is applied to the modules on the outside, see Fig. *EPX1058 with date code 3218FMFM, BTN 10000100 and Ex marking*.
- The type, version and revision are read as decimal numbers, even if they are technically saved in hexadecimal.

Identification numbers

EPX modules have two different identification numbers:

- date code (batch number)
- **Beckhoff Traceability Number**, or BTN for short (as a serial number it clearly identifies each module)

Date code

The date code is an eight-digit number given by Beckhoff and printed on the EPX module. The date code indicates the build version in the delivery state and thus identifies an entire production batch but does not distinguish between the modules in a batch.

Structure of the date code: **WW YY FF HH**
 WW - week of production (calendar week)
 YY - year of production
 FF - firmware version
 HH - hardware version

Example with date code 02180100:
 02 - week of production 02
 18 - year of production 2018
 01 - firmware version 01
 00 - hardware version 00

Beckhoff Traceability Number (BTN)

In addition, each EPX EtherCAT Box has a unique **Beckhoff Traceability Number (BTN)**.

Ex marking

In the center of the labeling you will find the Ex marking:

II 3 (1) G Ex ec [ia Ga] IIC T4 Gc
 II 3 (1) D Ex tc [ia Da] IIIC T135°C Dc
 I (M1) [Ex ia Ma] I
 IECEx BVS 22.0043X
 BVS 22 ATEX E 047 X
 Ta: -25 ... +70 °C

Examples



Fig. 1: Side name plate of EPX1058-0022, EPX3158-0022 and EPX3184-0022

2 Product overview

2.1 EPX1058-0022 - Introduction

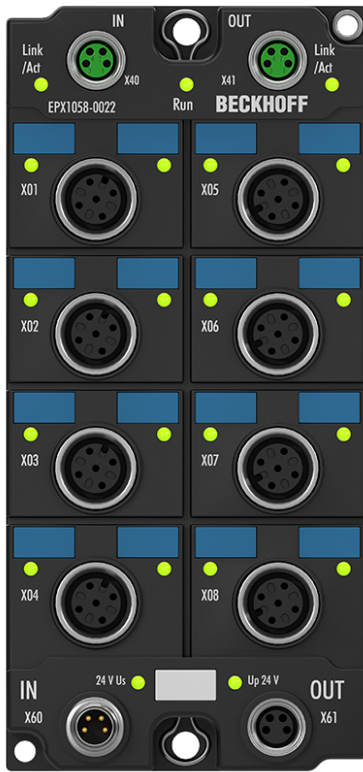

Fig. 2: EPX1058-0022 - 8-channel digital EtherCAT Box for NAMUR sensors, Ex i

The EPX1058-0022 digital EtherCAT Box allows the direct connection of intrinsically safe NAMUR field devices from hazardous areas of zones 0/20 and 1/21 and acquires their signals according to IEC 60947-5-6. The sensors are supplied with a voltage of 8.2 V and return a diagnosable current signal. In this way a wire break or short-circuit can be detected in addition to the switching state. The LEDs display the signal states or any error states.

On the software side, it can be selected channel by channel whether a positive or negative switching sensor is connected. This allows both NAMUR NC and NO to be integrated into the control system.

In addition, the error LEDs for the integration of potential-free switches can be deactivated channel by channel. Individual channels that are not used can be switched off.

2.2 EPX1058-0022 - Technical data

EtherCAT		EPX1058-0022
Connection		2x M8 socket, 4-pin, green

Supply voltage		EPX1058-0022
Connection	Input	M8 connector, 4-pin, black
	Downstream connection	M8 socket, 4-pin, black
U _S nominal voltage		24 V _{DC} (-15 % / +20 %)
U _S current consumption		typically 40 mA
U _S sum current: I _{S,SUM}		max. 4 A at 55 °C, max. 2.5 A at 70 °C, linear in between
U _P nominal voltage		24 V _{DC} (-15 % / +20 %)
U _P current consumption		typically 51 mA
U _P sum current: I _{P,SUM}		max. 4 A at 55 °C, max. 2.5 A at 70 °C, linear in between

Digital inputs		EPX1058-0022
Technology		NAMUR
Number of inputs		8
Connection		8 x M12 socket
Signal type		Binary / Current
Specification		NAMUR DC switching amplifier (IEC 60947-5-6)
Connection technology		2-wire
Signal current "0"		≤ 1.2 mA
Signal current "1"		≥ 2.1 mA
Switching frequency		max. 1 kHz (duty cycle 50%)
Open circuit voltage		typically 8.2 V _{DC}
Short circuit current		> 7 mA typically
Error detection		I ≤ 0.2 mA (wire break), I ≥ 6.3 mA (short circuit)
Distributed Clocks		-
Bit width in the process image		8 x 2 bit

Housing data		EPX1058-0022
Dimensions (W x H x D)		60 mm x 150 mm x 26.5 mm
Weight		approx. 250 g
Installation position		variable
Material		PA6 (polyamide)

Environmental conditions		EPX1058-0022
Permissible ambient temperature range during operation		-25 °C ... +70 °C
Permissible ambient temperature range during storage		-40 °C ... +85 °C
Mounting		Stand-alone / on optional mounting rail
Vibration / shock resistance		conforms to EN 60068-2-6 / EN 60068-2-27
EMC immunity / emission		conforms to EN 61000-6-2 / EN 61000-6-4
Protection rating		IP65, IP66, IP67 (according to EN 60529)

Approvals	EPX1058-0022
Approvals / markings*	CE, UL, ATEX, IECEx

*) Real applicable approvals/markings see type plate on the side (product marking).

Technical data for explosion protection		EPX1058-0022	
Ex marking		II 3 (1) G Ex ec [ia Ga] IIC T4 Gc II 3 (1) D Ex tc [ia Da] IIIC T135°C Dc I (M1) [Ex ia Ma] I	
Certificate numbers		IECEX BVS 22.0043X BVS 22 ATEX E 047 X	
Power supply		Via U_s and U_p $U_m = 60 V_{DC}$	
Field interfaces		$U_o = 10.72 V$ $I_o = 10.4 mA$ $P_o = 28 mW$ Characteristic curve: linear	
Reactances (without consideration of simultaneity)		L_o	C_o
	Ex ia I	100 mH	58 μF
	Ex ia IIA	100 mH	66 μF
	Ex ia IIB	100 mH	15 μF
	Ex ia IIC	100 mH	2.14 μF
	Ex ia IIIC	100 mH	15 μF

2.3 Intended use

WARNING

Danger to the safety of persons and equipment!

EPX components may only be used for the purposes described below!

CAUTION

Observe ATEX and IECEx!

The EPX components may only be used in accordance with the ATEX directive and the IECEx scheme!

The EPX EtherCAT Box Modules extend the field of application of the EtherCAT system with functions for integrating intrinsically safe field devices from hazardous areas. The intended field of application is data acquisition and control tasks in discrete and process engineering automation, taking into account explosion protection requirements.

The EPX EtherCAT Box Modules are protected by the type of protection "Increased safety" (Ex e) according to IEC 60079-7 and must only be operated in hazardous areas of Zone 2, Zone 22 or in non-hazardous areas.

The field interfaces of the EPX EtherCAT Box Modules achieve explosion protection through the type of protection "intrinsic safety" (Ex i) according to IEC 60079-11. For this reason, only appropriately certified, intrinsically safe devices may be connected to the EPX EtherCAT Box Modules. Observe the maximum permissible connection values for voltages, currents and reactances. Any infringement can damage the EPX EtherCAT Box Modules and thus eliminate the explosion protection.

CAUTION

Ensure traceability!

The buyer has to ensure the traceability of the device via the Beckhoff Traceability Number (BTN).

3 Mounting and connection

3.1 Special conditions for EPX EtherCAT Box modules

⚠ WARNING

Observe the special conditions for the intended use of Beckhoff EPX EtherCAT Box modules in hazardous areas (ATEX Directive 2014/34/EU)!

- The connection points are to be protected by a modification in such a way that a protection against mechanical danger is guaranteed!
- If the temperatures during nominal operation are higher than 70 °C at the feed-in points of cables, lines or pipes, or higher than 80 °C at the wire branching points, then cables must be selected whose temperature data correspond to the actual measured temperature values!
- When using EPX EtherCAT Box modules in hazardous areas, observe the permissible ambient temperature range of -25 to +70 °C!
- Measures must be taken to protect against the nominal operating voltage being exceeded by more than 40% due to short-term interference voltages! The power supply of the EPX EtherCAT Box must comply with overvoltage category II according to EN 60664-1.
- SELV/PELV circuits (Safety Extra Low Voltage, Protective Extra Low Voltage) with a maximum error voltage of 60 V_{DC} must be used to supply the EPX EtherCAT Box modules!
- The power and EtherCAT connectors of the certified components may only be connected or disconnected when the supply voltage has been switched off or when a non-explosive atmosphere is ensured!
- The EPX EtherCAT Box modules must be protected from direct sunlight.

3.2 Installation notes for EPX EtherCAT Box Modules

NOTE

Storage, transport and mounting

- Transport and storage are permitted only in the original packaging!
- Store in a dry place, free from vibrations.
- A brand new EPX EtherCAT Box with a certified build version is delivered only in a sealed carton. Therefore, check that the carton and all seals are intact before unpacking.
- Do not use the EPX EtherCAT Box if
 - its packaging is damaged
 - the terminal is visibly damaged or
 - you cannot be sure of the origin of the terminal.
- EPX EtherCAT Box Modules with a damaged packaging seal are regarded as used.

⚠ WARNING

Observe the accident prevention regulations

During mounting, commissioning, operation and maintenance, adhere to the safety regulations, accident prevention regulations and general technical rules applicable to your devices, machines and plants.

⚠ CAUTION

Observe the erection regulations

Observe the applicable erection regulations.

NOTE

Handling

- The opening of the housing, the removal of parts and any mechanical deformation or machining of an EPX EtherCAT Box are not permitted!

If an EPX EtherCAT Box is defective or damaged it must be replaced by an equivalent terminal. Do not carry out any repairs to the devices. For safety reasons repairs may only be carried out by the manufacturer.

NOTE**Contact labeling and pin assignment**

The colored labels above the front connection contacts shown in the illustrations of the introductory chapter are only exemplary and not part of the scope of delivery!

A clear assignment of channel and connection designation according to the chapter [Connection \[► 18\]](#) to the actual connection contact can be made via the designations on the respective connector as well as via the [name plate \[► 9\]](#).

Observe the polarity dependency of connected intrinsically safe circuits, if applicable!

⚠ WARNING**Observe the minimum distances according to IEC 60079-14!**

Also observe the specified minimum distances between intrinsically safe and non-intrinsically safe circuits according to IEC 60079-14!

3.3 Mounting

⚠ WARNING

Risk of injury through electric shock and damage to the device!

Bring the system in a safe, de-energized state before you start mounting, dismantling or wiring the EPX EtherCAT Box modules!

3.3.1 Dimensions

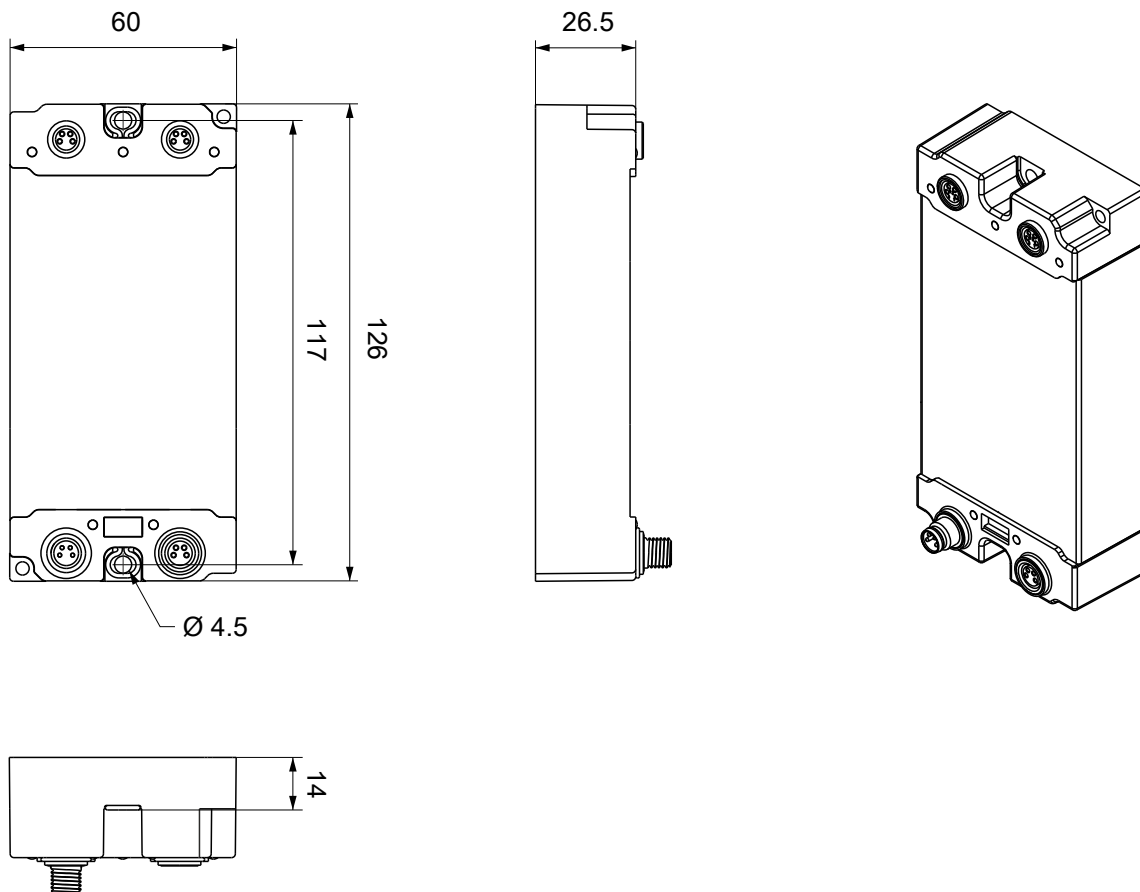

Fig. 3: EPX EtherCAT Box - Dimensions

All dimensions are given in millimeters.
The drawing is not true to scale.

Housing features

Housing material	PA6 (polyamide)
Sealing compound	Polyurethane
Mounting	two mounting holes Ø 4.5 mm for M4
Metal parts	brass, nickel-plated
Contacts	CuZn, gold-plated
Installation position	variable
Protection rating	IP65, IP66, IP67 (conforms to EN 60529) when screwed together
Dimensions (H x W x D)	approx. 126 x 60 x 26.5 mm (without connectors)

3.3.2 Mounting

NOTE

Protect connections against dirt!

Protect all connections from contamination during module installation! Protection rating IP67 can only be guaranteed if all cables and connectors are connected!

- Protect the connectors against dirt during the assembly.

Mount the module with two M4 screws in the centrally located mounting holes.

Note when mounting that the overall height is increased further by the fieldbus connections. See chapter Accessories.

Mounting Rail ZS5300-0011

The mounting rail ZS5300-0011 (500 mm x 129 mm) has in addition to the M3 threads also pre-made M4 threads to fix 60 mm wide modules via their middle holes.

Up to 14 narrow or 7 wide modules may be mixed mounted.

3.3.3 Functional earth (FE)

EPX EtherCAT Box modules must be grounded.

The Fixing also serve as connections for the functional earth (FE).

Make sure that the box is earthed with low impedance via both fastening screws. You can achieve this, for example, by mounting the box on a grounded machine bed.

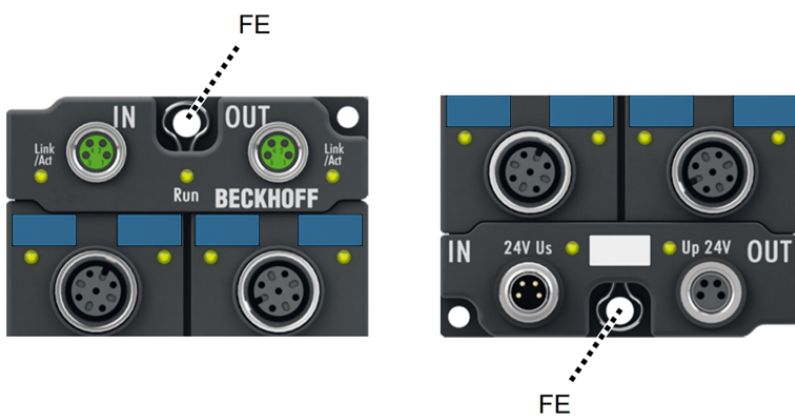

Fig. 4: EPX EtherCAT Box - Functional earth via the fastening holes

3.3.4 Disposal



Products marked with a crossed-out wheeled bin shall not be discarded with the normal waste stream. The device is considered as waste electrical and electronic equipment. The national regulations for the disposal of waste electrical and electronic equipment must be observed.

3.4 Connection

⚠ WARNING

Risk of injury through electric shock and damage to the device!

Bring the system in a safe, de-energized state before you start mounting, dismantling or wiring the EPX EtherCAT Box modules!

3.4.1 Connector

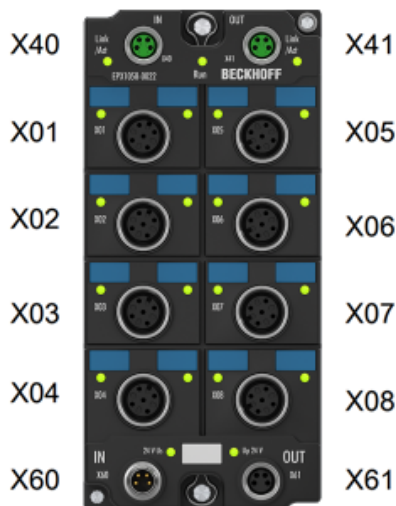

Fig. 5: Connectors using EPX1058-0022 as an example

Name	Function	Connector type	Tightening torque*
X01	Signal inputs	M12 socket	0.6 Nm
X02			
X03			
X04			
X05			
X06			
X07			
X08			
X40	EtherCAT: input	M8 socket	0.4 Nm
X41	EtherCAT: downstream connection		
X60	Supply voltage: input	M8 connector	0.4 Nm
X61	Supply voltage: downstream connection	M8 socket	

⚠ WARNING

Use torque wrench!

The specified tightening torque must be observed in order to be allowed to use the product in the hazardous area!

- Mount plugs and protective caps on these connectors with a torque wrench; e.g. Beckhoff ZB8801.
- Ensure the correct seating and tightening torque of pre-assembled protective caps. Protective caps are pre-assembled at the factory to protect connectors during transport. They may not be tightened enough to meet the conditions for hazardous area and protection rating IP67.
- Also seal unused connectors with protective caps!

3.4.2 EtherCAT

3.4.2.1 EtherCAT - connector

NOTE
<p>Danger of confusion: EtherCAT and supply voltages</p> <p>Defect possible due to mismatching of M8 connectors!</p> <ul style="list-style-type: none"> • green: EtherCAT • black: supply voltages

EtherCAT Box Modules have two green M8 sockets for the incoming and downstream EtherCAT connections.



Fig. 6: EtherCAT connector

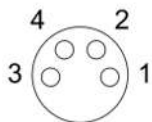

Fig. 7: EtherCAT connector - pin assignment

EtherCAT	M8 connector	Core colors		
Signal	Contact	ZB9010, ZB9020, ZB9030, ZB9032, ZK1090-6292, ZK1090-3xxx-xxxx	ZB9031 and old versions of ZB9030, ZB9032, ZK1090-3xxx-xxxx	TIA-568B
Tx+	1	yellow*	white/orange	white/orange
Tx-	4	orange*	orange	orange
Rx+	2	white*	white/blue	white/green
Rx-	3	blue*	blue	green
Shield	Housing	Shield	Shield	Shield

*) Core colors according to EN 61918

i Adaptation of core colors for cables ZB9030, ZB9032, ZK1090-3xxxx-xxxx

For standardization, the core colors of the ZB9030, ZB9032 and ZK1090-3xxx-xxxx cables have been changed to the EN 61918 core colors: yellow, orange, white, blue. So there are different color codes in circulation. The electrical properties of the cables have been retained when the core colors were changed

3.4.2.2 EtherCAT - status LEDs



Fig. 8: EtherCAT - status LEDs

Link/Act (L/A)

A green LED labelled **Link/Act** is located next to each EtherCAT socket. The LED indicates the communication state of the respective socket.

LED Link/Act	Meaning
off	no connection to the connected EtherCAT device
lit	LINK: connection to the connected EtherCAT device
flashes	ACT: communication with the connected EtherCAT device

Run

Each EtherCAT device has a green LED labeled **Run**. The LED signals the status of the device in the EtherCAT network.

LED Run	Meaning
off	Device is in "Init" state
flashes uniformly	Device is in "Pre-Operational" state
flashes sporadically	Device is in "Safe-Operational" state
lit	Device is in "Operational" state

NOTE



EtherCAT system documentation

For further information on EtherCAT states etc. please refer to the [EtherCAT system documentation](#), which is also available from the Beckhoff homepage on the [product page](#) of your EtherCAT device under *Documentation and Downloads / Technical Documentation*.

3.4.2.3 EtherCAT - cables

For the connection of EtherCAT devices use shielded Ethernet cables which at least comply with category 5 (CAT5) according to EN 50173 or ISO/IEC 11801.

EtherCAT uses four wires for signal transmission. Thanks to automatic line detection ("Auto MDI-X"), both symmetrical (1:1) or cross-over cables can be used between Beckhoff EtherCAT devices.

NOTE



Infrastructure for EtherCAT/Ethernet Technical recommendations and notes for design, implementation and testing

For further information on EtherCAT cables etc. please refer to the documentation [Infrastructure for EtherCAT/Ethernet](#), which is also available from the Beckhoff homepage on the [product page](#) of your EtherCAT device under *Documentation and Downloads / Technical Documentation*.

3.4.3 Power supply

3.4.3.1 Power supply - connector

NOTE
<p>Danger of confusion: EtherCAT and supply voltages</p> <p>Defect possible due to mismatching of M8 connectors!</p> <ul style="list-style-type: none"> • green: EtherCAT • black: supply voltages

The EtherCAT Box is supplied with two supply voltages. The ground potentials of the supply voltages are electrically isolated.

- Control voltage U_s
- Peripheral voltage U_p



Fig. 9: Power supply connector - input (left), downstream connection (right)



Fig. 10: Connector of the power supply - pin assignment

Contact	Function	Description	Core color*
1	U_s	Control voltage	brown
2	U_p	Peripheral voltage	white
3	GND_s	GND to U_s	blue
4	GND_p	GND to U_p	black

*) The core colors apply to cables of type: Beckhoff ZK2020-3xxx-xxxx

3.4.3.2 Power supply - status LEDs



Fig. 11: Status LEDs for the supply voltages

LED	Display	Meaning
U _s (control voltage)	off	Supply voltage U _s is not present
	green illuminated	Supply voltage U _s is present
U _p (peripheral voltage)	off	Supply voltage U _p is not present
	green illuminated	Supply voltage U _p is present

3.4.3.3 Conductor losses

Take into account the voltage drop on the supply line when planning a system. Avoid the voltage drop being so high that the supply voltages at the box lies below the minimum nominal voltage.

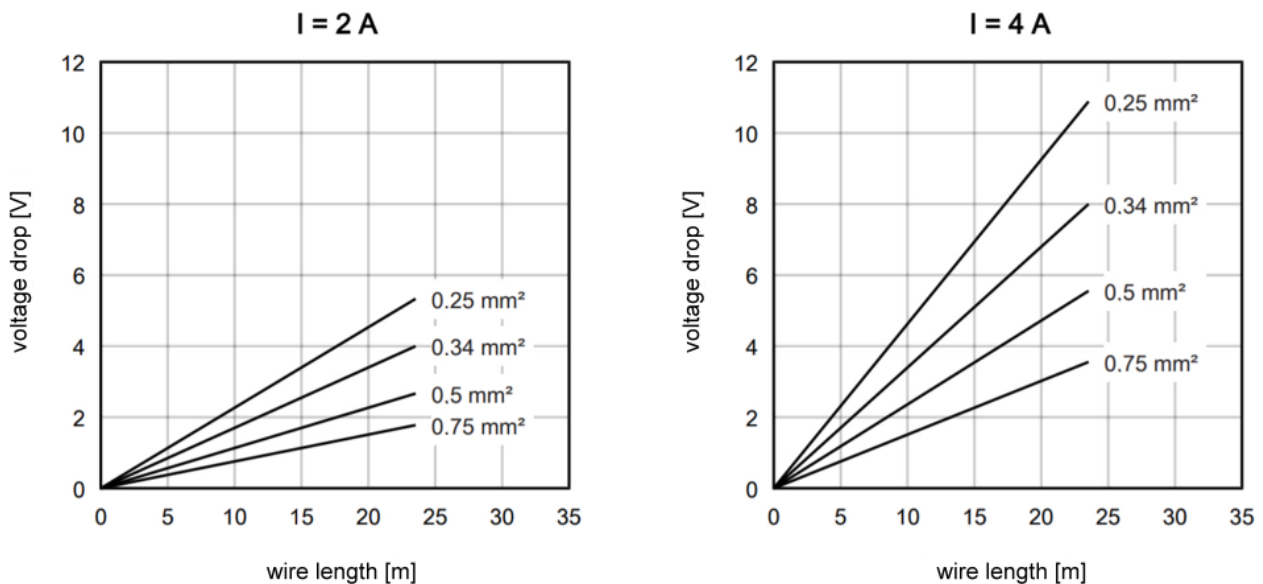

Fig. 12: Voltage drop on the supply line

Voltage fluctuations of the power supply unit must also be taken into account.

3.4.4 Signal inputs

3.4.4.1 Signal inputs - connectors

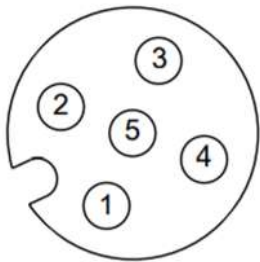

Fig. 13: M12 connector of the inputs - pin assignment

Contact (pin)	Symbol	Description
1	U_{Vn^*}	Sensor power supply for channel n^*
2	-	reserved
3	-	reserved
4	Input n^*	Input channel n^*
5	-	reserved

*) n applies to channel 1 ... 8

⚠ WARNING

The reserved contacts (pins) of the connections must not be connected or grounded!

- Do not connect any signals, voltages or ground potential to the reserved contacts!
- Pre-assembled connection cables that have the cable shield connected to pin 5 must not be used with the EtherCAT EPX Box modules!

3.4.4.2 Operation modes and LED displays

The EtherCAT Box EPX1058-0022 has four operation modes which can be selected channel by channel in the CoE via the object *Input Type* (Index 0x80nD:11). In addition, individual channels can be switched off (Channel disabled).

Index 80nD DI Settings (for $0 \leq n \leq 7$)

Index (hex)	Name	Meaning	Data type	Flags	Default
80nD:11	Input Type	Maximum subindex	UINT8	RW	0x11 (17 _{dec})
80nD:11	Input Type	0x00: Channel disabled 0x0A: Dry Contact NO (normally open) 0x0B: Dry Contact NC (normally closed) 0x14: NAMUR NO (normally open) 0x15: NAMUR NC (normally closed)	INT16	RW	0x14 (20 _{dec})

The EPX1058-0022 EtherCAT Box has a combination LED for each channel, consisting of a green input LED and a red error LED. If both LEDs are on, the result is an orange hue - in this case, both the Input and Error LEDs are to be understood as "on". The following tables are for the respective LED number of a channel.



Fig. 14: EPX1058 - signal LEDs

Operation mode NAMUR NO (normally open, default)

Input	Error	Meaning
off	on	Error detection: open circuit on channel ($I < 200 \mu\text{A}$ typ.)
off	off	Normal operation: NAMUR sensor on channel in blocking state ("0"; according to IEC 609497-5-6)
on	on	Error detection: short circuit on channel ($I > 6.3 \text{ mA}$ typ.)
on	off	Normal operation: NAMUR sensor on channel in conductive state ("1"; according to IEC 609497-5-6)

Operation mode NAMUR NC (normally closed)

Input	Error	Meaning
off	on	Error detection: short circuit on channel ($I > 6.3 \text{ mA}$ typ.)
off	off	Normal operation: NAMUR sensor on channel in conductive state ("1"; according to IEC 609497-5-6)
on	on	Error detection: open circuit on channel ($I < 200 \mu\text{A}$ typ.)
on	off	Normal operation: NAMUR sensor on channel in blocking state ("0"; according to IEC 609497-5-6)

i **No wire break and short-circuit detection for Dry Contact NO and Dry Contact NC**

In the following operation modes *Dry Contact NO* and *Dry Contact NC* the wire break and short-circuit detection is switched off, so that error bits and error LEDs are always "off"

Operation mode Dry Contact NO (normally open)

Input	Error	Meaning
off	off	Sensor on channel in blocking state
on	off	Sensor on channel in conductive state

Operation mode Dry Contact NC (normally closed)

Input	Error	Meaning
off	off	Sensor on channel in conductive state
on	off	Sensor on channel in blocking state

3.4.5 Shielding and potential separation

i **Shielding**

Encoder, analog sensors and actors should always be connected with shielded, twisted paired wires!

⚠ CAUTION**Observe installation requirements in areas of potentially explosive atmospheres!**

During installation, observe the requirements for cables, shielding and earth potential equalization in areas of potentially explosive atmospheres according to IEC 60079-11, IEC 60079-14 and IEC 60079-25!

4 Appendix

4.1 EtherCAT AL Status Codes

For detailed information please refer to the [EtherCAT system description](#).

4.2 UL notice

● Application

i The modules are intended for use with Beckhoff's UL Listed EtherCAT System only.

● Examination

i For cULus examination, the Beckhoff I/O System has only been investigated for risk of fire and electrical shock (in accordance with UL508 and CSA C22.2 No. 142).

● For devices with Ethernet connectors

i Not for connection to telecommunication circuits.

Basic principles

Two UL certificates are met in the Beckhoff EtherCAT product range, depending upon the components:

1. UL certification according to UL508. Devices with this kind of certification are marked by this sign:



2. UL certification according to UL508 with limited power consumption. The current consumed by the device is limited to a max. possible current consumption of 4 A. Devices with this kind of certification are marked by this sign:

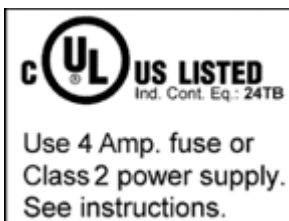

Almost all current EtherCAT products (as at 2010/05) are UL certified without restrictions.

Application

If terminals certified *with restrictions* are used, then the current consumption at 24 V_{DC} must be limited accordingly by means of supply

- from an isolated source protected by a fuse of max. 4 A (according to UL248) or
- from a voltage supply complying with *NEC class 2*.
A voltage source complying with *NEC class 2* may not be connected in series or parallel with another *NEC class 2*compliant voltage supply!

These requirements apply to the supply of all EtherCAT bus couplers, power adaptor terminals, Bus Terminals and their power contacts.

4.3 Support and Service

Beckhoff and their partners around the world offer comprehensive support and service, making available fast and competent assistance with all questions related to Beckhoff products and system solutions.

Beckhoff's branch offices and representatives

Please contact your Beckhoff branch office or representative for local support and service on Beckhoff products!

The addresses of Beckhoff's branch offices and representatives round the world can be found on her internet pages: <https://www.beckhoff.com>

You will also find further documentation for Beckhoff components there.

Beckhoff Support

Support offers you comprehensive technical assistance, helping you not only with the application of individual Beckhoff products, but also with other, wide-ranging services:

- support
- design, programming and commissioning of complex automation systems
- and extensive training program for Beckhoff system components

Hotline: +49 5246 963 157
Fax: +49 5246 963 9157
e-mail: support@beckhoff.com

Beckhoff Service

The Beckhoff Service Center supports you in all matters of after-sales service:

- on-site service
- repair service
- spare parts service
- hotline service

Hotline: +49 5246 963 460
Fax: +49 5246 963 479
e-mail: service@beckhoff.com

Beckhoff Headquarters

Beckhoff Automation GmbH & Co. KG

Huelshorstweg 20
33415 Verl
Germany

Phone: +49 5246 963 0
Fax: +49 5246 963 198
e-mail: info@beckhoff.com
web: <https://www.beckhoff.com>

Table of figures

Fig. 1	Side name plate of EPX1058-0022, EPX3158-0022 and EPX3184-0022	9
Fig. 2	EPX1058-0022 - 8-channel digital EtherCAT Box for NAMUR sensors, Ex i	10
Fig. 3	EPX EtherCAT Box - Dimensions	16
Fig. 4	EPX EtherCAT Box - Functional earth via the fastening holes	17
Fig. 5	Connectors using EPX1058-0022 as an example	18
Fig. 6	EtherCAT connector.....	19
Fig. 7	EtherCAT connector - pin assignment	19
Fig. 8	EtherCAT - status LEDs.....	20
Fig. 9	Power supply connector - input (left), downstream connection (right)	21
Fig. 10	Connector of the power supply - pin assignment	21
Fig. 11	Status LEDs for the supply voltages	22
Fig. 12	Voltage drop on the supply line.....	22
Fig. 13	M12 connector of the inputs - pin assignment	23
Fig. 14	EPX1058 - signal LEDs.....	24

More Information:
www.beckhoff.com/EPX1058-0022

Beckhoff Automation GmbH & Co. KG
Hülshorstweg 20
33415 Verl
Germany
Phone: +49 5246 9630
info@beckhoff.com
www.beckhoff.com

