

BECKHOFF New Automation Technology

Documentation | EN

EL95xx

Power Supply Terminals



EtherCAT®

1 Product overview – EtherCAT power supply terminals

[EL9505](#) [[▶](#) [14](#)] (power supply terminal, 5 V_{DC}, 0.5 A)

[EL9508](#) [[▶](#) [14](#)] (power supply terminal, 8 V_{DC}, 0.5 A)

[EL9510](#) [[▶](#) [14](#)] (power supply terminal, 10 V_{DC}, 0.5 A)

[EL9512](#) [[▶](#) [14](#)] (power supply terminal, 12 V_{DC}, 0.5 A)

[EL9515](#) [[▶](#) [14](#)] (power supply terminal, 15 V_{DC}, 0.5 A)

[EL9560](#) [[▶](#) [14](#)] (power supply terminal, 24 V / 24 V_{DC}, 0.1 A)

Table of contents

1	Product overview – EtherCAT power supply terminals	3
2	Foreword	5
2.1	Notes on the documentation	5
2.2	Safety instructions	6
2.3	Documentation issue status	7
2.4	Version identification of EtherCAT devices	8
2.4.1	General notes on marking	8
2.4.2	Version identification of EL terminals	9
2.4.3	Beckhoff Identification Code (BIC)	10
2.4.4	Electronic access to the BIC (eBIC)	12
3	Product description	14
3.1	Introduction	14
3.2	EL9505, EL9508, EL9510, EL9512, EL9515 - Technical data	15
3.3	EL9560 - Technical data	16
4	Basics communication	17
4.1	EtherCAT basics	17
4.2	EtherCAT cabling – wire-bound	18
4.3	EtherCAT State Machine	20
4.4	CoE Interface	22
5	Mounting and wiring	27
5.1	Instructions for ESD protection	27
5.2	Explosion protection	28
5.2.1	ATEX - Special conditions (standard temperature range)	28
5.2.2	Continuative documentation for ATEX and IECEx	29
5.3	UL notice	30
5.4	Installation on mounting rails	31
5.5	Positioning of passive Terminals	34
5.6	Installation instructions for enhanced mechanical load capacity	35
5.7	Connection	36
5.7.1	Connection system	36
5.7.2	Wiring	38
5.7.3	Shielding	39
5.8	Note - Power supply	40
5.9	ATEX - Special conditions (standard temperature range)	41
5.10	Continuative documentation for ATEX and IECEx	42
5.11	Pin assignment	43
6	Commissioning	44
6.1	Inserting the terminal in the EtherCAT terminal network	44
6.2	Process data	48
7	Appendix	49
7.1	Firmware compatibility	49
7.2	Support and Service	50

2 Foreword

2.1 Notes on the documentation

Intended audience

This description is only intended for the use of trained specialists in control and automation engineering who are familiar with the applicable national standards.

It is essential that the documentation and the following notes and explanations are followed when installing and commissioning these components.

It is the duty of the technical personnel to use the documentation published at the respective time of each installation and commissioning.

The responsible staff must ensure that the application or use of the products described satisfy all the requirements for safety, including all the relevant laws, regulations, guidelines and standards.

Disclaimer

The documentation has been prepared with care. The products described are, however, constantly under development.

We reserve the right to revise and change the documentation at any time and without prior announcement.

No claims for the modification of products that have already been supplied may be made on the basis of the data, diagrams and descriptions in this documentation.

Trademarks

Beckhoff®, TwinCAT®, TwinCAT/BSD®, TC/BSD®, EtherCAT®, EtherCAT G®, EtherCAT G10®, EtherCAT P®, Safety over EtherCAT®, TwinSAFE®, XFC®, XTS® and XPlanar® are registered trademarks of and licensed by Beckhoff Automation GmbH. Other designations used in this publication may be trademarks whose use by third parties for their own purposes could violate the rights of the owners.

Patent Pending

The EtherCAT Technology is covered, including but not limited to the following patent applications and patents: EP1590927, EP1789857, EP1456722, EP2137893, DE102015105702 with corresponding applications or registrations in various other countries.

The logo for EtherCAT, featuring the word "EtherCAT" in a bold, black, sans-serif font. A red arrow points from the top of the "A" towards the right, ending above the "T". A registered trademark symbol (®) is located to the right of the "T".

EtherCAT® is registered trademark and patented technology, licensed by Beckhoff Automation GmbH, Germany.

Copyright

© Beckhoff Automation GmbH & Co. KG, Germany.

The reproduction, distribution and utilization of this document as well as the communication of its contents to others without express authorization are prohibited.

Offenders will be held liable for the payment of damages. All rights reserved in the event of the grant of a patent, utility model or design.

2.2 Safety instructions

Safety regulations

Please note the following safety instructions and explanations!
Product-specific safety instructions can be found on following pages or in the areas mounting, wiring, commissioning etc.

Exclusion of liability

All the components are supplied in particular hardware and software configurations appropriate for the application. Modifications to hardware or software configurations other than those described in the documentation are not permitted, and nullify the liability of Beckhoff Automation GmbH & Co. KG.

Personnel qualification

This description is only intended for trained specialists in control, automation and drive engineering who are familiar with the applicable national standards.

Description of instructions

In this documentation the following instructions are used.
These instructions must be read carefully and followed without fail!

DANGER

Serious risk of injury!

Failure to follow this safety instruction directly endangers the life and health of persons.

WARNING

Risk of injury!

Failure to follow this safety instruction endangers the life and health of persons.

CAUTION

Personal injuries!

Failure to follow this safety instruction can lead to injuries to persons.

NOTE

Damage to environment/equipment or data loss

Failure to follow this instruction can lead to environmental damage, equipment damage or data loss.



Tip or pointer

This symbol indicates information that contributes to better understanding.

2.3 Documentation issue status

Version	Comment
2.3	<ul style="list-style-type: none">• Update chapter "Technical data"• Update structure
2.2	<ul style="list-style-type: none">• Update chapter "Technical data"• Update structure
2.1	<ul style="list-style-type: none">• Update chapter "Notes on the documentation"• Update chapter "Technical data"• Addenda chapter "Instructions for ESD protection"• Addenda chapter "Installation instructions for enhanced mechanical load capacity"• Chapter "ATEX - Special conditions" replaced with chapter "ATEX - Special conditions (standard temperature range)"
2.0	<ul style="list-style-type: none">• Migration• Update structure
1.4	<ul style="list-style-type: none">• Update "Technical data"
1.3	<ul style="list-style-type: none">• Update "Technical data", connection diagram
1.2	<ul style="list-style-type: none">• Note regarding firmware compatibility inserted
1.1	<ul style="list-style-type: none">• EL9560 added
1.0	<ul style="list-style-type: none">• First published
0.2	<ul style="list-style-type: none">• Corrections and addenda
0.1	<ul style="list-style-type: none">• Provisional documentation for EL95xx

2.4 Version identification of EtherCAT devices

2.4.1 General notes on marking

Designation

A Beckhoff EtherCAT device has a 14-digit designation, made up of

- family key
- type
- version
- revision

Example	Family	Type	Version	Revision
EL3314-0000-0016	EL terminal (12 mm, non-pluggable connection level)	3314 (4-channel thermocouple terminal)	0000 (basic type)	0016
ES3602-0010-0017	ES terminal (12 mm, pluggable connection level)	3602 (2-channel voltage measurement)	0010 (high-precision version)	0017
CU2008-0000-0000	CU device	2008 (8-port fast ethernet switch)	0000 (basic type)	0000

Notes

- The elements mentioned above result in the **technical designation**. EL3314-0000-0016 is used in the example below.
- EL3314-0000 is the order identifier, in the case of “-0000” usually abbreviated to EL3314. “-0016” is the EtherCAT revision.
- The **order identifier** is made up of
 - family key (EL, EP, CU, ES, KL, CX, etc.)
 - type (3314)
 - version (-0000)
- The **revision** -0016 shows the technical progress, such as the extension of features with regard to the EtherCAT communication, and is managed by Beckhoff.
In principle, a device with a higher revision can replace a device with a lower revision, unless specified otherwise, e.g. in the documentation.
Associated and synonymous with each revision there is usually a description (ESI, EtherCAT Slave Information) in the form of an XML file, which is available for download from the Beckhoff web site.
From 2014/01 the revision is shown on the outside of the IP20 terminals, see Fig. “EL5021 EL terminal, standard IP20 IO device with batch number and revision ID (since 2014/01)”.
- The type, version and revision are read as decimal numbers, even if they are technically saved in hexadecimal.

2.4.2 Version identification of EL terminals

The serial number/ data code for Beckhoff IO devices is usually the 8-digit number printed on the device or on a sticker. The serial number indicates the configuration in delivery state and therefore refers to a whole production batch, without distinguishing the individual modules of a batch.

Structure of the serial number: **KK YY FF HH**

KK - week of production (CW, calendar week)

YY - year of production

FF - firmware version

HH - hardware version

Example with serial number 12 06 3A 02:

12 - production week 12

06 - production year 2006

3A - firmware version 3A

02 - hardware version 02



Fig. 1: EL2872 with revision 0022 and serial number 01200815

2.4.3 Beckhoff Identification Code (BIC)

The Beckhoff Identification Code (BIC) is increasingly being applied to Beckhoff products to uniquely identify the product. The BIC is represented as a Data Matrix Code (DMC, code scheme ECC200), the content is based on the ANSI standard MH10.8.2-2016.

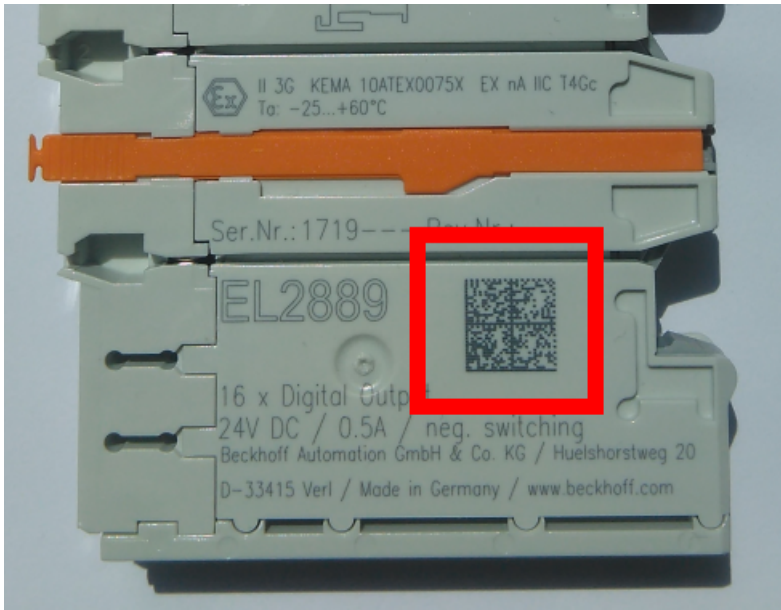

Fig. 2: BIC as data matrix code (DMC, code scheme ECC200)

The BIC will be introduced step by step across all product groups.

Depending on the product, it can be found in the following places:

- on the packaging unit
- directly on the product (if space suffices)
- on the packaging unit and the product

The BIC is machine-readable and contains information that can also be used by the customer for handling and product management.

Each piece of information can be uniquely identified using the so-called data identifier (ANSI MH10.8.2-2016). The data identifier is followed by a character string. Both together have a maximum length according to the table below. If the information is shorter, spaces are added to it.

Following information is possible, positions 1 to 4 are always present, the other according to need of production:

Position	Type of information	Explanation	Data identifier	Number of digits incl. data identifier	Example
1	Beckhoff order number	Beckhoff order number	1P	8	1P 072222
2	Beckhoff Traceability Number (BTN)	Unique serial number, see note below	SBTN	12	SBTN k4p562d7
3	Article description	Beckhoff article description, e.g. EL1008	1K	32	1K EL1809
4	Quantity	Quantity in packaging unit, e.g. 1, 10, etc.	Q	6	Q 1
5	Batch number	Optional: Year and week of production	2P	14	2P 401503180016
6	ID/serial number	Optional: Present-day serial number system, e.g. with safety products	51S	12	51S 678294
7	Variant number	Optional: Product variant number on the basis of standard products	30P	32	30P F971, 2*K183
...					

Further types of information and data identifiers are used by Beckhoff and serve internal processes.

Structure of the BIC

Example of composite information from positions 1 to 4 and with the above given example value on position 6. The data identifiers are highlighted in bold font:

1P072222**SBTN**k4p562d7**1K**EL1809 **Q**1 **51S**678294

Accordingly as DMC:



Fig. 3: Example DMC **1P**072222**SBTN**k4p562d7**1K**EL1809 **Q**1 **51S**678294

BTN

An important component of the BIC is the Beckhoff Traceability Number (BTN, position 2). The BTN is a unique serial number consisting of eight characters that will replace all other serial number systems at Beckhoff in the long term (e.g. batch designations on IO components, previous serial number range for safety products, etc.). The BTN will also be introduced step by step, so it may happen that the BTN is not yet coded in the BIC.

NOTE

This information has been carefully prepared. However, the procedure described is constantly being further developed. We reserve the right to revise and change procedures and documentation at any time and without prior notice. No claims for changes can be made from the information, illustrations and descriptions in this information.

2.4.4 Electronic access to the BIC (eBIC)

Electronic BIC (eBIC)

The Beckhoff Identification Code (BIC) is applied to the outside of Beckhoff products in a visible place. If possible, it should also be electronically readable.

Decisive for the electronic readout is the interface via which the product can be electronically addressed.

K-bus devices (IP20, IP67)

Currently, no electronic storage and readout is planned for these devices.

EtherCAT devices (IP20, IP67)

All Beckhoff EtherCAT devices have a so-called ESI-EEPROM, which contains the EtherCAT identity with the revision number. Stored in it is the EtherCAT slave information, also colloquially known as ESI/XML configuration file for the EtherCAT master. See the corresponding chapter in the EtherCAT system manual ([Link](#)) for the relationships.

The eBIC is also stored in the ESI-EEPROM. The eBIC was introduced into the Beckhoff I/O production (terminals, boxes) from 2020; widespread implementation is expected in 2021.

The user can electronically access the eBIC (if existent) as follows:

- With all EtherCAT devices, the EtherCAT master (TwinCAT) can read the eBIC from the ESI-EEPROM
 - From TwinCAT 3.1 build 4024.11, the eBIC can be displayed in the online view.
 - To do this, check the checkbox "Show Beckhoff Identification Code (BIC)" under EtherCAT → Advanced Settings → Diagnostics:

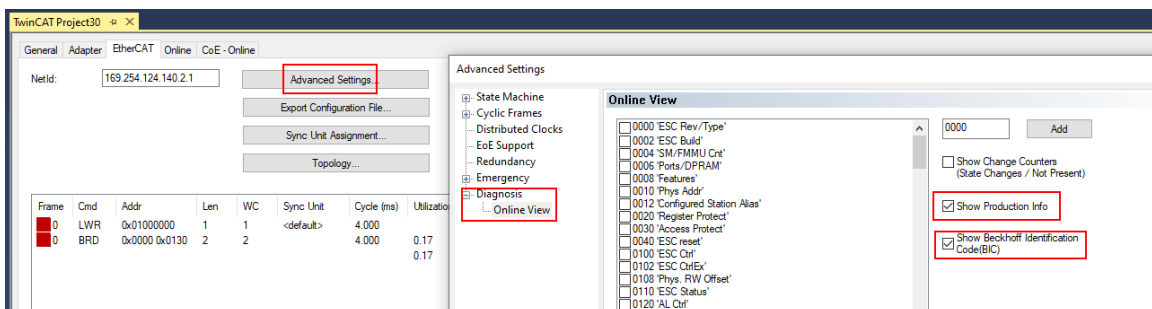

- The BTN and its contents are then displayed:

No	Addr	Name	State	CRC	Fw	Hw	Production Data	ItemNo	BTN	Description	Quantity	BatchNo	SerialNo
1	1001	Term 1 (EK1100)	OP	0,0	0	0	---						
2	1002	Term 2 (EL1018)	OP	0,0	0	0	2020 KW36 Fr	072222	k4p562d7	EL1809	1		678294
3	1003	Term 3 (EL3204)	OP	0,0	7	6	2012 KW24 Sa						
4	1004	Term 4 (EL2004)	OP	0,0	0	0	---	072223	k4p562d7	EL2004	1		678295
5	1005	Term 5 (EL1008)	OP	0,0	0	0	---						
6	1006	Term 6 (EL2008)	OP	0,0	0	12	2014 KW14 Mo						
7	1007	Term 7 (EK1110)	OP	0	1	8	2012 KW25 Mo						

- Note: as can be seen in the illustration, the production data HW version, FW version and production date, which have been programmed since 2012, can also be displayed with "Show Production Info".
- From TwinCAT 3.1. build 4024.24 the functions *FB_EcReadBIC* and *FB_EcReadBTN* for reading into the PLC and further eBIC auxiliary functions are available in the Tc2_EtherCAT Library from v3.3.19.0.
- In the case of EtherCAT devices with CoE directory, the object 0x10E2:01 can additionally be used to display the device's own eBIC; the PLC can also simply access the information here:

- The device must be in SAFEOP/OP for access:

Index	Name	Flags	Value
1000	Device type	RO	0x015E1389 (22942601)
1008	Device name	RO	ELM3704-0000
1009	Hardware version	RO	00
100A	Software version	RO	01
100B	Bootloader version	RO	J0.1.27.0
1011:0	Restore default parameters	RO	> 1 <
1018:0	Identity	RO	> 4 <
10E2:0	Manufacturer-specific Identification C...	RO	> 1 <
10E2:01	SubIndex 001	RO	1P158442SBTN0008jekp1KELM3704 Q1 2P482001000016
10F0:0	Backup parameter handling	RO	> 1 <
10F3:0	Diagnosis History	RO	> 21 <
10F8	Actual Time Stamp	RO	0x170bfb277e

- the object 0x10E2 will be introduced into stock products in the course of a necessary firmware revision.
- From TwinCAT 3.1. build 4024.24 the functions *FB_EcCoEReadBIC* and *FB_EcCoEReadBTN* for reading into the PLC and further eBIC auxiliary functions are available in the *Tc2_EtherCAT Library* from v3.3.19.0.
- Note: in the case of electronic further processing, the BTN is to be handled as a string(8); the identifier "SBTN" is not part of the BTN.
- Technical background
The new BIC information is additionally written as a category in the ESI-EEPROM during the device production. The structure of the ESI content is largely dictated by the ETG specifications, therefore the additional vendor-specific content is stored with the help of a category according to ETG.2010. ID 03 indicates to all EtherCAT masters that they must not overwrite these data in case of an update or restore the data after an ESI update.
The structure follows the content of the BIC, see there. This results in a memory requirement of approx. 50..200 bytes in the EEPROM.
- Special cases
 - If multiple, hierarchically arranged ESCs are installed in a device, only the top-level ESC carries the eBIC Information.
 - If multiple, non-hierarchically arranged ESCs are installed in a device, all ESCs carry the eBIC Information.
 - If the device consists of several sub-devices with their own identity, but only the top-level device is accessible via EtherCAT, the eBIC of the top-level device is located in the CoE object directory 0x10E2:01 and the eBICs of the sub-devices follow in 0x10E2:nn.

Profibus/Profinet/DeviceNet... Devices

Currently, no electronic storage and readout is planned for these devices.

3 Product description

3.1 Introduction

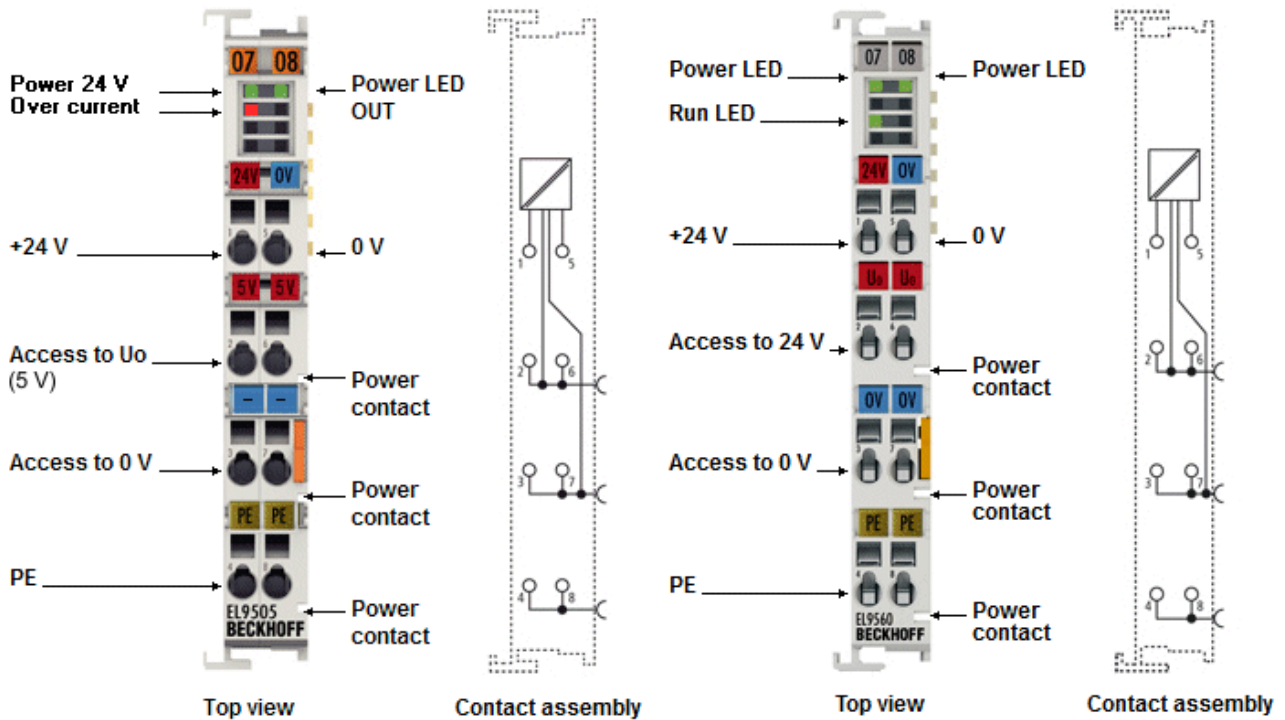

Fig. 4: Left: EL9505 (identical pin assignment: EL9508, EL9510, EL9512, EL9515) Right: EL9560

Based on the input voltage ($24 V_{DC}$), the EL9505, EL9508, EL9510, EL9512 and EL9515 power supply terminals generate different output voltages, which can be picked up at the terminals. The following EtherCAT Terminals are also supplied with this voltage via the power contacts. The power LEDs indicate the operating states of the terminals, short-circuits or overloads are indicated by the overcurrent LEDs. The input voltage and the output voltage U_o are not electrically isolated.

The EL9560 power supply unit terminal generates an electrically isolated output voltage from the $24 V_{DC}$ input voltage. The input voltage and the output voltage of 500 V are also electrically isolated.

3.2 EL9505, EL9508, EL9510, EL9512, EL9515 - Technical data

Technical data	EL9505	EL9508	EL9510	EL9512	EL9515
Input voltage	24 V _{DC}				
Output voltage	5 V _{DC} ±1%	8 V _{DC} ±1%	10 V _{DC} ±1%	12 V _{DC} ±1%	15 V _{DC} ±1%
Output current	0.5 A				
Short circuit diagnosis, overload:	Overcurrent LED				
Short circuit proof	yes				
Message to E-bus	yes				
Power contacts (right)	U ₀ , 0 V, shield				
E-Bus current consumption	90 mA typ.				
Bit width in process image	2				
Electrical connection to mounting rail	-				
Residual ripple	<5 mV				
Electrical isolation	yes (500 V against field level)				
Dimensions (W x H x D)	approx. 15 mm x 100 mm x 70 mm (width aligned: 12 mm)				
Configuration	no address or configuration settings required				
Weight	approx. 65 g				
Permissible ambient temperature range during operation	0°C ... + 55°C				
Permissible ambient temperature range during storage	-25°C ... + 85°C				
Permissible relative humidity	95 %, no condensation				
<u>Mounting</u> [▶ 31]	on 35 mm mounting rail conforms to EN 60715				
Enhanced mechanical load capacity	yes, see also <u>installation instructions for enhanced mechanical load capacity</u> [▶ 35]				
Vibration/shock resistance	conforms to EN 60068-2-6 / EN 60068-2-27, EN 60068-2-29				
EMC immunity/emission	conforms to EN 61000-6-2 / EN 61000-6-4				
Protection class	IP20				
Installation position	variable				
Marking / Approval ^{*)}	CE, EAC, UKCA cULus [▶ 30], ATEX [▶ 28]				

*) Real applicable approvals/markings see type plate on the side (product marking).

Ex marking

Standard	Marking
ATEX	II 3 G Ex nA IIC T4 Gc

3.3 EL9560 - Technical data

Technical data	EL9560
Input voltage	24 V _{DC} (-15 %/+20 %)
Output voltage	24 V _{DC} (-15 %/+5 %)
Output current	0.1 A
Short circuit proof	yes
Message to E-bus	yes
Power contacts (right)	U ₀ , 0 V, PE
E-Bus current consumption	90 mA typ.
Bit width in process image	1
Electrical connection to mounting rail	-
Isolation voltage	1,500 V _{AC} -continuous load, field side/E-bus
Insulation voltage input/output	500 V _{AC} continuous load
Dimensions (W x H x D)	approx. 15 mm x 100 mm x 70 mm (width aligned: 12 mm)
Configuration	no address or configuration settings required
Weight	approx. 65 g
Permissible ambient temperature range during operation	0°C ... + 55°C
Permissible ambient temperature range during storage	-25°C ... + 85°C
Permissible relative humidity	95 %, no condensation
Mounting [▶ 31]	on 35 mm mounting rail conforms to EN 60715
Enhanced mechanical load capacity	yes, see also installation instructions for enhanced mechanical load capacity [▶ 35]
Vibration/shock resistance	conforms to EN 60068-2-6 / EN 60068-2-27, EN 60068-2-29
EMC immunity/emission	conforms to EN 61000-6-2 / EN 61000-6-4
Protection class	IP20
Installation position	variable
Marking / Approval ^{*)}	CE, EAC, UKCA cULus [▶ 30]

*) Real applicable approvals/markings see type plate on the side (product marking).

4 Basics communication

4.1 EtherCAT basics

Please refer to the [EtherCAT System Documentation](#) for the EtherCAT fieldbus basics.

4.2 EtherCAT cabling – wire-bound

The cable length between two EtherCAT devices must not exceed 100 m. This results from the FastEthernet technology, which, above all for reasons of signal attenuation over the length of the cable, allows a maximum link length of 5 + 90 + 5 m if cables with appropriate properties are used. See also the [Design recommendations for the infrastructure for EtherCAT/Ethernet](#).

Cables and connectors

For connecting EtherCAT devices only Ethernet connections (cables + plugs) that meet the requirements of at least category 5 (CAT5) according to EN 50173 or ISO/IEC 11801 should be used. EtherCAT uses 4 wires for signal transfer.

EtherCAT uses RJ45 plug connectors, for example. The pin assignment is compatible with the Ethernet standard (ISO/IEC 8802-3).

Pin	Color of conductor	Signal	Description
1	yellow	TD +	Transmission Data +
2	orange	TD -	Transmission Data -
3	white	RD +	Receiver Data +
6	blue	RD -	Receiver Data -

Due to automatic cable detection (auto-crossing) symmetric (1:1) or cross-over cables can be used between EtherCAT devices from Beckhoff.

Recommended cables

- i** It is recommended to use the appropriate Beckhoff components e.g.
- cable sets ZK1090-9191-xxxx respectively
 - RJ45 connector, field assembly ZS1090-0005
 - EtherCAT cable, field assembly ZB9010, ZB9020

Suitable cables for the connection of EtherCAT devices can be found on the [Beckhoff website!](#)

E-Bus supply

A bus coupler can supply the EL terminals added to it with the E-bus system voltage of 5 V; a coupler is thereby loadable up to 2 A as a rule (see details in respective device documentation). Information on how much current each EL terminal requires from the E-bus supply is available online and in the catalogue. If the added terminals require more current than the coupler can supply, then power feed terminals (e.g. [EL9410](#)) must be inserted at appropriate places in the terminal strand.

The pre-calculated theoretical maximum E-Bus current is displayed in the TwinCAT System Manager. A shortfall is marked by a negative total amount and an exclamation mark; a power feed terminal is to be placed before such a position.

Number	Box Name	Add...	Type	In Si...	Out ...	E-Bus (mA)
1	Term 1 (EK1100)	1001	EK1100			
2	Term 2 (EL2008)	1002	EL2008		1.0	1890
3	Term 3 (EL2008)	1003	EL2008		1.0	1780
4	Term 4 (EL2008)	1004	EL2008		1.0	1670
5	Term 5 (EL6740...)	1005	EL6740-0010	2.0	2.0	1220
6	Term 6 (EL6740...)	1006	EL6740-0010	2.0	2.0	770
7	Term 7 (EL6740...)	1007	EL6740-0010	2.0	2.0	320
8	Term 8 (EL6740...)	1008	EL6740-0010	2.0	2.0	-130 !
9	Term 9 (EL6740...)	1009	EL6740-0010	2.0	2.0	-580 !

Fig. 5: System manager current calculation

NOTE**Malfunction possible!**

The same ground potential must be used for the E-Bus supply of all EtherCAT terminals in a terminal block!

4.3 EtherCAT State Machine

The state of the EtherCAT slave is controlled via the EtherCAT State Machine (ESM). Depending upon the state, different functions are accessible or executable in the EtherCAT slave. Specific commands must be sent by the EtherCAT master to the device in each state, particularly during the bootup of the slave.

A distinction is made between the following states:

- Init
- Pre-Operational
- Safe-Operational and
- Operational
- Boot

The regular state of each EtherCAT slave after bootup is the OP state.

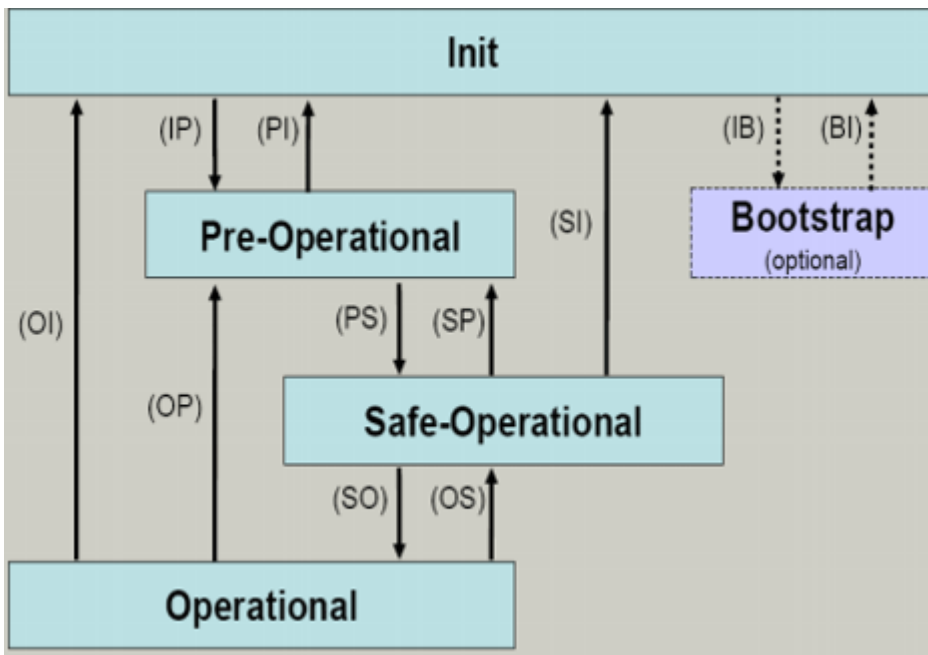

Fig. 6: States of the EtherCAT State Machine

Init

After switch-on the EtherCAT slave in the *Init* state. No mailbox or process data communication is possible. The EtherCAT master initializes sync manager channels 0 and 1 for mailbox communication.

Pre-Operational (Pre-Op)

During the transition between *Init* and *Pre-Op* the EtherCAT slave checks whether the mailbox was initialized correctly.

In *Pre-Op* state mailbox communication is possible, but not process data communication. The EtherCAT master initializes the sync manager channels for process data (from sync manager channel 2), the FMMU channels and, if the slave supports configurable mapping, PDO mapping or the sync manager PDO assignment. In this state the settings for the process data transfer and perhaps terminal-specific parameters that may differ from the default settings are also transferred.

Safe-Operational (Safe-Op)

During transition between *Pre-Op* and *Safe-Op* the EtherCAT slave checks whether the sync manager channels for process data communication and, if required, the distributed clocks settings are correct. Before it acknowledges the change of state, the EtherCAT slave copies current input data into the associated DP-RAM areas of the EtherCAT slave controller (ECSC).

In *Safe-Op* state mailbox and process data communication is possible, although the slave keeps its outputs in a safe state, while the input data are updated cyclically.

● **Outputs in SAFEOP state**

I The default set watchdog monitoring sets the outputs of the module in a safe state - depending on the settings in SAFEOP and OP - e.g. in OFF state. If this is prevented by deactivation of the watchdog monitoring in the module, the outputs can be switched or set also in the SAFEOP state.

Operational (Op)

Before the EtherCAT master switches the EtherCAT slave from *Safe-Op* to *Op* it must transfer valid output data.

In the *Op* state the slave copies the output data of the masters to its outputs. Process data and mailbox communication is possible.

Boot

In the *Boot* state the slave firmware can be updated. The *Boot* state can only be reached via the *Init* state.

In the *Boot* state mailbox communication via the *file access over EtherCAT* (FoE) protocol is possible, but no other mailbox communication and no process data communication.

4.4 CoE Interface

General description

The CoE interface (CAN application protocol over EtherCAT)) is used for parameter management of EtherCAT devices. EtherCAT slaves or the EtherCAT master manage fixed (read only) or variable parameters which they require for operation, diagnostics or commissioning.

CoE parameters are arranged in a table hierarchy. In principle, the user has read access via the fieldbus. The EtherCAT master (TwinCAT System Manager) can access the local CoE lists of the slaves via EtherCAT in read or write mode, depending on the attributes.

Different CoE parameter types are possible, including string (text), integer numbers, Boolean values or larger byte fields. They can be used to describe a wide range of features. Examples of such parameters include manufacturer ID, serial number, process data settings, device name, calibration values for analog measurement or passwords.

The order is specified in two levels via hexadecimal numbering: (main)index, followed by subindex. The value ranges are

- Index: 0x0000 ...0xFFFF (0...65535_{dec})
- SubIndex: 0x00...0xFF (0...255_{dec})

A parameter localized in this way is normally written as 0x8010:07, with preceding "0x" to identify the hexadecimal numerical range and a colon between index and subindex.

The relevant ranges for EtherCAT fieldbus users are:

- 0x1000: This is where fixed identity information for the device is stored, including name, manufacturer, serial number etc., plus information about the current and available process data configurations.
- 0x8000: This is where the operational and functional parameters for all channels are stored, such as filter settings or output frequency.

Other important ranges are:

- 0x4000: here are the channel parameters for some EtherCAT devices. Historically, this was the first parameter area before the 0x8000 area was introduced. EtherCAT devices that were previously equipped with parameters in 0x4000 and changed to 0x8000 support both ranges for compatibility reasons and mirror internally.
- 0x6000: Input PDOs ("input" from the perspective of the EtherCAT master)
- 0x7000: Output PDOs ("output" from the perspective of the EtherCAT master)

Availability



Not every EtherCAT device must have a CoE list. Simple I/O modules without dedicated processor usually have no variable parameters and therefore no CoE list.

If a device has a CoE list, it is shown in the TwinCAT System Manager as a separate tab with a listing of the elements:

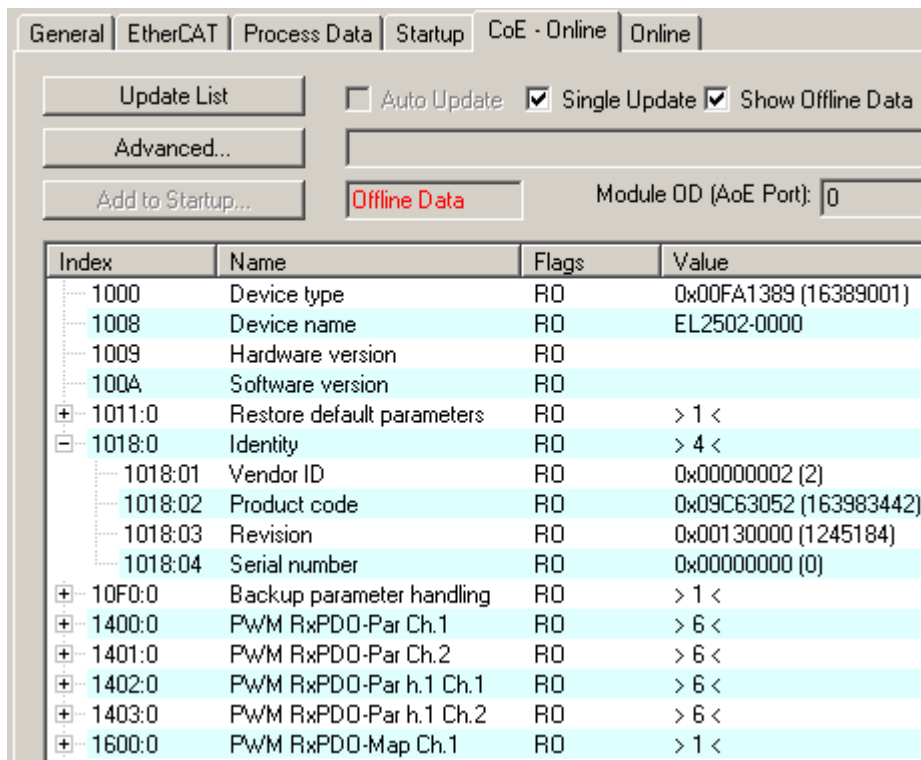

Fig. 7: “CoE Online” tab

The figure above shows the CoE objects available in device “EL2502”, ranging from 0x1000 to 0x1600. The subindices for 0x1018 are expanded.

Data management and function “NoCoeStorage”

Some parameters, particularly the setting parameters of the slave, are configurable and writeable. This can be done in write or read mode

- via the System Manager (Fig. “CoE Online” tab) by clicking
This is useful for commissioning of the system/slaves. Click on the row of the index to be parameterized and enter a value in the “SetValue” dialog.
- from the control system/PLC via ADS, e.g. through blocks from the TcEtherCAT.lib library
This is recommended for modifications while the system is running or if no System Manager or operating staff are available.

i Data management

If slave CoE parameters are modified online, Beckhoff devices store any changes in a fail-safe manner in the EEPROM, i.e. the modified CoE parameters are still available after a restart. The situation may be different with other manufacturers.

An EEPROM is subject to a limited lifetime with respect to write operations. From typically 100,000 write operations onwards it can no longer be guaranteed that new (changed) data are reliably saved or are still readable. This is irrelevant for normal commissioning. However, if CoE parameters are continuously changed via ADS at machine runtime, it is quite possible for the lifetime limit to be reached. Support for the NoCoeStorage function, which suppresses the saving of changed CoE values, depends on the firmware version.

Please refer to the technical data in this documentation as to whether this applies to the respective device.

- If the function is supported: the function is activated by entering the code word 0x12345678 once in CoE 0xF008 and remains active as long as the code word is not changed. After switching the device on it is then inactive. Changed CoE values are not saved in the EEPROM and can thus be changed any number of times.
- Function is not supported: continuous changing of CoE values is not permissible in view of the lifetime limit.

i Startup list

Changes in the local CoE list of the terminal are lost if the terminal is replaced. If a terminal is replaced with a new Beckhoff terminal, it will have the default settings. It is therefore advisable to link all changes in the CoE list of an EtherCAT slave with the Startup list of the slave, which is processed whenever the EtherCAT fieldbus is started. In this way a replacement EtherCAT slave can automatically be parameterized with the specifications of the user.

If EtherCAT slaves are used which are unable to store local CoE values permanently, the Startup list must be used.

Recommended approach for manual modification of CoE parameters

- Make the required change in the System Manager
The values are stored locally in the EtherCAT slave
- If the value is to be stored permanently, enter it in the Startup list.
The order of the Startup entries is usually irrelevant.

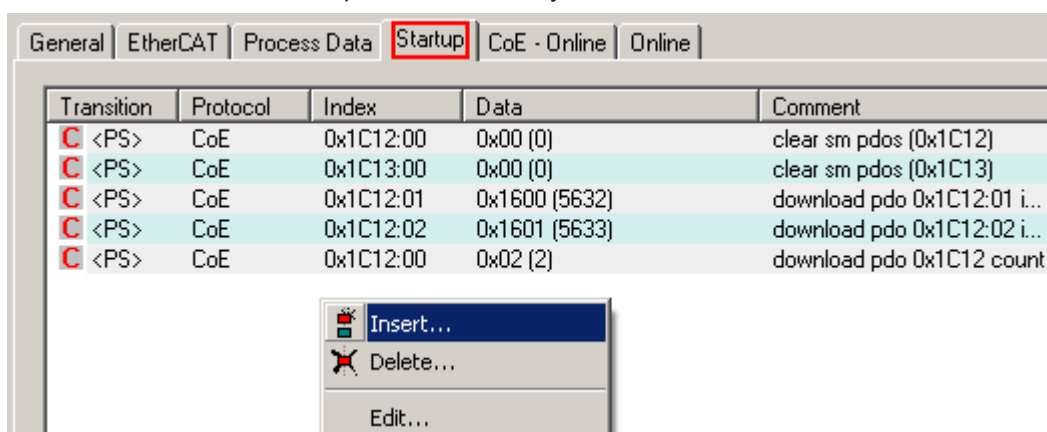

Fig. 8: Startup list in the TwinCAT System Manager

The Startup list may already contain values that were configured by the System Manager based on the ESI specifications. Additional application-specific entries can be created.

Online/offline list

While working with the TwinCAT System Manager, a distinction has to be made whether the EtherCAT device is “available”, i.e. switched on and linked via EtherCAT and therefore **online**, or whether a configuration is created **offline** without connected slaves.

In both cases a CoE list as shown in Fig. “CoE online tab” is displayed. The connectivity is shown as offline/online.

- If the slave is offline
 - The offline list from the ESI file is displayed. In this case modifications are not meaningful or possible.
 - The configured status is shown under Identity.
 - No firmware or hardware version is displayed, since these are features of the physical device.
 - **Offline** is shown in red.

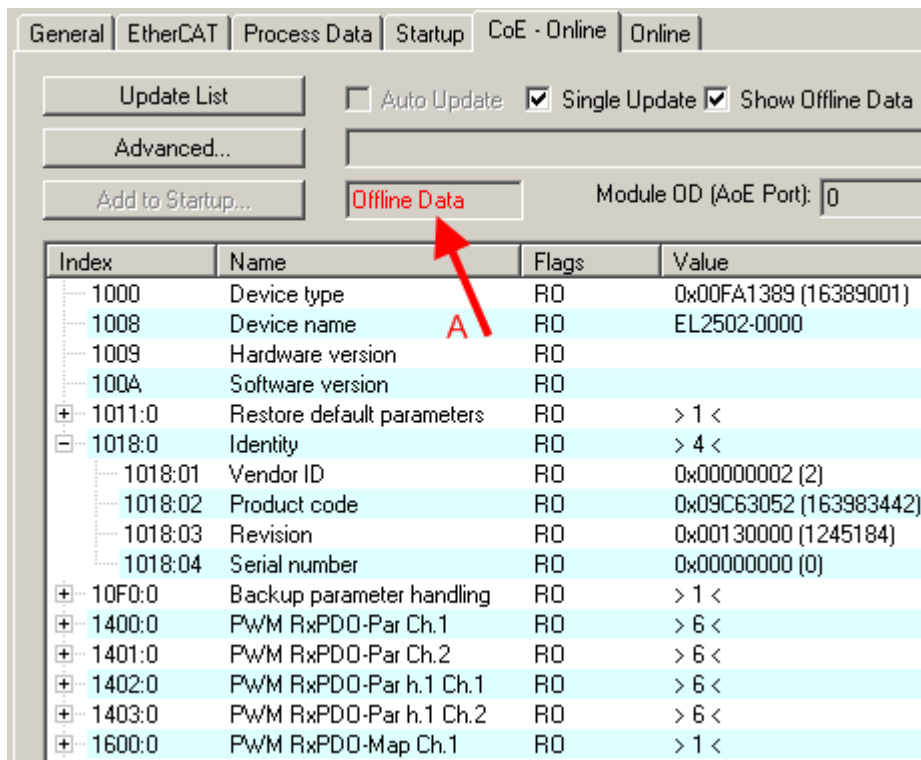

Fig. 9: Offline list

- If the slave is online
 - The actual current slave list is read. This may take several seconds, depending on the size and cycle time.
 - The actual identity is displayed
 - The firmware and hardware version of the equipment according to the electronic information is displayed
 - **Online** is shown in green.

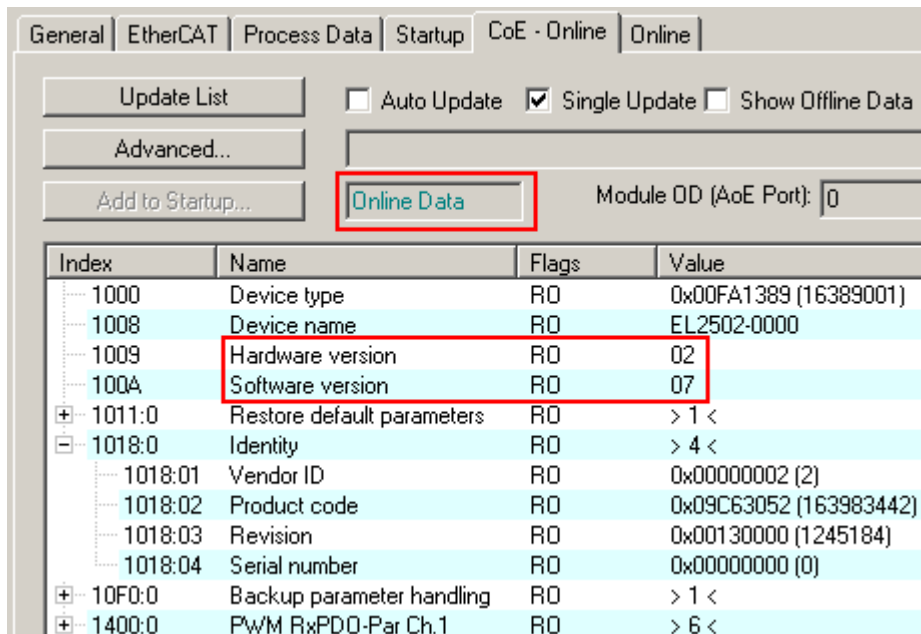

Fig. 10: Online list

Channel-based order

The CoE list is available in EtherCAT devices that usually feature several functionally equivalent channels. For example, a 4-channel analog 0...10 V input terminal also has four logical channels and therefore four identical sets of parameter data for the channels. In order to avoid having to list each channel in the documentation, the placeholder “n” tends to be used for the individual channel numbers.

In the CoE system 16 indices, each with 255 subindices, are generally sufficient for representing all channel parameters. The channel-based order is therefore arranged in $16_{\text{dec}}/10_{\text{hex}}$ steps. The parameter range 0x8000 exemplifies this:

- Channel 0: parameter range 0x8000:00 ... 0x800F:255
- Channel 1: parameter range 0x8010:00 ... 0x801F:255
- Channel 2: parameter range 0x8020:00 ... 0x802F:255
- ...

This is generally written as 0x80n0.

Detailed information on the CoE interface can be found in the [EtherCAT system documentation](#) on the Beckhoff website.

5 Mounting and wiring

5.1 Instructions for ESD protection

NOTE

Destruction of the devices by electrostatic discharge possible!

The devices contain components at risk from electrostatic discharge caused by improper handling.

- Please ensure you are electrostatically discharged and avoid touching the contacts of the device directly.
- Avoid contact with highly insulating materials (synthetic fibers, plastic film etc.).
- Surroundings (working place, packaging and personnel) should be grounded probably, when handling with the devices.
- Each assembly must be terminated at the right hand end with an [EL9011](#) or [EL9012](#) bus end cap, to ensure the protection class and ESD protection.

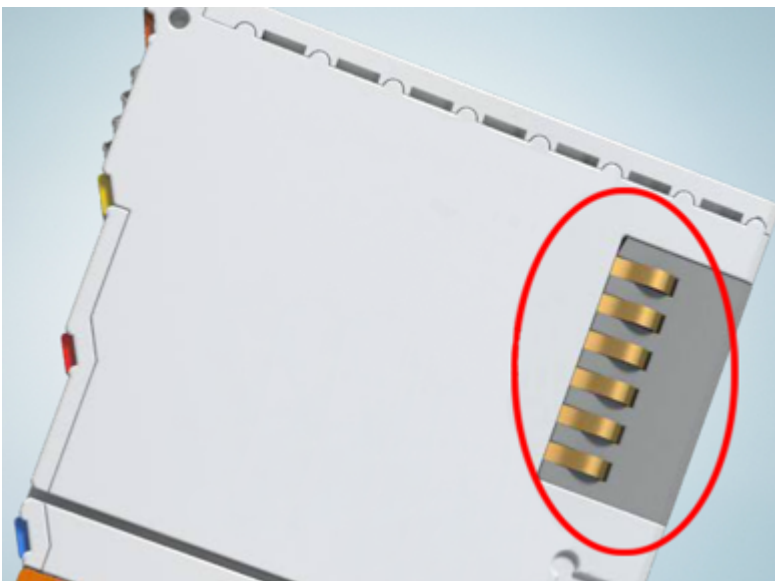

Fig. 11: Spring contacts of the Beckhoff I/O components

5.2 Explosion protection

5.2.1 ATEX - Special conditions (standard temperature range)

⚠ WARNING

Observe the special conditions for the intended use of Beckhoff fieldbus components with standard temperature range in potentially explosive areas (directive 2014/34/EU)!

- The certified components are to be installed in a suitable housing that guarantees a protection class of at least IP54 in accordance with EN 60079-15! The environmental conditions during use are thereby to be taken into account!
- For dust (only the fieldbus components of certificate no. KEMA 10ATEX0075 X Issue 9): The equipment shall be installed in a suitable enclosure providing a degree of protection of IP54 according to EN 60079-31 for group IIIA or IIIB and IP6X for group IIIC, taking into account the environmental conditions under which the equipment is used!
- If the temperatures during rated operation are higher than 70°C at the feed-in points of cables, lines or pipes, or higher than 80°C at the wire branching points, then cables must be selected whose temperature data correspond to the actual measured temperature values!
- Observe the permissible ambient temperature range of 0 to 55°C for the use of Beckhoff fieldbus components standard temperature range in potentially explosive areas!
- Measures must be taken to protect against the rated operating voltage being exceeded by more than 40% due to short-term interference voltages!
- The individual terminals may only be unplugged or removed from the Bus Terminal system if the supply voltage has been switched off or if a non-explosive atmosphere is ensured!
- The connections of the certified components may only be connected or disconnected if the supply voltage has been switched off or if a non-explosive atmosphere is ensured!
- The fuses of the KL92xx/EL92xx power feed terminals may only be exchanged if the supply voltage has been switched off or if a non-explosive atmosphere is ensured!
- Address selectors and ID switches may only be adjusted if the supply voltage has been switched off or if a non-explosive atmosphere is ensured!

Standards

The fundamental health and safety requirements are fulfilled by compliance with the following standards:

- EN 60079-0:2012+A11:2013
- EN 60079-15:2010
- EN 60079-31:2013 (only for certificate no. KEMA 10ATEX0075 X Issue 9)

Marking

The Beckhoff fieldbus components with standard temperature range certified according to the ATEX directive for potentially explosive areas bear one of the following markings:



II 3G KEMA 10ATEX0075 X Ex nA IIC T4 Gc Ta: 0 ... +55°C

II 3D KEMA 10ATEX0075 X Ex tc IIIC T135°C Dc Ta: 0 ... +55°C
(only for fieldbus components of certificate no. KEMA 10ATEX0075 X Issue 9)

or



II 3G KEMA 10ATEX0075 X Ex nA nC IIC T4 Gc Ta: 0 ... +55°C

II 3D KEMA 10ATEX0075 X Ex tc IIIC T135°C Dc Ta: 0 ... +55°C
(only for fieldbus components of certificate no. KEMA 10ATEX0075 X Issue 9)

5.2.2 Continuative documentation for ATEX and IECEx

NOTE



Continuative documentation about explosion protection according to ATEX and IECEx

Pay also attention to the continuative documentation

Ex. Protection for Terminal Systems

Notes on the use of the Beckhoff terminal systems in hazardous areas according to ATEX and IECEx,

that is available for [download](#) within the download area of your product on the Beckhoff homepage www.beckhoff.com!

5.3 UL notice

⚠ CAUTION



Application

Beckhoff EtherCAT modules are intended for use with Beckhoff's UL Listed EtherCAT System only.

⚠ CAUTION



Examination

For cULus examination, the Beckhoff I/O System has only been investigated for risk of fire and electrical shock (in accordance with UL508 and CSA C22.2 No. 142).

⚠ CAUTION



For devices with Ethernet connectors

Not for connection to telecommunication circuits.

Basic principles

UL certification according to UL508. Devices with this kind of certification are marked by this sign:



5.4 Installation on mounting rails

⚠ WARNING

Risk of electric shock and damage of device!

Bring the bus terminal system into a safe, powered down state before starting installation, disassembly or wiring of the bus terminals!

Assembly

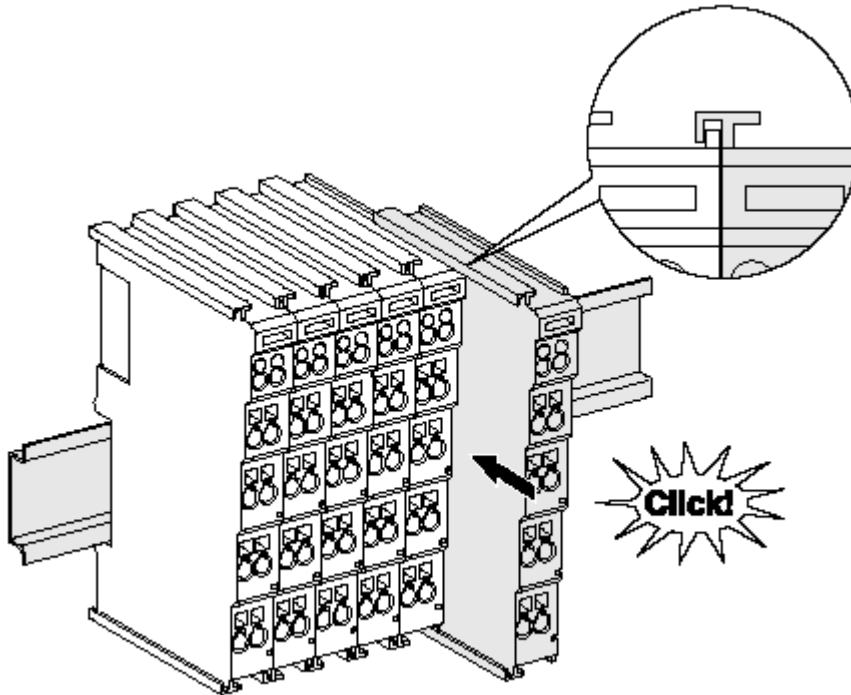

Fig. 12: Attaching on mounting rail

The bus coupler and bus terminals are attached to commercially available 35 mm mounting rails (DIN rails according to EN 60715) by applying slight pressure:

1. First attach the fieldbus coupler to the mounting rail.
2. The bus terminals are now attached on the right-hand side of the fieldbus coupler. Join the components with tongue and groove and push the terminals against the mounting rail, until the lock clicks onto the mounting rail.

If the terminals are clipped onto the mounting rail first and then pushed together without tongue and groove, the connection will not be operational! When correctly assembled, no significant gap should be visible between the housings.

i Fixing of mounting rails

The locking mechanism of the terminals and couplers extends to the profile of the mounting rail. At the installation, the locking mechanism of the components must not come into conflict with the fixing bolts of the mounting rail. To mount the mounting rails with a height of 7.5 mm under the terminals and couplers, you should use flat mounting connections (e.g. countersunk screws or blind rivets).

Disassembly

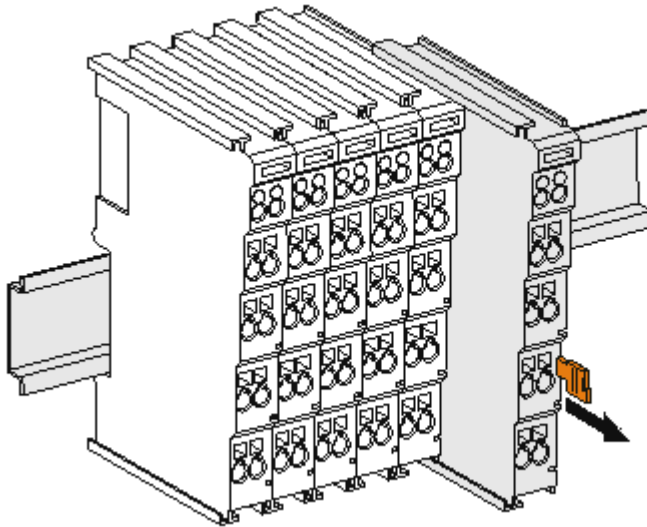

Fig. 13: Disassembling of terminal

Each terminal is secured by a lock on the mounting rail, which must be released for disassembly:

1. Pull the terminal by its orange-colored lugs approximately 1 cm away from the mounting rail. In doing so for this terminal the mounting rail lock is released automatically and you can pull the terminal out of the bus terminal block easily without excessive force.
2. Grasp the released terminal with thumb and index finger simultaneous at the upper and lower grooved housing surfaces and pull the terminal out of the bus terminal block.

Connections within a bus terminal block

The electric connections between the Bus Coupler and the Bus Terminals are automatically realized by joining the components:

- The six spring contacts of the K-Bus/E-Bus deal with the transfer of the data and the supply of the Bus Terminal electronics.
- The power contacts deal with the supply for the field electronics and thus represent a supply rail within the bus terminal block. The power contacts are supplied via terminals on the Bus Coupler (up to 24 V) or for higher voltages via power feed terminals.

i Power Contacts

During the design of a bus terminal block, the pin assignment of the individual Bus Terminals must be taken account of, since some types (e.g. analog Bus Terminals or digital 4-channel Bus Terminals) do not or not fully loop through the power contacts. Power Feed Terminals (KL91xx, KL92xx or EL91xx, EL92xx) interrupt the power contacts and thus represent the start of a new supply rail.

PE power contact

The power contact labeled PE can be used as a protective earth. For safety reasons this contact mates first when plugging together, and can ground short-circuit currents of up to 125 A.

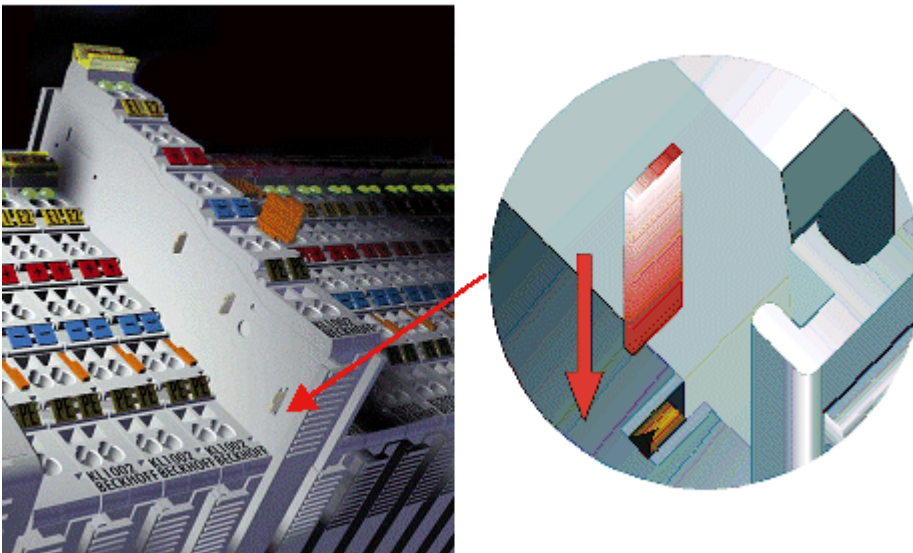

Fig. 14: Power contact on left side

NOTE

Possible damage of the device

Note that, for reasons of electromagnetic compatibility, the PE contacts are capacitatively coupled to the mounting rail. This may lead to incorrect results during insulation testing or to damage on the terminal (e.g. disruptive discharge to the PE line during insulation testing of a consumer with a nominal voltage of 230 V). For insulation testing, disconnect the PE supply line at the Bus Coupler or the Power Feed Terminal! In order to decouple further feed points for testing, these Power Feed Terminals can be released and pulled at least 10 mm from the group of terminals.

⚠ WARNING

Risk of electric shock!

The PE power contact must not be used for other potentials!

5.5 Positioning of passive Terminals

i **Hint for positioning of passive terminals in the bus terminal block**

EtherCAT Terminals (ELxxxx / ESxxxx), which do not take an active part in data transfer within the bus terminal block are so called passive terminals. The passive terminals have no current consumption out of the E-Bus.

To ensure an optimal data transfer, you must not directly string together more than two passive terminals!

Examples for positioning of passive terminals (highlighted)

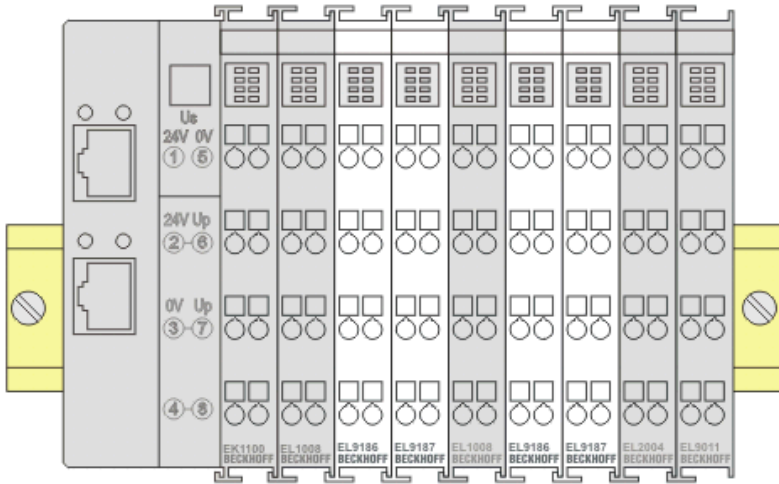

Fig. 15: Correct positioning

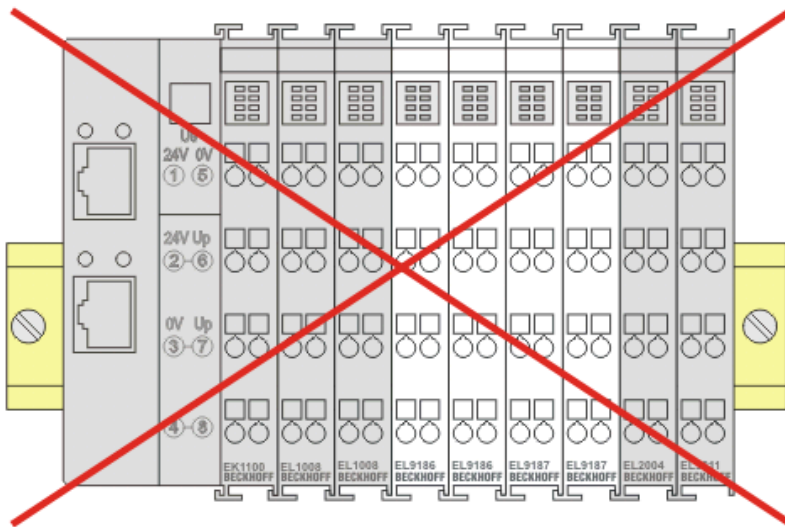

Fig. 16: Incorrect positioning

5.6 Installation instructions for enhanced mechanical load capacity

⚠ WARNING

Risk of injury through electric shock and damage to the device!

Bring the Bus Terminal system into a safe, de-energized state before starting mounting, disassembly or wiring of the Bus Terminals!

Additional checks

The terminals have undergone the following additional tests:

Verification	Explanation
Vibration	10 frequency runs in 3 axes
	6 Hz < f < 60 Hz displacement 0.35 mm, constant amplitude
	60.1 Hz < f < 500 Hz acceleration 5 g, constant amplitude
Shocks	1000 shocks in each direction, in 3 axes
	25 g, 6 ms

Additional installation instructions

For terminals with enhanced mechanical load capacity, the following additional installation instructions apply:

- The enhanced mechanical load capacity is valid for all permissible installation positions
- Use a mounting rail according to EN 60715 TH35-15
- Fix the terminal segment on both sides of the mounting rail with a mechanical fixture, e.g. an earth terminal or reinforced end clamp
- The maximum total extension of the terminal segment (without coupler) is:
64 terminals (12 mm mounting with) or 32 terminals (24 mm mounting with)
- Avoid deformation, twisting, crushing and bending of the mounting rail during edging and installation of the rail
- The mounting points of the mounting rail must be set at 5 cm intervals
- Use countersunk head screws to fasten the mounting rail
- The free length between the strain relief and the wire connection should be kept as short as possible. A distance of approx. 10 cm should be maintained to the cable duct.

5.7 Connection

5.7.1 Connection system

⚠ WARNING

Risk of electric shock and damage of device!

Bring the bus terminal system into a safe, powered down state before starting installation, disassembly or wiring of the bus terminals!

Overview

The bus terminal system offers different connection options for optimum adaptation to the respective application:

- The terminals of ELxxxx and KLxxxx series with standard wiring include electronics and connection level in a single enclosure.
- The terminals of ESxxxx and KSxxxx series feature a pluggable connection level and enable steady wiring while replacing.
- The High Density Terminals (HD Terminals) include electronics and connection level in a single enclosure and have advanced packaging density.

Standard wiring (ELxxxx / KLxxxx)



Fig. 17: Standard wiring

The terminals of ELxxxx and KLxxxx series have been tried and tested for years. They feature integrated screwless spring force technology for fast and simple assembly.

Pluggable wiring (ESxxxx / KSxxxx)



Fig. 18: Pluggable wiring

The terminals of ESxxxx and KSxxxx series feature a pluggable connection level. The assembly and wiring procedure is the same as for the ELxxxx and KLxxxx series. The pluggable connection level enables the complete wiring to be removed as a plug connector from the top of the housing for servicing. The lower section can be removed from the terminal block by pulling the unlocking tab. Insert the new component and plug in the connector with the wiring. This reduces the installation time and eliminates the risk of wires being mixed up.

The familiar dimensions of the terminal only had to be changed slightly. The new connector adds about 3 mm. The maximum height of the terminal remains unchanged.

A tab for strain relief of the cable simplifies assembly in many applications and prevents tangling of individual connection wires when the connector is removed.

Conductor cross sections between 0.08 mm² and 2.5 mm² can continue to be used with the proven spring force technology.

The overview and nomenclature of the product names for ESxxxx and KSxxxx series has been retained as known from ELxxxx and KLxxxx series.

High Density Terminals (HD Terminals)



Fig. 19: High Density Terminals

The terminals from these series with 16 terminal points are distinguished by a particularly compact design, as the packaging density is twice as large as that of the standard 12 mm bus terminals. Massive conductors and conductors with a wire end sleeve can be inserted directly into the spring loaded terminal point without tools.

● Wiring HD Terminals



The High Density Terminals of the ELx8xx and KLx8xx series doesn't support pluggable wiring.

Ultrasonically “bonded” (ultrasonically welded) conductors

● Ultrasonically “bonded” conductors



It is also possible to connect the Standard and High Density Terminals with ultrasonically “bonded” (ultrasonically welded) conductors. In this case, please note the tables concerning the wire-size width [► 38]!

5.7.2 Wiring

⚠ WARNING

Risk of electric shock and damage of device!

Bring the bus terminal system into a safe, powered down state before starting installation, disassembly or wiring of the bus terminals!

Terminals for standard wiring ELxxxx/KLxxxx and for pluggable wiring ESxxxx/KSxxxx

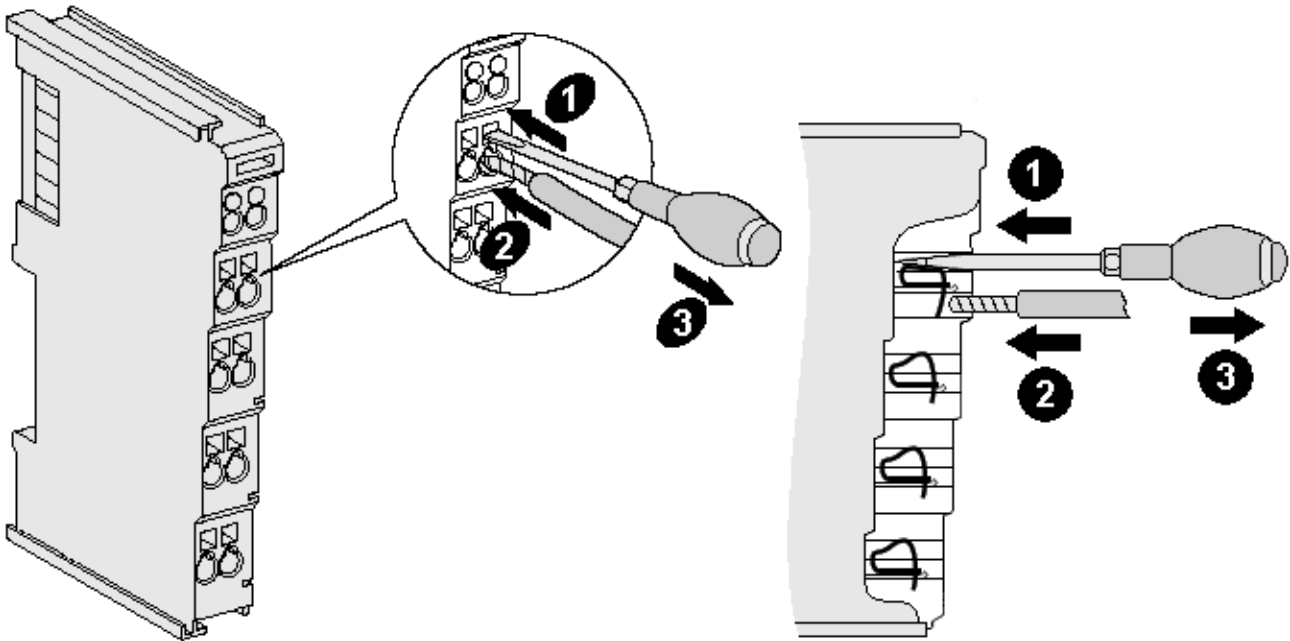

Fig. 20: Connecting a cable on a terminal point

Up to eight terminal points enable the connection of solid or finely stranded cables to the bus terminal. The terminal points are implemented in spring force technology. Connect the cables as follows:

1. Open a terminal point by pushing a screwdriver straight against the stop into the square opening above the terminal point. Do not turn the screwdriver or move it alternately (don't toggle).
2. The wire can now be inserted into the round terminal opening without any force.
3. The terminal point closes automatically when the pressure is released, holding the wire securely and permanently.

See the following table for the suitable wire size width.

Terminal housing	ELxxxx, KLxxxx	ESxxxx, KSxxxx
Wire size width (single core wires)	0.08 ... 2.5 mm ²	0.08 ... 2.5 mm ²
Wire size width (fine-wire conductors)	0.08 ... 2.5 mm ²	0.08 ... 2.5 mm ²
Wire size width (conductors with a wire end sleeve)	0.14 ... 1.5 mm ²	0.14 ... 1.5 mm ²
Wire stripping length	8 ... 9 mm	9 ... 10 mm

High Density Terminals (HD Terminals [[▶ 37](#)]) with 16 terminal points

The conductors of the HD Terminals are connected without tools for single-wire conductors using the direct plug-in technique, i.e. after stripping the wire is simply plugged into the terminal point. The cables are released, as usual, using the contact release with the aid of a screwdriver. See the following table for the suitable wire size width.

Terminal housing	High Density Housing
Wire size width (single core wires)	0.08 ... 1.5 mm ²
Wire size width (fine-wire conductors)	0.25 ... 1.5 mm ²
Wire size width (conductors with a wire end sleeve)	0.14 ... 0.75 mm ²
Wire size width (ultrasonically "bonded" conductors)	only 1.5 mm ² (see notice [▶ 37])
Wire stripping length	8 ... 9 mm

5.7.3 Shielding



Shielding

Encoder, analog sensors and actors should always be connected with shielded, twisted paired wires.

5.8 Note - Power supply

WARNING

Power supply from SELV/PELV power supply unit!

SELV/PELV circuits (Safety Extra Low Voltage, Protective Extra Low Voltage) according to IEC 61010-2-201 must be used to supply this device.

Notes:

- SELV/PELV circuits may give rise to further requirements from standards such as IEC 60204-1 et al, for example with regard to cable spacing and insulation.
- A SELV (Safety Extra Low Voltage) supply provides safe electrical isolation and limitation of the voltage without a connection to the protective conductor,
a PELV (Protective Extra Low Voltage) supply also requires a safe connection to the protective conductor.

5.9 ATEX - Special conditions (standard temperature range)

⚠ WARNING

Observe the special conditions for the intended use of Beckhoff fieldbus components with standard temperature range in potentially explosive areas (directive 2014/34/EU)!

- The certified components are to be installed in a suitable housing that guarantees a protection class of at least IP54 in accordance with EN 60079-15! The environmental conditions during use are thereby to be taken into account!
- For dust (only the fieldbus components of certificate no. KEMA 10ATEX0075 X Issue 9): The equipment shall be installed in a suitable enclosure providing a degree of protection of IP54 according to EN 60079-31 for group IIIA or IIIB and IP6X for group IIIC, taking into account the environmental conditions under which the equipment is used!
- If the temperatures during rated operation are higher than 70°C at the feed-in points of cables, lines or pipes, or higher than 80°C at the wire branching points, then cables must be selected whose temperature data correspond to the actual measured temperature values!
- Observe the permissible ambient temperature range of 0 to 55°C for the use of Beckhoff fieldbus components standard temperature range in potentially explosive areas!
- Measures must be taken to protect against the rated operating voltage being exceeded by more than 40% due to short-term interference voltages!
- The individual terminals may only be unplugged or removed from the Bus Terminal system if the supply voltage has been switched off or if a non-explosive atmosphere is ensured!
- The connections of the certified components may only be connected or disconnected if the supply voltage has been switched off or if a non-explosive atmosphere is ensured!
- The fuses of the KL92xx/EL92xx power feed terminals may only be exchanged if the supply voltage has been switched off or if a non-explosive atmosphere is ensured!
- Address selectors and ID switches may only be adjusted if the supply voltage has been switched off or if a non-explosive atmosphere is ensured!

Standards

The fundamental health and safety requirements are fulfilled by compliance with the following standards:

- EN 60079-0:2012+A11:2013
- EN 60079-15:2010
- EN 60079-31:2013 (only for certificate no. KEMA 10ATEX0075 X Issue 9)

Marking

The Beckhoff fieldbus components with standard temperature range certified according to the ATEX directive for potentially explosive areas bear one of the following markings:



II 3G KEMA 10ATEX0075 X Ex nA IIC T4 Gc Ta: 0 ... +55°C

II 3D KEMA 10ATEX0075 X Ex tc IIIC T135°C Dc Ta: 0 ... +55°C
(only for fieldbus components of certificate no. KEMA 10ATEX0075 X Issue 9)

or



II 3G KEMA 10ATEX0075 X Ex nA nC IIC T4 Gc Ta: 0 ... +55°C

II 3D KEMA 10ATEX0075 X Ex tc IIIC T135°C Dc Ta: 0 ... +55°C
(only for fieldbus components of certificate no. KEMA 10ATEX0075 X Issue 9)

5.10 Continulative documentation for ATEX and IECEx

NOTE



Continulative documentation about explosion protection according to ATEX and IECEx

Pay also attention to the continuative documentation

Ex. Protection for Terminal Systems

Notes on the use of the Beckhoff terminal systems in hazardous areas according to ATEX and IECEx,

that is available for [download](#) within the download area of your product on the Beckhoff homepage www.beckhoff.com!

5.11 Pin assignment

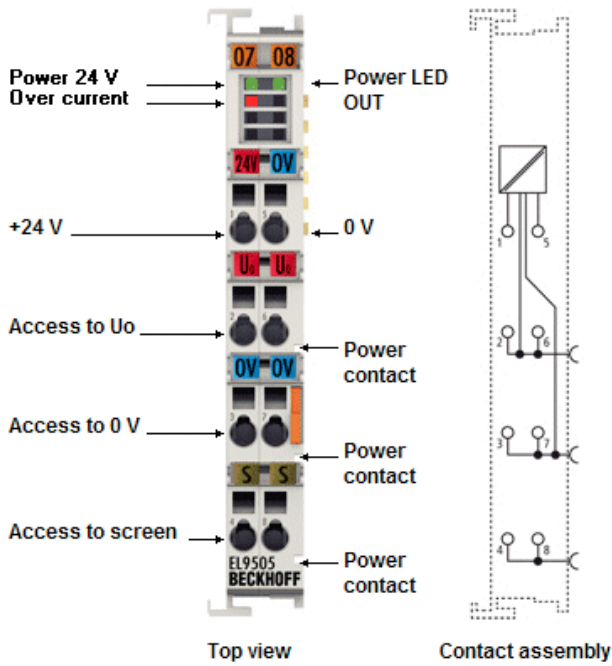

Fig. 21: Pin assignment based on EL9505 as an example

Terminal point		Description
Name	No.	
+24 V	1	+24 V input voltage
Output U_0	2	Pickup of output voltage U_0 (linked to terminal point 6 and power contact U_0)
Output 0 V	3	Pickup of output voltage 0 V (linked to terminal point 7 and power contact 0 V)
Shield / PE	4	Pickup of shielding / PE (linked to terminal point 8 and power contact shielding / PE)
0 V	5	0 V input voltage
Output U_0	6	Pickup of output voltage U_0 (linked to terminal point 2 and power contact U_0)
Output 0 V	7	Pickup of output voltage 0 V (linked to terminal point 3 and power contact 0 V)
Shield / PE	8	Pickup of shielding / PE (linked to terminal point 4 and power contact shielding / PE)

6 Commissioning

6.1 Inserting the terminal in the EtherCAT terminal network

(Master: TwinCAT 2.1x)

● Installation of the latest XML device description



Please ensure that you have installed the corresponding latest XML device description in TwinCAT. This can be downloaded from the Beckhoff Website and installed according to the installation instructions.

The configuration tree in the Beckhoff TwinCAT System Manager can be created in 2 ways:

- by scanning of existing hardware (referred to as “online”), or
- by manually inserting/appending fieldbus devices, couplers and slaves.

Automatic scanning in of the terminal

- The Bus Terminal system must be in a safe, de-energized state before the terminals are inserted into the terminal network as described in section [Mounting rail installation \[▶ 31\]](#).
- Once the operating voltage has been switched on, open the TwinCAT System Manager (Config mode) and scan in the terminal (see Fig. *Scanning in the EtherCAT configuration (I/O Devices -> right click -> Scan Devices...*). Acknowledge all dialogs with “OK”, so that the configuration is in “FreeRun” mode.

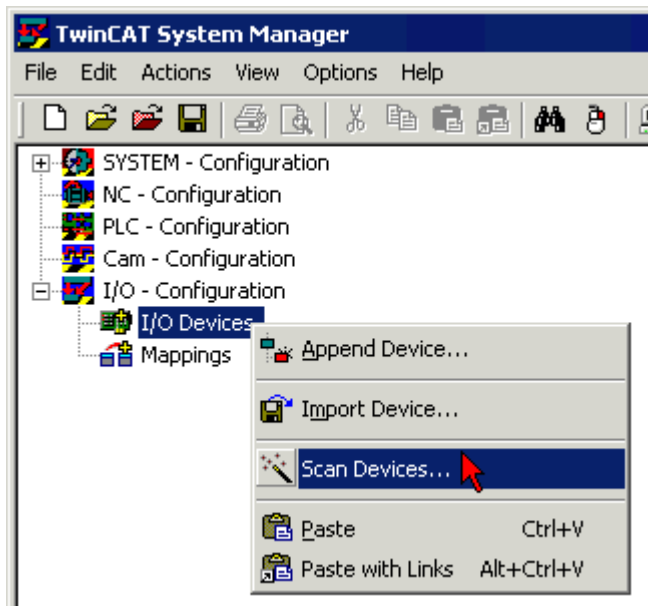

Fig. 22: Scanning in the EtherCAT configuration (I/O Devices-> right-click -> Scan Devices...)

Appending a terminal manually

- The Bus Terminal system must be in a safe, de-energized state before the terminals are inserted into the terminal network as described in section [Mounting rail installation \[▶ 31\]](#).
- Switch on the operating voltage, open the TwinCAT System Manager (Config mode)
- Appending a new I/O device (see Fig. *Appending a new I/O device (I/O Devices -> right click -> Append Device...*). In the dialog that follows select the device *EtherCAT (Direct Mode)*, see Fig. *Selecting the device EtherCAT (Direct Mode)* and confirm with OK.

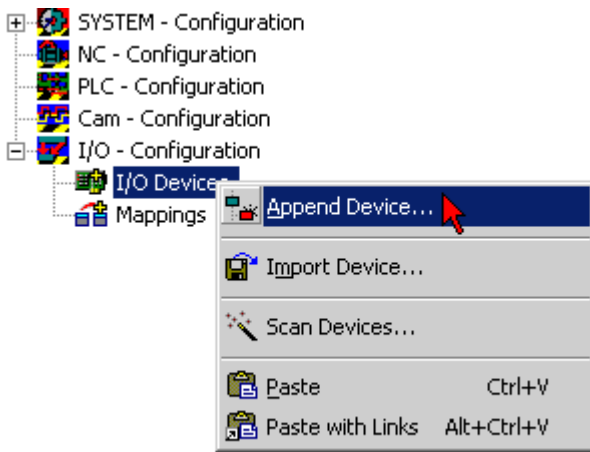

Fig. 23: Appending a new I/O device (I/O Devices-> right-click -> Append Device...)

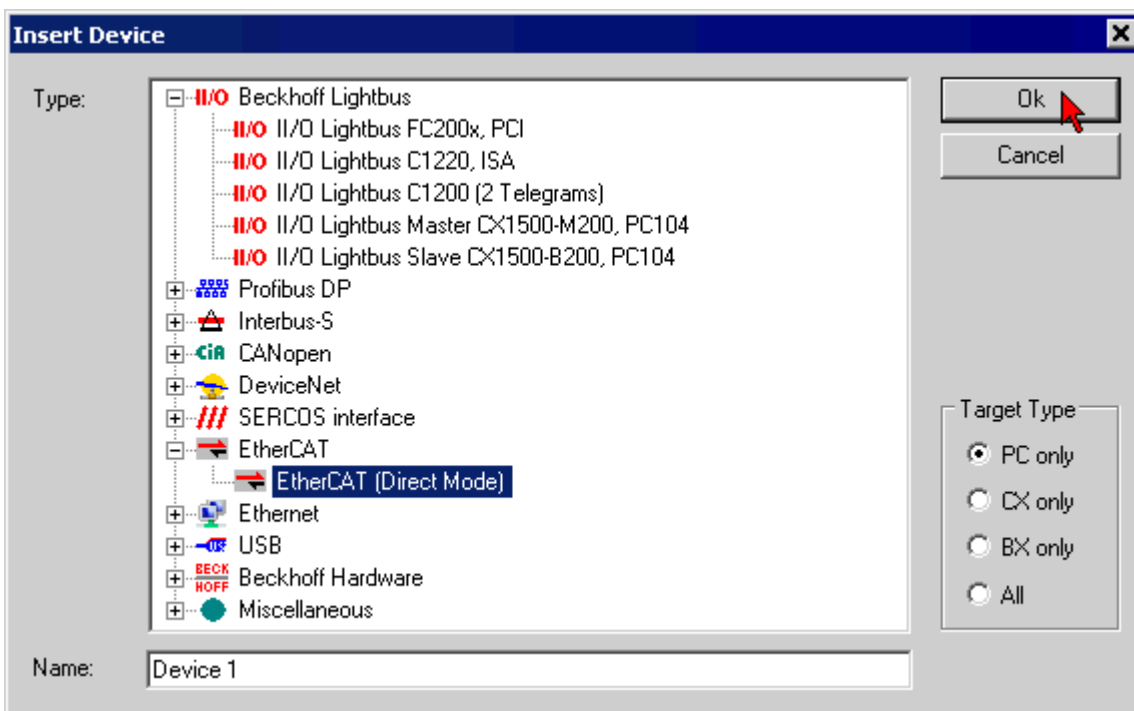

Fig. 24: Selecting the device EtherCAT (Direct Mode)

- Appending a new box (see Fig. *Appending a new box (Device -> right click -> Append Box...)*). In the dialog that follows select an EK1100 system coupler, for example (see Fig. *Selecting a system coupler (e.g. EK1100)*) and confirm with OK.

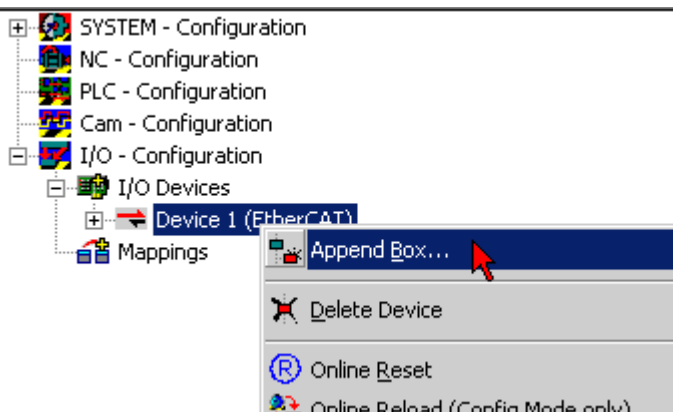

Fig. 25: Appending a new box (Device -> right-click -> Append Box...)

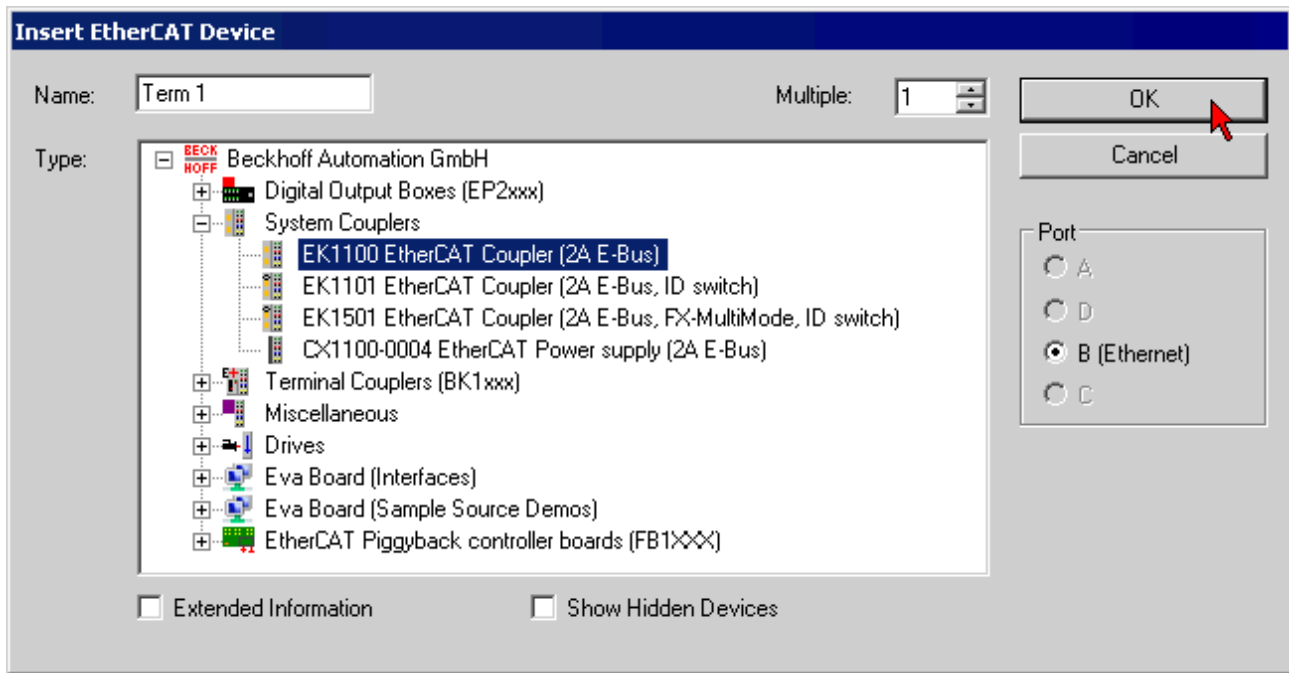

Fig. 26: Selecting a system coupler (e.g. EK1100)

- Appending a new box (see Fig. *Appending a new box (Device -> right click -> Append Box...)*). In the dialog that follows select the EL95xx, (see Fig. *Selecting the terminal, e.g. EL9505*) and confirm with OK.
- The terminal is added in the TwinCAT tree (see Fig. *Terminal in the TwinCAT tree*).

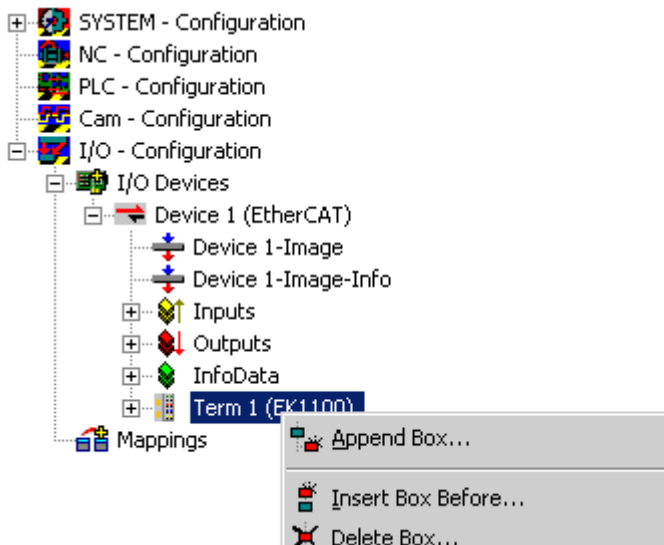

Fig. 27: Appending a new box (Device -> right-click -> Append Box...)

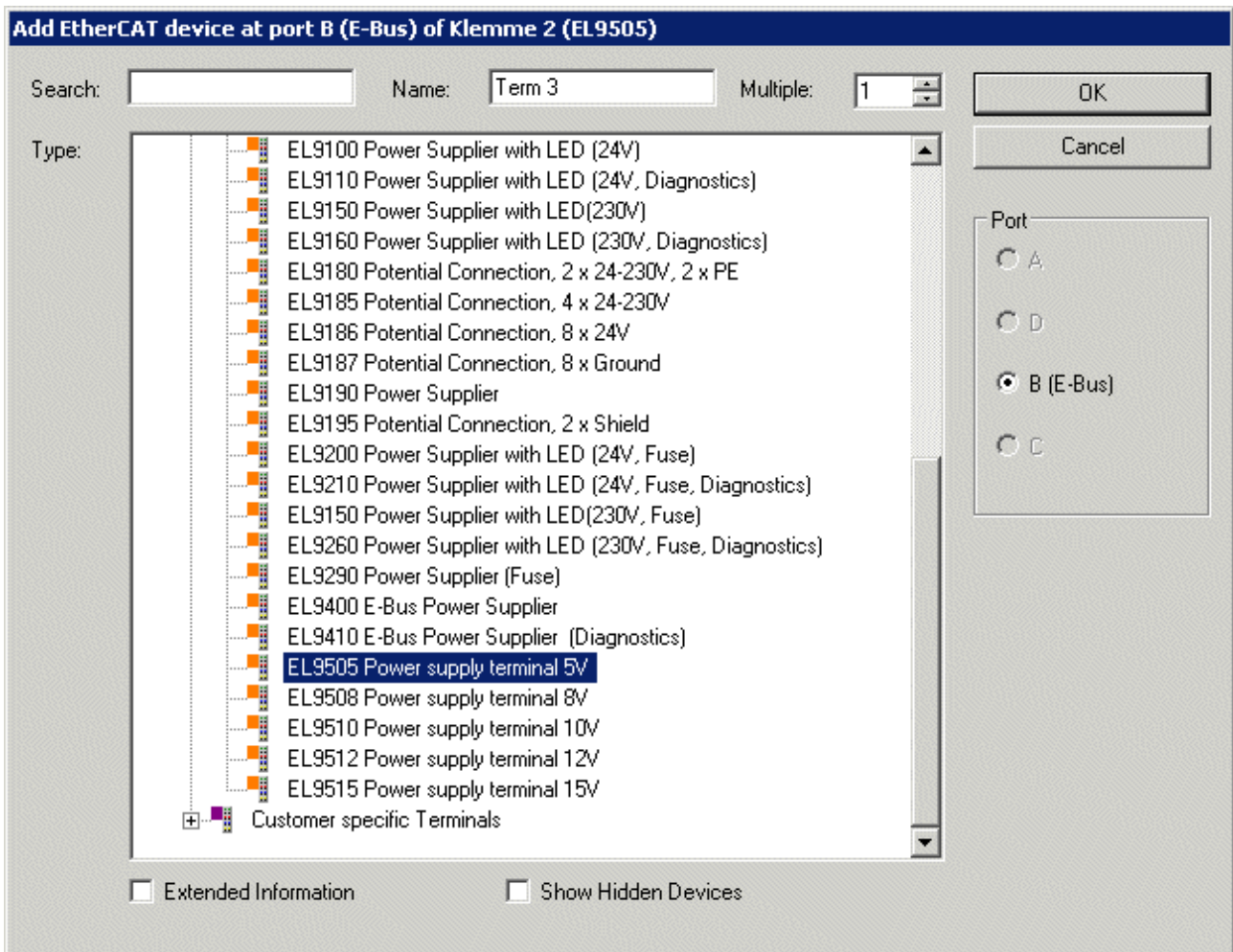

Fig. 28: Selecting the terminal, e.g. EL9505

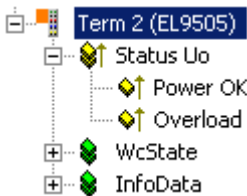

Fig. 29: Terminal in the TwinCAT tree

6.2 Process data

The "Process Data" tab of the EL95xx in the TwinCAT System Manager shows the PDO list of the EL95xx with the corresponding input objects. The width in the process image is 2 bits.

The index 0x1A00 ("Status U₀") contains the two boolean input objects "Power OK" (0x6000:01) for checking the output voltage and "Overload" (0x6000:02) for the overvoltage display.

The screenshot displays the 'Process Data' configuration window for the EL95xx device. It includes the following components:

- General Tab:** Shows 'EtherCAT', 'Process Data', and 'Online' status.
- Sync Manager:** A table with columns SM, Size, Type, and Flags. It shows SM 0, Size 1, Type Inputs.
- PDO List:** A table with columns Index, Size, Name, Flags, SM, and SU. It shows Index 0x1A00, Size 0.2, Name Status U₀, Flags MF, SM 0, and SU 0.
- PDO Assignment (0x1C10):** A list with a checked checkbox for 0x1A00.
- PDO Content (0x1A00):** A table with columns Index, Size, Offs, Name, and Type. It lists:

Index	Size	Offs	Name	Type
0x6000:01	0.1	0.0	Power OK	BOOL
0x6000:02	0.1	0.1	Overload	BOOL
- Download Section:** Contains checkboxes for 'Download', 'PDO Assignment', and 'PDO Configuration'.
- Buttons:** 'Load PDO info from device' and 'Sync Unit Assignment...'.

Fig. 30: EL95xx – "Process Data" tab

7 Appendix

7.1 Firmware compatibility

The terminals of the EL95xx series have no firmware.

7.2 Support and Service

Beckhoff and their partners around the world offer comprehensive support and service, making available fast and competent assistance with all questions related to Beckhoff products and system solutions.

Beckhoff's branch offices and representatives

Please contact your Beckhoff branch office or representative for local support and service on Beckhoff products!

The addresses of Beckhoff's branch offices and representatives round the world can be found on her internet pages: <https://www.beckhoff.com>

You will also find further documentation for Beckhoff components there.

Beckhoff Support

Support offers you comprehensive technical assistance, helping you not only with the application of individual Beckhoff products, but also with other, wide-ranging services:

- support
- design, programming and commissioning of complex automation systems
- and extensive training program for Beckhoff system components

Hotline: +49 5246 963 157
Fax: +49 5246 963 9157
e-mail: support@beckhoff.com

Beckhoff Service

The Beckhoff Service Center supports you in all matters of after-sales service:

- on-site service
- repair service
- spare parts service
- hotline service

Hotline: +49 5246 963 460
Fax: +49 5246 963 479
e-mail: service@beckhoff.com

Beckhoff Headquarters

Beckhoff Automation GmbH & Co. KG

Huelshorstweg 20
33415 Verl
Germany

Phone: +49 5246 963 0
Fax: +49 5246 963 198
e-mail: info@beckhoff.com
web: <https://www.beckhoff.com>

More Information:
www.beckhoff.com/EL9xxx

Beckhoff Automation GmbH & Co. KG
Hülshorstweg 20
33415 Verl
Germany
Phone: +49 5246 9630
info@beckhoff.com
www.beckhoff.com

