

Documentation | EN

# EL34xx

3-phase energy and power measurement terminals





# Table of contents

<b>1</b>	<b>Product overview energy measuring terminals .....</b>	<b>7</b>
<b>2</b>	<b>Foreword .....</b>	<b>8</b>
2.1	Notes on the documentation .....	8
2.2	Safety instructions .....	9
2.3	Guide through documentation .....	10
2.4	Documentation issue status .....	11
2.5	Version identification of EtherCAT devices .....	12
2.5.1	General notes on marking .....	12
2.5.2	Version identification of EL terminals .....	13
2.5.3	Beckhoff Identification Code (BIC) .....	14
2.5.4	Electronic access to the BIC (eBIC) .....	16
<b>3</b>	<b>Product description .....</b>	<b>18</b>
3.1	EL3423   3-phase power measurement terminal, Economy .....	18
3.1.1	EL3423 - Introduction .....	18
3.1.2	EL3423 - Technical data .....	19
3.1.3	EL3423 – LED and connection .....	20
3.2	EL3443   3-phase power measurement terminal with extended functionality .....	22
3.2.1	EL3443 - Introduction .....	22
3.2.2	EL3443 - Technical data .....	23
3.2.3	EL3443 – LED and connection .....	24
3.3	EL3446   6-channel current input terminal 1 A AC/DC for distributed power measurement .....	26
3.3.1	EL3446 - Introduction .....	26
3.3.2	EL3446 - Technical data .....	27
3.3.3	EL3446 – LED and connection .....	28
3.4	EL3453   3-phase power measurement terminal up to 690 V AC with extended functionality .....	30
3.4.1	EL3453 - Introduction .....	30
3.4.2	EL3453 - Technical data .....	31
3.4.3	EL3453 – LED and connection .....	33
3.5	EL3483   3-phase mains monitoring terminal for voltage, frequency and phase .....	36
3.5.1	EL3483 - Introduction .....	36
3.5.2	EL3483 - Technical data .....	37
3.5.3	EL3483 – LED and connection .....	38
3.6	Additional Notes .....	40
3.7	Basic function principles .....	41
3.8	Current transformers .....	49
3.9	Start .....	51
<b>4</b>	<b>Basics communication .....</b>	<b>52</b>
4.1	EtherCAT basics .....	52
4.2	EtherCAT cabling – wire-bound .....	52
4.3	General notes for setting the watchdog .....	53
4.4	EtherCAT State Machine .....	55
4.5	CoE Interface .....	57
4.6	Distributed Clock .....	62

<b>5</b>	<b>Mounting and wiring</b> .....	<b>63</b>
5.1	Instructions for ESD protection .....	63
5.2	Note on Beckhoff calibration certificates .....	64
5.3	UL notice .....	66
5.4	Installation on mounting rails .....	67
5.5	Connection .....	70
5.5.1	Connection system .....	70
5.5.2	Wiring .....	72
5.5.3	Shielding .....	73
5.6	Note - Power supply .....	74
5.7	Installation positions .....	75
5.8	Positioning of passive Terminals .....	77
5.9	Disposal .....	78
<b>6</b>	<b>Commissioning</b> .....	<b>79</b>
6.1	TwinCAT Quick Start .....	79
6.1.1	TwinCAT 2 .....	82
6.1.2	TwinCAT 3 .....	92
6.2	TwinCAT Development Environment .....	106
6.2.1	Installation of the TwinCAT real-time driver .....	106
6.2.2	Notes regarding ESI device description .....	112
6.2.3	TwinCAT ESI Updater .....	116
6.2.4	Distinction between Online and Offline .....	116
6.2.5	OFFLINE configuration creation .....	117
6.2.6	ONLINE configuration creation .....	122
6.2.7	EtherCAT subscriber configuration .....	130
6.2.8	Import/Export of EtherCAT devices with SCI and XTI .....	139
6.3	General Commissioning Instructions for an EtherCAT Slave .....	147
6.4	Process data .....	155
6.4.1	Sync Manager .....	155
6.4.2	Settings .....	163
6.4.3	Timestamp Distributed Clocks .....	168
6.5	Scaling factors .....	169
6.6	Object description and parameterization .....	170
6.6.1	EL3423 .....	170
6.6.2	EL3443-00xx .....	193
6.6.3	EL3446 .....	220
6.6.4	EL3453 .....	234
6.6.5	EL3483-00xx .....	267
<b>7</b>	<b>Application examples</b> .....	<b>278</b>
7.1	Power measurement on motor with 2 or 3 current transformers .....	278
7.2	Power measurement at a machine .....	280
7.3	Power measurement in a single-phase mains network .....	282
7.4	Power measurement at a fieldbus station .....	283
7.5	Power measurement at three-phase motors controlled by a frequency converter .....	284
7.6	Power measurement on loads with phase-to-phase voltages .....	285

7.7	Power measurement including differential current measurement .....	287
7.8	Example program for the evaluation of the EL34xx .....	289
7.9	Example Function Blocks for evaluation using the PLC data types .....	290
<b>8</b>	<b>Appendix .....</b>	<b>295</b>
8.1	TcEventLogger and IO .....	295
8.2	EtherCAT AL Status Codes .....	299
8.3	Firmware compatibility .....	300
8.4	Firmware Update EL/ES/EM/ELM/EP/EPP/ERPxxxx .....	304
8.4.1	Device description ESI file/XML .....	305
8.4.2	Firmware explanation .....	308
8.4.3	Updating controller firmware *.efw .....	309
8.4.4	FPGA firmware *.rbf .....	311
8.4.5	Simultaneous updating of several EtherCAT devices .....	315
8.5	Restoring the delivery state .....	316
8.6	Support and Service .....	318



# 1 Product overview energy measuring terminals

Technical data	Voltage			Current			Error		Time		Example
	#_U	U	U_DC	#_I	I	I_DC	u_U/I	u_X	t_mes	Sync	Application
EL3483	3	480	yes	0	-	-	0.50%	-	200 ms	Mains	Mains Guard
EL3483-0060	3	480	yes	0	-	-	0.30%	-	201 ms	Mains	incl. analog values
EL3423	3	480	yes	3	1	1.5	0.50%	1.00%	≥ 10 s	Mains	Energy MGMT
EL3443	3	480	yes	3	1	1.5	0.30%	0.60%	20 ms	Mains	Power measurement
EL3443-0010	3	480	yes	3	5	5	0.30%	0.60%	20 ms	Mains	
EL3443-0011	3	480	yes	3	0.1	0.15	0.30%	0.60%	20 ms	Mains	
EL3443-0013	3	480	yes	3	333 mV	400 mV	0.30%	0.60%	20 ms	Mains	
EL3443-0020	3	480	yes	3	1	1.5	0.30%	0.60%	20 ms	Mains	
EL3444	0	-	-	4	10	14	-	1.00%	200 ms	Mains	
EL3446	0	-	-	6	1	1.5	-	0.60%	200 ms	Mains	
KL3453	3	690	yes	4	5/1/0.1	no	0.30%	0.60%	10 ms	Mains	Power measurement
EL3453	3	690	yes	4	5/1/0.1	no	0.30%	0.60%	10 ms	Mains	
EL3453-0020	3	690	yes	4	5/1/0.1	no	0.30%	0.60%	10 ms	Mains	
EL3453-0100	3	100	yes	4	5/1/0.1	no	0.30%	0.60%	10 ms	Mains	
EL3773	3	480	yes	3	1	1.5	0.50%	-	≥ 100 μs	simultan	Oscilloscope function
EL3783	3	690	yes	3	5/1	no	0.20%	-	≥ 50 μs	simultan	
EL3783-0100	3	100	yes	3	5/1	no	0.20%	-	≥ 50 μs	simultan	

Technical data	Measuring values										DC timestamp		More	
	Current	Voltage	digital guards	Power Quality Factor (POF)	Frequency	Power(s) / energy(ies)	Fundamental power(s)	ROCOF	THD	Number of harmonics	Zero crossing voltage	Zero crossing current	Special features	Approvals
EL3483	X	X	yes	yes	X	X	X	X	X	X	yes	X		CE, UL
EL3483-0060	X	yes	yes	yes	X	X	X	X	X	X	yes	X		CE, UL
EL3423	X	X	yes	yes	X	yes	X	X	X	X	X	X		CE
EL3443	yes	yes	yes	yes	yes	yes	X	X	yes	40	yes	X		CE, UL
EL3443-0010	yes	yes	yes	yes	yes	yes	X	X	yes	40	yes	X		CE, UL
EL3443-0011	yes	yes	yes	yes	yes	yes	X	X	yes	40	yes	X		CE, UL
EL3443-0013	yes	yes	yes	yes	yes	yes	X	X	yes	40	yes	X	mV- current input	CE, UL
EL3443-0020	yes	yes	yes	yes	yes	yes	X	X	yes	40	yes	X	factory calibrated	CE, UL
EL3444	yes	(yes)	yes	(yes)	(yes)	(yes)	X	X	(yes)	(63)	yes	X	distributed power measurement	CE
EL3446	yes	(yes)	yes	(yes)	(yes)	(yes)	X	X	(yes)	(40)	yes	X		CE, UL
KL3453	yes	yes	yes	yes	yes	yes	yes	yes	yes	63	X	X	K-Bus Interface	CE, UL
EL3453	yes	yes	yes	yes	yes	yes	yes	yes	yes	63	yes	yes		CE, UL
EL3453-0020	yes	yes	yes	yes	yes	yes	yes	yes	yes	63	yes	yes	factory calibrated	CE, UL
EL3453-0100	yes	yes	yes	yes	yes	yes	yes	yes	yes	63	yes	yes		CE, UL
EL3773	yes	yes	(PLC)	(PLC)	(PLC)	(PLC)	(PLC)	(PLC)	(PLC)	(PLC)	(PLC)	(PLC)	Hardware filter configurable	CE, UL
EL3783	yes	yes	(PLC)	(PLC)	(PLC)	(PLC)	(PLC)	(PLC)	(PLC)	(PLC)	(PLC)	(PLC)	auto. meas. range switching	CE, UL
EL3783-0100	yes	yes	(PLC)	(PLC)	(PLC)	(PLC)	(PLC)	(PLC)	(PLC)	(PLC)	(PLC)	(PLC)		CE, UL

## 2 Foreword

### 2.1 Notes on the documentation

#### Intended audience

This description is only intended for the use of trained specialists in control and automation engineering who are familiar with the applicable national standards.

It is essential that the documentation and the following notes and explanations are followed when installing and commissioning these components.

The qualified personnel is obliged to always use the currently valid documentation.

The responsible staff must ensure that the application or use of the products described satisfy all the requirements for safety, including all the relevant laws, regulations, guidelines and standards.

#### Disclaimer

The documentation has been prepared with care. The products described are, however, constantly under development.

We reserve the right to revise and change the documentation at any time and without prior announcement.

No claims for the modification of products that have already been supplied may be made on the basis of the data, diagrams and descriptions in this documentation.

#### Trademarks

Beckhoff®, TwinCAT®, TwinCAT/BSD®, TC/BSD®, EtherCAT®, EtherCAT G®, EtherCAT G10®, EtherCAT P®, Safety over EtherCAT®, TwinSAFE®, XFC®, XTS® and XPlanar® are registered trademarks of and licensed by Beckhoff Automation GmbH. Other designations used in this publication may be trademarks whose use by third parties for their own purposes could violate the rights of the owners.

#### Patent Pending

The EtherCAT Technology is covered, including but not limited to the following patent applications and patents: EP1590927, EP1789857, EP1456722, EP2137893, DE102015105702 with corresponding applications or registrations in various other countries.



EtherCAT® is registered trademark and patented technology, licensed by Beckhoff Automation GmbH, Germany.

#### Copyright

© Beckhoff Automation GmbH & Co. KG, Germany.

The reproduction, distribution and utilization of this document as well as the communication of its contents to others without express authorization are prohibited.

Offenders will be held liable for the payment of damages. All rights reserved in the event of the grant of a patent, utility model or design.



## 2.2 Safety instructions

### Safety regulations

Please note the following safety instructions and explanations!  
Product-specific safety instructions can be found on following pages or in the areas mounting, wiring, commissioning etc.

### Exclusion of liability

All the components are supplied in particular hardware and software configurations appropriate for the application. Modifications to hardware or software configurations other than those described in the documentation are not permitted, and nullify the liability of Beckhoff Automation GmbH & Co. KG.

### Personnel qualification

This description is only intended for trained specialists in control, automation and drive engineering who are familiar with the applicable national standards.

### Signal words

The signal words used in the documentation are classified below. In order to prevent injury and damage to persons and property, read and follow the safety and warning notices.

#### Personal injury warnings

**⚠ DANGER**

Hazard with high risk of death or serious injury.

**⚠ WARNING**

Hazard with medium risk of death or serious injury.

**⚠ CAUTION**

There is a low-risk hazard that could result in medium or minor injury.

#### Warning of damage to property or environment

**NOTICE**

The environment, equipment, or data may be damaged.

#### Information on handling the product



This information includes, for example:  
recommendations for action, assistance or further information on the product.

## 2.3 Guide through documentation

### NOTICE



#### Further components of documentation

This documentation describes device-specific content. It is part of the modular documentation concept for Beckhoff I/O components. For the use and safe operation of the device / devices described in this documentation, additional cross-product descriptions are required, which can be found in the following table.

Title	Description
<b>EtherCAT System Documentation</b> ( <a href="#">PDF</a> )	<ul style="list-style-type: none"> <li>• System overview</li> <li>• EtherCAT basics</li> <li>• Cable redundancy</li> <li>• Hot Connect</li> <li>• EtherCAT devices configuration</li> </ul>
<b>I/O Analog Manual</b> ( <a href="#">PDF</a> )	Notes on I/O components with analog in and outputs
<b>Infrastructure for EtherCAT/Ethernet</b> ( <a href="#">PDF</a> )	Technical recommendations and notes for design, implementation and testing
<b>Software Declarations I/O</b> ( <a href="#">PDF</a> )	Open source software declarations for Beckhoff I/O components

The documentations can be viewed at and downloaded from the Beckhoff website ([www.beckhoff.com](http://www.beckhoff.com)) via:

- the “Documentation and Download” area of the respective product page,
- the [Download finder](#),
- the [Beckhoff Information System](#).

## 2.4 Documentation issue status

Version	Comment
2.9	<ul style="list-style-type: none"> <li>• Chapter "Technical data" updated</li> <li>• Chapter "Additional notes" updated</li> <li>• Update revision status</li> <li>• Structural update</li> </ul>
2.8	<ul style="list-style-type: none"> <li>• EL3443-0020 and EL3453-0020 amended</li> <li>• Chapter "Object description and parameterization" updated</li> <li>• Chapter "Technical data" updated</li> <li>• Chapter "Process data" updated</li> <li>• Structural update</li> </ul>
2.7	<ul style="list-style-type: none"> <li>• Chapter "LED and connection" updated</li> <li>• Chapter "Process data" updated</li> <li>• Chapter "Technical data" updated</li> <li>• Chapter "Object description and parameterization" updated</li> <li>• Update chapter "UL notes"</li> <li>• Revision status updated</li> <li>• Structural update</li> </ul>
2.6	<ul style="list-style-type: none"> <li>• Chapter "Technical data" updated</li> <li>• Structural update</li> </ul>
2.5	<ul style="list-style-type: none"> <li>• Chapter "Technical data" updated</li> <li>• Structural update</li> <li>• Revision status updated</li> </ul>
2.4	<ul style="list-style-type: none"> <li>• Chapter "Technical data" updated</li> <li>• Chapter "Process data" updated</li> <li>• Structural update</li> <li>• Revision status updated</li> </ul>
2.3	<ul style="list-style-type: none"> <li>• Chapter "Sample programs" updated</li> <li>• Structural update</li> </ul>
2.2	<ul style="list-style-type: none"> <li>• Chapter "Technical data" updated</li> <li>• Chapter "Power Quality Factor" added</li> <li>• Chapter "Long-term use" added</li> <li>• Structural update</li> <li>• Revision status updated</li> </ul>
2.1	<ul style="list-style-type: none"> <li>• Chapter "Technical data" updated</li> <li>• Chapter "LED and connection" updated</li> <li>• Chapter "Object description and parameterization" updated</li> <li>• Structural update</li> <li>• Revision status updated</li> </ul>
2.0	<ul style="list-style-type: none"> <li>• Chapter "Application examples" updated</li> <li>• Structural update</li> <li>• Revision status updated</li> </ul>
0.1 – 1.9	*archived*

## 2.5 Version identification of EtherCAT devices

### 2.5.1 General notes on marking

#### Designation

A Beckhoff EtherCAT device has a 14-digit designation, made up of

- family key
- type
- version
- revision

Example	Family	Type	Version	Revision
EL3314-0000-0016	EL terminal 12 mm, non-pluggable connection level	3314 4-channel thermocouple terminal	0000 basic type	0016
ES3602-0010-0017	ES terminal 12 mm, pluggable connection level	3602 2-channel voltage measurement	0010 high-precision version	0017
CU2008-0000-0000	CU device	2008 8-port fast ethernet switch	0000 basic type	0000

#### Notes

- The elements mentioned above result in the **technical designation**. EL3314-0000-0016 is used in the example below.
- EL3314-0000 is the order identifier, in the case of "-0000" usually abbreviated to EL3314. "-0016" is the EtherCAT revision.
- The **order identifier** is made up of
  - family key (EL, EP, CU, ES, KL, CX, etc.)
  - type (3314)
  - version (-0000)
- The **revision** -0016 shows the technical progress, such as the extension of features with regard to the EtherCAT communication, and is managed by Beckhoff.  
In principle, a device with a higher revision can replace a device with a lower revision, unless specified otherwise, e.g. in the documentation.  
Associated and synonymous with each revision there is usually a description (ESI, EtherCAT Slave Information) in the form of an XML file, which is available for download from the Beckhoff web site.  
From 2014/01 the revision is shown on the outside of the IP20 terminals, see Fig. "EL5021 EL terminal, standard IP20 IO device with batch number and revision ID (since 2014/01)".
- The type, version and revision are read as decimal numbers, even if they are technically saved in hexadecimal.

## 2.5.2 Version identification of EL terminals

The serial number/ data code for Beckhoff IO devices is usually the 8-digit number printed on the device or on a sticker. The serial number indicates the configuration in delivery state and therefore refers to a whole production batch, without distinguishing the individual modules of a batch.

Structure of the serial number: **KK YY FF HH**

KK - week of production (CW, calendar week)

YY - year of production

FF - firmware version

HH - hardware version

Example with serial number 12 06 3A 02:

12 - production week 12

06 - production year 2006

3A - firmware version 3A

02 - hardware version 02



Fig. 1: EL2872 with revision 0022 and serial number 01200815

### 2.5.3 Beckhoff Identification Code (BIC)

The Beckhoff Identification Code (BIC) is increasingly being applied to Beckhoff products to uniquely identify the product. The BIC is represented as a Data Matrix Code (DMC, code scheme ECC200), the content is based on the ANSI standard MH10.8.2-2016.

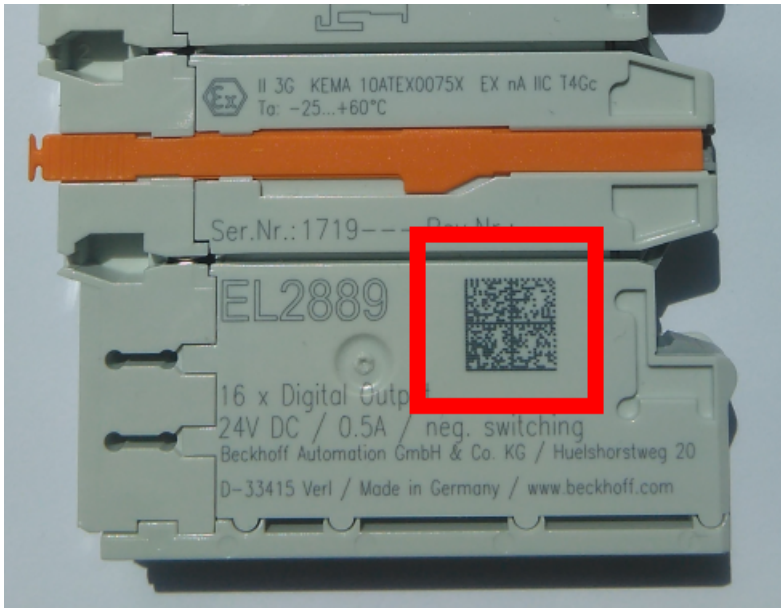

Fig. 2: BIC as data matrix code (DMC, code scheme ECC200)

The BIC will be introduced step by step across all product groups.

Depending on the product, it can be found in the following places:

- on the packaging unit
- directly on the product (if space suffices)
- on the packaging unit and the product

The BIC is machine-readable and contains information that can also be used by the customer for handling and product management.

Each piece of information can be uniquely identified using the so-called data identifier (ANSI MH10.8.2-2016). The data identifier is followed by a character string. Both together have a maximum length according to the table below. If the information is shorter, spaces are added to it.

Following information is possible, positions 1 to 4 are always present, the other according to need of production:

Position	Type of information	Explanation	Data identifier	Number of digits incl. data identifier	Example
1	Beckhoff order number	<b>Beckhoff order number</b>	1P	8	<b>1P</b> 072222
2	Beckhoff Traceability Number (BTN)	<b>Unique serial number, see note below</b>	SBTN	12	<b>SBTN</b> k4p562d7
3	Article description	<b>Beckhoff article description, e.g. EL1008</b>	1K	32	<b>1K</b> EL1809
4	Quantity	<b>Quantity in packaging unit, e.g. 1, 10, etc.</b>	Q	6	<b>Q1</b>
5	Batch number	Optional: Year and week of production	2P	14	<b>2P</b> 401503180016
6	ID/serial number	Optional: Present-day serial number system, e.g. with safety products	51S	12	<b>51S</b> 678294
7	Variant number	Optional: Product variant number on the basis of standard products	30P	32	<b>30P</b> F971, 2*K183
...					

Further types of information and data identifiers are used by Beckhoff and serve internal processes.

**Structure of the BIC**

Example of composite information from positions 1 to 4 and with the above given example value on position 6. The data identifiers are highlighted in bold font:

**1P**072222**SBTN**k4p562d7**1K**EL1809 **Q1** **51S**678294

Accordingly as DMC:



Fig. 3: Example DMC **1P**072222**SBTN**k4p562d7**1K**EL1809 **Q1** **51S**678294

**BTN**

An important component of the BIC is the Beckhoff Traceability Number (BTN, position 2). The BTN is a unique serial number consisting of eight characters that will replace all other serial number systems at Beckhoff in the long term (e.g. batch designations on IO components, previous serial number range for safety products, etc.). The BTN will also be introduced step by step, so it may happen that the BTN is not yet coded in the BIC.

**NOTICE**

This information has been carefully prepared. However, the procedure described is constantly being further developed. We reserve the right to revise and change procedures and documentation at any time and without prior notice. No claims for changes can be made from the information, illustrations and descriptions in this information.

## 2.5.4 Electronic access to the BIC (eBIC)

### Electronic BIC (eBIC)

The Beckhoff Identification Code (BIC) is applied to the outside of Beckhoff products in a visible place. If possible, it should also be electronically readable.

The interface that the product can be electronically addressed by is crucial for the electronic readout.

### K-bus devices (IP20, IP67)

Currently, no electronic storage or readout is planned for these devices.

### EtherCAT devices (IP20, IP67)

All Beckhoff EtherCAT devices have an ESI-EEPROM which contains the EtherCAT identity with the revision number. The EtherCAT slave information, also colloquially known as the ESI/XML configuration file for the EtherCAT master, is stored in it. See the corresponding chapter in the EtherCAT system manual ([Link](#)) for the relationships.

Beckhoff also stores the eBIC in the ESI-EEPROM. The eBIC was introduced into Beckhoff IO production (terminals, box modules) in 2020; as of 2023, implementation is largely complete.

The user can electronically access the eBIC (if present) as follows:

- With all EtherCAT devices, the EtherCAT master (TwinCAT) can read the eBIC from the ESI-EEPROM
  - From TwinCAT 3.1 build 4024.11, the eBIC can be displayed in the online view.
  - To do this, check the "Show Beckhoff Identification Code (BIC)" checkbox under EtherCAT → Advanced Settings → Diagnostics:

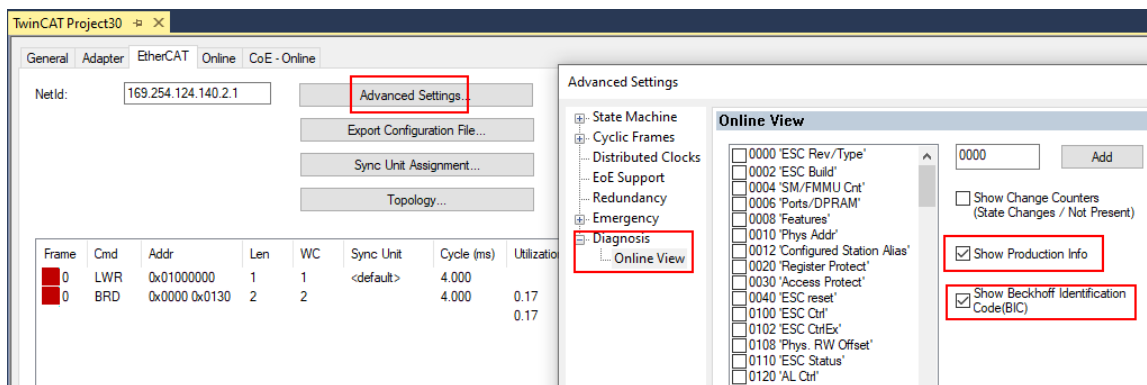

- The BTN and its contents are then displayed:

No	Addr	Name	State	CRC	Fw	Hw	Production Data	ItemNo	BTN	Description	Quantity	BatchNo	SerialNo
1	1001	Term 1 (EK1100)	OP	0.0	0	0	---						
2	1002	Term 2 (EL1018)	OP	0.0	0	0	2020 KW36 Fr	072222	k4p562d7	EL1809	1		678294
3	1003	Term 3 (EL3204)	OP	0.0	7	6	2012 KW24 Sa						
4	1004	Term 4 (EL2004)	OP	0.0	0	0	---	072223	k4p562d7	EL2004	1		678295
5	1005	Term 5 (EL1008)	OP	0.0	0	0	---						
6	1006	Term 6 (EL2008)	OP	0.0	0	12	2014 KW14 Mo						
7	1007	Term 7 (EK1110)	OP	0	1	8	2012 KW25 Mo						

- Note: As shown in the figure, the production data HW version, FW version, and production date, which have been programmed since 2012, can also be displayed with "Show production info".
- Access from the PLC: From TwinCAT 3.1. build 4024.24, the functions *FB\_EcReadBIC* and *FB\_EcReadBTN* for reading into the PLC are available in the *Tc2\_EtherCAT* library from v3.3.19.0.
- EtherCAT devices with a CoE directory may also have the object 0x10E2:01 to display their own eBIC, which can also be easily accessed by the PLC:



- The device must be in PREOP/SAFEOP/OP for access:

Index	Name	Flags	Value
1000	Device type	RO	0x015E1389 (22942601)
1008	Device name	RO	ELM3704-0000
1009	Hardware version	RO	00
100A	Software version	RO	01
100B	Bootloader version	RO	J0.1.27.0
1011:0	Restore default parameters	RO	> 1 <
1018:0	Identity	RO	> 4 <
10E2:0	Manufacturer-specific Identification C...	RO	> 1 <
10E2:01	SubIndex 001	RO	1P158442SBTN0008jckp1KELM3704 Q1 2P482001000016
10F0:0	Backup parameter handling	RO	> 1 <
10F3:0	Diagnosis History	RO	> 21 <
10F8	Actual Time Stamp	RO	0x170bfb277e

- The object 0x10E2 will be preferentially introduced into stock products in the course of necessary firmware revision.
- From TwinCAT 3.1. build 4024.24, the functions *FB\_EcCoEReadBIC* and *FB\_EcCoEReadBTN* for reading into the PLC are available in the *Tc2\_EtherCAT* library from v3.3.19.0
- The following auxiliary functions are available for processing the BIC/BTN data in the PLC in *Tc2\_Uilities* as of TwinCAT 3.1 build 4024.24
  - *F\_SplitBIC*: The function splits the Beckhoff Identification Code (BIC) *sBICValue* into its components using known identifiers and returns the recognized substrings in the *ST\_SplittedBIC* structure as a return value
  - *BIC\_TO\_BTN*: The function extracts the BTN from the BIC and returns it as a return value
- Note: If there is further electronic processing, the BTN is to be handled as a string(8); the identifier "SBTN" is not part of the BTN.
- Technical background  
 The new BIC information is written as an additional category in the ESI-EEPROM during device production. The structure of the ESI content is largely dictated by the ETG specifications, therefore the additional vendor-specific content is stored using a category in accordance with the ETG.2010. ID 03 tells all EtherCAT masters that they may not overwrite these data in the event of an update or restore the data after an ESI update.  
 The structure follows the content of the BIC, see here. The EEPROM therefore requires approx. 50..200 bytes of memory.
- Special cases
  - If multiple hierarchically arranged ESCs are installed in a device, only the top-level ESC carries the eBIC information.
  - If multiple non-hierarchically arranged ESCs are installed in a device, all ESCs carry the eBIC information.
  - If the device consists of several sub-devices which each have their own identity, but only the top-level device is accessible via EtherCAT, the eBIC of the top-level device is located in the CoE object directory 0x10E2:01 and the eBICs of the sub-devices follow in 0x10E2:nn.

**PROFIBUS; PROFINET, and DeviceNet devices**

Currently, no electronic storage or readout is planned for these devices.

## 3 Product description

### 3.1 EL3423 | 3-phase power measurement terminal, Economy

#### 3.1.1 EL3423 - Introduction

##### EL3423 | 3-phase power measurement terminal, Economy

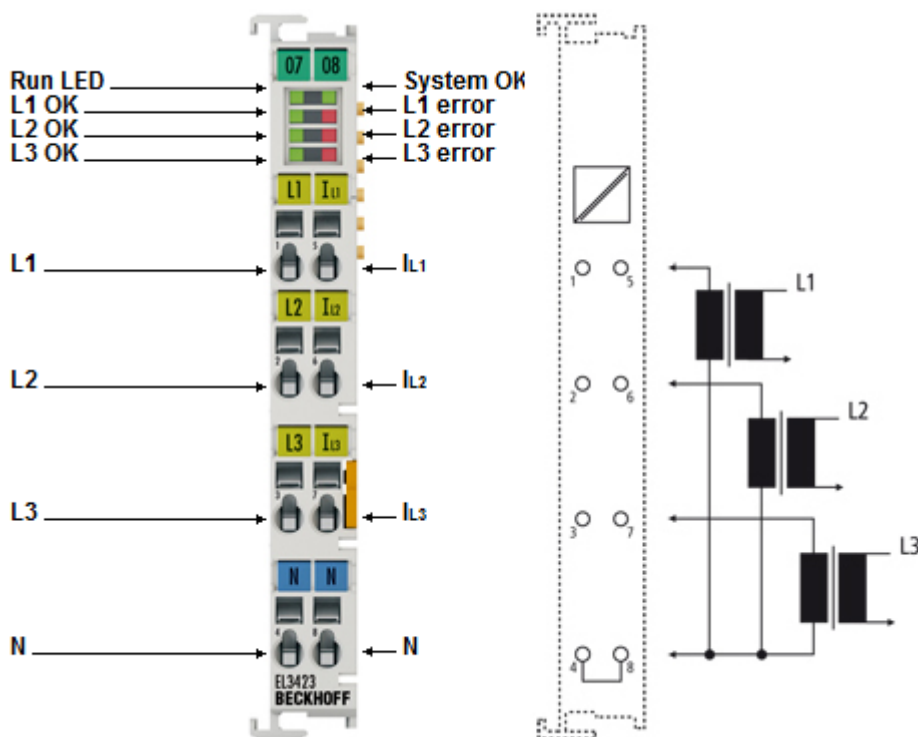

Fig. 4: EL3423

The EL3423 EtherCAT Terminal enables measurement of relevant data for an efficient energy management system. The voltage is measured internally via direct connection of L1, L2, L3 and N.

The current of the three phases L1, L2 and L3 is fed in via simple current transformers (e.g. the Beckhoff SCT series). The measured energy values are available separately as generated and delivered values. In the EL3423 version, the active power and the energy consumption for each phase are calculated.

In addition, an internally calculated power quality factor provides information about the quality of the monitored power supply. The EL3423 offers basic functionality for grid analysis and energy management.

#### Quick links

- [Technical data \[► 19\]](#)
- [Basic function principles \[► 41\]](#)
- [Object description and parameterization \[► 170\]](#)
- [Process data \[► 155\]](#)
- [Application examples \[► 278\]](#)

### 3.1.2 EL3423 - Technical data

#### EL3423

Technical data	EL3423
Number of inputs	3 x current, 3 x voltage
Technology	3-phase power measurement
Oversampling factor	–
Internal sampling rate	approx. 9.7 kSps (per channel)
Sampling type	simultaneously across all channels
Ground reference	single ended
Distributed clocks	–
Update interval	>10 s adjustable
Measured values	Energy, power, power quality factor
Measuring voltage	max. 480 V AC 3~ (UL <sub>x</sub> -N: max. 277 V AC; max. 240 V DC)
Measuring current	max. 1 A (AC/DC), via <a href="#">measuring transformer [▶ 40]</a> x A/1 A
Measuring error	0.5% relative to full scale value (U/I), 1% calculated values
Measuring procedure	true RMS
Update time	mains-synchronous
Frequency range	0 (direct current) and 12 ... 400 Hz
Electrical isolation	2500 V
Current consumption Power contacts	–
Current consumption via E-bus	120 mA typ.
Special features	single-phase operation possible, mains monitoring functionality
Configuration	via TwinCAT System Manager
Weight	approx. 75 g
Dimensions (W x H x D)	approx. 15 mm x 100 mm x 70 mm (width aligned: 12 mm)
<a href="#">Installation [▶ 63]</a>	on 35 mm mounting rail, conforms to EN 60715
Permissible ambient temperature range during operation	-25 °C ... +60 °C (extended temperature range)
Permissible ambient temperature range during storage	-40 °C ... +85 °C
Relative humidity	95 % no condensation
Vibration/shock resistance	conforms to EN 60068-2-6 / EN 60068-2-27
EMC immunity/emission	conforms to EN 61000-6-2 / EN 61000-6-4
Protection rating/installation position	IP20/any
Marking/Approval <sup>*)</sup>	CE, EAC, UKCA <a href="#">cULus [▶ 66]</a>

\*) Real applicable approvals/markings see type plate on the side (product marking).

### 3.1.3 EL3423 – LED and connection

**⚠ WARNING**

**Caution: Risk of injury through electric shock!**

If you do not connect the terminal point N with the neutral conductor of your mains supply (e.g. when using for current measurement only), terminal point N should be grounded, in order to avoid dangerous overvoltages in the event of a current transformer fault!

**⚠ WARNING**

**Caution: Risk of injury through electric shock!**

Please note that many vendors do not permit their current transformers to be operated in no-load mode! Connect the terminal to the secondary winding of the current transformers before using the current transformer!

**EL3423 - LEDs and connection**

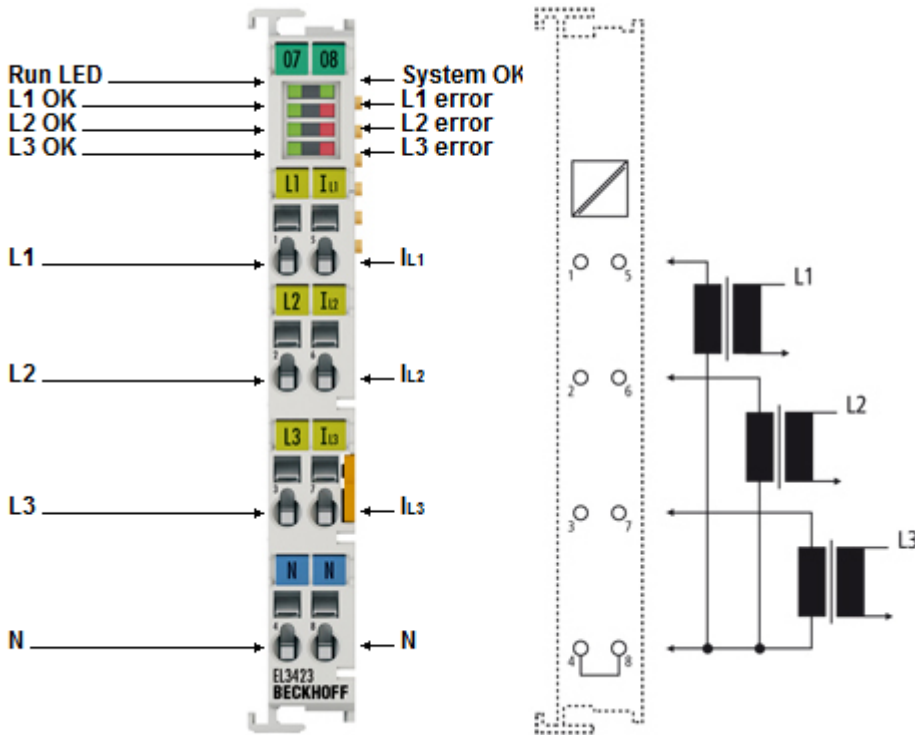





Fig. 5: EL3423 LEDs and connection

Terminal point		Description	Comment
Name	No.		
L1	1	Phase L1	Connections for the voltage measurement Note the <a href="#">Warnings [▶ 20]</a> above " Caution: Risk of electric shock! "
L2	2	Phase L2	
L3	3	Phase L3	
N	4	Neutral conductor N (internally connected to terminal point 8)	
$I_{L1}$	5	Consumer at phase L1	Connections for the current transformers. Note the <a href="#">Warnings [▶ 20]</a> above " Caution: Risk of electric shock! "
$I_{L2}$	6	Consumer at phase L2	
$I_{L3}$	7	Consumer at phase L3	
N	8	Neutral conductor N (internally connected to terminal point 4)	

LED	Color	Meaning	
RUN	green	This LED indicates the terminal's operating state:	
		off	State of the EtherCAT State Machine [▶ 55]: <b>INIT</b> = initialization of the terminal
		flashing rapidly	State of the EtherCAT State Machine [▶ 55]: <b>BOOTSTRAP</b> = function for terminal <a href="#">firmware updates</a> [▶ 304]
		flashing	State of the EtherCAT State Machine [▶ 55]: <b>PREOP</b> = function for mailbox communication and different default settings set
		Single flash	State of the EtherCAT State Machine [▶ 55]: <b>SAFEOP</b> = verification of the <a href="#">Sync Manager</a> [▶ 131] channels and the distributed clocks. Outputs remain in safe state.
		on	State of the EtherCAT State Machine [▶ 55]: <b>OP</b> = normal operating state; mailbox and process data communication is possible
System OK	green	on System OK, (the "SystemOK"-LED is the representation of the "System State" bit, <a href="#">F600:01</a> [▶ 176])	
L1 - L3 OK	green	on Voltage in the normal range  L1   L2   L3	
		flashes Voltage in the critical range (warning threshold exceeded)  L1   L2   L3	
		off Voltage in prohibited range (error threshold exceeded)	
L1 - L3 Error	red	on  L1   L2   L3	

## 3.2 EL3443 | 3-phase power measurement terminal with extended functionality

### 3.2.1 EL3443 - Introduction

#### EL3443 | 3-phase power measurement terminal with extended functionality

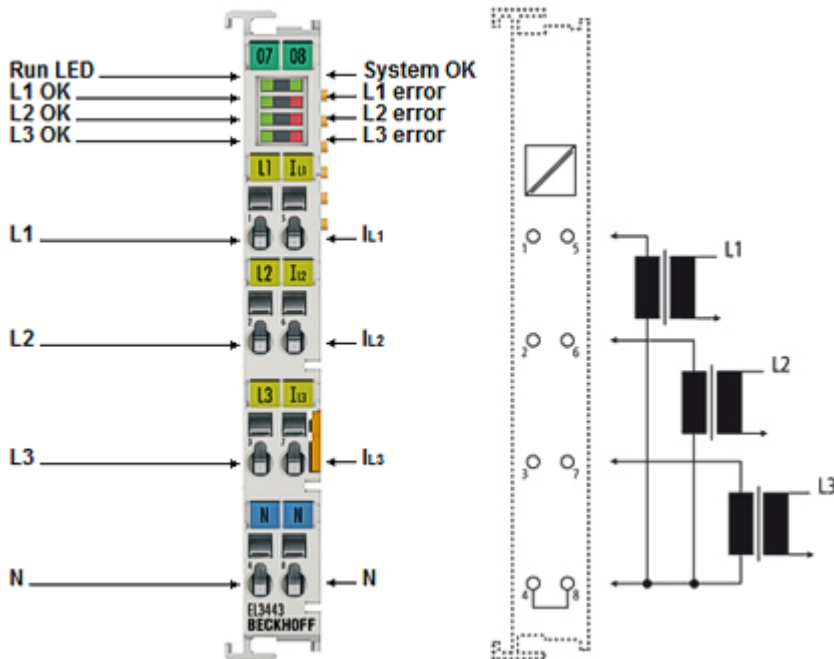

Fig. 6: EL3443

The EL3443 EtherCAT Terminal enables measurement of all relevant electrical data of the mains supply and performs simple pre-evaluations. The voltage is measured via the direct connection of L1, L2, L3 and N. The current of the three phases L1, L2 and L3 is fed in via simple current transformers (e.g. the Beckhoff [SCT](#) series).

All measured currents and voltages are available as RMS values. In the EL3443 version, the active power and the energy consumption for each phase are calculated.

The RMS values of voltage  $U$  and current  $I$  as well as the active power  $P$ , apparent power  $S$ , reactive power  $Q$ , frequency  $f$ , power factor  $PF$  and  $\cos \varphi$  beside phase shift angle and harmonic are available.

The EL3443 offers options for comprehensive grid analysis and energy management.

Versions:

- EL3443-0000: Version with direct current measurement up to 1 A
- EL3443-0010: Version with direct current measurement up to 5 A
- EL3443-0011: Version with direct current measurement 100 mA
- EL3443-0013: Version with direct voltage measurement 333 mV
- EL3443-0020: Version with direct current measurement up to 1 A, factory calibrated with [calibration certificate](#) [[▶ 64](#)]

#### Quick links

- [Technical data](#) [[▶ 23](#)]
- [Basic function principles](#) [[▶ 41](#)]
- [Object description and parameterization](#) [[▶ 170](#)]
- [Process data](#) [[▶ 155](#)]
- [Application examples](#) [[▶ 278](#)]

### 3.2.2 EL3443 - Technical data

#### EL3443-00xx

Technical data	EL3443	EL3443-0010	EL3443-0011	EL3443-0013	EL3443-0020
Number of inputs	3 x current, 3 x voltage				
Special feature	-				factory calibrated with <a href="#">calibration certificate</a> [► 64]
Technology	3-phase power measurement				
Oversampling factor	-				
Internal sampling rate	approx. 9.7 kSps (per channel)				
Sampling type	simultaneously across all channels				
Ground reference	single ended				
Distributed clocks	Optional (for determining the zero crossing time)				
Update interval	one mains period (20 ms at 50 Hz)				
Measured values	Current, voltage, active power, reactive power, apparent power, active energy, reactive energy, apparent energy, $\cos \varphi$ , frequency, THD, harmonics (up to 40th harmonic), power quality factor				
Measuring voltage	max. 480 V AC 3~ (UL <sub>x</sub> -N: max. 277 V AC; max. 240 V DC)				
Measuring current	max. 1 A (AC/DC), via <a href="#">measuring transformer</a> [► 40] x A/1 A	max. 5 A (AC/DC), via <a href="#">measuring transformer</a> [► 40] x A/5 A	max. 100 mA (AC/DC), via <a href="#">measuring transformer</a> [► 40] x A/100 mA	max. 333 mV (AC/DC), via <a href="#">measuring transformer</a> [► 40] x A/333 mV	max. 1 A (AC/DC), via <a href="#">measuring transformer</a> [► 40] x A/1 A
Measuring error	0.3% relative to the full scale value (U/I), 0.6% calculated values (see documentation)				
Measuring procedure	true RMS				
Frequency range	0 (direct current) and 12 ... 400 Hz				
Cut-off frequency	3000 Hz				
Electrical isolation	2500 V				
Update time	mains-synchronous				
Current consumption Power contacts	-				
Current consumption via E-bus	120 mA typ.				
Special features	Single-phase operation possible, mains monitoring functionality, precise voltage zero crossing determination				
Weight	approx. 75 g				
Dimensions (W x H x D)	approx. 15 mm x 100 mm x 70 mm (width aligned: 12 mm)				
<a href="#">Installation</a> [► 63]	on 35 mm mounting rail, conforms to EN 60715				
Permissible ambient temperature range during operation	-25 °C ... +60 °C (extended temperature range)		0 °C ... +55 °C		-25 °C ... +60 °C (extended temperature range)
Permissible ambient temperature range during storage	-40 °C ... +85 °C		-25 °C ... +85 °C		-40 °C ... +85 °C
Relative humidity	95% no condensation				
Vibration/shock resistance	conforms to EN 60068-2-6 / EN 60068-2-27				
EMC immunity/emission	conforms to EN 61000-6-2 / EN 61000-6-4				
Protection rating/ installation position	IP20/any				
Marking/Approval <sup>1)</sup>	CE, EAC, UKCA <a href="#">cULus</a> [► 66],				

\*) Real applicable approvals/markings see type plate on the side (product marking).

### 3.2.3 EL3443 – LED and connection

**⚠ WARNING**

**Caution: Risk of injury through electric shock!**

If you do not connect the terminal point N with the neutral conductor of your mains supply (e.g. when using for current measurement only), terminal point N should be grounded, in order to avoid dangerous overvoltages in the event of a current transformer fault!

**⚠ WARNING**

**Caution: Risk of injury through electric shock!**

Please note that many vendors do not permit their current transformers to be operated in no-load mode! Connect the terminal to the secondary winding of the current transformers before using the current transformer!

**EL3443 - LEDs and connection**

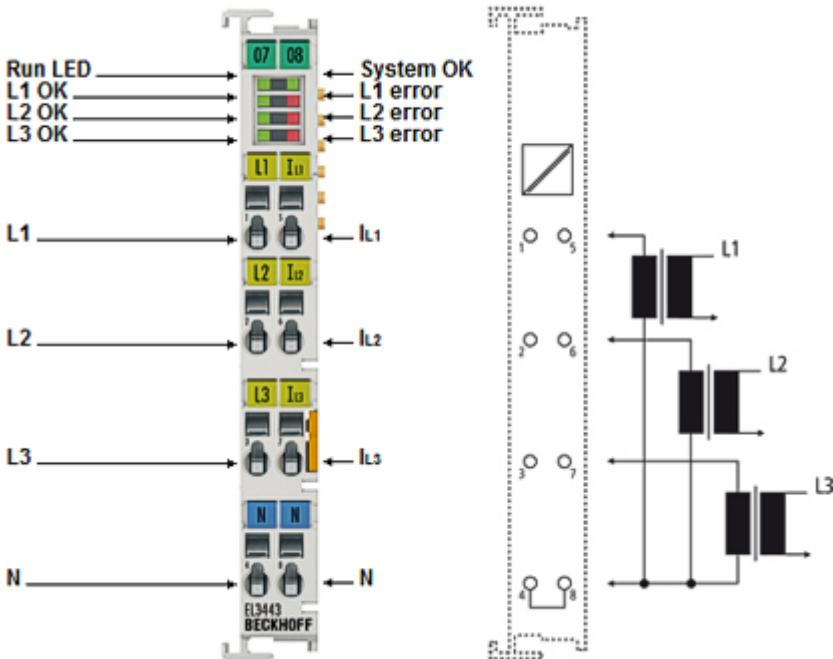





Fig. 7: EL3443 LEDs and connection

Terminal point		Description	Comment
Name	No.		
L1	1	Phase L1	Connections for the voltage measurement Note the <a href="#">Warnings [▶ 24]</a> above " Caution: Risk of electric shock! "
L2	2	Phase L2	
L3	3	Phase L3	
N	4	Neutral conductor N (internally connected to terminal point 8)	
$I_{L1}$	5	Consumer at phase L1	Connections for the current transformers. Note the <a href="#">Warnings [▶ 24]</a> above " Caution: Risk of electric shock! "
$I_{L2}$	6	Consumer at phase L2	
$I_{L3}$	7	Consumer at phase L3	
N	8	Neutral conductor N (internally connected to terminal point 4)	



LED	Color	Meaning	
RUN	green	This LED indicates the terminal's operating state:	
		off	State of the EtherCAT State Machine [▶ 55]: <b>INIT</b> = initialization of the terminal
		flashing rapidly	State of the EtherCAT State Machine [▶ 55]: <b>BOOTSTRAP</b> = function for terminal <a href="#">firmware updates</a> [▶ 304]
		flashing	State of the EtherCAT State Machine [▶ 55]: <b>PREOP</b> = function for mailbox communication and different default settings set
		Single flash	State of the EtherCAT State Machine [▶ 55]: <b>SAFEOP</b> = verification of the <a href="#">Sync Manager</a> [▶ 131] channels and the distributed clocks. Outputs remain in safe state.
		on	State of the EtherCAT State Machine [▶ 55]: <b>OP</b> = normal operating state; mailbox and process data communication is possible
System OK	green	on System OK, (the "SystemOK"-LED is the representation of the "System State" bit, F600:01 [▶ 176])	
L1 - L3 OK	green	on Voltage in the normal range  L1 L2 L3	
		flashes Voltage in the critical range (warning threshold exceeded)  L1 L2 L3	
		off Voltage in prohibited range (error threshold exceeded)	
L1 - L3 Error	red	on  L1 L2 L3	

## 3.3 EL3446 | 6-channel current input terminal 1 A AC/DC for distributed power measurement

### 3.3.1 EL3446 - Introduction

#### EL3446 | 6-channel current input terminal 1 A AC/DC for distributed power measurement

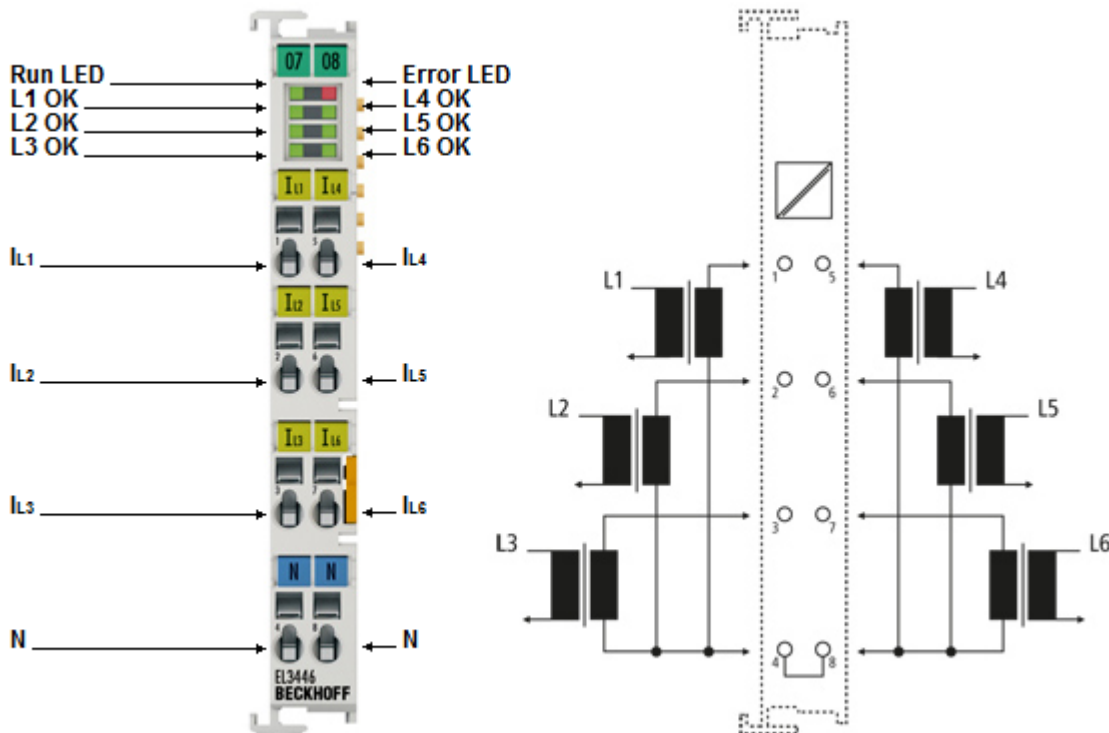

Fig. 8: EL3446

The EL3446 EtherCAT Terminal enables measurement of all relevant electrical data of the mains supply and performs simple pre-evaluations.

Since the EL3446 itself has no voltage inputs, the voltage measured values are transmitted via EtherCAT from an EL3443 to be installed once per network. The current of the up to six connectable phases is fed in via simple current transformers (e.g. the Beckhoff [SCT](#) series).

All measured currents and voltages are available as RMS values. In the EL3446 version, the active power and the energy consumption for each phase are calculated. The RMS values of voltage  $U$  and current  $I$  as well as active power  $P$ , apparent power  $S$ , reactive power  $Q$ , frequency  $f$ , phase shift angle  $\cos \varphi$  and harmonics are available.

The EL3446 offers options for comprehensive grid analysis and energy management.

#### Quick links

- [Technical data](#) [▶ 27]
- [Basic function principles](#) [▶ 41]
- [Object description and parameterization](#) [▶ 170]
- [Process data](#) [▶ 155]
- [Application examples](#) [▶ 278]

### 3.3.2 EL3446 - Technical data

#### EL3446

Technical data	EL3446
Number of inputs	6 x current
Technology	6-Channel Distributed Power Measurement
Oversampling factor	–
Internal sampling rate	approx. 9.7 kSps (per channel - simultaneously over all channels)
Sampling type	simultaneous over all channels
Ground reference	single ended
Distributed clocks	optional (required for distributed power measurement)
Update interval	one mains period (20 ms at 50 Hz)
Update time	mains-synchronous
Measured values	current, voltage, active power, reactive power, apparent power, active energy, reactive energy, apparent energy, cos $\phi$ , frequency, THD, harmonics (up to 40th harmonic)
Measuring current	max. 1 A (AC/DC), via measuring transformer [► 40] x A/1 A
Measuring error	0.3 % relative to the full scale value (U/I), 0.6 % calculated values (see documentation)
Measuring procedure	true RMS
Electrical isolation	2500 V
Current consumption Power contacts	–
Current consumption via E-bus	typ. 120 mA
Special features	together with an EL3443, the EL3446 enables the measurement of real power values (for apparent, reactive and active power) via Distributed Power Measurement.
Configuration	via TwinCAT System Manager
Weight	approx. 75 g
Dimensions (W x H x D)	approx. 15 mm x 100 mm x 70 mm (width aligned: 12 mm)
Mounting [► 63]	on 35 mm mounting rail according to EN 60715
Permissible ambient temperature range during operation	0 °C ... +55 °C
Permissible ambient temperature range during storage	-25 °C ... +85 °C
Relative humidity	95 % no condensation
Vibration/shock resistance	conforms to EN 60068-2-6 / EN 60068-2-27
EMC immunity/emission	conforms to EN 61000-6-2/EN 61000-6-4
Protection class/installation position	IP20/any
Marking/Approval <sup>*)</sup>	CE, EAC, UKCA cULus [► 66]

<sup>\*)</sup> Real applicable approvals/markings see type plate on the side (product marking).

### 3.3.3 EL3446 – LED and connection

**⚠ WARNING**

**Caution: Risk of injury through electric shock!**

If you do not connect the terminal point N with the neutral conductor of your mains supply (e.g. when using for current measurement only), terminal point N should be grounded, in order to avoid dangerous overvoltages in the event of a current transformer fault!

**⚠ WARNING**

**Caution: Risk of injury through electric shock!**

Please note that many vendors do not permit their current transformers to be operated in no-load mode! Connect the terminal to the secondary winding of the current transformers before using the current transformer!

#### EL3446 - LEDs and connection

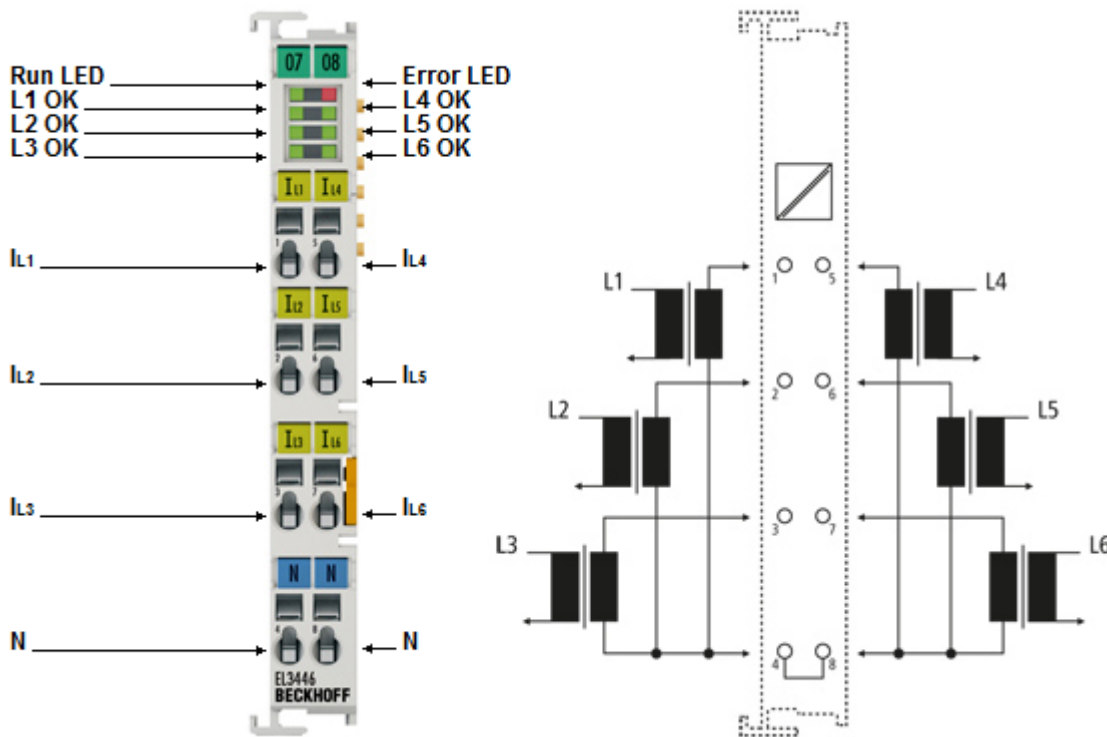

Fig. 9: EL3446 LEDs and connection

Terminal point		Description	Comment
Name	No.		
I <sub>L1</sub>	1	Load/current transformer on channel 1	Connections for the voltage measurement Note the <a href="#">Warnings [► 28]</a> above " Caution: Risk of electric shock! "
I <sub>L2</sub>	2	Load/current transformer on channel 2	
I <sub>L3</sub>	3	Load/current transformer on channel 3	
N	4	Neutral conductor N (internally connected to terminal point 8)	
I <sub>L4</sub>	5	Load/current transformer on channel 4	Connections for the current transformers. Note the <a href="#">Warnings [► 28]</a> above " Caution: Risk of electric shock! "
I <sub>L5</sub>	6	Load/current transformer on channel 5	
I <sub>L6</sub>	7	Load/current transformer on channel 6	
N	8	Neutral conductor N (internally connected to terminal point 4)	

LED	Color	Meaning	
RUN	green	This LED indicates the terminal's operating state:	
		off	State of the EtherCAT State Machine [▶ 55]: <b>INIT</b> = initialization of the terminal
		flashing rapidly	State of the EtherCAT State Machine [▶ 55]: <b>BOOTSTRAP</b> = function for terminal firmware updates [▶ 304]
		flashing	State of the EtherCAT State Machine [▶ 55]: <b>PREOP</b> = function for mailbox communication and different default settings set
		Single flash	State of the EtherCAT State Machine [▶ 55]: <b>SAFEOP</b> = verification of the Sync Manager [▶ 131] channels and the distributed clocks. Outputs remain in safe state.
		on	State of the EtherCAT State Machine [▶ 55]: <b>OP</b> = normal operating state; mailbox and process data communication is possible
System OK	green	on	System OK,
L1 – L6 OK	green	on	Voltage in the normal range
		flashes	Voltage in the critical range (warning threshold exceeded, Guard Settings see CoE object 0x80n2)
		off	Voltage in prohibited range (error threshold exceeded, Guard Settings see CoE object 0x80n2)
Error	red	on	Error of terminal

## 3.4 EL3453 | 3-phase power measurement terminal up to 690 V AC with extended functionality

### 3.4.1 EL3453 - Introduction

#### EL3453 | 3-phase power measurement terminal up to 690 V AC with extended functionality

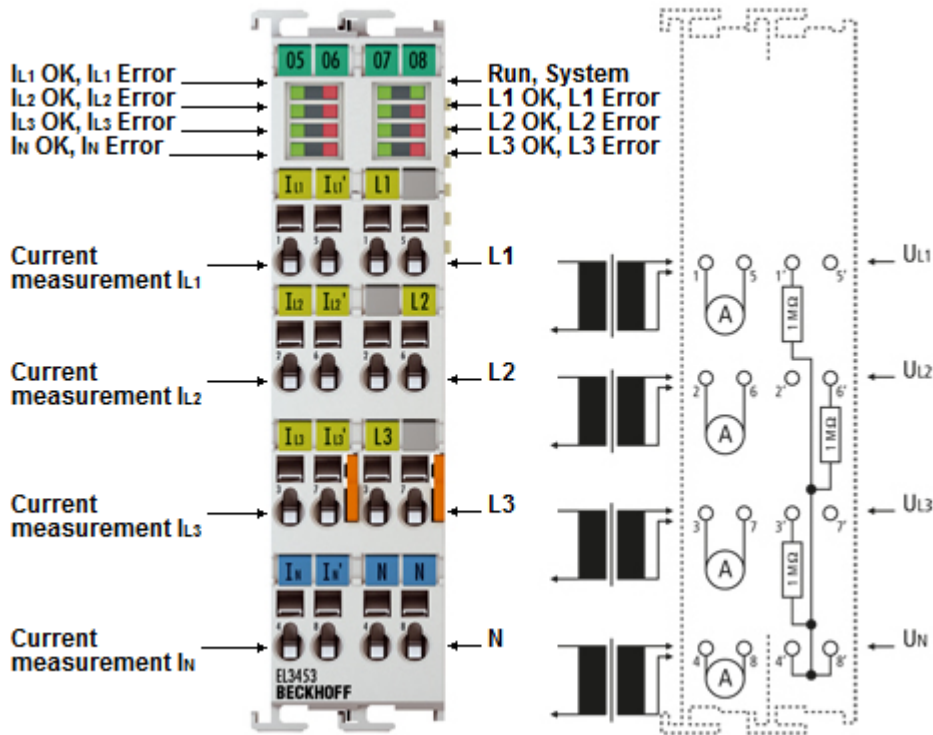

Fig. 10: EL3453 (component values only exemplary, exact value see technical data)

The EL3453 EtherCAT power measurement terminal is an advancement based on the EL3413. With up to 690 V AC the voltage inputs are optimized for direct monitoring of high-performance generators, as used in the wind power industry, for example. No upstream voltage transformer is required.

The four current inputs are electrically isolated from each other and allow the terminal to be used in all common grounded current transformer configurations such as 2- or 3-transformer configurations with star or delta connection including neutral current measurement. Simple grid analyses are performed by the EL3453 up to the 63th harmonic analysis or summarized in the Power Quality Factor for simplified diagnosis. Like all measured values of the terminal, the harmonic content can be read via the process data.

A version with factory calibration and [calibration certificate](#) [[▶ 64](#)] is available with the EL3453-0020.

The EL3453-0100 version is specially optimized for use including voltage transformers. It has a matched voltage measurement range corresponding to typical secondary side outputs of voltage transformers.

#### Quick links

- [Technical data](#) [[▶ 31](#)]
- [Basic function principles](#) [[▶ 41](#)]
- [Object description and parameterization](#) [[▶ 170](#)]
- [Process data](#) [[▶ 155](#)]
- [Application examples](#) [[▶ 278](#)]

### 3.4.2 EL3453 - Technical data

#### EL3453-0xx0

Technical data	EL3453	EL3453-0020	EL3453-0100
Number of inputs	4 x current, 3 x voltage		
Technology	3-phase power measurement		
Special feature	-	factory calibrated with calibration certificate [► 64]	-
Oversampling factor	–		
Internal sampling rate	approx. 9.7 kSps (per channel)		
Sampling type	simultaneously across all channels		
Ground reference	single ended		
Distributed clocks	optional (for determining the zero crossing time)		
Accuracy of Distributed Clocks	<< 1 $\mu$ s		
Update time	with each half-wave (10 ms at 50 Hz)		
Measured values	Current, voltage, active power, reactive power, apparent power, active energy, reactive energy, apparent energy, fundamental power and energy, $\cos \phi$ , frequency, THD, harmonics (up to 63th harmonic), power quality factor		
Measuring error	0.3% relative to full scale value (U/I), 0.6% calculated values		
Measuring procedure	true RMS		
Nominal voltage range (mains voltage)	AC: 400 V <sub>rms</sub> (UL <sub>x</sub> -N) or 690 V <sub>rms</sub> (UL <sub>x</sub> -UL <sub>y</sub> ) (TN network: 600 V <sub>rms</sub> ) DC: 480 V with connection via L1 and L2 (or L3)		corresponding to AC: 100 V <sub>rms</sub> (UL <sub>x</sub> -N) for voltage transformers
Technical voltage measuring range	520 V <sub>rms</sub> (UL <sub>x</sub> -N) or 897 V <sub>rms</sub> (UL <sub>x</sub> -UL <sub>y</sub> ) common reference potential N/GND max. time for voltages above 500 V <sub>rms</sub> (UL <sub>x</sub> -N) or 863 V <sub>rms</sub> (UL <sub>x</sub> -UL <sub>y</sub> ): $t_{max} < 10$ s <sup>*)</sup>		145 V <sub>rms</sub> (UL <sub>x</sub> -N) common reference potential N/GND
Max. permitted overvoltage	max. $\pm 736$ V (peak value, UL <sub>x</sub> -N, equivalent to 520 V <sub>rms</sub> ) or max. $\pm 1270$ V (peak value, UL <sub>x</sub> -UL <sub>y</sub> , equivalent to 897 V <sub>rms</sub> ) <sup>*)</sup>		max. 300 V <sub>rms</sub> (UL <sub>x</sub> -N) <sup>*)</sup>
Internal resolution	24 bit		
Input resistance voltage circuit	typ. 1.5 M $\Omega$		
Nominal current range	corresponding to AC: 100 mA <sub>rms</sub> ; 1 A <sub>rms</sub> (default); 5 A <sub>rms</sub> recommended via measuring transformer [► 40] x A AC/1 A AC		
Technical current measuring range	2.25 A (peak value, equivalent to 1.59 A <sub>rms</sub> ) or 9.6 A (peak value, equivalent to 6.8 A <sub>rms</sub> )		
Permissible overcurrent	max. $\pm 10$ A peak value, equivalent to 7 A <sub>rms</sub> <sup>*)</sup> per channel and max. sum current (I1+I2+I3+IN) $\pm 20$ A peak value, equivalent to 14 A <sub>rms</sub> <sup>*)</sup>		
Short-time current carrying capacity	60 A (sinusoidal) for 1 sec., the upstream use of current-limiting current transformers is recommended		
Largest short-term deviation during a specified electrical interference test	< $\pm 0.5\%$ of full scale value for the current measurement		
Input resistance current circuit	typ. 3 M $\Omega$		
Frequency range	15 ... 400 Hz		
Cut-off frequency	4000 Hz		
Electrical isolation	4500 V		
Current consumption power contacts	–		
Current consumption via E-bus	260 mA typ.		
Weight	approx. 100 g		
Dimensions (W x H x D)	approx. 27 mm x 100 mm x 70 mm (width aligned: 24 mm)		
Installation [► 63]	on 35 mm mounting rail, conforms to EN 60715		
Permissible ambient temperature range during operation	-25 °C ... +60 °C (extended temperature range)		0 °C ... +55 °C
Permissible ambient temperature range during storage	-40 °C ... +85 °C		-25 °C ... +85 °C
Relative humidity	95 % no condensation		
Vibration/shock resistance	conforms to EN 60068-2-6 / EN 60068-2-27		
EMC immunity/emission	conforms to EN 61000-6-2 / EN 61000-6-4		
Protection rating/installation position	IP20/any		
Marking/Approval <sup>*)</sup>	CE, EAC, UKCA cULus [► 66],		

\*) Real applicable approvals/markings see type plate on the side (product marking).

\*) Prolonged operation above the nominal range can lead to functional impairment and/or shortening of the service life.



### 3.4.3 EL3453 – LED and connection

**⚠ WARNING**

**Caution: Risk of injury through electric shock!**

If you do not connect the terminal point N with the neutral conductor of your mains supply (e.g. when using for current measurement only), terminal point N should be grounded, in order to avoid dangerous overvoltages in the event of a current transformer fault!

**⚠ WARNING**

**Caution: Risk of injury through electric shock!**

Please note that many vendors do not permit their current transformers to be operated in no-load mode! Connect the terminal to the secondary winding of the current transformers before using the current transformer!

#### EL3453 - LEDs and connection

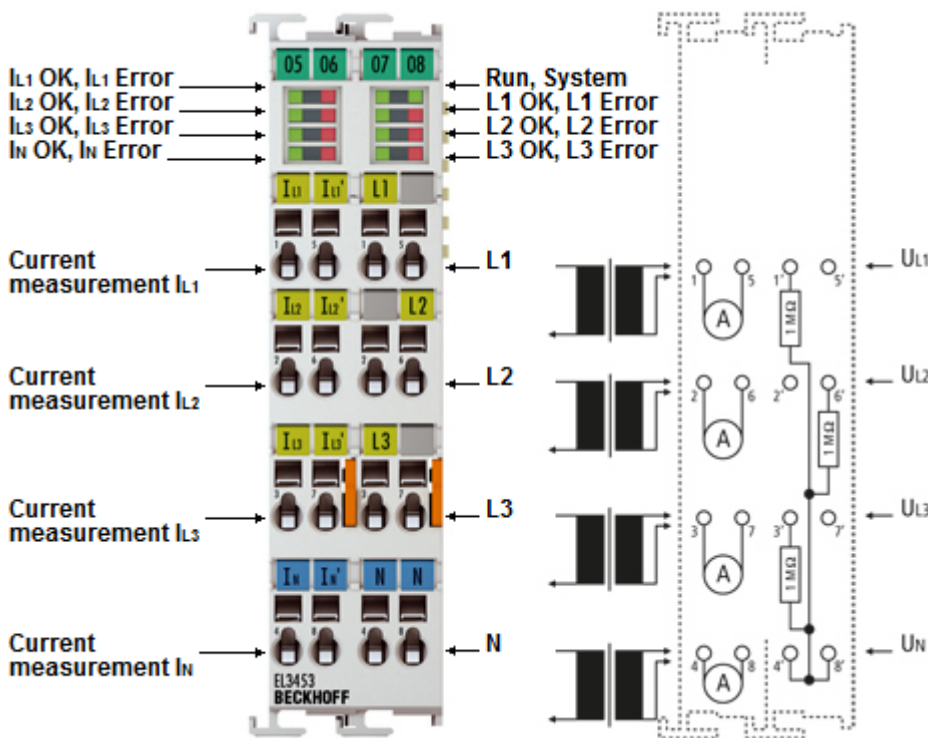

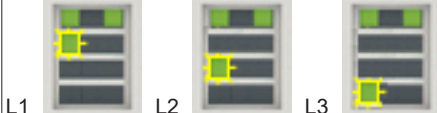

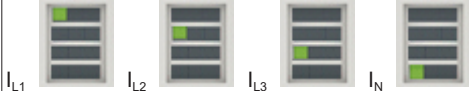
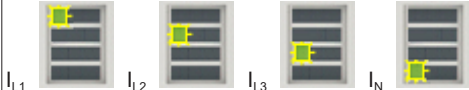
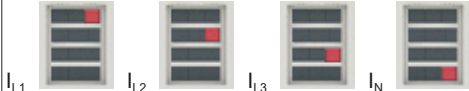

Fig. 11: EL3453 LED's, connection (Component values only exemplary, exact value s. Technical data)

Terminal point		Description	Comment
Name	No.		
I <sub>L1</sub>	1	Phase L1 current measurement input	Connections for the current transformers. Note the <u>Warnings</u> [► 33] above " Caution: Risk of electric shock!"
I <sub>L2</sub>	2	Phase L2 current measurement input	
I <sub>L3</sub>	3	Phase L3 current measurement input	
I <sub>N</sub>	4	Neutral conductor current measurement input (star point)	
I <sub>L1'</sub>	5	Phase L1 current measurement output	
I <sub>L2'</sub>	6	Phase L2 current measurement output	
I <sub>L3'</sub>	7	Phase L3 current measurement output	
I <sub>N'</sub>	8	Neutral conductor current measurement output (star point)	
L1	1'	Phase L1	Connections for the voltage measurement Note the <u>Warnings</u> [► 33] above " Caution: Risk of electric shock!"
	2'	n.c.	
L3	3'	Phase L3	
N	4'	Neutral conductor (internally connected with terminal point 8')	
	5'	n.c.	
L2	6'	Phase L2	
	7'	n.c.	
N	8'	Neutral conductor (internally connected with terminal point 4')	

LED	Color	Meaning	
RUN	green	This LED indicates the terminal's operating state:	
		off	State of the EtherCAT State Machine [▶ 55]: <b>INIT</b> = initialization of the terminal
		flashing rapidly	State of the EtherCAT State Machine [▶ 55]: <b>BOOTSTRAP</b> = function for terminal <a href="#">firmware updates [▶ 304]</a>
		flashing	State of the EtherCAT State Machine [▶ 55]: <b>PREOP</b> = function for mailbox communication and different default settings set
		Single flash	State of the EtherCAT State Machine [▶ 55]: <b>SAFEOP</b> = verification of the <a href="#">Sync Manager [▶ 131]</a> channels and the distributed clocks. Outputs remain in safe state.
on	State of the EtherCAT State Machine [▶ 55]: <b>OP</b> = normal operating state; mailbox and process data communication is possible		
System OK	green	on System OK, (the "SystemOK"-LED is the representation of the "System State" bit, <a href="#">F600:01 [▶ 176]</a> )	
L1 - L3 OK	green	on Right prism: Voltage in normal range  	
		flashes Right prism: Voltage in the critical range (warning threshold exceeded)  	
		off Right prism: Voltage in prohibited range (error threshold exceeded)	
L1 - L3 Error	red	on 	
I <sub>L1</sub> - I <sub>L3</sub> OK	green	on Left prism: Current in normal range  	
		flashes Left prism: Current in the critical range (warning threshold exceeded)  	
		off Left prism: Current in prohibited range (error threshold exceeded)	
I <sub>L1</sub> - I <sub>L3</sub> Error	red	on 	

## 3.5 EL3483 | 3-phase mains monitoring terminal for voltage, frequency and phase

### 3.5.1 EL3483 - Introduction

EL3483 | 3-phase mains monitoring terminal for voltage, frequency and phase

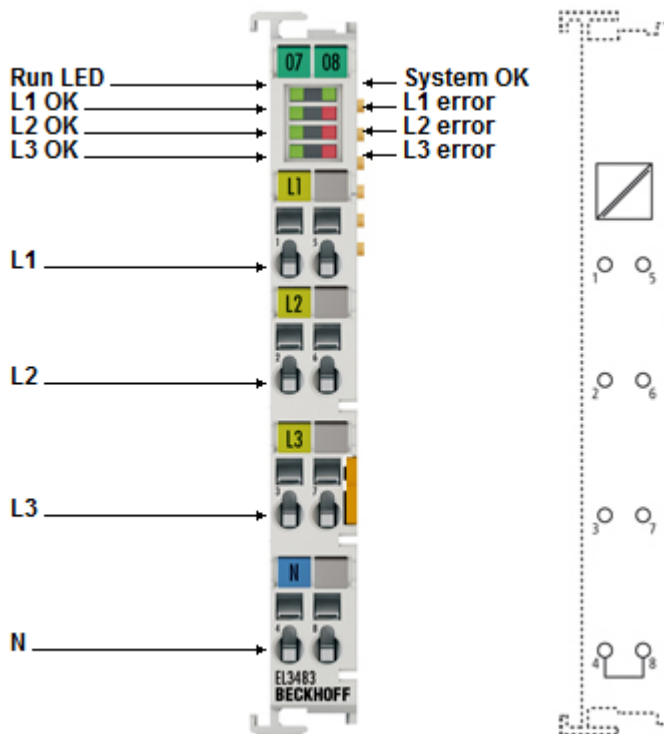

Fig. 12: EL3483

The EL3483 EtherCAT Terminal enables monitoring of relevant electrical data of the supply network. The voltage is measured internally via direct connection of L1, L2, L3 and N. The internal measured values are compared with threshold values preset by the user. The result is available as digital information in the process image.

The EL3483 monitors the correct phase sequence L1, L2, L3, phase failure, undervoltage and overvoltage and possible phase imbalance. An error bit is set in case of an incorrect phase sequence or phase failure. If, for example, an imbalance or voltage fault occurs, only a warning bit is set initially.

In addition, an internally calculated power quality factor provides information about the quality of the monitored power supply. The EL3483 offers options for simple grid analysis and mains control. The EL3483-0060 version also outputs the current rms values of the voltage in the process image.

#### Quick links

- [Technical data](#) [► 37]
- [Basic function principles](#) [► 41]
- [Object description and parameterization](#) [► 170]
- [Process data](#) [► 155]
- [Application examples](#) [► 278]

### 3.5.2 EL3483 - Technical data

#### EL3483-0xx0

Technical data	EL3483	EL3483-0060
Number of inputs	3 x voltage	
Technology	3-phase mains monitor	
Oversampling factor	–	
Internal sampling rate	approx. 9.7 kSps (per channel - simultaneously over all channels)	
Sampling type	simultaneous over all channels	
Ground reference	single ended	
Distributed clocks	–	
Update interval	ten mains periods (200 ms at 50 Hz)	
Measured values	digital thresholds and power quality factor (PowerQualityFactor)	digital thresholds and power quality factor (PowerQualityFactor), analog voltage measurement
Measuring voltage	max. 480 V AC 3~ (UL <sub>x</sub> -N: max. 277 V AC; max. 240 V DC)	
Measuring procedure	true RMS	
Update time	mains-synchronous	
Electrical isolation	2500 V	
Current consumption Power contacts	–	
Current consumption via E-bus	typ. 120 mA	
Special features	operation as voltage monitor, frequency monitor and phase monitor also possible in single-phase operation	
Monitoring function	phase sequence, phase failure, phase imbalance, undervoltage/overvoltage (adjustable)	
Weight	approx. 75 g	
Dimensions (W x H x D)	approx. 15 mm x 100 mm x 70 mm (width aligned: 12 mm)	
Mounting <a href="#">▶ 63</a>	on 35 mm mounting rail according to EN 60715	
Permissible ambient temperature range during operation	-25 °C ... +60 °C (extended temperature range)	
Permissible ambient temperature range during storage	-40 °C ... +85 °C	
Relative humidity	95 % no condensation	
Vibration/shock resistance	conforms to EN 60068-2-6 / EN 60068-2-27	
EMC immunity/emission	conforms to EN 61000-6-2/EN 61000-6-4	
Protection class/installation position	IP20/any	
Marking/Approval <sup>1)</sup>	CE, EAC, UKCA cULus <a href="#">▶ 66</a>	

\*) Real applicable approvals/markings see type plate on the side (product marking).

### 3.5.3 EL3483 – LED and connection

#### EL3483 - LEDs and connection

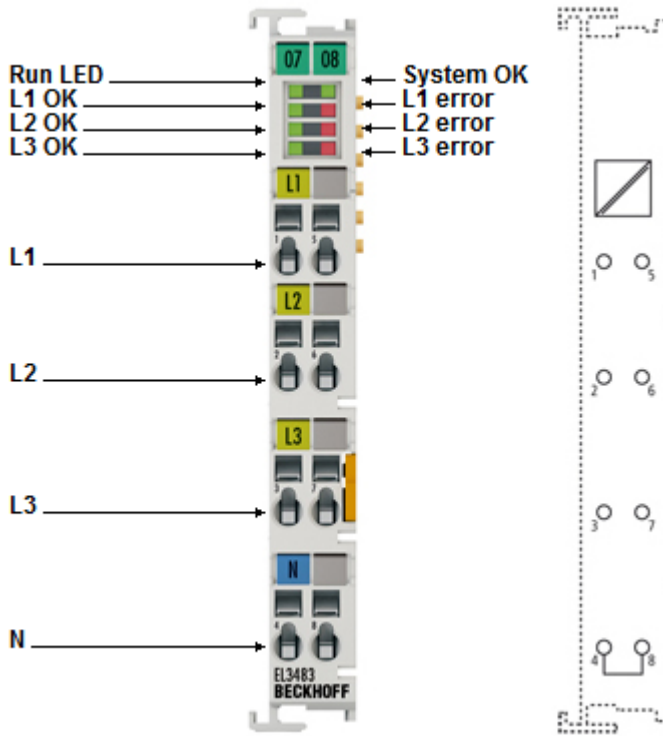





Fig. 13: EL3483 LEDs and connection

Terminal point		Description	Comment
Name	No.		
L1	1	Phase L1	Connections for the voltage measurement Note the <a href="#">Warnings [► 33]</a> above " Caution: Risk of electric shock! "
L2	2	Phase L2	
L3	3	Phase L3	
N	4	Neutral conductor N	

LED	Color	Meaning	
RUN	green	This LED indicates the terminal's operating state:	
		off	State of the EtherCAT State Machine [▶ 55]: <b>INIT</b> = initialization of the terminal
		flashing rapidly	State of the EtherCAT State Machine [▶ 55]: <b>BOOTSTRAP</b> = function for terminal <a href="#">firmware updates</a> [▶ 304]
		flashing	State of the EtherCAT State Machine [▶ 55]: <b>PREOP</b> = function for mailbox communication and different default settings set
		Single flash	State of the EtherCAT State Machine [▶ 55]: <b>SAFEOP</b> = verification of the <a href="#">Sync Manager</a> [▶ 131] channels and the distributed clocks. Outputs remain in safe state.
		on	State of the EtherCAT State Machine [▶ 55]: <b>OP</b> = normal operating state; mailbox and process data communication is possible
System OK	green	on System OK, (the "SystemOK"-LED is the representation of the "System State" bit, F600:01 [▶ 176])	
L1 - L3 OK	green	on Voltage in the normal range  L1 L2 L3	
		flashes Voltage in the critical range (warning threshold exceeded)  L1 L2 L3	
		off Voltage in prohibited range (error threshold exceeded)	
L1 - L3 Error	red	on  L1 L2 L3	

## 3.6 Additional Notes

---

### ● Accuracy - Technical data



Please note that the DPM algorithm generally performs compression over several waves. This can lead to limitations in accuracy, especially for signals with a period duration over more than one mains wave (e.g. wave packet control).

---

### ● Measuring transformers



Suitable measuring transformers for use with the energy and power measuring terminals are available with the SCT series from Beckhoff.

---

### ● Non-volatile storage of the energy values



All energy values are stored non-volatile in all EL34xx terminals even in case of a sudden voltage loss.

After switching on again, the energy values are at the level before the voltage loss and are counted on from there.

---



### 3.7 Basic function principles

#### Measuring principle

The EL3443 works with 6 analog/digital converters for recording the current and voltage values of all 3 phases.

Recording and processing is synchronous and identical for the 3 phases. The signal processing for one phase is described below. This description applies correspondingly for all 3 phases.

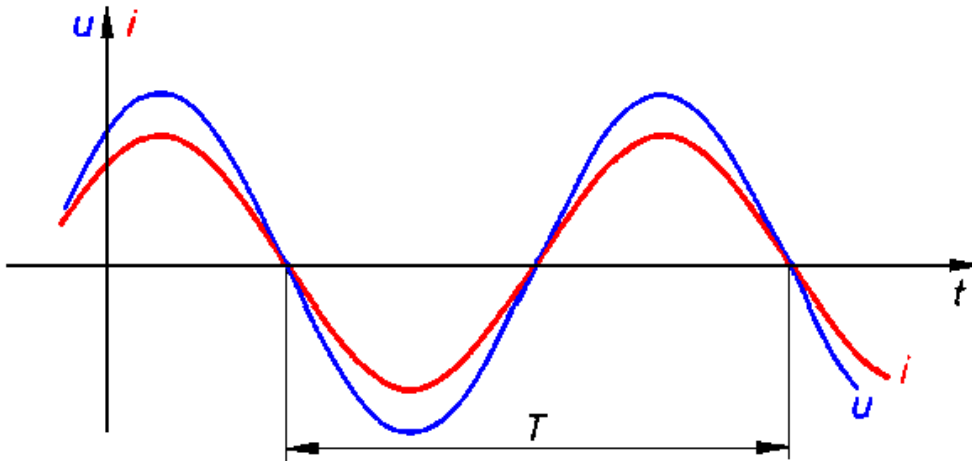

Fig. 14: Voltage u and current i curves

#### RMS value calculation

The RMS value for voltage and current is calculated during the period T. The following equations are used:

$$U = \sqrt{\frac{1}{n} \sum_{1}^n u_{(t)}^2}$$

$$I = \sqrt{\frac{1}{n} \sum_{1}^n i_{(t)}^2}$$

- $u_{(t)}$ : instantaneous voltage value
- $i_{(t)}$ : instantaneous current value
- n: number of measured values

The instantaneous values for current and voltage are low-pass filtered with a cut-off frequency of 2.5 kHz for the EL3443, EL3423 and EL3483.

#### Active power measurement

The EL34xx measures the active power P according to the following equation

$$P = \frac{1}{n} \sum_{1}^n u_{(t)} \cdot i_{(t)}$$

- P: active power
- n: number of samples
- $u_{(t)}$ : instantaneous voltage value
- $i_{(t)}$ : instantaneous current value

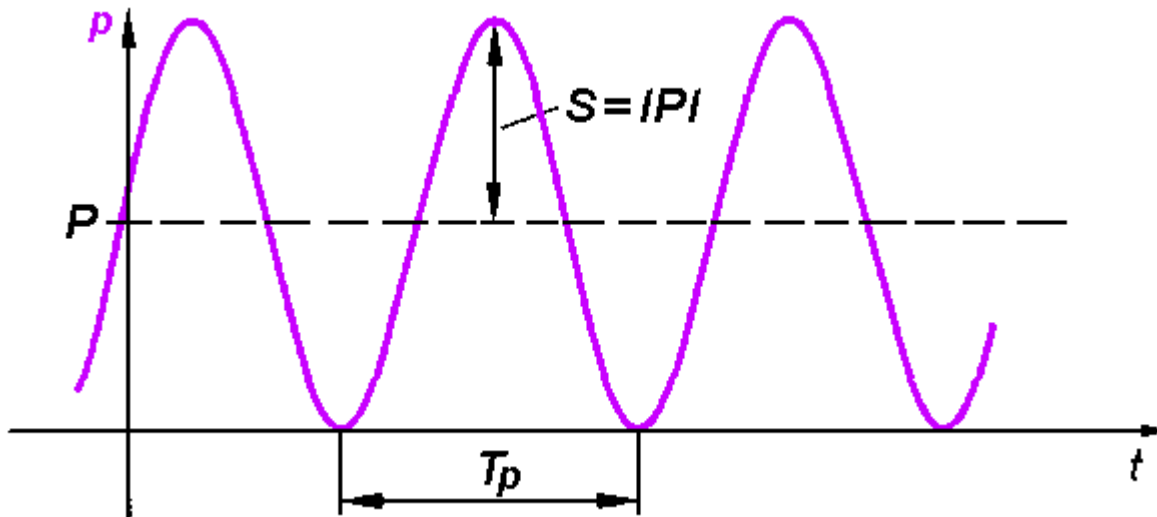
Fig. 15: Power  $s_{(t)}$  curve

In the first step, the power  $s_{(t)}$  is calculated at each sampling instant:

$$s_{(t)} = u_{(t)} \cdot i_{(t)}$$

The mean value is calculated over a period.

The power frequency is twice that of the corresponding voltages and currents.

### Apparent power measurement

In real networks, not all consumers are purely ohmic. Phase shifts occur between current and voltage. This does not affect the methodology for determining the RMS values of voltage and current as described above.

The situation for the active power is different: Here, the product of RMS voltage and RMS current is the apparent power.

$$S = U \cdot I$$

The active power is smaller than the apparent power.

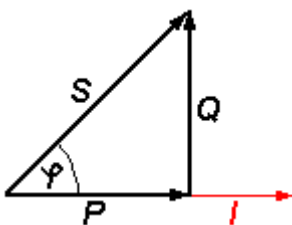

S: apparent power  
 P: active power  
 Q: reactive power  
 $\varphi$ : Phase shift angle

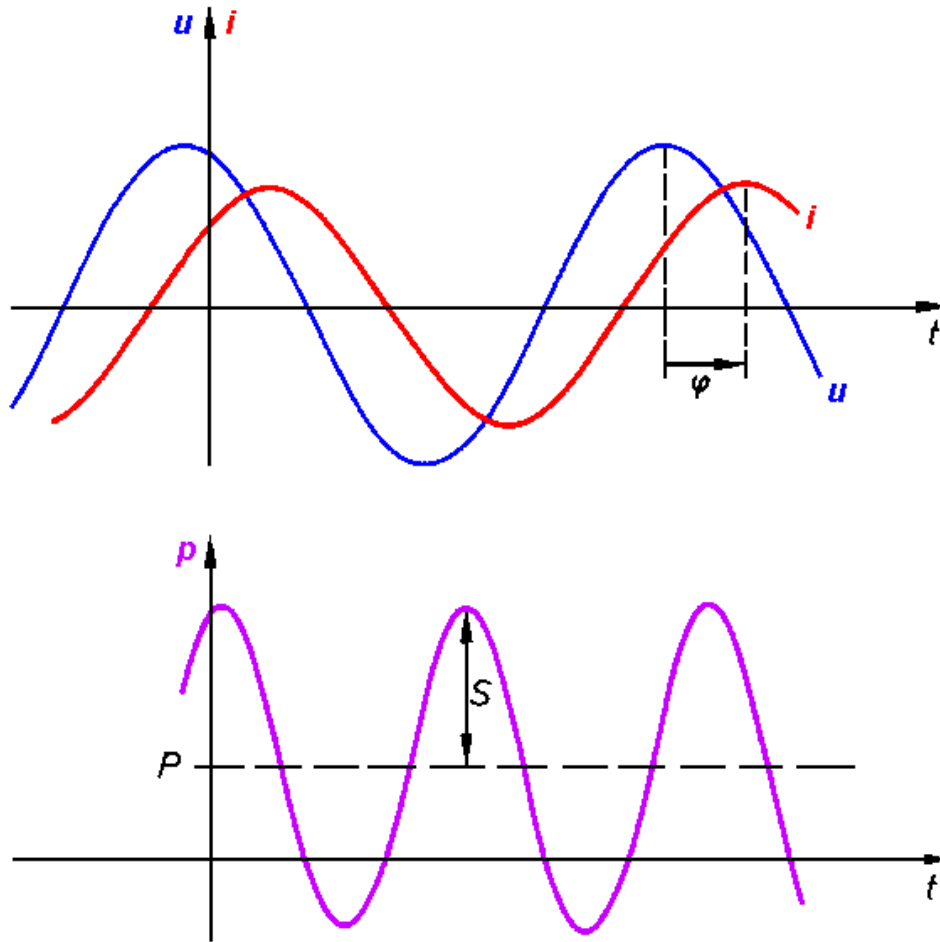

Fig. 16:  $u$ ,  $i$ ,  $p$  curves with phase shift angle  $\varphi$

In this context, further parameters of the mains system and its consumers are significant:

- apparent power  $S$
- reactive power  $Q$
- power factor  $\cos \varphi$

The EL3443 determines the following values:

- RMS voltage  $U$  and RMS current  $I$
- Active power  $P$  and active energy  $E$
- Apparent power  $S$  and apparent energy
- Reactive power  $Q$  and reactive energy
- Power factor and  $\cos(\varphi)$
- Distortion factors for current  $\text{THD}_I$  and voltage  $\text{THD}_U$
- Calculated RMS neutral conductor current  $I_N$
- Voltage imbalance
- Power quality factor (details see below)
- In "DC synchronous" mode, the distributed clock time of the voltage zero crossing is also available.

**Sign for power measurement**

The sign of the (fundamental wave) active power  $P$  and the power factor  $\cos \phi$  provides information about the direction of the energy flow. A positive sign indicates the motor mode, a negative sign indicates generator mode.

Furthermore, the sign of the fundamental harmonic reactive power  $Q$  provides information about the direction of the phase shift between current and voltage. Fig. *Four-quadrant representation of active/fundamental harmonic reactive power in motor and generator mode* illustrates this. In motor mode (quadrant I + IV), a positive fundamental harmonic reactive power indicates an inductive load, a negative fundamental harmonic reactive power indicates a capacitive load. The information about a capacitive or inductive load behavior is also shown in the sign of the phase angle  $\phi$ , which is already contained in the EL3443. In generator mode (quadrant II & III), an inductive generator is indicated by a positive fundamental harmonic reactive power, a capacitive generator by a negative fundamental harmonic reactive power.

Since the total reactive power is defined as the quadratic difference between apparent and active power, it has no sign. For the total active power, signs are permitted, as described above.

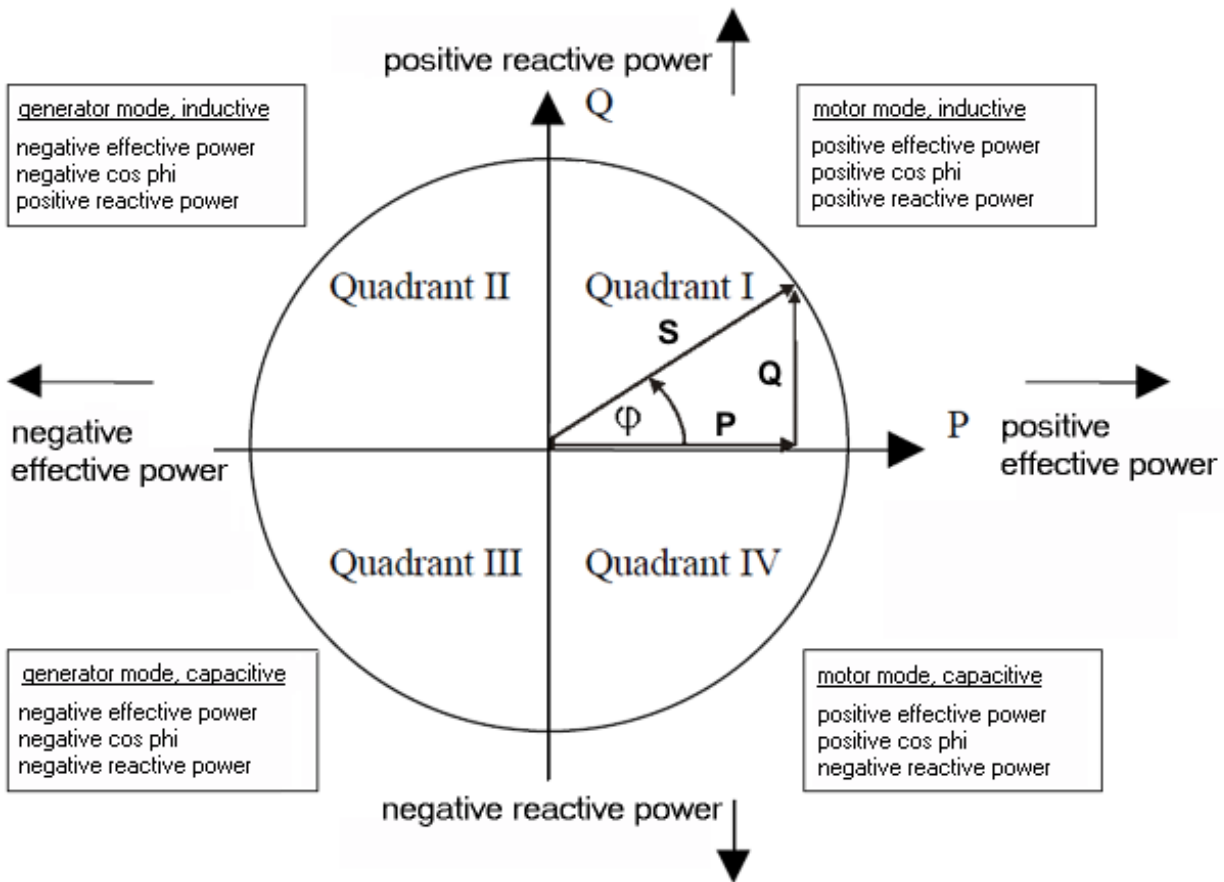

Fig. 17: Four-quadrant representation of active power/fundamental harmonic reactive power in motor and generator mode

**Frequency measurement**

The EL34xx can measure the frequency for a voltage path input signal and a current path input signal. CoE objects "Reference" and "Frequency Source" ([F800:11](#) [[P](#) [171](#)] and [F800:13](#) [[P](#) [171](#)]) can be used to set which frequency is to be output as PDO.

**Power quality factor**

The EL34xx calculates a PQF (power quality factor), which reflects the quality of the voltage supply as a simplified analog value between 1.0 and 0.

To calculate this factor, the measured values, frequency, RMS voltage, distortion factor and voltage imbalance are calculated and combined as shown in the following diagram.

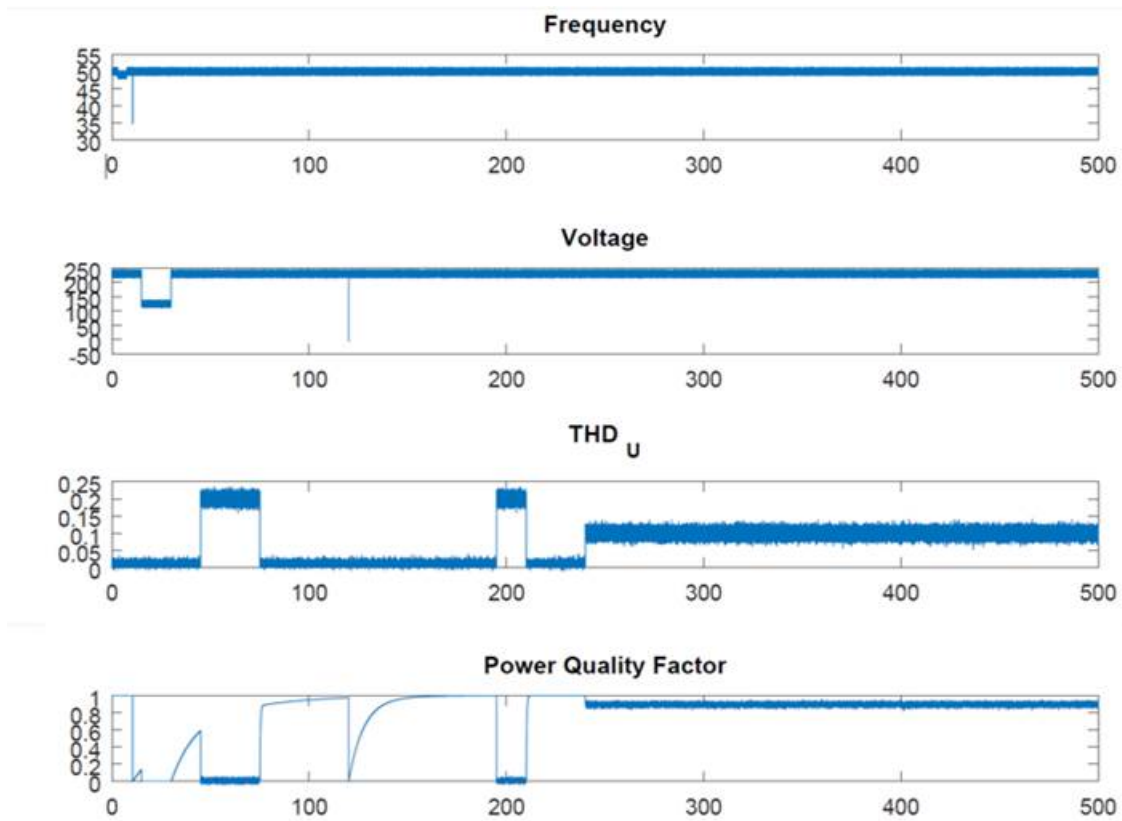

Fig. 18: Representation of the power quality factor calculation

As can be seen for the time value 120, the calculation method is chosen in such a way that even very short voltage drops cause a clear signal deflection.

The value above which the power supply is to be regarded as "sufficiently good" is strongly dependent on the connected application. The more sensitive the application, the higher the minimum limit value of the PQF should be.

To adapt the power quality factor to your mains supply, enter the nominal voltage and frequency in CoE object "0xF801 PMX Total Settings PQF [▶ 172]". This can also be done via the "Settings" tab, which summarizes all the important terminal setting options in a user-friendly manner.

The other monitored parameters (distortion factor and voltage unbalance) each have three parameters  $x_{nenn}$ ,  $\beta$ ,  $\gamma$  which are preset by the manufacturer. The combination of all factors is done by multiplication.

$$PQF_{tot} = \prod_{i \in I} PQF_i$$

The corresponding filter equation

$$PQF_k = f_k \left( \frac{x_k - x_{nenn}}{x_{nenn}} \right) * \alpha_k + PQF_{k-1} (1 - \alpha_k)$$

with

$$f(x) = \max(0, 1 - \gamma x^4) \text{ und } \alpha_k = \max(0, x_{k-1} - x_k) (1 - \beta) + \beta$$

The factor  $\alpha_k$  thus contains the rate of change of the monitored variable. If  $x_k$  changes significantly,  $\alpha_k$  also changes and the PQF reacts faster to changes.

In a real example, here using a short phase loss of 5 ms or 10 ms, the behavior of the PQF can be seen. For this example, the voltage (in green) was recorded at a frequency of 50 Hz using an EL3773. The PQF was calculated by an EL3483.

Example 1 shows a phase failure of 5 ms. This dropout can be seen on the PQF, but due to the length the factor does not go down to 0. The irregular dropout of the PQF over time can be explained by the calculation. The missing voltage increase is first visible in the voltage calculation (phase 1). In the second phase, the influence on the inertial calculation of the distortion also becomes clear.

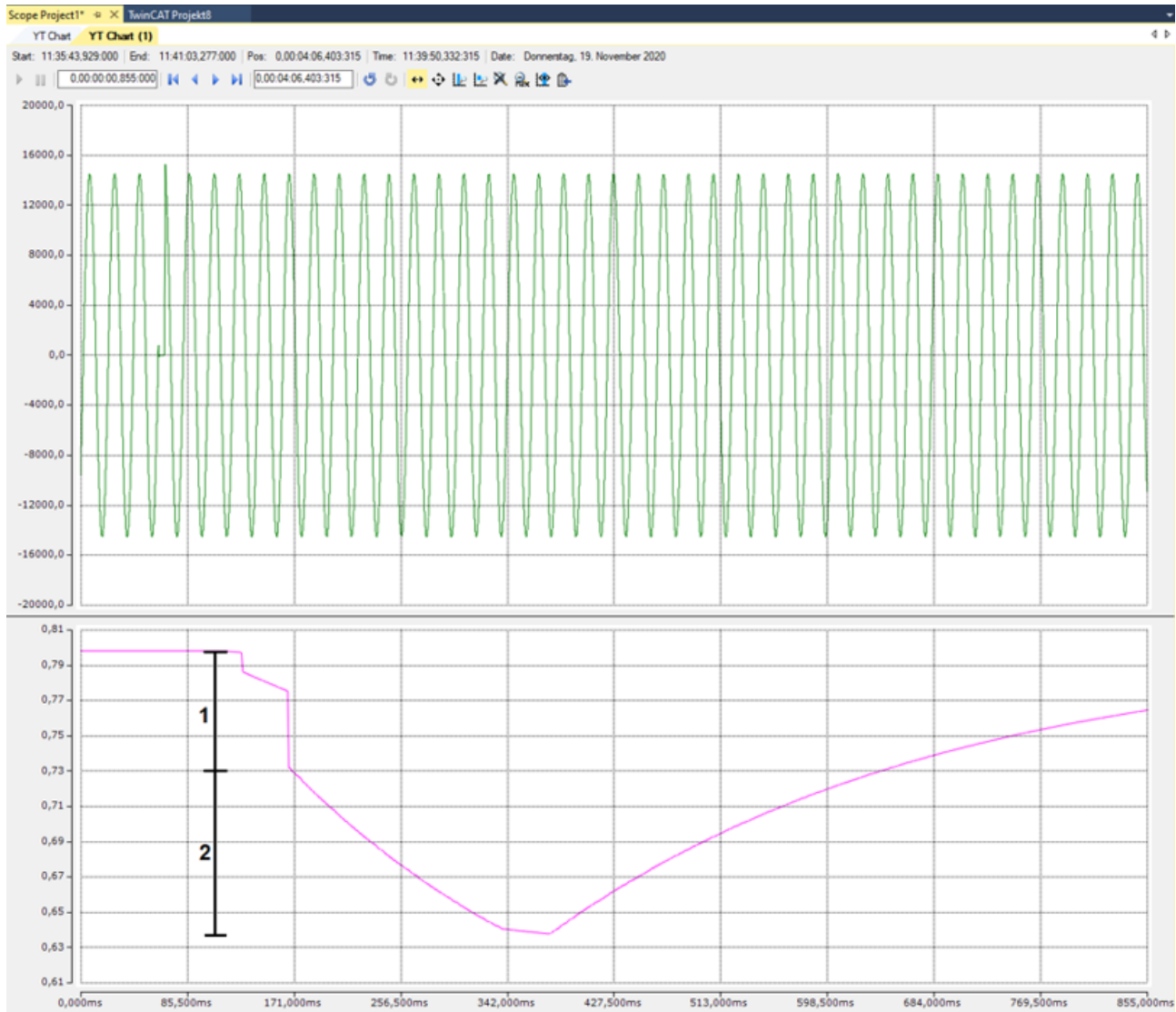

Fig. 19: PQF at 5 ms phase loss

With a longer phase loss for 10 ms (example 2), the influence on the PQF can be seen even more clearly. When a half-wave fails, it can be clearly seen in the voltage calculation so that the PQF drops directly to 0.

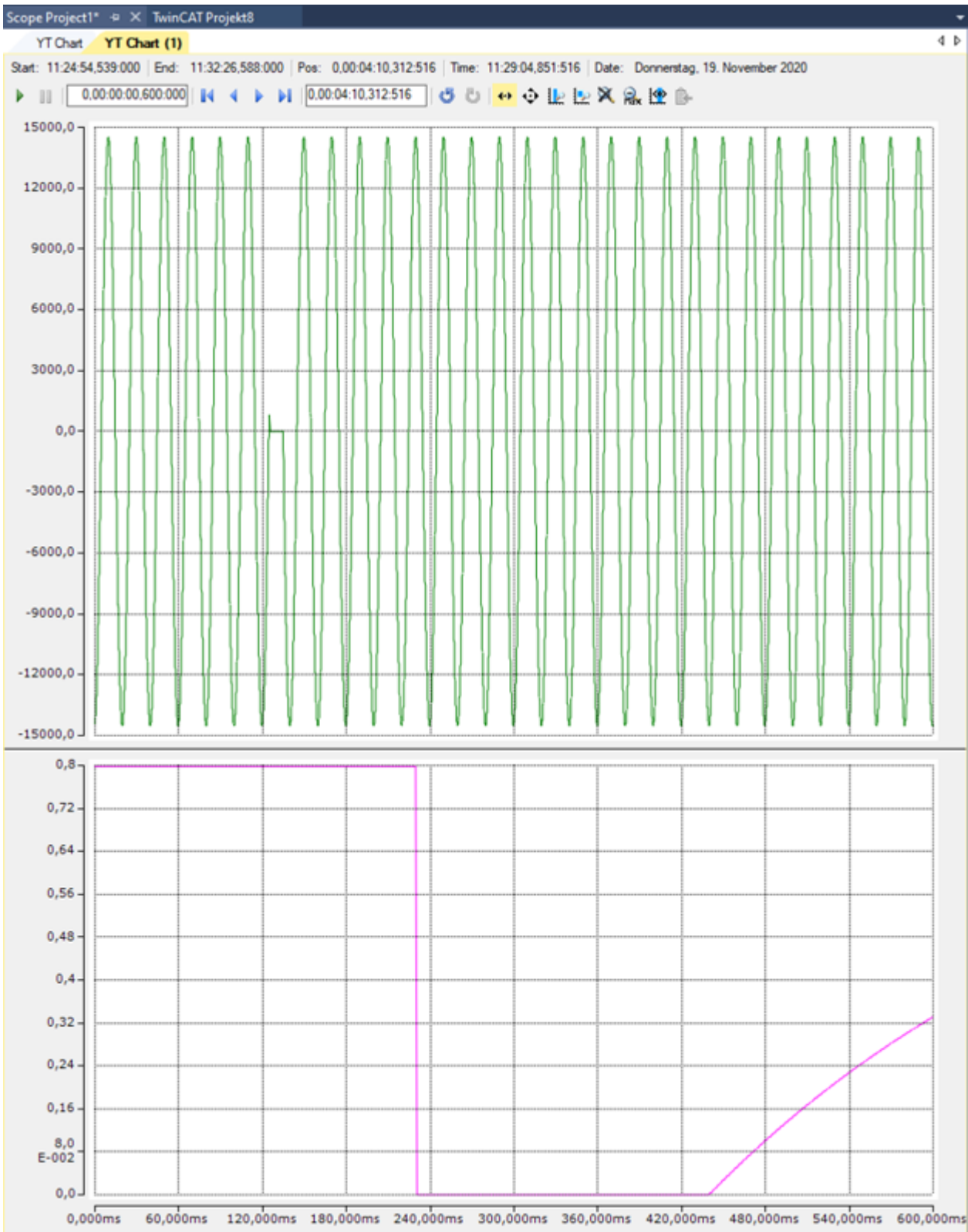

Fig. 20: PQF at 10 ms phase loss

The voltage supply value to be regarded as "sufficiently good" depends to a large extent on the connected application. The more sensitive the application, the higher the minimum limit value of the PQF should be selected.

## Voltage zero crossing

The EL3443 and EL3453 have the ability to determine the exact time of a voltage zero crossing. However, in order for this to be transmitted to a higher-level controller in a meaningful manner, the controller and the EtherCAT Terminal must have the same time base. Using distributed clocks technology, an EtherCAT system provides such a common time base (for details see [EtherCAT system description](#)). In order to be able to use these, the EL3443 must be in "DC synchronous" mode and the EtherCAT master must support the corresponding function.

Once these basic requirements have been met, the EL3443 and EL3453 provide the DC time of the penultimate zero crossing. In order to facilitate exact determination of the fundamental wave, the voltage signal to be evaluated must first be filtered, which inevitably entails a delay. In addition to the time of the voltage zero crossing, the EL3453 also determines the respective current zero crossings.

## Statistical evaluation

In addition to the cyclic data, the EL34xx terminals also produce statistical evaluations over longer periods (can be set in the CoE: "[F803 PMX Time Settings \[► 174\]](#)"). By default, the "[F803:12 Measurement Interval \[► 174\]](#)" is set to 15 minutes. The clock available for this purpose in the terminal can not only be read out via the CoE object "[F803:13 Actual System Time \[► 174\]](#)", it can also be actively influenced. Depending on the application, it may make sense to regularly synchronize the clock with an external clock. By default, the clock is set once at system startup based on the local Windows system time, taking into account the set time zone, usually UTC.

In addition, the interval can also be restarted manually via the "Reset Interval" output bit or directly from the application, for example to obtain statistics on a process that varies over time.

## Calculation of the neutral current

Since the EL34xx terminals have direct access to the instantaneous current values of all three phases, the neutral current can be calculated or estimated, assuming that no current is lost to the system (in other words: the differential current is zero). The calculated (i.e. not measured) current value is output in index "[F601:13 Calculated Neutral Line Current \[► 199\]](#)".

Since in the worst case all measurement errors add up, the maximum measurement error is correspondingly higher.

The additional possibility of measuring a fourth current value in the EL3453 means that either the differential current or the neutral current can be calculated. The other current can be measured directly using the fourth current channel. Due to the usual conditions and the corresponding measurement tolerances, however, it makes much more sense to measure the differential current with the aid of a summation current transformer and have the neutral conductor current calculated. Further information on this can be found in the chapter [Application examples \[► 278\]](#) under the section [Power measurement including residual current measurement \[► 287\]](#).

## Harmonic calculation

The EL34xx terminals perform an internal harmonic analysis for all current and voltage channels. For this purpose, a fundamental wave in the frequency range from 45 to 65 Hz is determined at the beginning (separately from the system frequency). The frequency value determined for the voltage harmonics can be read, for example, from index 99 (plus channel offset) of the variable output values and the amplitude in volts from index 98. The same applies to the current values - see "Variable output values".

The actual harmonic measured values are output as a percentage of the fundamental wave amplitude. It should also be noted that the zero harmonic indicates the DC component of the signal.



## 3.8 Current transformers

In principle, the choice of current transformer for the EL34xx is not critical. The internal resistance within the current circuit of the EL34xx is so small that it is negligible for the calculation of the total resistances of the current loop. The transformers should be able to produce a secondary rated current of 1 A. The primary rated current  $I_{pn}$  can be selected arbitrarily. The common permissible overload of  $1.2 \times I_{pn}$  is no problem for the EL34xx, but may lead to small measuring inaccuracies.

### ● Measuring transformers



Suitable measuring transformers for use with the energy and power measuring terminals are available with the SCT series from Beckhoff.

### Accuracy

Please note that the overall accuracy of the set-up consisting of EL34xx and current transformers to a large degree depends on the accuracy class of the transformers.

### ● No approval as a billing meter



Even an arrangement with a current transformer of class 0.5 or better is not subject to approval and certification. The EL34xx is not an approved billing meter within the meaning of the standard for electricity meters (DIN 43 856).

### NOTICE

#### DC currents with the EL3453

DC currents can lead to saturation of the internal current transformers and thus to measurement errors!

### Current types

The EL34xx can measure any current type up to a limiting proportion of 400 Hz. Since such currents are frequently created by inverters and may contain frequencies of less than 50 Hz or even a DC component, electronic transformers should be used for such applications.

### Overcurrent limiting factor FS

The overcurrent limiting factor FS of a current transformer indicates at what multiple of the primary rated current the current transformer changes to saturation mode, in order to protect the connected measuring instruments.

### NOTICE

#### Attention! Risk of damage to the device!

The EL34xx-xxxx must not be subjected to continuous loads that exceed the current values specified in the technical data! In systems, in which the overcurrent limiting factors of the transformers allow higher secondary currents, additional intermediate transformers with a suitable ratio should be used.

### NOTICE

#### Attention! Risk of damage to the device!

The EL3453-xxxx must not be permanently loaded with more than  $I_1 + I_2 + I_3 + I_N = 20$  A total current across all channels!

## Protection against dangerous touch voltages

During appropriate operation of the EL34xx with associated current transformers, no dangerous voltages occur. The secondary voltage is in the range of a few Volts. However, the following faults may lead to excessive voltages:

- Open current circuit of one or several transformers
- Neutral conductor cut on the voltage measurement side of the EL34xx
- General insulation fault

### WARNING

#### Risk of electric shock!

The complete wiring of the EL34xx must be protected against accidental contact and equipped with associated warnings! The insulation should be designed for the maximum conductor voltage of the system to be measured!

The EL34xx allows a maximum voltage of 480 V for normal operating conditions. The conductor voltage on the current side must not exceed this value! For higher voltages, an intermediate transformer stage should be used!

An EL34xx is equipped with a protection impedance of typically 1.2 M $\Omega$  on the voltage measurement side. If the neutral conductor is not connected and only one connection on the side of the voltage measurement is live, the resulting voltage against earth in a 3-phase system with a phase-to-phase voltage of 400 V<sub>AC</sub> is 230 V<sub>AC</sub>. This should also be measured on the side of the current measurement using a multimeter with an internal resistance of 10 M $\Omega$ , which does not represent an insulation fault.

## Connection cable for current transformers

Please note the following minimum power values for current transformers to be connected:

	Rated secondary transformer current							
	1 A	1 A	1 A	1 A	5 A	5 A	5 A	5 A
<b>Cross-section</b>	0.5 mm <sup>2</sup>	1 mm <sup>2</sup>	1.5 mm <sup>2</sup>	2.5 mm <sup>2</sup>	0.5 mm <sup>2</sup>	1 mm <sup>2</sup>	1.5 mm <sup>2</sup>	2.5 mm <sup>2</sup>
<b>1 m</b>	0.3	0.2	0.2	0.2	2.4	1.3	0.9	0.6
<b>2 m</b>	0.4	0.3	0.3	0.2	4.6	2.4	1.7	1.1
<b>3 m</b>	0.5	0.3	0.3	0.3	6.8	3.5	2.4	1.5
<b>4 m</b>	0.6	0.4	0.3	0.3	9.0	4.6	3.1	2.0
<b>5 m</b>	0.6	0.4	0.3	0.3	11.2	5.7	3.9	2.4
<b>10 m</b>	1.1	0.6	0.5	0.4	22.2	11.2	7.5	4.6
<b>20 m</b>	2.0	1.1	0.8	0.6	44.2	22.2	14.9	9.0
<b>30 m</b>	2.8	1.5	1.1	0.7	66.2	33.2	22.2	13.4
<b>40 m</b>	3.7	2.0	1.4	0.9	88.2	44.2	29.5	17.8
<b>50 m</b>	4.6	2.4	1.7	1.1	110.2	55.2	36.9	22.2
<b>100 m</b>	9.0	4.6	3.1	2.0	220.2	110.2	73.5	44.2
<b>Cable length</b>	Minimum operating load in VA for current transformers with copper cables and 80 °C operating temperature							

## Additional measuring devices in the current circuit

Please note that the addition of additional measuring devices (e.g. ammeters) in the current circuit can lead to a significant increase in the total apparent power.

Furthermore, connection I<sub>N</sub> of the EL34xx must represent a star point for the three secondary windings. Additional measuring devices therefore have to be potential-free and must be wired accordingly.

## 3.9 Start

For commissioning:

- mount the EL34xx as described in the chapter [Mounting and wiring \[▶ 67\]](#)
- configure the EL34xx in TwinCAT as described in the chapter [Commissioning \[▶ 106\]](#).

## 4 Basics communication

### 4.1 EtherCAT basics

Please refer to the [EtherCAT System Documentation](#) for the EtherCAT fieldbus basics.

### 4.2 EtherCAT cabling – wire-bound

The cable length between two EtherCAT devices must not exceed 100 m. This results from the FastEthernet technology, which, above all for reasons of signal attenuation over the length of the cable, allows a maximum link length of 5 + 90 + 5 m if cables with appropriate properties are used. See also the [Design recommendations for the infrastructure for EtherCAT/Ethernet](#).

#### Cables and connectors

For connecting EtherCAT devices only Ethernet connections (cables + plugs) that meet the requirements of at least category 5 (Cat5) according to EN 50173 or ISO/IEC 11801 should be used. EtherCAT uses 4 wires for signal transfer.

EtherCAT uses RJ45 plug connectors, for example. The pin assignment is compatible with the Ethernet standard (ISO/IEC 8802-3).

Pin	Color of conductor	Signal	Description
1	yellow	TD +	Transmission Data +
2	orange	TD -	Transmission Data -
3	white	RD +	Receiver Data +
6	blue	RD -	Receiver Data -

Due to automatic cable detection (auto-crossing) symmetric (1:1) or cross-over cables can be used between EtherCAT devices from Beckhoff.

#### ● Recommended cables



- It is recommended to use the appropriate Beckhoff components e.g.
- cable sets ZK1090-9191-xxxx respectively
  - RJ45 connector, field assembly ZS1090-0005
  - EtherCAT cable, field assembly ZB9010, ZB9020

Suitable cables for the connection of EtherCAT devices can be found on the [Beckhoff website!](#)

#### E-Bus supply

A bus coupler can supply the EL terminals added to it with the E-bus system voltage of 5 V; a coupler is thereby loadable up to 2 A as a rule (see details in respective device documentation). Information on how much current each EL terminal requires from the E-bus supply is available online and in the catalogue. If the added terminals require more current than the coupler can supply, then power feed terminals (e.g. [EL9410](#)) must be inserted at appropriate places in the terminal strand.

The pre-calculated theoretical maximum E-Bus current is displayed in the TwinCAT System Manager. A shortfall is marked by a negative total amount and an exclamation mark; a power feed terminal is to be placed before such a position.

The screenshot shows the I/O Devices tree on the left and a table on the right. The table lists 9 terminals with their respective current values in the E-Bus (mA) column. The E-Bus column is highlighted with a red box.

Number	Box Name	Add...	Type	In Si...	Out ...	E-Bus (mA)
1	Term 1 (EK1100)	1001	EK1100			
2	Term 2 (EL2008)	1002	EL2008		1.0	1890
3	Term 3 (EL2008)	1003	EL2008		1.0	1780
4	Term 4 (EL2008)	1004	EL2008		1.0	1670
5	Term 5 (EL6740-...)	1005	EL6740-0010	2.0	2.0	1220
6	Term 6 (EL6740-...)	1006	EL6740-0010	2.0	2.0	770
7	Term 7 (EL6740-...)	1007	EL6740-0010	2.0	2.0	320
8	Term 8 (EL6740-...)	1008	EL6740-0010	2.0	2.0	-130 I
9	Term 9 (EL6740-...)	1009	EL6740-0010	2.0	2.0	-580 I

Fig. 21: System manager current calculation

**NOTICE**

**Malfunction possible!**  
 The same ground potential must be used for the E-Bus supply of all EtherCAT terminals in a terminal block!

### 4.3 General notes for setting the watchdog

The EtherCAT terminals are equipped with a safety device (watchdog) which, e. g. in the event of interrupted process data traffic, switches the outputs (if present) to a presettable state after a presettable time, depending on the device and setting, e. g. to FALSE (off) or an output value.

The EtherCAT slave controller (ESC) features two watchdogs:

- SM watchdog (default: 100 ms)
- PDI watchdog (default: 100 ms)

Their times are individually parameterized in TwinCAT as follows:

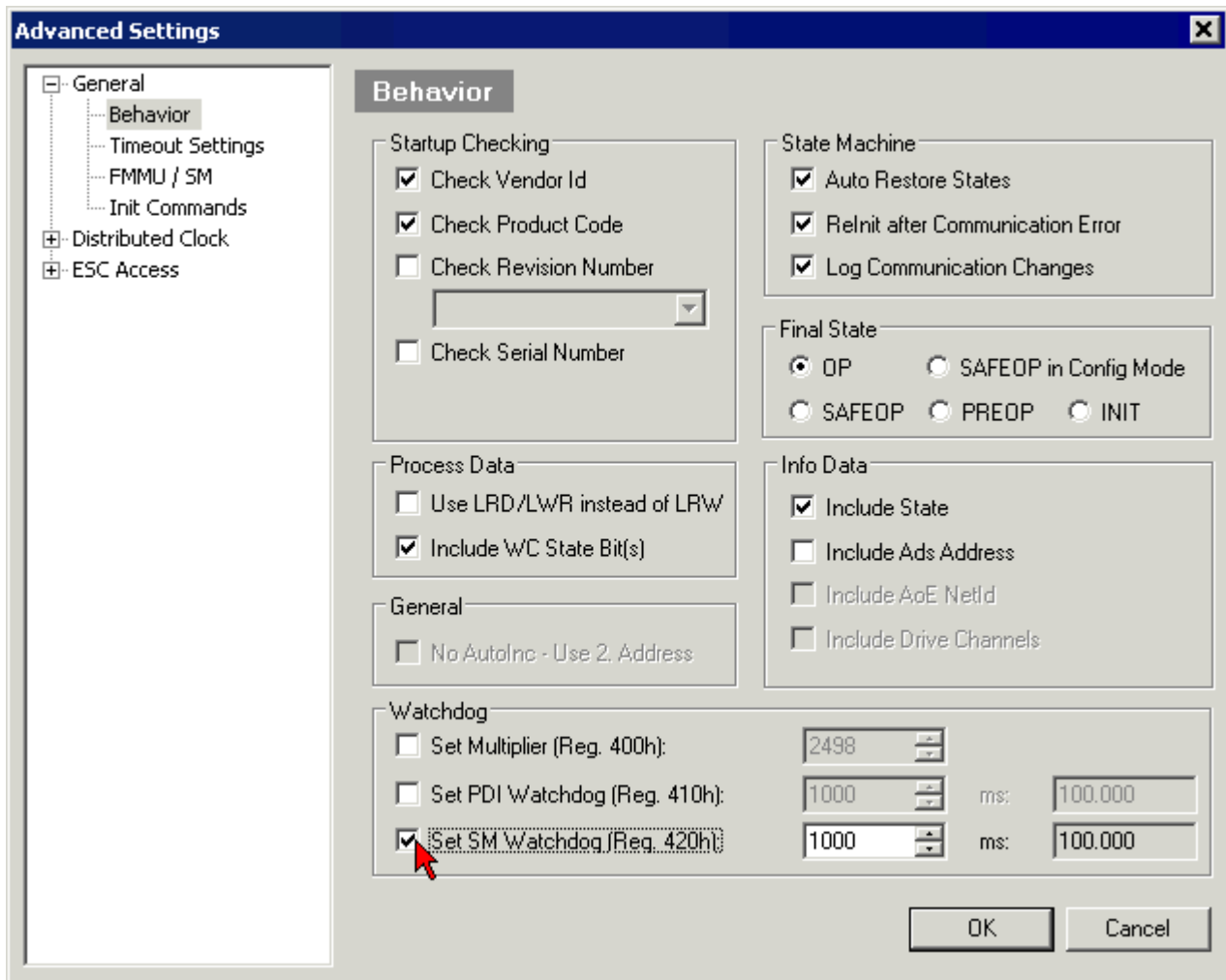

Fig. 22: eEtherCAT tab -> Advanced Settings -> Behavior -> Watchdog

#### Notes:

- the Multiplier Register 400h (hexadecimal, i. e. x0400) is valid for both watchdogs.
- each watchdog has its own timer setting 410h or 420h, which together with the Multiplier results in a resulting time.
- important: the Multiplier/Timer setting is only loaded into the slave at EtherCAT startup if the checkbox in front of it is activated.
- if it is not checked, nothing is downloaded and the setting located in the ESC remains unchanged.
- the downloaded values can be seen in the ESC registers x0400/0410/0420: ESC Access -> Memory

#### SM watchdog (SyncManager Watchdog)

The SyncManager watchdog is reset with each successful EtherCAT process data communication with the terminal. If, for example, no EtherCAT process data communication with the terminal takes place for longer than the set and activated SM watchdog time due to a line interruption, the watchdog is triggered. The status of the terminal (usually OP) remains unaffected. The watchdog is only reset again by a successful EtherCAT process data access.

The SyncManager watchdog is therefore a monitoring for correct and timely process data communication with the ESC from the EtherCAT side.

The maximum possible watchdog time depends on the device. For example, for "simple" EtherCAT slaves (without firmware) with watchdog execution in the ESC it is usually up to 170 seconds. For complex EtherCAT slaves (with firmware) the SM watchdog function is usually parameterized via Reg. 400/420 but executed by the  $\mu$ C and can be significantly lower. In addition, the execution may then be subject to a certain time uncertainty. Since the TwinCAT dialog may allow inputs up to 65535, a test of the desired watchdog time is recommended.

### PDI watchdog (Process Data Watchdog)

If there is no PDI communication with the EtherCAT slave controller (ESC) for longer than the set and activated PDI watchdog time, this watchdog is triggered.

PDI (Process Data Interface) is the internal interface of the ESC, e.g. to local processors in the EtherCAT slave. With the PDI watchdog this communication can be monitored for failure.

The PDI watchdog is therefore a monitoring for correct and timely process data communication with the ESC, but viewed from the application side.

### Calculation

Watchdog time =  $[1/25 \text{ MHz} * (\text{Watchdog multiplier} + 2)] * \text{PDI/SM watchdog}$

Example: default setting Multiplier=2498, SM watchdog=1000 -> 100 ms

The value in Multiplier + 2 corresponds to the number of 40ns base ticks representing one watchdog tick.

#### ⚠ CAUTION

##### Undefined state possible!

The function for switching off the SM watchdog via SM watchdog = 0 is only implemented in terminals from version -0016. In previous versions this operating mode should not be used.

#### ⚠ CAUTION

##### Damage of devices and undefined state possible!

If the SM watchdog is activated and a value of 0 is entered the watchdog switches off completely. This is the deactivation of the watchdog! Set outputs are NOT set in a safe state if the communication is interrupted.

## 4.4 EtherCAT State Machine

The state of the EtherCAT slave is controlled via the EtherCAT State Machine (ESM). Depending upon the state, different functions are accessible or executable in the EtherCAT slave. Specific commands must be sent by the EtherCAT master to the device in each state, particularly during the bootup of the slave.

A distinction is made between the following states:

- Init
- Pre-Operational
- Safe-Operational and
- Operational
- Boot

The regular state of each EtherCAT slave after bootup is the OP state.

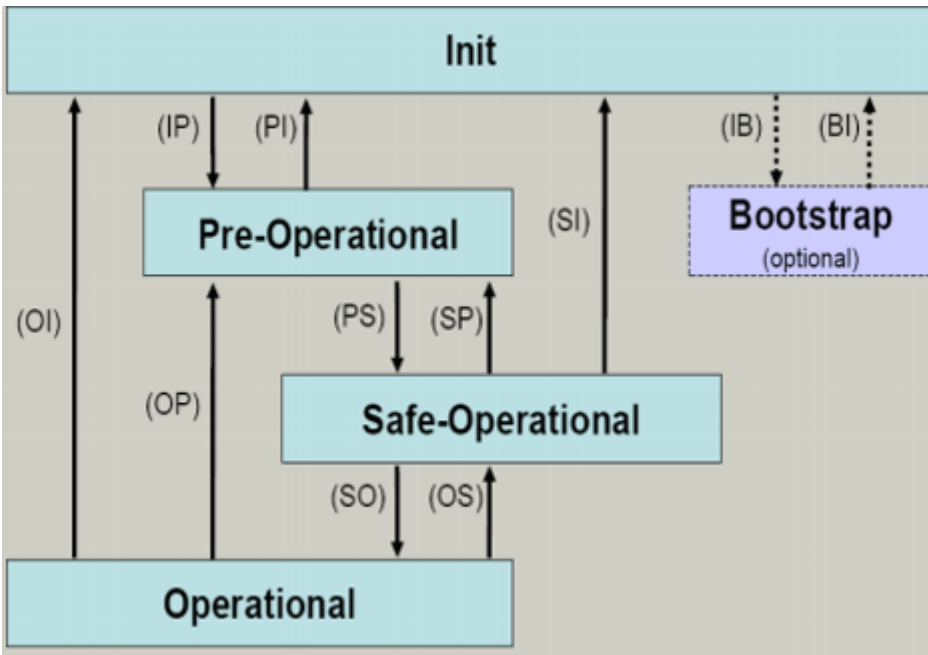

Fig. 23: States of the EtherCAT State Machine

**Init**

After switch-on the EtherCAT slave in the *Init* state. No mailbox or process data communication is possible. The EtherCAT master initializes sync manager channels 0 and 1 for mailbox communication.

**Pre-Operational (Pre-Op)**

During the transition between *Init* and *Pre-Op* the EtherCAT slave checks whether the mailbox was initialized correctly.

In *Pre-Op* state mailbox communication is possible, but not process data communication. The EtherCAT master initializes the sync manager channels for process data (from sync manager channel 2), the FMMU channels and, if the slave supports configurable mapping, PDO mapping or the sync manager PDO assignment. In this state the settings for the process data transfer and perhaps terminal-specific parameters that may differ from the default settings are also transferred.

**Safe-Operational (Safe-Op)**

During transition between *Pre-Op* and *Safe-Op* the EtherCAT slave checks whether the sync manager channels for process data communication and, if required, the distributed clocks settings are correct. Before it acknowledges the change of state, the EtherCAT slave copies current input data into the associated DP-RAM areas of the EtherCAT slave controller (ECSC).

In *Safe-Op* state mailbox and process data communication is possible, although the slave keeps its outputs in a safe state, while the input data are updated cyclically.

**● Outputs in SAFEOP state**

**i** The default set watchdog monitoring sets the outputs of the module in a safe state - depending on the settings in SAFEOP and OP - e.g. in OFF state. If this is prevented by deactivation of the watchdog monitoring in the module, the outputs can be switched or set also in the SAFEOP state.

**Operational (Op)**

Before the EtherCAT master switches the EtherCAT slave from *Safe-Op* to *Op* it must transfer valid output data.

In the *Op* state the slave copies the output data of the masters to its outputs. Process data and mailbox communication is possible.



## Boot

In the *Boot* state the slave firmware can be updated. The *Boot* state can only be reached via the *Init* state.

In the *Boot* state mailbox communication via the *file access over EtherCAT* (FoE) protocol is possible, but no other mailbox communication and no process data communication.

## 4.5 CoE Interface

### General description

The CoE interface (CAN application protocol over EtherCAT) is used for parameter management of EtherCAT devices. EtherCAT slaves or the EtherCAT master manage fixed (read only) or variable parameters which they require for operation, diagnostics or commissioning.

CoE parameters are arranged in a table hierarchy. In principle, the user has read access via the fieldbus. The EtherCAT master (TwinCAT System Manager) can access the local CoE lists of the slaves via EtherCAT in read or write mode, depending on the attributes.

Different CoE parameter types are possible, including string (text), integer numbers, Boolean values or larger byte fields. They can be used to describe a wide range of features. Examples of such parameters include manufacturer ID, serial number, process data settings, device name, calibration values for analog measurement or passwords.

The order is specified in two levels via hexadecimal numbering: (main)index, followed by subindex. The value ranges are

- Index: 0x0000 ... 0xFFFF (0...65535<sub>dec</sub>)
- SubIndex: 0x00...0xFF (0...255<sub>dec</sub>)

A parameter localized in this way is normally written as 0x8010:07, with preceding "0x" to identify the hexadecimal numerical range and a colon between index and subindex.

The relevant ranges for EtherCAT fieldbus users are:

- 0x1000: This is where fixed identity information for the device is stored, including name, manufacturer, serial number etc., plus information about the current and available process data configurations.
- 0x8000: This is where the operational and functional parameters for all channels are stored, such as filter settings or output frequency.

Other important ranges are:

- 0x4000: here are the channel parameters for some EtherCAT devices. Historically, this was the first parameter area before the 0x8000 area was introduced. EtherCAT devices that were previously equipped with parameters in 0x4000 and changed to 0x8000 support both ranges for compatibility reasons and mirror internally.
- 0x6000: Input PDOs ("input" from the perspective of the EtherCAT master)
- 0x7000: Output PDOs ("output" from the perspective of the EtherCAT master)

---

### **i** Availability

Not every EtherCAT device must have a CoE list. Simple I/O modules without dedicated processor usually have no variable parameters and therefore no CoE list.

---

If a device has a CoE list, it is shown in the TwinCAT System Manager as a separate tab with a listing of the elements:

Index	Name	Flags	Value
1000	Device type	RO	0x00FA1389 (16389001)
1008	Device name	RO	EL2502-0000
1009	Hardware version	RO	
100A	Software version	RO	
1011:0	Restore default parameters	RO	> 1 <
1018:0	Identity	RO	> 4 <
1018:01	Vendor ID	RO	0x00000002 (2)
1018:02	Product code	RO	0x09C63052 (163983442)
1018:03	Revision	RO	0x00130000 (1245184)
1018:04	Serial number	RO	0x00000000 (0)
10F0:0	Backup parameter handling	RO	> 1 <
1400:0	PwM RxDPO-Par Ch.1	RO	> 6 <
1401:0	PwM RxDPO-Par Ch.2	RO	> 6 <
1402:0	PwM RxDPO-Par h.1 Ch.1	RO	> 6 <
1403:0	PwM RxDPO-Par h.1 Ch.2	RO	> 6 <
1600:0	PwM RxDPO-Map Ch.1	RO	> 1 <

Fig. 24: "CoE Online" tab

The figure above shows the CoE objects available in device "EL2502", ranging from 0x1000 to 0x1600. The subindices for 0x1018 are expanded.

### NOTICE

#### Changes in the CoE directory (CAN over EtherCAT), program access

When using/manipulating the CoE parameters observe the general CoE notes in chapter "[CoE interface](#)" of the EtherCAT system documentation:

- Keep a startup list if components have to be replaced,
- Distinction between online/offline dictionary,
- Existence of current XML description (download from the [Beckhoff website](#)),
- "CoE-Reload" for resetting the changes
- Program access during operation via PLC (see [TwinCAT3 | PLC Library: Tc2\\_EtherCAT](#) and [Example program R/W CoE](#))

#### Data management and function "NoCoeStorage"

Some parameters, particularly the setting parameters of the slave, are configurable and writeable. This can be done in write or read mode

- via the System Manager (Fig. "CoE Online" tab) by clicking  
This is useful for commissioning of the system/slaves. Click on the row of the index to be parameterized and enter a value in the "SetValue" dialog.
- from the control system/PLC via ADS, e.g. through blocks from the TcEtherCAT.lib library  
This is recommended for modifications while the system is running or if no System Manager or operating staff are available.

**i Data management**

If slave CoE parameters are modified online, Beckhoff devices store any changes in a fail-safe manner in the EEPROM, i.e. the modified CoE parameters are still available after a restart. The situation may be different with other manufacturers.

An EEPROM is subject to a limited lifetime with respect to write operations. From typically 100,000 write operations onwards it can no longer be guaranteed that new (changed) data are reliably saved or are still readable. This is irrelevant for normal commissioning. However, if CoE parameters are continuously changed via ADS at machine runtime, it is quite possible for the lifetime limit to be reached. Support for the NoCoeStorage function, which suppresses the saving of changed CoE values, depends on the firmware version.

Please refer to the technical data in this documentation as to whether this applies to the respective device.

- If the function is supported: the function is activated by entering the code word 0x12345678 once in CoE 0xF008 and remains active as long as the code word is not changed. After switching the device on it is then inactive. Changed CoE values are not saved in the EEPROM and can thus be changed any number of times.
- Function is not supported: continuous changing of CoE values is not permissible in view of the lifetime limit.

**i Startup list**

Changes in the local CoE list of the terminal are lost if the terminal is replaced. If a terminal is replaced with a new Beckhoff terminal, it will have the default settings. It is therefore advisable to link all changes in the CoE list of an EtherCAT slave with the Startup list of the slave, which is processed whenever the EtherCAT fieldbus is started. In this way a replacement EtherCAT slave can automatically be parameterized with the specifications of the user.

If EtherCAT slaves are used which are unable to store local CoE values permanently, the Startup list must be used.

**Recommended approach for manual modification of CoE parameters**

- Make the required change in the System Manager  
The values are stored locally in the EtherCAT slave
- If the value is to be stored permanently, enter it in the Startup list.  
The order of the Startup entries is usually irrelevant.

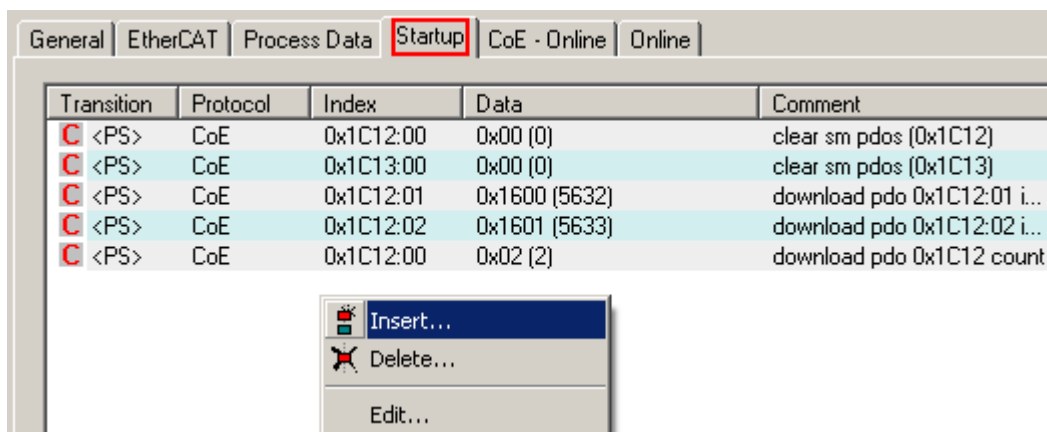

Fig. 25: Startup list in the TwinCAT System Manager

The Startup list may already contain values that were configured by the System Manager based on the ESI specifications. Additional application-specific entries can be created.

**Online/offline list**

While working with the TwinCAT System Manager, a distinction has to be made whether the EtherCAT device is “available”, i.e. switched on and linked via EtherCAT and therefore **online**, or whether a configuration is created **offline** without connected slaves.

In both cases a CoE list as shown in Fig. “CoE online tab” is displayed. The connectivity is shown as offline/online.

- If the slave is offline
  - The offline list from the ESI file is displayed. In this case modifications are not meaningful or possible.
  - The configured status is shown under Identity.
  - No firmware or hardware version is displayed, since these are features of the physical device.
  - **Offline** is shown in red.

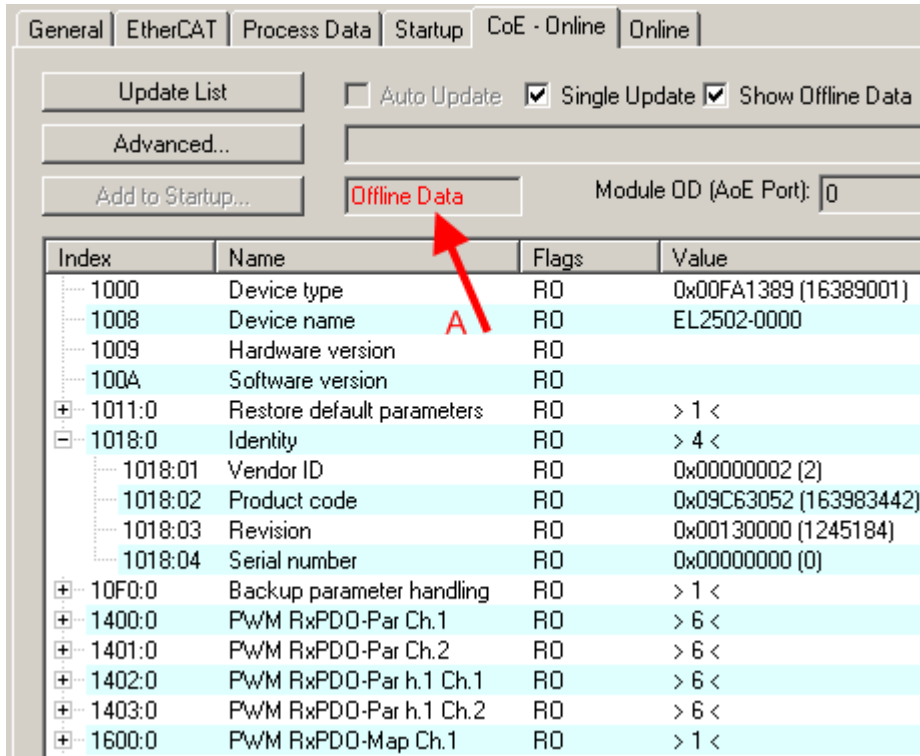

The screenshot shows the 'CoE - Online' tab in the software interface. The 'Offline Data' section is highlighted in red, and a red arrow points to the 'Offline Data' label. The table below shows the offline data for various device parameters.

Index	Name	Flags	Value
1000	Device type	RO	0x00FA1389 (16389001)
1008	Device name	RO	EL2502-0000
1009	Hardware version	RO	
100A	Software version	RO	
1011:0	Restore default parameters	RO	> 1 <
1018:0	Identity	RO	> 4 <
1018:01	Vendor ID	RO	0x00000002 (2)
1018:02	Product code	RO	0x09C63052 (163983442)
1018:03	Revision	RO	0x00130000 (1245184)
1018:04	Serial number	RO	0x00000000 (0)
10F0:0	Backup parameter handling	RO	> 1 <
1400:0	PWM RxDPO-Par Ch.1	RO	> 6 <
1401:0	PWM RxDPO-Par Ch.2	RO	> 6 <
1402:0	PWM RxDPO-Par h.1 Ch.1	RO	> 6 <
1403:0	PWM RxDPO-Par h.1 Ch.2	RO	> 6 <
1600:0	PWM RxDPO-Map Ch.1	RO	> 1 <

Fig. 26: Offline list

- If the slave is online
  - The actual current slave list is read. This may take several seconds, depending on the size and cycle time.
  - The actual identity is displayed
  - The firmware and hardware version of the equipment according to the electronic information is displayed
  - **Online** is shown in green.

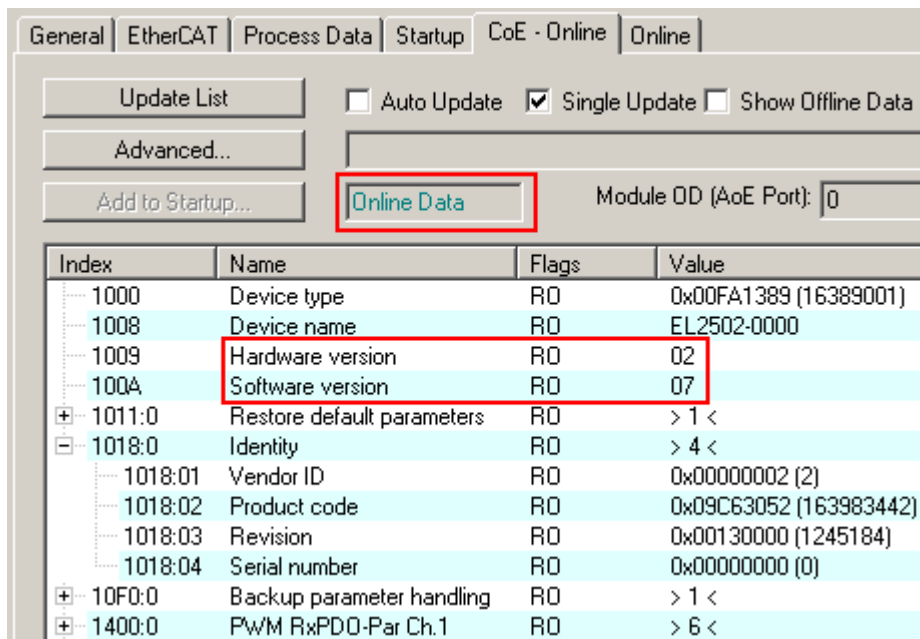

Fig. 27: Online list

**Channel-based order**

The CoE list is available in EtherCAT devices that usually feature several functionally equivalent channels. For example, a 4-channel analog 0...10 V input terminal also has four logical channels and therefore four identical sets of parameter data for the channels. In order to avoid having to list each channel in the documentation, the placeholder “n” tends to be used for the individual channel numbers.

In the CoE system 16 indices, each with 255 subindices, are generally sufficient for representing all channel parameters. The channel-based order is therefore arranged in  $16_{dec}/10_{hex}$  steps. The parameter range 0x8000 exemplifies this:

- Channel 0: parameter range 0x8000:00 ... 0x800F:255
- Channel 1: parameter range 0x8010:00 ... 0x801F:255
- Channel 2: parameter range 0x8020:00 ... 0x802F:255
- ...

This is generally written as 0x80n0.

Detailed information on the CoE interface can be found in the [EtherCAT system documentation](#) on the Beckhoff website.

## 4.6 Distributed Clock

The distributed clock represents a local clock in the EtherCAT slave controller (ESC) with the following characteristics:

- Unit *1 ns*
- Zero point *1.1.2000 00:00*
- Size *64 bit* (sufficient for the next 584 years; however, some EtherCAT slaves only offer 32-bit support, i.e. the variable overflows after approx. 4.2 seconds)
- The EtherCAT master automatically synchronizes the local clock with the master clock in the EtherCAT bus with a precision of *< 100 ns*.

For detailed information please refer to the [EtherCAT system description](#).

## 5 Mounting and wiring

### 5.1 Instructions for ESD protection

#### NOTICE

##### **Destruction of the devices by electrostatic discharge possible!**

The devices contain components at risk from electrostatic discharge caused by improper handling.

- Please ensure you are electrostatically discharged and avoid touching the contacts of the device directly.
- Avoid contact with highly insulating materials (synthetic fibers, plastic film etc.).
- Surroundings (working place, packaging and personnel) should be grounded probably, when handling with the devices.
- Each assembly must be terminated at the right hand end with an [EL9011](#) or [EL9012](#) bus end cap, to ensure the protection class and ESD protection.

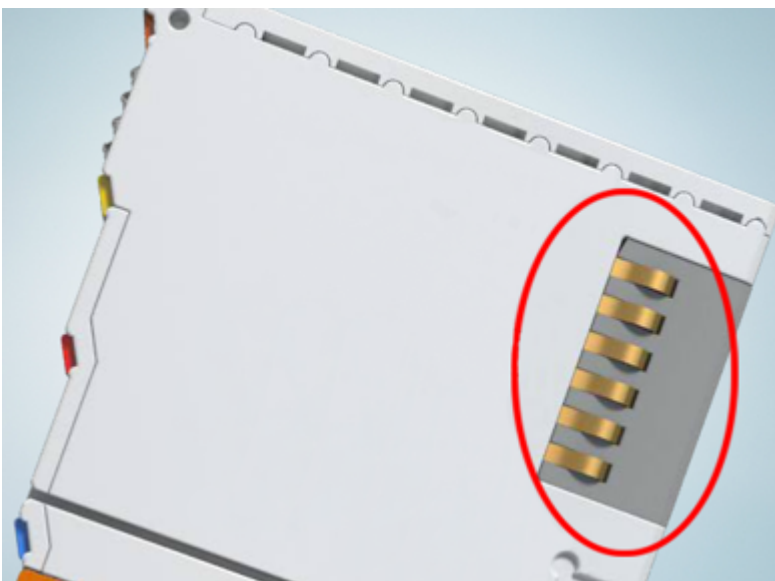

Fig. 28: Spring contacts of the Beckhoff I/O components

## 5.2 Note on Beckhoff calibration certificates

Basically every Beckhoff analogue device (input or output) will be justified i.e. will be calibrated during production. This procedure won't be documented unique. This documentation as a calibration certificate is only provided for devices that are expressly delivered with a certificate.

The calibration certificate (or German: "Kalibrierschein") entitles the residual error after compensation/adjustment to the used standard (reference device). The calibration certificate (as a PDF document) is to be assigned to the device via a unique number. It is therefore not a statement about a device class such as e.g. an approval, but always only applies to a single, named device. It is available for [download](#).

The calibration certificate documents the measurement accuracy at the time the certificate was issued and contains, among other things, information on the ambient conditions and the reference instrument used. It does not contain statement about the behavior or the change of the measuring accuracy in the future. A calibration certificate acts as a backtracking view to the previous time of usage. By reiterated certification procedures over years (without justification) it allows making conclusions about its ageing behavior, so called calibrate history.

### Performance levels of the calibration certificates

Different "qualities" of a calibration certificate are common:

- Beckhoff calibration certificates  
Such IP20 terminals can be usually identified by the product suffix -0020. The certificate is issued in Beckhoff production as PDF.  
The terminals can be obtained from Beckhoff and recalibrated by the Beckhoff service department.
- ISO17025 calibration certificates  
Such IP20 terminals can be usually identified by the product suffix -0030. The certificate is issued by a service provider on behalf of Beckhoff as part of Beckhoff production and delivered by Beckhoff as a PDF.  
The terminals can be obtained from Beckhoff and recalibrated by the Beckhoff service department.
- DAkkS calibration certificates (German: "Deutsche Akkreditierungsstelle GmbH")  
Such IP20 terminals can be usually identified by the product suffix -0030. The certificate is issued by a accredited service provider on behalf of Beckhoff as a part of Beckhoff production and delivered by Beckhoff as a PDF.  
The terminals can be obtained from Beckhoff and recalibrated by the Beckhoff service department.



**Unique device number**

Depending on the device, the following numbers are used for identification:

- EL/ELM terminals up to year of manufacture 2020: the ID number which is lasered on the side.



Fig. 29: ID number



- From year of manufacture 2021 onwards, the BTN number (Beckhoff Traceability Number) will gradually replace the ID number, this is also lasered on the side.

Beckhoff produces a wide range of analog input/output devices as IP20 terminal or IP67 box. A selection of these is also available with factory/ISO/DAkkS calibration certificates. For specific details and availability, see the technical data of the devices or contact Beckhoff Sales.

**● Linguistic note**

**i** In American English, "calibration" or "alignment" is understood to mean compensation/adjustment, thus a modifying effect on the device. "Verification", on the other hand, refers to observational determination and documentation of the residual error, referred in German language use as "*Kalibrierung*".

## 5.3 UL notice

⚠ CAUTION	
	<p><b>Application</b> Beckhoff EtherCAT modules are intended for use with Beckhoff's UL Listed EtherCAT System only.</p>
⚠ CAUTION	
	<p><b>Examination</b> For cULus examination, the Beckhoff I/O System has only been investigated for risk of fire and electrical shock.</p>
⚠ CAUTION	
	<p><b>For devices with Ethernet connectors</b> Not for connection to telecommunication circuits.</p>

### Special conditions for intended use

1. For use with Listed current transformers suitably rated for the application only, terminals EL3453 and EL3783 may also measure the current directly.
2. Connected wires must be rated min. 75°C, 300 V or 600 V (depends on rated voltage of EtherCAT Terminal) and be made of copper.
3. If the equipment is used in a manner not specified by the manufacturer, the protection provided by the equipment may be impaired.
4. Pollution degree 2.
5. Requirements related to the external current transformers as per annex DVE of UL/CSA 61010-1:
  1. **WARNING** To reduce risk of electric shock, always open or disconnect circuit from power-distribution system (or service) of building before installing or servicing current transformers or equivalent.
  2. Per DVE.3.2.1:
    - Always open or disconnect circuit from power-distribution system (or service) of building before installing or servicing current transformers.
    - The current transformers may not be installed in equipment where they exceed 75 percent of the wiring space of any cross-sectional area within the equipment.
    - Restrict installation of current transformer in an area where it would block ventilation openings.
    - Restrict installation of current transformer in an area of breaker arc venting.
    - Not suitable for Class 2 wiring methods and not intended for connection to Class 2 equipment.
    - Secure current transformer and route conductors so that the conductors do not directly contact live terminals or bus.

## 5.4 Installation on mounting rails

### ⚠ WARNING

#### Risk of electric shock and damage of device!

Bring the bus terminal system into a safe, powered down state before starting installation, disassembly or wiring of the bus terminals!

The Bus Terminal system and is designed for mounting in a control cabinet or terminal box.

#### Assembly

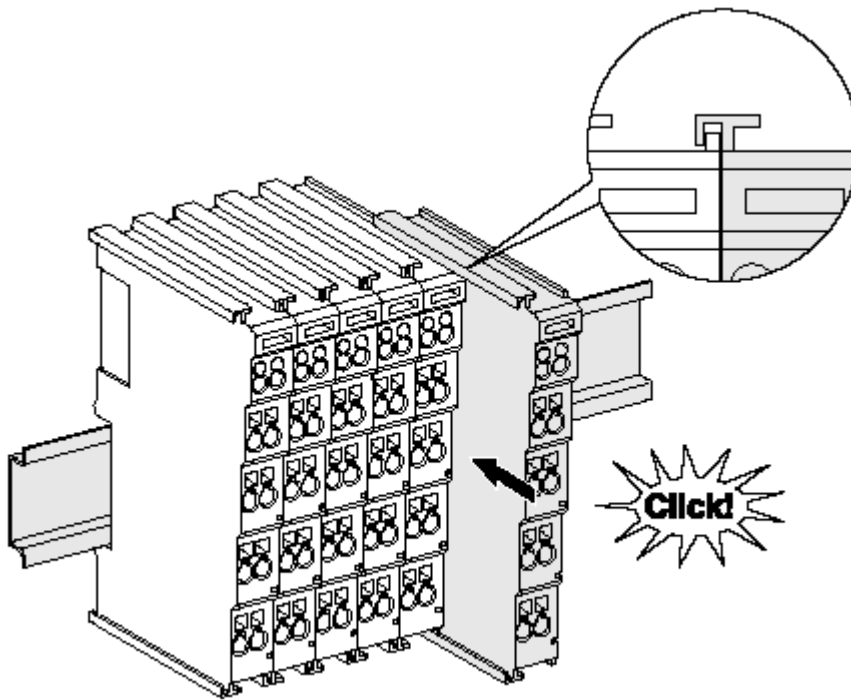

Fig. 30: Attaching on mounting rail

The bus coupler and bus terminals are attached to commercially available 35 mm mounting rails (DIN rails according to EN 60715) by applying slight pressure:

1. First attach the fieldbus coupler to the mounting rail.
2. The bus terminals are now attached on the right-hand side of the fieldbus coupler. Join the components with tongue and groove and push the terminals against the mounting rail, until the lock clicks onto the mounting rail.

If the terminals are clipped onto the mounting rail first and then pushed together without tongue and groove, the connection will not be operational! When correctly assembled, no significant gap should be visible between the housings.

#### **i** Fixing of mounting rails

The locking mechanism of the terminals and couplers extends to the profile of the mounting rail. At the installation, the locking mechanism of the components must not come into conflict with the fixing bolts of the mounting rail. To mount the mounting rails with a height of 7.5 mm under the terminals and couplers, you should use flat mounting connections (e.g. countersunk screws or blind rivets).

## Disassembly

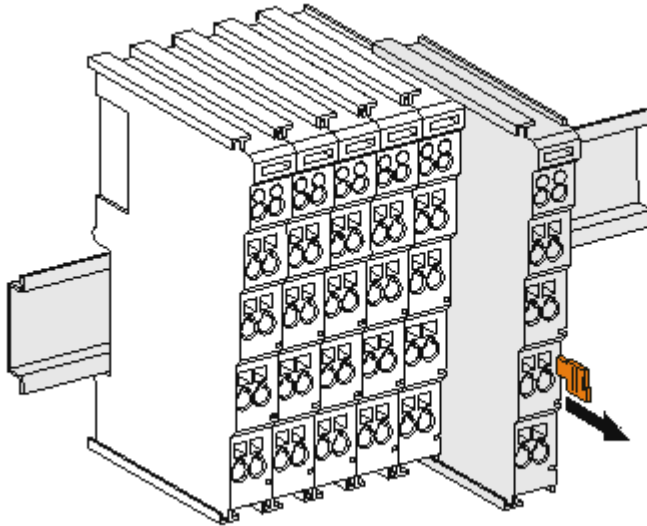

Fig. 31: Disassembling of terminal

Each terminal is secured by a lock on the mounting rail, which must be released for disassembly:

1. Pull the terminal by its orange-colored lugs approximately 1 cm away from the mounting rail. In doing so for this terminal the mounting rail lock is released automatically and you can pull the terminal out of the bus terminal block easily without excessive force.
2. Grasp the released terminal with thumb and index finger simultaneous at the upper and lower grooved housing surfaces and pull the terminal out of the bus terminal block.

## Connections within a bus terminal block

The electric connections between the Bus Coupler and the Bus Terminals are automatically realized by joining the components:

- The six spring contacts of the K-Bus/E-Bus deal with the transfer of the data and the supply of the Bus Terminal electronics.
- The power contacts deal with the supply for the field electronics and thus represent a supply rail within the bus terminal block. The power contacts are supplied via terminals on the Bus Coupler (up to 24 V) or for higher voltages via power feed terminals.

### ● Power Contacts

**i** During the design of a bus terminal block, the pin assignment of the individual Bus Terminals must be taken account of, since some types (e.g. analog Bus Terminals or digital 4-channel Bus Terminals) do not or not fully loop through the power contacts. Power Feed Terminals (KL91xx, KL92xx or EL91xx, EL92xx) interrupt the power contacts and thus represent the start of a new supply rail.

## PE power contact

The power contact labeled PE can be used as a protective earth. For safety reasons this contact mates first when plugging together, and can ground short-circuit currents of up to 125 A.

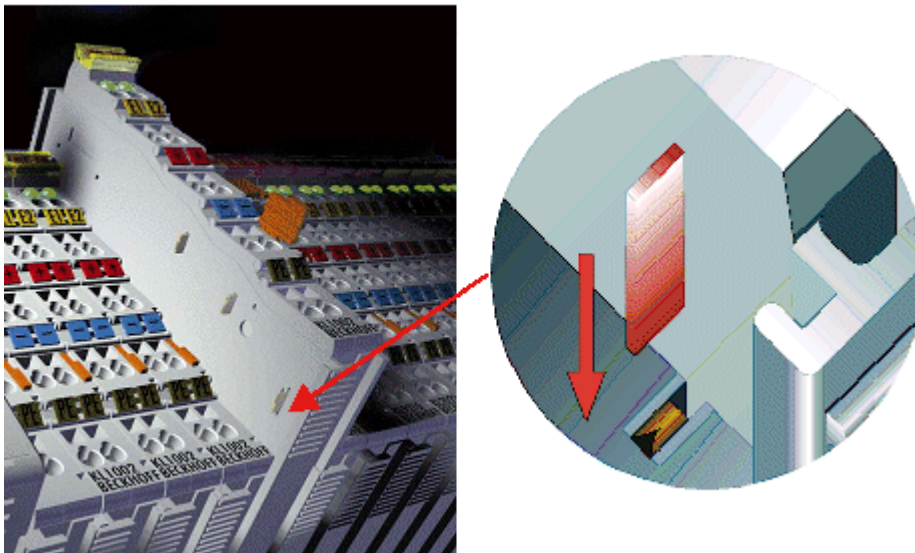

Fig. 32: Power contact on left side

### NOTICE

#### Possible damage of the device

Note that, for reasons of electromagnetic compatibility, the PE contacts are capacitatively coupled to the mounting rail. This may lead to incorrect results during insulation testing or to damage on the terminal (e.g. disruptive discharge to the PE line during insulation testing of a consumer with a nominal voltage of 230 V). For insulation testing, disconnect the PE supply line at the Bus Coupler or the Power Feed Terminal! In order to decouple further feed points for testing, these Power Feed Terminals can be released and pulled at least 10 mm from the group of terminals.

### ⚠ WARNING

#### Risk of electric shock!

The PE power contact must not be used for other potentials!

## 5.5 Connection

### 5.5.1 Connection system

#### ⚠ WARNING

#### Risk of electric shock and damage of device!

Bring the bus terminal system into a safe, powered down state before starting installation, disassembly or wiring of the bus terminals!

#### Overview

The bus terminal system offers different connection options for optimum adaptation to the respective application:

- The terminals of ELxxxx and KLxxxx series with standard wiring include electronics and connection level in a single enclosure.
- The terminals of ESxxxx and KSxxxx series feature a pluggable connection level and enable steady wiring while replacing.
- The High Density Terminals (HD Terminals) include electronics and connection level in a single enclosure and have advanced packaging density.

#### Standard wiring (ELxxxx / KLxxxx)



Fig. 33: Standard wiring

The terminals of ELxxxx and KLxxxx series have been tried and tested for years. They feature integrated screwless spring force technology for fast and simple assembly.

#### Pluggable wiring (ESxxxx / KSxxxx)



Fig. 34: Pluggable wiring

The terminals of ESxxxx and KSxxxx series feature a pluggable connection level. The assembly and wiring procedure is the same as for the ELxxxx and KLxxxx series. The pluggable connection level enables the complete wiring to be removed as a plug connector from the top of the housing for servicing. The lower section can be removed from the terminal block by pulling the unlocking tab. Insert the new component and plug in the connector with the wiring. This reduces the installation time and eliminates the risk of wires being mixed up.

The familiar dimensions of the terminal only had to be changed slightly. The new connector adds about 3 mm. The maximum height of the terminal remains unchanged.

A tab for strain relief of the cable simplifies assembly in many applications and prevents tangling of individual connection wires when the connector is removed.

Conductor cross sections between 0.08 mm<sup>2</sup> and 2.5 mm<sup>2</sup> can continue to be used with the proven spring force technology.

The overview and nomenclature of the product names for ESxxxx and KSxxxx series has been retained as known from ELxxxx and KLxxxx series.

### High Density Terminals (HD Terminals)



Fig. 35: High Density Terminals

The terminals from these series with 16 terminal points are distinguished by a particularly compact design, as the packaging density is twice as large as that of the standard 12 mm bus terminals. Massive conductors and conductors with a wire end sleeve can be inserted directly into the spring loaded terminal point without tools.

---

#### ● **Wiring HD Terminals**

**i** The High Density Terminals of the ELx8xx and KLx8xx series doesn't support pluggable wiring.

---

### Ultrasonically “bonded” (ultrasonically welded) conductors

#### ● **Ultrasonically “bonded” conductors**

**i** It is also possible to connect the Standard and High Density Terminals with ultrasonically “bonded” (ultrasonically welded) conductors. In this case, please note the tables concerning the wire-size width [[▶ 72](#)]!

---

## 5.5.2 Wiring

### ⚠ WARNING

#### Risk of electric shock and damage of device!

Bring the bus terminal system into a safe, powered down state before starting installation, disassembly or wiring of the bus terminals!

#### Terminals for standard wiring ELxxxx/KLxxxx and for pluggable wiring ESxxxx/KSxxxx

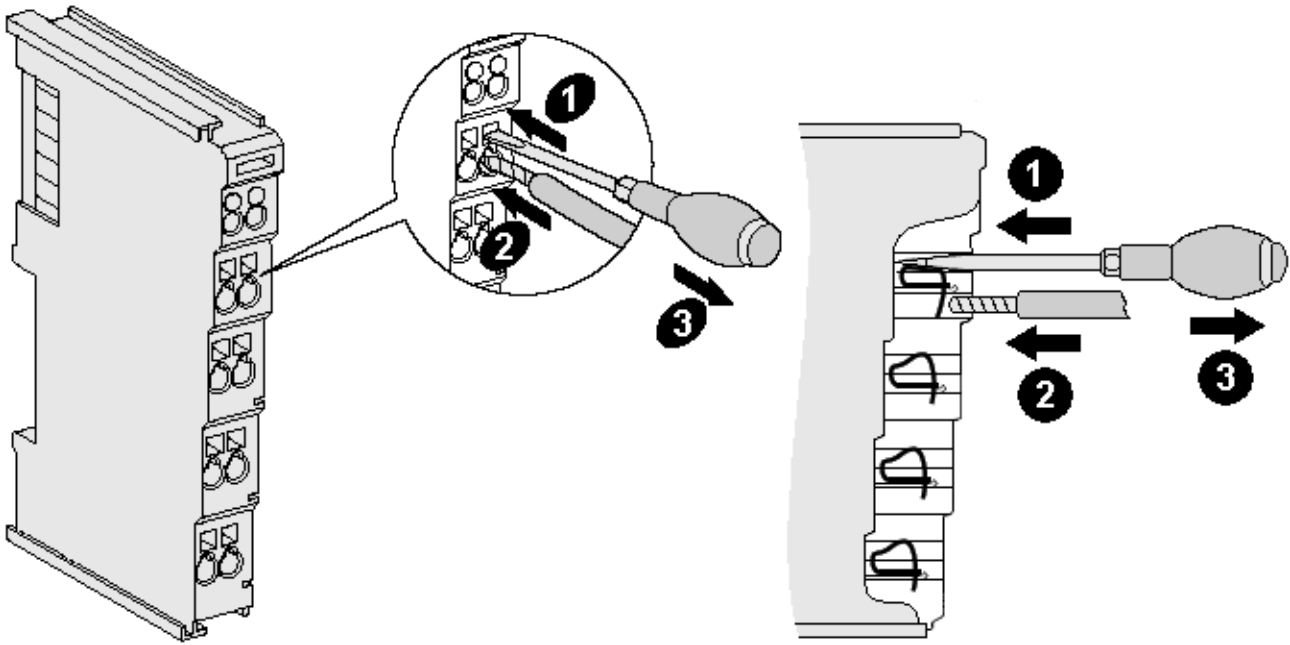

Fig. 36: Connecting a cable on a terminal point

Up to eight terminal points enable the connection of solid or finely stranded cables to the bus terminal. The terminal points are implemented in spring force technology. Connect the cables as follows:

1. Open a terminal point by pushing a screwdriver straight against the stop into the square opening above the terminal point. Do not turn the screwdriver or move it alternately (don't toggle).
2. The wire can now be inserted into the round terminal opening without any force.
3. The terminal point closes automatically when the pressure is released, holding the wire securely and permanently.

See the following table for the suitable wire size width.

Terminal housing	ELxxxx, KLxxxx	ESxxxx, KSxxxx
Wire size width (single core wires)	0.08 ... 2.5 mm <sup>2</sup>	0.08 ... 2.5 mm <sup>2</sup>
Wire size width (fine-wire conductors)	0.08 ... 2.5 mm <sup>2</sup>	0.08 ... 2.5 mm <sup>2</sup>
Wire size width (conductors with a wire end sleeve)	0.14 ... 1.5 mm <sup>2</sup>	0.14 ... 1.5 mm <sup>2</sup>
Wire stripping length	8 ... 9 mm	9 ... 10 mm

#### High Density Terminals ([HD Terminals](#) [▶ 71]) with 16 terminal points

The conductors of the HD Terminals are connected without tools for single-wire conductors using the direct plug-in technique, i.e. after stripping the wire is simply plugged into the terminal point. The cables are released, as usual, using the contact release with the aid of a screwdriver. See the following table for the suitable wire size width.



Terminal housing	High Density Housing
Wire size width (single core wires)	0.08 ... 1.5 mm <sup>2</sup>
Wire size width (fine-wire conductors)	0.25 ... 1.5 mm <sup>2</sup>
Wire size width (conductors with a wire end sleeve)	0.14 ... 0.75 mm <sup>2</sup>
Wire size width (ultrasonically "bonded" conductors)	only 1.5 mm <sup>2</sup> (see notice [▶ 71])
Wire stripping length	8 ... 9 mm

### 5.5.3 Shielding

#### ● Shielding

**i** Encoder, analog sensors and actuators should always be connected with shielded, twisted paired wires.

## 5.6 Note - Power supply

### WARNING

#### **Power supply from SELV/PELV power supply unit!**

SELV/PELV circuits (Safety Extra Low Voltage, Protective Extra Low Voltage) according to IEC 61010-2-201 must be used to supply this device.

Notes:

- SELV/PELV circuits may give rise to further requirements from standards such as IEC 60204-1 et al, for example with regard to cable spacing and insulation.
- A SELV (Safety Extra Low Voltage) supply provides safe electrical isolation and limitation of the voltage without a connection to the protective conductor,  
a PELV (Protective Extra Low Voltage) supply also requires a safe connection to the protective conductor.

## 5.7 Installation positions

**NOTICE**

**Constraints regarding installation position and operating temperature range**

Please refer to the technical data for a terminal to ascertain whether any restrictions regarding the installation position and/or the operating temperature range have been specified. When installing high power dissipation terminals ensure that an adequate spacing is maintained between other components above and below the terminal in order to guarantee adequate ventilation!

**Optimum installation position (standard)**

The optimum installation position requires the mounting rail to be installed horizontally and the connection surfaces of the EL/KL terminals to face forward (see Fig. *Recommended distances for standard installation position*). The terminals are ventilated from below, which enables optimum cooling of the electronics through convection. "From below" is relative to the acceleration of gravity.

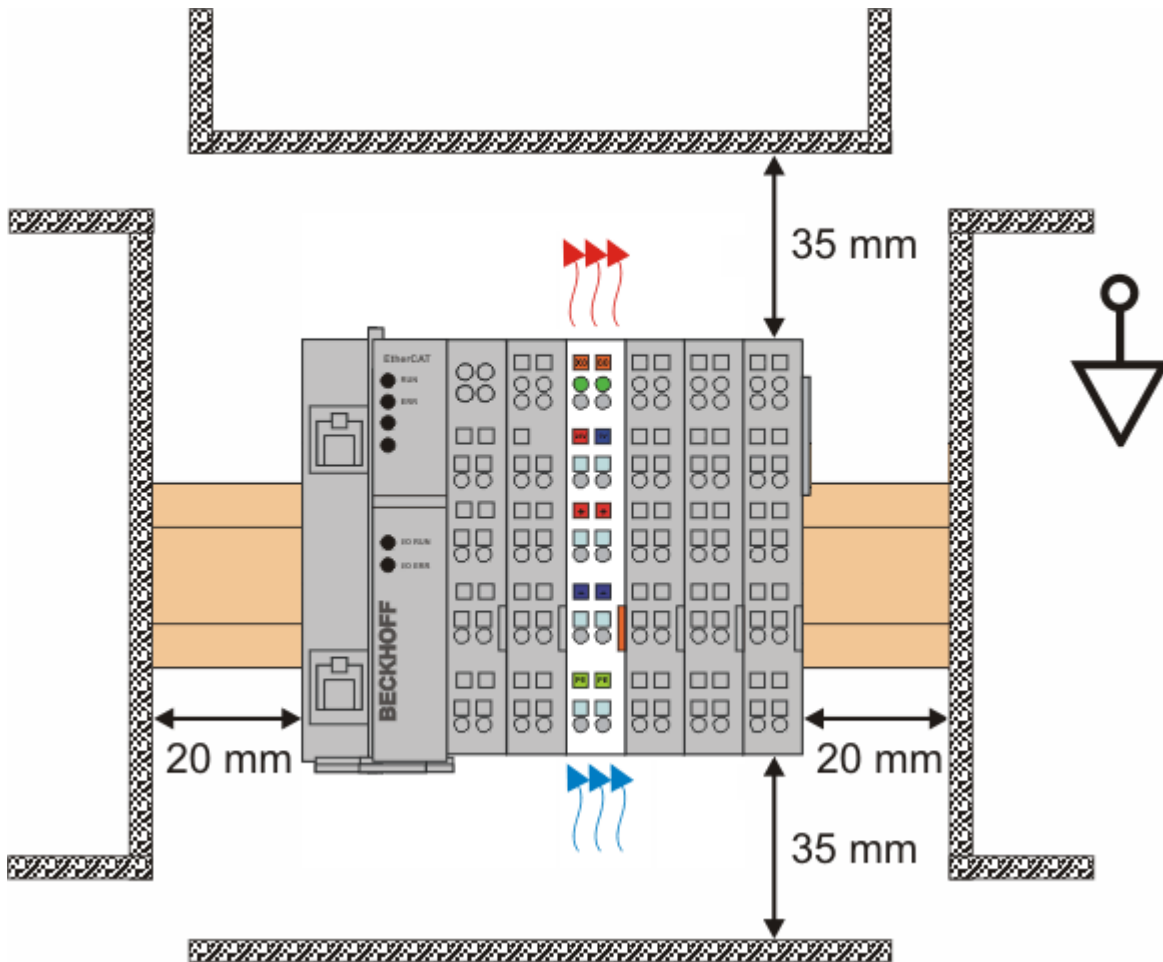

Fig. 37: Recommended distances for standard installation position

Compliance with the distances shown in Fig. *Recommended distances for standard installation position* is recommended.

**Other installation positions**

All other installation positions are characterized by different spatial arrangement of the mounting rail - see Fig *Other installation positions*.

The minimum distances to ambient specified above also apply to these installation positions.

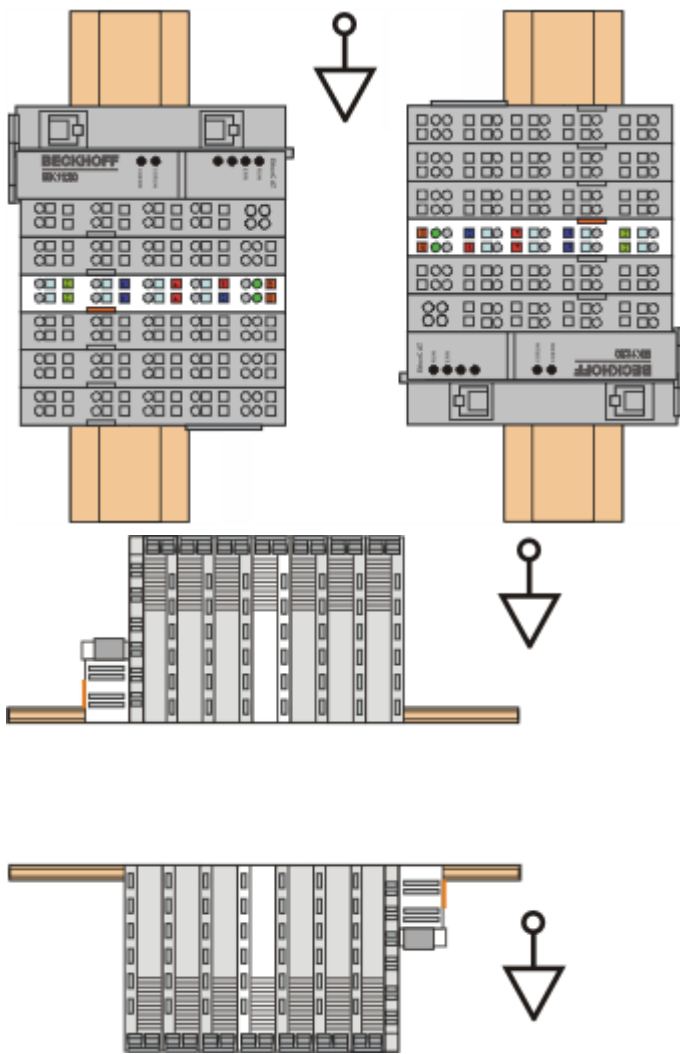

Fig. 38: Other installation positions

## 5.8 Positioning of passive Terminals

**i** **Hint for positioning of passive terminals in the bus terminal block**

EtherCAT Terminals (ELxxxx / ESxxxx), which do not take an active part in data transfer within the bus terminal block are so called passive terminals. The passive terminals have no current consumption out of the E-Bus.

To ensure an optimal data transfer, you must not directly string together more than two passive terminals!

**Examples for positioning of passive terminals (highlighted)**

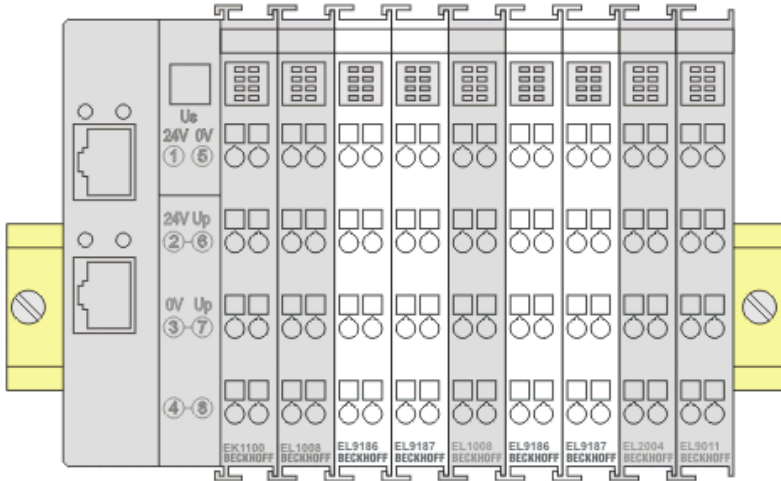

Fig. 39: Correct positioning

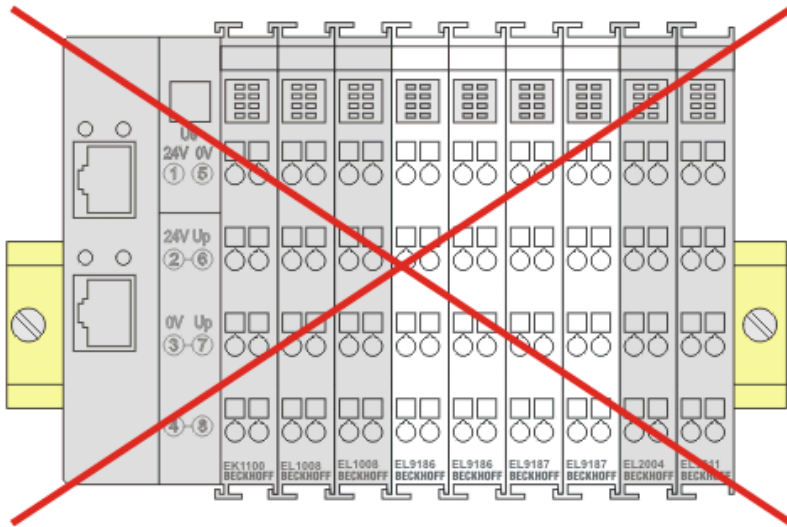

Fig. 40: Incorrect positioning

## 5.9 Disposal



Products marked with a crossed-out wheeled bin shall not be discarded with the normal waste stream. The device is considered as waste electrical and electronic equipment. The national regulations for the disposal of waste electrical and electronic equipment must be observed.

## 6 Commissioning

### 6.1 TwinCAT Quick Start

TwinCAT is a development environment for real-time control including a multi PLC system, NC axis control, programming and operation. The whole system is mapped through this environment and enables access to a programming environment (including compilation) for the controller. Individual digital or analog inputs or outputs can also be read or written directly, in order to verify their functionality, for example.

For further information, please refer to <http://infosys.beckhoff.com>:

- **EtherCAT System Manual:**  
Fieldbus Components → EtherCAT Terminals → EtherCAT System Documentation → Setup in the TwinCAT System Manager
- **TwinCAT 2** → TwinCAT System Manager → I/O Configuration
- In particular, for TwinCAT – driver installation:  
**Fieldbus components** → Fieldbus Cards and Switches → FC900x – PCI Cards for Ethernet → Installation

Devices contain the relevant terminals for the actual configuration. All configuration data can be entered directly via editor functions (offline) or via the `scan function (online):

- **“offline”**: The configuration can be customized by adding and positioning individual components. These can be selected from a directory and configured.
  - The procedure for the offline mode can be found under <http://infosys.beckhoff.com>:  
**TwinCAT 2** → TwinCAT System Manager → IO Configuration → Add an I/O device
- **“online”**: The existing hardware configuration is read
  - See also <http://infosys.beckhoff.com>:  
**Fieldbus components** → Fieldbus Cards and Switches → FC900x – PCI Cards for Ethernet → Installation → Searching for devices

The following relationship is envisaged between the user PC and individual control elements:

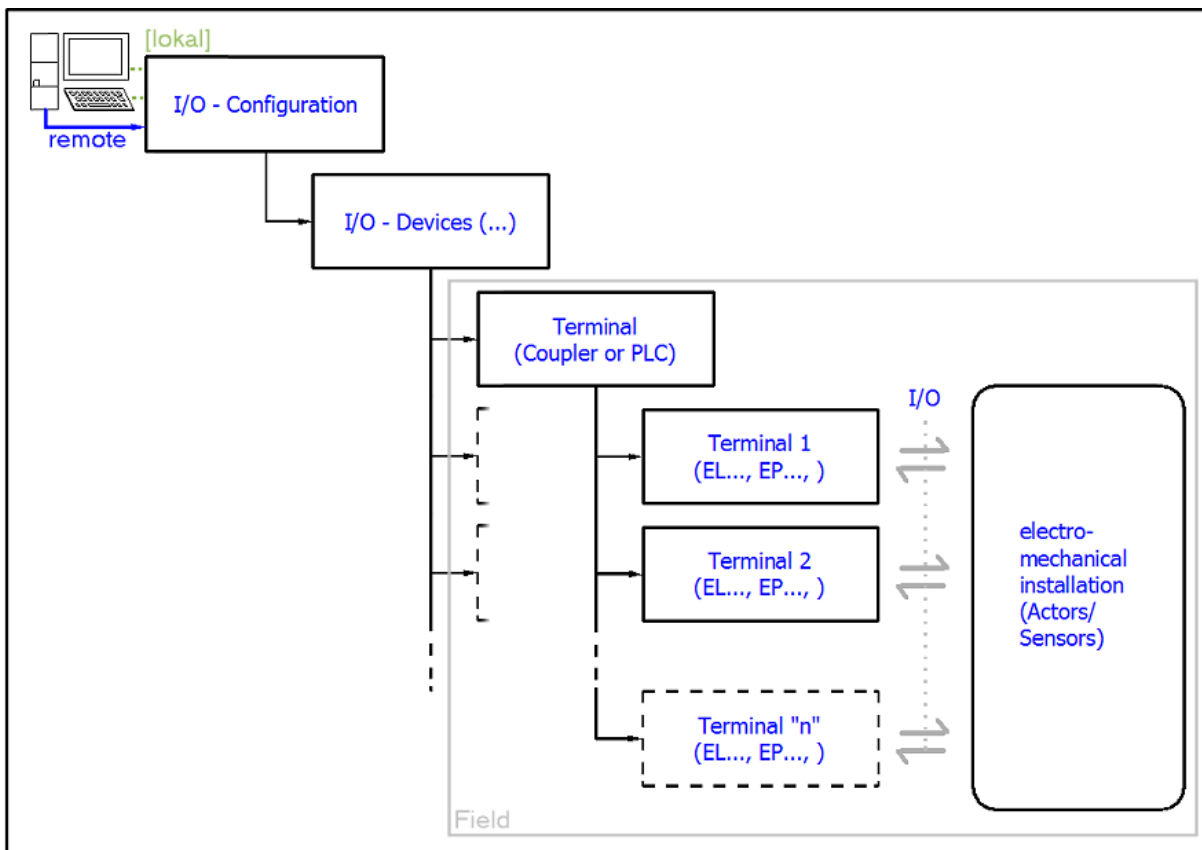

Fig. 41: Relationship between user side (commissioning) and installation

Insertion of certain components (I/O device, terminal, box...) by users functions the same way as in TwinCAT 2 and TwinCAT 3. The descriptions below relate solely to the online procedure.

### Example configuration (actual configuration)

Based on the following example configuration, the subsequent subsections describe the procedure for TwinCAT 2 and TwinCAT 3:

- **CX2040** control system (PLC) including **CX2100-0004** power supply unit
- Connected to CX2040 on the right (E-bus):  
**EL1004** (4-channel digital input terminal 24 V<sub>DC</sub>)
- Linked via the X001 port (RJ-45): **EK1100** EtherCAT Coupler
- Connected to the EK1100 EtherCAT Coupler on the right (E-bus):  
**EL2008** (8-channel digital output terminal 24 V<sub>DC</sub>; 0.5 A)
- (Optional via X000: a link to an external PC for the user interface)



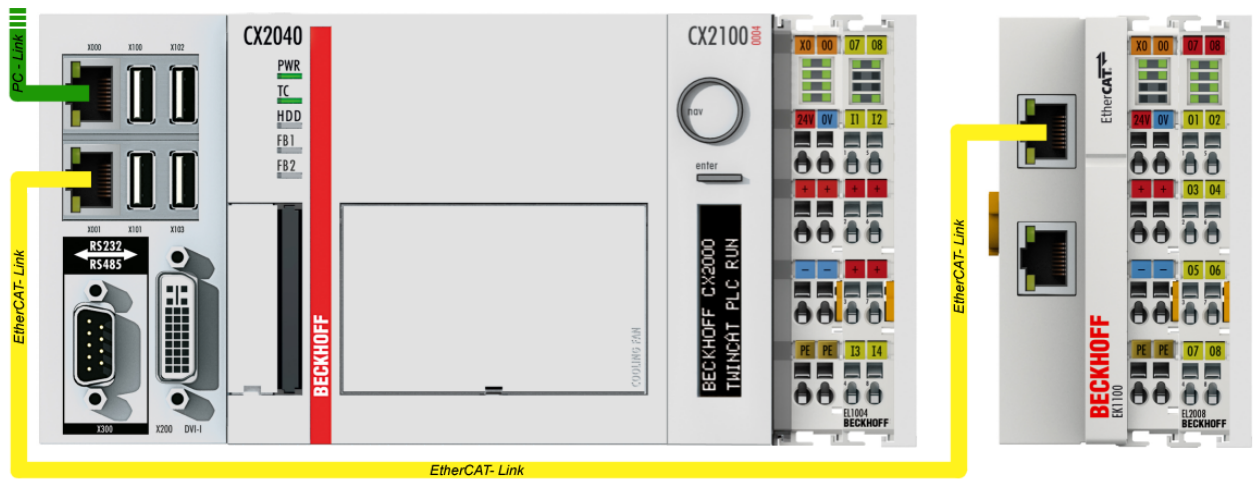

Fig. 42: Control configuration with Embedded PC, input (EL1004) and output (EL2008)

Note that all combinations of a configuration are possible; for example, the EL1004 terminal could also be connected after the coupler, or the EL2008 terminal could additionally be connected to the CX2040 on the right, in which case the EK1100 coupler wouldn't be necessary.

## 6.1.1 TwinCAT 2

### Startup

TwinCAT 2 basically uses two user interfaces: the TwinCAT System Manager for communication with the electromechanical components and TwinCAT PLC Control for the development and compilation of a controller. The starting point is the TwinCAT System Manager.

After successful installation of the TwinCAT system on the PC to be used for development, the TwinCAT 2 System Manager displays the following user interface after startup:

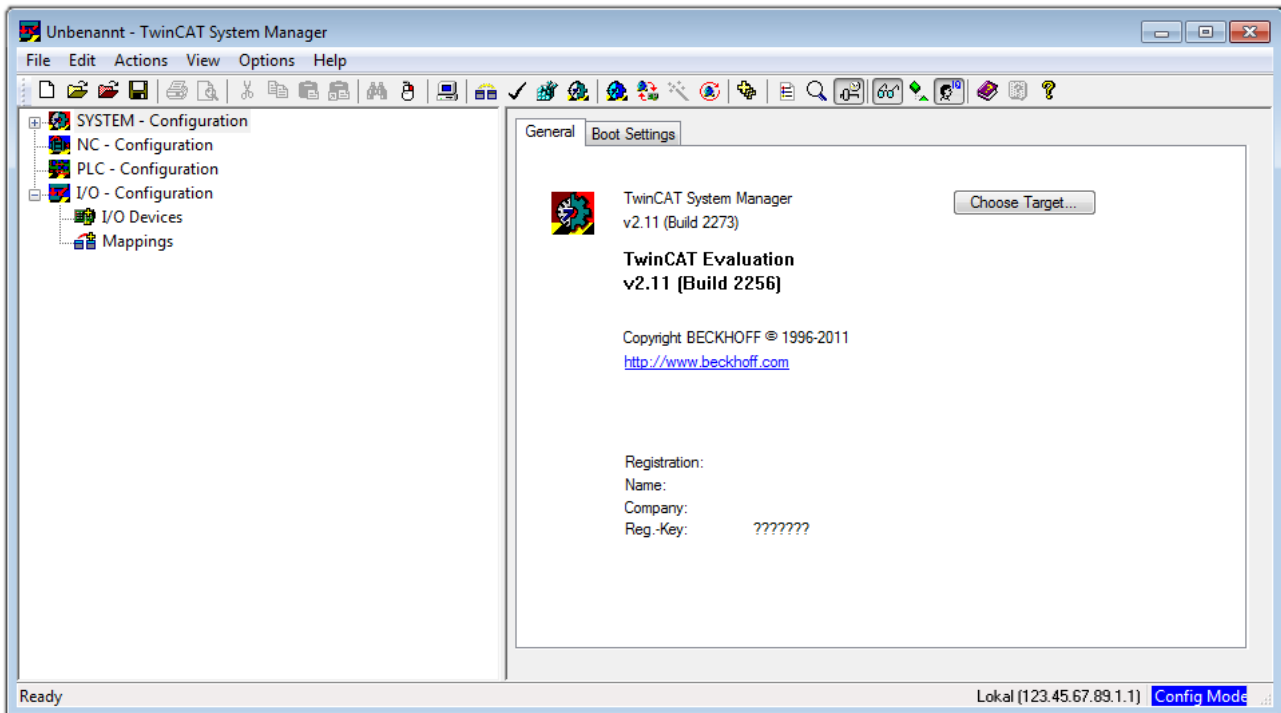



Fig. 43: Initial TwinCAT 2 user interface

Generally, TwinCAT can be used in local or remote mode. Once the TwinCAT system, including the user interface (standard) is installed on the respective PLC, TwinCAT can be used in local mode and thus the next step is “[Insert Device](#) [▶ 84]”.

If the intention is to address the TwinCAT runtime environment installed on a PLC remotely from another system used as a development environment, the target system must be made known first. In the menu under

“Actions” → “Choose Target System...”, the following window is opened for this via the symbol “” or the “F8” key:

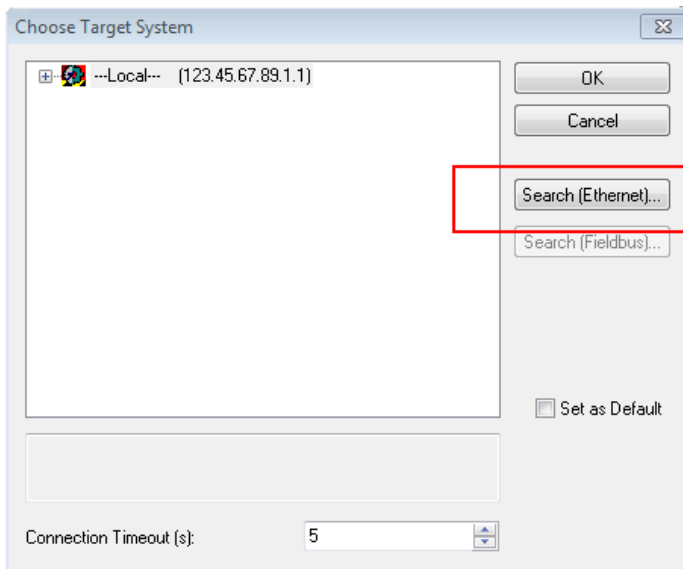

Fig. 44: Selection of the target system

Use “Search (Ethernet)...” to enter the target system. Thus another dialog opens to either:

- enter the known computer name after “Enter Host Name / IP:” (as shown in red)
- perform a “Broadcast Search” (if the exact computer name is not known)
- enter the known computer – IP or AmsNetID

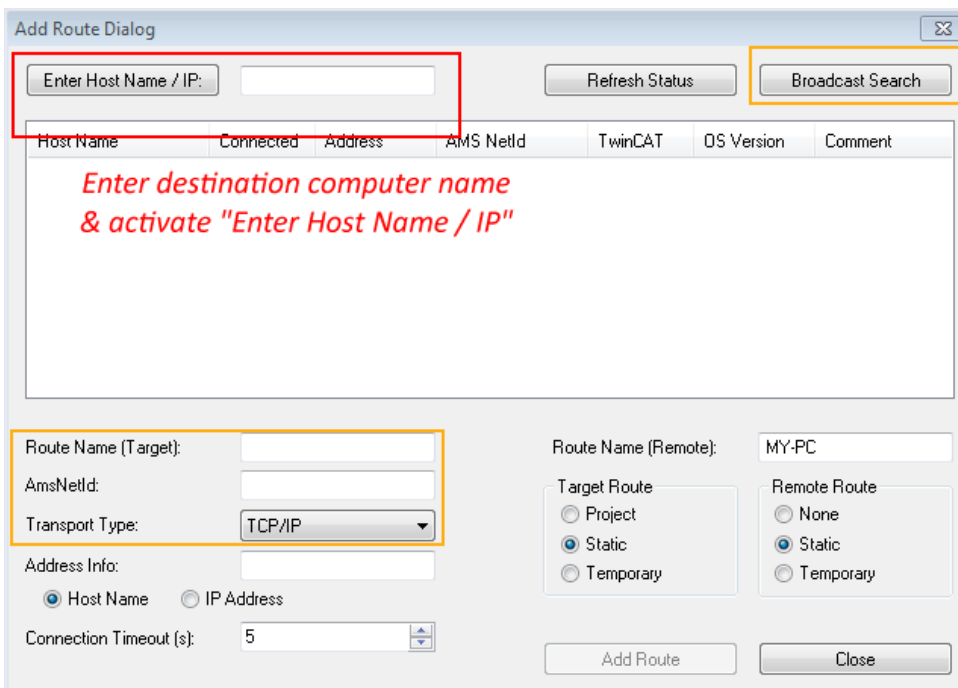
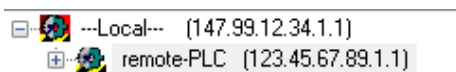

Fig. 45: specify the PLC for access by the TwinCAT System Manager: selection of the target system



Once the target system has been entered, it is available for selection as follows (a correct password may have to be entered before this):



After confirmation with “OK”, the target system can be accessed via the System Manager.

**Adding devices**

In the configuration tree of the TwinCAT 2 System Manager user interface on the left, select “I/O Devices” and then right-click to open a context menu and select “Scan Devices...”, or start the action in the menu bar

via . The TwinCAT System Manager may first have to be set to “Config Mode” via  or via the menu “Actions” → “Set/Reset TwinCAT to Config Mode...” (Shift + F4).

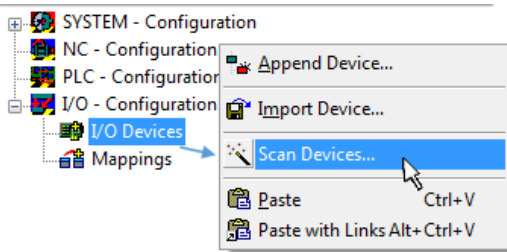

Fig. 46: Select “Scan Devices...”

Confirm the warning message, which follows, and select the “EtherCAT” devices in the dialog:

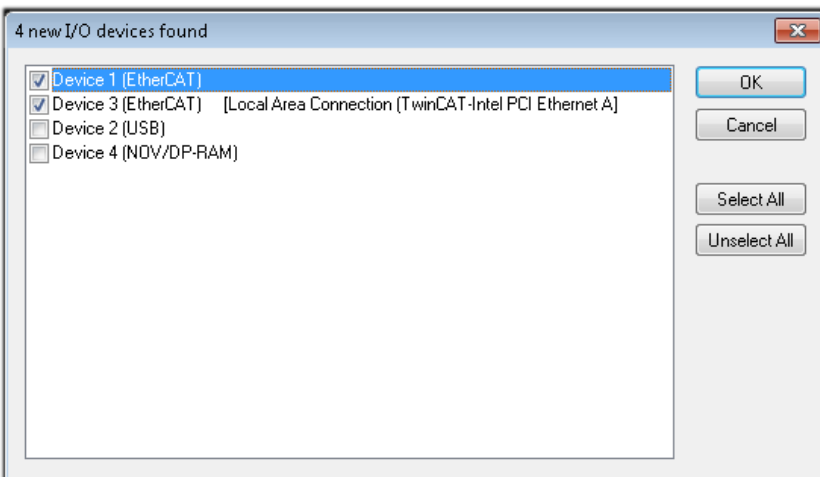

Fig. 47: Automatic detection of I/O devices: selection of the devices to be integrated

Confirm the message “Find new boxes”, in order to determine the terminals connected to the devices. “Free Run” enables manipulation of input and output values in “Config Mode” and should also be acknowledged.

Based on the [example configuration \[▶ 80\]](#) described at the beginning of this section, the result is as follows:

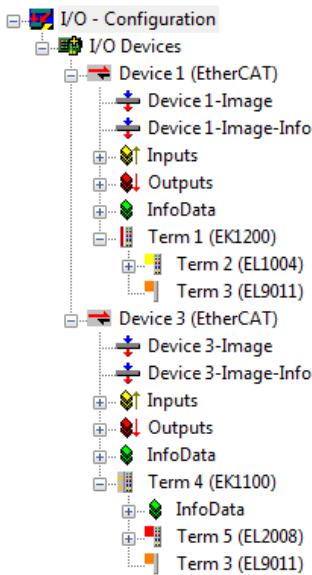

Fig. 48: Mapping of the configuration in the TwinCAT 2 System Manager

The whole process consists of two stages, which can also be performed separately (first determine the devices, then determine the connected elements such as boxes, terminals, etc.). A scan (search function) can also be initiated by selecting “Device ...” from the context menu, which then only reads the elements below which are present in the configuration:

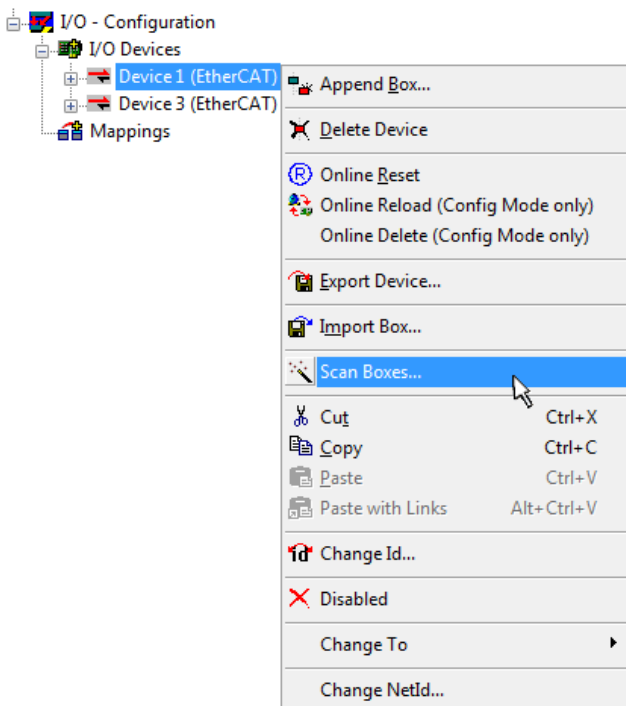

Fig. 49: Reading of individual terminals connected to a device

This functionality is useful if the actual configuration is modified at short notice.

**Programming and integrating the PLC**

TwinCAT PLC Control is the development environment for generating the controller in different program environments: TwinCAT PLC Control supports all languages described in IEC 61131-3. There are two text-based languages and three graphical languages.

- **Text-based languages**
  - Instruction List (IL)
  - Structured Text (ST)

- **Graphical languages**
  - Function Block Diagram (FBD)
  - Ladder Diagram (LD)
  - The Continuous Function Chart Editor (CFC)
  - Sequential Function Chart (SFC)

The following section refers solely to Structured Text (ST).

After starting TwinCAT PLC Control, the following user interface is shown for an initial project:

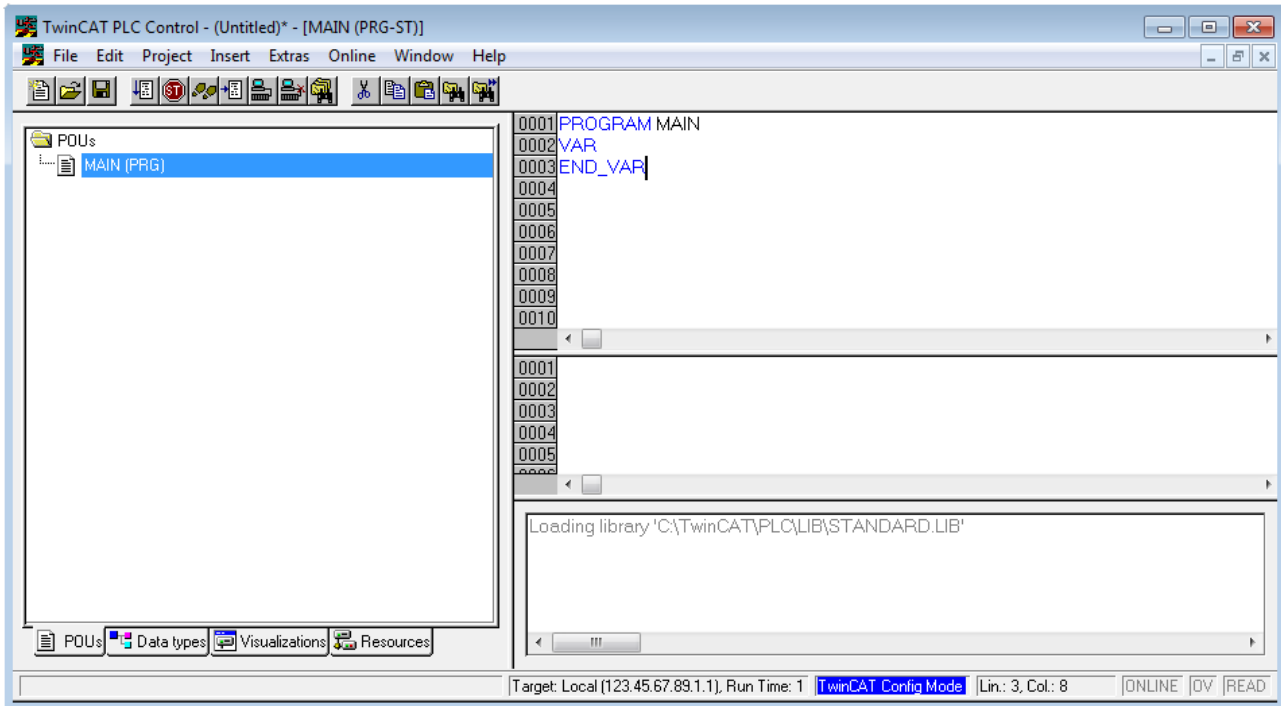

Fig. 50: TwinCAT PLC Control after startup

Example variables and an example program have been created and stored under the name "PLC\_example.pro":

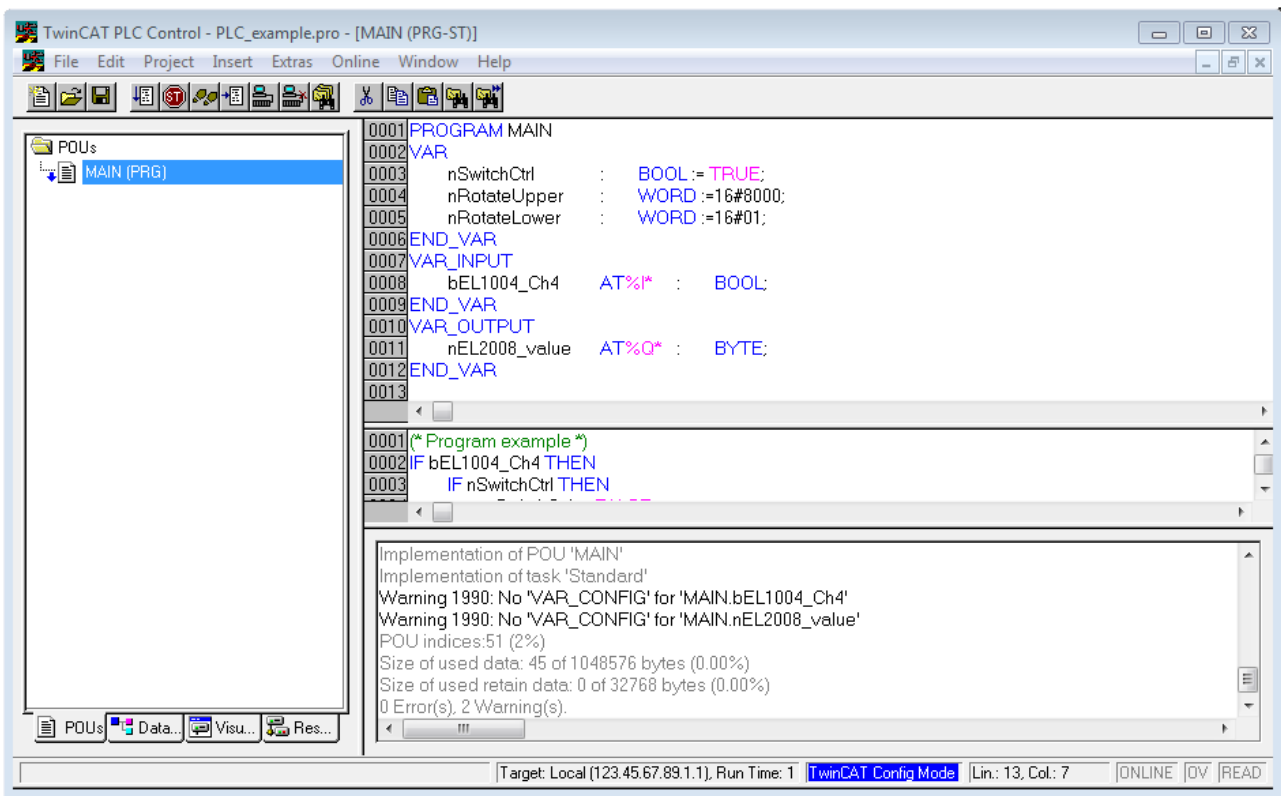

Fig. 51: Example program with variables after a compile process (without variable integration)

Warning 1990 (missing “VAR\_CONFIG”) after a compile process indicates that the variables defined as external (with the ID “AT%I\*” or “AT%Q\*”) have not been assigned. After successful compilation, TwinCAT PLC Control creates a “\*.tpy” file in the directory in which the project was stored. This file (“\*.tpy”) contains variable assignments and is not known to the System Manager, hence the warning. Once the System Manager has been notified, the warning no longer appears.

First, integrate the TwinCAT PLC Control project in the **System Manager**. This is performed via the context menu of the PLC configuration (right-click) and selecting “Append PLC Project...”:

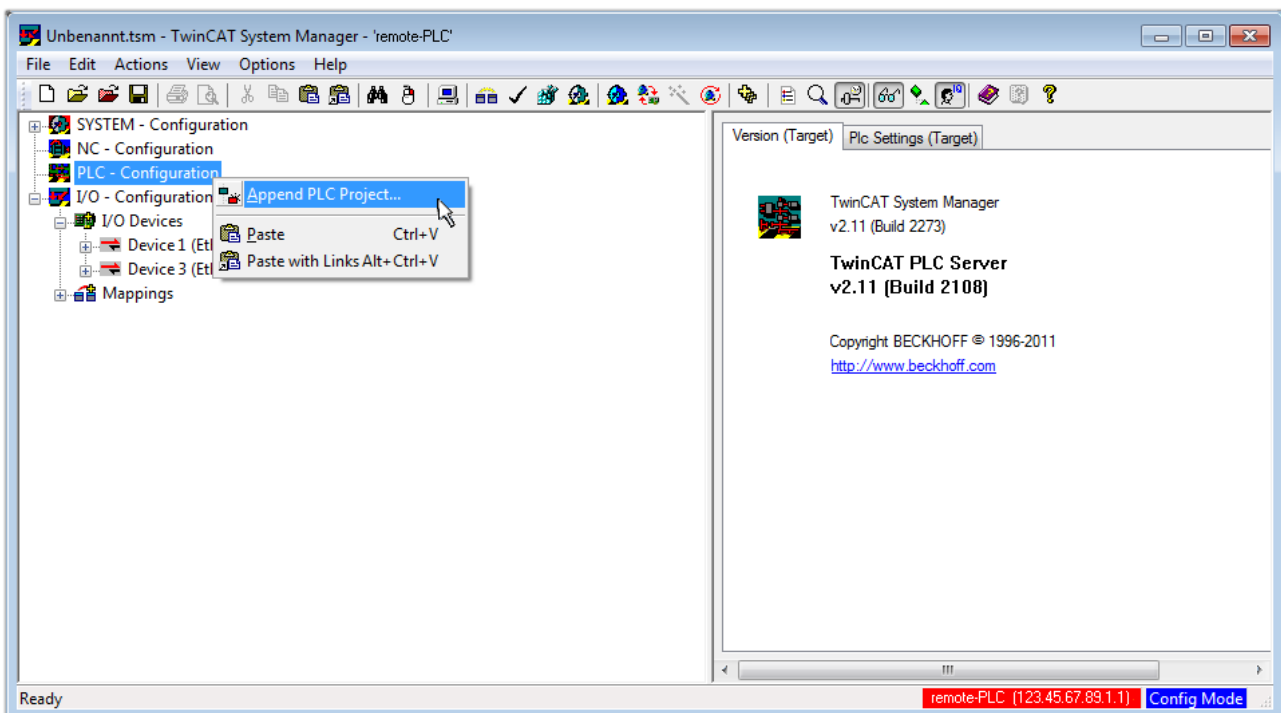

Fig. 52: Appending the TwinCAT PLC Control project

Select the PLC configuration “PLC\_example.tpy” in the browser window that opens. The project including the two variables identified with “AT” are then integrated in the configuration tree of the System Manager:

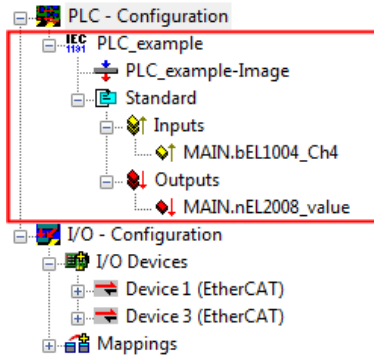

Fig. 53: PLC project integrated in the PLC configuration of the System Manager

The two variables “bEL1004\_Ch4” and “nEL2008\_value” can now be assigned to certain process objects of the I/O configuration.

**Assigning variables**

Open a window for selecting a suitable process object (PDO) via the context menu of a variable of the integrated project “PLC\_example” and via “Modify Link...” “Standard”:

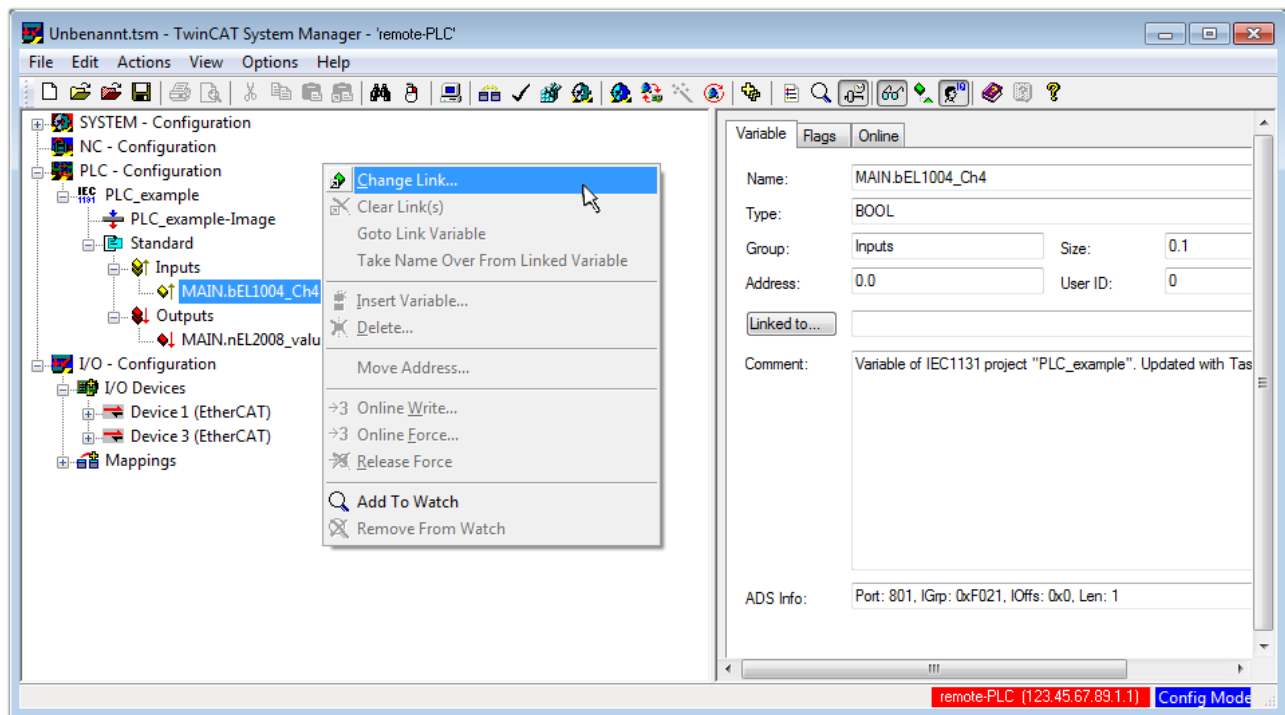

Fig. 54: Creating the links between PLC variables and process objects

In the window that opens, the process object for the “bEL1004\_Ch4” BOOL-type variable can be selected from the PLC configuration tree:



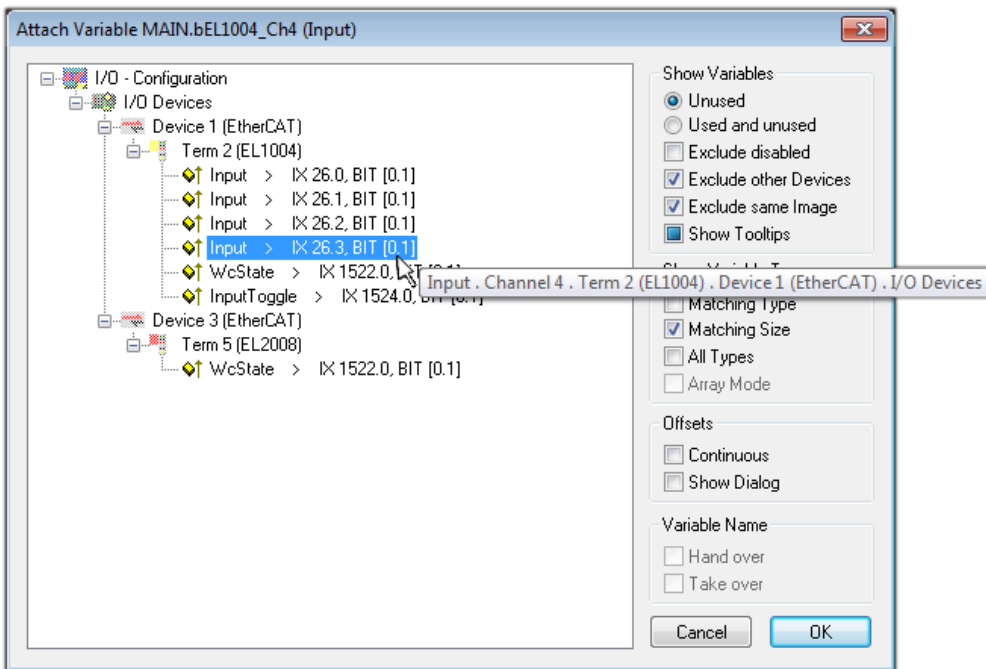

Fig. 55: Selecting BOOL-type PDO

According to the default setting, only certain PDO objects are now available for selection. In this example, the input of channel 4 of the EL1004 terminal is selected for linking. In contrast, the checkbox “All types” must be ticked to create the link for the output variables, in order to allocate a set of eight separate output bits to a byte variable in this case. The following diagram shows the whole process:

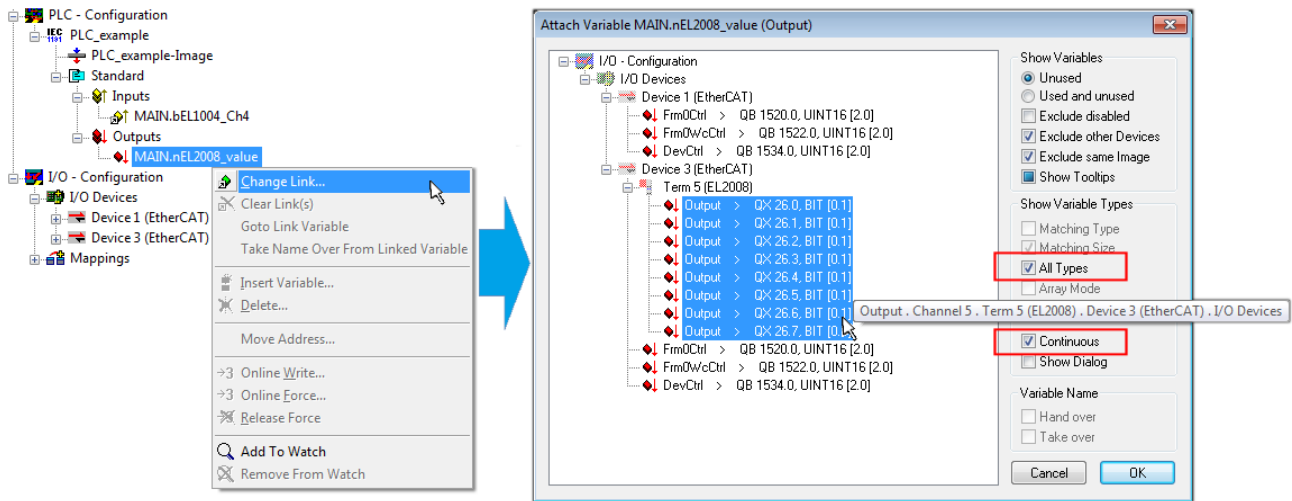



Fig. 56: Selecting several PDOs simultaneously: activate “Continuous” and “All types”

Note that the “Continuous” checkbox was also activated. This is designed to allocate the bits contained in the byte of the “nEL2008\_value” variable sequentially to all eight selected output bits of the EL2008 Terminal. It is thus possible to subsequently address all eight outputs of the terminal in the program with a byte corresponding to bit 0 for channel 1 to bit 7 for channel 8 of the PLC. A special symbol (  ) on the yellow or red object of the variable indicates that a link exists. The links can also be checked by selecting “Goto Link Variable” from the context menu of a variable. The opposite linked object, in this case the PDO, is automatically selected:

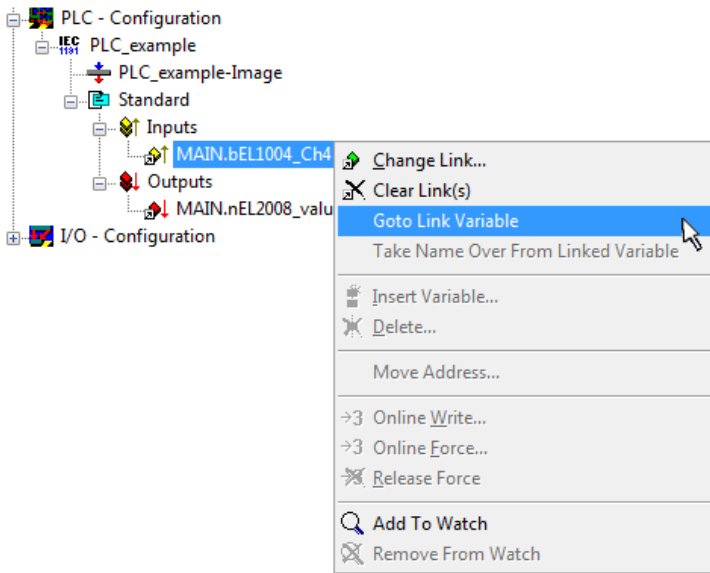

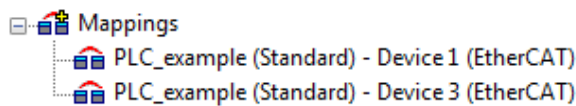

Fig. 57: Application of a “Goto Link Variable”, using “MAIN.bEL1004\_Ch4” as an example

The process of assigning variables to the PDO is completed via the menu option “Actions” → “Create assignment”, or via .

This can be visualized in the configuration:



The process of creating links can also be performed in the opposite direction, i.e. starting with individual PDOs to a variable. However, in this example, it would not be possible to select all output bits for the EL2008, since the terminal only makes individual digital outputs available. If a terminal has a byte, word, integer or similar PDO, it is also possible to allocate this to a set of bit-standardized variables. Here, too, a “Goto Link Variable” can be executed in the other direction, so that the respective PLC instance can then be selected.

**Activation of the configuration**

The allocation of PDO to PLC variables has now established the connection from the controller to the inputs and outputs of the terminals. The configuration can now be activated. First, the configuration can be verified

via  (or via “Actions” → “Check Configuration”). If no error is present, the configuration can be

activated via  (or via “Actions” → “Activate Configuration...”) to transfer the System Manager settings to the runtime system. Confirm the messages “Old configurations will be overwritten!” and “Restart TwinCAT system in Run mode” with “OK”.

A few seconds later, the real-time status **RTime 0%** is displayed at the bottom right in the System Manager. The PLC system can then be started as described below.

**Starting the controller**

Starting from a remote system, the PLC control has to be linked with the embedded PC over the Ethernet via “Online” → “Choose Runtime System...”:

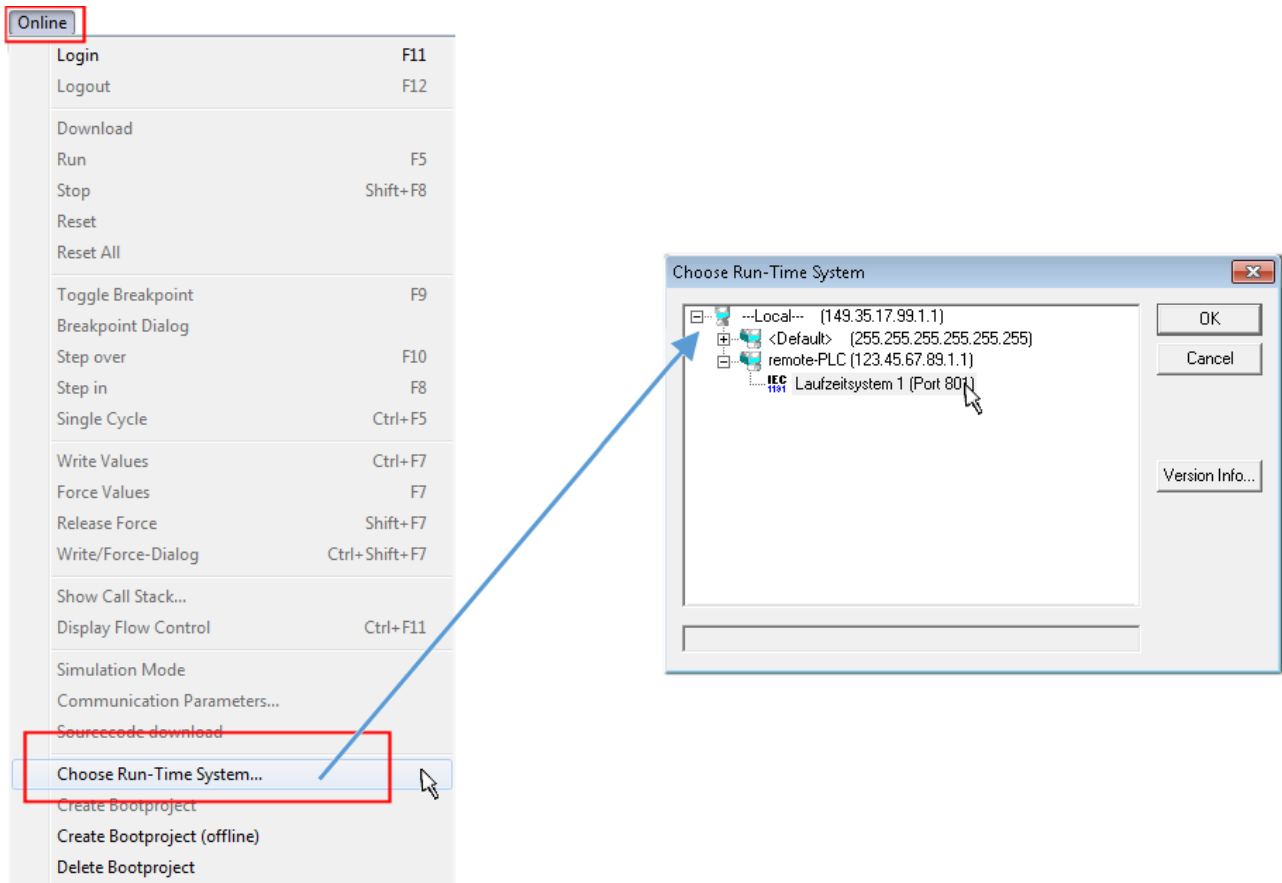

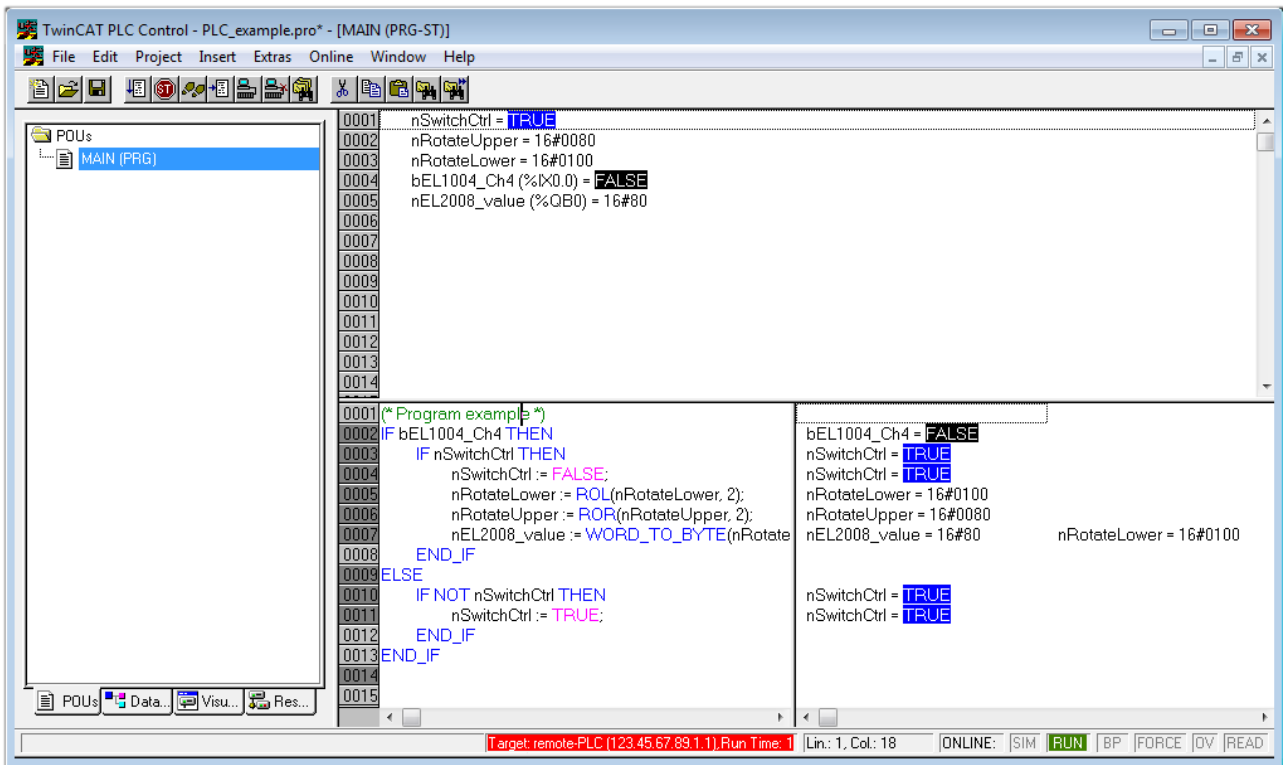

Fig. 58: Choose target system (remote)

In this example, "Runtime system 1 (port 801)" is selected and confirmed. Link the PLC with the real-time

system via the menu option "Online" → "Login", the F11 key or by clicking on the symbol . The control program can then be loaded for execution. This results in the message "No program on the controller! Should the new program be loaded?", which should be confirmed with "Yes". The runtime environment is ready for the program start:



The PLC can now be started via “Online” → “Run”, F5 key or .

## 6.1.2 TwinCAT 3

### Startup

TwinCAT 3 makes the development environment areas available all together, with Microsoft Visual Studio: after startup, the project folder explorer appears on the left in the general window area (see “TwinCAT System Manager” of TwinCAT 2) for communication with the electromechanical components.

After successful installation of the TwinCAT system on the PC to be used for development, TwinCAT 3 (shell) displays the following user interface after startup:



Fig. 60: Initial TwinCAT 3 user interface

First create a new project via  **New TwinCAT Project...** (or under “File”→“New”→“Project...”). In the following dialog, make the corresponding entries as required (as shown in the diagram):

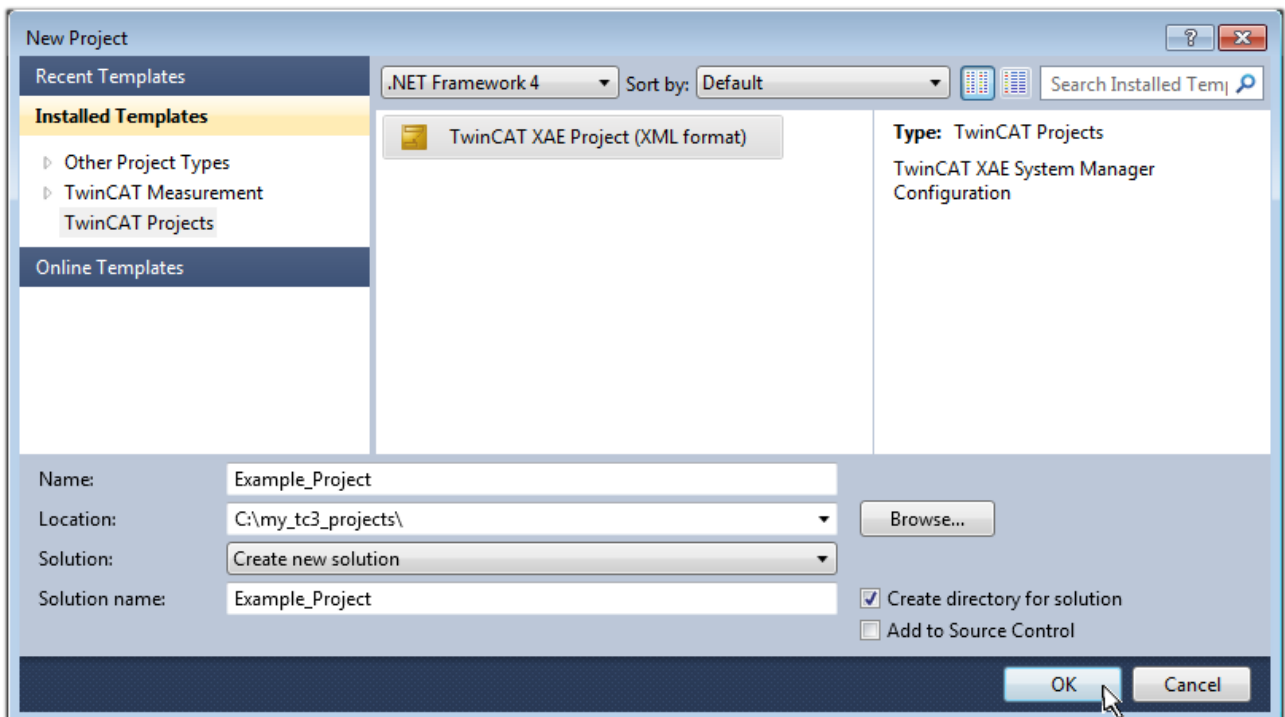

Fig. 61: Create new TwinCAT 3 project

The new project is then available in the project folder explorer:

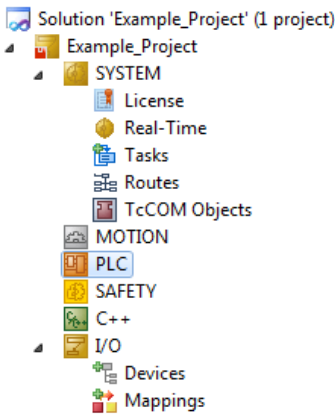
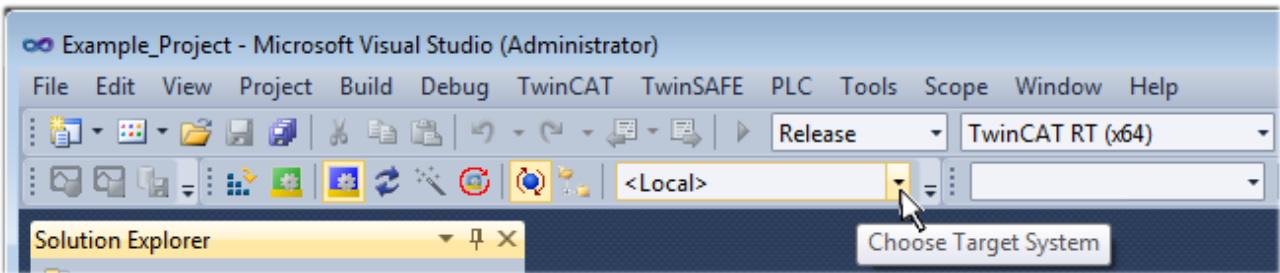

Fig. 62: New TwinCAT 3 project in the project folder explorer

Generally, TwinCAT can be used in local or remote mode. Once the TwinCAT system including the user interface (standard) is installed on the respective PLC (locally), TwinCAT can be used in local mode and the process can be continued with the next step, "Insert Device [► 95]".

If the intention is to address the TwinCAT runtime environment installed on a PLC remotely from another system used as a development environment, the target system must be made known first. Via the symbol in the menu bar:



expand the pull-down menu:

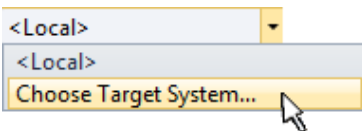

and open the following window:

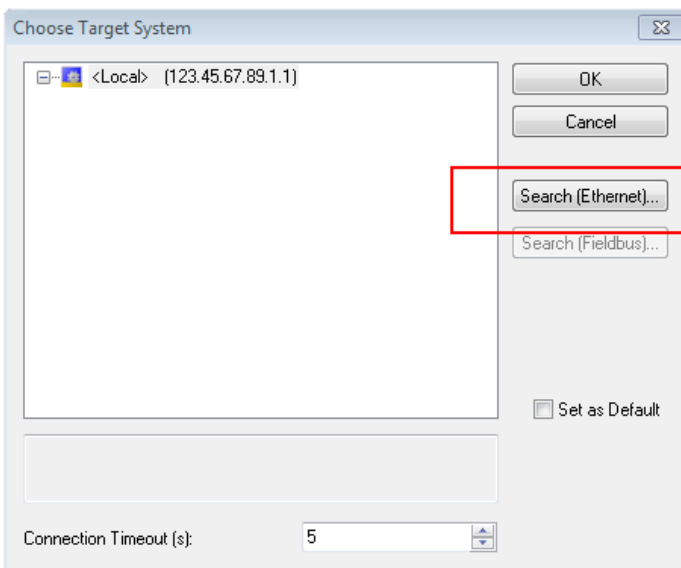

Fig. 63: Selection dialog: Choose the target system

Use “Search (Ethernet)...” to enter the target system. Thus another dialog opens to either:

- enter the known computer name after “Enter Host Name / IP:” (as shown in red)
- perform a “Broadcast Search” (if the exact computer name is not known)
- enter the known computer – IP or AmsNetID

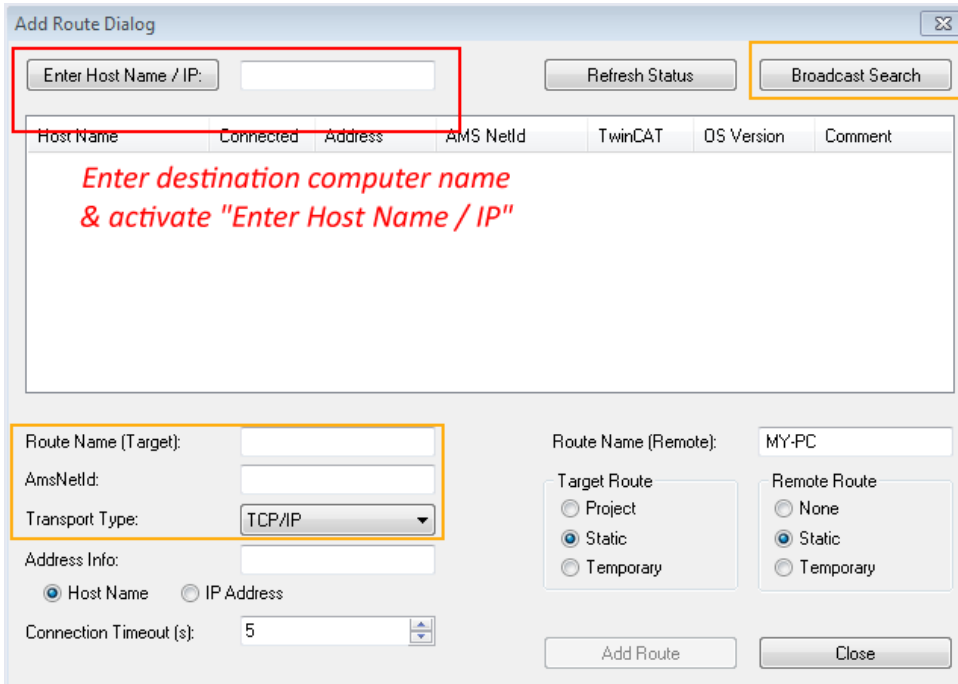
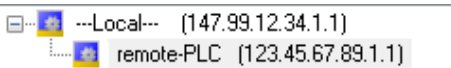

Fig. 64: specify the PLC for access by the TwinCAT System Manager: selection of the target system

Once the target system has been entered, it is available for selection as follows (the correct password may have to be entered beforehand):



After confirmation with “OK” the target system can be accessed via the Visual Studio shell.

**Adding devices**

In the project folder explorer on the left of the Visual Studio shell user interface, select “Devices” within the

element “I/O”, then right-click to open a context menu and select “Scan” or start the action via  in the

menu bar. The TwinCAT System Manager may first have to be set to “Config mode” via  or via the menu “TwinCAT” → “Restart TwinCAT (Config Mode)”.

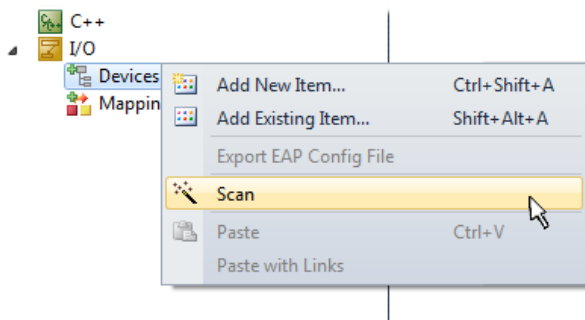

Fig. 65: Select “Scan”

Confirm the warning message, which follows, and select the “EtherCAT” devices in the dialog:

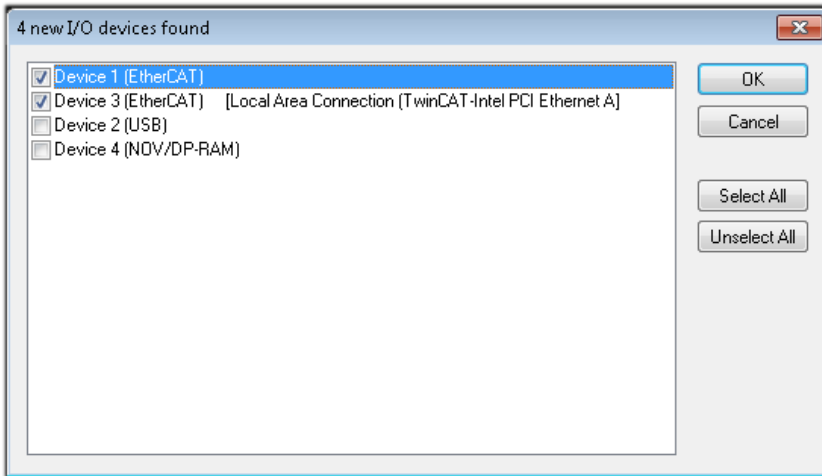

Fig. 66: Automatic detection of I/O devices: selection of the devices to be integrated

Confirm the message “Find new boxes”, in order to determine the terminals connected to the devices. “Free Run” enables manipulation of input and output values in “Config Mode” and should also be acknowledged.

Based on the [example configuration \[▶ 80\]](#) described at the beginning of this section, the result is as follows:

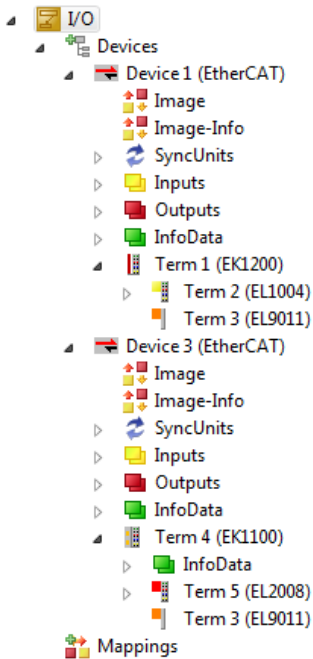

Fig. 67: Mapping of the configuration in VS shell of the TwinCAT 3 environment

The whole process consists of two stages, which can also be performed separately (first determine the devices, then determine the connected elements such as boxes, terminals, etc.). A scan (search function) can also be initiated by selecting “Device ...” from the context menu, which then only reads the elements below which are present in the configuration:



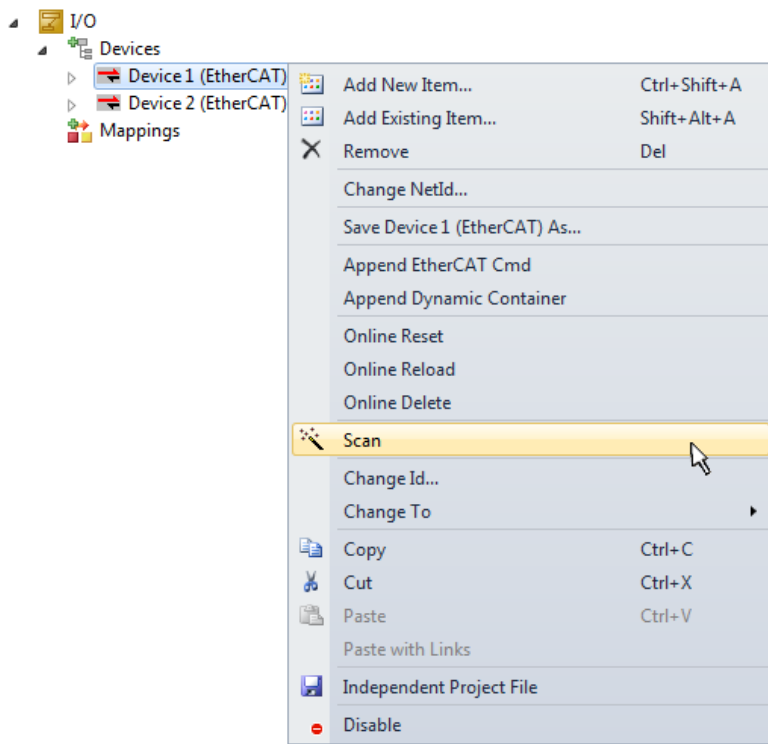

Fig. 68: Reading of individual terminals connected to a device

This functionality is useful if the actual configuration is modified at short notice.

### Programming the PLC

TwinCAT PLC Control is the development environment for generating the controller in different program environments: TwinCAT PLC Control supports all languages described in IEC 61131-3. There are two text-based languages and three graphical languages.

- **Text-based languages**
  - Instruction List (IL)
  - Structured Text (ST)
- **Graphical languages**
  - Function Block Diagram (FBD)
  - Ladder Diagram (LD)
  - The Continuous Function Chart Editor (CFC)
  - Sequential Function Chart (SFC)

The following section refers solely to Structured Text (ST).

In order to create a programming environment, a PLC subproject is added to the example project via the context menu of the "PLC" in the project folder explorer by selecting "Add New Item....":

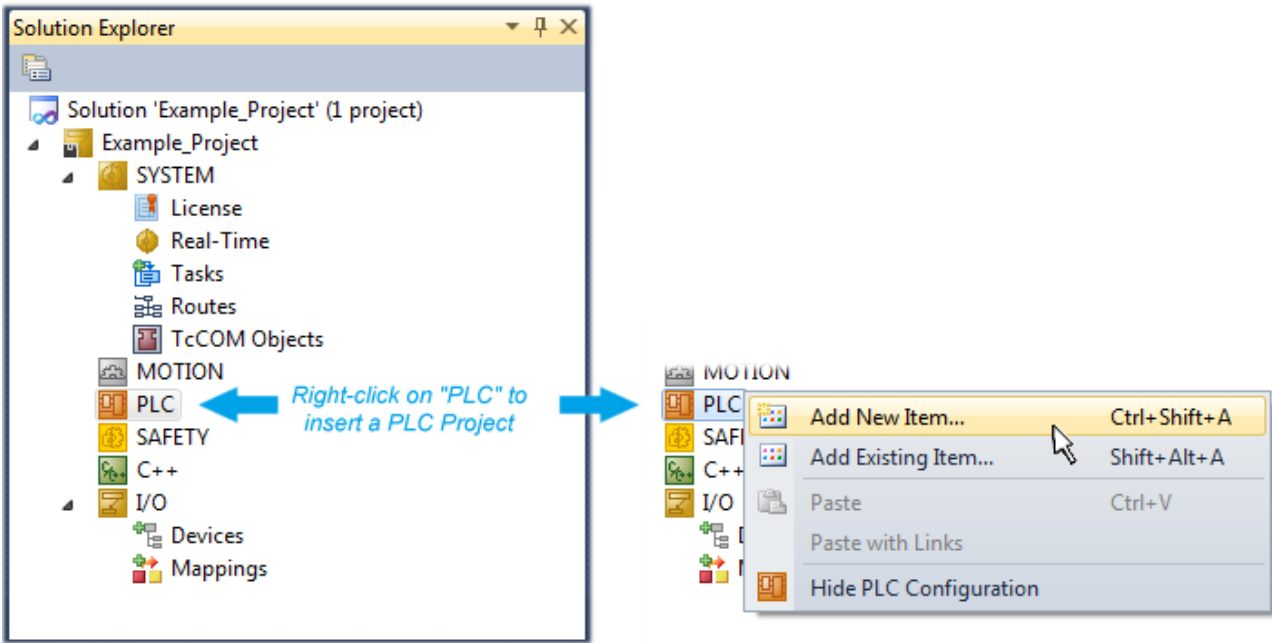

Fig. 69: Adding the programming environment in “PLC”

In the dialog that opens, select “Standard PLC project” and enter “PLC\_example” as project name, for example, and select a corresponding directory:

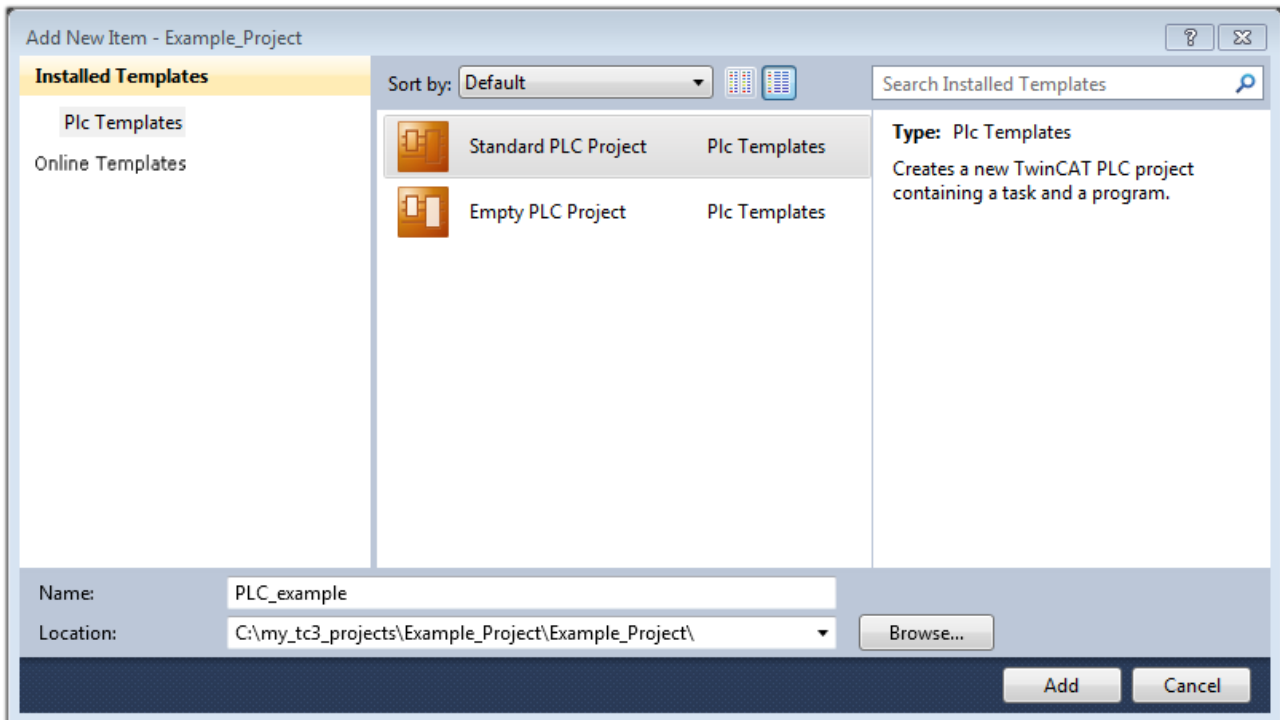

Fig. 70: Specifying the name and directory for the PLC programming environment

The “Main” program, which already exists due to selecting “Standard PLC project”, can be opened by double-clicking on “PLC\_example\_project” in “POUs”. The following user interface is shown for an initial project:

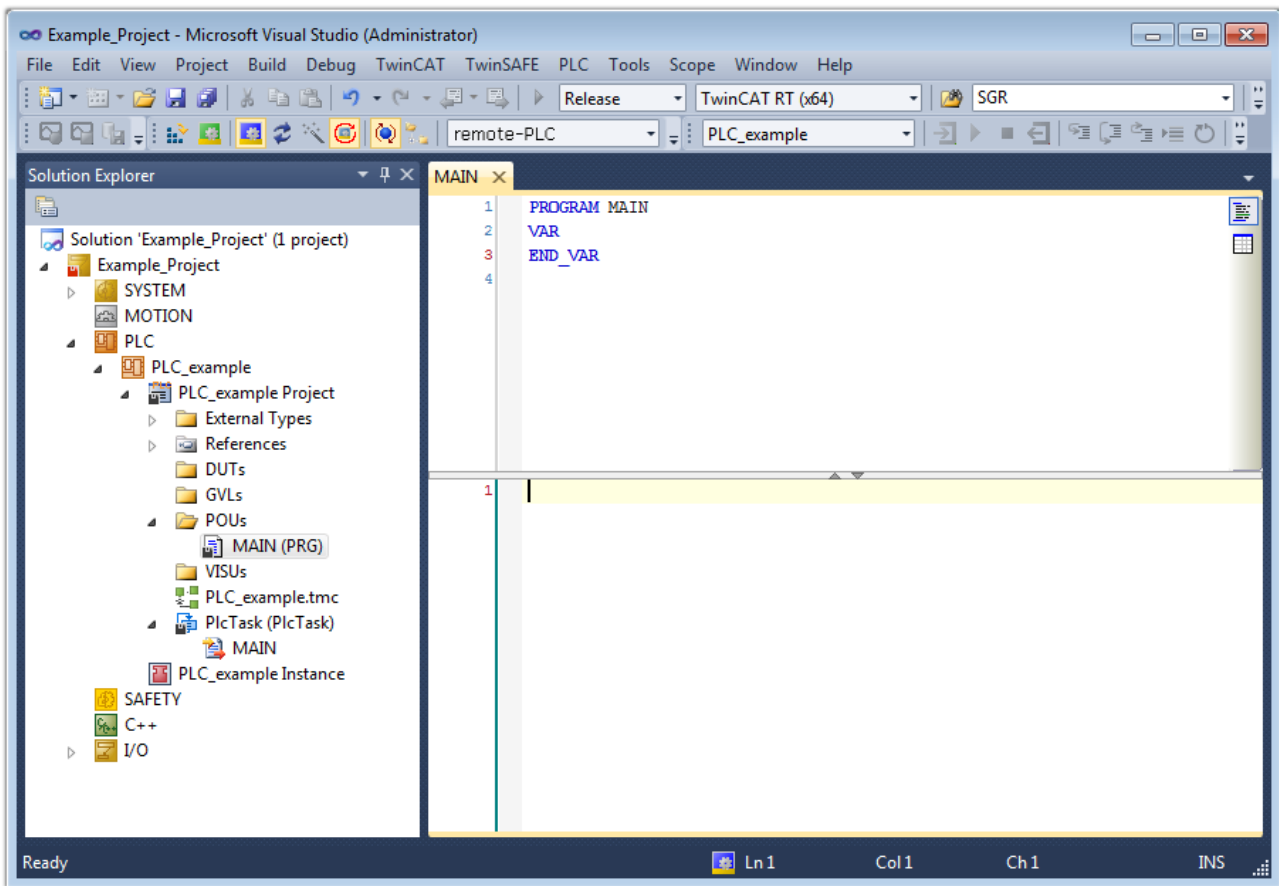

Fig. 71: Initial “Main” program for the standard PLC project

Now example variables and an example program have been created for the next stage of the process:

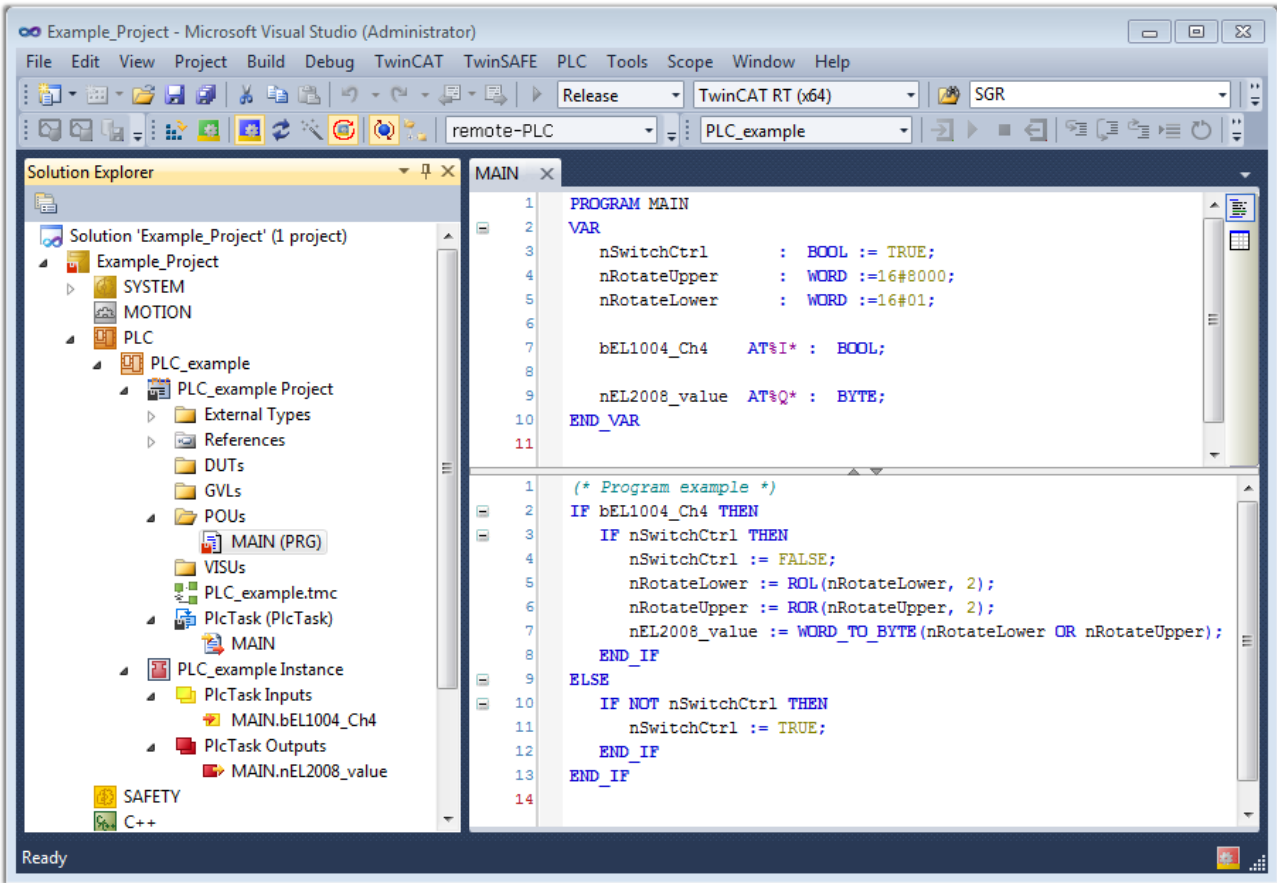

Fig. 72: Example program with variables after a compile process (without variable integration)

The control program is now created as a project folder, followed by the compile process:

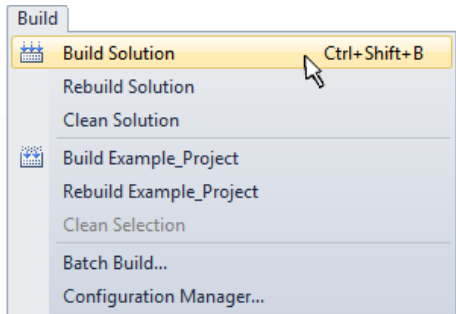
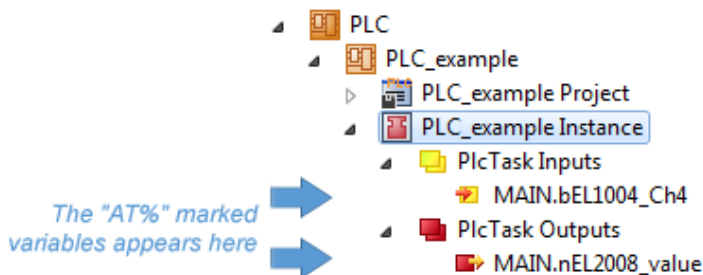

Fig. 73: Start program compilation

The following variables, identified in the ST/PLC program with “AT%”, are then available under “Assignments” in the project folder explorer:



**Assigning variables**

Via the menu of an instance – variables in the “PLC” context, use the “Modify Link...” option to open a window to select a suitable process object (PDO) for linking:

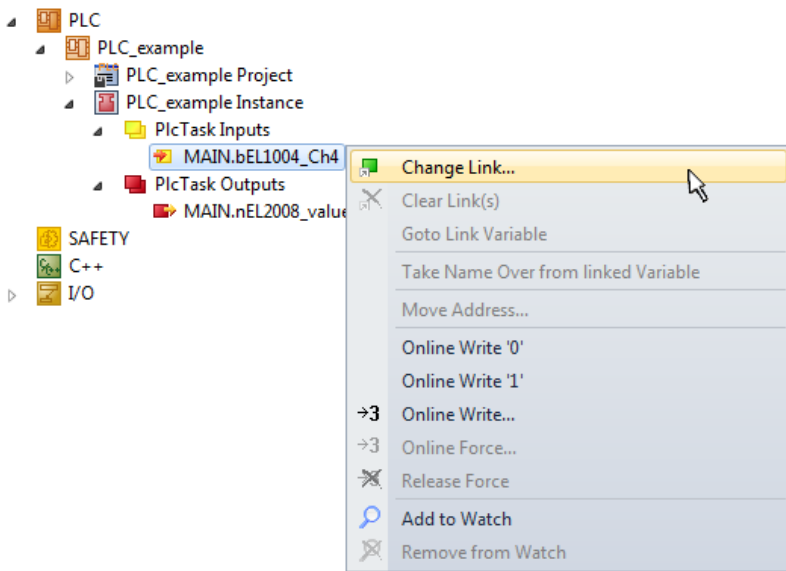

Fig. 74: Creating the links between PLC variables and process objects

In the window that opens, the process object for the “bEL1004\_Ch4” BOOL-type variable can be selected from the PLC configuration tree:

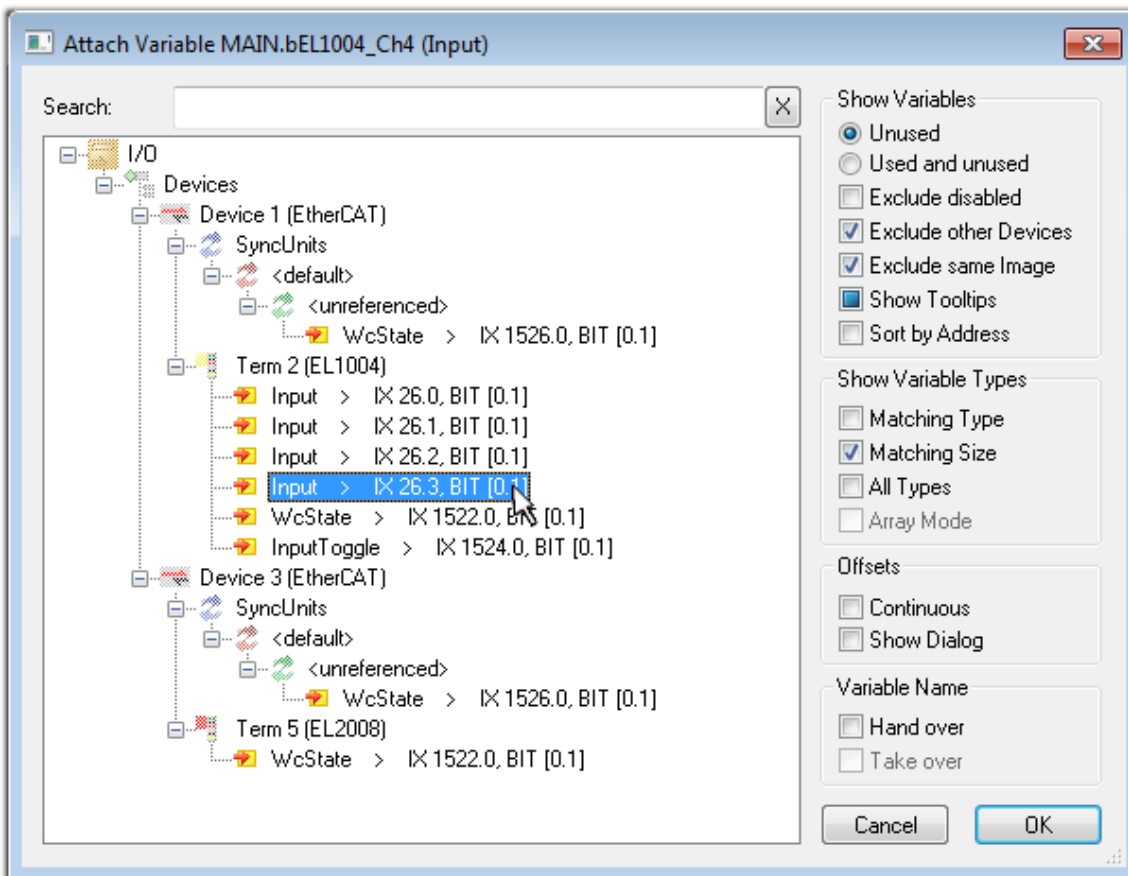

Fig. 75: Selecting BOOL-type PDO

According to the default setting, only certain PDO objects are now available for selection. In this example, the input of channel 4 of the EL1004 terminal is selected for linking. In contrast, the checkbox “All types” must be ticked to create the link for the output variables, in order to allocate a set of eight separate output bits to a byte variable in this case. The following diagram shows the whole process:

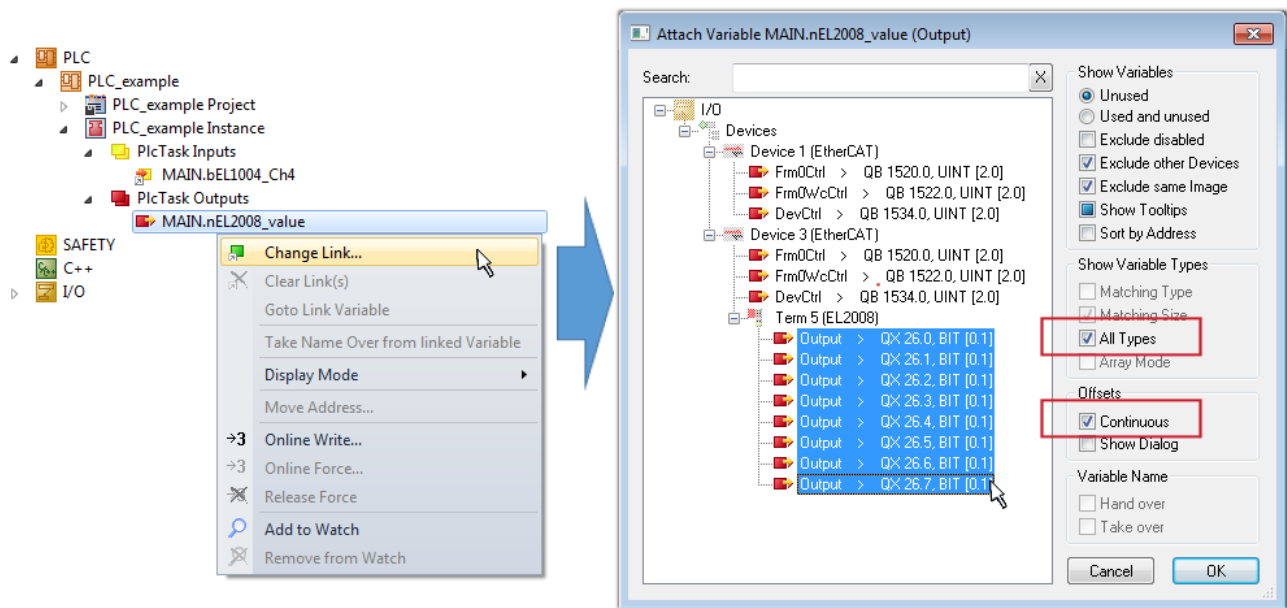



Fig. 76: Selecting several PDOs simultaneously: activate “Continuous” and “All types”

Note that the “Continuous” checkbox was also activated. This is designed to allocate the bits contained in the byte of the “nEL2008\_value” variable sequentially to all eight selected output bits of the EL2008 Terminal. It is thus possible to subsequently address all eight outputs of the terminal in the program with a byte corresponding to bit 0 for channel 1 to bit 7 for channel 8 of the PLC. A special symbol (  ) on the yellow or red object of the variable indicates that a link exists. The links can also be checked by selecting “Goto Link Variable” from the context menu of a variable. The opposite linked object, in this case the PDO, is automatically selected:

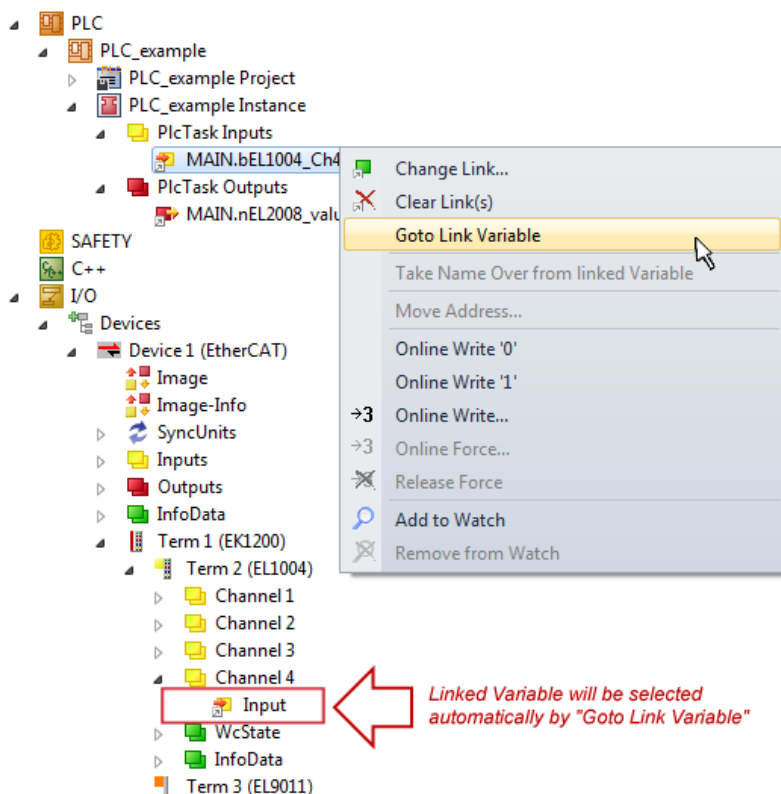

Fig. 77: Application of a “Goto Link Variable”, using “MAIN.bEL1004\_Ch4” as an example

The process of creating links can also be performed in the opposite direction, i.e. starting with individual PDOs to a variable. However, in this example, it would not be possible to select all output bits for the EL2008, since the terminal only makes individual digital outputs available. If a terminal has a byte, word,

integer or similar PDO, it is also possible to allocate this to a set of bit-standardized variables. Here, too, a “Goto Link Variable” can be executed in the other direction, so that the respective PLC instance can then be selected.

**Note on type of variable assignment**

**i** The following type of variable assignment can only be used from TwinCAT version V3.1.4024.4 onwards and is only available for terminals with a microcontroller.

In TwinCAT, a structure can be created from the mapped process data of a terminal. An instance of this structure can then be created in the PLC, so it is possible to access the process data directly from the PLC without having to declare own variables.

The procedure for the EL3001 1-channel analog input terminal -10...+10 V is shown as an example.

1. First, the required process data must be selected in the “Process data” tab in TwinCAT.
2. After that, the PLC data type must be generated in the “PLC” tab via the check box.
3. The data type in the “Data Type” field can then be copied using the “Copy” button.

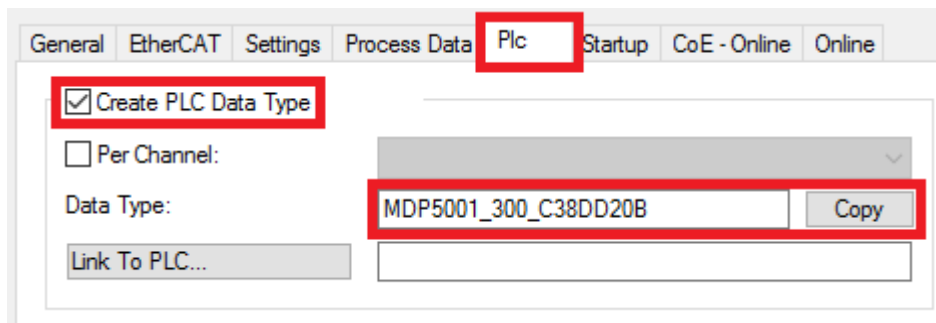

Fig. 78: Creating a PLC data type

4. An instance of the data structure of the copied data type must then be created in the PLC.

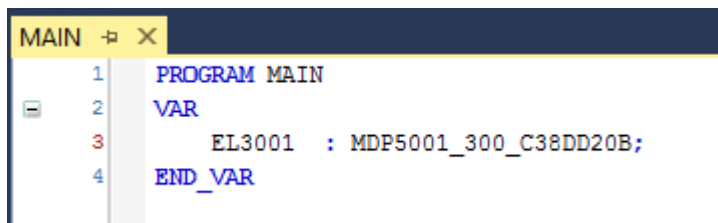

Fig. 79: Instance\_of\_struct

5. Then the project folder must be created. This can be done either via the key combination “CTRL + Shift + B” or via the “Build” tab in TwinCAT.
6. The structure in the “PLC” tab of the terminal must then be linked to the created instance.

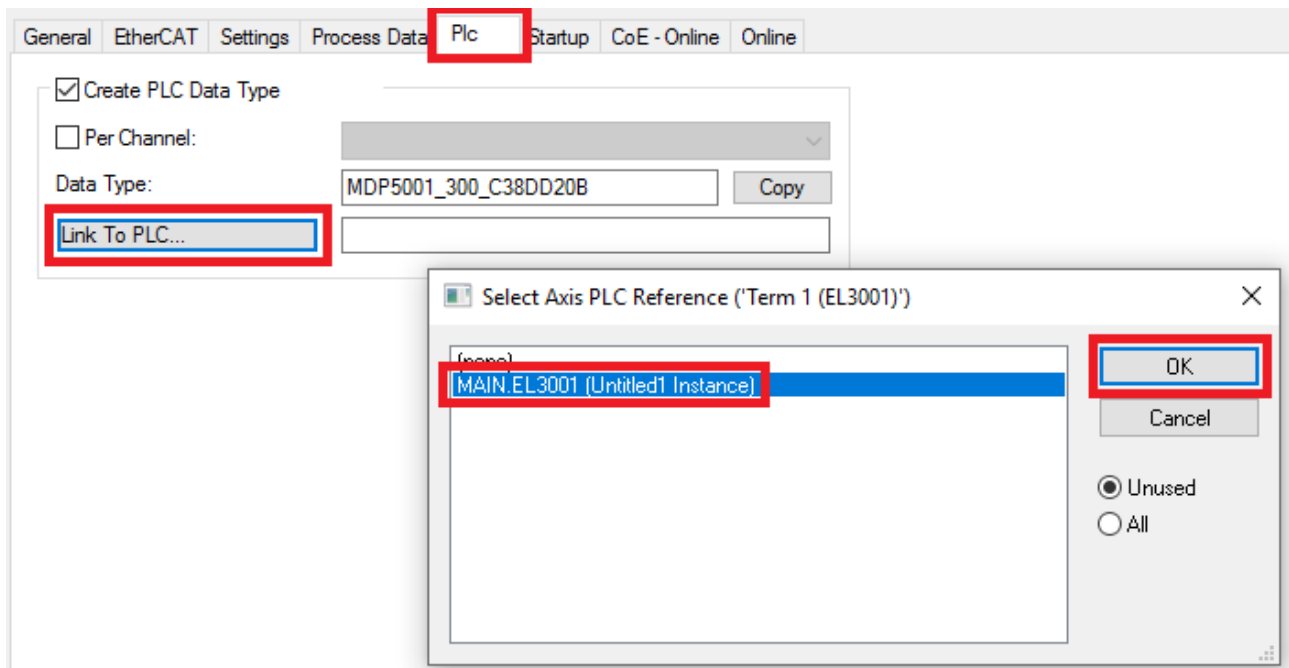

Fig. 80: Linking the structure

7. In the PLC, the process data can then be read or written via the structure in the program code.

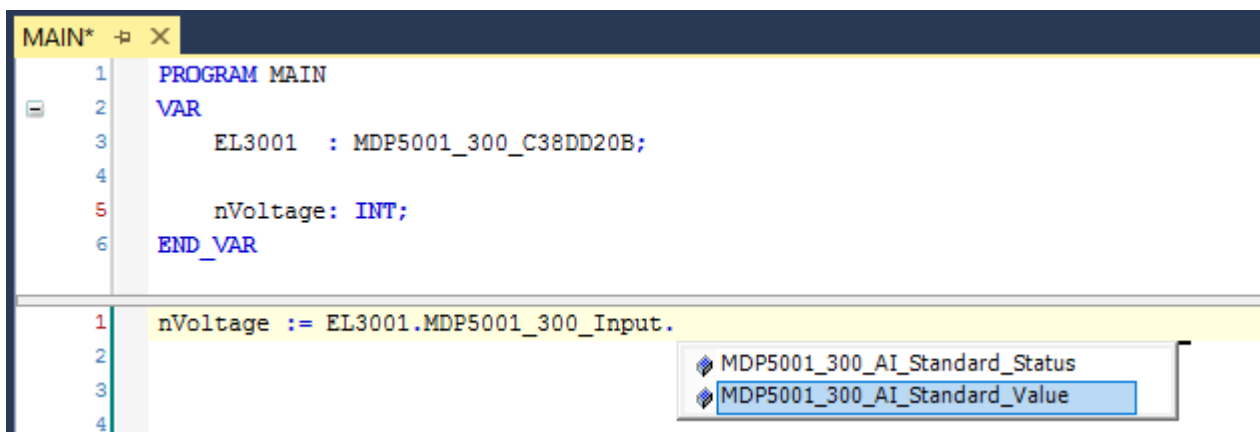

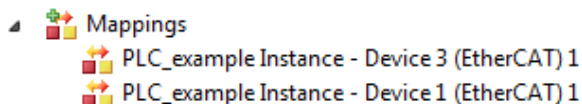

Fig. 81: Reading a variable from the structure of the process data

**Activation of the configuration**

The allocation of PDO to PLC variables has now established the connection from the controller to the inputs

and outputs of the terminals. The configuration can now be activated with  or via the menu under “TwinCAT” in order to transfer the settings of the development environment to the runtime system. Confirm the messages “Old configurations will be overwritten!” and “Restart TwinCAT system in Run mode” with “OK”. The corresponding assignments can be seen in the project folder explorer:





A few seconds later, the corresponding status of the Run mode is displayed in the form of a rotating symbol

 at the bottom right of the VS shell development environment. The PLC system can then be started as described below.



### Starting the controller

Select the menu option “PLC” → “Login” or click on  to link the PLC with the real-time system and load the control program for execution. This results in the message “No program on the controller! Should the new program be loaded?”, which should be acknowledged with “Yes”. The runtime environment is ready for

the program to be started by clicking on symbol , the “F5” key or via “PLC” in the menu, by selecting “Start”. The started programming environment shows the runtime values of individual variables:

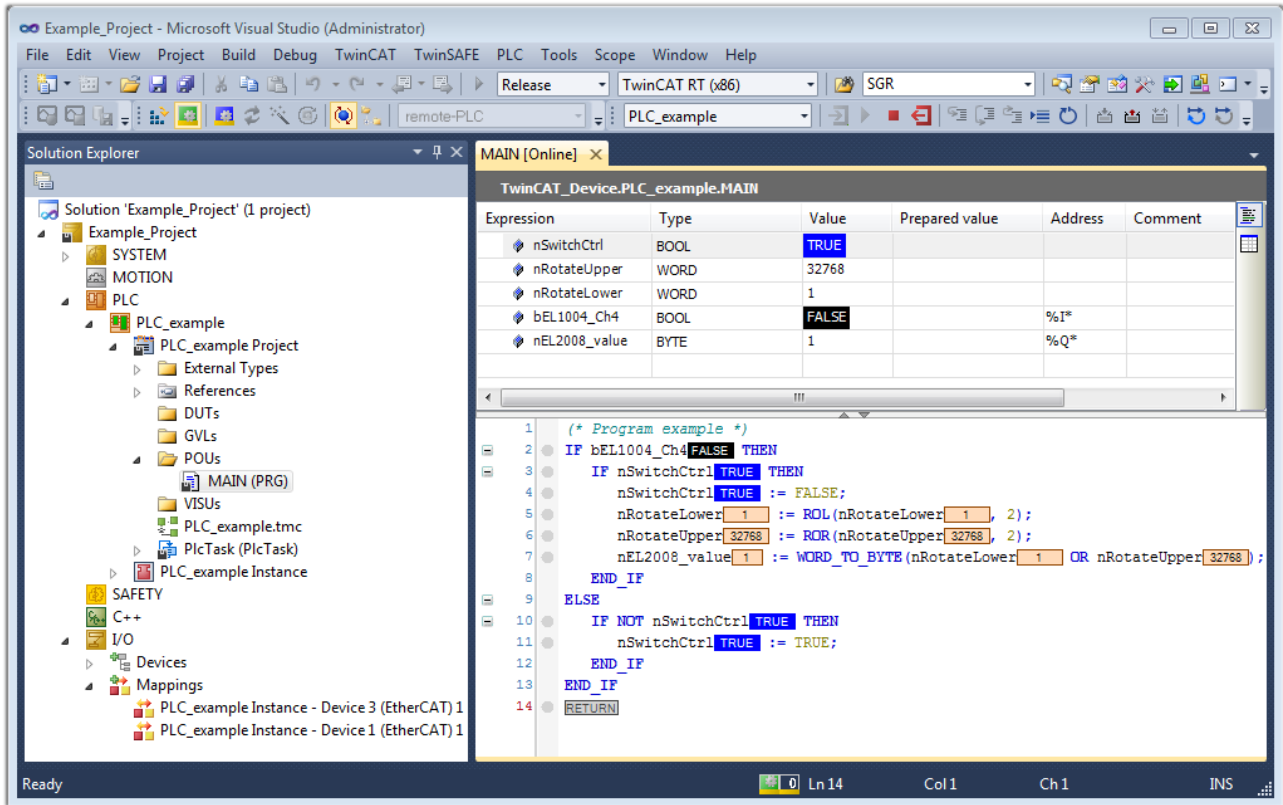



Fig. 82: TwinCAT 3 development environment (VS shell): logged-in, after program startup

The two operator control elements for stopping  and logout  result in the required action (also, “Shift + F5” can be used for stop, or both actions can be selected via the PLC menu).

## 6.2 TwinCAT Development Environment

The Software for automation TwinCAT (The Windows Control and Automation Technology) will be distinguished into:

- TwinCAT 2: System Manager (Configuration) & PLC Control (Programming)
- TwinCAT 3: Enhancement of TwinCAT 2 (Programming and Configuration takes place via a common Development Environment)

### Details:

- **TwinCAT 2:**
  - Connects I/O devices to tasks in a variable-oriented manner
  - Connects tasks to tasks in a variable-oriented manner
  - Supports units at the bit level
  - Supports synchronous or asynchronous relationships
  - Exchange of consistent data areas and process images
  - Datalink on NT - Programs by open Microsoft Standards (OLE, OCX, ActiveX, DCOM+, etc.)
  - Integration of IEC 61131-3-Software-SPS, Software- NC and Software-CNC within Windows NT/ 2000/XP/Vista, Windows 7, NT/XP Embedded, CE
  - Interconnection to all common fieldbusses
  - More...

### Additional features:

- **TwinCAT 3 (eXtended Automation):**
  - Visual Studio® integration
  - Choice of the programming language
  - Supports object orientated extension of IEC 61131-3
  - Usage of C/C++ as programming language for real time applications
  - Connection to MATLAB®/Simulink®
  - Open interface for expandability
  - Flexible run-time environment
  - Active support of multi-core- and 64 bit operating system
  - Automatic code generation and project creation with the TwinCAT Automation Interface
  - More...

Within the following sections commissioning of the TwinCAT Development Environment on a PC System for the control and also the basically functions of unique control elements will be explained.

Please see further information to TwinCAT 2 and TwinCAT 3 at <http://infosys.beckhoff.com>.

### 6.2.1 Installation of the TwinCAT real-time driver

In order to assign real-time capability to a standard Ethernet port of an IPC controller, the Beckhoff real-time driver has to be installed on this port under Windows.

This can be done in several ways.

#### A: Via the TwinCAT Adapter dialog

In the System Manager call up the TwinCAT overview of the local network interfaces via Options → Show Real Time Ethernet Compatible Devices.

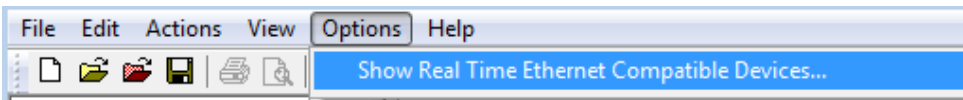

Fig. 83: System Manager “Options” (TwinCAT 2)

This have to be called up by the menu “TwinCAT” within the TwinCAT 3 environment:

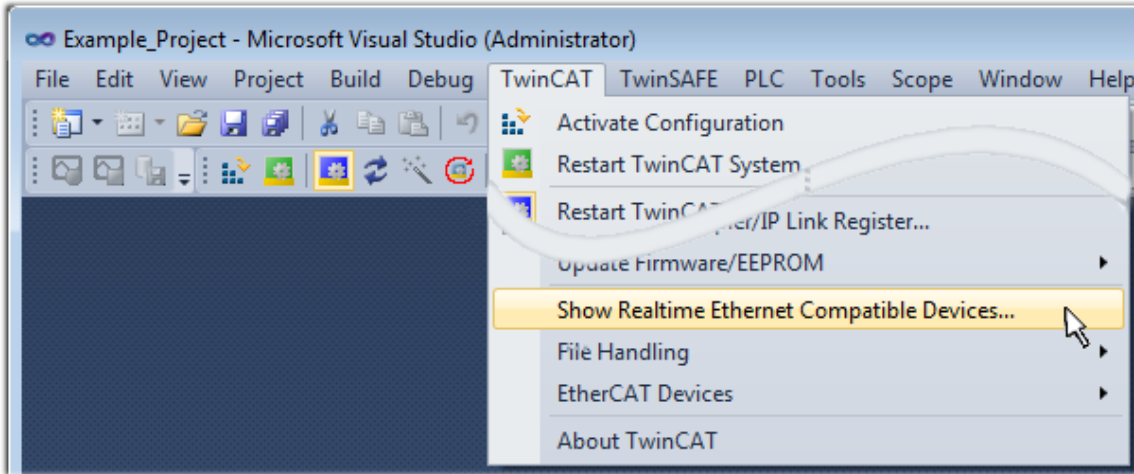

Fig. 84: Call up under VS Shell (TwinCAT 3)

**B: Via TcRtelInstall.exe in the TwinCAT directory**

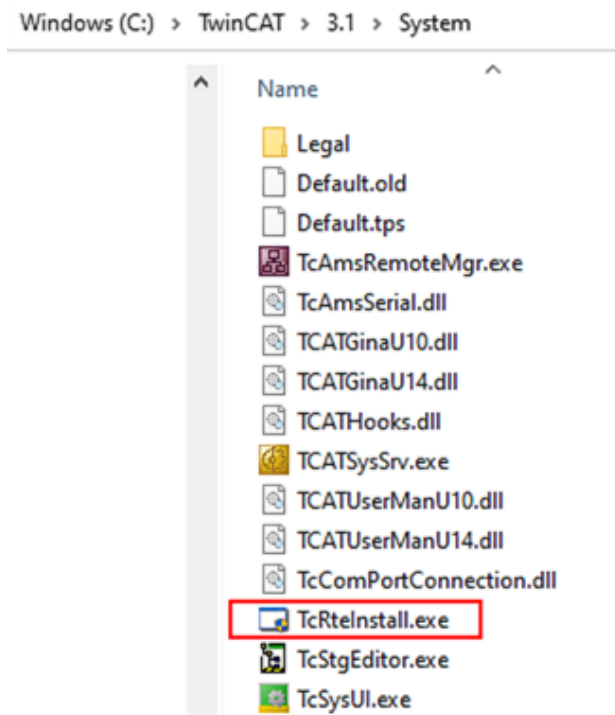

Fig. 85: TcRtelInstall in the TwinCAT directory

In both cases, the following dialog appears:

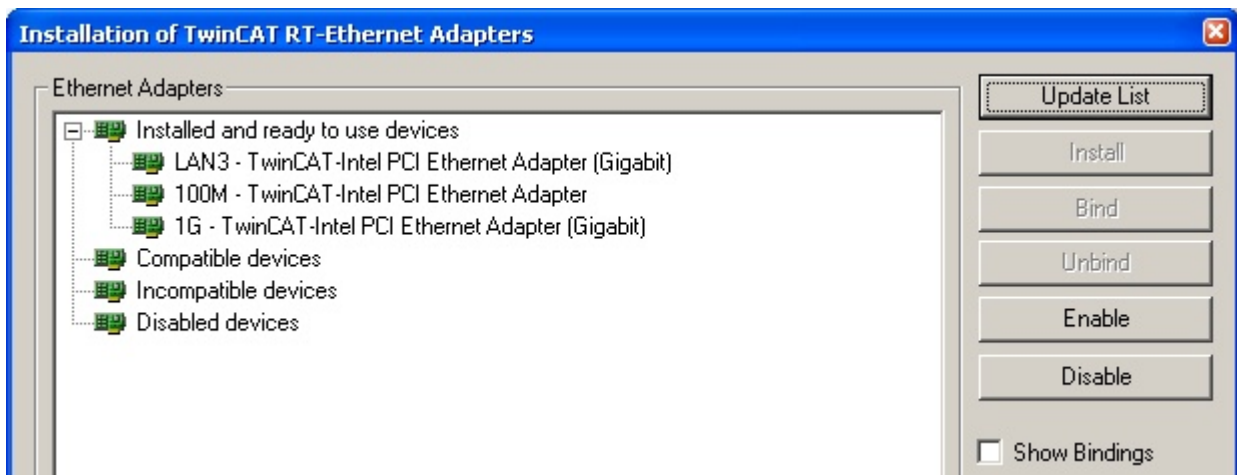

Fig. 86: Overview of network interfaces

Interfaces listed under “Compatible devices” can be assigned a driver via the “Install” button. A driver should only be installed on compatible devices.

A Windows warning regarding the unsigned driver can be ignored.

**Alternatively** an EtherCAT-device can be inserted first of all as described in chapter [Offline configuration creation](#), section “Creating the EtherCAT device” [▶ 117] in order to view the compatible ethernet ports via its EtherCAT properties (tab “Adapter”, button “Compatible Devices...”):



Fig. 87: EtherCAT device properties (TwinCAT 2): click on “Compatible Devices...” of tab “Adapter”

TwinCAT 3: the properties of the EtherCAT device can be opened by double click on “Device .. (EtherCAT)” within the Solution Explorer under “I/O”:

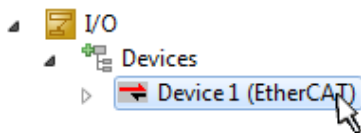

After the installation the driver appears activated in the Windows overview for the network interface (Windows Start → System Properties → Network)

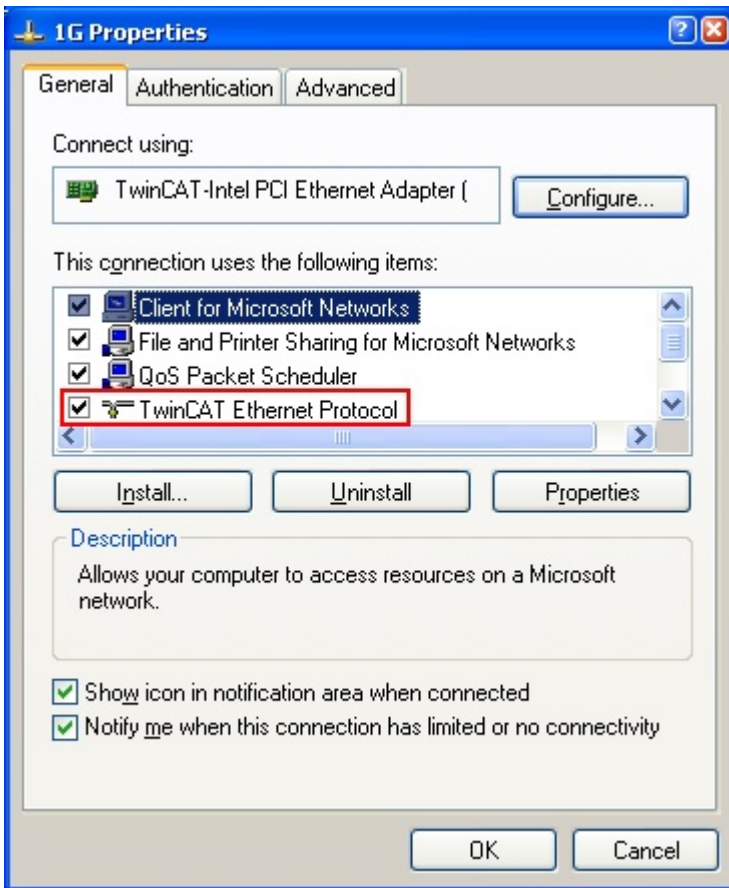

Fig. 88: Windows properties of the network interface

A correct setting of the driver could be:

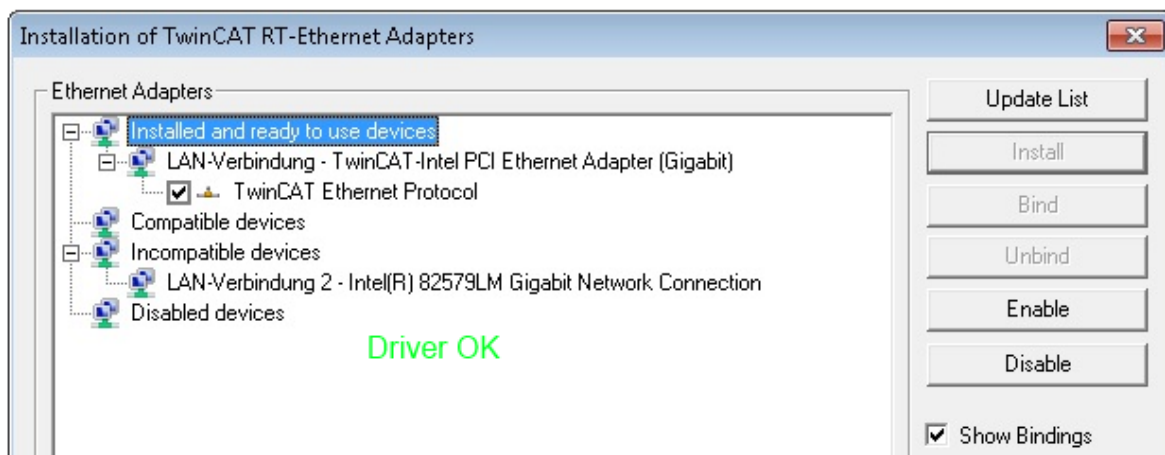

Fig. 89: Exemplary correct driver setting for the Ethernet port

Other possible settings have to be avoided:

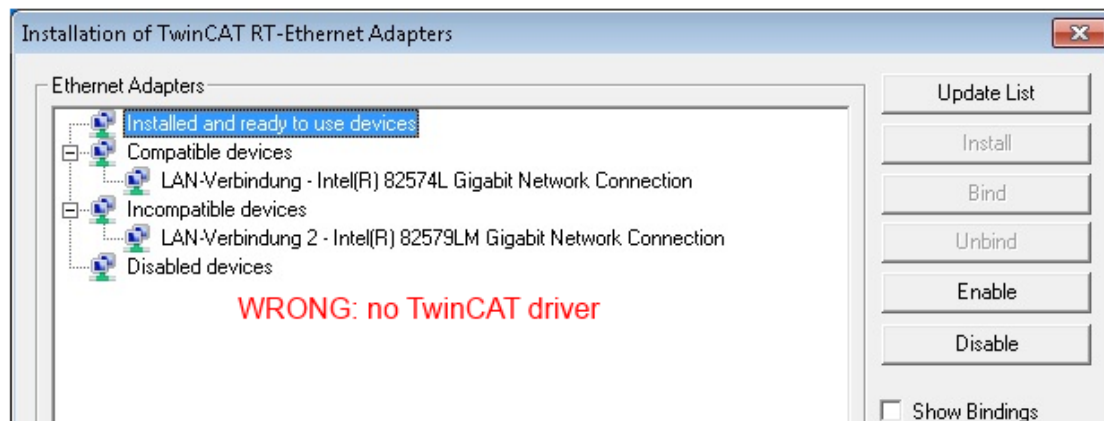
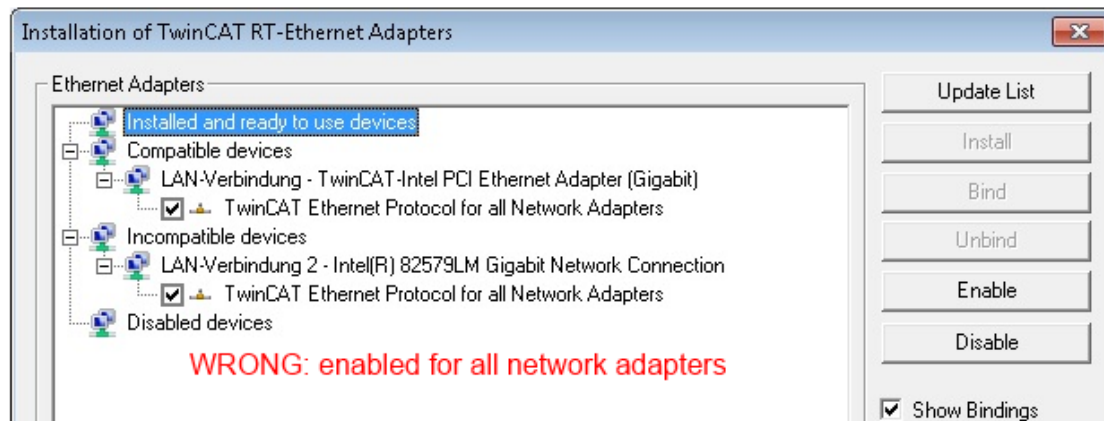
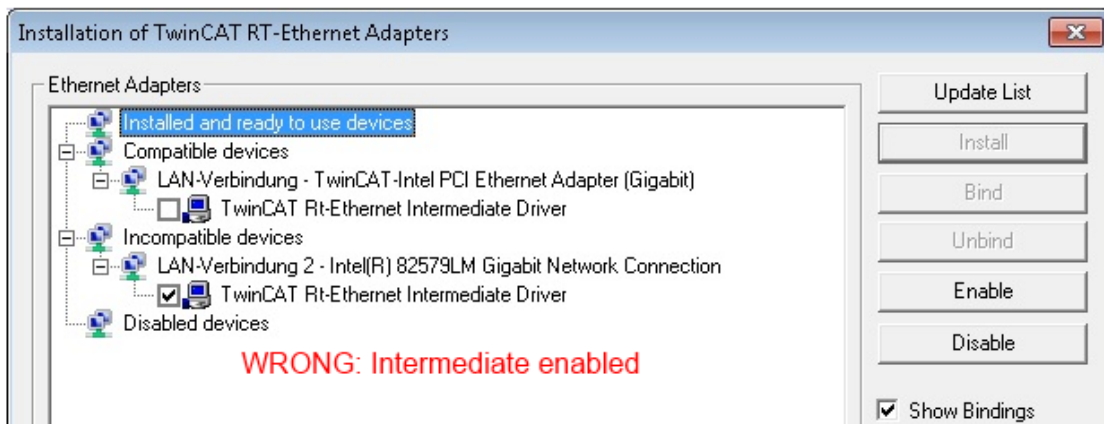
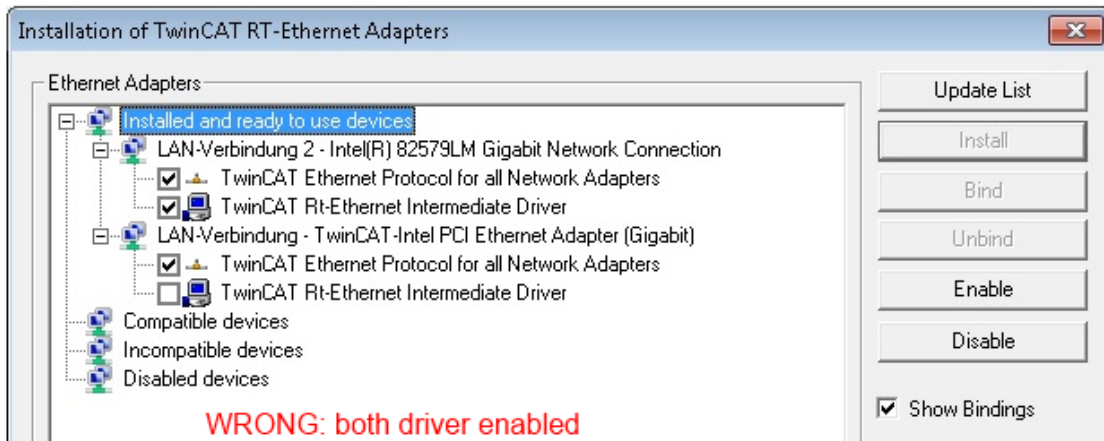

Fig. 90: Incorrect driver settings for the Ethernet port

## IP address of the port used

### ● IP address/DHCP

**i** In most cases an Ethernet port that is configured as an EtherCAT device will not transport general IP packets. For this reason and in cases where an EL6601 or similar devices are used it is useful to specify a fixed IP address for this port via the “Internet Protocol TCP/IP” driver setting and to disable DHCP. In this way the delay associated with the DHCP client for the Ethernet port assigning itself a default IP address in the absence of a DHCP server is avoided. A suitable address space is 192.168.x.x, for example.

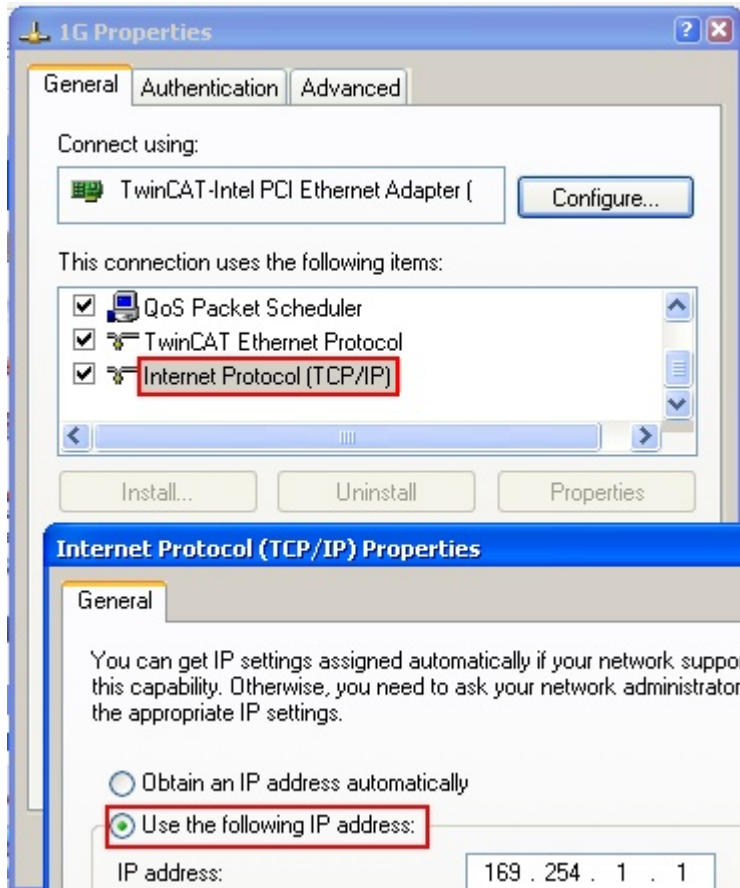

Fig. 91: TCP/IP setting for the Ethernet port

## 6.2.2 Notes regarding ESI device description

### Installation of the latest ESI device description

The TwinCAT EtherCAT master/System Manager needs the device description files for the devices to be used in order to generate the configuration in online or offline mode. The device descriptions are contained in the so-called ESI files (EtherCAT Slave Information) in XML format. These files can be requested from the respective manufacturer and are made available for download. An \*.xml file may contain several device descriptions.

The ESI files for Beckhoff EtherCAT devices are available on the [Beckhoff website](#).

The ESI files should be stored in the TwinCAT installation directory.

Default settings:

- **TwinCAT 2:** C:\TwinCAT\IO\EtherCAT
- **TwinCAT 3:** C:\TwinCAT\3.1\Config\Io\EtherCAT

The files are read (once) when a new System Manager window is opened, if they have changed since the last time the System Manager window was opened.

A TwinCAT installation includes the set of Beckhoff ESI files that was current at the time when the TwinCAT build was created.

For TwinCAT 2.11/TwinCAT 3 and higher, the ESI directory can be updated from the System Manager, if the programming PC is connected to the Internet; by

- **TwinCAT 2:** Option → “Update EtherCAT Device Descriptions”
- **TwinCAT 3:** TwinCAT → EtherCAT Devices → “Update Device Descriptions (via ETG Website)...”

The [TwinCAT ESI Updater](#) [▶ 116] is available for this purpose.



### ESI

The \*.xml files are associated with \*.xsd files, which describe the structure of the ESI XML files. To update the ESI device descriptions, both file types should therefore be updated.

### Device differentiation

EtherCAT devices/slaves are distinguished by four properties, which determine the full device identifier. For example, the device identifier EL2521-0025-1018 consists of:

- family key “EL”
- name “2521”
- type “0025”
- and revision “1018”

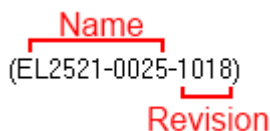

Fig. 92: Identifier structure

The order identifier consisting of name + type (here: EL2521-0025) describes the device function. The revision indicates the technical progress and is managed by Beckhoff. In principle, a device with a higher revision can replace a device with a lower revision, unless specified otherwise, e.g. in the documentation. Each revision has its own ESI description. See [further notes](#) [▶ 12].



## Online description

If the EtherCAT configuration is created online through scanning of real devices (see section Online setup) and no ESI descriptions are available for a slave (specified by name and revision) that was found, the System Manager asks whether the description stored in the device should be used. In any case, the System Manager needs this information for setting up the cyclic and acyclic communication with the slave correctly.

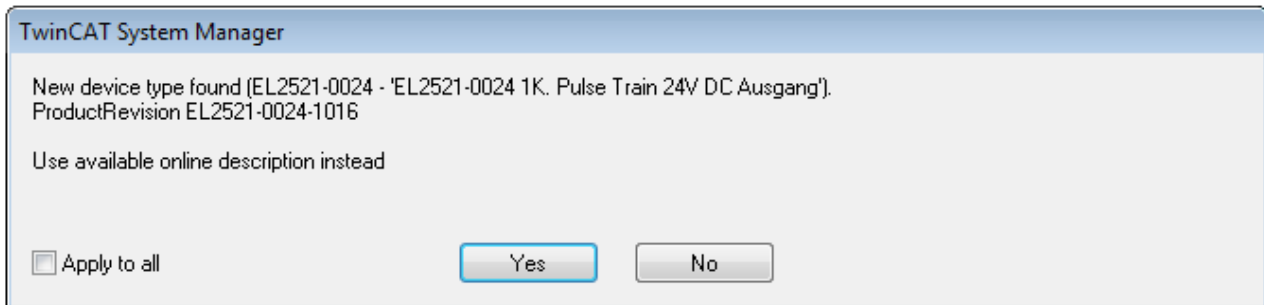

Fig. 93: OnlineDescription information window (TwinCAT 2)

In TwinCAT 3 a similar window appears, which also offers the Web update:

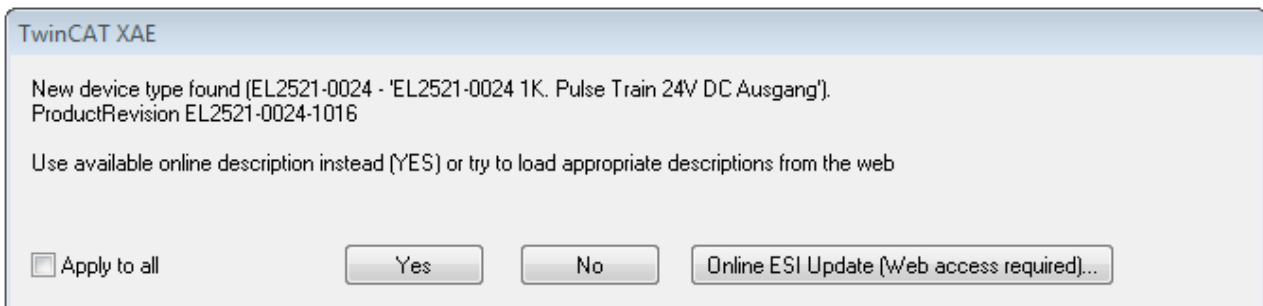

Fig. 94: Information window OnlineDescription (TwinCAT 3)

If possible, the Yes is to be rejected and the required ESI is to be requested from the device manufacturer. After installation of the XML/XSD file the configuration process should be repeated.

### NOTICE

#### Changing the “usual” configuration through a scan

- ✓ If a scan discovers a device that is not yet known to TwinCAT, distinction has to be made between two cases. Taking the example here of the EL2521-0000 in the revision 1019
  - a) no ESI is present for the EL2521-0000 device at all, either for the revision 1019 or for an older revision. The ESI must then be requested from the manufacturer (in this case Beckhoff).
  - b) an ESI is present for the EL2521-0000 device, but only in an older revision, e.g. 1018 or 1017. In this case an in-house check should first be performed to determine whether the spare parts stock allows the integration of the increased revision into the configuration at all. A new/higher revision usually also brings along new features. If these are not to be used, work can continue without reservations with the previous revision 1018 in the configuration. This is also stated by the Beckhoff compatibility rule.

Refer in particular to the chapter “[General notes on the use of Beckhoff EtherCAT IO components](#)” and for manual configuration to the chapter “[Offline configuration creation \[► 117\]](#)”.

If the OnlineDescription is used regardless, the System Manager reads a copy of the device description from the EEPROM in the EtherCAT slave. In complex slaves the size of the EEPROM may not be sufficient for the complete ESI, in which case the ESI would be *incomplete* in the configurator. Therefore it's recommended using an offline ESI file with priority in such a case.

The System Manager creates for online recorded device descriptions a new file “OnlineDescription0000...xml” in its ESI directory, which contains all ESI descriptions that were read online.

OnlineDescriptionCache00000002.xml

Fig. 95: File OnlineDescription.xml created by the System Manager

If a slave desired to be added manually to the configuration at a later stage, online created slaves are indicated by a prepended symbol ">" in the selection list (see Figure *Indication of an online recorded ESI of EL2521 as an example*).

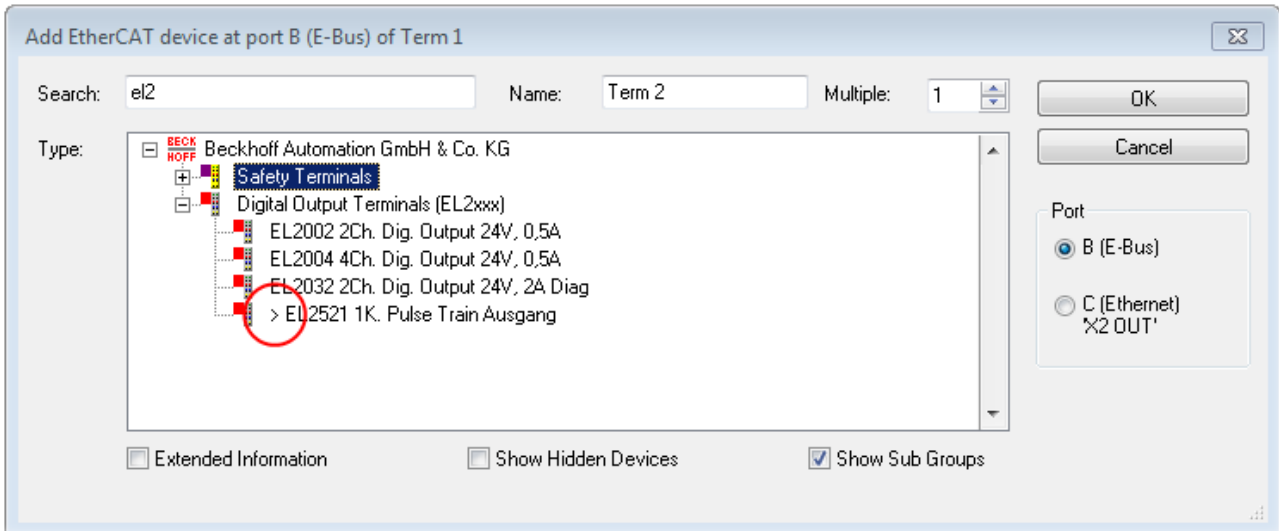

Fig. 96: Indication of an online recorded ESI of EL2521 as an example

If such ESI files are used and the manufacturer's files become available later, the file OnlineDescription.xml should be deleted as follows:

- close all System Manager windows
- restart TwinCAT in Config mode
- delete "OnlineDescription0000...xml"
- restart TwinCAT System Manager

This file should not be visible after this procedure, if necessary press <F5> to update

### **i** OnlineDescription for TwinCAT 3.x

In addition to the file described above "OnlineDescription0000...xml", a so called EtherCAT cache with new discovered devices is created by TwinCAT 3.x, e.g. under Windows 7:

`C:\User\[USERNAME]\AppData\Roaming\Beckhoff\TwinCAT3\Components\Base\EtherCATCache.xml`

(Please note the language settings of the OS!)

You have to delete this file, too.

### Faulty ESI file

If an ESI file is faulty and the System Manager is unable to read it, the System Manager brings up an information window.

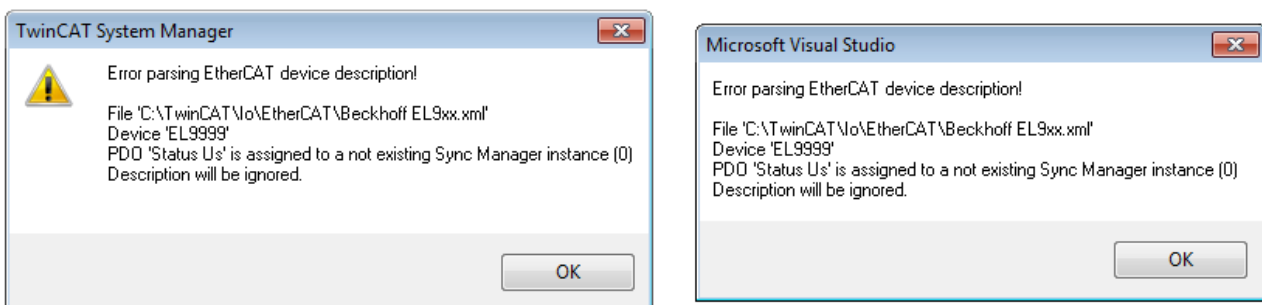

Fig. 97: Information window for faulty ESI file (left: TwinCAT 2; right: TwinCAT 3)

Reasons may include:

- Structure of the \*.xml does not correspond to the associated \*.xsd file → check your schematics
- Contents cannot be translated into a device description → contact the file manufacturer

### 6.2.3 TwinCAT ESI Updater

For TwinCAT 2.11 and higher, the System Manager can search for current Beckhoff ESI files automatically, if an online connection is available:

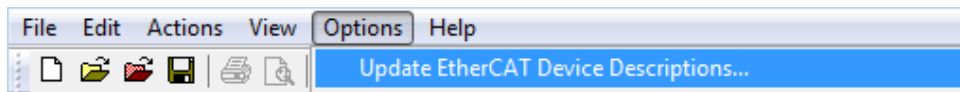

Fig. 98: Using the ESI Updater (>= TwinCAT 2.11)

The call up takes place under:  
“Options” → “Update EtherCAT Device Descriptions”

Selection under TwinCAT 3:

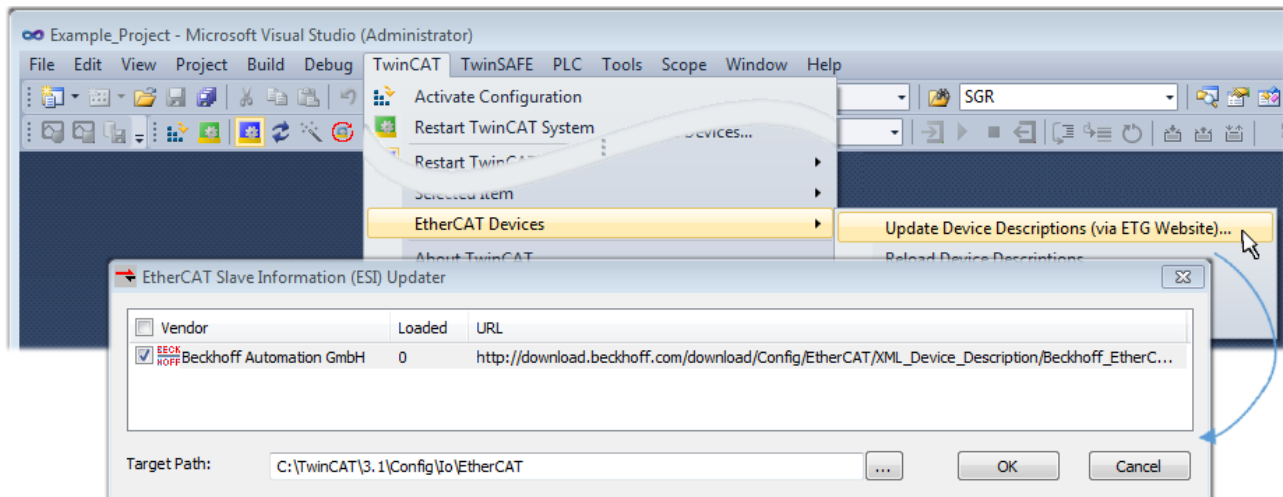

Fig. 99: Using the ESI Updater (TwinCAT 3)

The ESI Updater (TwinCAT 3) is a convenient option for automatic downloading of ESI data provided by EtherCAT manufacturers via the Internet into the TwinCAT directory (ESI = EtherCAT slave information). TwinCAT accesses the central ESI ULR directory list stored at ETG; the entries can then be viewed in the Updater dialog, although they cannot be changed there.

The call up takes place under:  
“TwinCAT” → “EtherCAT Devices” → “Update Device Description (via ETG Website)...”.

### 6.2.4 Distinction between Online and Offline

The distinction between online and offline refers to the presence of the actual I/O environment (drives, terminals, EJ-modules). If the configuration is to be prepared in advance of the system configuration as a programming system, e.g. on a laptop, this is only possible in “Offline configuration” mode. In this case all components have to be entered manually in the configuration, e.g. based on the electrical design.

If the designed control system is already connected to the EtherCAT system and all components are energised and the infrastructure is ready for operation, the TwinCAT configuration can simply be generated through “scanning” from the runtime system. This is referred to as online configuration.

In any case, during each startup the EtherCAT master checks whether the slaves it finds match the configuration. This test can be parameterised in the extended slave settings. Refer to [note “Installation of the latest ESI-XML device description” \[▶ 112\]](#).

#### For preparation of a configuration:

- the real EtherCAT hardware (devices, couplers, drives) must be present and installed
- the devices/modules must be connected via EtherCAT cables or in the terminal/ module strand in the same way as they are intended to be used later
- the devices/modules be connected to the power supply and ready for communication

- TwinCAT must be in CONFIG mode on the target system.

**The online scan process consists of:**

- detecting the EtherCAT device [▶ 122] (Ethernet port at the IPC)
- detecting the connected EtherCAT devices [▶ 123]. This step can be carried out independent of the preceding step
- troubleshooting [▶ 126]

The scan with existing configuration [▶ 127] can also be carried out for comparison.

## 6.2.5 OFFLINE configuration creation

### Creating the EtherCAT device

Create an EtherCAT device in an empty System Manager window.

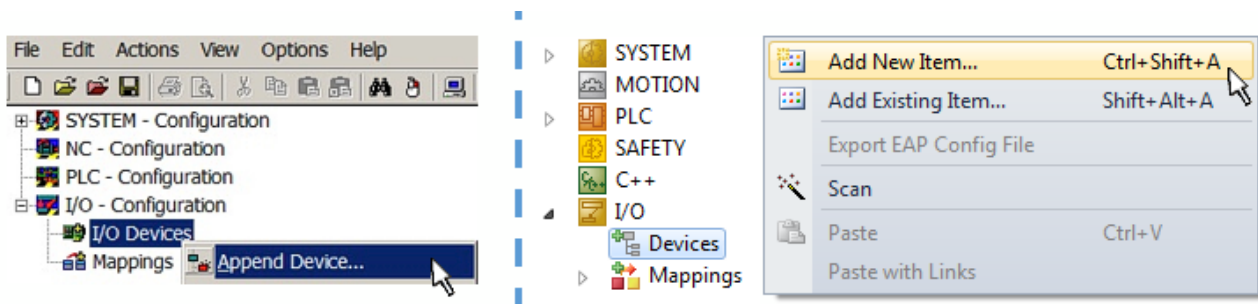

Fig. 100: Append EtherCAT device (left: TwinCAT 2; right: TwinCAT 3)

Select type “EtherCAT” for an EtherCAT I/O application with EtherCAT slaves. For the present publisher/ subscriber service in combination with an EL6601/EL6614 terminal select “EtherCAT Automation Protocol via EL6601”.

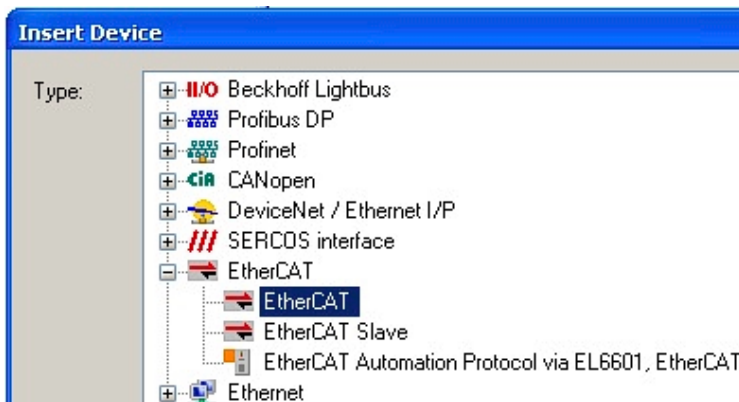

Fig. 101: Selecting the EtherCAT connection (TwinCAT 2.11, TwinCAT 3)

Then assign a real Ethernet port to this virtual device in the runtime system.

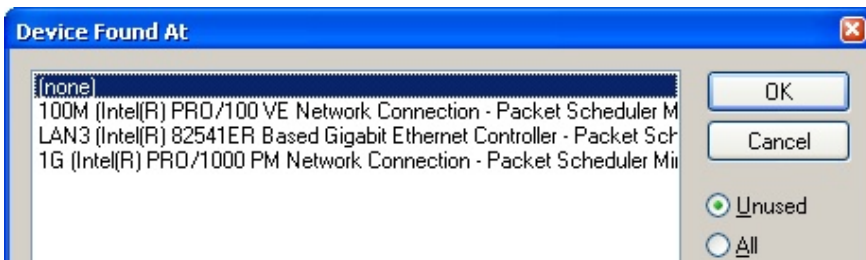

Fig. 102: Selecting the Ethernet port

This query may appear automatically when the EtherCAT device is created, or the assignment can be set/modified later in the properties dialog; see Fig. “EtherCAT device properties (TwinCAT 2)”.

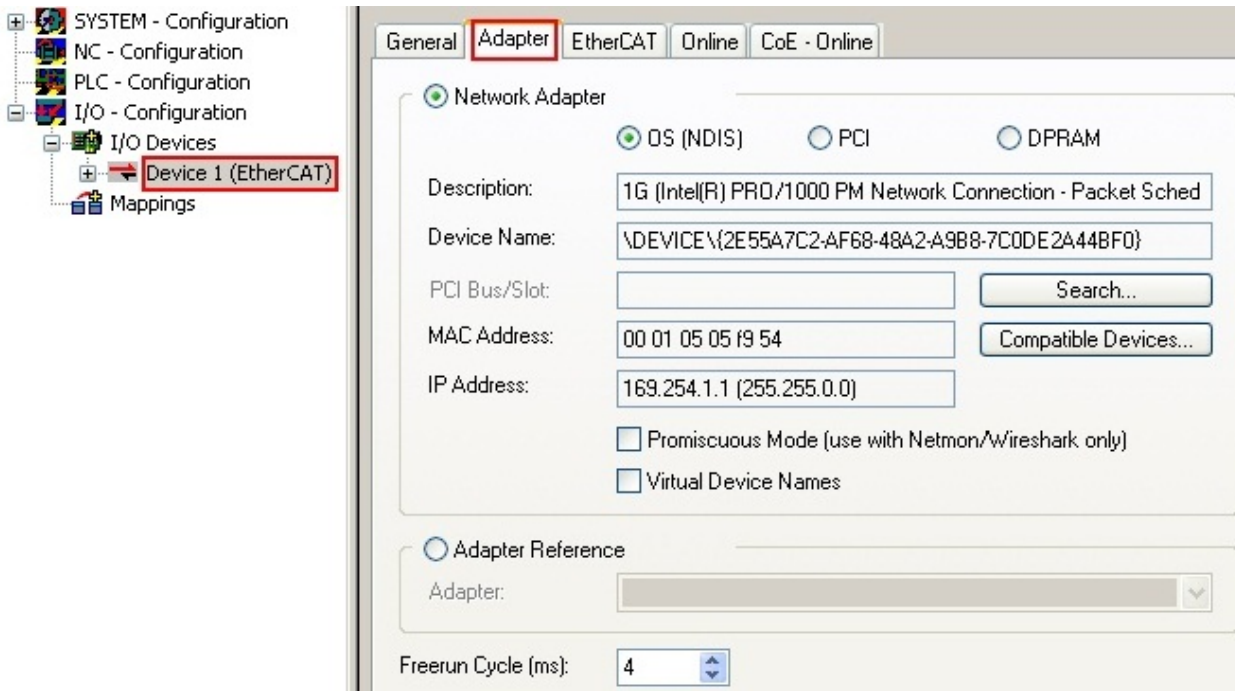
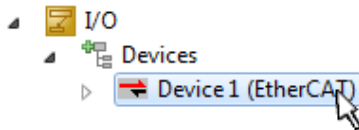

Fig. 103: EtherCAT device properties (TwinCAT 2)

TwinCAT 3: the properties of the EtherCAT device can be opened by double click on “Device .. (EtherCAT)” within the Solution Explorer under “I/O”:



**i** **Selecting the Ethernet port**

Ethernet ports can only be selected for EtherCAT devices for which the TwinCAT real-time driver is installed. This has to be done separately for each port. Please refer to the respective [installation page \[p. 106\]](#).

**Defining EtherCAT slaves**

Further devices can be appended by right-clicking on a device in the configuration tree.

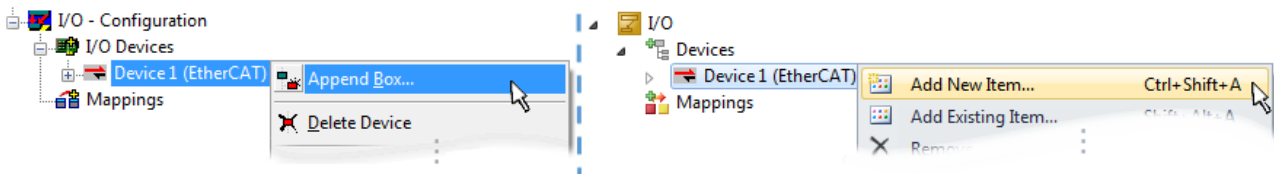

Fig. 104: Appending EtherCAT devices (left: TwinCAT 2; right: TwinCAT 3)

The dialog for selecting a new device opens. Only devices for which ESI files are available are displayed.

Only devices are offered for selection that can be appended to the previously selected device. Therefore, the physical layer available for this port is also displayed (Fig. “Selection dialog for new EtherCAT device”, A). In the case of cable-based Fast-Ethernet physical layer with PHY transfer, then also only cable-based devices are available, as shown in Fig. “Selection dialog for new EtherCAT device”. If the preceding device has several free ports (e.g. EK1122 or EK1100), the required port can be selected on the right-hand side (A).

Overview of physical layer

- “Ethernet”: cable-based 100BASE-TX: couplers, box modules, devices with RJ45/M8/M12 connector

- “E-Bus”: LVDS “terminal bus”, EtherCAT plug-in modules (EJ), EtherCAT terminals (EL/ES), various modular modules

The search field facilitates finding specific devices (since TwinCAT 2.11 or TwinCAT 3).

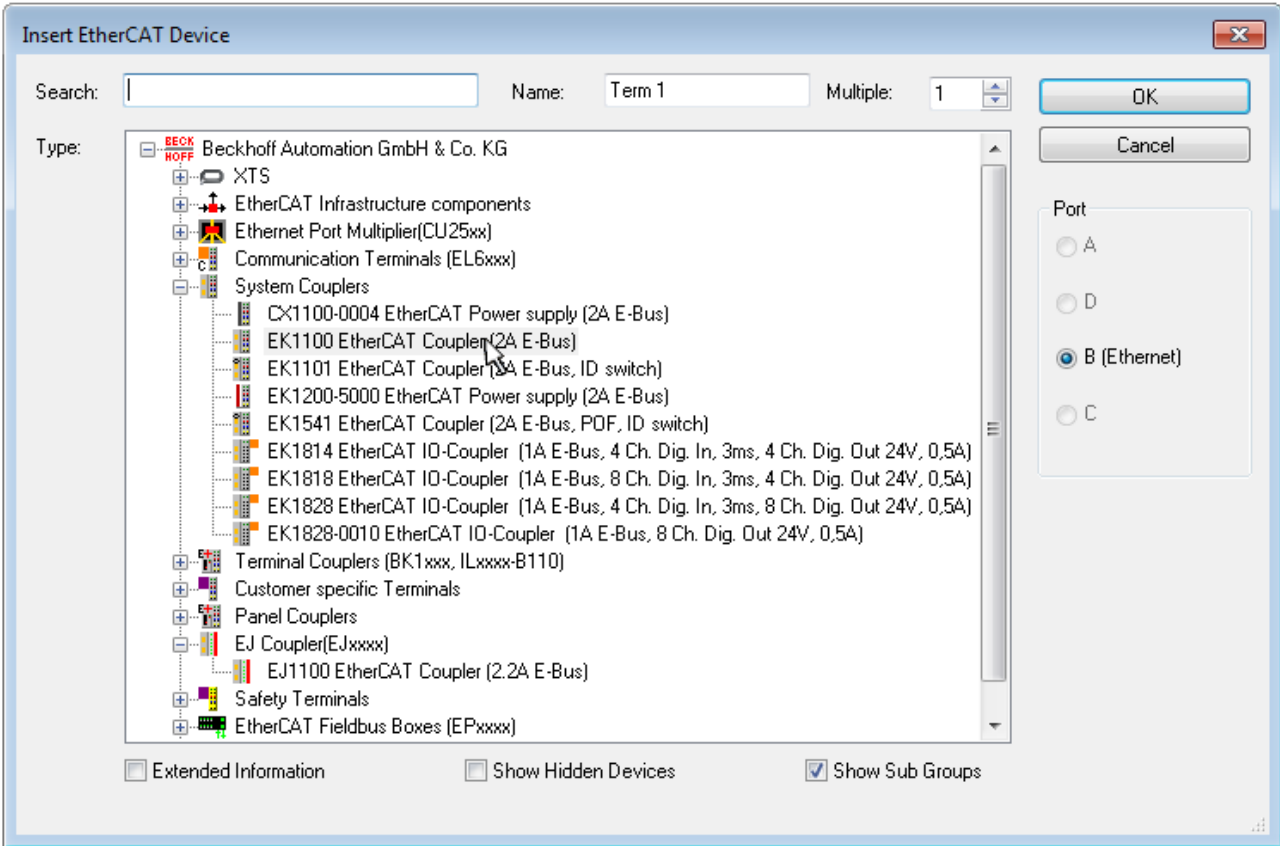

Fig. 105: Selection dialog for new EtherCAT device

By default, only the name/device type is used as selection criterion. For selecting a specific revision of the device, the revision can be displayed as “Extended Information”.

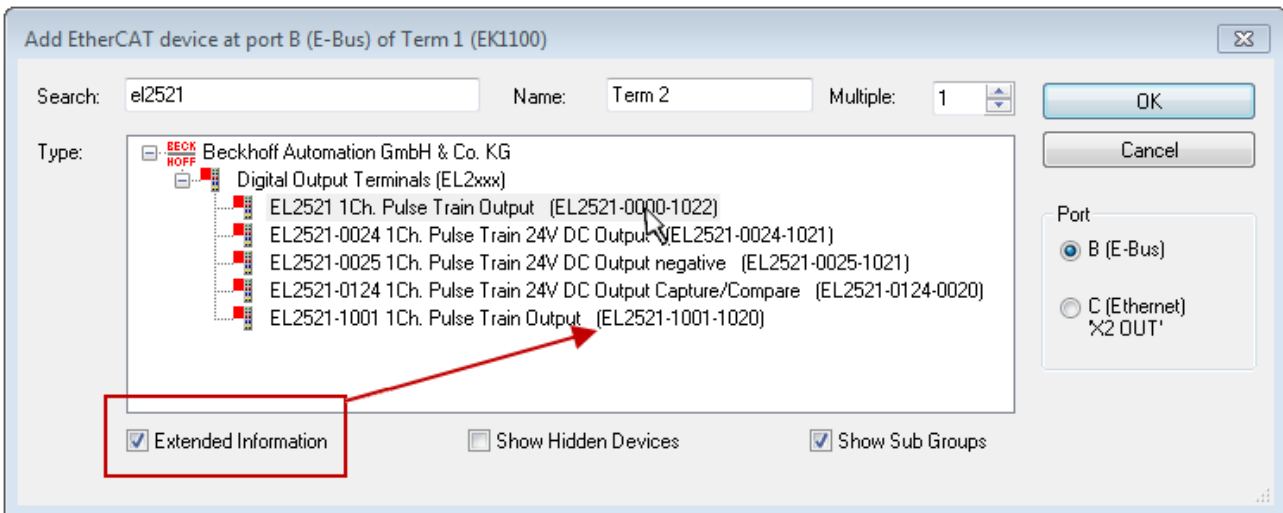

Fig. 106: Display of device revision

In many cases several device revisions were created for historic or functional reasons, e.g. through technological advancement. For simplification purposes (see Fig. “Selection dialog for new EtherCAT device”) only the last (i.e. highest) revision and therefore the latest state of production is displayed in the selection dialog for Beckhoff devices. To show all device revisions available in the system as ESI descriptions tick the “Show Hidden Devices” check box, see Fig. “Display of previous revisions”.

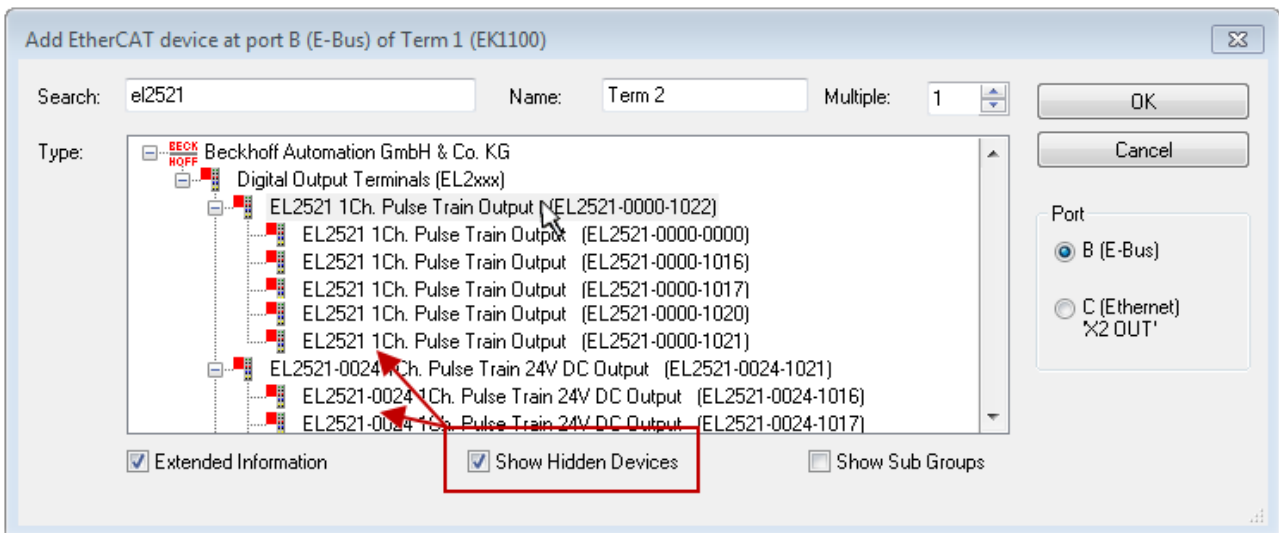

Fig. 107: Display of previous revisions

### ● Device selection based on revision, compatibility

**i** The ESI description also defines the process image, the communication type between master and slave/device and the device functions, if applicable. The physical device (firmware, if available) has to support the communication queries/settings of the master. This is backward compatible, i.e. newer devices (higher revision) should be supported if the EtherCAT master addresses them as an older revision. The following compatibility rule of thumb is to be assumed for Beckhoff EtherCAT Terminals/ Boxes/ EJ-modules:

#### **device revision in the system $\geq$ device revision in the configuration**

This also enables subsequent replacement of devices without changing the configuration (different specifications are possible for drives).

### Example

If an EL2521-0025-**1018** is specified in the configuration, an EL2521-0025-**1018** or higher (**-1019**, **-1020**) can be used in practice.

Name  
(EL2521-0025-1018)  
Revision

Fig. 108: Name/revision of the terminal

If current ESI descriptions are available in the TwinCAT system, the last revision offered in the selection dialog matches the Beckhoff state of production. It is recommended to use the last device revision when creating a new configuration, if current Beckhoff devices are used in the real application. Older revisions should only be used if older devices from stock are to be used in the application.

In this case the process image of the device is shown in the configuration tree and can be parameterized as follows: linking with the task, CoE/DC settings, plug-in definition, startup settings, ...



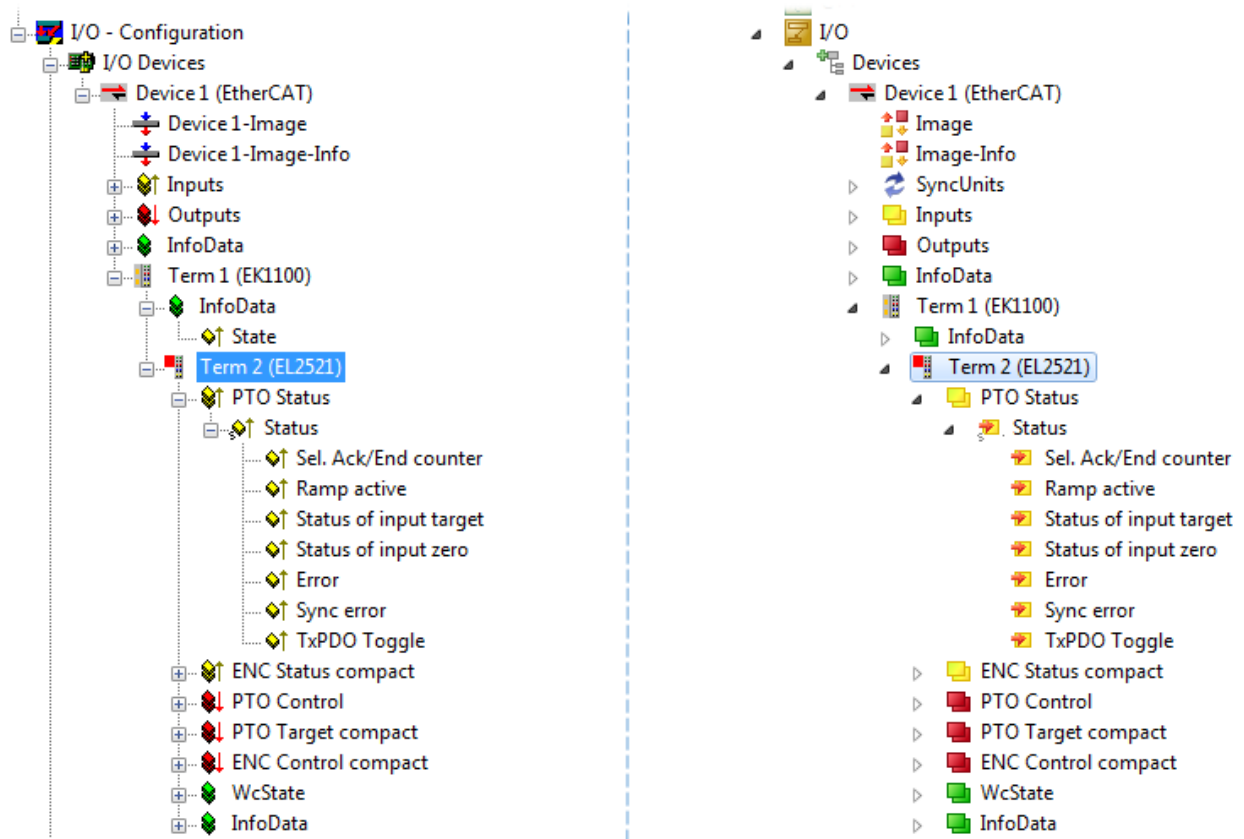



Fig. 109: EtherCAT terminal in the TwinCAT tree (left: TwinCAT 2; right: TwinCAT 3)



## 6.2.6 ONLINE configuration creation

### Detecting/scanning of the EtherCAT device

The online device search can be used if the TwinCAT system is in CONFIG mode. This can be indicated by a symbol right below in the information bar:



- on TwinCAT 2 by a blue display “Config Mode” within the System Manager window:  .
- on TwinCAT 3 within the user interface of the development environment by a symbol  .

TwinCAT can be set into this mode:

- TwinCAT 2: by selection of  in the Menubar or by “Actions” → “Set/Reset TwinCAT to Config Mode...”
- TwinCAT 3: by selection of  in the Menubar or by “TwinCAT” → “Restart TwinCAT (Config Mode)”

### ● Online scanning in Config mode

**i** The online search is not available in RUN mode (production operation). Note the differentiation between TwinCAT programming system and TwinCAT target system.

The TwinCAT 2 icon () or TwinCAT 3 icon () within the Windows-Taskbar always shows the TwinCAT mode of the local IPC. Compared to that, the System Manager window of TwinCAT 2 or the user interface of TwinCAT 3 indicates the state of the target system.

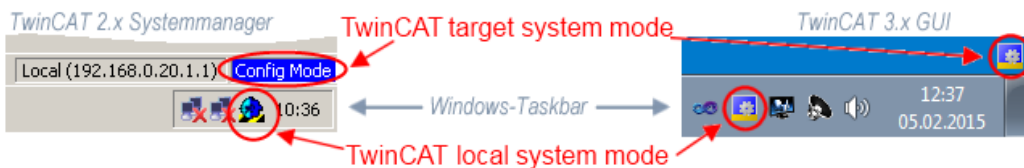

Fig. 110: Differentiation local/target system (left: TwinCAT 2; right: TwinCAT 3)

Right-clicking on “I/O Devices” in the configuration tree opens the search dialog.

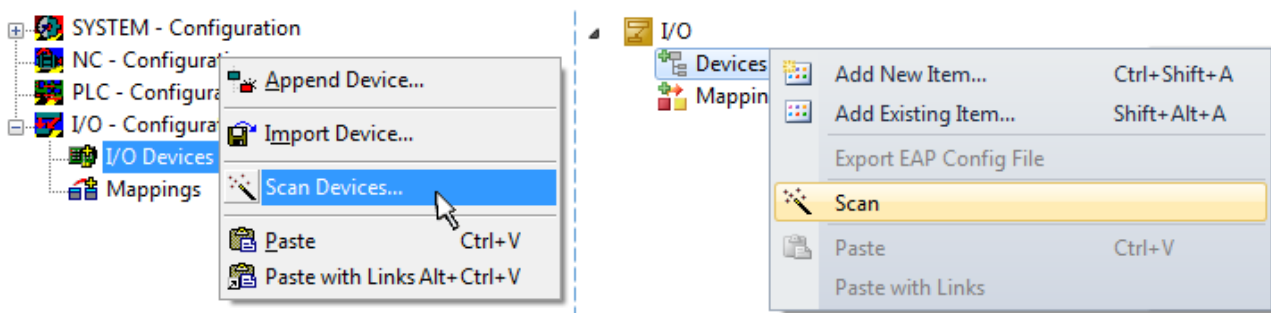

Fig. 111: Scan Devices (left: TwinCAT 2; right: TwinCAT 3)

This scan mode attempts to find not only EtherCAT devices (or Ethernet ports that are usable as such), but also NOVDRAM, fieldbus cards, SMB etc. However, not all devices can be found automatically.

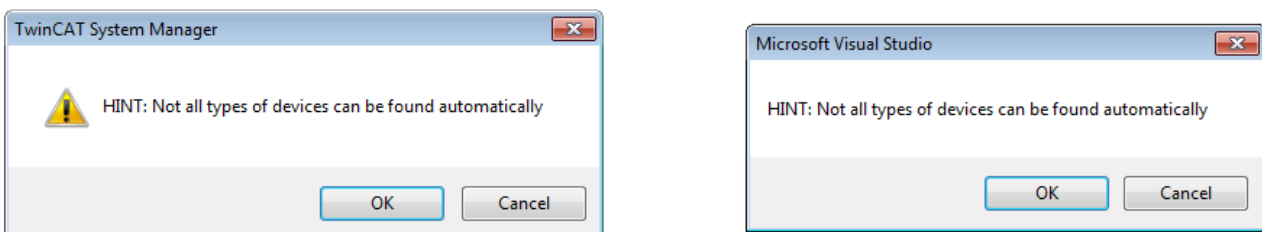

Fig. 112: Note for automatic device scan (left: TwinCAT 2; right: TwinCAT 3)

Ethernet ports with installed TwinCAT real-time driver are shown as “RT Ethernet” devices. An EtherCAT frame is sent to these ports for testing purposes. If the scan agent detects from the response that an EtherCAT slave is connected, the port is immediately shown as an “EtherCAT Device” .

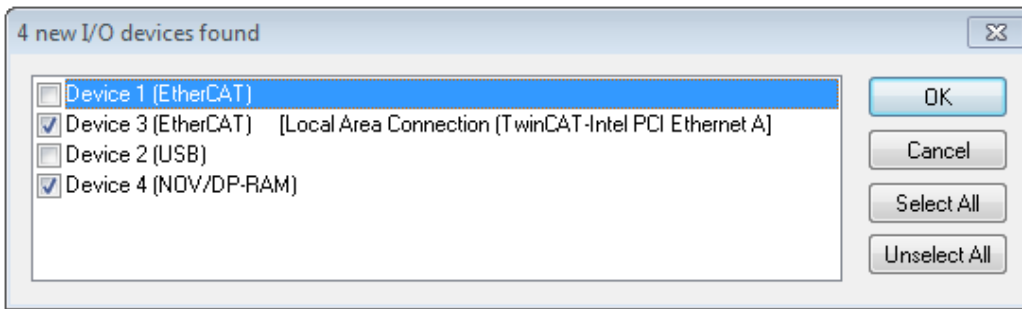

Fig. 113: Detected Ethernet devices

Via respective checkboxes devices can be selected (as illustrated in Fig. “Detected Ethernet devices” e.g. Device 3 and Device 4 were chosen). After confirmation with “OK” a device scan is suggested for all selected devices, see Fig.: “Scan query after automatic creation of an EtherCAT device”.

**● Selecting the Ethernet port**



Ethernet ports can only be selected for EtherCAT devices for which the TwinCAT real-time driver is installed. This has to be done separately for each port. Please refer to the respective [installation page](#) [▶ 106].

**Detecting/Scanning the EtherCAT devices**

**● Online scan functionality**



During a scan the master queries the identity information of the EtherCAT slaves from the slave EEPROM. The name and revision are used for determining the type. The respective devices are located in the stored ESI data and integrated in the configuration tree in the default state defined there.

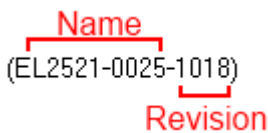

Fig. 114: Example default state

**NOTICE**

**Slave scanning in practice in series machine production**

The scanning function should be used with care. It is a practical and fast tool for creating an initial configuration as a basis for commissioning. In series machine production or reproduction of the plant, however, the function should no longer be used for the creation of the configuration, but if necessary for [comparison](#) [▶ 127] with the defined initial configuration. Background: since Beckhoff occasionally increases the revision version of the delivered products for product maintenance reasons, a configuration can be created by such a scan which (with an identical machine construction) is identical according to the device list; however, the respective device revision may differ from the initial configuration.

**Example:**

Company A builds the prototype of a machine B, which is to be produced in series later on. To do this the prototype is built, a scan of the IO devices is performed in TwinCAT and the initial configuration “B.tsm” is created. The EL2521-0025 EtherCAT terminal with the revision 1018 is located somewhere. It is thus built into the TwinCAT configuration in this way:

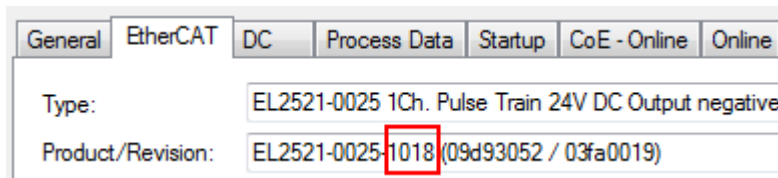

Fig. 115: Installing EthetCAT terminal with revision -1018

Likewise, during the prototype test phase, the functions and properties of this terminal are tested by the programmers/commissioning engineers and used if necessary, i.e. addressed from the PLC “B.pro” or the NC. (the same applies correspondingly to the TwinCAT 3 solution files).

The prototype development is now completed and series production of machine B starts, for which Beckhoff continues to supply the EL2521-0025-0018. If the commissioning engineers of the series machine production department always carry out a scan, a B configuration with the identical contents results again for each machine. Likewise, A might create spare parts stores worldwide for the coming series-produced machines with EL2521-0025-1018 terminals.

After some time Beckhoff extends the EL2521-0025 by a new feature C. Therefore the FW is changed, outwardly recognizable by a higher FW version and a **new revision -1019**. Nevertheless the new device naturally supports functions and interfaces of the predecessor version(s); an adaptation of “B.tsm” or even “B.pro” is therefore unnecessary. The series-produced machines can continue to be built with “B.tsm” and “B.pro”; it makes sense to perform a comparative scan [► 127] against the initial configuration “B.tsm” in order to check the built machine.

However, if the series machine production department now doesn't use “B.tsm”, but instead carries out a scan to create the productive configuration, the revision **-1019** is automatically detected and built into the configuration:

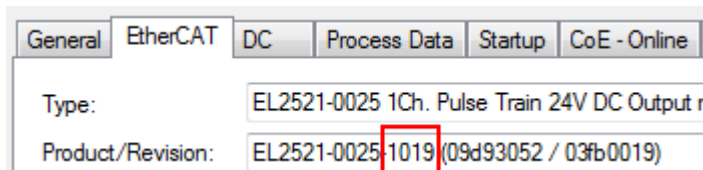

Fig. 116: Detection of EtherCAT terminal with revision -1019

This is usually not noticed by the commissioning engineers. TwinCAT cannot signal anything either, since a new configuration is essentially created. According to the compatibility rule, however, this means that no EL2521-0025-**1018** should be built into this machine as a spare part (even if this nevertheless works in the vast majority of cases).

In addition, it could be the case that, due to the development accompanying production in company A, the new feature C of the EL2521-0025-1019 (for example, an improved analog filter or an additional process data for the diagnosis) is discovered and used without in-house consultation. The previous stock of spare part devices are then no longer to be used for the new configuration “B2.tsm” created in this way. If series machine production is established, the scan should only be performed for informative purposes for comparison with a defined initial configuration. Changes are to be made with care!

If an EtherCAT device was created in the configuration (manually or through a scan), the I/O field can be scanned for devices/slaves.



Fig. 117: Scan query after automatic creation of an EtherCAT device (left: TwinCAT 2; right: TwinCAT 3)

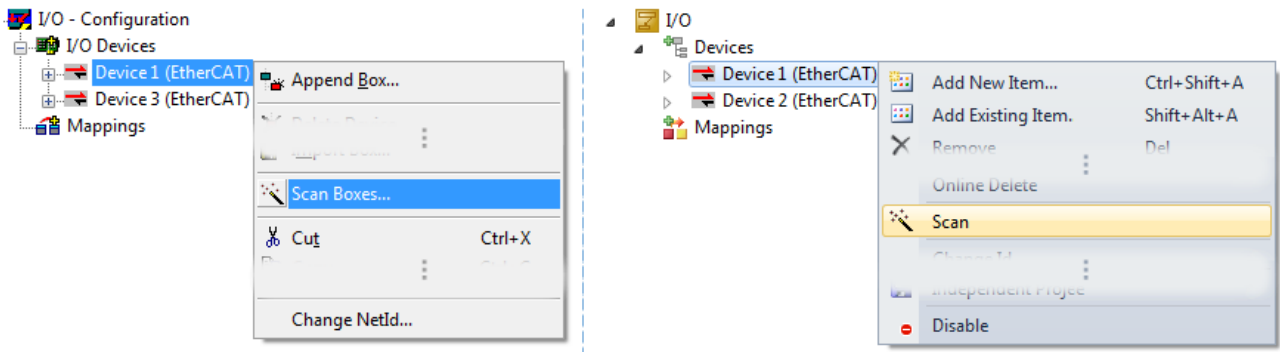

Fig. 118: Manual scanning for devices on a specified EtherCAT device (left: TwinCAT 2; right: TwinCAT 3)

In the System Manager (TwinCAT 2) or the User Interface (TwinCAT 3) the scan process can be monitored via the progress bar at the bottom in the status bar.



Fig. 119: Scan progress exemplary by TwinCAT 2

The configuration is established and can then be switched to online state (OPERATIONAL).



Fig. 120: Config/FreeRun query (left: TwinCAT 2; right: TwinCAT 3)

In Config/FreeRun mode the System Manager display alternates between blue and red, and the EtherCAT device continues to operate with the idling cycle time of 4 ms (default setting), even without active task (NC, PLC).



Fig. 121: Displaying of “Free Run” and “Config Mode” toggling right below in the status bar



Fig. 122: TwinCAT can also be switched to this state by using a button (left: TwinCAT 2; right: TwinCAT 3)

The EtherCAT system should then be in a functional cyclic state, as shown in Fig. *Online display example*.

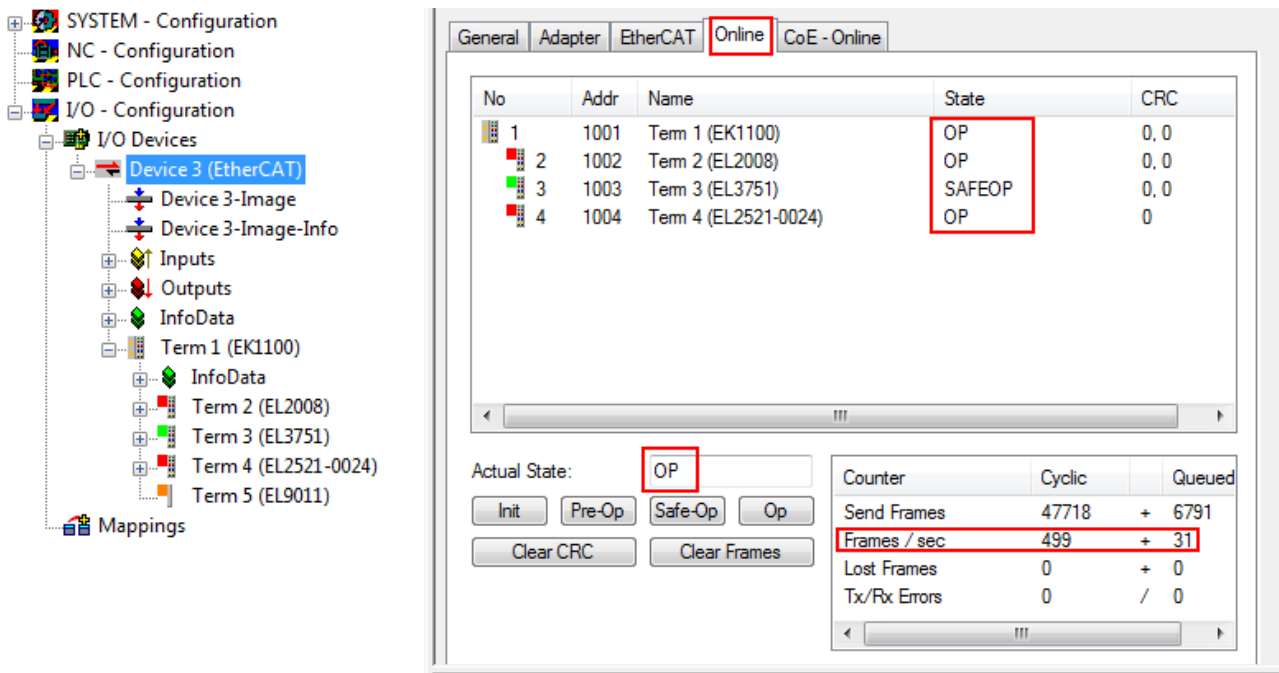

Fig. 123: Online display example

Please note:

- all slaves should be in OP state
- the EtherCAT master should be in “Actual State” OP
- “frames/sec” should match the cycle time taking into account the sent number of frames
- no excessive “LostFrames” or CRC errors should occur

The configuration is now complete. It can be modified as described under [manual procedure \[► 117\]](#).

### Troubleshooting

Various effects may occur during scanning.

- An **unknown device** is detected, i.e. an EtherCAT slave for which no ESI XML description is available. In this case the System Manager offers to read any ESI that may be stored in the device. This case is described in the chapter “Notes regarding ESI device description”.
- **Device are not detected properly**  
Possible reasons include:
  - faulty data links, resulting in data loss during the scan
  - slave has invalid device description

The connections and devices should be checked in a targeted manner, e.g. via the emergency scan. Then re-run the scan.

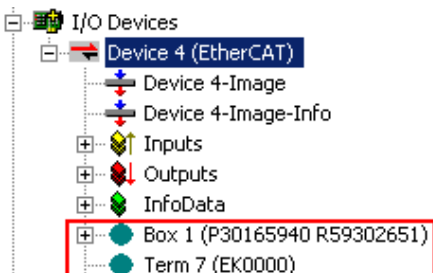

Fig. 124: Faulty identification

In the System Manager such devices may be set up as EK0000 or unknown devices. Operation is not possible or meaningful.

Scan over existing Configuration

**NOTICE**

**Change of the configuration after comparison**

With this scan (TwinCAT 2.11 or 3.1) only the device properties vendor (manufacturer), device name and revision are compared at present! A “ChangeTo” or “Copy” should only be carried out with care, taking into consideration the Beckhoff IO compatibility rule (see above). The device configuration is then replaced by the revision found; this can affect the supported process data and functions.

If a scan is initiated for an existing configuration, the actual I/O environment may match the configuration exactly or it may differ. This enables the configuration to be compared.



Fig. 125: Identical configuration (left: TwinCAT 2; right: TwinCAT 3)

If differences are detected, they are shown in the correction dialog, so that the user can modify the configuration as required.

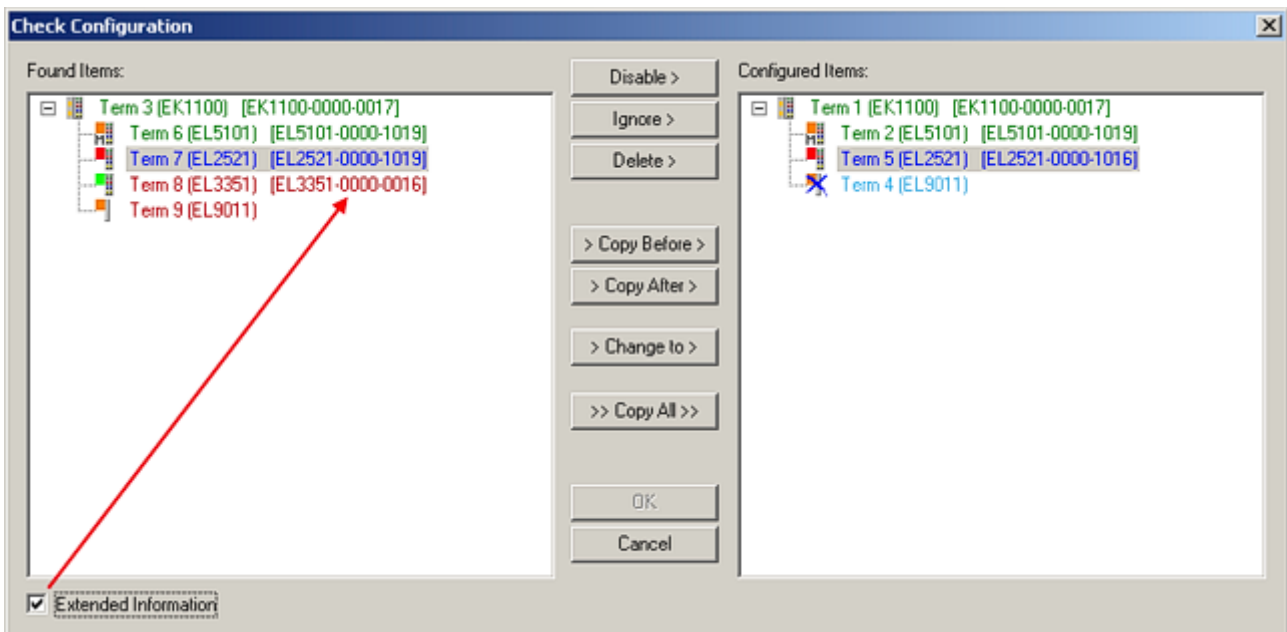

Fig. 126: Correction dialog

It is advisable to tick the “Extended Information” check box to reveal differences in the revision.

Color	Explanation
green	This EtherCAT slave matches the entry on the other side. Both type and revision match.
blue	This EtherCAT slave is present on the other side, but in a different revision. This other revision can have other default values for the process data as well as other/additional functions. If the found revision is higher than the configured revision, the slave may be used provided compatibility issues are taken into account.  If the found revision is lower than the configured revision, it is likely that the slave cannot be used. The found device may not support all functions that the master expects based on the higher revision number.
light blue	This EtherCAT slave is ignored ("Ignore" button)
red	<ul style="list-style-type: none"> <li>This EtherCAT slave is not present on the other side.</li> <li>It is present, but in a different revision, which also differs in its properties from the one specified. The compatibility principle then also applies here: if the found revision is higher than the configured revision, use is possible provided compatibility issues are taken into account, since the successor devices should support the functions of the predecessor devices. If the found revision is lower than the configured revision, it is likely that the slave cannot be used. The found device may not support all functions that the master expects based on the higher revision number.</li> </ul>

### **i** Device selection based on revision, compatibility

The ESI description also defines the process image, the communication type between master and slave/device and the device functions, if applicable. The physical device (firmware, if available) has to support the communication queries/settings of the master. This is backward compatible, i.e. newer devices (higher revision) should be supported if the EtherCAT master addresses them as an older revision. The following compatibility rule of thumb is to be assumed for Beckhoff EtherCAT Terminals/ Boxes/ EJ-modules:

#### **device revision in the system >= device revision in the configuration**

This also enables subsequent replacement of devices without changing the configuration (different specifications are possible for drives).

### Example

If an EL2521-0025-**1018** is specified in the configuration, an EL2521-0025-**1018** or higher (**-1019**, **-1020**) can be used in practice.

Name  
(EL2521-0025-1018)  
Revision

Fig. 127: Name/revision of the terminal

If current ESI descriptions are available in the TwinCAT system, the last revision offered in the selection dialog matches the Beckhoff state of production. It is recommended to use the last device revision when creating a new configuration, if current Beckhoff devices are used in the real application. Older revisions should only be used if older devices from stock are to be used in the application.

In this case the process image of the device is shown in the configuration tree and can be parameterized as follows: linking with the task, CoE/DC settings, plug-in definition, startup settings, ...



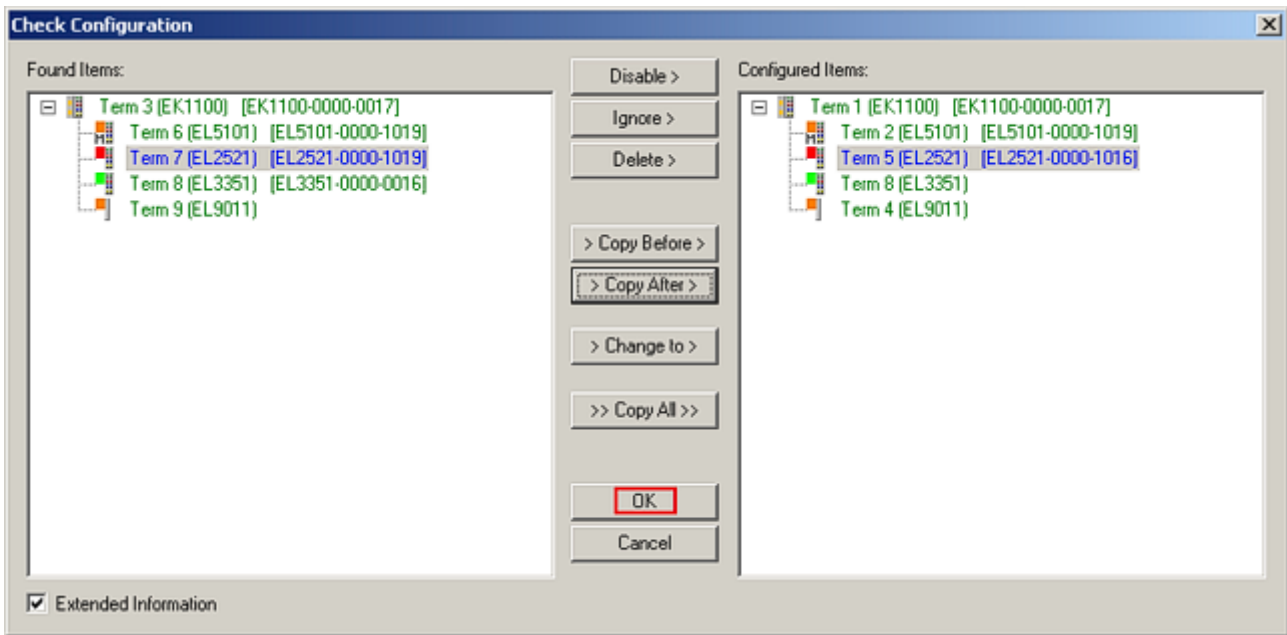

Fig. 128: Correction dialog with modifications

Once all modifications have been saved or accepted, click “OK” to transfer them to the real \*.tsm configuration.

### Change to Compatible Type

TwinCAT offers a function *Change to Compatible Type...* for the exchange of a device whilst retaining the links in the task.

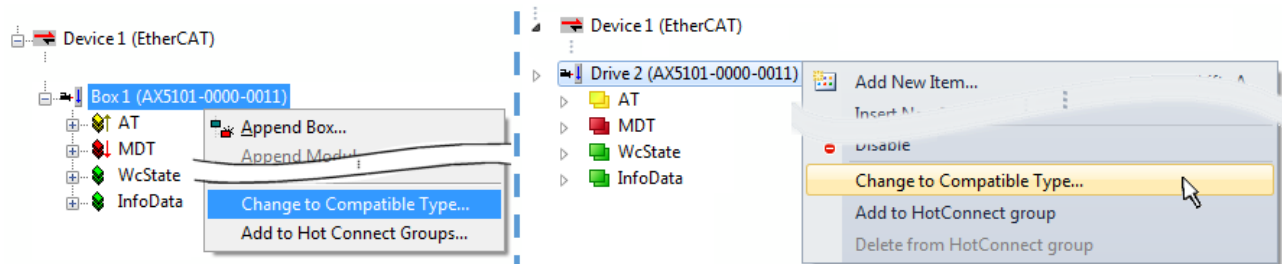

Fig. 129: Dialog “Change to Compatible Type...” (left: TwinCAT 2; right: TwinCAT 3)

The following elements in the ESI of an EtherCAT device are compared by TwinCAT and assumed to be the same in order to decide whether a device is indicated as "compatible":

- Physics (e.g. RJ45, Ebus...)
- FMMU (additional ones are allowed)
- SyncManager (SM, additional ones are allowed)
- EoE (attributes MAC, IP)
- CoE (attributes SdoInfo, PdoAssign, PdoConfig, PdoUpload, CompleteAccess)
- FoE
- PDO (process data: Sequence, SyncUnit SU, SyncManager SM, EntryCount, Entry.Datatype)

This function is preferably to be used on AX5000 devices.

### Change to Alternative Type

The TwinCAT System Manager offers a function for the exchange of a device: Change to Alternative Type

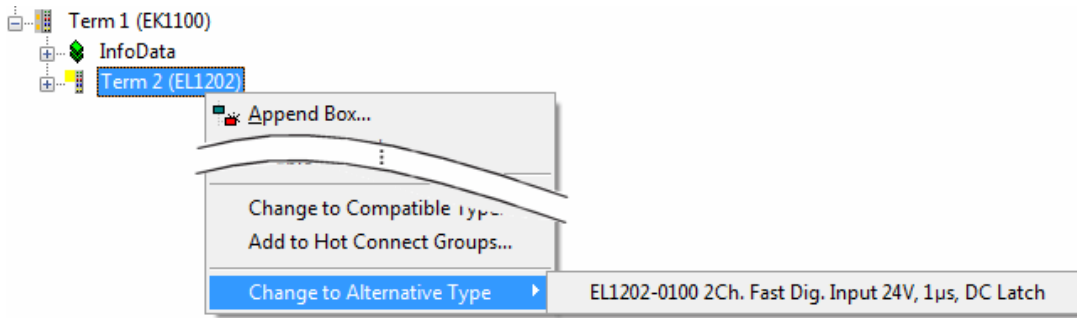

Fig. 130: TwinCAT 2 Dialog Change to Alternative Type

If called, the System Manager searches in the procured device ESI (in this example: EL1202-0000) for details of compatible devices contained there. The configuration is changed and the ESI-EEPROM is overwritten at the same time – therefore this process is possible only in the online state (ConfigMode).

### 6.2.7 EtherCAT subscriber configuration

In the left-hand window of the TwinCAT 2 System Manager or the Solution Explorer of the TwinCAT 3 Development Environment respectively, click on the element of the terminal within the tree you wish to configure (in the example: EL3751 Terminal 3).

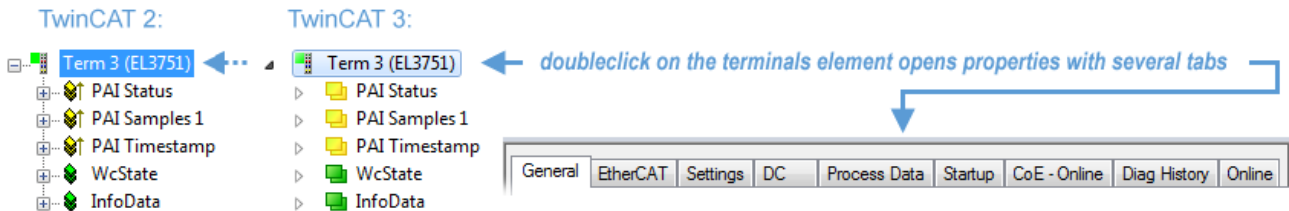

Fig. 131: Branch element as terminal EL3751

In the right-hand window of the TwinCAT System Manager (TwinCAT 2) or the Development Environment (TwinCAT 3), various tabs are now available for configuring the terminal. And yet the dimension of complexity of a subscriber determines which tabs are provided. Thus as illustrated in the example above the terminal EL3751 provides many setup options and also a respective number of tabs are available. On the contrary by the terminal EL1004 for example the tabs “General”, “EtherCAT”, “Process Data” and “Online” are available only. Several terminals, as for instance the EL6695 provide special functions by a tab with its own terminal name, so “EL6695” in this case. A specific tab “Settings” by terminals with a wide range of setup options will be provided also (e.g. EL3751).

#### “General” tab

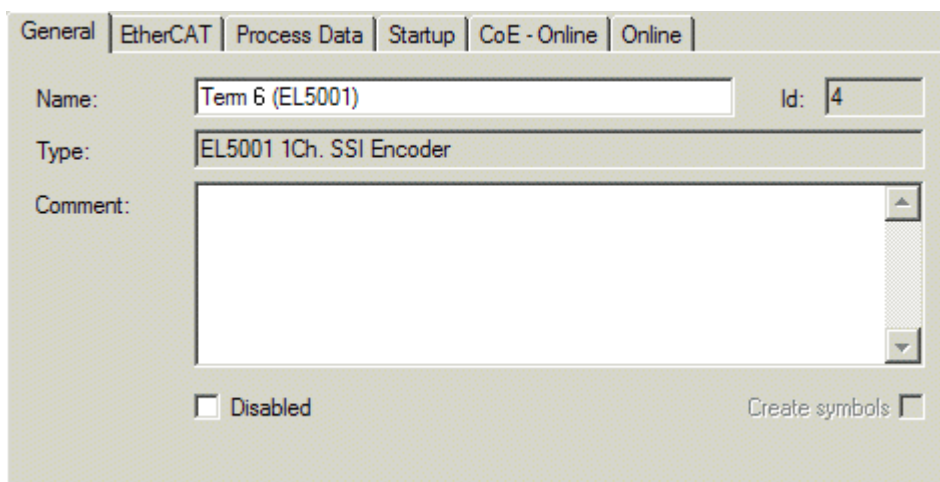

Fig. 132: “General” tab

<b>Name</b>	Name of the EtherCAT device
<b>Id</b>	Number of the EtherCAT device
<b>Type</b>	EtherCAT device type
<b>Comment</b>	Here you can add a comment (e.g. regarding the system).
<b>Disabled</b>	Here you can deactivate the EtherCAT device.
<b>Create symbols</b>	Access to this EtherCAT slave via ADS is only available if this control box is activated.

**“EtherCAT” tab**

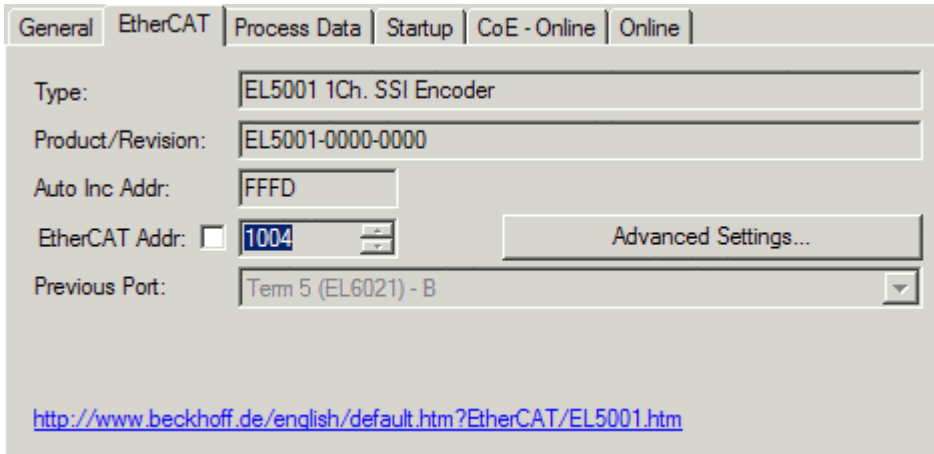

Fig. 133: “EtherCAT” tab

<b>Type</b>	EtherCAT device type
<b>Product/Revision</b>	Product and revision number of the EtherCAT device
<b>Auto Inc Addr.</b>	Auto increment address of the EtherCAT device. The auto increment address can be used for addressing each EtherCAT device in the communication ring through its physical position. Auto increment addressing is used during the start-up phase when the EtherCAT master allocates addresses to the EtherCAT devices. With auto increment addressing the first EtherCAT slave in the ring has the address 0000 <sub>hex</sub> . For each further slave the address is decremented by 1 (FFFF <sub>hex</sub> , FFFE <sub>hex</sub> etc.).
<b>EtherCAT Addr.</b>	Fixed address of an EtherCAT slave. This address is allocated by the EtherCAT master during the start-up phase. Tick the control box to the left of the input field in order to modify the default value.
<b>Previous Port</b>	Name and port of the EtherCAT device to which this device is connected. If it is possible to connect this device with another one without changing the order of the EtherCAT devices in the communication ring, then this combination field is activated and the EtherCAT device to which this device is to be connected can be selected.
<b>Advanced Settings</b>	This button opens the dialogs for advanced settings.

The link at the bottom of the tab points to the product page for this EtherCAT device on the web.

**“Process Data” tab**

Indicates the configuration of the process data. The input and output data of the EtherCAT slave are represented as CANopen process data objects (**Process Data Objects, PDOs**). The user can select a PDO via PDO assignment and modify the content of the individual PDO via this dialog, if the EtherCAT slave supports this function.

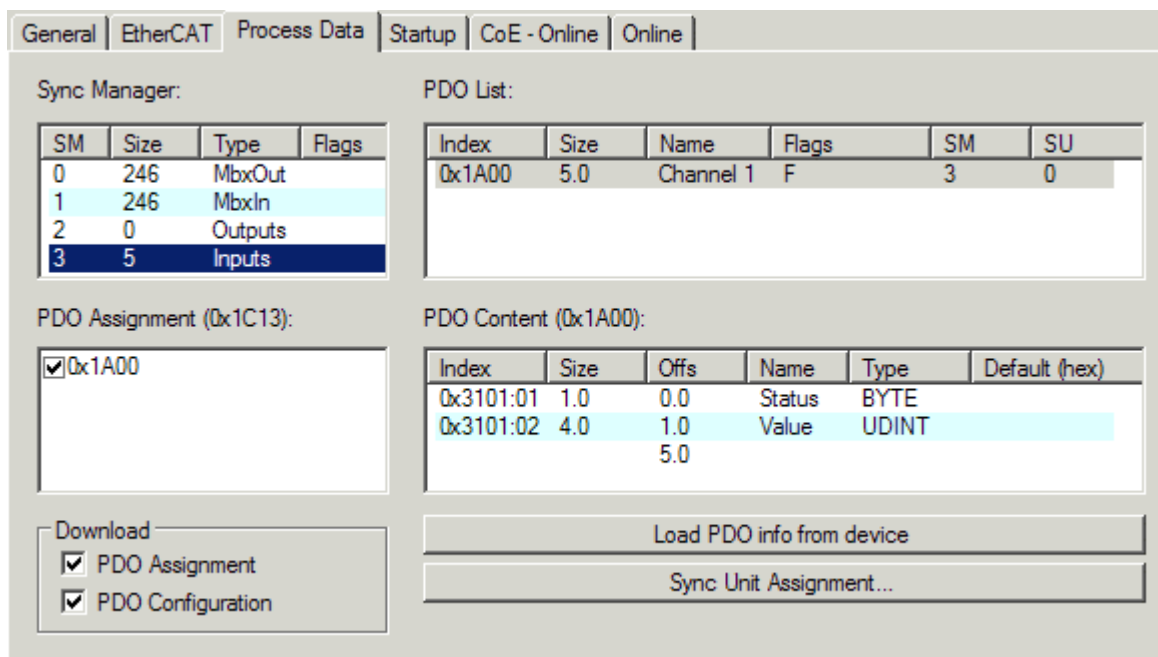

Fig. 134: "Process Data" tab

The process data (PDOs) transferred by an EtherCAT slave during each cycle are user data which the application expects to be updated cyclically or which are sent to the slave. To this end the EtherCAT master (Beckhoff TwinCAT) parameterizes each EtherCAT slave during the start-up phase to define which process data (size in bits/bytes, source location, transmission type) it wants to transfer to or from this slave. Incorrect configuration can prevent successful start-up of the slave.

For Beckhoff EtherCAT EL, ES, EM, EJ and EP slaves the following applies in general:

- The input/output process data supported by the device are defined by the manufacturer in the ESI/XML description. The TwinCAT EtherCAT Master uses the ESI description to configure the slave correctly.
- The process data can be modified in the System Manager. See the device documentation. Examples of modifications include: mask out a channel, displaying additional cyclic information, 16-bit display instead of 8-bit data size, etc.
- In so-called "intelligent" EtherCAT devices the process data information is also stored in the CoE directory. Any changes in the CoE directory that lead to different PDO settings prevent successful startup of the slave. It is not advisable to deviate from the designated process data, because the device firmware (if available) is adapted to these PDO combinations.

If the device documentation allows modification of process data, proceed as follows (see Figure *Configuring the process data*).

- A: select the device to configure
- B: in the "Process Data" tab select Input or Output under SyncManager (C)
- D: the PDOs can be selected or deselected
- H: the new process data are visible as linkable variables in the System Manager  
The new process data are active once the configuration has been activated and TwinCAT has been restarted (or the EtherCAT master has been restarted)
- E: if a slave supports this, Input and Output PDO can be modified simultaneously by selecting a so-called PDO record ("predefined PDO settings").

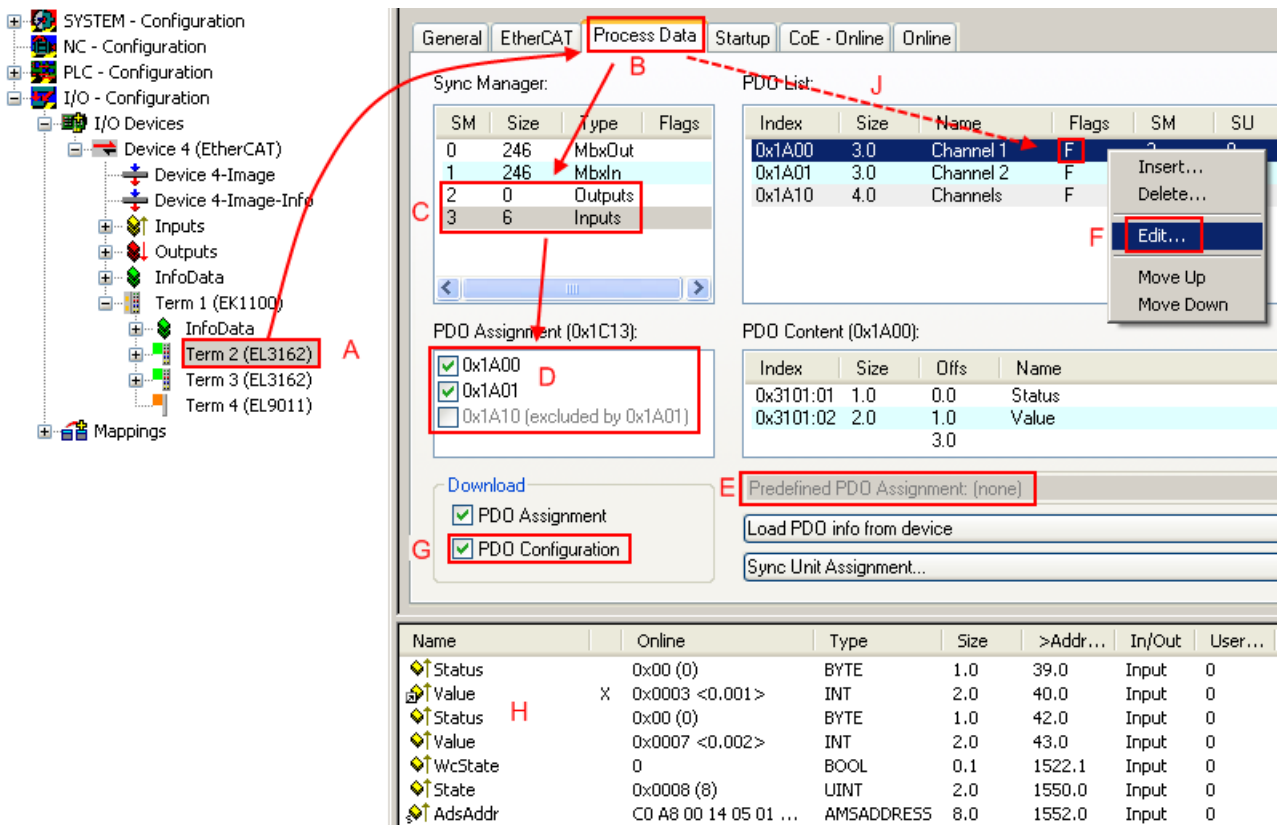

Fig. 135: Configuring the process data

**i Manual modification of the process data**

According to the ESI description, a PDO can be identified as “fixed” with the flag “F” in the PDO overview (Fig. *Configuring the process data*, J). The configuration of such PDOs cannot be changed, even if TwinCAT offers the associated dialog (“Edit”). In particular, CoE content cannot be displayed as cyclic process data. This generally also applies in cases where a device supports download of the PDO configuration, “G”. In case of incorrect configuration the EtherCAT slave usually refuses to start and change to OP state. The System Manager displays an “invalid SM cfg” logger message: This error message (“invalid SM IN cfg” or “invalid SM OUT cfg”) also indicates the reason for the failed start.

A detailed description [► 138] can be found at the end of this section.

**“Startup” tab**

The *Startup* tab is displayed if the EtherCAT slave has a mailbox and supports the *CANopen over EtherCAT* (CoE) or *Servo drive over EtherCAT* protocol. This tab indicates which download requests are sent to the mailbox during startup. It is also possible to add new mailbox requests to the list display. The download requests are sent to the slave in the same order as they are shown in the list.

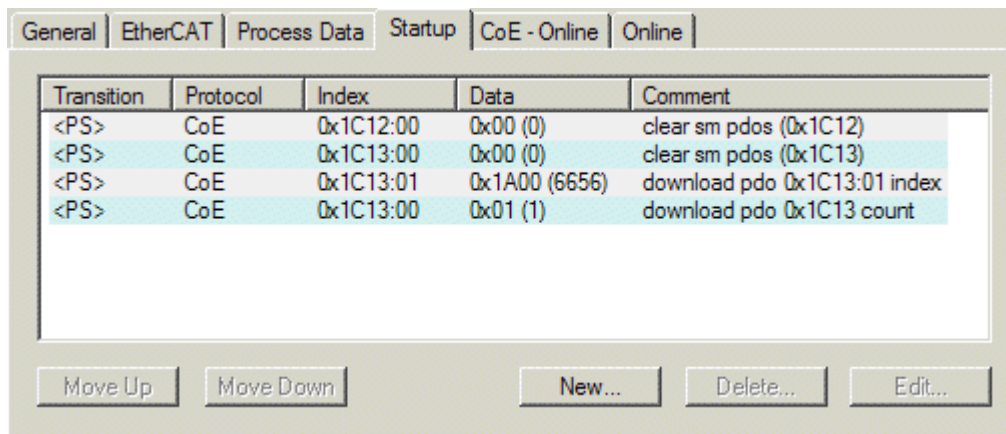

Fig. 136: "Startup" tab

Column	Description
Transition	Transition to which the request is sent. This can either be <ul style="list-style-type: none"> <li>the transition from pre-operational to safe-operational (PS), or</li> <li>the transition from safe-operational to operational (SO).</li> </ul> If the transition is enclosed in "<>" (e.g. <PS>), the mailbox request is fixed and cannot be modified or deleted by the user.
Protocol	Type of mailbox protocol
Index	Index of the object
Data	Date on which this object is to be downloaded.
Comment	Description of the request to be sent to the mailbox

- Move Up** This button moves the selected request up by one position in the list.
- Move Down** This button moves the selected request down by one position in the list.
- New** This button adds a new mailbox download request to be sent during startup.
- Delete** This button deletes the selected entry.
- Edit** This button edits an existing request.

#### "CoE - Online" tab

The additional *CoE - Online* tab is displayed if the EtherCAT slave supports the *CANopen over EtherCAT* (CoE) protocol. This dialog lists the content of the object list of the slave (SDO upload) and enables the user to modify the content of an object from this list. Details for the objects of the individual EtherCAT devices can be found in the device-specific object descriptions.

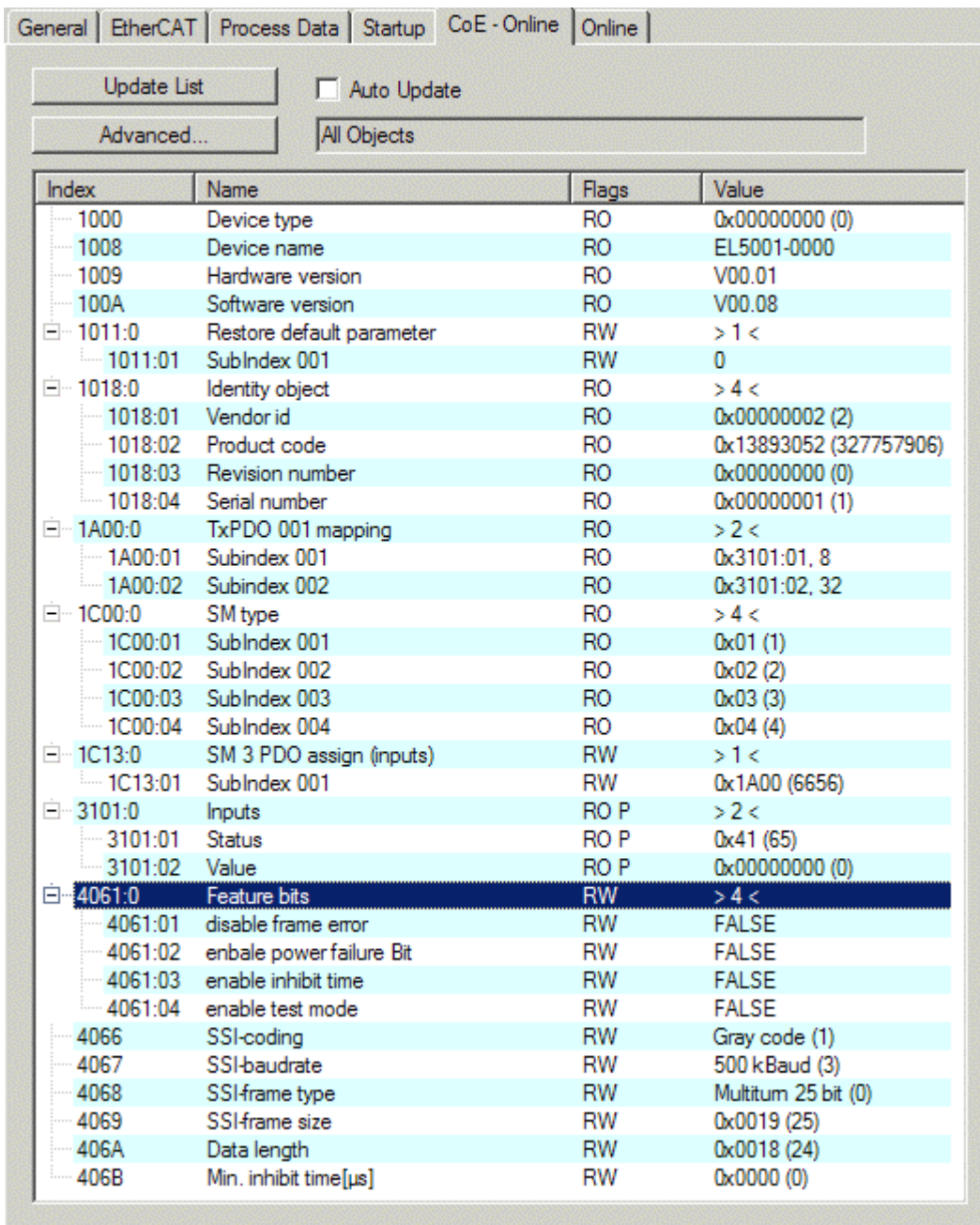

Fig. 137: "CoE - Online" tab

**Object list display**

Column	Description
Index	Index and sub-index of the object
Name	Name of the object
Flags	RW The object can be read, and data can be written to the object (read/write)
	RO The object can be read, but no data can be written to the object (read only)
	P An additional P identifies the object as a process data object.
Value	Value of the object

- Update List** The *Update list* button updates all objects in the displayed list
- Auto Update** If this check box is selected, the content of the objects is updated automatically.
- Advanced** The *Advanced* button opens the *Advanced Settings* dialog. Here you can specify which objects are displayed in the list.

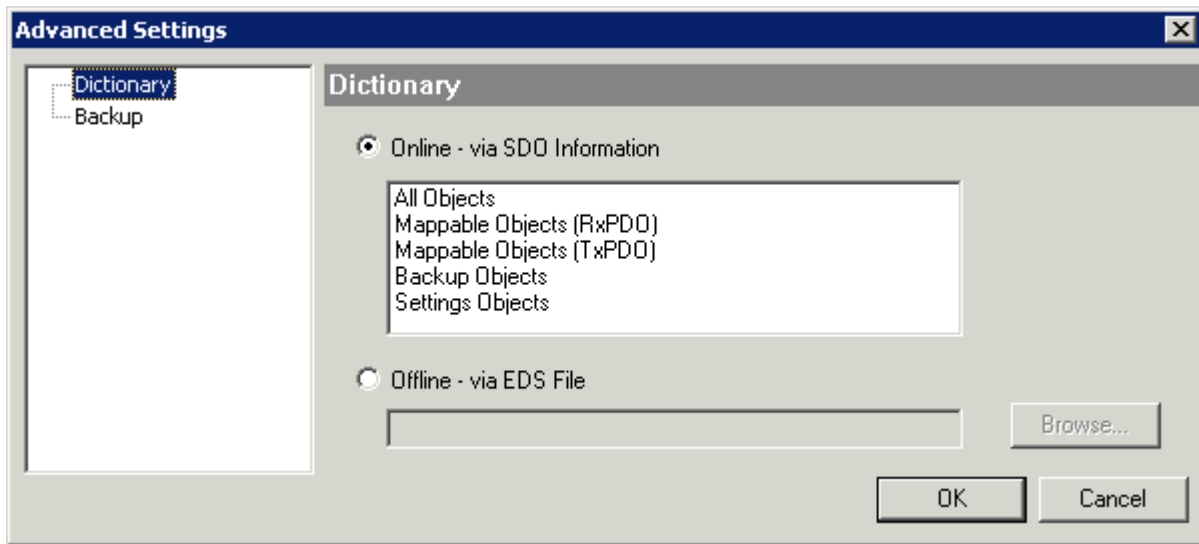

Fig. 138: Dialog “Advanced settings”

**Online - via SDO Information** If this option button is selected, the list of the objects included in the object list of the slave is uploaded from the slave via SDO information. The list below can be used to specify which object types are to be uploaded.

**Offline - via EDS File** If this option button is selected, the list of the objects included in the object list is read from an EDS file provided by the user.

“Online” tab

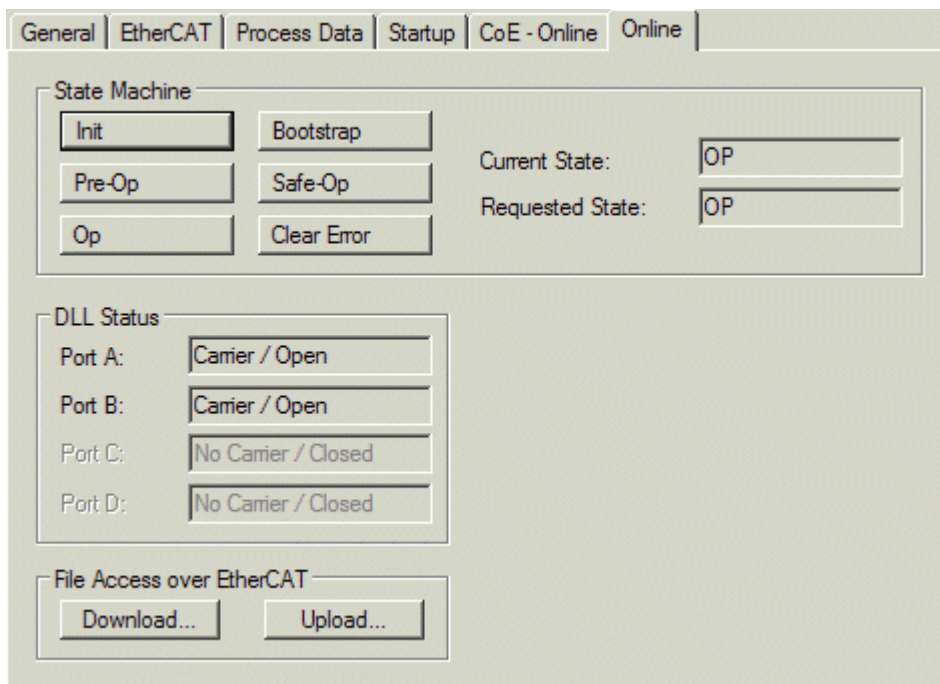

Fig. 139: “Online” tab



**State Machine**

- Init** This button attempts to set the EtherCAT device to the *Init* state.
- Pre-Op** This button attempts to set the EtherCAT device to the *pre-operational* state.
- Op** This button attempts to set the EtherCAT device to the *operational* state.
- Bootstrap** This button attempts to set the EtherCAT device to the *Bootstrap* state.
- Safe-Op** This button attempts to set the EtherCAT device to the *safe-operational* state.
- Clear Error** This button attempts to delete the fault display. If an EtherCAT slave fails during change of state it sets an error flag.  
  
Example: An EtherCAT slave is in PREOP state (pre-operational). The master now requests the SAFEOP state (safe-operational). If the slave fails during change of state it sets the error flag. The current state is now displayed as ERR PREOP. When the *Clear Error* button is pressed the error flag is cleared, and the current state is displayed as PREOP again.
- Current State** Indicates the current state of the EtherCAT device.
- Requested State** Indicates the state requested for the EtherCAT device.

**DLL Status**

Indicates the DLL status (data link layer status) of the individual ports of the EtherCAT slave. The DLL status can have four different states:

Status	Description
No Carrier / Open	No carrier signal is available at the port, but the port is open.
No Carrier / Closed	No carrier signal is available at the port, and the port is closed.
Carrier / Open	A carrier signal is available at the port, and the port is open.
Carrier / Closed	A carrier signal is available at the port, but the port is closed.

**File Access over EtherCAT**

- Download** With this button a file can be written to the EtherCAT device.
- Upload** With this button a file can be read from the EtherCAT device.

**“DC” tab (Distributed Clocks)**

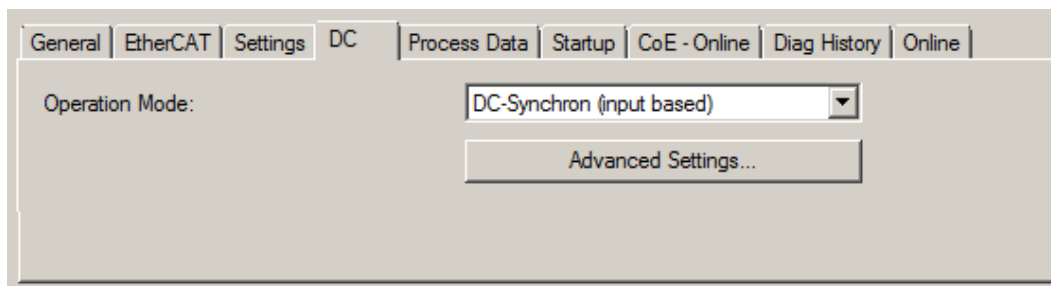

Fig. 140: “DC” tab (Distributed Clocks)

- Operation Mode** Options (optional):
  - FreeRun
  - SM-Synchron
  - DC-Synchron (Input based)
  - DC-Synchron
- Advanced Settings...** Advanced settings for readjustment of the real time determinant TwinCAT-clock

Detailed information to Distributed Clocks is specified on <http://infosys.beckhoff.com>:

**Fieldbus Components** → EtherCAT Terminals → EtherCAT System documentation → EtherCAT basics → Distributed Clocks

## 6.2.7.1 Detailed description of Process Data tab

### Sync Manager

Lists the configuration of the Sync Manager (SM).

If the EtherCAT device has a mailbox, SM0 is used for the mailbox output (MbxOut) and SM1 for the mailbox input (MbxIn).

SM2 is used for the output process data (outputs) and SM3 (inputs) for the input process data.

If an input is selected, the corresponding PDO assignment is displayed in the *PDO Assignment* list below.

### PDO Assignment

PDO assignment of the selected Sync Manager. All PDOs defined for this Sync Manager type are listed here:

- If the output Sync Manager (outputs) is selected in the Sync Manager list, all RxPDOs are displayed.
- If the input Sync Manager (inputs) is selected in the Sync Manager list, all TxPDOs are displayed.

The selected entries are the PDOs involved in the process data transfer. In the tree diagram of the System Manager these PDOs are displayed as variables of the EtherCAT device. The name of the variable is identical to the *Name* parameter of the PDO, as displayed in the PDO list. If an entry in the PDO assignment list is deactivated (not selected and greyed out), this indicates that the input is excluded from the PDO assignment. In order to be able to select a greyed out PDO, the currently selected PDO has to be deselected first.

### ● **Activation of PDO assignment**



- ✓ If you have changed the PDO assignment, in order to activate the new PDO assignment,
  - a) the EtherCAT slave has to run through the PS status transition cycle (from pre-operational to safe-operational) once (see [Online tab \[▶ 136\]](#)),
  - b) and the System Manager has to reload the EtherCAT slaves



( button for TwinCAT 2 or



button for TwinCAT 3)

### PDO list

List of all PDOs supported by this EtherCAT device. The content of the selected PDOs is displayed in the *PDO Content* list. The PDO configuration can be modified by double-clicking on an entry.

Column	Description	
Index	PDO index.	
Size	Size of the PDO in bytes.	
Name	Name of the PDO. If this PDO is assigned to a Sync Manager, it appears as a variable of the slave with this parameter as the name.	
Flags	F	Fixed content: The content of this PDO is fixed and cannot be changed by the System Manager.
	M	Mandatory PDO. This PDO is mandatory and must therefore be assigned to a Sync Manager! Consequently, this PDO cannot be deleted from the <i>PDO Assignment</i> list
SM	Sync Manager to which this PDO is assigned. If this entry is empty, this PDO does not take part in the process data traffic.	
SU	Sync unit to which this PDO is assigned.	

### PDO Content

Indicates the content of the PDO. If flag F (fixed content) of the PDO is not set the content can be modified.

**Download**

If the device is intelligent and has a mailbox, the configuration of the PDO and the PDO assignments can be downloaded to the device. This is an optional feature that is not supported by all EtherCAT slaves.

**PDO Assignment**

If this check box is selected, the PDO assignment that is configured in the PDO Assignment list is downloaded to the device on startup. The required commands to be sent to the device can be viewed in the Startup [▶ 133] tab.

**PDO Configuration**

If this check box is selected, the configuration of the respective PDOs (as shown in the PDO list and the PDO Content display) is downloaded to the EtherCAT slave.

**6.2.7.2 Download revision**

**Download revision in Start-up list**

Several terminals / modules generate the entry from object 0xF081:01 in the Start-up list automatically (see fig. "Download revision in Start-up list").

The object 0xF081:01 (Download revision) describes the revision of the terminal / module, e.g. 0x0018000A for EL7201-0010-0024, and is necessary to ensure compatibility.

Please note, that you must not delete this entry from the Start-up list!

Transition	Protocol	Index	Data	Comment
<PS>	CoE	0x1C12 C 0	02 00 00 16 01 16	download pdo 0x1C12 index
<PS>	CoE	0x1C13 C 0	02 00 00 1A 01 1A	download pdo 0x1C13 index
IP	CoE	0xF081:01	0x0018000A (1572874)	

Fig. 141: Download revision in Start-up list

**6.2.8 Import/Export of EtherCAT devices with SCI and XTI**

**SCI and XTI Export/Import – Handling of user-defined modified EtherCAT slaves**

**6.2.8.1 Basic principles**

An EtherCAT slave is basically parameterized through the following elements:

- Cyclic process data (PDO)
- Synchronization (Distributed Clocks, FreeRun, SM-Synchron)
- CoE parameters (acyclic object dictionary)

Note: Not all three elements may be present, depending on the slave.

For a better understanding of the export/import function, let's consider the usual procedure for IO configuration:

- The user/programmer processes the IO configuration in the TwinCAT system environment. This involves all input/output devices such as drives that are connected to the fieldbuses used.  
 Note: In the following sections, only EtherCAT configurations in the TwinCAT system environment are considered.

- For example, the user manually adds devices to a configuration or performs a scan on the online system.
- This results in the IO system configuration.
- On insertion, the slave appears in the system configuration in the default configuration provided by the vendor, consisting of default PDO, default synchronization method and CoE StartUp parameter as defined in the ESI (XML device description).
- If necessary, elements of the slave configuration can be changed, e.g. the PDO configuration or the synchronization method, based on the respective device documentation.

It may become necessary to reuse the modified slave in other projects in this way, without having to make equivalent configuration changes to the slave again. To accomplish this, proceed as follows:

- Export the slave configuration from the project,
- Store and transport as a file,
- Import into another EtherCAT project.

TwinCAT offers two methods for this purpose:

- within the TwinCAT environment: Export/Import as **x**ti file or
- outside, i.e. beyond the TwinCAT limits: Export/Import as **s**ci file.

An example is provided below for illustration purposes: an EL3702 terminal with standard setting is switched to 2-fold oversampling (blue) and the optional PDO "StartTimeNextLatch" is added (red):

The screenshot displays the TwinCAT configuration interface for a project named 'TwinCAT Project34'. The 'Process Data' tab is selected, showing the 'DC/Oversampling' parameter set to 2.0. The 'PDO List' table is as follows:

Index	Size	Name
0x1B00	2.0	Ch1 CycleCount
0x1A00	2.0	Ch1 Sample 0
0x1A01	2.0	Ch1 Sample 1
0x1A02	2.0	Ch1 Sample 2
0x1A03	2.0	Ch1 Sample 3
0x1A04	2.0	Ch1 Sample 4
0x1A05	2.0	Ch1 Sample 5

The 'PDO Assignment (0x1C12)' table shows the following entries:

Index	Type	Size
<input type="checkbox"/> 0x1AE0	Inputs	6
<input type="checkbox"/> 0x1AE1	Inputs	6
<input type="checkbox"/> 0x1AE2	Inputs	4
<input checked="" type="checkbox"/> 0x1B10	Inputs	4

The 'PDO Content (0x1B00)' table shows the following entry:

Index	Size	Offs	Name
0x6800:01	2.0	0.0	Ch1 CycleCount
	2.0		

The 'Mappings' table at the bottom shows the following entries:

Name	Online	Type	Size	>Addr...
Ch1 CycleCount		UINT	2.0	58.0
Ch1 Value		INT	2.0	60.0
Ch1 Value		INT	2.0	62.0
Ch2 CycleCount		UINT	2.0	64.0
Ch2 Value		INT	2.0	66.0
Ch2 Value		INT	2.0	68.0
StartTimeNextLa...		UDINT	4.0	70.0
WcState		BIT	0.1	1522.2

The two methods for exporting and importing the modified terminal referred to above are demonstrated below.

### 6.2.8.2 Procedure within TwinCAT with xti files

Each IO device can be exported/saved individually:

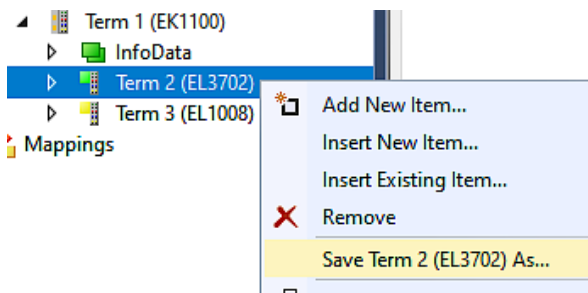

The xti file can be stored:

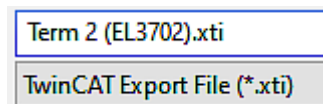

and imported again in another TwinCAT system via "Insert Existing item":

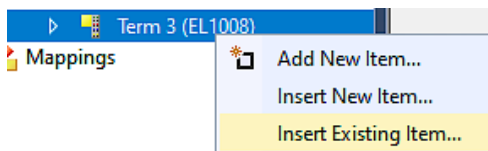

### 6.2.8.3 Procedure within and outside TwinCAT with sci file

*Note regarding availability (2021/01)*

*The SCI method is available from TwinCAT 3.1 build 4024.14.*

The Slave Configuration Information (SCI) describes a specific complete configuration for an EtherCAT slave (terminal, box, drive...) based on the setting options of the device description file (ESI, EtherCAT Slave Information). That is, it includes PDO, CoE, synchronization.

**Export:**

- select a single device via the menu (multiple selection is also possible):  
TwinCAT → EtherCAT Devices → Export SCI.

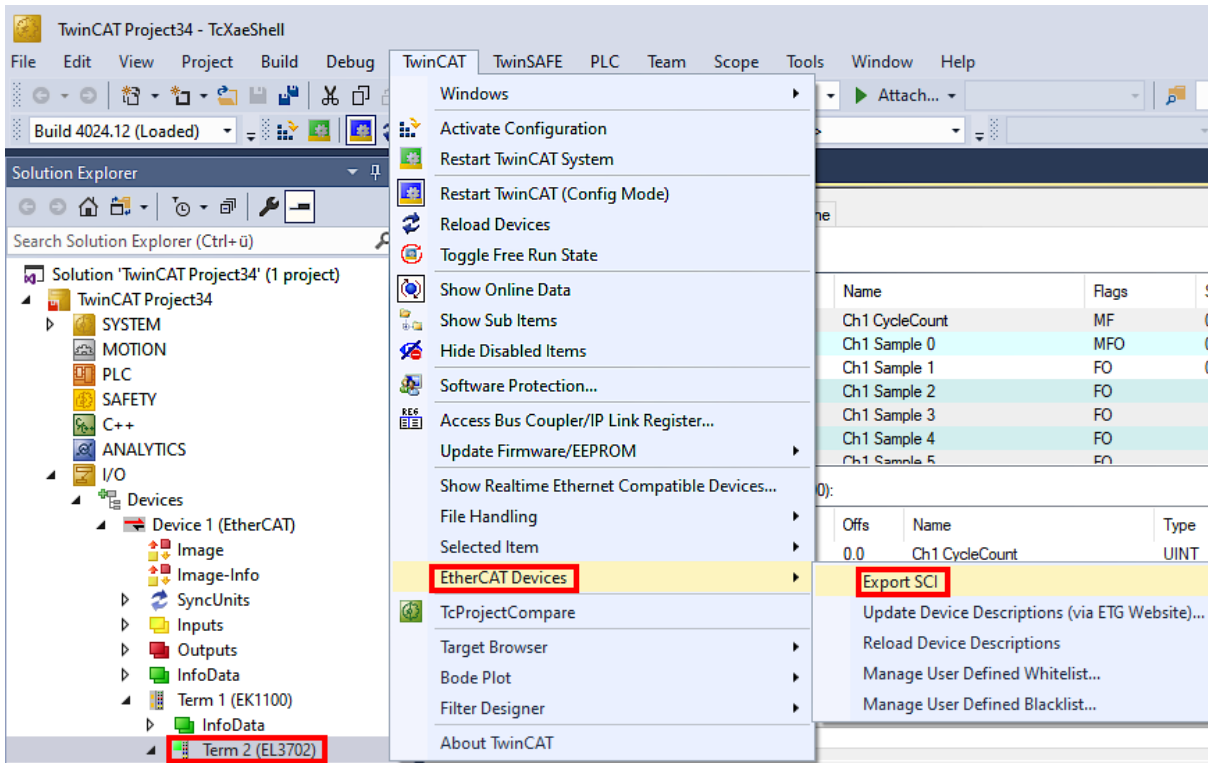

- If TwinCAT is offline (i.e. if there is no connection to an actual running controller) a warning message may appear, because after executing the function the system attempts to reload the EtherCAT segment. However, in this case this is not relevant for the result and can be acknowledged by clicking OK:

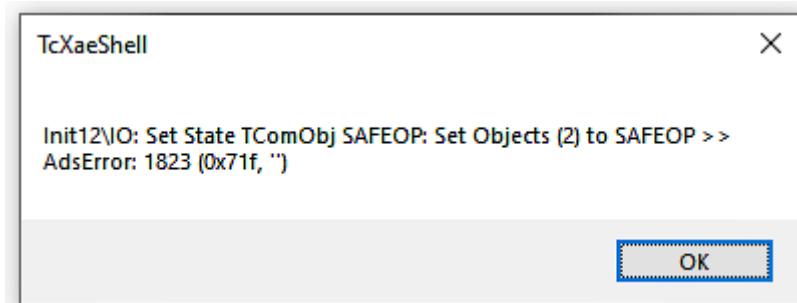

- A description may also be provided:

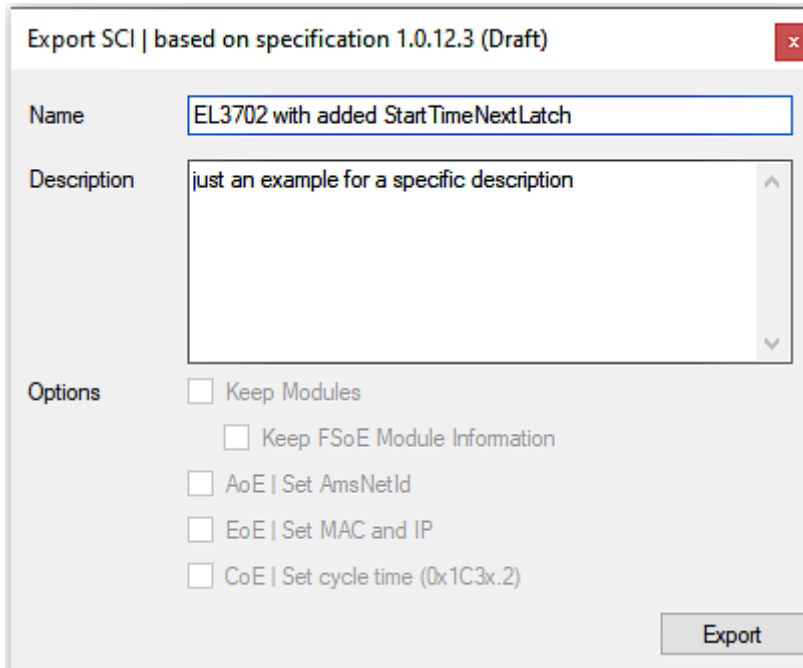

- Explanation of the dialog box:

Name	Name of the SCI, assigned by the user.	
Description	Description of the slave configuration for the use case, assigned by the user.	
Options	Keep modules	If a slave supports modules/slots, the user can decide whether these are to be exported or whether the module and device data are to be combined during export.
	AoE   Set AmsNetId	The configured AmsNetId is exported. Usually this is network-dependent and cannot always be determined in advance.
	EoE   Set MAC and IP	The configured virtual MAC and IP addresses are stored in the SCI. Usually these are network-dependent and cannot always be determined in advance.
	CoE   Set cycle time(0x1C3x.2)	The configured cycle time is exported. Usually this is network-dependent and cannot always be determined in advance.
ESI	Reference to the original ESI file.	
Export	Save SCI file.	

- A list view is available for multiple selections (*Export multiple SCI files*):

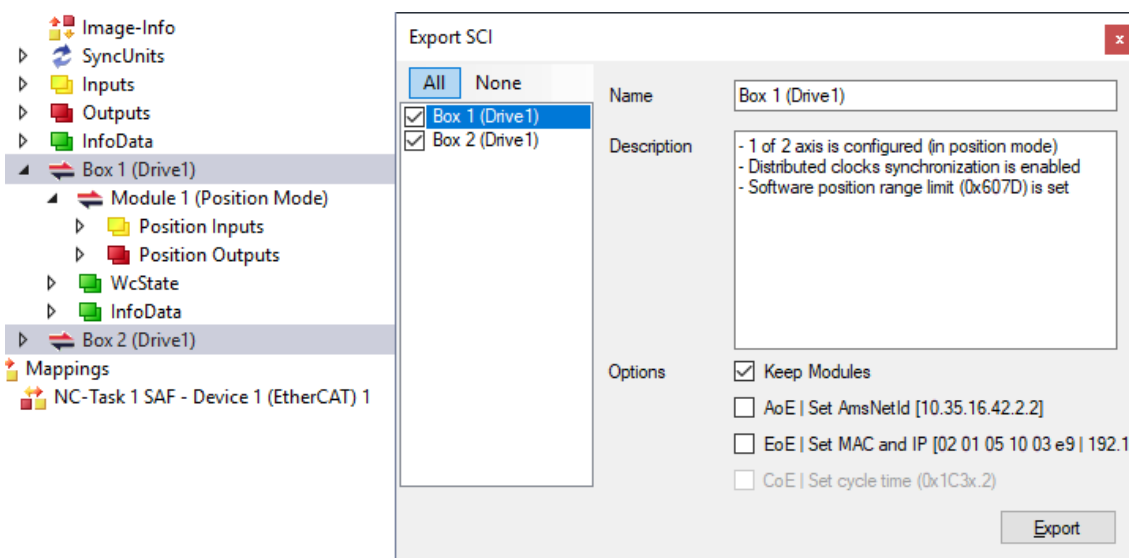

- Selection of the slaves to be exported:
  - All:
    - All slaves are selected for export.

- None:  
All slaves are deselected.
- The sci file can be saved locally:

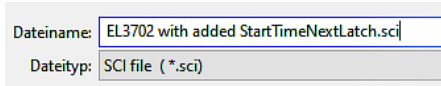

- The export takes place:

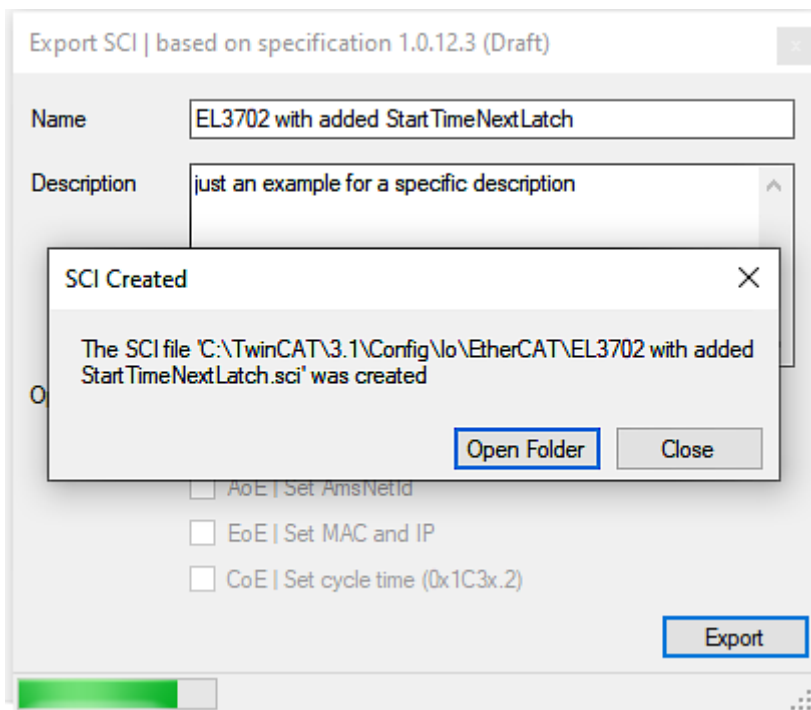

**Import**

- An sci description can be inserted manually into the TwinCAT configuration like any normal Beckhoff device description.
- The sci file must be located in the TwinCAT ESI path, usually under:  
C:\TwinCAT\3.1\Config\Io\EtherCAT

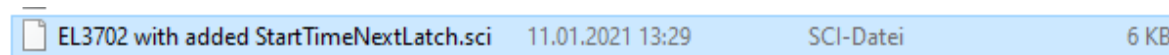

- Open the selection dialog:

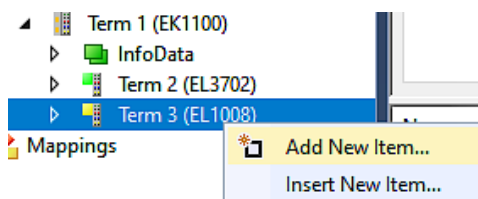



- Display SCI devices and select and insert the desired device:

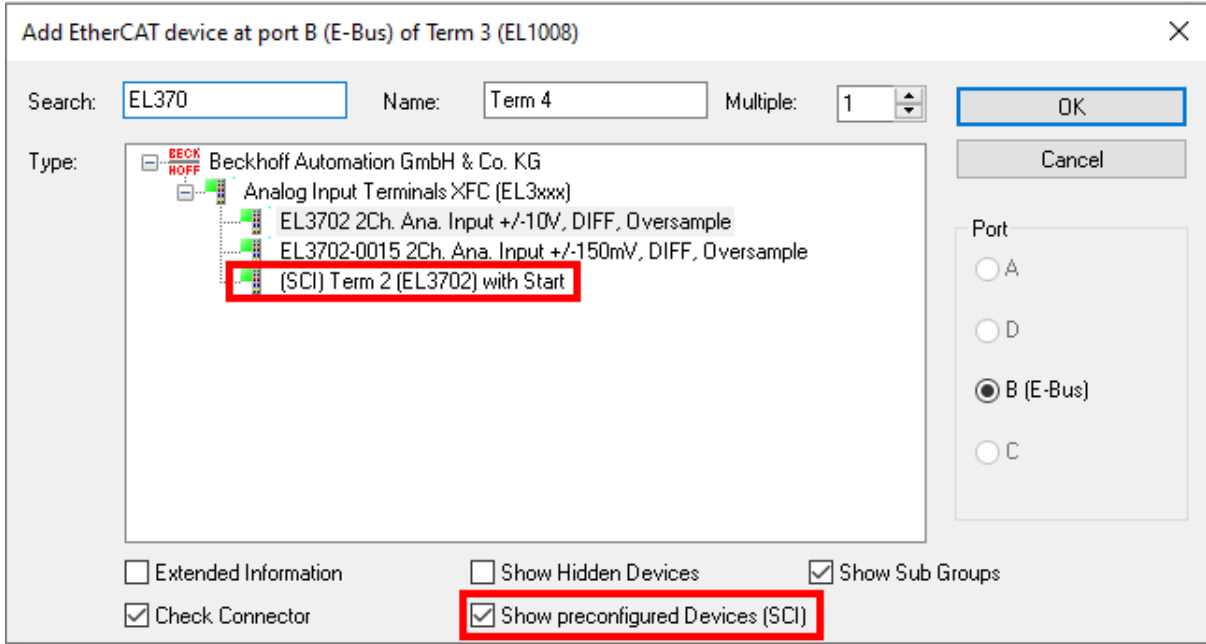

**Additional Notes**

- Settings for the SCI function can be made via the general Options dialog (Tools → Options → TwinCAT → Export SCI):

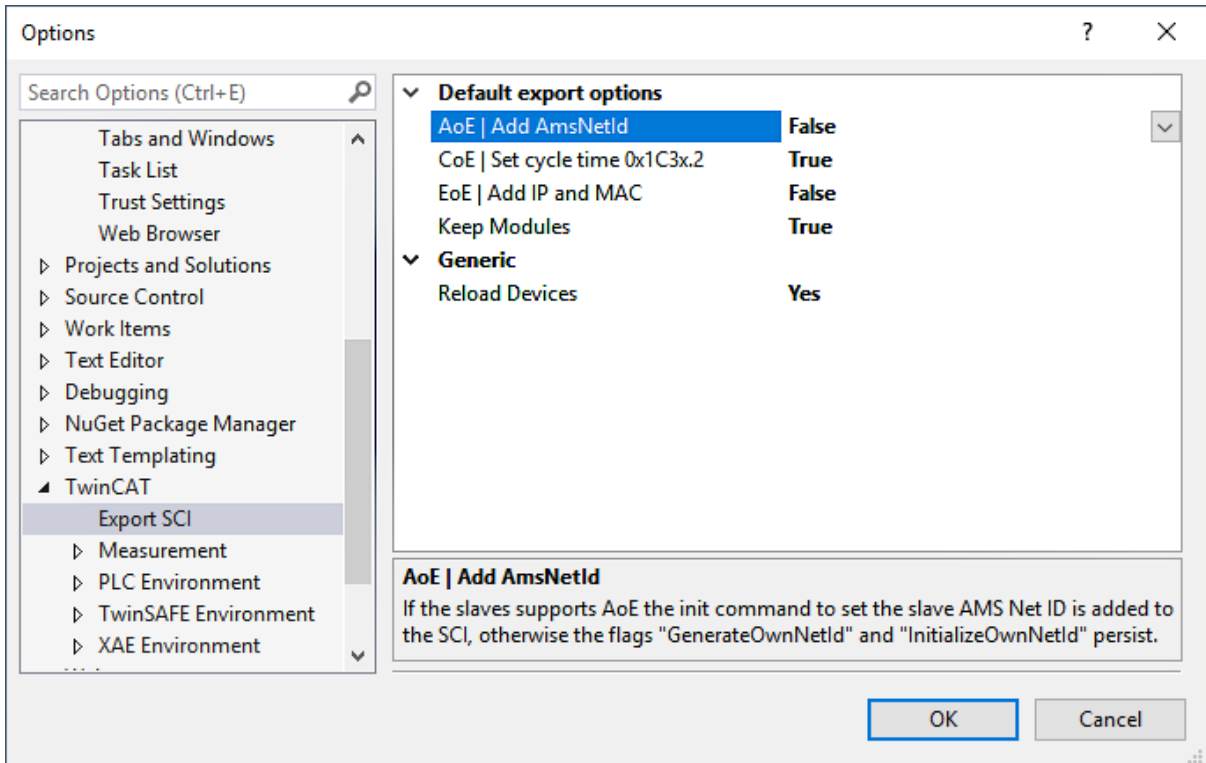

Explanation of the settings:

Default export options	AoE   Set AmsNetId	Default setting whether the configured AmsNetId is exported.
	CoE   Set cycle time(0x1C3x.2)	Default setting whether the configured cycle time is exported.
	EoE   Set MAC and IP	Default setting whether the configured MAC and IP addresses are exported.
	Keep modules	Default setting whether the modules persist.
Generic	Reload Devices	Setting whether the Reload Devices command is executed before the SCI export. This is strongly recommended to ensure a consistent slave configuration.

SCI error messages are displayed in the TwinCAT logger output window if required:

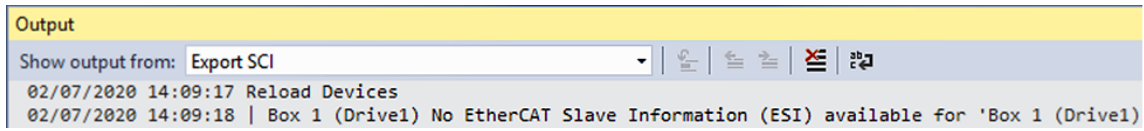

## 6.3 General Commissioning Instructions for an EtherCAT Slave

This summary briefly deals with a number of aspects of EtherCAT Slave operation under TwinCAT. More detailed information on this may be found in the corresponding sections of, for instance, the [EtherCAT System Documentation](#).

### Diagnosis in real time: WorkingCounter, EtherCAT State and Status

Generally speaking an EtherCAT Slave provides a variety of diagnostic information that can be used by the controlling task.

This diagnostic information relates to differing levels of communication. It therefore has a variety of sources, and is also updated at various times.

Any application that relies on I/O data from a fieldbus being correct and up to date must make diagnostic access to the corresponding underlying layers. EtherCAT and the TwinCAT System Manager offer comprehensive diagnostic elements of this kind. Those diagnostic elements that are helpful to the controlling task for diagnosis that is accurate for the current cycle when in operation (not during commissioning) are discussed below.

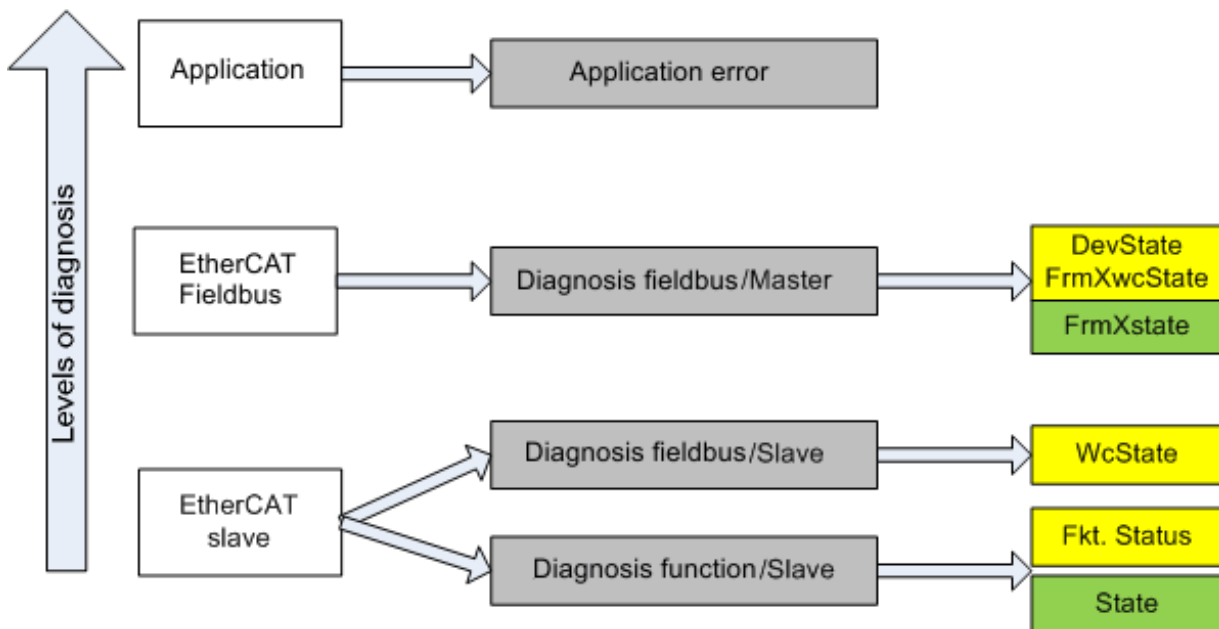

Fig. 142: Selection of the diagnostic information of an EtherCAT Slave

In general, an EtherCAT Slave offers

- communication diagnosis typical for a slave (diagnosis of successful participation in the exchange of process data, and correct operating mode)  
This diagnosis is the same for all slaves.

as well as

- function diagnosis typical for a channel (device-dependent)  
See the corresponding device documentation

The colors in Fig. *Selection of the diagnostic information of an EtherCAT Slave* also correspond to the variable colors in the System Manager, see Fig. *Basic EtherCAT Slave Diagnosis in the PLC*.

Colour	Meaning
yellow	Input variables from the Slave to the EtherCAT Master, updated in every cycle
red	Output variables from the Slave to the EtherCAT Master, updated in every cycle
green	Information variables for the EtherCAT Master that are updated acyclically. This means that it is possible that in any particular cycle they do not represent the latest possible status. It is therefore useful to read such variables through ADS.

Fig. Basic EtherCAT Slave Diagnosis in the PLC shows an example of an implementation of basic EtherCAT Slave Diagnosis. A Beckhoff EL3102 (2-channel analogue input terminal) is used here, as it offers both the communication diagnosis typical of a slave and the functional diagnosis that is specific to a channel. Structures are created as input variables in the PLC, each corresponding to the process image.

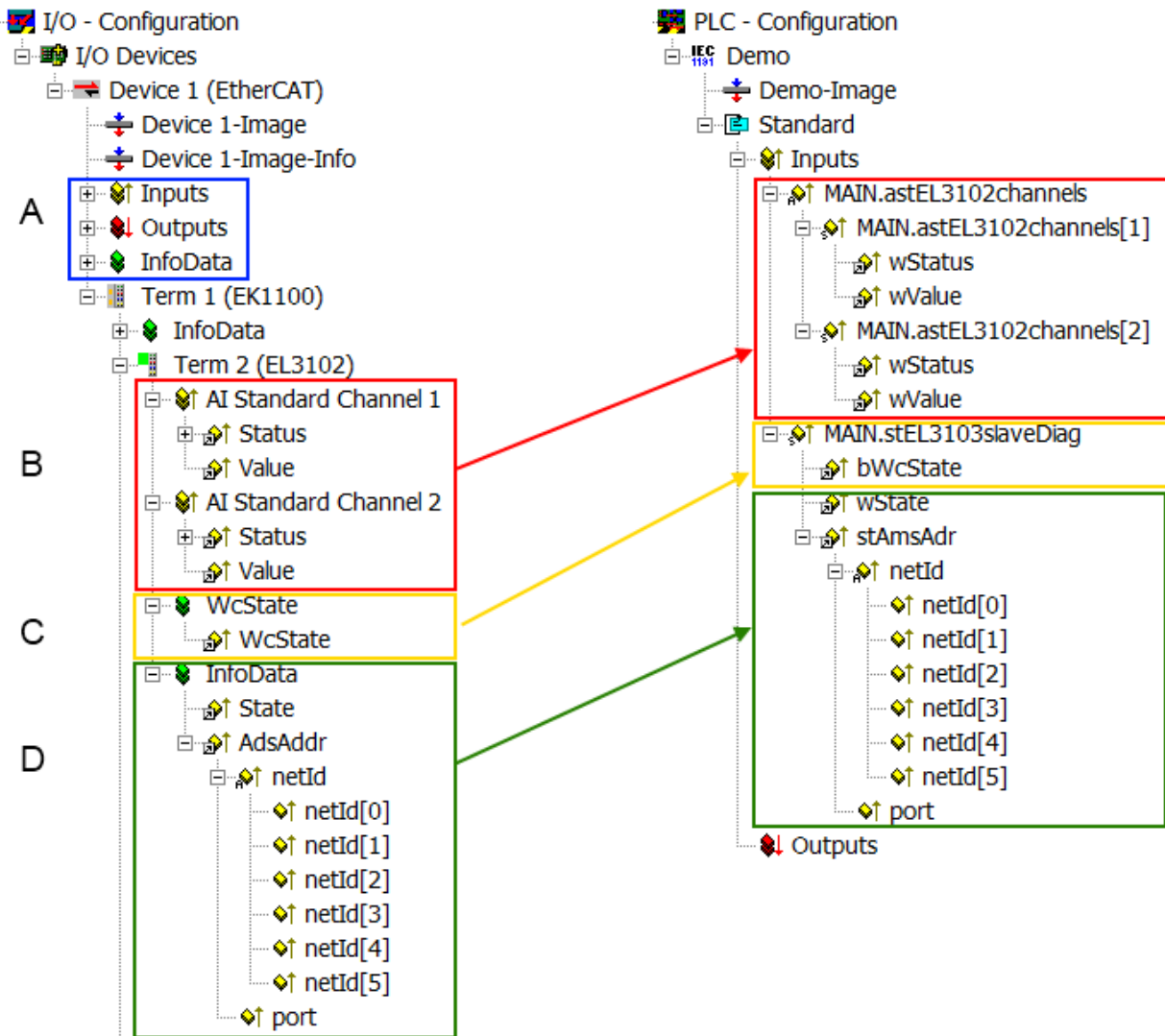

Fig. 143: Basic EtherCAT Slave Diagnosis in the PLC

The following aspects are covered here:

Code	Function	Implementation	Application/evaluation
A	The EtherCAT Master's diagnostic information updated acyclically (yellow) or provided acyclically (green).		At least the DevState is to be evaluated for the most recent cycle in the PLC. The EtherCAT Master's diagnostic information offers many more possibilities than are treated in the EtherCAT System Documentation. A few keywords: <ul style="list-style-type: none"> <li>• CoE in the Master for communication with/through the Slaves</li> <li>• Functions from <i>TcEtherCAT.lib</i></li> <li>• Perform an OnlineScan</li> </ul>
B	In the example chosen (EL3102) the EL3102 comprises two analogue input channels that transmit a single function status for the most recent cycle.	Status <ul style="list-style-type: none"> <li>• the bit significations may be found in the device documentation</li> <li>• other devices may supply more information, or none that is typical of a slave</li> </ul>	In order for the higher-level PLC task (or corresponding control applications) to be able to rely on correct data, the function status must be evaluated there. Such information is therefore provided with the process data for the most recent cycle.
C	For every EtherCAT Slave that has cyclic process data, the Master displays, using what is known as a WorkingCounter, whether the slave is participating successfully and without error in the cyclic exchange of process data. This important, elementary information is therefore provided for the most recent cycle in the System Manager <ol style="list-style-type: none"> <li>1. at the EtherCAT Slave, and, with identical contents</li> <li>2. as a collective variable at the EtherCAT Master (see Point A) for linking.</li> </ol>	WcState (Working Counter) 0: valid real-time communication in the last cycle 1: invalid real-time communication This may possibly have effects on the process data of other Slaves that are located in the same SyncUnit	In order for the higher-level PLC task (or corresponding control applications) to be able to rely on correct data, the communication status of the EtherCAT Slave must be evaluated there. Such information is therefore provided with the process data for the most recent cycle.
D	Diagnostic information of the EtherCAT Master which, while it is represented at the slave for linking, is actually determined by the Master for the Slave concerned and represented there. This information cannot be characterized as real-time, because it <ul style="list-style-type: none"> <li>• is only rarely/never changed, except when the system starts up</li> <li>• is itself determined acyclically (e.g. EtherCAT Status)</li> </ul>	State current Status (INIT..OP) of the Slave. The Slave must be in OP (=8) when operating normally. <i>AdsAddr</i> The ADS address is useful for communicating from the PLC/task via ADS with the EtherCAT Slave, e.g. for reading/writing to the CoE. The AMS-NetID of a slave corresponds to the AMS-NetID of the EtherCAT Master; communication with the individual Slave is possible via the <i>port</i> (= EtherCAT address).	Information variables for the EtherCAT Master that are updated acyclically. This means that it is possible that in any particular cycle they do not represent the latest possible status. It is therefore possible to read such variables through ADS.

**NOTICE**

**Diagnostic information**

It is strongly recommended that the diagnostic information made available is evaluated so that the application can react accordingly.

**CoE Parameter Directory**

The CoE parameter directory (CanOpen-over-EtherCAT) is used to manage the set values for the slave concerned. Changes may, in some circumstances, have to be made here when commissioning a relatively complex EtherCAT Slave. It can be accessed through the TwinCAT System Manager, see Fig. *EL3102, CoE directory*:

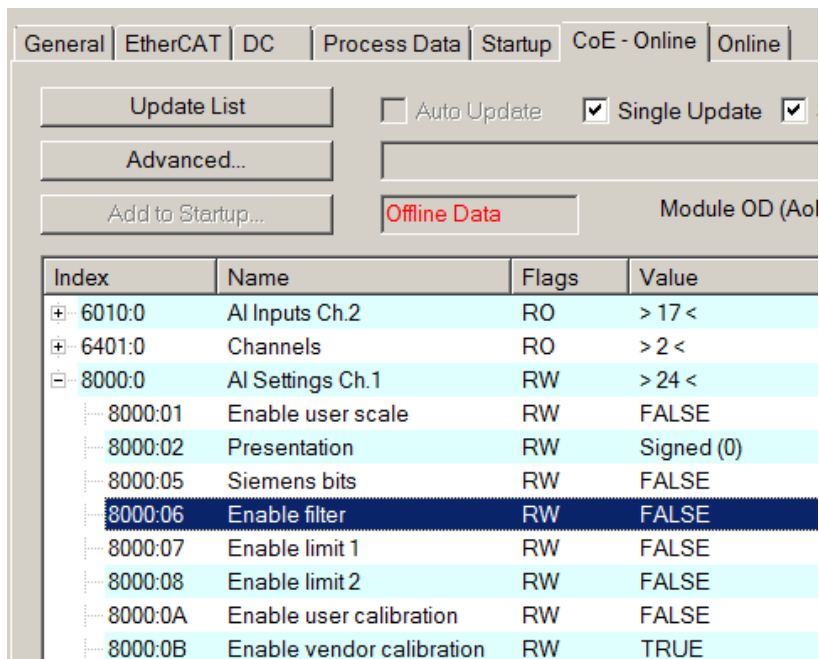

Fig. 144: EL3102, CoE directory

### **i** EtherCAT System Documentation

The comprehensive description in the [EtherCAT System Documentation](#) (EtherCAT Basics --> CoE Interface) must be observed!

A few brief extracts:

- Whether changes in the online directory are saved locally in the slave depends on the device. EL terminals (except the EL66xx) are able to save in this way.
- The user must manage the changes to the StartUp list.

### **Commissioning aid in the TwinCAT System Manager**

Commissioning interfaces are being introduced as part of an ongoing process for EL/EP EtherCAT devices. These are available in TwinCAT System Managers from TwinCAT 2.11R2 and above. They are integrated into the System Manager through appropriately extended ESI configuration files.

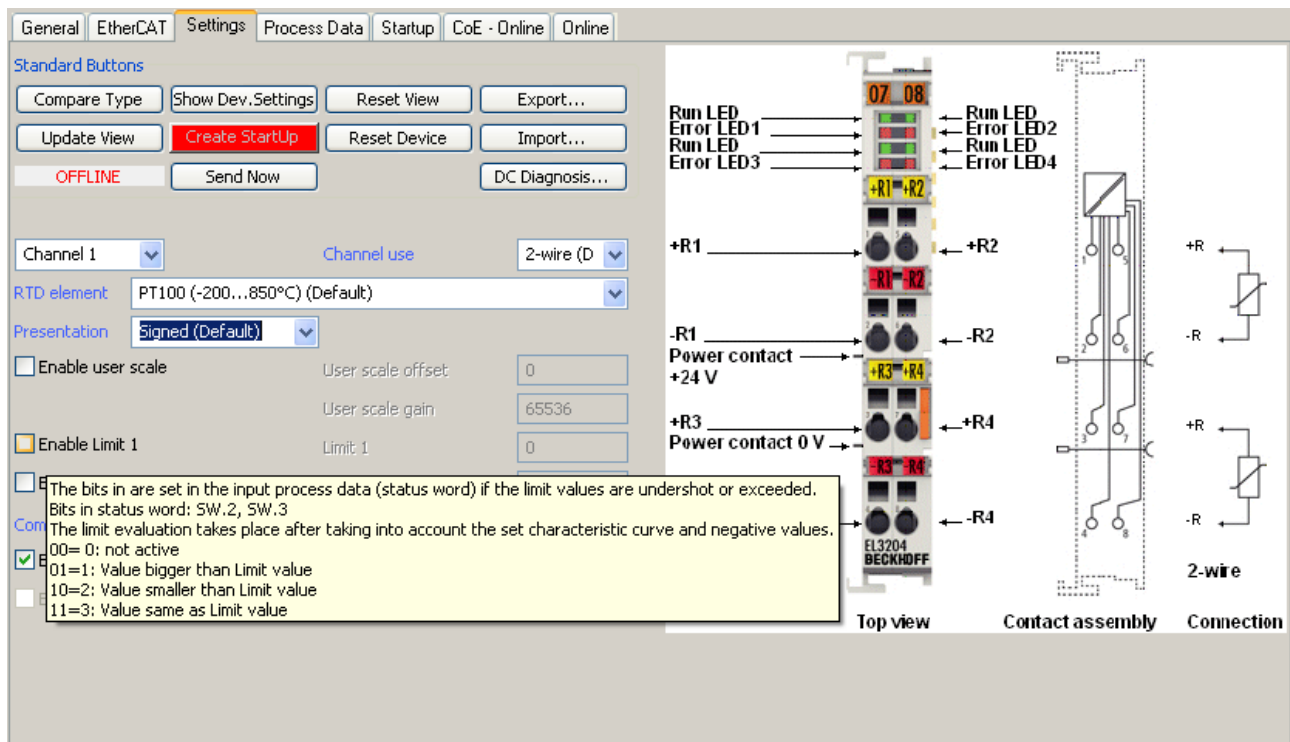

Fig. 145: Example of commissioning aid for a EL3204

This commissioning process simultaneously manages

- CoE Parameter Directory
- DC/FreeRun mode
- the available process data records (PDO)

Although the “Process Data”, “DC”, “Startup” and “CoE-Online” that used to be necessary for this are still displayed, it is recommended that, if the commissioning aid is used, the automatically generated settings are not changed by it.

The commissioning tool does not cover every possible application of an EL/EP device. If the available setting options are not adequate, the user can make the DC, PDO and CoE settings manually, as in the past.

**EtherCAT State: automatic default behaviour of the TwinCAT System Manager and manual operation**

After the operating power is switched on, an EtherCAT Slave must go through the following statuses

- INIT
- PREOP
- SAFEOP
- OP

to ensure sound operation. The EtherCAT Master directs these statuses in accordance with the initialization routines that are defined for commissioning the device by the ES/XML and user settings (Distributed Clocks (DC), PDO, CoE). See also the section on "Principles of [Communication, EtherCAT State Machine \[► 55\]](#)" in this connection. Depending how much configuration has to be done, and on the overall communication, booting can take up to a few seconds.

The EtherCAT Master itself must go through these routines when starting, until it has reached at least the OP target state.

The target state wanted by the user, and which is brought about automatically at start-up by TwinCAT, can be set in the System Manager. As soon as TwinCAT reaches the status RUN, the TwinCAT EtherCAT Master will approach the target states.

**Standard setting**

The advanced settings of the EtherCAT Master are set as standard:

- EtherCAT Master: OP
- Slaves: OP  
This setting applies equally to all Slaves.

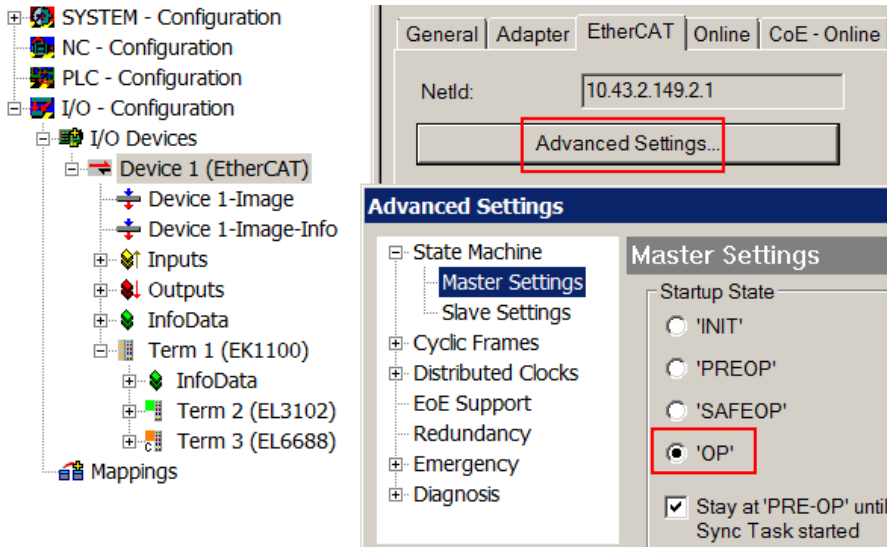

Fig. 146: Default behaviour of the System Manager

In addition, the target state of any particular Slave can be set in the “Advanced Settings” dialogue; the standard setting is again OP.

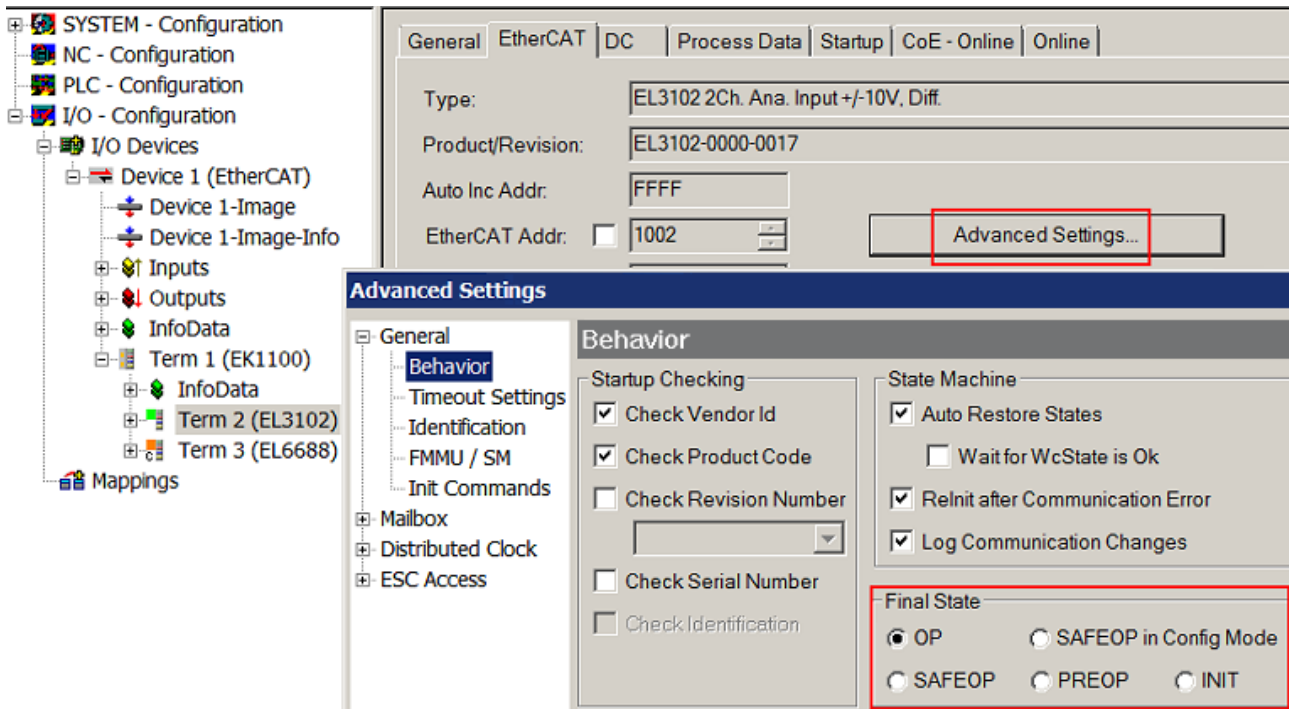

Fig. 147: Default target state in the Slave

**Manual Control**

There are particular reasons why it may be appropriate to control the states from the application/task/PLC. For instance:

- for diagnostic reasons
- to induce a controlled restart of axes



- because a change in the times involved in starting is desirable

In that case it is appropriate in the PLC application to use the PLC function blocks from the *TcEtherCAT.lib*, which is available as standard, and to work through the states in a controlled manner using, for instance, *FB\_EcSetMasterState*.

It is then useful to put the settings in the EtherCAT Master to INIT for master and slave.

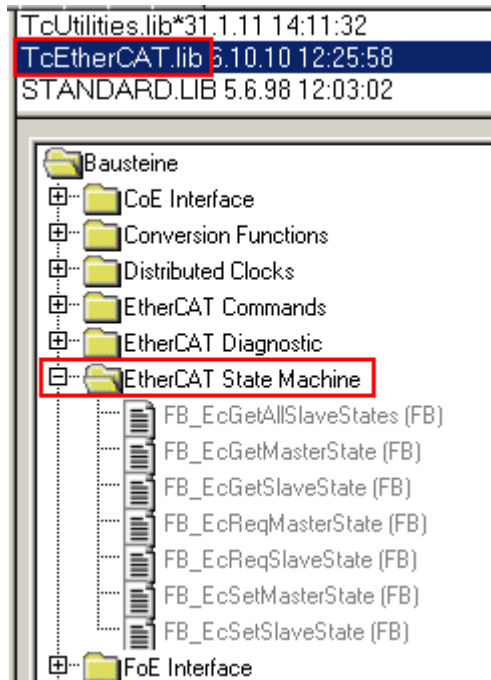

Fig. 148: PLC function blocks

### Note regarding E-Bus current

EL/ES terminals are placed on the DIN rail at a coupler on the terminal strand. A Bus Coupler can supply the EL terminals added to it with the E-bus system voltage of 5 V; a coupler is thereby loadable up to 2 A as a rule. Information on how much current each EL terminal requires from the E-bus supply is available online and in the catalogue. If the added terminals require more current than the coupler can supply, then power feed terminals (e.g. EL9410) must be inserted at appropriate places in the terminal strand.

The pre-calculated theoretical maximum E-Bus current is displayed in the TwinCAT System Manager as a column value. A shortfall is marked by a negative total amount and an exclamation mark; a power feed terminal is to be placed before such a position.

General   Adapter   EtherCAT   Online   CoE - Online						
NetId:		10.43.2.149.2.1		Advanced Settings...		
Number	Box Name	Address	Type	In Size	Out S...	E-Bus (..
1	Term 1 (EK1100)	1001	EK1100			
2	Term 2 (EL3102)	1002	EL3102	8.0		1830
3	Term 4 (EL2004)	1003	EL2004		0.4	1730
4	Term 5 (EL2004)	1004	EL2004		0.4	1630
5	Term 6 (EL7031)	1005	EL7031	8.0	8.0	1510
6	Term 7 (EL2808)	1006	EL2808		1.0	1400
7	Term 8 (EL3602)	1007	EL3602	12.0		1210
8	Term 9 (EL3602)	1008	EL3602	12.0		1020
9	Term 10 (EL3602)	1009	EL3602	12.0		830
10	Term 11 (EL3602)	1010	EL3602	12.0		640
11	Term 12 (EL3602)	1011	EL3602	12.0		450
12	Term 13 (EL3602)	1012	EL3602	12.0		260
13	Term 14 (EL3602)	1013	EL3602	12.0		70
14	Term 3 (EL6688)	1014	EL6688	22.0		-240 !

Fig. 149: Illegally exceeding the E-Bus current

From TwinCAT 2.11 and above, a warning message “E-Bus Power of Terminal...” is output in the logger window when such a configuration is activated:

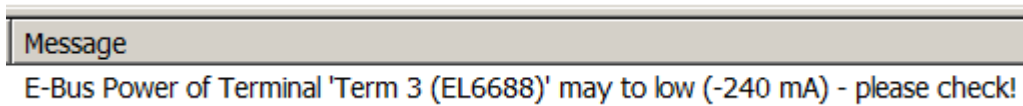

Fig. 150: Warning message for exceeding E-Bus current

<b>NOTICE</b>
<p><b>Caution! Malfunction possible!</b></p> <p>The same ground potential must be used for the E-Bus supply of all EtherCAT terminals in a terminal block!</p>

## 6.4 Process data

### 6.4.1 Sync Manager

The scope of the process data offered can be viewed on the "Process data" tab.

The following figures show an example of the assigned input process data objects (PDO) of the sync manager (SM3) of the EL3423.

The screenshot displays the 'Process Data' configuration for Sync Manager SM3. It is divided into several sections:

- Sync Manager:** A table listing SM, Size, Type, and Flags.
 

SM	Size	Type	Flags
0	128	MbxOut	
1	128	MbxIn	
2	2	Outputs	
3	178	Inputs	
- PDO List:** A table listing Index, Size, Name, Flags, SM, and SU.
 

Index	Size	Name	Flags	SM	SU
0x1A00	2.0	L1 Status	F	0	0
0x1A03	24.0	L1 Energy	F	0	0
0x1A06	12.0	L1 Statistic Voltage	F	0	0
0x1A07	12.0	L1 Statistic Current	F	0	0
0x1A08	36.0	L1 Statistic Power	F	0	0
0x1A0A	2.0	L2 Status	F	0	0
0x1A0D	24.0	L2 Energy	F	0	0
0x1A10	12.0	L2 Statistic Voltage	F	0	0
0x1A11	12.0	L2 Statistic Current	F	0	0
0x1A12	36.0	L2 Statistic Power	F	0	0
0x1A14	2.0	L3 Status	F	0	0
0x1A17	24.0	L3 Energy	F	0	0
0x1A1A	12.0	L3 Statistic Voltage	F	0	0
0x1A1B	12.0	L3 Statistic Current	F	0	0
0x1A1C	36.0	L3 Statistic Power	F	0	0
- PDO Assignment (0x1C12):** A list with a checked checkbox for '0x1601'.
- PDO Content (0x1A00):** A table listing Index, Size, Offs, Name, Type, and Default (hex).
 

Index	Size	Offs	Name	Type	Default (hex)
---	0.1	0.0	---		
0x6000:02	0.1	0.1	Overvoltage	BIT	
0x6000:03	0.1	0.2	Overcurrent	BIT	
0x6000:04	0.1	0.3	Inaccurate Voltage	BIT	
0x6000:05	0.1	0.4	Inaccurate Current	BIT	
0x6000:06	0.1	0.5	Voltage Guard Warning	BIT	
0x6000:07	0.1	0.6	Voltage Guard Error	BIT	
---	1.0	0.7	---		
0x6000:10	0.1	1.7	TxPDO Toggle	BIT	
		2.0			
- Download:** Radio buttons for 'PDO Assignment' (checked) and 'PDO Configuration'.
- Predefined PDO Assignment:** A list of predefined assignments, with 'Total only' selected.

Fig. 151: Process Data tab SM3, example EL3423

#### Predefined PDO Assignment

The "Predefined PDO Assignment" enables a simplified selection of the process data. The desired function is selected on the lower part of the Process Data tab. As a result, all necessary PDOs are automatically enabled and the unnecessary PDOs are disabled.

The following PDO assignments for the EL34xx are available:

EL3423		
Name	SM2, PDO assignment	SM3, PDO assignment
3 Phase	-	0x1A00 (L1 Status) 0x1A03 (L1 Energy)  0x1A0A (L2 Status) 0x1A0D (L2 Energy)  0x1A14 (L3 Status) 0x1A17 (L3 Energy)  0x1A1E (Total Status) 0x1A20 (Total Advanced)  0x1A29 (Total Active Reduced) 0x1A2A (Total Apparent Reduced) 0x1A2B (Total reactive Reduced)
Statistics	-	0x1A06 (L1 Statistic Voltage) 0x1A08 (L1 Statistic Power)  0x1A10 (L2 Statistic Voltage) 0x1A12 (L2 Statistic Power)  0x1A1A (L3 Statistic Voltage) 0x1A1C (L3 Statistic Power)  0x1A1E (Total Status)  0x1A26 (Total Statistic Power) 0x1A27 (Total Statistic PQF) 0x1A28 (Total Interval Energy)
Single Phase	-	0x1A00 (L1 Status) 0x1A03 (L1 Energy)  0x1A1E (Total Status) 0x1A20 (Total Advanced)  0x1A29 (Total Active Reduced) 0x1A2A (Total Apparent Reduced) 0x1A2B (Total reactive Reduced)
Total only	-	0x1A1E (Total Status) 0x1A20 (Total Advanced)  0x1A26 (Total Statistic Power) 0x1A27 (Total Statistic PQF) 0x1A29 (Total Active Reduced) 0x1A2A (Total Apparent Reduced) 0x1A2B (Total reactive Reduced) 0x1A2C (Total Interval Energy Reduced)

EL3443		
Name	SM2, PDO assignment	SM3, PDO assignment
Default	-	0x1A00 (L1 Status) 0x1A01 (L1 Basic) 0x1A02 (L1 Power) 0x1A04 (L1 Timing)  0x1A0A (L2 Status) 0x1A0B (L2 Basic) 0x1A0C (L2 Power) 0x1A0E (L2 Timing)  0x1A14 (L3 Status) 0x1A15 (L3 Basic) 0x1A16 (L3 Power) 0x1A18 (L3 Timing)  0x1A1E (Total Status) 0x1A1F (Total Basic) 0x1A21 (Total Active) 0x1A24 (Total L-L Voltage)
Default + Variant	0x1600 (Total Variant Value Out)	0x1A00 (L1 Status) 0x1A01 (L1 Basic) 0x1A02 (L1 Power) 0x1A04 (L1 Timing)  0x1A0A (L2 Status) 0x1A0B (L2 Basic) 0x1A0C (L2 Power) 0x1A0E (L2 Timing)  0x1A14 (L3 Status) 0x1A15 (L3 Basic) 0x1A16 (L3 Power) 0x1A18 (L3 Timing)  0x1A1E (Total Status) 0x1A1F (Total Basic) 0x1A25 (Total Variant Value In)
Advanced	-	0x1A00 (L1 Status) 0x1A01 (L1 Basic) 0x1A02 (L1 Power) 0x1A03 (L1 Energy) 0x1A04 (L1 Timing)  0x1A0A (L2 Status) 0x1A0B (L2 Basic) 0x1A0C (L2 Power) 0x1A0D (L2 Energy) 0x1A0E (L2 Timing)  0x1A14 (L3 Status) 0x1A15 (L3 Basic) 0x1A16 (L3 Power) 0x1A17 (L3 Energy) 0x1A18 (L3 Timing)  0x1A1E (Total Status) 0x1A1F (Total Basic) 0x1A20 (Total Advanced) 0x1A21 (Total Active)
Total Only	0x1600 (Total Variant Value Out)	0x1A00 (L1 Status)  0x1A0A (L2 Status)  0x1A14 (L3 Status)  0x1A1E (Total Status) 0x1A1F (Total Basic) 0x1A20 (Total Advanced)  0x1A24 (Total L-L Voltage) 0x1A25 (Total Variant Value In) 0x1A26 (Total Statistic Power) 0x1A27 (Total Statistic PQF)  0x1A29 (Total Active Reduced) 0x1A2A (Total Apparent Reduced) 0x1A2B (Total Reactive Reduced)
Classic	0x1600 (Total Variant Value Out)	0x1A00 (L1 Status) 0x1A09 (L1 Classic)  0x1A0A (L2 Status) 0x1A13 (L2 Classic)

EL3443		
Name	SM2, PDO assignment	SM3, PDO assignment
		0x1A14 (L3 Status) 0x1A1D (L3 Classic) 0x1A1E (Total Status) 0x1A25 (Total Variant Value In)
Single Phase	0x1600 (Total Variant Value Out) 0x1601 (Total Interval)	0x1A00 (L1 Status) 0x1A01 (L1 Basic) 0x1A02 (L1 Power) 0x1A03 (L1 Energy) 0x1A04 (L1 Timing) 0x1A06 (L1 Statistic Voltage) 0x1A1E (Total Status) 0x1A1F (Total Basic) 0x1A25 (Total Variant Value In) 0x1A28 (Total Interval Energy)
DPM	0x1600 (Total Outputs Device) 0x1601 (Total Interval)	0x1A00 (L1 Status) 0x1A0A (L2 Status) 0x1A14 (L3 Status) 0x1A1E (Total Status) 0x1A25 (Total Variant Value In) 0x1A2D (DPM Data)

EL3446		
Name	SM2, PDO assignment	SM3, PDO assignment
Current only	-	0x1A01 (I1 Current) 0x1A03 (I2 Current) 0x1A05 (I3 Current) 0x1A07 (I4 Current) 0x1A09 (I5 Current) 0x1A0B (I6 Current)
DPM	-	0x1A00 (I1 Channel) 0x1A02 (I2 Channel) 0x1A04 (I3 Channel) 0x1A06 (I4 Channel) 0x1A08 (I5 Channel) 0x1A0A (I6 Channel)  0x1A0C (DPM Variant Value In)

EL3453		
Name	SM2, PDO assignment	SM3, PDO assignment
Default	-	0x1A00 (L1 Status) 0x1A01 (L1 Basic) 0x1A02 (L1 Power)  0x1A0C (L2 Status) 0x1A0D (L2 Basic) 0x1A0E (L2 Power)  0x1A18 (L3 Status) 0x1A19 (L3 Basic) 0x1A1A (L3 Power)  0x1A24 (Total Status) 0x1A25 (Total Basic)
Default + Variant	0x1600 (Total Variant Value Out)	0x1A00 (L1 Status) 0x1A01 (L1 Basic) 0x1A02 (L1 Power)  0x1A0C (L2 Status) 0x1A0D (L2 Basic) 0x1A0E (L2 Power)  0x1A18 (L3 Status) 0x1A19 (L3 Basic) 0x1A1A (L3 Power)  0x1A24 (Total Status) 0x1A25 (Total Basic) 0x1A2E (Total Variant Value In)
Advanced	-	0x1A00 (L1 Status) 0x1A01 (L1 Basic) 0x1A02 (L1 Power) 0x1A07 (L1 Advanced)  0x1A0C (L2 Status) 0x1A0D (L2 Basic) 0x1A0E (L2 Power) 0x1A13 (L2 Advanced)  0x1A18 (L3 Status) 0x1A19 (L3 Basic) 0x1A1A (L3 Power) 0x1A1F (L3 Advanced)  0x1A24 (Total Status) 0x1A25 (Total Basic) 0x1A26 (Total Advanced)
Total Only	0x1600 (Total Variant Value Out)	0x1A00 (L1 Status)  0x1A0C (L2 Status)  0x1A18 (L3 Status)  0x1A24 (Total Status) 0x1A25 (Total Basic) 0x1A26 (Total Advanced)  0x1A2E (Total Variant Value In)  0x1A36 (Total Active Reduced) 0x1A37 (Total Apparent Reduced) 0x1A38 (Total Reactive Reduced)
Classic	0x1600 (Total Variant Value Out)	0x1A00 (L1 Status) 0x1A0B (L1 Classic)  0x1A0C (L2 Status) 0x1A17 (L2 Classic)  0x1A18 (L3 Status) 0x1A23 (L3 Classic)  0x1A24 (Total Status)  0x1A2E (Total Variant Value In)
Single Phase	0x1600 (Total Variant Value Out) 0x1601 (Total Interval)	0x1A00 (L1 Status) 0x1A01 (L1 Basic) 0x1A02 (L1 Power) 0x1A06 (L1 Timing) 0x1A07 (L1 Advanced)  0x1A24 (Total Status)
DPM	0x1600 (Total Variant Value Out) 0x1601 (Total Interval)	0x1A00 (L1 Status) 0x1A01 (L1 Basic) 0x1A02 (L1 Power)



EL3453		
Name	SM2, PDO assignment	SM3, PDO assignment
		0x1A0C (L2 Status) 0x1A0D (L2 Basic) 0x1A0E (L2 Power)  0x1A18 (L3 Status) 0x1A19 (L3 Basic) 0x1A1A (L3 Power)  0x1A24 (Total Status) 0x1A25 (Total Basic)  0x1A2E (Total Variant Value In)  0x1A3A (DPM Data)

EL3483		
Name	SM2, PDO-Zuordnung	SM3, PDO-Zuordnung
Default	-	0x1A00 (L1 Status) 0x1A0A (L2 Status) 0x1A14 (L3 Status) 0x1A20 (Total Advanced)
Single Phase	-	0x1A00 (L1 Status) 0x1A1E (Total Status) 0x1A20 (Total Advanced)

### **i** Manual selection of the input PDO (SM3)

When manually compiling the PDO, care must be taken that no more than 238 bytes of input PDO are selected. The output PDOs are not subject to any restrictions and may always be selected completely.

### Notes on the TxPDO toggle bits

The TxPDO toggle bits indicate that new data is available for the respective measured values:

- Lx Status - TxPDO Toggle => new base (U,I) and power values (P,Q,S) are provided
- Lx Advanced - TxPDO Toggle => a new set of harmonics is present
- Total Interval Energy - TxPDO Toggle => new interval values are available (this also includes all statistic values)

EL3423		EL3443	
Name	PDO assignment   PDO	Name	PDO assignment   PDO
L1 Status	1A00:09   0x6010:10	L1 Status	1A00:09   0x6010:10
L2 Status	1A0A:09   0x6010:10	L2 Status	1A0A:09   0x6010:10
L3 Status	1A14:09   0x6020:10	L3 Status	1A14:09   0x6020:10
L1 Advanced	-	L1 Advanced	1A05:02   0x6007:10
L2 Advanced	-	L2 Advanced	1A0F:02   0x6017:10
L3 Advanced	-	L3 Advanced	1A19:02   0x6027:10
Total Interval Energy	-	Total Interval Energy	1A28:02   0xF60D:10

EL3453		EL3483	
Name	PDO assignment   PDO	Name	PDO assignment   PDO
L1 Status	1A00:0B   0x6010:10	L1 Status	1A00:09   0x6010:10
L2 Status	1A0C:0B   0x6010:10	L2 Status	1A0A:09   0x6010:10
L3 Status	1A18:0B   0x6020:10	L3 Status	1A14:09   0x6020:10
L1 Advanced	1A07:02   0x6007:10	L1 Advanced	-
L2 Advanced	1A13:02   0x6017:10	L2 Advanced	-
L3 Advanced	1A1F:02   0x6027:10	L3 Advanced	-
Total Interval Energy	1A31:02   0xF60D:10	Total Interval Energy	-

## 6.4.2 Settings

### "Settings" Tab

General EtherCAT Settings DC Process Data Startup CoE - Online Diag History Online

Enable Settings (Applicable from FW01)

EL3443 Energy Measurement Terminal

Operation Mode: Default

Nominal Voltage: 0 Nominal Frequency: 0

Reference: Measurement Range: Frequency Source:

	Channel 1	Channel 2	Channel 3
Voltage Transformer Ratio	1.000000	1.000000	1.000000
Current Transformer Ratio	1.000000	1.000000	1.000000
Current Transformer Delay	0.000000	0.000000	0.000000

	Min Error	Min Warning	Max Warning	Max Error
Frequency	0	0	0	0
PQF	0	0	0	0
Neutral Current	0	0	0	0
Active Power	0	0	0	0
Apparent Power	0	0	0	0

Channel 1 Voltage	2.000000	207.000000	253.000000	278.000000
Channel 2 Voltage	2.000000	207.000000	253.000000	278.000000
Channel 3 Voltage	2.000000	207.000000	253.000000	278.000000
Channel 1 Current	-1.050000	-1.000000	1.000000	1.050000
Channel 2 Current	-1.050000	-1.000000	1.000000	1.050000
Channel 3 Current	-1.050000	-1.000000	1.000000	1.050000

Current Values

Import/Export Product Details DefaultValues Apply (offline) TxPDO State: 0 Cycle Time[ms]: 4

Fig. 152: "Settings" tab

The "Settings" tab provides direct access to the most important configuration objects in the object data dictionary. It facilitates the terminal configuration.

The Import/Export button can be used to save and reload existing settings.

#### Confirmation of variable output values 1 - 4

(PDOs: PMX Variant Value In, Subindex "Index" [\[0xF60A:12 |> 201\]](#), [\[0xF60A:14 |> 201\]](#), [\[0xF60A:16 |> 201\]](#), [\[0xF60A:18 |> 201\]](#))

The calculated values can be output on the PDOs: PMX Variant Value In, Subindex "Variant value In" [\[0xF60A:12, 0xF60A:14, 0xF60A:16, 0xF60A:18\]](#).

To this end, the corresponding values for the measured value to be output should be entered in the PDOs: PMX Variant Value Out, Subindex "PMX Variant Value Out" [\[0xF700:11 |> 203\]](#), [\[0xF700:12 |> 203\]](#), [\[0xF700:13 |> 203\]](#), [\[0xF700:14 |> 203\]](#).

Assignment of variable output values plus channel offset (256 for channel 1; 512 for channel 2 or 768 for channel 3)				
Values (dec), Entry in PDOs: PMX Variant Value In Index 1-3 REAL [0xF700:11, 0xF700:12,] 0xF700:13]	Values (dec), Entry in PDOs: PMX Variant Value In Index 4 ULINT [0xF700:14]	Meaning	Unit	Description
1 (Examp.: 257 = 1 + 256 for ch. 1)	-	U RMS	V	RMS value of the voltage
2 (Examp.: 770 = 2 + 768 for ch. 3)	-	U peak	V	Peak value of the instantaneous voltage in the last interval
-	3	U Last Zero Cross	V	DC time of the penultimate voltage zero crossing
4	-	U RMS Minimum	V	Minimum RMS value of the voltage in the last interval
5	-	U RMS Maximum	V	Maximum RMS value of the voltage in the last interval
6	-	ULL	V	RMS value of the phase-to-phase voltage (Channel 1: U_L1L2; Channel 1: U_L2L3; Channel 3: U_L3L1)
8	-	I RMS	A	RMS value of the current
9	-	I peak	A	Peak value of the instantaneous current in the last interval
-	10*	I Last Zero Cross	ns	DC time of the last current zero crossing
11	-	I RMS Minimum	A	Minimum RMS value of the current in the last interval
12	-	I RMS Maximum	A	Maximum RMS value of the current in the last interval
17	-	Frequency	Hz	Frequency of this phase
21	-	Phi	°	Phase angle of the fundamental wave
22	-	Cos phi	-	Cosine of the fundamental wave phase angle
23	-	Power Factor	-	Power factor
26	-	P	W	Active power
27	-	Pavg	W	Average active power during the last interval
28	-	Pmin	W	Minimum active power in the last interval
29	-	Pmax	W	Maximum active power in the last interval
30*	-	Pfund	W	Fundamental wave active power in the last interval
32	-	S	VA	Apparent power
33	-	Savg	VA	Average apparent power during the last interval
34	-	Smin	VA	Minimum apparent power in last interval
35	-	Smax	VA	Maximum apparent power in last interval
36*	-	Sfund	VA	Fundamental wave apparent power in the last interval
38	-	Q	var	Reactive power
39	-	Qavg	var	Average reactive power average during the last interval
40	-	Qmin	var	Minimum reactive power in the last interval
41	-	Qmax	var	Maximum reactive power in the last interval
42*	-	Qfund	var	Fundamental wave reactive power in last interval
-	45	EP	mWh	Recorded active energy
-	46	EP pos	mhW	Received active energy
-	47	EP neg	mWh	Supplied active energy
-	51	ES	mWh	Apparent energy
-	57	EQ	mWh	Reactive energy
-	63*	EP_fund	mWh	Balanced fundamental wave active energy
-	64*	EP_pos_fund	mWh	Related fundamental wave active energy
-	65*	EP_neg_fund	mWh	Input fundamental wave active energy
-	69*	ES_fund	mWh	Fundamental wave apparent energy
-	75*	EQ_fund	mWh	Balanced fundamental wave reactive energy
-	76*	EQ_pos_fund	mWh	Inductive fundamental wave reactive energy
-	77*	EQ_neg_fund	mWh	Capacitive fundamental wave reactive energy

Assignment of variable output values plus channel offset (256 for channel 1; 512 for channel 2 or 768 for channel 3)				
Values (dec), Entry in PDOs: PMX Variant Value In Index 1-3 REAL [0xF700:11, 0xF700:12.] 0xF700:13]	Values (dec), Entry in PDOs: PMX Variant Value In Index 4 ULINT [0xF700:14]	Meaning	Unit	Description
95		THD_U	-	"Total Harmonic Distortion" is the distortion factor of the voltage. It indicates the ratio of the harmonic components of an oscillation relative to its fundamental.
98		RMS_fund_U	V	Amplitude of the fundamental wave
99		F_Ref_U	Hz	Reference frequency of the voltage harmonic: Specifies the underlying fundamental frequency, e.g.: 50 or 60 Hz.
100-141 - 163*		Harmonics U 0 to 41 up to 63*	% of the fundamental wave	0 => DC component 1 => fundamental wave 2=> 2nd harmonic 3=> 3rd harmonic
165		THD_I	-	"Total Harmonic Distortion" is the distortion factor of the current. It indicates the ratio of the harmonic components of an oscillation relative to its fundamental.
166		TDD_I	% of the maximum current	"Total Demand Distortion" indicates the ratio between the current harmonics and the maximum current (EL3443: 1A and EL3443-0010: 5A)
168		RMS_fund_I	A	Amplitude of the fundamental wave
169		F_Ref_I	Hz	Reference frequency of the current harmonic: Specifies the underlying fundamental frequency, e.g.: 50 or 60 Hz.
170-211 - 233*		Harmonics I 0 to 41 up to 63*	% of the fundamental wave	0 => DC component 1 => fundamental wave 2=> 2nd harmonic 3=> 3rd harmonic
255		Error: INDEX not valid	-	Error message: The selected index is not available.

Values with star\* are only available in the EL3453.

Assignment of variable output values across all channels				
Values (dec), Entry in PDOs: PMX Variant Value In Index 1-3 REAL [0xF700:11, 0xF700:12, 0xF700:13]	Values (dec), Entry in PDOs: PMX Variant Value In Index 4 ULINT [0xF700:14]	Meaning	Unit	Description
1032 (= 1024 + 8)	-	In RMS	A	Calculated RMS value of the neutral current
1033 (= 1024 + 9)*	-	In peak	A	Highest peak value of the instantaneous current in the last interval
1035 (= 1024 + 11)*	-	In RMS Minimum	A	Smallest effective value of the current in the last interval
1036 (= 1024 + 12)*	-	In RMS Maximum	A	Largest effective value of the current in the last interval
1041 (= 1024 + 17)*	-	Frequency	Hz	Frequency of the PDO value set via CoE (see reference channel of frequency measurement)
1047 (= 1024 + 23)	-	Power Factor	-	Total power factor over all phases
1050 (= 1024 + 26)	-	Ptot	W	Total active power
1051 (= 1024 + 27)	-	Ptotavg	W	Average total active power during the last interval
1052 (= 1024 + 28)	-	Ptotmin	W	Minimum total active power in the last interval
1053 (= 1024 + 29)	-	Ptotmax	W	Maximum total active power in the last interval
1056 (= 1024 + 32)	-	Stot	VA	Total apparent power
1057 (= 1024 + 33)	-	Stotavg	VA	Average total apparent power during the last interval
1058 (= 1024 + 34)	-	Stotmin	VA	Minimum total apparent power in the last interval
1059 (= 1024 + 35)	-	Stotmax	VA	Maximum total apparent power in the last interval
1062 (= 1024 + 38)	-	Qtot	var	Total reactive power
1063 (= 1024 + 39)	-	Qtotavg	var	Average total reactive power during the last interval
1064 (= 1024 + 40)	-	Qtotmin	var	Minimum total reactive power in the last interval
1065 (= 1024 + 41)	-	Qtotmax	var	Maximum total reactive power in the last interval
-	1069 (= 1024 + 45)	Eptot	mWh	Balanced total active energy
-	1070 (= 1024 + 46)	EPtot pos	mWh	Imported total active energy
-	1071 (= 1024 + 47)	EPtot neg	mWh	Generated total active energy
-	1072 (= 1024 + 48)	Eptot_intervall	mWh	Balanced total active energy in last interval
-	1073 (= 1024 + 49)	EPtot_pos_intervall	mWh	Total active energy imported in the last interval
-	1074 (= 1024 + 50)	EPtot_neg_intervall	mWh	Generated total active energy the last interval
-	1075 (= 1024 + 51)	EStot	mWh	Total apparent energy
-	1078 (= 1024 + 54)	EStot_intervall	mWh	Total apparent energy in the last interval
-	1081 (= 1024 + 57)	EQtot	mWh	Total reactive energy
-	1084 (= 1024 + 60)	EQtot_intervall	mWh	Total reactive energy in the last interval
1094 (= 1024 + 70)	-	PhiL1L2	°	Phase shift angle between phase L1 and L2
1095 (= 1024 + 71)	-	PhiL1L3	°	Phase shift angle between phase L1 and L3
1096 (= 1024 + 72)	-	Unbalance	-	Ratio between negative and positive voltage system
1104 (= 1024 + 80)	-	PQF	-	Power quality factor
1105 (= 1024 + 81)	-	PQF Avg	-	Average value of the power quality factor during the last interval
1106 (= 1024 + 82)	-	PQF Min	-	Minimum power quality factor in the last interval
1107 (= 1024 + 83)	-	PQF Max	-	Maximum power quality factor in the last interval
-	1124 (= 1024 + 100)*	Eptot_fund	mWh	Balanced total fundamental wave active energy
-	1125 (= 1024 + 101)*	EPtot_fund pos	mWh	Received total fundamental wave active energy
-	1126 (= 1024 + 102)*	EPtot_fund neg	mWh	Supplied total fundamental wave active energy
-	1127 (= 1024 + 103)*	Eptot_fund_intervall	mWh	Balanced total fundamental wave active energy in the last interval
-	1128 (= 1024 + 104)*	EPtot_fund_pos_intervall	mWh	Received total fundamental wave active energy in the last interval
-	1129 (= 1024 + 105)*	EPtot_fund_neg_intervall	mWh	Supplied total fundamental wave active energy in the last interval

Assignment of variable output values across all channels				
Values (dec), Entry in PDOs: PMX Variant Value In Index 1-3 REAL [0xF700:11, 0xF700:12, 0xF700:13]	Values (dec), Entry in PDOs: PMX Variant Value In Index 4 ULINT [0xF700:14]	Meaning	Unit	Description
-	1130 (= 1024 + 106)*	EStot_fund	mWh	Total fundamental wave apparent energy
-	1133 (= 1024 + 109)*	EStot_fund _intervall	mWh	Total fundamental wave apparent energy in the last interval
-	1136 (= 1024 + 112)*	EQtot_fund	mWh	Balanced total fundamental wave reactive energy
-	1137 (= 1024 + 113)*	EQtot_fund pos	mWh	Inductive total fundamental wave reactive energy
-	1138 (= 1024 + 114)*	EQtot_fund neg	mWh	Capacitive total fundamental wave reactive energy
-	1139 (= 1024 + 115)*	EQtot_fund _intervall	mWh	Balanced total fundamental wave reactive energy in the last interval
-	1140 (= 1024 + 116)*	EQtot_fund pos_intervall	mWh	Inductive total fundamental wave reactive energy in the last interval
-	1141 (= 1024 + 117)*	EQtot_fund neg_intervall	mWh	Capacitive total fundamental wave reactive energy in the last interval
1154 (= 1024 + 130)*	-	Ptot_fund	W	Total fundamental wave active power
1155 (= 1024 + 131)*	-	Ptotavg_fund	W	Total fundamental wave average active power during last interval
1156 (= 1024 + 132)*	-	Ptotmin_fund	W	Total fundamental wave minimum active power in the last interval
1157 (= 1024 + 133)*	-	Ptotmax_fund	W	Total fundamental wave maximum active power in the last interval
1160 (= 1024 + 136)*	-	Stot_fund	VA	Total fundamental wave apparent power
1161 (= 1024 + 137)*	-	Stotavg_fund	VA	Total fundamental wave average apparent power during last interval
1162 (= 1024 + 138)*	-	Stotmin_fund	VA	Total fundamental wave minimum apparent power in the last interval
1163 (= 1024 + 139)*	-	Stotmax_fund	VA	Total fundamental wave maximum apparent power in the last interval
1166 (= 1024 + 142)*	-	Qtot_fund	var	Total fundamental wave reactive power
1167 (= 1024 + 143)*	-	Qtotavg_fund	var	Total fundamental wave average reactive power during last interval
1168 (= 1024 + 144)*	-	Qtotmin_fund	var	Total fundamental wave minimum reactive power during last interval
1169 (= 1024 + 145)*	-	Qtotmax_fund	var	Total fundamental wave maximum reactive power during last interval

Values with star\* are only available in the EL3453.

### Reference channel for the frequency measurement (index [0xF800:11](#) [[▶ 171](#)] and index [0xF800:13](#) [[▶ 171](#)])

The EL34xx can measure the frequency for a voltage path input signal and a current path input signal. CoE objects "Reference" and "Frequency Source" (F800:11 and F800:13) can be used to set which frequency is to be output as PDO.

Default: Voltage at channel 1

### Power quality factor setting

To adapt the power quality factor to your mains supply, enter the nominal voltage and frequency in CoE object "[0xF801 PMX Total Settings PQF](#) [[▶ 172](#)]". This can also be done via the "Settings" tab, which summarizes all the important terminal setting options in a user-friendly manner.

### PT2 filter (EL3453)

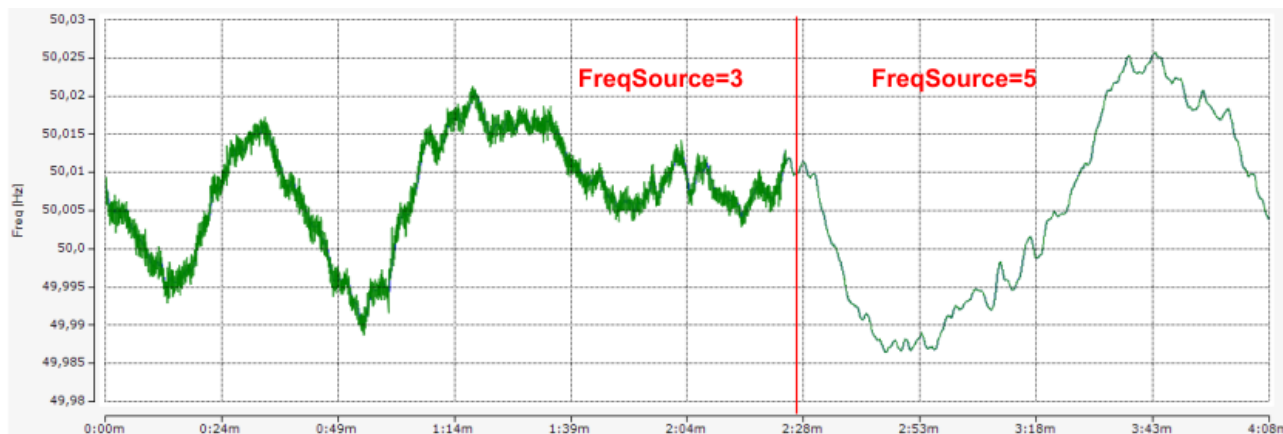

Fig. 153: Setting Index [F800:13](#); [[▶ 235](#)] left without PT2 filter (FreqSource=3), right with PT2 filter (FreqSource=5)

## 6.4.3 Timestamp Distributed Clocks

The terminal transfers the time of the voltage zero crossing as timestamp to objects [0x6006:12](#) [[▶ 197](#)] (channel 1), [0x6016:12](#) [[▶ 197](#)] (channel 2) or [0x6026:12](#) [[▶ 197](#)] (channel 3), if the corresponding indices [0x1A04](#) [[▶ 209](#)], [0x1A0E](#) [[▶ 209](#)] or [0x1A18](#) [[▶ 209](#)] are enabled.

### NOTICE

#### Combination of an Embedded PC of the **CX70xx** series with the **EL344x**

With the above combination a distributed clock jitter must be assumed, which depends on the application, the number of EtherCAT devices and the task time. The distributed clock jitter leads to an additional measurement uncertainty of the phase angle, which affects the ratio of active and reactive power.

The user must decide whether the measurement uncertainty is sufficient for the application. Beckhoff can only point out that the distributed clock jitter in the CX70xx increases the measurement uncertainty and therefore no longer corresponds to the technical data of the terminal.



## 6.5 Scaling factors

If no floating point numbers can be used, the EL3443 can be operated in "Classic" mode, in which only integer values are transferred. The following overview shows the scaling factors required to calculate the actual values from the raw process data values.

If the transformer ratios are not stored in the terminal memory, they must also be subsequently calculated in the PLC.

If the transformer ratios are stored in the CoE (Index 80n0 PMX Settings) of the terminal, these can be skipped as scaling factors in the PLC.

### Scaling factors for the "Classic" mode of the EL3443-00xx

Values	Calculation
Current	Raw values x 0.0001 A x current transformer ratio
Voltage	Raw values x 0.001 V x voltage transformer ratio
Active power	Raw values x 0.001 W x current and voltage transformer ratio
Apparent power	Raw values x 0.001 VA x current and voltage transformer ratio
Reactive power	Raw values x 0.001 VA x current and voltage transformer ratio
Energy	Raw values x 0.001 Wh x current and voltage transformer ratio
Frequency	Raw values x 0.001 Hz

## 6.6 Object description and parameterization

### ● EtherCAT XML Device Description



The display matches that of the CoE objects from the EtherCAT XML Device Description. We recommend downloading the latest XML file from the download area of the Beckhoff website and installing it according to installation instructions.

### ● Parameterization via the CoE list (CAN over EtherCAT)



The EtherCAT device is parameterized via the CoE - Online tab [▶ 134] (double-click on the respective object) or via the Process Data tab [▶ 131] (allocation of PDOs). Please note the following general CoE notes [▶ 57] when using/manipulating the CoE parameters:

- Keep a startup list if components have to be replaced
- Differentiation between online/offline dictionary, existence of current XML description
- use “CoE reload” for resetting changes

### Introduction

The CoE overview contains objects for different intended applications:

- Objects required for parameterization during commissioning:
  - Restore object index 0x1011
  - Configuration data index 0xF800
- Objects intended for regular operation, e.g. through ADS access.
  - PM command object index 0xFB00
- Profile-specific objects:
  - Configuration data (vendor-specific) index 0x80nF
  - Input data index 0x60n0
  - Output data index 0x70n0
  - Information and diagnostic data index 0xF000, 0xF008, 0xF100, 0xF801 and 0xF80F
- Standard objects

The following section first describes the objects required for normal operation, followed by a complete overview of missing objects.

### 6.6.1 EL3423

#### 6.6.1.1 Restore object

##### Index 1011 Restore default parameters

Index (hex)	Name	Meaning	Data type	Flags	Default
1011:0	<u>Restore default parameters</u> [▶ 316]	Restore default parameters	UINT8	RO	0x01 (1 <sub>dec</sub> )
1011:01	SubIndex 001	If this object is set to “ <b>0x64616F6C</b> ” in the set value dialog, all backup objects are reset to their delivery state.	UINT32	RW	0x00000000 (0 <sub>dec</sub> )

### 6.6.1.2 Configuration data

#### Index 80n0 PMX settings (for ch.1, n = 0; ch.2, n = 1; ch.3, n = 2)

Index (hex)	Name	Meaning	Data type	Flags	Default
80n0:0	PMX Settings	Max. subindex	UINT8	RO	0x13 (19 <sub>dec</sub> )
80n0:11	Voltage Transformer Ratio	If a voltage transformer is used, its transmission ratio can be entered here.	REAL32	RW	0x3F800000 (1065353216 <sub>dec</sub> )
80n0:12	Current Transformer Ratio	The ratio of the current transformer used can be entered here.	REAL32	RW	0x3F800000 (1065353216 <sub>dec</sub> )
80n0:13	Current Transformer Delay	Here you can enter a possible time delay of the current transformers in milliseconds.	REAL32	RW	0x00000000 (0 <sub>dec</sub> )

#### Index 80n1 PMX Guard Settings (for ch.1, n = 0; ch.2, n = 1; ch.3, n = 2)

Index (hex)	Name	Meaning	Data type	Flags	Default
80n1:0	PMX Guard Settings	Max. subindex	UINT8	RO	0x14 (20 <sub>dec</sub> )
80n1:11	Voltage Guard Min Error	Lower limit value for a voltage error message [V]	REAL32	RW	0x40000000 (1073741824 <sub>dec</sub> )
80n1:12	Voltage Guard Min Warning	Lower limit value for a voltage warning message [V]	REAL32	RW	0x434F0000 (1129250816 <sub>dec</sub> )
80n1:13	Voltage Guard Max Warning	Upper limit value for a voltage warning message [V]	REAL32	RW	0x437D0000 (1132265472 <sub>dec</sub> )
80n1:14	Voltage Guard Max Error	Upper limit value for a voltage error message [V]	REAL32	RW	0x438B0000 (1133182976 <sub>dec</sub> )

#### Index F800 PMX Settings

Index (hex)	Name	Meaning	Data type	Flags	Default
F800:0	PMX Settings	Max. subindex	UINT8	RO	0x16 (22 <sub>dec</sub> )
F800:01	Reset Interval	Manual restart of the measurement and statistics interval	BOOLEAN	RW	0x00 (0 <sub>dec</sub> )
F800:11	Reference	Timing reference for the RMS calculation Set to "Current" if a current is to be measured without an applied voltage. permitted values: 0 Voltage (default) 1 Current	UINT32	RW	0x00000000 (0 <sub>dec</sub> )
F800:12	Measurement Range	Filter setting for determining the fundamental permitted values: 0 25..65 Hz (default) 1 25..400 Hz 2 12..45 Hz	UINT32	RW	0x00000000 (0 <sub>dec</sub> )
F800:13	Frequency Source	Source of the system frequency permitted values: 0 Channel 1 (default) 1 Channel 2 2 Channel 3	BIT1	RW	0x00000000 (0 <sub>dec</sub> )
F800:14	Power Calculation Threshold	Noise reduction: Here you can enter a minimum limit value in percent for the power calculation, below which all values are zeroed.	REAL32	RW	0x3F800000 (1065353216 <sub>dec</sub> )
F800:15	Inaccurate Threshold Voltage	Limit value for the warning bit: Inaccurate Voltage	REAL32	RW	0x3FDC28F6 (1071393014 <sub>dec</sub> )
F800:16	Inaccurate Threshold Current	Limit value for the warning bit: Inaccurate Current	REAL32	RW	0x3BC49BA6 (1002740646 <sub>dec</sub> )

## Index F801 PMX Total Settings PQF

Index (hex)	Name	Meaning	Data type	Flags	Default
F801:0	PMX Total Settings PQF	Max. subindex	UINT8	RO	0x13 (19 <sub>dec</sub> )
F801:11	Nominal voltage	A nominal voltage value or set value is required to calculate the power quality factor (for details see basic function principles).	REAL32	RW	230.0000000 (2.3000000e+02)
F801:12	Nominal Frequency	A nominal frequency or set value is required to calculate the power quality factor (for details see basic function principles).	REAL32	RW	50.0000000 (5.0000000e+01)
F801:13	PQF Dataset	permitted values: 0: default 1: default + unbalance	UINT32	RW	Default + Unbalance (1 <sub>dez</sub> )

**Index F802 PMX Guard Settings**

Index (hex)	Name	Meaning	Data type	Flags	Default
F802:0	PMX Guard Settings	Max. subindex	UINT8	RO	0x28 (40 <sub>dec</sub> )
F802:11	Frequency Guard Min Error	Lower limit value for a frequency error message	REAL32	RW	47.000000 (4.700000e+001)
F802:12	Frequency Guard Min Warning	Lower limit value for a frequency warning message	REAL32	RW	49.500000 (4.950000e+001)
F802:13	Frequency Guard Max Warning	Upper limit value for a frequency warning message	REAL32	RW	50.500000 (5.050000e+001)
F802:14	Frequency Guard Max Error	Upper limit value for a frequency error message	REAL32	RW	52.000000 (5.200000e+001)
F802:15	Neutral Current Guard Min Error	Lower limit value for an error message of the neutral conductor current	REAL32	RW	<b>EL3423, EL3443</b> 0.000000 (0.000000e+000) <b>EL3453</b> -1.050000 (-1.050000e+000)
F802:16	Neutral Current Guard Min Warning	Lower limit value for a warning message of the neutral conductor current	REAL32	RW	<b>EL3423, EL3443</b> 0.000000 (0.000000e+000) <b>EL3453</b> -1.000000 (-1.000000e+000)
F802:17	Neutral Current Guard Max Warning	Upper limit value for a warning message of the neutral conductor current	REAL32	RW	<b>EL3423, EL3443</b> 0.006000 (6.000000e-003) <b>EL3453</b> 1.000000 (1.000000e+000)
F802:18	Neutral Current Guard Max Error	Upper limit value for an error message of the neutral conductor current	REAL32	RW	<b>EL3423, EL3443</b> 0.030000 (3.000000e-002) <b>EL3453</b> 1.050000 (1.050000e+000)
F802:19	Active Power Guard Min Error	Lower limit value for an active power error message [W]	REAL32	RW	0.000000 (0.000000e+000)
F802:1A	Active Power Guard Min Warning	Lower limit value for an active power warning message [W]	REAL32	RW	0.000000 (0.000000e+000)
F802:1B	Active Power Guard Max Warning	Upper limit value for an active power warning message [W]	REAL32	RW	0.000000 (0.000000e+000)
F802:1C	Active Power Guard Max Error	Upper limit value for an active power error message [W]	REAL32	RW	0.000000 (0.000000e+000)
F802:1D	Apparent Power Guard Min Error	Lower limit value for an apparent power error message [VA]	REAL32	RW	0.000000 (0.000000e+000)
F802:1E	Apparent Power Guard Min Warning	Lower limit value for an apparent power warning message [VA]	REAL32	RW	0.000000 (0.000000e+000)
F802:1F	Apparent Power Guard Max Warning	Upper limit value for an apparent power warning message [VA]	REAL32	RW	0.000000 (0.000000e+000)
F802:20	Apparent Power Guard Max Error	Upper limit value for an apparent power error message [VA]	REAL32	RW	0.000000 (0.000000e+000)
F802:21	PQF Guard Min Error	Lower limit value for a power quality factor error message	REAL32	RW	0.050000 (5.000000e-002)
F802:22	PQF Guard Min Warning	Lower limit value for a power quality factor warning message	REAL32	RW	0.800000 (8.000000e-001)
F802:23	PQF Guard Max Warning	Upper limit value for a power quality factor warning message	REAL32	RW	1.000000 (1.000000e+000)
F802:24	PQF Guard Max Error	Upper limit value for a power quality factor error message	REAL32	RW	1.000000 (1.000000e+000)
F802:25	Unbalance Guard Min Error	Lower limit value for an error message due to voltage imbalance	REAL32	RW	0.000000 (0.000000e+000)
F802:26	Unbalance Guard Min Warning	Lower limit value for a warning message due to voltage imbalance	REAL32	RW	0.000000 (0.000000e+000)

Index (hex)	Name	Meaning	Data type	Flags	Default
F802:27	Unbalance Guard Max Warning	Upper limit value for a warning message due to voltage imbalance	REAL32	RW	<b>EL3423, EL3453</b> 0.000000 (0.000000e+000)  <b>EL3443</b> 2.000000 (2.000000e+000)
F802:28	Unbalance Guard Max Error	Upper limit value for an error message due to voltage imbalance	REAL32	RW	<b>EL3423, EL3453</b> 0.000000 (0.000000e+000)  <b>EL3443</b> 3.000000 (3.000000e+000)

### Index F803 PMX Time Settings

Index (hex)	Name	Meaning	Data type	Flags	Default
F803:0	PMX Time Settings	Max. subindex	UINT8	RO	0x13 (19 <sub>dec</sub> )
F803:11	Measurement Mode	permitted values: 0	UINT32	RW	0x00000000 (0 <sub>dec</sub> )
F803:12	Measurement Interval	Time in seconds to automatic restart of the measurement and statistics interval	UINT32	RW	0x00000000 (0 <sub>dec</sub> )
F803:13	Actual System Time	Shows the current system time of the terminal. Write access to the object is possible in order to change the system time.	STRING	RW	

## 6.6.1.3 Configuration data (vendor-specific)

### Index 80nF PMX vendor data (for ch.1, n = 0; ch.2, n = 1; ch.3, n = 2)

Index (hex)	Name	Meaning	Data type	Flags	Default
80nF:0	PMX Vendor data	Max. subindex	UINT8	RO	0x16 (22 <sub>dec</sub> )
80nF:11	Calibration Voltage Offset	Value in V	REAL32	RW	0x00000000 (0 <sub>dec</sub> )
80nF:12	Calibration Voltage Gain	Factor (without unit)	REAL32	RW	0x3F800000 (1065353216 <sub>dec</sub> )
80nF:13	Calibration Voltage Phase Offset	Value in milliseconds	REAL32	RW	0x00000000 (0 <sub>dec</sub> )
80nF:14	Calibration Current Offset	Value in A	REAL32	RW	0x00000000 (0 <sub>dec</sub> )
80nF:15	Calibration Current Gain	Factor (without unit)	REAL32	RW	0x3F800000 (1065353216 <sub>dec</sub> )
80nF:16	Calibration Current Phase Offset	Value in milliseconds	REAL32	RW	0x00000000 (0 <sub>dec</sub> )

## 6.6.1.4 Input data

### Index 60n0 PMX status (n = 0, 1, 2)

Index (hex)	Name	Meaning	Data type	Flags	Default
60n0:0	PMX Status	Max. subindex	UINT8	RO	0x10 (16 <sub>dec</sub> )
60n0:02	Overvoltage	Maximum measurable voltage is exceeded.	BOOLEAN	RO	0x00 (0 <sub>dec</sub> )
60n0:03	Overcurrent	Maximum measurable current is exceeded.	BOOLEAN	RO	0x00 (0 <sub>dec</sub> )
60n0:04	Inaccurate Voltage	The measured voltage value is smaller than the value entered in CoE object "F800:15 Inaccurate Threshold Voltage".	BOOLEAN	RO	0x00 (0 <sub>dec</sub> )
60n0:05	Inaccurate Current	The measured current value is smaller than the value entered in CoE object "F800:16 Inaccurate Threshold Current".	BOOLEAN	RO	0x00 (0 <sub>dec</sub> )
60n0:06	Voltage Guard Warning	A warning limit of the voltage monitor has been breached.	BOOLEAN	RO	0x00 (0 <sub>dec</sub> )
60n0:07	Voltage Guard Error	An error limit of the voltage monitor has been breached.	BOOLEAN	RO	0x00 (0 <sub>dec</sub> )
6000:10	TxPDO Toggle	The TxPDO toggle is toggled by the slave when the data of the associated TxPDO is updated.	BOOLEAN	RO	0x00 (0 <sub>dec</sub> )

**Index 60n4 PMX Energy (n = 0, 1, 2)**

Index (hex)	Name	Meaning	Data type	Flags	Default
60n4:0	PMX Energy	Max. subindex	UINT8	RO	0x13 (19 <sub>dec</sub> )
60n4:11	Active Energy	Active energy in mWh	INT64	RO	
60n4:12	Apparent Energy	Apparent energy in mVAh	INT64	RO	
60n4:13	Reactive Energy	Reactive energy in mvarh	INT64	RO	

**Index 60n8 PMX Statistic Voltage (n = 0, 1, 2)**

Index (hex)	Name	Meaning	Data type	Flags	Default
60n8:0	PMX Statistic Voltage	Max Subindex	UINT8	RO	0x13 (19 <sub>dec</sub> )
60n8:11	Voltage Peak	Peak value of the instantaneous voltage in the last interval in V	REAL32	RO	0x00000000 (0 <sub>dec</sub> )
60n8:12	Voltage RMS Minimum	Minimum RMS value of the voltage in the last interval in V	REAL32	RO	0x00000000 (0 <sub>dec</sub> )
60n8:13	Voltage RMS Maximum	Maximum RMS value of the voltage in the last interval in V	REAL32	RO	0x00000000 (0 <sub>dec</sub> )

**Index 60n9 PMX Statistic Current (n = 0, 1, 2)**

Index (hex)	Name	Meaning	Data type	Flags	Default
60n9:0	PMX Statistic Current	Max Subindex	UINT8	RO	0x13 (19 <sub>dec</sub> )
60n9:11	Current Peak	Peak value of the instantaneous current in the last interval in A	REAL32	RO	0x00000000 (0 <sub>dec</sub> )
60n9:12	Current RMS Minimum	Minimum RMS value of the current in the last interval in A	REAL32	RO	0x00000000 (0 <sub>dec</sub> )
60n9:13	Current RMS Maximum	Maximum RMS value of the current in the last interval in A	REAL32	RO	0x00000000 (0 <sub>dec</sub> )

**Index 60nA PMX Statistic Power (n = 0, 1, 2)**

Index (hex)	Name	Meaning	Data type	Flags	Default
60nA:0	PMX Statistic Power	Max Subindex	UINT8	RO	0x19 (25 <sub>dec</sub> )
60nA:11	Active Power Avg	Average active power during the last interval in W	REAL32	RO	0x00000000 (0 <sub>dec</sub> )
60nA:12	Active Power Min	Minimum active power in the last interval in W	REAL32	RO	0x00000000 (0 <sub>dec</sub> )
60nA:13	Active Power Max	Maximum active power in the last interval in W	REAL32	RO	0x00000000 (0 <sub>dec</sub> )
60nA:14	Apparent Power Avg	Average apparent power during the last interval in VA	REAL32	RO	0x00000000 (0 <sub>dec</sub> )
60nA:15	Apparent Power Max	Maximum apparent power in the last interval in VA	REAL32	RO	0x00000000 (0 <sub>dec</sub> )
60nA:16	Reactive Power Avg	Average reactive power average during the last interval in var	REAL32	RO	0x00000000 (0 <sub>dec</sub> )
60nA:17	Reactive Power Min	Minimum reactive power in the last interval in var	REAL32	RO	0x00000000 (0 <sub>dec</sub> )
60nA:18	Reactive Power Max	Maximum reactive power in the last interval in var	REAL32	RO	0x00000000 (0 <sub>dec</sub> )
60nA:19	Apparent Power Min	Minimum apparent power in the last interval in VA	REAL32	RO	0x00000000 (0 <sub>dec</sub> )

## Index F600 PMX Total Status

Index (hex)	Name	Meaning	Data type	Flags	Default
F600:0	PMX Total Status	Max. subindex	UINT8	RO	0x11 (17 <sub>dec</sub> )
F600:01	System State	Overall system state (as a logical disjunction of voltage guard errors, phase sequence, overvoltage, overcurrent and frequency guard errors)	BOOLEAN	RO	0x00 (0 <sub>dec</sub> )
F600:02	Grid Direction	Phase sequence L1 - L2 - L3 correctly detected (with clockwise 3-phase mains)	BOOLEAN	RO	0x00 (0 <sub>dec</sub> )
F600:03	Frequency Guard Warning	A warning limit of the frequency monitor has been breached.	BOOLEAN	RO	0x00 (0 <sub>dec</sub> )
F600:04	Frequency Guard Error	An error limit of the frequency monitor has been breached.	BOOLEAN	RO	0x00 (0 <sub>dec</sub> )
F600:05	Neutral Current Guard Warning	A warning limit of the neutral conductor current monitor has been breached.	BOOLEAN	RO	0x00 (0 <sub>dec</sub> )
F600:06	Neutral Current Guard Error	An error limit of the neutral conductor current monitor has been breached.	BOOLEAN	RO	0x00 (0 <sub>dec</sub> )
F600:07	Active Power Guard Warning	A warning limit of the active power monitor has been breached.	BOOLEAN	RO	0x00 (0 <sub>dec</sub> )
F600:08	Active Power Guard Error	An error limit of the active power monitor has been breached.	BOOLEAN	RO	0x00 (0 <sub>dec</sub> )
F600:09	Apparent Power Guard Warning	A warning limit of the apparent power monitor has been breached.	BOOLEAN	RO	0x00 (0 <sub>dec</sub> )
F600:0A	Apparent Power Guard Error	An error limit of the apparent power monitor has been breached.	BOOLEAN	RO	0x00 (0 <sub>dec</sub> )
F600:0B	Power Quality Guard Warning	A warning limit of the PQF monitor has been breached.	BOOLEAN	RO	0x00 (0 <sub>dec</sub> )
F600:0C	Power Quality Guard Error	An error limit of the PQF monitor has been breached.	BOOLEAN	RO	0x00 (0 <sub>dec</sub> )
F600:0F	TxPDO State	TRUE for general error	BOOLEAN	RO	0x00 (0 <sub>dec</sub> )
F600:10	TxPDO Toggle	The TxPDO toggle is toggled by the slave when the data of the associated TxPDO is updated.	BOOLEAN	RO	0x00 (0 <sub>dec</sub> )
F600:11	Power Quality Factor	Analog value of the voltage quality between 1.0 and 0 (see basic function principles - Power Quality Factor)	REAL32	RO	0x00000000 (0 <sub>dec</sub> )

## Index F602 PMX Total Advanced

Index (hex)	Name	Meaning	Data type	Flags	Default
F602:0	PMX Total Advanced	Max. subindex	UINT8	RO	0x02 (2 <sub>dec</sub> )
F602:01	Unbalance Guard Warning	A warning limit of the unbalance monitor has been breached.	BOOLEAN	RO	0x00 (0 <sub>dec</sub> )
F602:02	Unbalance Guard Error	An error limit of the unbalance monitor has been breached.	BOOLEAN	RO	0x00 (0 <sub>dec</sub> )

## Index F603 PMX Total Active

Index (hex)	Name	Meaning	Data type	Flags	Default
F603:0	PMX Total Active	Max. subindex	UINT8	RO	0x14 (20 <sub>dec</sub> )
F603:12	Active Energy	Recorded active energy in mWh	INT64	RO	
F603:13	Active Positive Energy	Received active energy in mWh	INT64	RO	
F603:14	Active Negative Energy	Supplied active energy in mWh	INT64	RO	

## Index F605 PMX Total Apparent

Index (hex)	Name	Meaning	Data type	Flags	Default
F605:0	PMX Total Apparent	Max. subindex	UINT8	RO	0x14 (20 <sub>dec</sub> )
F605:12	Apparent Energy	Recorded apparent energy in mWh	INT64	RO	
F605:13	Apparent Positive Energy	Received apparent energy in mWh	UINT64	RO	
F605:14	Apparent Negative Energy	Supplied apparent energy in mWh	UINT64	RO	



**Index F607 PMX Total Reactive**

Index (hex)	Name	Meaning	Data type	Flags	Default
F607:0	PMX Total Reactive	Max. subindex	UINT8	RO	0x14 (20 <sub>dec</sub> )
F607:12	Reactive Energy	Recorded reactive energy in mWh	INT64	RO	
F607:13	Reactive Positive Energy	Received reactive energy in mWh	UINT64	RO	
F607:14	Reactive Negative Energy	Supplied reactive energy in mWh	UINT64	RO	

**Index F60B PMX Total Statistic Power**

Index (hex)	Name	Meaning	Data type	Flags	Default
F60B:0	PMX Total Statistic Power	Max. subindex	UINT8	RO	0x19 (25 <sub>dec</sub> )
F60B:11	Active Power Avg	Average total active power during the last interval in W	REAL32	RO	0x00000000 (0 <sub>dec</sub> )
F60B:12	Active Power Min	Minimum total active power in the last interval in W	REAL32	RO	0x00000000 (0 <sub>dec</sub> )
F60B:13	Active Power Max	Maximum total active power in the last interval in W	REAL32	RO	0x00000000 (0 <sub>dec</sub> )
F60B:14	Apparent Power Avg	Average total apparent power during the last interval in VA	REAL32	RO	0x00000000 (0 <sub>dec</sub> )
F60B:15	Apparent Power Min	Minimum total apparent power in the last interval in VA	REAL32	RO	0x00000000 (0 <sub>dec</sub> )
F60B:16	Apparent Power Max	Maximum total apparent power in the last interval in VA	REAL32	RO	0x00000000 (0 <sub>dec</sub> )
F60B:17	Reactive Power Avg	Average total reactive power average during the last interval in Var	REAL32	RO	0x00000000 (0 <sub>dec</sub> )
F60B:18	Reactive Power Min	Minimum total reactive power in the last interval in Var	REAL32	RO	0x00000000 (0 <sub>dec</sub> )
F60B:19	Reactive Power Max	Maximum total reactive power in the last interval in Var	REAL32	RO	0x00000000 (0 <sub>dec</sub> )

**Index F60C PMX Total Statistic PQF**

Index (hex)	Name	Meaning	Data type	Flags	Default
F60C:0	PMX Total Statistic PQF	Max. subindex	UINT8	RO	0x13 (19 <sub>dec</sub> )
F60C:11	PQF Avg	Average value of the power quality factor during the last interval	REAL32	RO	0x00000000 (0 <sub>dec</sub> )
F60C:12	PQF Min	Minimum power quality factor in the last interval	REAL32	RO	0x00000000 (0 <sub>dec</sub> )
F60C:13	PQF Max	Maximum power quality factor in the last interval	REAL32	RO	0x00000000 (0 <sub>dec</sub> )

**Index F60D PMX Total Interval Energy**

Index (hex)	Name	Meaning	Data type	Flags	Default
F60D:0	PMX Total Interval Energy	Max. subindex	UINT8	RO	0x19 (25 <sub>dec</sub> )
F60D:10	TxPDO Toggle	The TxPDO toggle is toggled by the slave when the data of the associated TxPDO is updated.	BOOLEAN	RO	0x00 (0 <sub>dec</sub> )
F60D:11	Active Energy	Recorded total active energy during the last interval in mWh	REAL32	RO	0x00000000 (0 <sub>dec</sub> )
F60D:12	Active Energy Positive	Received total active energy during the last interval in mWh	REAL32	RO	0x00000000 (0 <sub>dec</sub> )
F60D:13	Active Energy Negative	Supplied total active energy during at last interval in mWh	REAL32	RO	0x00000000 (0 <sub>dec</sub> )
F60D:14	Apparent Energy	Recorded total apparent energy during the last interval in mWh	REAL32	RO	0x00000000 (0 <sub>dec</sub> )
F60D:15	Apparent Energy Positive	Received total apparent energy during the last interval in mWh	REAL32	RO	0x00000000 (0 <sub>dec</sub> )
F60D:16	Apparent Energy Negative	Supplied total apparent energy during the last interval in mWh	REAL32	RO	0x00000000 (0 <sub>dec</sub> )
F60D:17	Reactive Energy	Recorded total reactive energy during the last interval in mWh	REAL32	RO	0x00000000 (0 <sub>dec</sub> )
F60D:18	Reactive Energy Positive	Received total reactive energy during the last interval in mWh	REAL32	RO	0x00000000 (0 <sub>dec</sub> )
F60D:19	Reactive Energy Negative	Supplied total reactive energy during the last interval in mWh	REAL32	RO	0x00000000 (0 <sub>dec</sub> )

**Index F612 PMX Total Active Reduced**

Index (hex)	Name	Meaning	Data type	Flags	Default
F612:0	PMX Total Active Reduced	Max. subindex	UINT8	RO	0x12 (18 <sub>dec</sub> )
F612:12	Active Energy	Active energy in mWh	INT64	RO	0x00000000 (0 <sub>dec</sub> )

**Index F613 PMX Total Apparent Reduced**

Index (hex)	Name	Meaning	Data type	Flags	Default
F613:0	PMX Total Apparent Reduced	Max. subindex	UINT8	RO	0x12 (18 <sub>dec</sub> )
F613:12	Apparent Energy	Apparent energy in mVAh	INT64	RO	0x00000000 (0 <sub>dec</sub> )

**Index F614 PMX Total Reactive Reduced**

Index (hex)	Name	Meaning	Data type	Flags	Default
F614:0	PMX Total Reactive Reduced	Max. subindex	UINT8	RO	0x12 (18 <sub>dec</sub> )
F614:12	Reactive Energy	Reactive energy in mvarh	INT64	RO	0x00000000 (0 <sub>dec</sub> )

**Index F615 PMX Total Interval Energy Reduced**

Index (hex)	Name	Meaning	Data type	Flags	Default
F615:0	PMX Total Interval Energy Reduced	Max. Subindex	UINT8	RO	0x13 (19 <sub>dec</sub> )
F615:10	TxPDO Toggle	The TxPDO toggle is toggled by the slave when the data of the associated TxPDO is updated.	BOOLEAN	RO	0x00 (0 <sub>dec</sub> )
F615:11	Active Energy	Recorded total active energy during the last interval in mWh	REAL32	RO	0x00000000 (0 <sub>dec</sub> )
F615:12	Apparent Energy	Recorded total apparent energy during the last interval in mVAh	REAL32	RO	0x00000000 (0 <sub>dec</sub> )
F615:13	Reactive Energy	Recorded total reactive energy during the last interval in mvarh	REAL32	RO	0x00000000 (0 <sub>dec</sub> )

**6.6.1.5 Output data****Index F701 PMX Interval**

Index (hex)	Name	Meaning	Data type	Flags	Default
F701:0	PMX Interval	Max. subindex	UINT8	RO	0x01 (1 <sub>dec</sub> )
F701:01	Reset Interval	Manual option for resetting the interval (see basic function principles – Statistical evaluation)	BOOLEAN	RO	0x00 (0 <sub>dec</sub> )

**6.6.1.6 Information and diagnostic data****Index 90n0 PMX info data voltage (for ch.1, n = 0; ch.2, n = 1; ch.3, n = 2)**

Index (hex)	Name	Meaning	Data type	Flags	Default
90n0:0	PMX Info data Voltage	Max. subindex	UINT8	RO	0x13 (19 <sub>dec</sub> )
90n0:11	Voltage Peak	Peak value of the instantaneous voltage in the last interval in V	REAL32	RO	0x00000000 (0 <sub>dec</sub> )
90n0:12	Voltage RMS Minimum	Minimum RMS value of the voltage in the last interval in V	REAL32	RO	0x00000000 (0 <sub>dec</sub> )
90n0:13	Voltage RMS Maximum	Maximum RMS value of the voltage in the last interval in V	REAL32	RO	0x00000000 (0 <sub>dec</sub> )

**Index 90n1 PMX info data current (for ch.1, n = 0; ch.2, n = 1; ch.3, n = 2)**

Index (hex)	Name	Meaning	Data type	Flags	Default
90n1:0	PMX Info data Current	Max. subindex	UINT8	RO	0x13 (19 <sub>dec</sub> )
90n1:11	Current Peak	Peak value of the instantaneous current in the last interval in A	REAL32	RO	0x00000000 (0 <sub>dec</sub> )
90n1:12	Current RMS Minimum	Minimum RMS value of the current in the last interval in A	REAL32	RO	0x00000000 (0 <sub>dec</sub> )
90n1:13	Current RMS Maximum	Maximum RMS value of the current in the last interval in A	REAL32	RO	0x00000000 (0 <sub>dec</sub> )

**Index 90n2 PMX info data power (for ch.1, n = 0; ch.2, n = 1; ch.3, n = 2)**

Index (hex)	Name	Meaning	Data type	Flags	Default
90n2:0	PMX Info data Power	Max. subindex	UINT8	RO	0x1B (27 <sub>dec</sub> )
90n2:11	Active Power Avg	Average active phase power during the last interval in W	REAL32	RO	0x00000000 (0 <sub>dec</sub> )
90n2:12	Active Power Min	Minimum active phase power during the last interval in W	REAL32	RO	0x00000000 (0 <sub>dec</sub> )
90n2:13	Active Power Max	Maximum active phase power during the last interval in W	REAL32	RO	0x00000000 (0 <sub>dec</sub> )
90n2:14	Apparent Power Avg	Average apparent phase power during the last interval in VA	REAL32	RO	0x00000000 (0 <sub>dec</sub> )
90n2:15	Apparent Power Min	Minimum apparent phase power during the last interval in VA	REAL32	RO	0x00000000 (0 <sub>dec</sub> )
90n2:16	Apparent Power Max	Maximum apparent phase power during the last interval in VA	REAL32	RO	0x00000000 (0 <sub>dec</sub> )
90n2:17	Reactive Power Avg	Average reactive phase power during the last interval in var	REAL32	RO	0x00000000 (0 <sub>dec</sub> )
90n2:18	Reactive Power Min	Minimum reactive phase power during the last interval in var	REAL32	RO	0x00000000 (0 <sub>dec</sub> )
90n2:19	Reactive Power Max	Maximum reactive phase power during the last interval in var	REAL32	RO	0x00000000 (0 <sub>dec</sub> )
90n2:1A	Phi	Phase angle in degrees (between voltage U_Lx and the corresponding current I_Lx)	REAL32	RO	0x00000000 (0 <sub>dec</sub> )
90n2:1B	Phase angle	Phase difference in degrees (between different voltages U_Lx and U_Ly)	REAL32	RO	0x00000000 (0 <sub>dec</sub> )

**Index 90n3 PMX info data energy (for ch.1, n = 0; ch.2, n = 1; ch.3, n = 2)**

Index (hex)	Name	Meaning	Data type	Flags	Default
90n3:0	PMX info data energy ch.1	Max. subindex	UINT8	RO	0x19 (25 <sub>dec</sub> )
90n3:11	Active Energy	Recorded active phase energy in mWh	INT64	RO	
90n3:12	Positive Active Energy	Received active phase energy in mWh	UINT64	RO	
90n3:13	Negative Active Energy	Supplied active phase energy in mWh	UINT64	RO	
90n3:14	Apparent Energy	Recorded apparent phase energy in mWh	INT64	RO	
90n3:15	Positive Apparent Energy	Received apparent phase energy in mWh	UINT64	RO	
90n3:16	Negative Apparent Energy	Supplied apparent phase energy in mWh	UINT64	RO	
90n3:17	Reactive Energy	Recorded reactive phase energy in mWh	INT64	RO	
90n3:18	Positive Reactive Energy	Received reactive phase energy in mWh	UINT64	RO	
90n3:19	Negative Reactive Energy	Supplied reactive phase energy in mWh	UINT64	RO	

**Index A0n0 PMX Diag data (for ch.1, n = 0; ch.2, n = 1; ch.3, n = 2)**

Index (hex)	Name	Meaning	Data type	Flags	Default
A0n0:0	PMX diag data ch.1	Max. subindex	UINT8	RO	0x12 (18 <sub>dec</sub> )
A0n0:11	Saturation Time Voltage	Time (in 0.1 ms) in which the terminal has measured an overvoltage.	UINT32	RO	0x00000000 (0 <sub>dec</sub> )
A0n0:12	Saturation Time Current	Time (in 0.1 ms) in which the terminal has measured an overcurrent.	UINT32	RO	0x00000000 (0 <sub>dec</sub> )

**Index F081 Download revision**

Index (hex)	Name	Meaning	Data type	Flags	Default
F081:0	Download revision	Max. subindex	UINT8	RO	0x01 (1 <sub>dec</sub> )
F010:01	Revision number	Configured revision of the terminal, (see note [► 139])	UINT32	RW	0x00000000 (0 <sub>dec</sub> )

**Index F80F PM Vendor data**

Index (hex)	Name	Meaning	Data type	Flags	Default
F80F:0	PMX Vendor data	Max. subindex	UINT8	RO	0x11 (17 <sub>dec</sub> )
F80F:11	Type	Vendor-specific data	UINT32	RW	0x00000000 (0 <sub>dec</sub> )

**Index F902 PMX Total Info data Power**

Index (hex)	Name	Meaning	Data type	Flags	Default
F902:0	PMX Total Info data Power	Max subindex	UINT8	RO	0x19 (25 <sub>dec</sub> )
F902:11	Active Power Avg	Average total active power during the last interval in W	REAL32	RO	0x00000000 (0 <sub>dec</sub> )
F902:12	Active Power Min	Minimum total active power in the last interval in W	REAL32	RO	0x00000000 (0 <sub>dec</sub> )
F902:13	Active Power Max	Maximum total active power in the last interval in W	REAL32	RO	0x00000000 (0 <sub>dec</sub> )
F902:14	Apparent Power Avg	Average total apparent power during the last interval in VA	REAL32	RO	0x00000000 (0 <sub>dec</sub> )
F902:15	Apparent Power Min	Minimum total apparent power in the last interval in VA	REAL32	RO	0x00000000 (0 <sub>dec</sub> )
F902:16	Apparent Power Max	Maximum total apparent power in the last interval in VA	REAL32	RO	0x00000000 (0 <sub>dec</sub> )
F902:17	Reactive Power Avg	Average total reactive power average during the last interval in var	REAL32	RO	0x00000000 (0 <sub>dec</sub> )
F902:18	Reactive Power Min	Minimum total reactive power in the last interval in var	REAL32	RO	0x00000000 (0 <sub>dec</sub> )
F902:19	Reactive Power Max	Maximum total reactive power in the last interval in var	REAL32	RO	0x00000000 (0 <sub>dec</sub> )

**Index F903 PMX Total Info data Energy**

Index (hex)	Name	Meaning	Data type	Flags	Default
F903:0	PMX Total Info data Energy	Max. subindex	UINT8	RO	0x19 (25 <sub>dec</sub> )
F903:11	Active Energy	Recorded total active energy in mWh	INT64	RO	
F903:12	Positive Active Energy	Received total active energy in mWh	UINT64	RO	
F903:13	Negative Active Energy	Supplied total active energy in mWh	UINT64	RO	
F903:14	Apparent Energy	Recorded total apparent energy in mWh	INT64	RO	
F903:15	Positive Apparent Energy	Received total apparent energy in mWh	UINT64	RO	
F903:16	Negative Apparent Energy	Supplied total apparent energy in mWh	UINT64	RO	
F903:17	Reactive Energy	Recorded total reactive energy in mWh	INT64	RO	
F903:18	Positive Reactive Energy	Received total reactive energy in mWh	UINT64	RO	
F903:19	Negative Reactive Energy	Supplied total reactive energy in mWh	UINT64	RO	

**Index F904 PMX Total Info data PQF**

Index (hex)	Name	Meaning	Data type	Flags	Default
F904:0	PMX Total Info data PQF	Max. subindex	UINT8	RO	0x13 (19 <sub>dec</sub> )
F904:11	PQF Avg	Average value of the power quality factor during the last interval	REAL32	RO	0x00000000 (0 <sub>dec</sub> )
F904:12	PQF Min	Minimum power quality factor in the last interval	REAL32	RO	0x00000000 (0 <sub>dec</sub> )
F904:13	PQF Max	Maximum power quality factor in the last interval	REAL32	RO	0x00000000 (0 <sub>dec</sub> )

**Index FA00 PMX Diag data**

Index (hex)	Name	Meaning	Data type	Flags	Default
FA00:0	PMX Diag data	Max. subindex	UINT8	RO	0x13 (19 <sub>dec</sub> )
FA00:11	Min CPU Die Temperature	Minimum CPU temperature measured so far	REAL32	RO	0x00000000 (0 <sub>dec</sub> )
FA00:12	Max CPU Die Temperature	Maximum CPU temperature measured so far	REAL32	RO	0x00000000 (0 <sub>dec</sub> )
FA00:13	EBUS Voltage	Current E-bus voltage	REAL32	RO	0x00000000 (0 <sub>dec</sub> )

## 6.6.1.7 Standard objects

### Standard objects (0x1000-0x1FFF)

The standard objects have the same meaning for all EtherCAT slaves.

#### Index 1000 Device type

Index (hex)	Name	Meaning	Data type	Flags	Default
1000:0	Device type	Device type of the EtherCAT slave: The Lo-Word contains the CoE profile used (5001). The Hi-Word contains the module profile according to the modular device profile.	UINT32	RO	0x01551389 (22352777 <sub>dec</sub> )

#### Index 1008 Device name

Index (hex)	Name	Meaning	Data type	Flags	Default
1008:0	Device name	Device name of the EtherCAT slave	STRING	RO	EL34xx

#### Index 1009 Hardware version

Index (hex)	Name	Meaning	Data type	Flags	Default
1009:0	Hardware version	Hardware version of the EtherCAT slave	STRING	RO	

#### Index 100A Software Version

Index (hex)	Name	Meaning	Data type	Flags	Default
100A:0	Software version	Firmware version of the EtherCAT slave	STRING	RO	

#### Index 100B Bootloader version

Index (hex)	Name	Meaning	Data type	Flags	Default
100B:0	Bootloader version	Bootloader version	STRING	RO	

#### Index 1018 Identity

Index (hex)	Name	Meaning	Data type	Flags	Default
1018:0	Identity	Length of this object	UINT8	RO	0x04 (4 <sub>dec</sub> )
1018:01	Vendor ID	Vendor ID of the EtherCAT slave	UINT32	RO	0x00000002 (2 <sub>dec</sub> )
1018:02	Product code	Product code of the EtherCAT slave	UINT32	RO	0x0D5F3052 (224342098 <sub>dec</sub> )
1018:03	Revision	Revision number of the EtherCAT slave; the low word (bit 0-15) indicates the special terminal number, the high word (bit 16-31) refers to the device description	UINT32	RO	0x00100000 (1048576 <sub>dec</sub> )
1018:04	Serial number	Serial number of the EtherCAT slave; the low byte (bit 0-7) of the low word contains the year of production, the high byte (bit 8-15) of the low word contains the week of production, the high word (bit 16-31) is 0	UINT32	RO	e.g. 0x00001E06 (KW 30/2006)

#### Index 10F0 Backup parameter

Index (hex)	Name	Meaning	Data type	Flags	Default
10F0:0	Backup parameter	Length of this object	UINT8	RO	0x01
10F0:01	Checksum	Checksum	UINT32	RW	0x00000000 (0 <sub>dec</sub> )

**Index 10F3 Diagnosis History**

Index	Name	Meaning	Data type	Flags	Default
10F3:0	Diagnosis History	Maximum subindex	UINT8	RO	0x15 (21 <sub>dec</sub> )
10F3:01	Maximum Messages	Maximum number of stored messages. A maximum of 50 messages can be stored	UINT8	RO	0x00 (0 <sub>dec</sub> )
10F3:02	Newest Message	Subindex of the latest message	UINT8	RO	0x00 (0 <sub>dec</sub> )
10F3:03	Newest Acknowledged Message	Subindex of the last confirmed message	UINT8	RW	0x00 (0 <sub>dec</sub> )
10F3:04	New Messages Available	Indicates that a new message is available	BOOLEAN	RO	0x00 (0 <sub>dec</sub> )
10F3:05	Flags	not used	UINT16	RW	0x0000 (0 <sub>dec</sub> )
10F3:06	Diagnosis Message 001	Message 1	OCTET STRING[28]	RO	{0}
...	...	...	...	...	...
10F3:15	Diagnosis Message 016	Message 16	OCTET STRING[28]	RO	{0}

**Index 10F8 Actual Time Stamp**

Index	Name	Meaning	Data type	Flags	Default
10F8:0	Actual Time Stamp	Time stamp	UINT64	RO	0x0000000000000000 (0 <sub>dec</sub> )

**Index 10F9 Time Distribution Object**

Index	Name	Meaning	Data type	Flags	Default
10F9:0	Time Distribution Object	Max Subindex	UINT8	RO	0x01 (1 <sub>dec</sub> )
10F9:01	Distributed Time Value	Object for time distribution by the EtherCAT Master	INT64	RW	

**Index 1601 Total RxPDO-Map Interval**

Index (hex)	Name	Meaning	Data type	Flags	Default
1601:0	Total RxPDO-Map Interval	PDO Mapping RxPDO 2	UINT8	RO	0x02 (2 <sub>dec</sub> )
1601:01	SubIndex 001	1. PDO Mapping entry (object 0xF701 (PMX Interval), entry 0x01 (Reset Interval))	UINT32	RO	0xF701:01, 1
1601:02	SubIndex 002	2. PDO Mapping entry (15 bits align)	UINT32	RO	0x0000:00, 15

**Index 1App TxPDO-Map Status (for L1, pp = 00; L2, pp = 0A; L3, pp = 14)**

Index (hex)	Name	Meaning	Data type	Flags	Default
1App:0	TxPDO-Map Status	PDO Mapping TxPDO	UINT8	RO	0x09 (9 <sub>dec</sub> )
1App:01	SubIndex 001	1. PDO Mapping entry (1 bits align)	UINT32	RO	0x0000:00, 1
1App:02	SubIndex 002	2. PDO Mapping entry (object 0x60n0 (PMX Status), entry 0x02 (Overvoltage))	UINT32	RO	0x60n0:02, 1**
1App:03	SubIndex 003	3. PDO Mapping entry (object 0x60n0 (PMX Status), entry 0x03 (Overcurrent))	UINT32	RO	0x60n0:03, 1**
1App:04	SubIndex 004	4. PDO Mapping entry (object 0x60n0 (PMX Status), entry 0x04 (Inaccurate Voltage))	UINT32	RO	0x60n0:04, 1**
1App:05	SubIndex 005	5. PDO Mapping entry (object 0x60n0 (PMX Status), entry 0x05 (Inaccurate Current))	UINT32	RO	0x60n0:05, 1**
1App:06	SubIndex 006	6. PDO Mapping entry (object 0x60n0 (PMX Status), entry 0x06 (Voltage Guard Warning))	UINT32	RO	0x60n0:06, 1**
1App:07	SubIndex 007	7. PDO Mapping entry (object 0x60n0 (PMX Status), entry 0x07 (Voltage Guard Error))	UINT32	RO	0x60n0:07, 1**
1App:08	SubIndex 008	8. PDO Mapping entry (8 bits align)	UINT32	RO	0x0000:00, 8**
1App:09	SubIndex 009	9. PDO Mapping entry (object 0x60n0 (PMX Status), entry 0x10 (TxPDO Toggle))	UINT32	RO	0x60n0:10, 1**

\*\* ) for L1, n = 0; L2, n = 1; L3, n = 2)

**Index 1App TxPDO-Map Energy (for L1, pp = 03; L2, pp = 0D; L3, pp = 17)**

Index (hex)	Name	Meaning	Data type	Flags	Default
1App:0	TxPDO-Map Energy	PDO Mapping TxPDO	UINT8	RO	0x03 (3 <sub>dec</sub> )
1App:01	SubIndex 001	1. PDO Mapping entry (object 0x60n4 (PMX Energy), entry 0x11 (Active Energy))	UINT32	RO	0x60n4:11, 64**
1App:02	SubIndex 002	2. PDO Mapping entry (object 0x60n4 (PMX Energy), entry 0x12 (Apparent Energy))	UINT32	RO	0x60n4:12, 64**
1App:03	SubIndex 003	3. PDO Mapping entry (object 0x60n4 (PMX Energy), entry 0x13 (Reactive Energy))	UINT32	RO	0x60n4:13, 64**

\*\* ) for L1, n = 0; L2, n = 1; L3, n = 2)

**Index 1App TxPDO-Map Statistic Voltage (for L1, pp = 06; L2, pp = 10; L3, pp = 1A)**

Index (hex)	Name	Meaning	Data type	Flags	Default
1App:0	TxPDO-Map Statistic Voltage	PDO Mapping TxPDO	UINT8	RO	0x03 (3 <sub>dec</sub> )
1App:01	SubIndex 001	1. PDO Mapping entry (object 0x60n8 (PMX Statistic Voltage), entry 0x11 (Voltage Peak))	UINT32	RO	0x60n8:11, 32**
1App:02	SubIndex 002	2. PDO Mapping entry (object 0x60n8 (PMX Statistic Voltage), entry 0x12 (Voltage RMS Minimum))	UINT32	RO	0x60n8:12, 32**
1App:03	SubIndex 003	3. PDO Mapping entry (object 0x60n8 (PMX Statistic Voltage), entry 0x13 (Voltage RMS Maximum))	UINT32	RO	0x60n8:13, 32**

\*\* ) for L1, n = 0; L2, n = 1; L3, n = 2)

**Index 1App TxPDO-Map Statistic Current (for L1, pp = 07; L2, pp = 11; L3, pp = 1B)**

Index (hex)	Name	Meaning	Data type	Flags	Default
1App:0	L1 TxPDO-Map Statistic Current	PDO Mapping TxPDO 8	UINT8	RO	0x03 (3 <sub>dec</sub> )
1App:01	SubIndex 001	1. PDO Mapping entry (object 0x60n9 (PMX Statistic Current), entry 0x11 (Current Peak))	UINT32	RO	0x60n9:11, 32**
1App:02	SubIndex 002	2. PDO Mapping entry (object 0x60n9 (PMX Statistic Current), entry 0x12 (Current RMS Minimum))	UINT32	RO	0x60n9:12, 32**
1App:03	SubIndex 003	3. PDO Mapping entry (object 0x60n9 (PMX Statistic Current), entry 0x13 (Current RMS Maximum))	UINT32	RO	0x60n9:13, 32**

\*\* ) for L1, n = 0; L2, n = 1; L3, n = 2)



**Index 1App TxPDO-Map Statistic Power (for L1, pp = 08; L2, pp = 12; L3, pp = 1C)**

Index (hex)	Name	Meaning	Data type	Flags	Default
1App:0	TxPDO-Map Statistic Power	PDO Mapping TxPDO	UINT8	RO	0x09 (9 <sub>dec</sub> )
1App:01	SubIndex 001	1. PDO Mapping entry (object 0x60nA (PMX Statistic Power), entry 0x11 (Active Power Avg))	UINT32	RO	0x60nA:11, 32**
1App:02	SubIndex 002	2. PDO Mapping entry (object 0x60nA (PMX Statistic Power), entry 0x12 (Active Power Min))	UINT32	RO	0x60nA:12, 32**
1App:03	SubIndex 003	3. PDO Mapping entry (object 0x60nA (PMX Statistic Power), entry 0x13 (Active Power Max))	UINT32	RO	0x60nA:13, 32**
1App:04	SubIndex 004	4. PDO Mapping entry (object 0x60nA (PMX Statistic Power), entry 0x14 (Apparent Power Avg))	UINT32	RO	0x60nA:14, 32**
1App:05	SubIndex 005	5. PDO Mapping entry (object 0x60nA (PMX Statistic Power), entry 0x15 (Apparent Power Max))	UINT32	RO	0x60nA:15, 32**
1App:06	SubIndex 006	6. PDO Mapping entry (object 0x60nA (PMX Statistic Power), entry 0x16 (Reactive Power Avg))	UINT32	RO	0x60nA:16, 32**
1App:07	SubIndex 007	7. PDO Mapping entry (object 0x60nA (PMX Statistic Power), entry 0x17 (Reactive Power Min))	UINT32	RO	0x60nA:17, 32**
1App:08	SubIndex 008	8. PDO Mapping entry (object 0x60nA (PMX Statistic Power), entry 0x18 (Reactive Power Max))	UINT32	RO	0x60nA:18, 32**
1App:09	SubIndex 009	9. PDO Mapping entry (object 0x60nA (PMX Statistic Power), entry 0x19 (Apparent Power Min))	UINT32	RO	0x60nA:19, 32**

\*\*): for L1, n = 0; L2, n = 1; L3, n = 2)

**Index 1A1E Total TxPDO-Map Total Status**

Index (hex)	Name	Meaning	Data type	Flags	Default
1A1E:0	Total TxPDO-Map Total Status	PDO Mapping TxPDO 31	UINT8	RO	0x10 (16 <sub>dec</sub> )
1A1E:01	SubIndex 001	1. PDO Mapping entry (object 0xF600 (PMX Total Status), entry 0x01 (System State))	UINT32	RO	0xF600:01, 1
1A1E:02	SubIndex 002	2. PDO Mapping entry (object 0xF600 (PMX Total Status), entry 0x02 (Grid Direction))	UINT32	RO	0xF600:02, 1
1A1E:03	SubIndex 003	3. PDO Mapping entry (object 0xF600 (PMX Total Status), entry 0x03 (Frequency Guard Warning))	UINT32	RO	0xF600:03, 1
1A1E:04	SubIndex 004	4. PDO Mapping entry (object 0xF600 (PMX Total Status), entry 0x04 (Frequency Guard Error))	UINT32	RO	0xF600:04, 1
1A1E:05	SubIndex 005	5. PDO Mapping entry (object 0xF600 (PMX Total Status), entry 0x05 (Neutral Current Guard Warning))	UINT32	RO	0xF600:05, 1
1A1E:06	SubIndex 006	6. PDO Mapping entry (object 0xF600 (PMX Total Status), entry 0x06 (Neutral Current Guard Error))	UINT32	RO	0xF600:06, 1
1A1E:07	SubIndex 007	7. PDO Mapping entry (object 0xF600 (PMX Total Status), entry 0x07 (Active Power Guard Warning))	UINT32	RO	0xF600:07, 1
1A1E:08	SubIndex 008	8. PDO Mapping entry (object 0xF600 (PMX Total Status), entry 0x08 (Active Power Guard Error))	UINT32	RO	0xF600:08, 1
1A1E:09	SubIndex 009	9. PDO Mapping entry (object 0xF600 (PMX Total Status), entry 0x09 (Apparent Power Guard Warning))	UINT32	RO	0xF600:09, 1
1A1E:0A	SubIndex 010	10. PDO Mapping entry (object 0xF600 (PMX Total Status), entry 0x0A (Apparent Power Guard Error))	UINT32	RO	0xF600:0A, 1
1A1E:0B	SubIndex 011	11. PDO Mapping entry (object 0xF600 (PMX Total Status), entry 0x0B (Power Quality Guard Warning))	UINT32	RO	0xF600:0B, 1
1A1E:0C	SubIndex 012	12. PDO Mapping entry (object 0xF600 (PMX Total Status), entry 0x0C (Power Quality Guard Error))	UINT32	RO	0xF600:0C, 1
1A1E:0D	SubIndex 013	13. PDO Mapping entry (2 bits align)	UINT32	RO	0x0000:00, 2
1A1E:0E	SubIndex 014	14. PDO Mapping entry (object 0xF600 (PMX Total Status), entry 0x0E (TxPDO State))	UINT32	RO	0xF600:0E, 1
1A1E:0F	SubIndex 015	15. PDO Mapping entry (object 0xF600 (PMX Total Status), entry 0x10 (TxPDO Toggle))	UINT32	RO	0xF600:10, 1
1A1E:10	SubIndex 016	16. PDO Mapping entry (object 0xF600 (PMX Total Status), entry 0x11 (Power Quality Factor))	UINT32	RO	0xF600:11, 32

**Index 1A20 Total TxPDO-Map Total Advanced**

Index (hex)	Name	Meaning	Data type	Flags	Default
1A20:0	Total TxPDO-Map Total Advanced	PDO Mapping TxPDO 33	UINT8	RO	0x03 (3 <sub>dec</sub> )
1A20:01	SubIndex 001	1. PDO Mapping entry (object 0xF602 (PMX Total Advanced), entry 0x01 (Unbalance Guard Warning))	UINT32	RO	0xF602:01, 1
1A20:02	SubIndex 002	2. PDO Mapping entry (object 0xF602 (PMX Total Advanced), entry 0x02 (Unbalance Guard Error))	UINT32	RO	0xF602:02, 1
1A20:03	SubIndex 003	3. PDO Mapping entry (14 bits align)	UINT32	RO	0x0000:00, 14

**Index 1A21 Total TxPDO-Map Total Active**

Index (hex)	Name	Meaning	Data type	Flags	Default
1A21:0	Total TxPDO-Map Total Active	PDO Mapping TxPDO 34	UINT8	RO	0x04 (4 <sub>dec</sub> )
1A21:01	SubIndex 001	1. PDO Mapping entry (32 bits align)	UINT32	RO	0x0000:00, 32
1A21:02	SubIndex 002	2. PDO Mapping entry (object 0xF603 (PMX Total Active), entry 0x12 (Active Energy))	UINT32	RO	0xF603:12, 64
1A21:03	SubIndex 003	3. PDO Mapping entry (object 0xF603 (PMX Total Active), entry 0x13 (Active Positive Energy))	UINT32	RO	0xF603:13, 64
1A21:04	SubIndex 004	4. PDO Mapping entry (object 0xF603 (PMX Total Active), entry 0x14 (Active Negative Energy))	UINT32	RO	0xF603:14, 64

**Index 1A22 Total TxPDO-Map Total Apparent**

Index (hex)	Name	Meaning	Data type	Flags	Default
1A22:0	Total TxPDO-Map Total Apparent	PDO Mapping TxPDO 35	UINT8	RO	0x04 (4 <sub>dec</sub> )
1A22:01	SubIndex 001	1. PDO Mapping entry (32 bits align)	UINT32	RO	0x0000:00, 32
1A22:02	SubIndex 002	2. PDO Mapping entry (object 0xF605 (PMX Total Apparent), entry 0x12 (Apparent Energy))	UINT32	RO	0xF605:12, 64
1A22:03	SubIndex 003	3. PDO Mapping entry (object 0xF605 (PMX Total Apparent), entry 0x13 (Apparent Positive Energy))	UINT32	RO	0xF605:13, 64
1A22:04	SubIndex 004	4. PDO Mapping entry (object 0xF605 (PMX Total Apparent), entry 0x14 (Apparent Negative Energy))	UINT32	RO	0xF605:14, 64

**Index 1A23 Total TxPDO-Map Total Reactive**

Index (hex)	Name	Meaning	Data type	Flags	Default
1A23:0	Total TxPDO-Map Total Reactive	PDO Mapping TxPDO 36	UINT8	RO	0x04 (4 <sub>dec</sub> )
1A23:01	SubIndex 001	1. PDO Mapping entry (32 bits align)	UINT32	RO	0x0000:00, 32
1A23:02	SubIndex 002	2. PDO Mapping entry (object 0xF607 (PMX Total Reactive), entry 0x12 (Reactive Energy))	UINT32	RO	0xF607:12, 64
1A23:03	SubIndex 003	3. PDO Mapping entry (object 0xF607 (PMX Total Reactive), entry 0x13 (Reactive Positive Energy))	UINT32	RO	0xF607:13, 64
1A23:04	SubIndex 004	4. PDO Mapping entry (object 0xF607 (PMX Total Reactive), entry 0x14 (Reactive Negative Energy))	UINT32	RO	0xF607:14, 64

**Index 1A26 Total TxPDO-Map Total Statistic Power**

Index (hex)	Name	Meaning	Data type	Flags	Default
1A26:0	Total TxPDO-Map Total Statistic Power	PDO Mapping TxPDO 39	UINT8	RO	0x09 (9 <sub>dec</sub> )
1A26:01	SubIndex 001	1. PDO Mapping entry (object 0xF60B (PMX Total Statistic Power), entry 0x11 (Active Power Avg))	UINT32	RO	0xF60B:11, 32
1A26:02	SubIndex 002	2. PDO Mapping entry (object 0xF60B (PMX Total Statistic Power), entry 0x12 (Active Power Min))	UINT32	RO	0xF60B:12, 32
1A26:03	SubIndex 003	3. PDO Mapping entry (object 0xF60B (PMX Total Statistic Power), entry 0x13 (Active Power Max))	UINT32	RO	0xF60B:13, 32
1A26:04	SubIndex 004	4. PDO Mapping entry (object 0xF60B (PMX Total Statistic Power), entry 0x14 (Apparent Power Avg))	UINT32	RO	0xF60B:14, 32
1A26:05	SubIndex 005	5. PDO Mapping entry (object 0xF60B (PMX Total Statistic Power), entry 0x15 (Apparent Power Min))	UINT32	RO	0xF60B:15, 32
1A26:06	SubIndex 006	6. PDO Mapping entry (object 0xF60B (PMX Total Statistic Power), entry 0x16 (Apparent Power Max))	UINT32	RO	0xF60B:16, 32
1A26:07	SubIndex 007	7. PDO Mapping entry (object 0xF60B (PMX Total Statistic Power), entry 0x17 (Reactive Power Avg))	UINT32	RO	0xF60B:17, 32
1A26:08	SubIndex 008	8. PDO Mapping entry (object 0xF60B (PMX Total Statistic Power), entry 0x18 (Reactive Power Min))	UINT32	RO	0xF60B:18, 32
1A26:09	SubIndex 009	9. PDO Mapping entry (object 0xF60B (PMX Total Statistic Power), entry 0x19 (Reactive Power Max))	UINT32	RO	0xF60B:19, 32

**Index 1A27 Total TxPDO-Map Total Statistic PQF**

Index (hex)	Name	Meaning	Data type	Flags	Default
1A27:0	Total TxPDO-Map Total Statistic PQF	PDO Mapping TxPDO 40	UINT8	RO	0x03 (3 <sub>dec</sub> )
1A27:01	SubIndex 001	1. PDO Mapping entry (object 0xF60C (PMX Total Statistic PQF), entry 0x11 (PQF Avg))	UINT32	RO	0xF60C:11, 32
1A27:02	SubIndex 002	2. PDO Mapping entry (object 0xF60C (PMX Total Statistic PQF), entry 0x12 (PQF Min))	UINT32	RO	0xF60C:12, 32
1A27:03	SubIndex 003	3. PDO Mapping entry (object 0xF60C (PMX Total Statistic PQF), entry 0x13 (PQF Max))	UINT32	RO	0xF60C:13, 32

**Index 1A28 Total TxPDO-Map Total Interval Energy**

Index (hex)	Name	Meaning	Data type	Flags	Default
1A28:0	Total TxPDO-Map Total Interval Energy	PDO Mapping TxPDO 41	UINT8	RO	0x0B (11 <sub>dec</sub> )
1A28:01	SubIndex 001	1. PDO Mapping entry (15 bits align)	UINT32	RO	0x0000:00, 15
1A28:02	SubIndex 002	2. PDO Mapping entry (object 0xF60D (PMX Total Interval Energy), entry 0x10 (TxPDO Toggle))	UINT32	RO	0xF60D:10, 1
1A28:03	SubIndex 003	3. PDO Mapping entry (object 0xF60D (PMX Total Interval Energy), entry 0x11 (Active Energy))	UINT32	RO	0xF60D:11, 32
1A28:04	SubIndex 004	4. PDO Mapping entry (object 0xF60D (PMX Total Interval Energy), entry 0x12 (Active Energy Positive))	UINT32	RO	0xF60D:12, 32
1A28:05	SubIndex 005	5. PDO Mapping entry (object 0xF60D (PMX Total Interval Energy), entry 0x13 (Active Energy Negative))	UINT32	RO	0xF60D:13, 32
1A28:06	SubIndex 006	6. PDO Mapping entry (object 0xF60D (PMX Total Interval Energy), entry 0x14 (Apparent Energy))	UINT32	RO	0xF60D:14, 32
1A28:07	SubIndex 007	7. PDO Mapping entry (object 0xF60D (PMX Total Interval Energy), entry 0x15 (Apparent Energy Positive))	UINT32	RO	0xF60D:15, 32
1A28:08	SubIndex 008	8. PDO Mapping entry (object 0xF60D (PMX Total Interval Energy), entry 0x16 (Apparent Energy Negative))	UINT32	RO	0xF60D:16, 32
1A28:09	SubIndex 009	9. PDO Mapping entry (object 0xF60D (PMX Total Interval Energy), entry 0x17 (Reactive Energy))	UINT32	RO	0xF60D:17, 32
1A28:0A	SubIndex 010	10. PDO Mapping entry (object 0xF60D (PMX Total Interval Energy), entry 0x18 (Reactive Energy Positive))	UINT32	RO	0xF60D:18, 32
1A28:0B	SubIndex 011	11. PDO Mapping entry (object 0xF60D (PMX Total Interval Energy), entry 0x19 (Reactive Energy Negative))	UINT32	RO	0xF60D:19, 32

**Index 1A29 Total TxPDO-Map Active Reduced**

Index (hex)	Name	Meaning	Data type	Flags	Default
1A29:0	Total TxPDO-Map Active Reduced	PDO Mapping TxPDO 35	UINT8	RO	0x02 (2 <sub>dec</sub> )
1A29:01	SubIndex 001	1. PDO Mapping entry (Aligned)	UINT32	RO	0x0000:00, 32
1A29:02	SubIndex 002	2. PDO Mapping entry (object 0xF612 (PMX Total Active Reduced), entry 0x12 (Active Energy))	UINT32	RO	0xF612:12, 64

**Index 1A2A Total TxPDO-Map Apparent Reduced**

Index (hex)	Name	Meaning	Data type	Flags	Default
1A2A:0	Total TxPDO-Map Apparent Reduced	PDO Mapping TxPDO 35	UINT8	RO	0x02 (2 <sub>dec</sub> )
1A2A:01	SubIndex 001	1. PDO Mapping entry (32 bits align)	UINT32	RO	0x0000:00, 32
1A2A:02	SubIndex 002	2. PDO Mapping entry (object 0xF613 (PMX Total Apparent Reduced), entry 0x12 (Apparent Energy))	UINT32	RO	0xF613:12, 64

**Index 1A2B Total TxPDO-Map Reactive Reduced**

Index (hex)	Name	Meaning	Data type	Flags	Default
1A2B:0	Total TxPDO-Map Reactive Reduced	PDO Mapping TxPDO 36	UINT8	RO	0x02 (2 <sub>dec</sub> )
1A2B:01	SubIndex 001	1. PDO Mapping entry (32 bits align)	UINT32	RO	0x0000:00, 32
1A2B:02	SubIndex 002	2. PDO Mapping entry (object 0xF614 (PMX Total Reactive Reduced), entry 0x12 (Reactive Energy))	UINT32	RO	0xF614:12, 64

**Index 1A2C Total TxPDO-Map Interval Energy Reduced**

Index (hex)	Name	Meaning	Data type	Flags	Default
1A2C:0	Total TxPDO-Map Interval Energy Reduced	PDO Mapping TxPDO 36	UINT8	RO	0x05 (5 <sub>dec</sub> )
1A2C:01	SubIndex 001	1. PDO Mapping entry (align)	UINT32	RO	0x0000:00, 15
1A2C:02	SubIndex 002	2. PDO Mapping entry (object 0xF615 (PMX Total Interval Energy Reduced), entry 0x10 (TxPDO Toggle))	UINT32	RO	0xF615:10, 1
1A2C:03	SubIndex 003	3. PDO Mapping entry (object 0xF615 (PMX Total Interval Energy Reduced), entry 0x11 (Active Energy))	UINT32	RO	0xF615:11, 32
1A2C:04	SubIndex 004	4. PDO Mapping entry (object 0xF615 (PMX Total Interval Energy Reduced), entry 0x12 (Apparent Energy))	UINT32	RO	0xF615:12, 32
1A2C:05	SubIndex 005	5. PDO Mapping entry (object 0xF615 (PMX Total Interval Energy Reduced), entry 0x13 (reactive Energy))	UINT32	RO	0xF615:13, 32

**Index 1C00 Sync manager type**

Index (hex)	Name	Meaning	Data type	Flags	Default
1C00:0	Sync manager type	Length of this object	UINT8	RO	0x04 (4 <sub>dec</sub> )
1C00:01	SubIndex 001	Sync-Manager Type Channel 1: Mailbox Write	UINT8	RW	0x01 (1 <sub>dec</sub> )
1C00:02	SubIndex 002	Sync-Manager Type Channel 2: Mailbox Read	UINT8	RW	0x02 (2 <sub>dec</sub> )
1C00:03	SubIndex 003	Sync-Manager Type Channel 3: Process Data Write (Outputs)	UINT8	RW	0x03 (3 <sub>dec</sub> )
1C00:04	SubIndex 004	Sync-Manager Type Channel 4: Process Data Read (Inputs)	UINT8	RW	0x04 (4 <sub>dec</sub> )

**Index 1C12 RxPDO assign**

Index (hex)	Name	Meaning	Data type	Flags	Default
1C12:0	RxPDO assign	PDO Assign Outputs	UINT8	RW	0x01 (1 <sub>dec</sub> )
1C12:01	SubIndex 001	1. allocated RxPDO (contains the index of the associated RxPDO mapping object)	UINT16	RW	0x1601 (5633 <sub>dec</sub> )

**Index 1C13 TxPDO assign**

Index (hex)	Name	Meaning	Data type	Flags	Default
1C13:0	TxPDO assign	PDO Assign Inputs	UINT8	RW	0x0B (11 <sub>dec</sub> )
1C13:01	SubIndex 001	1. allocated TxPDO (contains the index of the associated TxPDO mapping object)	UINT16	RW	0x1A00 (6656 <sub>dec</sub> )
1C13:02	SubIndex 002	2. allocated TxPDO (contains the index of the associated TxPDO mapping object)	UINT16	RW	0x1A0A (6666 <sub>dec</sub> )
1C13:03	SubIndex 003	3. allocated TxPDO (contains the index of the associated TxPDO mapping object)	UINT16	RW	0x1A14 (6676 <sub>dec</sub> )
1C13:04	SubIndex 004	4. allocated TxPDO (contains the index of the associated TxPDO mapping object)	UINT16	RW	0x1A1E (6686 <sub>dec</sub> )
1C13:05	SubIndex 005	5. allocated TxPDO (contains the index of the associated TxPDO mapping object)	UINT16	RW	0x1A20 (6688 <sub>dec</sub> )
1C13:06	SubIndex 006	6. allocated TxPDO (contains the index of the associated TxPDO mapping object)	UINT16	RW	0x1A26 (6694 <sub>dec</sub> )
1C13:07	SubIndex 007	7. allocated TxPDO (contains the index of the associated TxPDO mapping object)	UINT16	RW	0x1A27 (6695 <sub>dec</sub> )
1C13:08	SubIndex 008	8. allocated TxPDO (contains the index of the associated TxPDO mapping object)	UINT16	RW	0x1A29 (6697 <sub>dec</sub> )
1C13:09	SubIndex 009	9. allocated TxPDO (contains the index of the associated TxPDO mapping object)	UINT16	RW	0x1A2A (6698 <sub>dec</sub> )
1C13:0A	SubIndex 010	10. allocated TxPDO (contains the index of the associated TxPDO mapping object)	UINT16	RW	0x1A2B (6699 <sub>dec</sub> )
1C13:0B	SubIndex 011	11. allocated TxPDO (contains the index of the associated TxPDO mapping object)	UINT16	RW	0x1A2C (6700 <sub>dec</sub> )
1C13:0C	SubIndex 012	12. allocated TxPDO (contains the index of the associated TxPDO mapping object)	UINT16	RW	0x0000 (0 <sub>dec</sub> )
...					
1C13:1B	SubIndex 027	27. allocated TxPDO (contains the index of the associated TxPDO mapping object)	UINT16	RW	0x0000 (0 <sub>dec</sub> )

## Index 1C32 SM output parameter

Index	Name	Meaning	Data type	Flags	Default
1C32:0	SM output parameter	Synchronization parameters for the outputs	UINT8	RO	0x20 (32 <sub>dec</sub> )
1C32:01	Sync mode	Current synchronization mode: 0: Free Run 1: Synchron with SM 2 Event 2: DC-Mode - Synchron with SYNC0 Event 3: DC-Mode - Synchron with SYNC1 Event	UINT16	RW	0x0000 (0 <sub>dec</sub> )
1C32:02	Cycle time	Cycle time (in ns): Free Run: Cycle time of the local timer Synchron with SM 2 Event: Master cycle time DC mode: SYNC0/SYNC1 Cycle Time	UINT32	RW	0x0016E360 (1500000 <sub>dec</sub> )
1C32:03	Shift time	Time between SYNC0 event and output of the outputs (in ns, DC mode only)	UINT32	RO	0x00000384 (900 <sub>dec</sub> )
1C32:04	Sync modes supported	Supported synchronization modes: Bit 0 = 1: free run is supported Bit 1 = 1: synchronous with SM 2 event is supported Bit 2-3 = 01: DC mode is supported Bit 4-5 = 10: Output shift with SYNC1 event (only DC mode) Bit 14 = 1: dynamic times (measurement through writing of 1C32:08)	UINT16	RO	0x0805 (2053 <sub>dec</sub> )
1C32:05	Minimum cycle time	Minimum cycle time (in ns)	UINT32	RO	0x0007A120 (500000 <sub>dec</sub> )
1C32:06	Calc and copy time	Minimum time between SYNC0 and SYNC1 event (in ns, DC mode only)	UINT32	RO	0x00000384 (900 <sub>dec</sub> )
1C32:07	Minimum delay time		UINT32	RO	0x00000384 (900 <sub>dec</sub> )
1C32:08	Command	0: Measurement of the local cycle time is stopped 1: Measurement of the local cycle time is started The entries 1C32:03, 1C32:05, 1C32:06, 1C32:09, 1C33:03, 1C33:06, 1C33:09 are updated with the maximum measured values. For a subsequent measurement the measured values are reset	UINT16	RW	0x0000 (0 <sub>dec</sub> )
1C32:09	Maximum delay time	Time between SYNC1 event and output of the outputs (in ns, DC mode only)	UINT32	RO	0x00000384 (900 <sub>dec</sub> )
1C32:0B	SM event missed counter	Number of missed SM events in OPERATIONAL (DC mode only)	UINT16	RO	0x0000 (0 <sub>dec</sub> )
1C32:0C	Cycle exceeded counter	Number of occasions the cycle time was exceeded in OPERATIONAL (cycle was not completed in time or the next cycle began too early)	UINT16	RO	0x0000 (0 <sub>dec</sub> )
1C32:0D	Shift too short counter	Number of occasions that the interval between SYNC0 and SYNC1 event was too short (DC mode only)	UINT16	RO	0x0000 (0 <sub>dec</sub> )

**Index 1C33 SM input parameter**

Index (hex)	Name	Meaning	Data type	Flags	Default
1C33:0	SM input parameter	Synchronization parameters for the inputs	UINT8	RO	0x20 (32 <sub>dec</sub> )
1C33:01	Sync mode	Current synchronization mode: 0: Free Run 1: Synchron with SM 3 Event (no outputs available) 2: DC - Synchron with SYNC0 Event 3: DC - Synchron with SYNC1 Event 34: Synchron with SM 2 event (outputs available)	UINT16	RW	0x0000 (0 <sub>dec</sub> )
1C33:02	Cycle time	as 1C32:02	UINT32	RW	0x0016E360 (1500000 <sub>dec</sub> )
1C33:03	Shift time	Time between SYNC0 event and reading of the inputs (in ns, only DC mode)	UINT32	RO	0x00000384 (900 <sub>dec</sub> )
1C33:04	Sync modes supported	Supported synchronization modes: Bit 0: free run is supported Bit 1: Synchron with SM 2 Event is supported (outputs available) Bit 1: Synchron with SM 3 Event is supported (no outputs available) Bit 2-3 = 01: DC mode is supported Bit 4-5 = 01: Input shift through local event (outputs available) Bit 4-5 = 10: Input shift with SYNC1 event (no outputs available) Bit 14 = 1: dynamic times (measurement through writing of 1C32:08 or 1C33:08)	UINT16	RO	0x0805 (2053 <sub>dec</sub> )
1C33:05	Minimum cycle time	as 1C32:05	UINT32	RO	0x0007A120 (500000 <sub>dec</sub> )
1C33:06	Calc and copy time	Time between reading of the inputs and availability of the inputs for the master (in ns, only DC mode)	UINT32	RO	0x0007A120 (500000 <sub>dec</sub> )
1C33:07	Minimum delay time		UINT32	RO	0x00000384 (900 <sub>dec</sub> )
1C33:08	Command	as 1C32:08	UINT16	RW	0x0000 (0 <sub>dec</sub> )
1C33:09	Maximum delay time	Time between SYNC1 event and reading of the inputs (in ns, only DC mode)	UINT32	RO	0x00000384 (900 <sub>dec</sub> )
1C33:0B	SM event missed counter	as 1C32:11	UINT16	RO	0x0000 (0 <sub>dec</sub> )
1C33:0C	Cycle exceeded counter	as 1C32:12	UINT16	RO	0x0000 (0 <sub>dec</sub> )
1C33:0D	Shift too short counter	as 1C32:13	UINT16	RO	0x0000 (0 <sub>dec</sub> )

**Index F000 Modular device profile**

Index (hex)	Name	Meaning	Data type	Flags	Default
F000:0	Modular device profile	Largest subindex of this object	UINT8	RO	0x02 (2 <sub>dec</sub> )
F000:01	Module index distance	Index distance of the objects of the individual channels	UINT16	RW	0x0010 (16 <sub>dec</sub> )
F000:02	Maximum number of modules	Number of channels	UINT16	RW	0x0003 (3 <sub>dec</sub> )

**Index F008 Code word**

Index (hex)	Name	Meaning	Data type	Flags	Default
F008:0	Code word	reserved	UINT32	RW	0x00000000 (0 <sub>dec</sub> )

**Code Word**

**i** The vendor reserves the authority for the basic calibration of the terminals. The code word is therefore at present reserved.

## Index F010 Module List

Index (hex)	Name	Meaning	Data type	Flags	Default
F010:0	Module list		UINT8	RW	0x03 (3 <sub>dec</sub> )
F010:01	SubIndex 001		UINT32	RW	0x00000155 (341 <sub>dec</sub> )
F010:02	SubIndex 002		UINT32	RW	0x00000155 (341 <sub>dec</sub> )
F010:03	SubIndex 003		UINT32	RW	0x00000155 (341 <sub>dec</sub> )

## 6.6.1.8 Command object

### Index FB00 PMX Command

The command object is used for triggering an action in the terminal. The command is started by writing subindex 1 (request). Write access is disabled until the current command is completed.

Index (hex)	Name	Meaning	Data type	Flags	Default	
FB00:0	PM Command	Largest subindex of this object	UINT8	RO	0x03 (3 <sub>dec</sub> )	
FB00:01	Request	<b>Byte 0 - service request data</b>	OCTET-STRING [2]	RW	0x0000 (0 <sub>dec</sub> )	
		4 <sub>hex</sub>				Clear energy or reset all energy counters
		<b>Byte 1 - channel selection</b>				
		00 <sub>hex</sub>				all channels
		01 <sub>hex</sub>				Channel 1
		02 <sub>hex</sub>	Channel 2			
		03 <sub>hex</sub>	Channel 3			
FB00:02	Status	<b>Byte 0</b> reserved	UINT8	RW	0x00 (0 <sub>dec</sub> )	
FB00:03	Response	<b>Byte 0</b> reserved	OCTET-STRING [2]	RW	0x00000000 (0 <sub>dec</sub> )	
		<b>Byte 1</b> reserved				
		<b>Byte 2-n</b> reserved				



## 6.6.2 EL3443-00xx

### 6.6.2.1 Restore object

#### Index 1011 Restore default parameters

Index (hex)	Name	Meaning	Data type	Flags	Default
1011:0	Restore default parameters <a href="#">▶ 316</a>	Restore default parameters	UINT8	RO	0x01 (1 <sub>dec</sub> )
1011:01	SubIndex 001	If this object is set to “ <b>0x64616F6C</b> ” in the set value dialog, all backup objects are reset to their delivery state.	UINT32	RW	0x00000000 (0 <sub>dec</sub> )

### 6.6.2.2 Configuration data

#### Index 80n0 PMX settings (for ch.1, n = 0; ch.2, n = 1; ch.3, n = 2)

Index (hex)	Name	Meaning	Data type	Flags	Default
80n0:0	PMX Settings	Max. subindex	UINT8	RO	0x13 (19 <sub>dec</sub> )
80n0:11	Voltage Transformer Ratio	If a voltage transformer is used, its transmission ratio can be entered here.	REAL32	RW	0x3F800000 (1065353216 <sub>dec</sub> )
80n0:12	Current Transformer Ratio	The ratio of the current transformer used can be entered here.	REAL32	RW	0x3F800000 (1065353216 <sub>dec</sub> )
80n0:13	Current Transformer Delay	Here you can enter a possible time delay of the current transformers in milliseconds.	REAL32	RW	0x00000000 (0 <sub>dec</sub> )

#### Index 80n1 PMX Guard Settings (for ch.1, n = 0; ch.2, n = 1; ch.3, n = 2)

Index (hex)	Name	Meaning	Data type	Flags	Default
80n1:0	PMX Guard Settings	Max. subindex	UINT8	RO	0x14 (20 <sub>dec</sub> )
80n1:11	Voltage Guard Min Error	Lower limit value for a voltage error message [V]	REAL32	RW	2.000000 (2.000000e+000)
80n1:12	Voltage Guard Min Warning	Lower limit value for a voltage warning message [V]	REAL32	RW	207.000000 (2.070000e+002)
80n1:13	Voltage Guard Max Warning	Upper limit value for a voltage warning message [V]	REAL32	RW	253.000000 (2.530000e+002)
80n1:14	Voltage Guard Max Error	Upper limit value for a voltage error message [V]	REAL32	RW	278.000000 (2.780000e+002)
80n1:15	Current Guard Min Error	Lower limit value for a current error message [A]	REAL32	RW	-1.050000 (-1.050000e+000)
80n1:16	Current Guard Min Warning	Lower limit value for a current warning message [A]	REAL32	RW	-1.000000 (-1.000000e+000)
80n1:17	Current Guard Max Warning	Upper limit value for a current warning message [A]	REAL32	RW	1.000000 (1.000000e+000)
80n1:18	Current Guard Max Error	Upper limit value for a current error message [A]	REAL32	RW	1.050000 (1.050000e+000)

#### Index 80n2 PMX User Scale (for ch.1, n = 0; ch.2, n = 1; ch.3, n = 2)

Index (hex)	Name	Meaning	Data type	Flags	Default
80n2:0	PMX User Scale Ch.1	Max. subindex	UINT8	RO	0x15 (21 <sub>dec</sub> )
80n2:01	User Calibration Enable	Set to TRUE to enable user calibration data.	BOOLEAN	RW	0x00 (0 <sub>dez</sub> )
80n2:11	User Calibration Voltage Offset	Value in V	REAL32	RW	0.000000 (0.000000e+000)
80n2:12	User Calibration Voltage Gain	Factor (without unit)	REAL32	RW	1.000000 (1.000000e+000)
80n2:13	User Calibration Current Offset	Value in A	REAL32	RW	0.000000 (0.000000e+000)
80n2:14	User Calibration Current Gain	Factor (without unit)	REAL32	RW	1.000000 (1.000000e+000)
80n2:15	User Calibration Phase Offset	Value in milliseconds	REAL32	RW	0.000000 (0.000000e+000)

## Index F800 PMX Settings

Index (hex)	Name	Meaning	Data type	Flags	Default
F800:0	PMX Settings	Max. subindex	UINT8	RO	0x16 (22 <sub>dec</sub> )
F800:01	Reset Interval	Manual restart of the measurement and statistics interval	BOOLEAN	RW	0x00 (0 <sub>dec</sub> )
F800:11	Reference	Timing reference for the RMS calculation Set to "Current" if a current is to be measured without an applied voltage. permitted values: 0 Voltage (default) 1 Current	UINT32	RW	0x00000000 (0 <sub>dec</sub> )
F800:12	Measurement Range	Filter setting for determining the fundamental permitted values: 0 25..65 Hz (default) 1 25..400 Hz 2 12..45 Hz	UINT32	RW	0x00000000 (0 <sub>dec</sub> )
F800:13	Frequency Source	Source of the system frequency permitted values: 0 Channel 1 (default) 1 Channel 2 2 Channel 3	BIT1	RW	0x00000000 (0 <sub>dec</sub> )
F800:14	Power Calculation Threshold	Noise reduction: Here you can enter a minimum limit value in percent for the power calculation, below which all values are zeroed.	REAL32	RW	0x3F800000 (1065353216 <sub>dec</sub> )
F800:15	Inaccurate Threshold Voltage	Limit value for the warning bit: Inaccurate Voltage	REAL32	RW	0x3FDC28F6 (1071393014 <sub>dec</sub> )
F800:16	Inaccurate Threshold Current	Limit value for the warning bit: Inaccurate Current	REAL32	RW	0x3BC49BA6 (1002740646 <sub>dec</sub> )

## Index F801 PMX Total Settings PQF

Index (hex)	Name	Meaning	Data type	Flags	Default
F801:0	PMX Total Settings PQF	Max. subindex	UINT8	RO	0x13 (19 <sub>dec</sub> )
F801:11	Nominal voltage	A nominal voltage value or set value is required to calculate the power quality factor (for details see basic function principles).	REAL32	RW	230.0000000 (2.3000000e+02)
F801:12	Nominal Frequency	A nominal frequency or set value is required to calculate the power quality factor (for details see basic function principles).	REAL32	RW	50.0000000 (5.0000000e+01)
F801:13	PQF Dataset	permitted values: 0: default 1: default + unbalance	UINT32	RW	Default + Unbalance (1 <sub>dez</sub> )

**Index F802 PMX Guard Settings**

Index (hex)	Name	Meaning	Data type	Flags	Default
F802:0	PMX Guard Settings	Max. subindex	UINT8	RO	0x28 (40 <sub>dec</sub> )
F802:11	Frequency Guard Min Error	Lower limit value for a frequency error message	REAL32	RW	47.000000 (4.700000e+001)
F802:12	Frequency Guard Min Warning	Lower limit value for a frequency warning message	REAL32	RW	49.500000 (4.950000e+001)
F802:13	Frequency Guard Max Warning	Upper limit value for a frequency warning message	REAL32	RW	50.500000 (5.050000e+001)
F802:14	Frequency Guard Max Error	Upper limit value for a frequency error message	REAL32	RW	52.000000 (5.200000e+001)
F802:15	Neutral Current Guard Min Error	Lower limit value for an error message of the neutral conductor current	REAL32	RW	<b>EL3423, EL3443</b> 0.000000 (0.000000e+000) <b>EL3453</b> -1.050000 (-1.050000e+000)
F802:16	Neutral Current Guard Min Warning	Lower limit value for a warning message of the neutral conductor current	REAL32	RW	<b>EL3423, EL3443</b> 0.000000 (0.000000e+000) <b>EL3453</b> -1.000000 (-1.000000e+000)
F802:17	Neutral Current Guard Max Warning	Upper limit value for a warning message of the neutral conductor current	REAL32	RW	<b>EL3423, EL3443</b> 0.006000 (6.000000e-003) <b>EL3453</b> 1.000000 (1.000000e+000)
F802:18	Neutral Current Guard Max Error	Upper limit value for an error message of the neutral conductor current	REAL32	RW	<b>EL3423, EL3443</b> 0.030000 (3.000000e-002) <b>EL3453</b> 1.050000 (1.050000e+000)
F802:19	Active Power Guard Min Error	Lower limit value for an active power error message [W]	REAL32	RW	0.000000 (0.000000e+000)
F802:1A	Active Power Guard Min Warning	Lower limit value for an active power warning message [W]	REAL32	RW	0.000000 (0.000000e+000)
F802:1B	Active Power Guard Max Warning	Upper limit value for an active power warning message [W]	REAL32	RW	0.000000 (0.000000e+000)
F802:1C	Active Power Guard Max Error	Upper limit value for an active power error message [W]	REAL32	RW	0.000000 (0.000000e+000)
F802:1D	Apparent Power Guard Min Error	Lower limit value for an apparent power error message [VA]	REAL32	RW	0.000000 (0.000000e+000)
F802:1E	Apparent Power Guard Min Warning	Lower limit value for an apparent power warning message [VA]	REAL32	RW	0.000000 (0.000000e+000)
F802:1F	Apparent Power Guard Max Warning	Upper limit value for an apparent power warning message [VA]	REAL32	RW	0.000000 (0.000000e+000)
F802:20	Apparent Power Guard Max Error	Upper limit value for an apparent power error message [VA]	REAL32	RW	0.000000 (0.000000e+000)
F802:21	PQF Guard Min Error	Lower limit value for a power quality factor error message	REAL32	RW	0.050000 (5.000000e-002)
F802:22	PQF Guard Min Warning	Lower limit value for a power quality factor warning message	REAL32	RW	0.800000 (8.000000e-001)
F802:23	PQF Guard Max Warning	Upper limit value for a power quality factor warning message	REAL32	RW	1.000000 (1.000000e+000)
F802:24	PQF Guard Max Error	Upper limit value for a power quality factor error message	REAL32	RW	1.000000 (1.000000e+000)
F802:25	Unbalance Guard Min Error	Lower limit value for an error message due to voltage imbalance	REAL32	RW	0.000000 (0.000000e+000)
F802:26	Unbalance Guard Min Warning	Lower limit value for a warning message due to voltage imbalance	REAL32	RW	0.000000 (0.000000e+000)

Index (hex)	Name	Meaning	Data type	Flags	Default
F802:27	Unbalance Guard Max Warning	Upper limit value for a warning message due to voltage imbalance	REAL32	RW	<b>EL3423, EL3453</b> 0.000000 (0.000000e+000)  <b>EL3443</b> 2.000000 (2.000000e+000)
F802:28	Unbalance Guard Max Error	Upper limit value for an error message due to voltage imbalance	REAL32	RW	<b>EL3423, EL3453</b> 0.000000 (0.000000e+000)  <b>EL3443</b> 3.000000 (3.000000e+000)

### Index F803 PMX Time Settings

Index (hex)	Name	Meaning	Data type	Flags	Default
F803:0	PMX Time Settings	Max. subindex	UINT8	RO	0x13 (19 <sub>dec</sub> )
F803:11	Measurement Mode	permitted values: 0	UINT32	RW	0x00000000 (0 <sub>dec</sub> )
F803:12	Measurement Interval	Time in seconds to automatic restart of the measurement and statistics interval	UINT32	RW	0x00000000 (0 <sub>dec</sub> )
F803:13	Actual System Time	Shows the current system time of the terminal. Write access to the object is possible in order to change the system time.	STRING	RW	

## 6.6.2.3 Configuration data (vendor-specific)

### Index 80nF PMX vendor data (for ch.1, n = 0; ch.2, n = 1; ch.3, n = 2)

Index (hex)	Name	Meaning	Data type	Flags	Default
80nF:0	PMX Vendor data	Max. subindex	UINT8	RO	0x16 (22 <sub>dec</sub> )
80nF:11	Calibration Voltage Offset	Value in V	REAL32	RW	0x00000000 (0 <sub>dec</sub> )
80nF:12	Calibration Voltage Gain	Factor (without unit)	REAL32	RW	0x3F800000 (1065353216 <sub>dec</sub> )
80nF:13	Calibration Voltage Phase Offset	Value in milliseconds	REAL32	RW	0x00000000 (0 <sub>dec</sub> )
80nF:14	Calibration Current Offset	Value in A	REAL32	RW	0x00000000 (0 <sub>dec</sub> )
80nF:15	Calibration Current Gain	Factor (without unit)	REAL32	RW	0x3F800000 (1065353216 <sub>dec</sub> )
80nF:16	Calibration Current Phase Offset	Value in milliseconds	REAL32	RW	0x00000000 (0 <sub>dec</sub> )

### 6.6.2.4 Input data

#### Index 60n0 PMX status (n = 0, 1, 2)

Index (hex)	Name	Meaning	Data type	Flags	Default
60n0:0	PMX Status	Max. subindex	UINT8	RO	0x10 (16 <sub>dec</sub> )
60n0:01	Voltage Sign Bit	Indicates the sign of the current sine wave voltage: 1 = U > 0V 0 = U < 0V	BOOLEAN	RO	0x00 (0 <sub>dec</sub> )
60n0:02	Overvoltage	Maximum measurable voltage is exceeded.	BOOLEAN	RO	0x00 (0 <sub>dec</sub> )
60n0:03	Overcurrent	Maximum measurable current is exceeded.	BOOLEAN	RO	0x00 (0 <sub>dec</sub> )
60n0:04	Inaccurate Voltage	The measured voltage value is smaller than the value entered in CoE object "F800:15 Inaccurate Threshold Voltage".	BOOLEAN	RO	0x00 (0 <sub>dec</sub> )
60n0:05	Inaccurate Current	The measured current value is smaller than the value entered in CoE object "F800:16 Inaccurate Threshold Current".	BOOLEAN	RO	0x00 (0 <sub>dec</sub> )
60n0:06	Voltage Guard Warning	A warning limit of the voltage monitor has been breached.	BOOLEAN	RO	0x00 (0 <sub>dec</sub> )
60n0:07	Voltage Guard Error	An error limit of the voltage monitor has been breached.	BOOLEAN	RO	0x00 (0 <sub>dec</sub> )
6000:10	TxPDO Toggle	The TxPDO toggle is toggled by the slave when the data of the associated TxPDO is updated.	BOOLEAN	RO	0x00 (0 <sub>dec</sub> )

#### Index 60n1 PMX Basic (n = 0, 1, 2)

Index (hex)	Name	Meaning	Data type	Flags	Default
60n1:0	PMX Basic	Max. Subindex	UINT8	RO	0x12 (18 <sub>dec</sub> )
60n1:11	Voltage	RMS value of the voltage in V	REAL32	RO	0x00000000 (0 <sub>dec</sub> )
60n1:12	Current	RMS value of the current in A	REAL32	RO	0x00000000 (0 <sub>dec</sub> )

#### Index 60n2 PMX Power (n = 0, 1, 2)

Index (hex)	Name	Meaning	Data type	Flags	Default
60n2:0	PMX Power	Max Subindex	UINT8	RO	0x14 (20 <sub>dec</sub> )
60n2:11	Active power	Active power in W	REAL32	RO	0x00000000 (0 <sub>dec</sub> )
60n2:12	Apparent Power	Apparent power in VA	REAL32	RO	0x00000000 (0 <sub>dec</sub> )
60n2:13	Reactive Power	Reactive power in var	REAL32	RO	0x00000000 (0 <sub>dec</sub> )
60n2:14	Power Factor	Power factor	REAL32	RO	0x00000000 (0 <sub>dec</sub> )

#### Index 60n4 PMX Energy (n = 0, 1, 2)

Index (hex)	Name	Meaning	Data type	Flags	Default
60n4:0	PMX Energy	Max. subindex	UINT8	RO	0x13 (19 <sub>dec</sub> )
60n4:11	Active Energy	Active energy in mWh	INT64	RO	
60n4:12	Apparent Energy	Apparent energy in mVAh	INT64	RO	
60n4:13	Reactive Energy	Reactive energy in mvarh	INT64	RO	

#### Index 60n6 PMX Timing (n = 0, 1, 2)

Index (hex)	Name	Meaning	Data type	Flags	Default
60n6:0	PMX Timing	Max Subindex	UINT8	RO	0x12 (18 <sub>dec</sub> )
60n6:12	Voltage Last Zero Crossing	Last detected voltage zero crossing as distributed clock time	UINT64	RO	

**Index 60n7 PMX Advanced (n = 0, 1, 2)**

Index (hex)	Name	Meaning	Data type	Flags	Default
60n7:0	PMX Advanced	Max Subindex	UINT8	RO	0x14 (20 <sub>dec</sub> )
60n7:10	TxPDO Toggle	The TxPDO toggle is toggled by the slave when the data of the associated TxPDO is updated.	BOOLEAN	RO	0x00 (0 <sub>dec</sub> )
60n7:11	Voltage Total Harmonic Distortion	"Total Harmonic Distortion" is the distortion factor of the voltage. It indicates the ratio of the harmonic components of an oscillation relative to its fundamental in %.	REAL32	RO	0x00000000 (0 <sub>dec</sub> )
60n7:12	Current Distortion Factor	The "Current Distortion Factor" is also referred to as TDD (Total Demand Distortion). It indicates the ratio between the current harmonics and the maximum current (EL3443: 1A and EL3443-0010: 5A). Specified in % of the maximum current.	REAL32	RO	0x00000000 (0 <sub>dec</sub> )
60n7:13	Current Total Harmonic Distortion	"Total Harmonic Distortion" is the distortion factor of the current. It indicates the ratio of the harmonic components of an oscillation relative to its fundamental in %.	REAL32	RO	0x00000000 (0 <sub>dec</sub> )
60n7:14	Cos phi	Phase angle of the fundamental wave in degrees	REAL32	RO	0x00000000 (0 <sub>dec</sub> )

**Index 60n8 PMX Statistic Voltage (n = 0, 1, 2)**

Index (hex)	Name	Meaning	Data type	Flags	Default
60n8:0	PMX Statistic Voltage	Max Subindex	UINT8	RO	0x13 (19 <sub>dec</sub> )
60n8:11	Voltage Peak	Peak value of the instantaneous voltage in the last interval in V	REAL32	RO	0x00000000 (0 <sub>dec</sub> )
60n8:12	Voltage RMS Minimum	Minimum RMS value of the voltage in the last interval in V	REAL32	RO	0x00000000 (0 <sub>dec</sub> )
60n8:13	Voltage RMS Maximum	Maximum RMS value of the voltage in the last interval in V	REAL32	RO	0x00000000 (0 <sub>dec</sub> )

**Index 60n9 PMX Statistic Current (n = 0, 1, 2)**

Index (hex)	Name	Meaning	Data type	Flags	Default
60n9:0	PMX Statistic Current	Max Subindex	UINT8	RO	0x13 (19 <sub>dec</sub> )
60n9:11	Current Peak	Peak value of the instantaneous current in the last interval in A	REAL32	RO	0x00000000 (0 <sub>dec</sub> )
60n9:12	Current RMS Minimum	Minimum RMS value of the current in the last interval in A	REAL32	RO	0x00000000 (0 <sub>dec</sub> )
60n9:13	Current RMS Maximum	Maximum RMS value of the current in the last interval in A	REAL32	RO	0x00000000 (0 <sub>dec</sub> )

**Index 60nA PMX Statistic Power (n = 0, 1, 2)**

Index (hex)	Name	Meaning	Data type	Flags	Default
60nA:0	PMX Statistic Power	Max Subindex	UINT8	RO	0x19 (25 <sub>dec</sub> )
60nA:11	Active Power Avg	Average active power during the last interval in W	REAL32	RO	0x00000000 (0 <sub>dec</sub> )
60nA:12	Active Power Min	Minimum active power in the last interval in W	REAL32	RO	0x00000000 (0 <sub>dec</sub> )
60nA:13	Active Power Max	Maximum active power in the last interval in W	REAL32	RO	0x00000000 (0 <sub>dec</sub> )
60nA:14	Apparent Power Avg	Average apparent power during the last interval in VA	REAL32	RO	0x00000000 (0 <sub>dec</sub> )
60nA:15	Apparent Power Max	Maximum apparent power in the last interval in VA	REAL32	RO	0x00000000 (0 <sub>dec</sub> )
60nA:16	Reactive Power Avg	Average reactive power average during the last interval in var	REAL32	RO	0x00000000 (0 <sub>dec</sub> )
60nA:17	Reactive Power Min	Minimum reactive power in the last interval in var	REAL32	RO	0x00000000 (0 <sub>dec</sub> )
60nA:18	Reactive Power Max	Maximum reactive power in the last interval in var	REAL32	RO	0x00000000 (0 <sub>dec</sub> )
60nA:19	Apparent Power Min	Minimum apparent power in the last interval in VA	REAL32	RO	0x00000000 (0 <sub>dec</sub> )

**Index 60nB PMX Classic (n = 0, 1, 2)**

Index (hex)	Name	Meaning	Data type	Flags	Default
600B:0	PMX Classic	Max. subindex	UINT8	RO	0x16 (22 <sub>dec</sub> )
600B:10	TxPDO Toggle	The TxPDO toggle is toggled by the slave when the data of the associated TxPDO is updated.	BOOLEAN	RO	0x00 (0 <sub>dec</sub> )
600B:11	Voltage	RMS value of the voltage in 0.001 V	INT32	RO	0x00000000 (0 <sub>dec</sub> )
600B:12	Current	RMS value of the current in 0.0001 A	INT32	RO	0x00000000 (0 <sub>dec</sub> )
600B:13	Frequency	Frequency of the fundamental in 0.001 Hz	INT32	RO	0x00000000 (0 <sub>dec</sub> )
600B:14	Active Power	Active power in 0.001 W	INT32	RO	0x00000000 (0 <sub>dec</sub> )
600B:15	Apparent Power	Apparent power in 0.001 VA	INT32	RO	0x00000000 (0 <sub>dec</sub> )
600B:16	Reactive Power	Reactive power in 0.001 var	INT32	RO	0x00000000 (0 <sub>dec</sub> )

**Index F600 PMX Total Status**

Index (hex)	Name	Meaning	Data type	Flags	Default
F600:0	PMX Total Status	Max. subindex	UINT8	RO	0x11 (17 <sub>dec</sub> )
F600:01	System State	Overall system state (as a logical disjunction of voltage guard errors, phase sequence, overvoltage, overcurrent and frequency guard errors)	BOOLEAN	RO	0x00 (0 <sub>dec</sub> )
F600:02	Grid Direction	Phase sequence L1 - L2 - L3 correctly detected (with clockwise 3-phase mains)	BOOLEAN	RO	0x00 (0 <sub>dec</sub> )
F600:03	Frequency Guard Warning	A warning limit of the frequency monitor has been breached.	BOOLEAN	RO	0x00 (0 <sub>dec</sub> )
F600:04	Frequency Guard Error	An error limit of the frequency monitor has been breached.	BOOLEAN	RO	0x00 (0 <sub>dec</sub> )
F600:05	Neutral Current Guard Warning	A warning limit of the neutral conductor current monitor has been breached.	BOOLEAN	RO	0x00 (0 <sub>dec</sub> )
F600:06	Neutral Current Guard Error	An error limit of the neutral conductor current monitor has been breached.	BOOLEAN	RO	0x00 (0 <sub>dec</sub> )
F600:07	Active Power Guard Warning	A warning limit of the active power monitor has been breached.	BOOLEAN	RO	0x00 (0 <sub>dec</sub> )
F600:08	Active Power Guard Error	An error limit of the active power monitor has been breached.	BOOLEAN	RO	0x00 (0 <sub>dec</sub> )
F600:09	Apparent Power Guard Warning	A warning limit of the apparent power monitor has been breached.	BOOLEAN	RO	0x00 (0 <sub>dec</sub> )
F600:0A	Apparent Power Guard Error	An error limit of the apparent power monitor has been breached.	BOOLEAN	RO	0x00 (0 <sub>dec</sub> )
F600:0B	Power Quality Guard Warning	A warning limit of the PQF monitor has been breached.	BOOLEAN	RO	0x00 (0 <sub>dec</sub> )
F600:0C	Power Quality Guard Error	An error limit of the PQF monitor has been breached.	BOOLEAN	RO	0x00 (0 <sub>dec</sub> )
F600:0F	TxPDO State	TRUE for general error	BOOLEAN	RO	0x00 (0 <sub>dec</sub> )
F600:10	TxPDO Toggle	The TxPDO toggle is toggled by the slave when the data of the associated TxPDO is updated.	BOOLEAN	RO	0x00 (0 <sub>dec</sub> )
F600:11	Power Quality Factor	Analog value of the voltage quality between 1.0 and 0 (see basic function principles - Power Quality Factor)	REAL32	RO	0x00000000 (0 <sub>dec</sub> )

**Index F601 PMX Total Basic**

Index (hex)	Name	Meaning	Data type	Flags	Default
F601:0	PMX Total Basic	Max. subindex	UINT8	RO	0x13 (19 <sub>dec</sub> )
F601:11	Frequency	Frequency in Hz	REAL32	RO	0x00000000 (0 <sub>dec</sub> )
F601:12	Power Factor	Power factor	REAL32	RO	0x00000000 (0 <sub>dec</sub> )
F601:13	Calculated Neutral Line Current	Calculated RMS value of the neutral conductor current in A	REAL32	RO	0x00000000 (0 <sub>dec</sub> )

**Index F602 PMX Total Advanced**

Index (hex)	Name	Meaning	Data type	Flags	Default
F602:0	PMX Total Advanced	Max. subindex	UINT8	RO	0x14 (20 <sub>dec</sub> )
F602:01	Unbalance Guard Warning	A warning limit of the unbalance monitor has been breached.	BOOLEAN	RO	0x00 (0 <sub>dec</sub> )
F602:02	Unbalance Guard Error	An error limit of the unbalance monitor has been breached.	BOOLEAN	RO	0x00 (0 <sub>dec</sub> )
F602:10	TxPDO Toggle	The TxPDO toggle is toggled by the slave when the data of the associated TxPDO is updated.	BOOLEAN	RO	0x00 (0 <sub>dec</sub> )
F602:11	Max Voltage Harmonic Distortion	Maximum distortion factor of all three phase voltages in %.	REAL32	RO	0x00000000 (0 <sub>dec</sub> )
F602:12	Max Current Harmonic Distortion	Maximum distortion factor of all three phase currents in %	REAL32	RO	0x00000000 (0 <sub>dec</sub> )
F602:13	Max Current Distortion Factor	Maximum "Total Demand Distortion" value of all three phases in %	REAL32	RO	0x00000000 (0 <sub>dec</sub> )
F602:14	Voltage Unbalance	Ratio between negative and positive voltage system in %	REAL32	RO	0x00000000 (0 <sub>dec</sub> )

**Index F603 PMX Total Active**

Index (hex)	Name	Meaning	Data type	Flags	Default
F603:0	PMX Total Active	Max. subindex	UINT8	RO	0x14 (20 <sub>dec</sub> )
F603:11	Active Power	Active power in W	REAL32	RO	
F603:12	Active Energy	Recorded active energy in mWh	INT64	RO	
F603:13	Active Positive Energy	Received active energy in mWh	INT64	RO	
F603:14	Active Negative Energy	Supplied active energy in mWh	INT64	RO	

**Index F605 PMX Total Apparent**

Index (hex)	Name	Meaning	Data type	Flags	Default
F605:0	PMX Total Apparent	Max. subindex	UINT8	RO	0x14 (20 <sub>dec</sub> )
F605:11	Apparent Power	Balanced apparent power in VA	INT64	RO	
F605:12	Apparent Energy	Recorded apparent energy in mWh	INT64	RO	
F605:13	Apparent Positive Energy	Received apparent energy in mWh	UINT64	RO	
F605:14	Apparent Negative Energy	Supplied apparent energy in mWh	UINT64	RO	

**Index F607 PMX Total Reactive**

Index (hex)	Name	Meaning	Data type	Flags	Default
F607:0	PMX Total Reactive	Max. subindex	UINT8	RO	0x14 (20 <sub>dec</sub> )
F607:11	Reactive Power	Balanced reactive power in Var	INT64	RO	
F607:12	Reactive Energy	Recorded reactive energy in mWh	INT64	RO	
F607:13	Reactive Positive Energy	Received reactive energy in mWh	UINT64	RO	
F607:14	Reactive Negative Energy	Supplied reactive energy in mWh	UINT64	RO	

**Index F609 PMX Total L-L Voltages**

Index (hex)	Name	Meaning	Data type	Flags	Default
F609:0	PMX Total L-L Voltages	Max. subindex	UINT8	RO	0x13 (19 <sub>dec</sub> )
F609:11	L1-L2 Voltage	RMS value of the phase-to-phase voltage between L1 and L2 in V	REAL32	RO	0x00000000 (0 <sub>dec</sub> )
F609:12	L2-L3 Voltage	RMS value of the phase-to-phase voltage between L2 and L3 in V	REAL32	RO	0x00000000 (0 <sub>dec</sub> )
F609:13	L3-L1 Voltage	RMS value of the phase-to-phase voltage between L3 and L1 in V	REAL32	RO	0x00000000 (0 <sub>dec</sub> )



**Index F60A PMX Variant Value In**

Index (hex)	Name	Meaning	Data type	Flags	Default
F60A:0	PMX Variant Value In	Max. subindex	UINT8	RO	0x18 (24 <sub>dec</sub> )
F60A:10	TxPDO Toggle	The TxPDO toggle is toggled by the slave when the data of the associated TxPDO is updated.	BOOLEAN	RO	0x00 (0 <sub>dec</sub> )
F60A:11	Index 1 REAL	Acknowledge for variable output value 1	UINT16	RO	0x0000 (0 <sub>dec</sub> )
F60A:12	Value 1 REAL	variable output value channel 1	REAL32	RO	0x00000000 (0 <sub>dec</sub> )
F60A:13	Index 2 REAL	Acknowledge for variable output value 2	UINT16	RO	0x0000 (0 <sub>dec</sub> )
F60A:14	Value 2 REAL	variable output value channel 2	REAL32	RO	0x00000000 (0 <sub>dec</sub> )
F60A:15	Index 3 REAL	Acknowledge for variable output value 3	UINT16	RO	0x0000 (0 <sub>dec</sub> )
F60A:16	Value 3 REAL	variable output value channel 3	REAL32	RO	0x00000000 (0 <sub>dec</sub> )
F60A:17	Index 4 ULINT	Acknowledge for variable output value 4	UINT16	RO	0x0000 (0 <sub>dec</sub> )
F60A:18	Value 4 ULINT	variable output value channel 4	UINT64	RO	

**Index F60B PMX Total Statistic Power**

Index (hex)	Name	Meaning	Data type	Flags	Default
F60B:0	PMX Total Statistic Power	Max. subindex	UINT8	RO	0x19 (25 <sub>dec</sub> )
F60B:11	Active Power Avg	Average total active power during the last interval in W	REAL32	RO	0x00000000 (0 <sub>dec</sub> )
F60B:12	Active Power Min	Minimum total active power in the last interval in W	REAL32	RO	0x00000000 (0 <sub>dec</sub> )
F60B:13	Active Power Max	Maximum total active power in the last interval in W	REAL32	RO	0x00000000 (0 <sub>dec</sub> )
F60B:14	Apparent Power Avg	Average total apparent power during the last interval in VA	REAL32	RO	0x00000000 (0 <sub>dec</sub> )
F60B:15	Apparent Power Min	Minimum total apparent power in the last interval in VA	REAL32	RO	0x00000000 (0 <sub>dec</sub> )
F60B:16	Apparent Power Max	Maximum total apparent power in the last interval in VA	REAL32	RO	0x00000000 (0 <sub>dec</sub> )
F60B:17	Reactive Power Avg	Average total reactive power average during the last interval in Var	REAL32	RO	0x00000000 (0 <sub>dec</sub> )
F60B:18	Reactive Power Min	Minimum total reactive power in the last interval in Var	REAL32	RO	0x00000000 (0 <sub>dec</sub> )
F60B:19	Reactive Power Max	Maximum total reactive power in the last interval in Var	REAL32	RO	0x00000000 (0 <sub>dec</sub> )

**Index F60C PMX Total Statistic PQF**

Index (hex)	Name	Meaning	Data type	Flags	Default
F60C:0	PMX Total Statistic PQF	Max. subindex	UINT8	RO	0x13 (19 <sub>dec</sub> )
F60C:11	PQF Avg	Average value of the power quality factor during the last interval	REAL32	RO	0x00000000 (0 <sub>dec</sub> )
F60C:12	PQF Min	Minimum power quality factor in the last interval	REAL32	RO	0x00000000 (0 <sub>dec</sub> )
F60C:13	PQF Max	Maximum power quality factor in the last interval	REAL32	RO	0x00000000 (0 <sub>dec</sub> )

**Index F60D PMX Total Interval Energy**

Index (hex)	Name	Meaning	Data type	Flags	Default
F60D:0	PMX Total Interval Energy	Max. subindex	UINT8	RO	0x19 (25 <sub>dec</sub> )
F60D:10	TxPDO Toggle	The TxPDO toggle is toggled by the slave when the data of the associated TxPDO is updated.	BOOLEAN	RO	0x00 (0 <sub>dec</sub> )
F60D:11	Active Energy	Recorded total active energy during the last interval in mWh	REAL32	RO	0x00000000 (0 <sub>dec</sub> )
F60D:12	Active Energy Positive	Received total active energy during the last interval in mWh	REAL32	RO	0x00000000 (0 <sub>dec</sub> )
F60D:13	Active Energy Negative	Supplied total active energy during at last interval in mWh	REAL32	RO	0x00000000 (0 <sub>dec</sub> )
F60D:14	Apparent Energy	Recorded total apparent energy during the last interval in mWh	REAL32	RO	0x00000000 (0 <sub>dec</sub> )
F60D:15	Apparent Energy Positive	Received total apparent energy during the last interval in mWh	REAL32	RO	0x00000000 (0 <sub>dec</sub> )
F60D:16	Apparent Energy Negative	Supplied total apparent energy during the last interval in mWh	REAL32	RO	0x00000000 (0 <sub>dec</sub> )
F60D:17	Reactive Energy	Recorded total reactive energy during the last interval in mWh	REAL32	RO	0x00000000 (0 <sub>dec</sub> )
F60D:18	Reactive Energy Positive	Received total reactive energy during the last interval in mWh	REAL32	RO	0x00000000 (0 <sub>dec</sub> )
F60D:19	Reactive Energy Negative	Supplied total reactive energy during the last interval in mWh	REAL32	RO	0x00000000 (0 <sub>dec</sub> )

**Index F612 PMX Total Active Reduced**

Index (hex)	Name	Meaning	Data type	Flags	Default
F612:0	PMX Total Active Reduced	Max. subindex	UINT8	RO	0x12 (18 <sub>dec</sub> )
F612:11	Active Power	Active power in W	REAL32	RO	0x00000000 (0 <sub>dec</sub> )
F612:12	Active Energy	Active energy in mWh	INT64	RO	0x00000000 (0 <sub>dec</sub> )

**Index F613 PMX Total Apparent Reduced**

Index (hex)	Name	Meaning	Data type	Flags	Default
F613:0	PMX Total Apparent Reduced	Max. subindex	UINT8	RO	0x12 (18 <sub>dec</sub> )
F613:11	Apparent Power	Apparent power in VA	REAL32	RO	0x00000000 (0 <sub>dec</sub> )
F613:12	Apparent Energy	Apparent energy in mVAh	INT64	RO	0x00000000 (0 <sub>dec</sub> )

**Index F614 PMX Total Reactive Reduced**

Index (hex)	Name	Meaning	Data type	Flags	Default
F614:0	PMX Total Reactive Reduced	Max. subindex	UINT8	RO	0x12 (18 <sub>dec</sub> )
F614:11	Reactive Power	Reactive power in var	REAL32	RO	0x00000000 (0 <sub>dec</sub> )
F614:12	Reactive Energy	Reactive energy in mvarh	INT64	RO	0x00000000 (0 <sub>dec</sub> )

**Index F615 PMX Total Interval Energy Reduced**

Index (hex)	Name	Meaning	Data type	Flags	Default
F615:0	PMX Total Interval Energy Reduced	Max. Subindex	UINT8	RO	0x13 (19 <sub>dec</sub> )
F615:10	TxPDO Toggle	The TxPDO toggle is toggled by the slave when the data of the associated TxPDO is updated.	BOOLEAN	RO	0x00 (0 <sub>dec</sub> )
F615:11	Active Energy	Recorded total active energy during the last interval in mWh	REAL32	RO	0x00000000 (0 <sub>dec</sub> )
F615:12	Apparent Energy	Recorded total apparent energy during the last interval in mVAh	REAL32	RO	0x00000000 (0 <sub>dec</sub> )
F615:13	Reactive Energy	Recorded total reactive energy during the last interval in mvarh	REAL32	RO	0x00000000 (0 <sub>dec</sub> )

### 6.6.2.5 Output data

#### Index F700 PMX Variant Value Out

Index (hex)	Name	Meaning	Data type	Flags	Default
F700:0	PMX Variant Value Out	Max. subindex	UINT8	RO	0x14 (20 <sub>dec</sub> )
F700:11	Index 1 REAL	Request for variable output value 1 (REAL) Can be used for all non-energy values (details see settings)	UINT16	RO	0x0000 (0 <sub>dec</sub> )
F700:12	Index 2 REAL	Request for variable output value 2 (REAL) Can be used for all non-energy values (details see settings)	UINT16	RO	0x0000 (0 <sub>dec</sub> )
F700:13	Index 3 REAL	Request for variable output value 3 (REAL) Can be used for all non-energy values (details see settings)	UINT16	RO	0x0000 (0 <sub>dec</sub> )
F700:14	Index 4 ULINT	Request for variable output value 4 (ULINT) Can be used for all energy values (which are output as ULINT): 45-59 and 1069-1083	UINT16	RO	0x0000 (0 <sub>dec</sub> )

#### Index F701 PMX Interval

Index (hex)	Name	Meaning	Data type	Flags	Default
F701:0	PMX Interval	Max. subindex	UINT8	RO	0x01 (1 <sub>dec</sub> )
F701:01	Reset Interval	Manual option for resetting the interval (see basic function principles – Statistical evaluation)	BOOLEAN	RO	0x00 (0 <sub>dec</sub> )

### 6.6.2.6 Information and diagnostic data

#### Index 90n0 PMX info data voltage (for ch.1, n = 0; ch.2, n = 1; ch.3, n = 2)

Index (hex)	Name	Meaning	Data type	Flags	Default
90n0:0	PMX Info data Voltage	Max. subindex	UINT8	RO	0x13 (19 <sub>dec</sub> )
90n0:11	Voltage Peak	Peak value of the instantaneous voltage in the last interval in V	REAL32	RO	0x00000000 (0 <sub>dec</sub> )
90n0:12	Voltage RMS Minimum	Minimum RMS value of the voltage in the last interval in V	REAL32	RO	0x00000000 (0 <sub>dec</sub> )
90n0:13	Voltage RMS Maximum	Maximum RMS value of the voltage in the last interval in V	REAL32	RO	0x00000000 (0 <sub>dec</sub> )

#### Index 90n1 PMX info data current (for ch.1, n = 0; ch.2, n = 1; ch.3, n = 2)

Index (hex)	Name	Meaning	Data type	Flags	Default
90n1:0	PMX Info data Current	Max. subindex	UINT8	RO	0x13 (19 <sub>dec</sub> )
90n1:11	Current Peak	Peak value of the instantaneous current in the last interval in A	REAL32	RO	0x00000000 (0 <sub>dec</sub> )
90n1:12	Current RMS Minimum	Minimum RMS value of the current in the last interval in A	REAL32	RO	0x00000000 (0 <sub>dec</sub> )
90n1:13	Current RMS Maximum	Maximum RMS value of the current in the last interval in A	REAL32	RO	0x00000000 (0 <sub>dec</sub> )

**Index 90n2 PMX info data power (for ch.1, n = 0; ch.2, n = 1; ch.3, n = 2)**

Index (hex)	Name	Meaning	Data type	Flags	Default
90n2:0	PMX Info data Power	Max. subindex	UINT8	RO	0x1B (27 <sub>dec</sub> )
90n2:11	Active Power Avg	Average active phase power during the last interval in W	REAL32	RO	0x00000000 (0 <sub>dec</sub> )
90n2:12	Active Power Min	Minimum active phase power during the last interval in W	REAL32	RO	0x00000000 (0 <sub>dec</sub> )
90n2:13	Active Power Max	Maximum active phase power during the last interval in W	REAL32	RO	0x00000000 (0 <sub>dec</sub> )
90n2:14	Apparent Power Avg	Average apparent phase power during the last interval in VA	REAL32	RO	0x00000000 (0 <sub>dec</sub> )
90n2:15	Apparent Power Min	Minimum apparent phase power during the last interval in VA	REAL32	RO	0x00000000 (0 <sub>dec</sub> )
90n2:16	Apparent Power Max	Maximum apparent phase power during the last interval in VA	REAL32	RO	0x00000000 (0 <sub>dec</sub> )
90n2:17	Reactive Power Avg	Average reactive phase power during the last interval in var	REAL32	RO	0x00000000 (0 <sub>dec</sub> )
90n2:18	Reactive Power Min	Minimum reactive phase power during the last interval in var	REAL32	RO	0x00000000 (0 <sub>dec</sub> )
90n2:19	Reactive Power Max	Maximum reactive phase power during the last interval in var	REAL32	RO	0x00000000 (0 <sub>dec</sub> )
90n2:1A	Phi	Phase angle in degrees (between voltage U_Lx and the corresponding current I_Lx)	REAL32	RO	0x00000000 (0 <sub>dec</sub> )
90n2:1B	Phase angle	Phase difference in degrees (between different voltages U_Lx and U_Ly)	REAL32	RO	0x00000000 (0 <sub>dec</sub> )

**Index 90n3 PMX info data energy (for ch.1, n = 0; ch.2, n = 1; ch.3, n = 2)**

Index (hex)	Name	Meaning	Data type	Flags	Default
90n3:0	PMX info data energy ch.1	Max. subindex	UINT8	RO	0x19 (25 <sub>dec</sub> )
90n3:11	Active Energy	Recorded active phase energy in mWh	INT64	RO	
90n3:12	Positive Active Energy	Received active phase energy in mWh	UINT64	RO	
90n3:13	Negative Active Energy	Supplied active phase energy in mWh	UINT64	RO	
90n3:14	Apparent Energy	Recorded apparent phase energy in mWh	INT64	RO	
90n3:15	Positive Apparent Energy	Received apparent phase energy in mWh	UINT64	RO	
90n3:16	Negative Apparent Energy	Supplied apparent phase energy in mWh	UINT64	RO	
90n3:17	Reactive Energy	Recorded reactive phase energy in mWh	INT64	RO	
90n3:18	Positive Reactive Energy	Received reactive phase energy in mWh	UINT64	RO	
90n3:19	Negative Reactive Energy	Supplied reactive phase energy in mWh	UINT64	RO	

**Index 90n4 PMX Harmonic Voltage (for ch.1, n = 0; ch.2, n = 1; ch.3, n = 2)**

Index (hex)	Name	Meaning	Data type	Flags	Default
90n4:0	PMX Harmonic Voltage Ch.1	Max. subindex	UINT8	RO	0x2A (42 <sub>dec</sub> )
90n4:01	Harmonic 0	DC component of the oscillation in % of the fundamental wave	REAL32	RO	0x00000000 (0 <sub>dec</sub> )
90n4:02	Harmonic 1	Fundamental wave	REAL32	RO	0x00000000 (0 <sub>dec</sub> )
90n4:03	Harmonic 2	Second harmonic in % of the fundamental wave	REAL32	RO	0x00000000 (0 <sub>dec</sub> )
90n4:04	Harmonic 3	Third harmonic in % of the fundamental wave	REAL32	RO	0x00000000 (0 <sub>dec</sub> )
...	...	...	...	...	...
90n4:2A	Harmonic 41	41st harmonic in % of the fundamental wave	REAL32	RO	0x00000000 (0 <sub>dec</sub> )

**Index 90n5 PMX Harmonic Current (for ch.1, n = 0; ch.2, n = 1; ch.3, n = 2)**

Index (hex)	Name	Meaning	Data type	Flags	Default
90n5:0	PMX Harmonic Voltage Ch.1	Max. subindex	UINT8	RO	0x2A (42 <sub>dec</sub> )
90n5:01	Harmonic 0	DC component of the oscillation in % of the fundamental wave	REAL32	RO	0x00000000 (0 <sub>dec</sub> )
90n5:02	Harmonic 1	Fundamental wave	REAL32	RO	0x00000000 (0 <sub>dec</sub> )
90n5:03	Harmonic 2	2nd harmonic in % of the fundamental wave	REAL32	RO	0x00000000 (0 <sub>dec</sub> )
90n5:04	Harmonic 3	3rd harmonic in % of the fundamental wave	REAL32	RO	0x00000000 (0 <sub>dec</sub> )
...	...	...	...	...	...
90n5:2A	Harmonic 41	41st harmonic in % of the fundamental wave	REAL32	RO	0x00000000 (0 <sub>dec</sub> )

**Index A0n0 PMX Diag data (for ch.1, n = 0; ch.2, n = 1; ch.3, n = 2)**

Index (hex)	Name	Meaning	Data type	Flags	Default
A0n0:0	PMX diag data ch.1	Max. subindex	UINT8	RO	0x12 (18 <sub>dec</sub> )
A0n0:11	Saturation Time Voltage	Time (in 0.1 ms) in which the terminal has measured an overvoltage.	UINT32	RO	0x00000000 (0 <sub>dec</sub> )
A0n0:12	Saturation Time Current	Time (in 0.1 ms) in which the terminal has measured an overcurrent.	UINT32	RO	0x00000000 (0 <sub>dec</sub> )

**Index F081 Download revision**

Index (hex)	Name	Meaning	Data type	Flags	Default
F081:0	Download revision	Max. subindex	UINT8	RO	0x01 (1 <sub>dec</sub> )
F010:01	Revision number	Configured revision of the terminal, (see <a href="#">note [p. 139]</a> )	UINT32	RW	0x00000000 (0 <sub>dec</sub> )

**Index F80F PM Vendor data**

Index (hex)	Name	Meaning	Data type	Flags	Default
F80F:0	PMX Vendor data	Max. subindex	UINT8	RO	0x11 (17 <sub>dec</sub> )
F80F:11	Type	Vendor-specific data	UINT32	RW	0x00000000 (0 <sub>dec</sub> )

**Index F902 PMX Total Info data Power**

Index (hex)	Name	Meaning	Data type	Flags	Default
F902:0	PMX Total Info data Power	Max subindex	UINT8	RO	0x19 (25 <sub>dec</sub> )
F902:11	Active Power Avg	Average total active power during the last interval in W	REAL32	RO	0x00000000 (0 <sub>dec</sub> )
F902:12	Active Power Min	Minimum total active power in the last interval in W	REAL32	RO	0x00000000 (0 <sub>dec</sub> )
F902:13	Active Power Max	Maximum total active power in the last interval in W	REAL32	RO	0x00000000 (0 <sub>dec</sub> )
F902:14	Apparent Power Avg	Average total apparent power during the last interval in VA	REAL32	RO	0x00000000 (0 <sub>dec</sub> )
F902:15	Apparent Power Min	Minimum total apparent power in the last interval in VA	REAL32	RO	0x00000000 (0 <sub>dec</sub> )
F902:16	Apparent Power Max	Maximum total apparent power in the last interval in VA	REAL32	RO	0x00000000 (0 <sub>dec</sub> )
F902:17	Reactive Power Avg	Average total reactive power average during the last interval in var	REAL32	RO	0x00000000 (0 <sub>dec</sub> )
F902:18	Reactive Power Min	Minimum total reactive power in the last interval in var	REAL32	RO	0x00000000 (0 <sub>dec</sub> )
F902:19	Reactive Power Max	Maximum total reactive power in the last interval in var	REAL32	RO	0x00000000 (0 <sub>dec</sub> )

**Index F903 PMX Total Info data Energy**

Index (hex)	Name	Meaning	Data type	Flags	Default
F903:0	PMX Total Info data Energy	Max. subindex	UINT8	RO	0x19 (25 <sub>dec</sub> )
F903:11	Active Energy	Recorded total active energy in mWh	INT64	RO	
F903:12	Positive Active Energy	Received total active energy in mWh	UINT64	RO	
F903:13	Negative Active Energy	Supplied total active energy in mWh	UINT64	RO	
F903:14	Apparent Energy	Recorded total apparent energy in mWh	INT64	RO	
F903:15	Positive Apparent Energy	Received total apparent energy in mWh	UINT64	RO	
F903:16	Negative Apparent Energy	Supplied total apparent energy in mWh	UINT64	RO	
F903:17	Reactive Energy	Recorded total reactive energy in mWh	INT64	RO	
F903:18	Positive Reactive Energy	Received total reactive energy in mWh	UINT64	RO	
F903:19	Negative Reactive Energy	Supplied total reactive energy in mWh	UINT64	RO	

**Index F904 PMX Total Info data PQF**

Index (hex)	Name	Meaning	Data type	Flags	Default
F904:0	PMX Total Info data PQF	Max. subindex	UINT8	RO	0x13 (19 <sub>dec</sub> )
F904:11	PQF Avg	Average value of the power quality factor during the last interval	REAL32	RO	0x00000000 (0 <sub>dec</sub> )
F904:12	PQF Min	Minimum power quality factor in the last interval	REAL32	RO	0x00000000 (0 <sub>dec</sub> )
F904:13	PQF Max	Maximum power quality factor in the last interval	REAL32	RO	0x00000000 (0 <sub>dec</sub> )

**Index FA00 PMX Diag data**

Index (hex)	Name	Meaning	Data type	Flags	Default
FA00:0	PMX Diag data	Max. subindex	UINT8	RO	0x13 (19 <sub>dec</sub> )
FA00:11	Min CPU Die Temperature	Minimum CPU temperature measured so far	REAL32	RO	0x00000000 (0 <sub>dec</sub> )
FA00:12	Max CPU Die Temperature	Maximum CPU temperature measured so far	REAL32	RO	0x00000000 (0 <sub>dec</sub> )
FA00:13	EBUS Voltage	Current E-bus voltage	REAL32	RO	0x00000000 (0 <sub>dec</sub> )

**6.6.2.7 Standard objects****Standard objects (0x1000-0x1FFF)**

The standard objects have the same meaning for all EtherCAT slaves.

**Index 1000 Device type**

Index (hex)	Name	Meaning	Data type	Flags	Default
1000:0	Device type	Device type of the EtherCAT slave: The Lo-Word contains the CoE profile used (5001). The Hi-Word contains the module profile according to the modular device profile.	UINT32	RO	0x01551389 (22352777 <sub>dec</sub> )

**Index 1008 Device name**

Index (hex)	Name	Meaning	Data type	Flags	Default
1008:0	Device name	Device name of the EtherCAT slave	STRING	RO	EL34xx

**Index 1009 Hardware version**

Index (hex)	Name	Meaning	Data type	Flags	Default
1009:0	Hardware version	Hardware version of the EtherCAT slave	STRING	RO	

**Index 100A Software Version**

Index (hex)	Name	Meaning	Data type	Flags	Default
100A:0	Software version	Firmware version of the EtherCAT slave	STRING	RO	

**Index 100B Bootloader version**

Index (hex)	Name	Meaning	Data type	Flags	Default
100B:0	Bootloader version	Bootloader version	STRING	RO	

**Index 1018 Identity**

Index (hex)	Name	Meaning	Data type	Flags	Default
1018:0	Identity	Information for identifying the slave	UINT8	RO	0x04 (4 <sub>dec</sub> )
1018:01	Vendor ID	Vendor ID of the EtherCAT slave	UINT32	RO	0x00000002 (2 <sub>dec</sub> )
1018:02	Product code	Product code of the EtherCAT slave	UINT32	RO	0x0D733052 (225652818 <sub>dez</sub> )
1018:03	Revision	Revision number of the EtherCAT slave; the low word (bit 0-15) indicates the special terminal number, the high word (bit 16-31) refers to the device description	UINT32	RO	0x00000000 (0 <sub>dec</sub> )
1018:04	Serial number	Serial number of the EtherCAT slave; the low byte (bit 0-7) of the low word contains the year of production, the high byte (bit 8-15) of the low word contains the week of production, the high word (bit 16-31) is 0	UINT32	RO	e.g. 0x00001E06 (KW 30/2006)

**Index 10F0 Backup parameter**

Index (hex)	Name	Meaning	Data type	Flags	Default
10F0:0	Backup parameter	Length of this object	UINT8	RO	0x01
10F0:01	Checksum	Checksum	UINT32	RW	0x00000000 (0 <sub>dec</sub> )

**Index 10F3 Diagnosis History**

Index	Name	Meaning	Data type	Flags	Default
10F3:0	Diagnosis History	Maximum subindex	UINT8	RO	0x15 (21 <sub>dec</sub> )
10F3:01	Maximum Messages	Maximum number of stored messages. A maximum of 50 messages can be stored	UINT8	RO	0x00 (0 <sub>dec</sub> )
10F3:02	Newest Message	Subindex of the latest message	UINT8	RO	0x00 (0 <sub>dec</sub> )
10F3:03	Newest Acknowledged Message	Subindex of the last confirmed message	UINT8	RW	0x00 (0 <sub>dec</sub> )
10F3:04	New Messages Available	Indicates that a new message is available	BOOLEAN	RO	0x00 (0 <sub>dec</sub> )
10F3:05	Flags	not used	UINT16	RW	0x0000 (0 <sub>dec</sub> )
10F3:06	Diagnosis Message 001	Message 1	OCTET STRING[28]	RO	{0}
...	...	...	...	...	...
10F3:15	Diagnosis Message 016	Message 16	OCTET STRING[28]	RO	{0}

**Index 10F8 Actual Time Stamp**

Index	Name	Meaning	Data type	Flags	Default
10F8:0	Actual Time Stamp	Time stamp	UINT64	RO	0x0000000000000000 (0 <sub>dec</sub> )

**Index 10F9 Time Distribution Object**

Index	Name	Meaning	Data type	Flags	Default
10F9:0	Time Distribution Object	Max Subindex	UINT8	RO	0x01 (1 <sub>dec</sub> )
10F9:01	Distributed Time Value	Object for time distribution by the EtherCAT Master	INT64	RW	

**Index 1600 Total RxPDO-Map Outputs Device**

Index (hex)	Name	Meaning	Data type	Flags	Default
1600:0	Total RxPDO-Map Outputs Device	PDO Mapping RxPDO 1	UINT8	RO	0x04 (4 <sub>dec</sub> )
1600:01	SubIndex 001	1. PDO Mapping entry (object 0xF700 (PMX Variant Value Out), entry 0x11 (Index 1 REAL))	UINT32	RO	0xF700:11, 16
1600:02	SubIndex 002	2. PDO Mapping entry (object 0xF700 (PMX Variant Value Out), entry 0x12 (Index 2 REAL))	UINT32	RO	0xF700:12, 16
1600:03	SubIndex 003	3. PDO Mapping entry (object 0xF700 (PMX Variant Value Out), entry 0x13 (Index 3 REAL))	UINT32	RO	0xF700:13, 16
1600:04	SubIndex 004	4. PDO Mapping entry (object 0xF700 (PMX Variant Value Out), entry 0x14 (Index 4 ULINT))	UINT32	RO	0xF700:14, 16

**Index 1601 Total RxPDO-Map Interval**

Index (hex)	Name	Meaning	Data type	Flags	Default
1601:0	Total RxPDO-Map Interval	PDO Mapping RxPDO 2	UINT8	RO	0x02 (2 <sub>dec</sub> )
1601:01	SubIndex 001	1. PDO Mapping entry (object 0xF701 (PMX Interval), entry 0x01 (Reset Interval))	UINT32	RO	0xF701:01, 1
1601:02	SubIndex 002	2. PDO Mapping entry (15 bits align)	UINT32	RO	0x0000:00, 15

**Index 1App TxPDO-Map Status (for L1, pp = 00; L2, pp = 0A; L3, pp = 14)**

Index (hex)	Name	Meaning	Data type	Flags	Default
1App:0	TxPDO-Map Status	PDO Mapping TxPDO	UINT8	RO	0x0B (11 <sub>dec</sub> )
1App:01	SubIndex 001	1. PDO Mapping entry (2 bits align)	UINT32	RO	0x60n0:01, 1**
1App:02	SubIndex 002	2. PDO Mapping entry (object 0x60n0 (PMX Status), entry 0x03 (Overcurrent))	UINT32	RO	0x60n0:02, 1**
1App:03	SubIndex 003	3. PDO Mapping entry (object 0x60n0 (PMX Status), entry 0x04 (Inaccurate Voltage))	UINT32	RO	0x60n0:03, 1**
1App:04	SubIndex 004	4. PDO Mapping entry (object 0x60n0 (PMX Status), entry 0x05 (Inaccurate Current))	UINT32	RO	0x60n0:04, 1**
1App:05	SubIndex 005	5. PDO Mapping entry (object 0x60n0 (PMX Status), entry 0x06 (Voltage Guard Warning))	UINT32	RO	0x60n0:05, 1**
1App:06	SubIndex 006	6. PDO Mapping entry (object 0x60n0 (PMX Status), entry 0x07 (Voltage Guard Error))	UINT32	RO	0x60n0:06, 1**
1App:07	SubIndex 007	7. PDO Mapping entry (object 0x60n0 (PMX Status), entry 0x08 (Current Guard Warning))	UINT32	RO	0x60n0:07, 1**
1App:08	SubIndex 008	8. PDO Mapping entry (object 0x60n0 (PMX Status), entry 0x09 (Current Guard Error))	UINT32	RO	0x60n0:08, 1**
1App:09	SubIndex 009	9. PDO Mapping entry (6 bits align)	UINT32	RO	0x60n0:09, 1**
1App:0A	SubIndex 010	10. PDO Mapping entry (object 0x60n0 (PMX Status), entry 0x10 (TxPDO Toggle))	UINT32	RO	0x00n0:00, 6**
1App:0B	SubIndex 011	11. PDO Mapping entry (object 0x60n0 (PMX Status), entry 0x10 (TxPDO Toggle))	UINT32	RO	0x60n0:10, 1**

\*\* ) for L1, n = 0; L2, n = 1; L3, n = 2)

**Index 1App TxPDO-Map Basic (for L1, pp = 01; L2, pp = 0B; L3, pp = 15)**

Index (hex)	Name	Meaning	Data type	Flags	Default
1App:0	TxPDO-Map Statistic Basic	PDO Mapping TxPDO	UINT8	RO	0x02 (2 <sub>dec</sub> )
1App:01	SubIndex 001	1. PDO Mapping entry (object 0x60n1 (PMX Basic), entry 0x11 (Voltage))	UINT32	RO	0x60n1:11, 32**
1App:02	SubIndex 002	2. PDO Mapping entry (object 0x60n1 (PMX Basic), entry 0x12 (Current))	UINT32	RO	0x60n1:12, 32**

\*\* ) for L1, n = 0; L2, n = 1; L3, n = 2)



**Index 1App TxPDO-Map Power (for L1, pp = 02; L2, pp = 0C; L3, pp = 16)**

Index (hex)	Name	Meaning	Data type	Flags	Default
1App:0	TxPDO-Map Power	PDO Mapping TxPDO	UINT8	RO	0x04 (4 <sub>dec</sub> )
1App:01	SubIndex 001	1. PDO Mapping entry (object 0x60n2 (PMX Power), entry 0x11 (Active Power))	UINT32	RO	0x60n2:11, 32**
1App:02	SubIndex 002	2. PDO Mapping entry (object 0x60n2 (PMX Power), entry 0x12 (Apparent Power))	UINT32	RO	0x60n2:12, 32**
1App:03	SubIndex 001	1. PDO Mapping entry (object 0x60n2 (PMX Power), entry 0x13 (Reactive Power))	UINT32	RO	0x60n2:13, 32**
1App:04	SubIndex 002	2. PDO Mapping entry (object 0x60n2 (PMX Power), entry 0x14 (Power Factor))	UINT32	RO	0x60n2:14, 32**

\*\*) for L1, n = 0; L2, n = 1; L3, n = 2)

**Index 1App TxPDO-Map Energy (for L1, pp = 03; L2, pp = 0D; L3, pp = 17)**

Index (hex)	Name	Meaning	Data type	Flags	Default
1App:0	TxPDO-Map Energy	PDO Mapping TxPDO	UINT8	RO	0x03 (3 <sub>dec</sub> )
1App:01	SubIndex 001	1. PDO Mapping entry (object 0x60n4 (PMX Energy), entry 0x11 (Active Energy))	UINT32	RO	0x60n4:11, 64**
1App:02	SubIndex 002	2. PDO Mapping entry (object 0x60n4 (PMX Energy), entry 0x12 (Apparent Energy))	UINT32	RO	0x60n4:12, 64**
1App:03	SubIndex 003	3. PDO Mapping entry (object 0x60n4 (PMX Energy), entry 0x13 (Reactive Energy))	UINT32	RO	0x60n4:13, 64**

\*\*) for L1, n = 0; L2, n = 1; L3, n = 2)

**Index 1App TxPDO-Map Timing (for L1, pp = 04; L2, pp = 0E; L3, pp = 18)**

Index (hex)	Name	Meaning	Data type	Flags	Default
1App:0	TxPDO-Map Statistic Timing	PDO Mapping TxPDO	UINT8	RO	0x02 (2 <sub>dec</sub> )
1App:01	SubIndex 001	1. PDO Mapping entry (object 0x60n6 (PMX Timing), entry 0x12 (Voltage Last Zero Crossing))	UINT32	RO	0x60n6:12, 64**

\*\*) for L1, n = 0; L2, n = 1; L3, n = 2)

**Index 1App TxPDO-Map Advanced (for L1, pp = 05; L2, pp = 0F; L3, pp = 19)**

Index (hex)	Name	Meaning	Data type	Flags	Default
1App:0	TxPDO-Map Advanced	PDO Mapping TxPDO	UINT8	RO	0x06 (6 <sub>dec</sub> )
1App:01	SubIndex 001	1. PDO Mapping entry (15 bits align)	UINT32	RO	0x00n0:00, 15**
1App:02	SubIndex 002	2. PDO Mapping entry (object 0x60n7 (PMX Advanced), entry 0x10 (TxPDO Toggle))	UINT32	RO	0x60n7:10, 1**
1App:03	SubIndex 003	3. PDO Mapping entry (object 0x60n7 (PMX Advanced), entry 0x11 (Voltage Total Harmonic Distortion))	UINT32	RO	0x60n7:11, 32**
1App:04	SubIndex 004	4. PDO Mapping entry (object 0x60n7 (PMX Advanced), entry 0x12 (Current Distortion Factor))	UINT32	RO	0x60n7:12, 32**
1App:05	SubIndex 005	5. PDO Mapping entry (object 0x60n7 (PMX Advanced), entry 0x13 (Current Total Harmonic Distortion))	UINT32	RO	0x60n7:13, 32**
1App:06	SubIndex 006	6. PDO Mapping entry (object 0x60n7 (PMX Advanced), entry 0x14 (Cos Phi))	UINT32	RO	0x60n7:14, 32**

\*\*) for L1, n = 0; L2, n = 1; L3, n = 2)

**Index 1App TxPDO-Map Statistic Voltage (for L1, pp = 06; L2, pp = 10; L3, pp = 1A)**

Index (hex)	Name	Meaning	Data type	Flags	Default
1App:0	TxPDO-Map Statistic Voltage	PDO Mapping TxPDO	UINT8	RO	0x03 (3 <sub>dec</sub> )
1App:01	SubIndex 001	1. PDO Mapping entry (object 0x60n8 (PMX Statistic Voltage), entry 0x11 (Voltage Peak))	UINT32	RO	0x60n8:11, 32**
1App:02	SubIndex 002	2. PDO Mapping entry (object 0x60n8 (PMX Statistic Voltage), entry 0x12 (Voltage RMS Minimum))	UINT32	RO	0x60n8:12, 32**
1App:03	SubIndex 003	3. PDO Mapping entry (object 0x60n8 (PMX Statistic Voltage), entry 0x13 (Voltage RMS Maximum))	UINT32	RO	0x60n8:13, 32**

\*\* ) for L1, n = 0; L2, n = 1; L3, n = 2)

**Index 1App TxPDO-Map Statistic Current (for L1, pp = 07; L2, pp = 11; L3, pp = 1B)**

Index (hex)	Name	Meaning	Data type	Flags	Default
1App:0	L1 TxPDO-Map Statistic Current	PDO Mapping TxPDO 8	UINT8	RO	0x03 (3 <sub>dec</sub> )
1App:01	SubIndex 001	1. PDO Mapping entry (object 0x60n9 (PMX Statistic Current), entry 0x11 (Current Peak))	UINT32	RO	0x60n9:11, 32**
1App:02	SubIndex 002	2. PDO Mapping entry (object 0x60n9 (PMX Statistic Current), entry 0x12 (Current RMS Minimum))	UINT32	RO	0x60n9:12, 32**
1App:03	SubIndex 003	3. PDO Mapping entry (object 0x60n9 (PMX Statistic Current), entry 0x13 (Current RMS Maximum))	UINT32	RO	0x60n9:13, 32**

\*\* ) for L1, n = 0; L2, n = 1; L3, n = 2)

**Index 1App TxPDO-Map Statistic Power (for L1, pp = 08; L2, pp = 12; L3, pp = 1C)**

Index (hex)	Name	Meaning	Data type	Flags	Default
1App:0	TxPDO-Map Statistic Power	PDO Mapping TxPDO	UINT8	RO	0x09 (9 <sub>dec</sub> )
1App:01	SubIndex 001	1. PDO Mapping entry (object 0x60nA (PMX Statistic Power), entry 0x11 (Active Power Avg))	UINT32	RO	0x60nA:11, 32**
1App:02	SubIndex 002	2. PDO Mapping entry (object 0x60nA (PMX Statistic Power), entry 0x12 (Active Power Min))	UINT32	RO	0x60nA:12, 32**
1App:03	SubIndex 003	3. PDO Mapping entry (object 0x60nA (PMX Statistic Power), entry 0x13 (Active Power Max))	UINT32	RO	0x60nA:13, 32**
1App:04	SubIndex 004	4. PDO Mapping entry (object 0x60nA (PMX Statistic Power), entry 0x14 (Apparent Power Avg))	UINT32	RO	0x60nA:14, 32**
1App:05	SubIndex 005	5. PDO Mapping entry (object 0x60nA (PMX Statistic Power), entry 0x15 (Apparent Power Max))	UINT32	RO	0x60nA:15, 32**
1App:06	SubIndex 006	6. PDO Mapping entry (object 0x60nA (PMX Statistic Power), entry 0x16 (Reactive Power Avg))	UINT32	RO	0x60nA:16, 32**
1App:07	SubIndex 007	7. PDO Mapping entry (object 0x60nA (PMX Statistic Power), entry 0x17 (Reactive Power Min))	UINT32	RO	0x60nA:17, 32**
1App:08	SubIndex 008	8. PDO Mapping entry (object 0x60nA (PMX Statistic Power), entry 0x18 (Reactive Power Max))	UINT32	RO	0x60nA:18, 32**
1App:09	SubIndex 009	9. PDO Mapping entry (object 0x60nA (PMX Statistic Power), entry 0x19 (Apparent Power Min))	UINT32	RO	0x60nA:19, 32**

\*\* ) for L1, n = 0; L2, n = 1; L3, n = 2)

**Index 1App TxPDO-Map Classic (for L1, pp = 09; L2, pp = 13; L3, pp = 1D)**

Index (hex)	Name	Meaning	Data type	Flags	Default
1App:0	TxPDO-Map Classic	PDO Mapping TxPDO	UINT8	RO	0x08 (8 <sub>dec</sub> )
1App:01	SubIndex 001	1. PDO Mapping entry (15 bits align)	UINT32	RO	0x00n0:00, 15**
1App:02	SubIndex 002	2. PDO Mapping entry (object 0x60nB (PMX Classic), entry 0x10 (TxPDO Toggle))	UINT32	RO	0x60nB:10, 1**
1App:03	SubIndex 003	3. PDO Mapping entry (object 0x60nB (PMX Classic), entry 0x11 (Voltage))	UINT32	RO	0x60nB:11, 32**
1App:04	SubIndex 004	4. PDO Mapping entry (object 0x60nB (PMX Classic), entry 0x12 (Current))	UINT32	RO	0x60nB:12, 32**
1App:05	SubIndex 005	5. PDO Mapping entry (object 0x60nB (PMX Classic), entry 0x13 (Frequency))	UINT32	RO	0x60nB:13, 32**
1App:06	SubIndex 006	6. PDO Mapping entry (object 0x60nB (PMX Classic), entry 0x14 (Active Power))	UINT32	RO	0x60nB:14, 32**
1App:07	SubIndex 007	7. PDO Mapping entry (object 0x60nB (PMX Classic), entry 0x15 (Apparent Power))	UINT32	RO	0x60nB:15, 32**
1App:08	SubIndex 008	8. PDO Mapping entry (object 0x60nB (PMX Classic), entry 0x16 (Reactive Power))	UINT32	RO	0x60nB:16, 32**

\*\* ) for L1, n = 0; L2, n = 1; L3, n = 2)

**Index 1A1E Total TxPDO-Map Total Status**

Index (hex)	Name	Meaning	Data type	Flags	Default
1A1E:0	Total TxPDO-Map Total Status	PDO Mapping TxPDO 31	UINT8	RO	0x10 (16 <sub>dec</sub> )
1A1E:01	SubIndex 001	1. PDO Mapping entry (object 0xF600 (PMX Total Status), entry 0x01 (System State))	UINT32	RO	0xF600:01, 1
1A1E:02	SubIndex 002	2. PDO Mapping entry (object 0xF600 (PMX Total Status), entry 0x02 (Grid Direction))	UINT32	RO	0xF600:02, 1
1A1E:03	SubIndex 003	3. PDO Mapping entry (object 0xF600 (PMX Total Status), entry 0x03 (Frequency Guard Warning))	UINT32	RO	0xF600:03, 1
1A1E:04	SubIndex 004	4. PDO Mapping entry (object 0xF600 (PMX Total Status), entry 0x04 (Frequency Guard Error))	UINT32	RO	0xF600:04, 1
1A1E:05	SubIndex 005	5. PDO Mapping entry (object 0xF600 (PMX Total Status), entry 0x05 (Neutral Current Guard Warning))	UINT32	RO	0xF600:05, 1
1A1E:06	SubIndex 006	6. PDO Mapping entry (object 0xF600 (PMX Total Status), entry 0x06 (Neutral Current Guard Error))	UINT32	RO	0xF600:06, 1
1A1E:07	SubIndex 007	7. PDO Mapping entry (object 0xF600 (PMX Total Status), entry 0x07 (Active Power Guard Warning))	UINT32	RO	0xF600:07, 1
1A1E:08	SubIndex 008	8. PDO Mapping entry (object 0xF600 (PMX Total Status), entry 0x08 (Active Power Guard Error))	UINT32	RO	0xF600:08, 1
1A1E:09	SubIndex 009	9. PDO Mapping entry (object 0xF600 (PMX Total Status), entry 0x09 (Apparent Power Guard Warning))	UINT32	RO	0xF600:09, 1
1A1E:0A	SubIndex 010	10. PDO Mapping entry (object 0xF600 (PMX Total Status), entry 0x0A (Apparent Power Guard Error))	UINT32	RO	0xF600:0A, 1
1A1E:0B	SubIndex 011	11. PDO Mapping entry (object 0xF600 (PMX Total Status), entry 0x0B (Power Quality Guard Warning))	UINT32	RO	0xF600:0B, 1
1A1E:0C	SubIndex 012	12. PDO Mapping entry (object 0xF600 (PMX Total Status), entry 0x0C (Power Quality Guard Error))	UINT32	RO	0xF600:0C, 1
1A1E:0D	SubIndex 013	13. PDO Mapping entry (2 bits align)	UINT32	RO	0x0000:00, 2
1A1E:0E	SubIndex 014	14. PDO Mapping entry (object 0xF600 (PMX Total Status), entry 0x0E (TxPDO State))	UINT32	RO	0xF600:0E, 1
1A1E:0F	SubIndex 015	15. PDO Mapping entry (object 0xF600 (PMX Total Status), entry 0x10 (TxPDO Toggle))	UINT32	RO	0xF600:10, 1
1A1E:10	SubIndex 016	16. PDO Mapping entry (object 0xF600 (PMX Total Status), entry 0x11 (Power Quality Factor))	UINT32	RO	0xF600:11, 32

**Index 1A1F Total TxPDO-Map Total Basic**

Index (hex)	Name	Meaning	Data type	Flags	Default
1A1F:0	Total TxPDO-Map Total Basic	PDO Mapping TxPDO 32	UINT8	RO	0x03 (3 <sub>dec</sub> )
1A1F:01	SubIndex 001	1. PDO Mapping entry (object 0xF601 (PMX Grid Basic), entry 0x11 (Frequency))	UINT32	RO	0xF601:11, 32
1A1F:02	SubIndex 002	2. PDO Mapping entry (object 0xF601 (PMX Grid Basic), entry 0x12 (Power Factor))	UINT32	RO	0xF601:12, 32
1A1F:03	SubIndex 003	3. PDO Mapping entry (object 0xF601 (PMX Grid Basic), entry 0x13 (Calculated Neutral Line Current))	UINT32	RO	0xF601:13, 32

**Index 1A20 Total TxPDO-Map Advanced**

Index (hex)	Name	Meaning	Data type	Flags	Default
1A20:0	Total TxPDO-Map Advanced	PDO Mapping TxPDO 33	UINT8	RO	0x08 (8 <sub>dec</sub> )
1A20:01	SubIndex 001	1. PDO Mapping entry (object 0xF602 (PMX Grid Advanced), entry 0x11 (Max Voltage Harmonic Distortion))	UINT32	RO	0xF602:01, 1
1A20:02	SubIndex 002	2. PDO Mapping entry (object 0xF602 (PMX Grid Advanced), entry 0x12 (Max Current Harmonic Distortion))	UINT32	RO	0xF602:02, 1
1A20:03	SubIndex 003	3. PDO Mapping entry (13 bits align)	UINT32	RO	0x0000:00, 13
1A20:04	SubIndex 004	4. PDO Mapping entry (object 0xF602 (PMX Grid Advanced), entry 0x14 (Voltage Unbalance))	UINT32	RO	0xF602:10, 1
1A20:05	SubIndex 005	5. PDO Mapping entry (object 0xF602 (PMX Total Advanced), entry 0x11 (Max Voltage Harmonic Distortion))	UINT32	RO	0xF602:11, 32
1A20:06	SubIndex 006	6. PDO Mapping entry (object 0xF602 (PMX Total Advanced), entry 0x12 (Max Current Harmonic Distortion))	UINT32	RO	0xF602:12, 32
1A20:07	SubIndex 007	7. PDO Mapping entry (object 0xF602 (PMX Total Advanced), entry 0x13 (Max Current Distortion Factor))	UINT32	RO	0xF602:13, 32
1A20:08	SubIndex 008	8. PDO Mapping entry (object 0xF602 (PMX Total Advanced), entry 0x14 (Voltage Unbalance))	UINT32	RO	0xF602:14, 32

**Index 1A21 Total TxPDO-Map Total Active**

Index (hex)	Name	Meaning	Data type	Flags	Default
1A21:0	Total TxPDO-Map Total Active	PDO Mapping TxPDO 34	UINT8	RO	0x04 (4 <sub>dec</sub> )
1A21:01	SubIndex 001	1. PDO Mapping entry (32 bits align)	UINT32	RO	0x0000:00, 32
1A21:02	SubIndex 002	2. PDO Mapping entry (object 0xF603 (PMX Total Active), entry 0x12 (Active Energy))	UINT32	RO	0xF603:12, 64
1A21:03	SubIndex 003	3. PDO Mapping entry (object 0xF603 (PMX Total Active), entry 0x13 (Active Positive Energy))	UINT32	RO	0xF603:13, 64
1A21:04	SubIndex 004	4. PDO Mapping entry (object 0xF603 (PMX Total Active), entry 0x14 (Active Negative Energy))	UINT32	RO	0xF603:14, 64

**Index 1A22 Total TxPDO-Map Apparent**

Index (hex)	Name	Meaning	Data type	Flags	Default
1A22:0	Total TxPDO-Map Apparent	PDO Mapping TxPDO 35	UINT8	RO	0x04 (4 <sub>dec</sub> )
1A22:01	SubIndex 001	1. PDO Mapping entry (32 bits align)	UINT32	RO	0x0000:00, 32
1A22:02	SubIndex 002	2. PDO Mapping entry (object 0xF605 (PMX Total Apparent), entry 0x12 (Apparent Energy))	UINT32	RO	0xF605:12, 64
1A22:03	SubIndex 003	3. PDO Mapping entry (object 0xF605 (PMX Total Apparent), entry 0x13 (Apparent Positive Energy))	UINT32	RO	0xF605:13, 64
1A22:04	SubIndex 004	4. PDO Mapping entry (object 0xF605 (PMX Total Apparent), entry 0x14 (Apparent Negative Energy))	UINT32	RO	0xF605:14, 64

**Index 1A23 Total TxPDO-Map Reactive**

Index (hex)	Name	Meaning	Data type	Flags	Default
1A23:0	Total TxPDO-Map Reactive	PDO Mapping TxPDO 36	UINT8	RO	0x04 (4 <sub>dec</sub> )
1A23:01	SubIndex 001	1. PDO Mapping entry (32 bits align)	UINT32	RO	0x0000:00, 32
1A23:02	SubIndex 002	2. PDO Mapping entry (object 0xF607 (PMX Total Reactive), entry 0x12 (Reactive Energy))	UINT32	RO	0xF607:12, 64
1A23:03	SubIndex 003	3. PDO Mapping entry (object 0xF607 (PMX Total Reactive), entry 0x13 (Reactive Positive Energy))	UINT32	RO	0xF607:13, 64
1A23:04	SubIndex 004	4. PDO Mapping entry (object 0xF607 (PMX Total Reactive), entry 0x14 (Reactive Negative Energy))	UINT32	RO	0xF607:14, 64

**Index 1A24 Total TxPDO-Map Total L-L Voltage**

Index (hex)	Name	Meaning	Data type	Flags	Default
1A24:0	Total TxPDO-Map Total L-L Voltage	PDO Mapping TxPDO 37	UINT8	RO	0x03 (3 <sub>dec</sub> )
1A24:01	SubIndex 001	1. PDO Mapping entry (object 0xF609 (PMX Grid L-L Voltages), entry 0x11 (L1-L2 Voltage))	UINT32	RO	0xF609:11, 32
1A24:02	SubIndex 002	2. PDO Mapping entry (object 0xF609 (PMX Grid L-L Voltages), entry 0x12 (L2-L3 Voltage))	UINT32	RO	0xF609:12, 32
1A24:03	SubIndex 003	3. PDO Mapping entry (object 0xF609 (PMX Grid L-L Voltages), entry 0x13 (L3-L1 Voltage))	UINT32	RO	0xF609:13, 32

**Index 1A25 Total TxPDO-Map Variant Value In**

Index (hex)	Name	Meaning	Data type	Flags	Default
1A25:0	Total TxPDO-Map Variant Value In	PDO Mapping TxPDO 38	UINT8	RO	0x0A (10 <sub>dec</sub> )
1A25:01	SubIndex 001	1. PDO Mapping entry (15 bits align)	UINT32	RO	0x0000:00, 15
1A25:02	SubIndex 002	2. PDO Mapping entry (object 0xF60A (PMX Variant Value In), entry 0x10 (TxPDO Toggle))	UINT32	RO	0xF60A:10, 1
1A25:03	SubIndex 003	3. PDO Mapping entry (object 0xF60A (PMX Variant Value In), entry 0x11 (Index 1 REAL))	UINT32	RO	0xF60A:11, 16
1A25:04	SubIndex 004	4. PDO Mapping entry (object 0xF60A (PMX Variant Value In), entry 0x12 (Value 1 REAL))	UINT32	RO	0xF60A:12, 32
1A25:05	SubIndex 005	5. PDO Mapping entry (object 0xF60A (PMX Variant Value In), entry 0x13 (Index 2 REAL))	UINT32	RO	0xF60A:13, 16
1A25:06	SubIndex 006	6. PDO Mapping entry (object 0xF60A (PMX Variant Value In), entry 0x14 (Value 2 REAL))	UINT32	RO	0xF60A:14, 32
1A25:07	SubIndex 007	7. PDO Mapping entry (object 0xF60A (PMX Variant Value In), entry 0x13 (Index 3 REAL))	UINT32	RO	0xF60A:15, 16
1A25:08	SubIndex 008	8. PDO Mapping entry (object 0xF60A (PMX Variant Value In), entry 0x16 (Value 3 REAL))	UINT32	RO	0xF60A:16, 32
1A25:09	SubIndex 009	9. PDO Mapping entry (object 0xF60A (PMX Variant Value In), entry 0x17 (Index 4 ULINT))	UINT32	RO	0xF60A:17, 16
1A25:0A	SubIndex 010	10. PDO Mapping entry (object 0xF60A (PMX Variant Value In), entry 0x18 (Value 4 ULINT))	UINT32	RO	0xF60A:18, 64

**Index 1A26 Total TxPDO-Map Statistic Power**

Index (hex)	Name	Meaning	Data type	Flags	Default
1A26:0	Total TxPDO-Map Statistic Power	PDO Mapping TxPDO 39	UINT8	RO	0x09 (9 <sub>dec</sub> )
1A26:01	SubIndex 001	1. PDO Mapping entry (object 0xF60B (PMX Total Statistic Power), entry 0x11 (Active Power Avg))	UINT32	RO	0xF60B:11, 32
1A26:02	SubIndex 002	2. PDO Mapping entry (object 0xF60B (PMX Total Statistic Power), entry 0x12 (Active Power Min))	UINT32	RO	0xF60B:12, 32
1A26:03	SubIndex 003	3. PDO Mapping entry (object 0xF60B (PMX Total Statistic Power), entry 0x13 (Active Power Max))	UINT32	RO	0xF60B:13, 32
1A26:04	SubIndex 004	4. PDO Mapping entry (object 0xF60B (PMX Total Statistic Power), entry 0x14 (Apparent Power Avg))	UINT32	RO	0xF60B:14, 32
1A26:05	SubIndex 005	5. PDO Mapping entry (object 0xF60B (PMX Total Statistic Power), entry 0x15 (Apparent Power Min))	UINT32	RO	0xF60B:15, 32
1A26:06	SubIndex 006	6. PDO Mapping entry (object 0xF60B (PMX Total Statistic Power), entry 0x16 (Apparent Power Max))	UINT32	RO	0xF60B:16, 32
1A26:07	SubIndex 007	7. PDO Mapping entry (object 0xF60B (PMX Total Statistic Power), entry 0x17 (Reactive Power Avg))	UINT32	RO	0xF60B:17, 32
1A26:08	SubIndex 008	8. PDO Mapping entry (object 0xF60B (PMX Total Statistic Power), entry 0x18 (Reactive Power Min))	UINT32	RO	0xF60B:18, 32
1A26:09	SubIndex 009	9. PDO Mapping entry (object 0xF60B (PMX Total Statistic Power), entry 0x19 (Reactive Power Max))	UINT32	RO	0xF60B:19, 32

**Index 1A27 Total TxPDO-Map Statistic PQF**

Index (hex)	Name	Meaning	Data type	Flags	Default
1A27:0	Total TxPDO-Map Statistic PQF	PDO Mapping TxPDO 40	UINT8	RO	0x03 (3 <sub>dec</sub> )
1A27:01	SubIndex 001	1. PDO Mapping entry (object 0xF60C (PMX Total Statistic PQF), entry 0x11 (PQF Avg))	UINT32	RO	0xF60C:11, 32
1A27:02	SubIndex 002	2. PDO Mapping entry (object 0xF60C (PMX Total Statistic PQF), entry 0x12 (PQF Min))	UINT32	RO	0xF60C:12, 32
1A27:03	SubIndex 003	3. PDO Mapping entry (object 0xF60C (PMX Total Statistic PQF), entry 0x13 (PQF Max))	UINT32	RO	0xF60C:13, 32

**Index 1A28 Total TxPDO-Map Interval Energy**

Index (hex)	Name	Meaning	Data type	Flags	Default
1A28:0	Total TxPDO-Map Interval Energy	PDO Mapping TxPDO 41	UINT8	RO	0x0B (11 <sub>dec</sub> )
1A28:01	SubIndex 001	1. PDO Mapping entry (15 bits align)	UINT32	RO	0x0000:00, 15
1A28:02	SubIndex 002	2. PDO Mapping entry (object 0xF60D (PMX Total Interval Energy), entry 0x10 (TxPDO Toggle))	UINT32	RO	0xF60D:10, 1
1A28:03	SubIndex 003	3. PDO Mapping entry (object 0xF60D (PMX Total Interval Energy), entry 0x11 (Active Energy))	UINT32	RO	0xF60D:11, 32
1A28:04	SubIndex 004	4. PDO Mapping entry (object 0xF60D (PMX Total Interval Energy), entry 0x12 (Active Energy Positive))	UINT32	RO	0xF60D:12, 32
1A28:05	SubIndex 005	5. PDO Mapping entry (object 0xF60D (PMX Total Interval Energy), entry 0x13 (Active Energy Negative))	UINT32	RO	0xF60D:13, 32
1A28:06	SubIndex 006	6. PDO Mapping entry (object 0xF60D (PMX Total Interval Energy), entry 0x14 (Apparent Energy))	UINT32	RO	0xF60D:14, 32
1A28:07	SubIndex 007	7. PDO Mapping entry (object 0xF60D (PMX Total Interval Energy), entry 0x15 (Apparent Energy Positive))	UINT32	RO	0xF60D:15, 32
1A28:08	SubIndex 008	8. PDO Mapping entry (object 0xF60D (PMX Total Interval Energy), entry 0x16 (Apparent Energy Negative))	UINT32	RO	0xF60D:16, 32
1A28:09	SubIndex 009	9. PDO Mapping entry (object 0xF60D (PMX Total Interval Energy), entry 0x17 (Reactive Energy))	UINT32	RO	0xF60D:17, 32
1A28:0A	SubIndex 010	10. PDO Mapping entry (object 0xF60D (PMX Total Interval Energy), entry 0x18 (Reactive Energy Positive))	UINT32	RO	0xF60D:18, 32
1A28:0B	SubIndex 011	11. PDO Mapping entry (object 0xF60D (PMX Total Interval Energy), entry 0x19 (Reactive Energy Negative))	UINT32	RO	0xF60D:19, 32

**Index 1A29 Total TxPDO-Map Active Reduced**

Index (hex)	Name	Meaning	Data type	Flags	Default
1A29:0	Total TxPDO-Map Active Reduced	PDO Mapping TxPDO 35	UINT8	RO	0x02 (2 <sub>dec</sub> )
1A29:01	SubIndex 001	1. PDO Mapping entry (object 0xF612 (PMX Total Active Reduced), entry 0x11 (Active Power))	UINT32	RO	0xF612:11, 32
1A29:02	SubIndex 002	2. PDO Mapping entry (object 0xF612 (PMX Total Active Reduced), entry 0x12 (Active Energy))	UINT32	RO	0xF612:12, 64

**Index 1A2A Total TxPDO-Map Apparent Reduced**

Index (hex)	Name	Meaning	Data type	Flags	Default
1A2A:0	Total TxPDO-Map Apparent Reduced	PDO Mapping TxPDO 35	UINT8	RO	0x02 (2 <sub>dec</sub> )
1A2A:01	SubIndex 001	1. PDO Mapping entry (Aligned)	UINT32	RO	0x0000:00, 32
1A2A:02	SubIndex 002	2. PDO Mapping entry (object 0xF613 (PMX Total Apparent Reduced), entry 0x12 (Apparent Energy))	UINT32	RO	0xF613:12, 64

**Index 1A2B Total TxPDO-Map Reactive Reduced**

Index (hex)	Name	Meaning	Data type	Flags	Default
1A2B:0	Total TxPDO-Map Reactive Reduced	PDO Mapping TxPDO 36	UINT8	RO	0x02 (2 <sub>dec</sub> )
1A2B:01	SubIndex 001	1. PDO Mapping entry (Aligned)	UINT32	RO	0x0000:00, 32
1A2B:02	SubIndex 002	2. PDO Mapping entry (object 0xF614 (PMX Total Reactive Reduced), entry 0x12 (Reactive Energy))	UINT32	RO	0xF614:12, 64

**Index 1A2C Total TxPDO-Map Interval Energy Reduced**

Index (hex)	Name	Meaning	Data type	Flags	Default
1A2C:0	Total TxPDO-Map Interval Energy Reduced	PDO Mapping TxPDO 36	UINT8	RO	0x05 (5 <sub>dec</sub> )
1A2C:01	SubIndex 001	1. PDO Mapping entry (align)	UINT32	RO	0x0000:00, 15
1A2C:02	SubIndex 002	2. PDO Mapping entry (object 0xF615 (PMX Total Interval Energy Reduced), entry 0x10 (TxPDO Toggle))	UINT32	RO	0xF615:10, 1
1A2C:03	SubIndex 003	3. PDO Mapping entry (object 0xF615 (PMX Total Interval Energy Reduced), entry 0x11 (Active Energy))	UINT32	RO	0xF615:11, 32
1A2C:04	SubIndex 004	4. PDO Mapping entry (object 0xF615 (PMX Total Interval Energy Reduced), entry 0x12 (Apparent Energy))	UINT32	RO	0xF615:12, 32
1A2C:05	SubIndex 005	5. PDO Mapping entry (object 0xF615 (PMX Total Interval Energy Reduced), entry 0x13 (reactive Energy))	UINT32	RO	0xF615:13, 32

**Index 1C00 Sync manager type**

Index (hex)	Name	Meaning	Data type	Flags	Default
1C00:0	Sync manager type	Length of this object	UINT8	RO	0x04 (4 <sub>dec</sub> )
1C00:01	SubIndex 001	Sync-Manager Type Channel 1: Mailbox Write	UINT8	RW	0x01 (1 <sub>dec</sub> )
1C00:02	SubIndex 002	Sync-Manager Type Channel 2: Mailbox Read	UINT8	RW	0x02 (2 <sub>dec</sub> )
1C00:03	SubIndex 003	Sync-Manager Type Channel 3: Process Data Write (Outputs)	UINT8	RW	0x03 (3 <sub>dec</sub> )
1C00:04	SubIndex 004	Sync-Manager Type Channel 4: Process Data Read (Inputs)	UINT8	RW	0x04 (4 <sub>dec</sub> )

**Index 1C12 RxPDO assign**

Index (hex)	Name	Meaning	Data type	Flags	Default
1C12:0	RxPDO assign	PDO Assign Outputs	UINT8	RW	0x01 (1 <sub>dec</sub> )
1C12:01	SubIndex 001	1. allocated RxPDO (contains the index of the associated RxPDO mapping object)	UINT16	RW	0x1601 (5633 <sub>dec</sub> )

## Index 1C13 TxPDO assign

Index (hex)	Name	Meaning	Data type	Flags	Default
1C13:0	TxPDO assign	PDO Assign Inputs	UINT8	RW	0x10 (16 <sub>dec</sub> )
1C13:01	Subindex 001	1. allocated TxPDO (contains the index of the associated TxPDO mapping object)	UINT16	RW	0x1A00 (6656 <sub>dec</sub> )
1C13:02	Subindex 002	2. allocated TxPDO (contains the index of the associated TxPDO mapping object)	UINT16	RW	0x1A01 (6657 <sub>dec</sub> )
1C13:03	Subindex 003	3. allocated TxPDO (contains the index of the associated TxPDO mapping object)	UINT16	RW	0x1A02 (6658 <sub>dec</sub> )
1C13:04	Subindex 004	4. allocated TxPDO (contains the index of the associated TxPDO mapping object)	UINT16	RW	0x1A04 (6660 <sub>dec</sub> )
1C13:05	Subindex 005	5. allocated TxPDO (contains the index of the associated TxPDO mapping object)	UINT16	RW	0x1A0A (6666 <sub>dec</sub> )
1C13:06	Subindex 006	6. allocated TxPDO (contains the index of the associated TxPDO mapping object)	UINT16	RW	0x1A0B (6667 <sub>dec</sub> )
1C13:07	Subindex 007	7. allocated TxPDO (contains the index of the associated TxPDO mapping object)	UINT16	RW	0x1A0C (6668 <sub>dec</sub> )
1C13:08	Subindex 008	8. allocated TxPDO (contains the index of the associated TxPDO mapping object)	UINT16	RW	0x1A0E (6670 <sub>dec</sub> )
1C13:09	Subindex 009	9. allocated TxPDO (contains the index of the associated TxPDO mapping object)	UINT16	RW	0x1A14 (6676 <sub>dec</sub> )
1C13:0A	Subindex 010	10. allocated TxPDO (contains the index of the associated TxPDO mapping object)	UINT16	RW	0x1A15 (6677 <sub>dec</sub> )
1C13:0B	Subindex 011	11. allocated TxPDO (contains the index of the associated TxPDO mapping object)	UINT16	RW	0x1A16 (6678 <sub>dec</sub> )
1C13:0C	Subindex 012	12. allocated TxPDO (contains the index of the associated TxPDO mapping object)	UINT16	RW	0x1A18 (6680 <sub>dec</sub> )
1C13:0D	Subindex 013	13. allocated TxPDO (contains the index of the associated TxPDO mapping object)	UINT16	RW	0x1A1E (6686 <sub>dec</sub> )
1C13:0E	Subindex 014	14. allocated TxPDO (contains the index of the associated TxPDO mapping object)	UINT16	RW	0x1A1F (6687 <sub>dec</sub> )
1C13:0F	Subindex 015	15. allocated TxPDO (contains the index of the associated TxPDO mapping object)	UINT16	RW	0x1A21 (6689 <sub>dec</sub> )
1C13:10	Subindex 016	16. allocated TxPDO (contains the index of the associated TxPDO mapping object)	UINT16	RW	0x1A24 (6692 <sub>dec</sub> )
1C13:11	Subindex 017	17. allocated TxPDO (contains the index of the associated TxPDO mapping object)	UINT16	RW	0x0000 (0 <sub>dec</sub> )
...					
1C13:2E	Subindex 046	46. allocated TxPDO (contains the index of the associated TxPDO mapping object)	UINT16	RW	0x0000 (0 <sub>dec</sub> )



**Index 1C32 SM output parameter**

Index	Name	Meaning	Data type	Flags	Default
1C32:0	SM output parameter	Synchronization parameters for the outputs	UINT8	RO	0x20 (32 <sub>dec</sub> )
1C32:01	Sync mode	Current synchronization mode: 0: Free Run 1: Synchron with SM 2 Event 2: DC-Mode - Synchron with SYNC0 Event 3: DC-Mode - Synchron with SYNC1 Event	UINT16	RW	0x0000 (0 <sub>dec</sub> )
1C32:02	Cycle time	Cycle time (in ns): Free Run: Cycle time of the local timer Synchron with SM 2 Event: Master cycle time DC mode: SYNC0/SYNC1 Cycle Time	UINT32	RW	0x0016E360 (1500000 <sub>dec</sub> )
1C32:03	Shift time	Time between SYNC0 event and output of the outputs (in ns, DC mode only)	UINT32	RO	0x00000384 (900 <sub>dec</sub> )
1C32:04	Sync modes supported	Supported synchronization modes: Bit 0 = 1: free run is supported Bit 1 = 1: synchronous with SM 2 event is supported Bit 2-3 = 01: DC mode is supported Bit 4-5 = 10: Output shift with SYNC1 event (only DC mode) Bit 14 = 1: dynamic times (measurement through writing of 1C32:08)	UINT16	RO	0x0805 (2053 <sub>dec</sub> )
1C32:05	Minimum cycle time	Minimum cycle time (in ns)	UINT32	RO	0x0007A120 (500000 <sub>dec</sub> )
1C32:06	Calc and copy time	Minimum time between SYNC0 and SYNC1 event (in ns, DC mode only)	UINT32	RO	0x00000384 (900 <sub>dec</sub> )
1C32:07	Minimum delay time		UINT32	RO	0x00000384 (900 <sub>dec</sub> )
1C32:08	Command	0: Measurement of the local cycle time is stopped 1: Measurement of the local cycle time is started The entries 1C32:03, 1C32:05, 1C32:06, 1C32:09, 1C33:03, 1C33:06, 1C33:09 are updated with the maximum measured values. For a subsequent measurement the measured values are reset	UINT16	RW	0x0000 (0 <sub>dec</sub> )
1C32:09	Maximum delay time	Time between SYNC1 event and output of the outputs (in ns, DC mode only)	UINT32	RO	0x00000384 (900 <sub>dec</sub> )
1C32:0B	SM event missed counter	Number of missed SM events in OPERATIONAL (DC mode only)	UINT16	RO	0x0000 (0 <sub>dec</sub> )
1C32:0C	Cycle exceeded counter	Number of occasions the cycle time was exceeded in OPERATIONAL (cycle was not completed in time or the next cycle began too early)	UINT16	RO	0x0000 (0 <sub>dec</sub> )
1C32:0D	Shift too short counter	Number of occasions that the interval between SYNC0 and SYNC1 event was too short (DC mode only)	UINT16	RO	0x0000 (0 <sub>dec</sub> )

## Index 1C33 SM input parameter

Index (hex)	Name	Meaning	Data type	Flags	Default
1C33:0	SM input parameter	Synchronization parameters for the inputs	UINT8	RO	0x20 (32 <sub>dec</sub> )
1C33:01	Sync mode	Current synchronization mode: 0: Free Run 1: Synchron with SM 3 Event (no outputs available) 2: DC - Synchron with SYNC0 Event 3: DC - Synchron with SYNC1 Event 34: Synchron with SM 2 event (outputs available)	UINT16	RW	0x0000 (0 <sub>dec</sub> )
1C33:02	Cycle time	as 1C32:02	UINT32	RW	0x0016E360 (1500000 <sub>dec</sub> )
1C33:03	Shift time	Time between SYNC0 event and reading of the inputs (in ns, only DC mode)	UINT32	RO	0x00000384 (900 <sub>dec</sub> )
1C33:04	Sync modes supported	Supported synchronization modes: Bit 0: free run is supported Bit 1: Synchron with SM 2 Event is supported (outputs available) Bit 1: Synchron with SM 3 Event is supported (no outputs available) Bit 2-3 = 01: DC mode is supported Bit 4-5 = 01: Input shift through local event (outputs available) Bit 4-5 = 10: Input shift with SYNC1 event (no outputs available) Bit 14 = 1: dynamic times (measurement through writing of 1C32:08 or 1C33:08)	UINT16	RO	0x0805 (2053 <sub>dec</sub> )
1C33:05	Minimum cycle time	as 1C32:05	UINT32	RO	0x0007A120 (500000 <sub>dec</sub> )
1C33:06	Calc and copy time	Time between reading of the inputs and availability of the inputs for the master (in ns, only DC mode)	UINT32	RO	0x0007A120 (500000 <sub>dec</sub> )
1C33:07	Minimum delay time		UINT32	RO	0x00000384 (900 <sub>dec</sub> )
1C33:08	Command	as 1C32:08	UINT16	RW	0x0000 (0 <sub>dec</sub> )
1C33:09	Maximum delay time	Time between SYNC1 event and reading of the inputs (in ns, only DC mode)	UINT32	RO	0x00000384 (900 <sub>dec</sub> )
1C33:0B	SM event missed counter	as 1C32:11	UINT16	RO	0x0000 (0 <sub>dec</sub> )
1C33:0C	Cycle exceeded counter	as 1C32:12	UINT16	RO	0x0000 (0 <sub>dec</sub> )
1C33:0D	Shift too short counter	as 1C32:13	UINT16	RO	0x0000 (0 <sub>dec</sub> )

## Index F000 Modular device profile

Index (hex)	Name	Meaning	Data type	Flags	Default
F000:0	Modular device profile	Largest subindex of this object	UINT8	RO	0x02 (2 <sub>dec</sub> )
F000:01	Module index distance	Index distance of the objects of the individual channels	UINT16	RW	0x0010 (16 <sub>dec</sub> )
F000:02	Maximum number of modules	Number of channels	UINT16	RW	0x0003 (3 <sub>dec</sub> )

## Index F008 Code word

Index (hex)	Name	Meaning	Data type	Flags	Default
F008:0	Code word	reserved	UINT32	RW	0x00000000 (0 <sub>dec</sub> )

**Code Word**

The vendor reserves the authority for the basic calibration of the terminals. The code word is therefore at present reserved.

**Index F010 Module List**

Index (hex)	Name	Meaning	Data type	Flags	Default
F010:0	Module list		UINT8	RW	0x03 (3 <sub>dec</sub> )
F010:01	SubIndex 001		UINT32	RW	0x00000155 (341 <sub>dec</sub> )
F010:02	SubIndex 002		UINT32	RW	0x00000155 (341 <sub>dec</sub> )
F010:03	SubIndex 003		UINT32	RW	0x00000155 (341 <sub>dec</sub> )

**6.6.2.8 Command object**

**Index FB00 PMX Command**

The command object is used for triggering an action in the terminal. The command is started by writing subindex 1 (request). Write access is disabled until the current command is completed.

Index (hex)	Name	Meaning	Data type	Flags	Default	
FB00:0	PM Command	Largest subindex of this object	UINT8	RO	0x03 (3 <sub>dec</sub> )	
FB00:01	Request	<b>Byte 0 - service request data</b>	OCTET-STRING [2]	RW	0x0000 (0 <sub>dec</sub> )	
		4 <sub>hex</sub>				Clear energy or reset all energy counters
		<b>Byte 1 - channel selection</b>				
		00 <sub>hex</sub>				all channels
		01 <sub>hex</sub>				Channel 1
		02 <sub>hex</sub>	Channel 2			
		03 <sub>hex</sub>	Channel 3			
FB00:02	Status	<b>Byte 0</b> reserved	UINT8	RW	0x00 (0 <sub>dec</sub> )	
FB00:03	Response	<b>Byte 0</b> reserved	OCTET-STRING [2]	RW	0x00000000 (0 <sub>dec</sub> )	
		<b>Byte 1</b> reserved				
		<b>Byte 2-n</b> reserved				

## 6.6.3 EL3446

### 6.6.3.1 Restore object

#### Index 1011 Restore default parameters

Index (hex)	Name	Meaning	Data type	Flags	Default
1011:0	Restore default parameters <a href="#">▶ 316</a>	Restore default parameters	UINT8	RO	0x01 (1 <sub>dec</sub> )
1011:01	SubIndex 001	If this object is set to “ <b>0x64616F6C</b> ” in the set value dialog, all backup objects are reset to their delivery state.	UINT32	RW	0x00000000 (0 <sub>dec</sub> )

### 6.6.3.2 Configuration data

#### Index 80n0 DPM Channel Settings (for Ch.1, n = 0; Ch.2, n = 1; Ch.3, n = 2; Ch.4, n = 3; Ch.5, n = 4; Ch.6, n = 5)

Index (hex)	Name	Meaning	Data type	Flags	Default
80n0:0	DPM Channel Settings	Max. subindex	UINT8	RO	0x13 (19 <sub>dec</sub> )
80n0:11	Supply Channel	Selection of the voltage reference: 0: no reference 1: Channel 1 2: Channel 2 3: Channel 3	UINT32	RW	Channel 1 (1)
80n0:12	Current Transformer Ratio	Here the transmission ratio of the current transformer used can be entered.	REAL32	RW	1.000000 (1.000000e+000)
80n0:13	Current Transformer Delay	A possible time delay of the current transformers in milliseconds can be entered here.	REAL32	RW	0.000000 (0.000000e+000)

#### Index 80n1 DPM Channel User Scale (for Ch.1, n = 0; Ch.2, n = 1; Ch.3, n = 2; Ch.4, n = 3; Ch.5, n = 4; Ch.6, n = 5)

Index (hex)	Name	Meaning	Data type	Flags	Default
80n1:0	DPM Channel User Scale	Max. subindex	UINT8	RO	0x15 (21 <sub>dec</sub> )
80n1:01	User Calibration Enable	Set to true to enable user calibration data.	BOOLEAN	RW	0x00 (0 <sub>dec</sub> )
80n1:11	User Calibration Current Offset	Value in A	REAL32	RW	0.000000 (0.000000e+000)
80n1:12	User Calibration Current Gain	Factor (without unit)	REAL32	RW	1.000000 (1.000000e+000)
80n1:13	User Calibration Phase Offset	Value in milliseconds	REAL32	RW	0.000000 (0.000000e+000)

**Index 80n2 DPM Channel Guard Settings - EL3446 (for Ch.1, n = 0; Ch.2, n = 1; Ch.3, n = 2; Ch.4, n = 3; Ch.5, n = 4; Ch.6, n = 5)**

Index (hex)	Name	Meaning	Data type	Flags	Default
80n2:0	DPM Channel Guard Settings	Max. subindex	UINT8	RO	0x14 (20 <sub>dec</sub> )
80n2:01	Voltage Guard Min Error	Lower limit value for a voltage error message [V]	REAL32	RW	2.000000 (2.000000e+000)
80n2:02	Voltage Guard Min Warning	Lower limit value for a voltage warning message [V]	REAL32	RW	207.000000 (2.070000e+002)
80n2:03	Voltage Guard Max Warning	Upper limit value for a voltage warning message [V]	REAL32	RW	253.000000 (2.530000e+002)
80n2:04	Voltage Guard Max Error	Upper limit value for a voltage error message [V]	REAL32	RW	278.000000 (2.780000e+002)
80n2:05	Current Guard Min Error	Lower limit value for a current error message [A]	REAL32	RW	-1.050000 (-1.050000e+000)
80n2:06	Current Guard Min Warning	Lower limit value for a current warning message [A]	REAL32	RW	-1.000000 (-1.000000e+000)
80n2:07	Current Guard Max Warning	Upper limit value for a current warning message [A]	REAL32	RW	1.000000 (1.000000e+000)
80n2:08	Current Guard Max Error	Upper limit value for a current error message [A]	REAL32	RW	1.050000 (1.050000e+000)
80n2:09	Active Power Guard Min Error	Lower limit value for an active power error message [W]	REAL32	RW	-241.500000 (-2.415000e+002)
80n2:0A	Active Power Guard Min Warning	Lower limit value for an active power warning message [W]	REAL32	RW	-230.000000 (-2.300000e+002)
80n2:0B	Active Power Guard Max Warning	Upper limit value for an active power warning message [W]	REAL32	RW	230.000000 (2.300000e+002)
80n2:0C	Active Power Guard Max Error	Upper limit value for an active power error message [W]	REAL32	RW	241.500000 (2.415000e+002)
80n2:0D	Apparent Power Guard Min Error	Lower limit value for an apparent power error message [VA]	REAL32	RW	0.000000 (0.000000e+000)
80n2:0E	Apparent Power Guard Min Warning	Lower limit value for an apparent power warning message [VA]	REAL32	RW	0.000000 (0.000000e+000)
80n2:0F	Apparent Power Guard Max Warning	Upper limit value for an apparent power warning message [VA]	REAL32	RW	230.000000 (2.300000e+002)
80n2:10	Apparent Power Guard Max Error	Upper limit value for an apparent power error message [VA]	REAL32	RW	241.500000 (2.415000e+002)
80n2:11	Reactive Power Guard Min Error	Lower limit value for a reactive power error message [var]	REAL32	RW	0.000000 (0.000000e+000)
80n2:12	Reactive Power Guard Min Warning	Lower limit value for a reactive power warning message [var]	REAL32	RW	0.000000 (0.000000e+000)
80n2:13	Reactive Power Guard Max Warning	Upper limit value for a reactive power warning message [var]	REAL32	RW	230.000000 (2.300000e+002)
80n2:14	Reactive Power Guard Max Error	Upper limit value for a reactive power error message [var]	REAL32	RW	241.500000 (2.415000e+002)

**6.6.3.3 Configuration data (vendor-specific)**

**Index 80nF DPM Channel Vendor data (for Ch.1, n = 0; Ch.2, n = 1; Ch.3, n = 2; Ch.4, n = 3; Ch.5, n = 4; Ch.6, n = 5)**

Index (hex)	Name	Meaning	Data type	Flags	Default
80nF:0	DPM Channel Vendor data	Max. subindex	UINT8	RO	0x13 (19 <sub>dec</sub> )
80nF:11	Calibration Current Offset	Value in A	REAL32	RW	0.000000 (0.000000e+000)
80nF:12	Calibration Current Gain	Factor (without unit)	REAL32	RW	1.000000 (1.000000e+000)
80nF:13	Calibration Current Phase Offset	Value in milliseconds	REAL32	RW	0.000000 (0.000000e+000)

### 6.6.3.4 Input data

#### Index 606A DPM Variant Value In

Index (hex)	Name	Meaning	Data type	Flags	Default
606A:0	DPM Variant Value In	Max. subindex	UINT8	RO	0x18 (24 <sub>dec</sub> )
606A:10	TxPDO Toggle	The TxPDO toggle is toggled by the slave when the data of the associated TxPDO has been updated	BOOLEAN	RO	0x00 (0 <sub>dec</sub> )
606A:11	Index 1 REAL	Acknowledge for variable output value 1	UINT16	RO	0x0000 (0 <sub>dec</sub> )
606A:12	Value 1 REAL	Variable output value channel 1	REAL32	RO	0x00000000 (0 <sub>dec</sub> )
606A:13	Index 2 REAL	Acknowledge for variable output value 2	UINT16	RO	0x0000 (0 <sub>dec</sub> )
606A:14	Value 2 REAL	Variable output value channel 2	REAL32	RO	0x00000000 (0 <sub>dec</sub> )
606A:15	Index 3 REAL	Acknowledge for variable output value 3	UINT16	RO	0x0000 (0 <sub>dec</sub> )
606A:16	Value 3 REAL	Variable output value channel 3	REAL32	RO	0x00000000 (0 <sub>dec</sub> )
606A:17	Index 4 ULINT	Acknowledge for variable output value 4	UINT16	RO	0x0000 (0 <sub>dec</sub> )
606A:18	Value 4 ULINT	Variable output value channel 4	UINT64	RO	

#### Index 60n0 DPM Channel (for Ch.1 n = 0; Ch.2 n = 1; Ch.3 n = 2; Ch.4 n = 3; Ch.5 n = 4; Ch.6 n = 5)

Index (hex)	Name	Meaning	Data type	Flags	Default
60n0:0	DPM Channel	Max. subindex	UINT8	RO	0x15 (21 <sub>dec</sub> )
60n0:01	Overcurrent	Maximum measurable current is exceeded.	BOOLEAN	RO	0x00 (0 <sub>dec</sub> )
60n0:02	Inaccurate Current	The measured current value is outside the limits for the current entered in CoE object 0x80n2	BOOLEAN	RO	0x00 (0 <sub>dec</sub> )
60n0:03	Current Guard Warning	The measured current value is outside the warning limits entered in the CoE objects 0x80n2:06 and 0x80n2:07	BOOLEAN	RO	0x00 (0 <sub>dec</sub> )
60n0:04	Current Guard Error	The measured current value is outside the error limits entered in the CoE objects 0x80n2:05 and 0x80n2:08	BOOLEAN	RO	0x00 (0 <sub>dec</sub> )
60n0:05	Apparent Power Guard Warning	The value for the apparent power is outside the warning limits entered in the CoE objects 0x80n2:0A and 0x80n2:0B	BOOLEAN	RO	0x00 (0 <sub>dec</sub> )
60n0:06	Apparent Power Guard Error	The value for the apparent power is outside the error limits for the current entered in the CoE objects 0x80n2:09 and 0x80n2:0C	BOOLEAN	RO	0x00 (0 <sub>dec</sub> )
60n0:07	Active Power Guard Warning	The value for active power is outside the warning limits entered in the CoE objects 0x80n2:0E and 0x80n2:0F	BOOLEAN	RO	0x00 (0 <sub>dec</sub> )
60n0:08	Active Power Guard Error	The value for active power is outside the error limits for the current entered in CoE objects 0x80n2:0D and 0x80n2:10	BOOLEAN	RO	0x00 (0 <sub>dec</sub> )
60n0:09	Reactive Power Guard Warning	The value for the reactive power is outside the warning limits entered in the CoE objects 0x80n2:12 and 0x80n2:13	BOOLEAN	RO	0x00 (0 <sub>dec</sub> )
60n0:0A	Reactive Power Guard Error	The value for the reactive power is outside the error limits for the current entered in the CoE objects 0x80n2:11 and 0x80n2:14	BOOLEAN	RO	0x00 (0 <sub>dec</sub> )
60n0:0C	DPM Toggle	The DPM toggle is toggled by the slave when the DPM data has been updated.	BOOLEAN	RO	0x00 (0 <sub>dec</sub> )
60n0:10	TxPDO Toggle	The TxPDO toggle is toggled by the slave when the data of the associated TxPDO has been updated.	BOOLEAN	RO	0x00 (0 <sub>dec</sub> )
60n0:11	Current	Actual measured current value	REAL32	RO	0x00000000 (0 <sub>dec</sub> )
60n0:12	Active Power	Actually measured active power	REAL32	RO	0x00000000 (0 <sub>dec</sub> )
60n0:13	Apparent Power	Actual measured apparent power	REAL32	RO	0x00000000 (0 <sub>dec</sub> )
60n0:14	Reactive Power Fundamental	Balanced reactive power fundamental oscillation	REAL32	RO	0x00000000 (0 <sub>dec</sub> )
60n0:15	Active Energy	Actually measured active energy	UINT32	RO	0x00000000 (0 <sub>dec</sub> )

### 6.6.3.5 Output data

#### Index 7060 DPM Variant Value Out

Index (hex)	Name	Meaning	Data type	Flags	Default
7060:0	DPM Variant Value Out	Max. subindex	UINT8	RO	0x14 (20 <sub>dec</sub> )
7060:11	Index 1 REAL	Request for variable output value 1 (REAL)	UINT16	RO	0x0000 (0 <sub>dec</sub> )
7060:12	Index 2 REAL	Request for variable output value 2 (REAL)	UINT16	RO	0x0000 (0 <sub>dec</sub> )
7060:13	Index 3 REAL	Request for variable output value 3 (REAL)	UINT16	RO	0x0000 (0 <sub>dec</sub> )
7060:14	Index 4 ULINT	Request for variable output value 4 (ULINT)	UINT16	RO	0x0000 (0 <sub>dec</sub> )

#### Index F700 DPM Data

Index (hex)	Name	Meaning	Data type	Flags	Default
F700:0	DPM Data	Max. subindex	UINT8	RO	0x14 (20 <sub>dec</sub> )
F700:01	SubIndex 001		UINT32	RO	0x00000000 (0 <sub>dez</sub> )
F700:02	SubIndex 002		UINT32	RO	0x00000000 (0 <sub>dez</sub> )
F700:03	SubIndex 003		UINT32	RO	0x00000000 (0 <sub>dez</sub> )
F700:04	SubIndex 004		UINT32	RO	0x00000000 (0 <sub>dez</sub> )
F700:05	SubIndex 005		UINT32	RO	0x00000000 (0 <sub>dez</sub> )
F700:06	SubIndex 006		UINT32	RO	0x00000000 (0 <sub>dez</sub> )
F700:07	SubIndex 007		UINT32	RO	0x00000000 (0 <sub>dez</sub> )
F700:08	SubIndex 008		UINT32	RO	0x00000000 (0 <sub>dez</sub> )
F700:09	SubIndex 009		UINT32	RO	0x00000000 (0 <sub>dez</sub> )
F700:0A	SubIndex 010		UINT32	RO	0x00000000 (0 <sub>dez</sub> )
F700:0B	SubIndex 011		UINT32	RO	0x00000000 (0 <sub>dez</sub> )
F700:0C	SubIndex 012		UINT32	RO	0x00000000 (0 <sub>dez</sub> )
F700:0D	SubIndex 013		UINT32	RO	0x00000000 (0 <sub>dez</sub> )
F700:0E	SubIndex 014		UINT32	RO	0x00000000 (0 <sub>dez</sub> )
F700:0F	SubIndex 015		UINT32	RO	0x00000000 (0 <sub>dez</sub> )
F700:10	SubIndex 016		UINT32	RO	0x00000000 (0 <sub>dez</sub> )
F700:11	SubIndex 017		UINT32	RO	0x00000000 (0 <sub>dez</sub> )
F700:12	SubIndex 018		UINT32	RO	0x00000000 (0 <sub>dez</sub> )
F700:13	SubIndex 019		UINT32	RO	0x00000000 (0 <sub>dez</sub> )
F700:14	SubIndex 020		UINT32	RO	0x00000000 (0 <sub>dez</sub> )

### 6.6.3.6 Information and diagnostic data

#### Index 90n0 DPM Channel Harmonics - EL3446 (for Ch.1, n = 0; Ch.2, n = 1; Ch.3, n = 2; Ch.4, n = 3; Ch.5, n = 4; Ch.6, n = 5)

Index (hex)	Name	Meaning	Data type	Flags	Default
90n0:0	DPM Channel Harmonics	Max. subindex	UINT8	RO	0x14 (20 <sub>dec</sub> )
90n0:01	Subindex 001	DC component of the oscillation of the fundamental wave	REAL32	RO	0x00000000 (0 <sub>dec</sub> )
90n0:02	Subindex 002	Fundamental wave	REAL32	RO	0x00000000 (0 <sub>dec</sub> )
90n0:03	Subindex 003	2nd harmonic of the fundamental wave	REAL32	RO	0x00000000 (0 <sub>dec</sub> )
90n0:04	Subindex 004	3rd harmonic of the fundamental wave	REAL32	RO	0x00000000 (0 <sub>dec</sub> )
...	...	...	...	...	...
90n0:14	Subindex 020	19th harmonic of the fundamental wave	REAL32	RO	0x00000000 (0 <sub>dec</sub> )

#### Index 90n1 DPM Channel Info data Current - EL3446 (for Ch.1, n = 0; Ch.2, n = 1; Ch.3, n = 2; Ch.4, n = 3; Ch.5, n = 4; Ch.6, n = 5)

Index (hex)	Name	Meaning	Data type	Flags	Default
90n1:0	DPM Channel Info data Current	Max. subindex	UINT8	RO	0x13 (19 <sub>dec</sub> )
90n1:11	Current Peak	Peak value of the instantaneous current in the last interval in A	REAL32	RO	0x00000000 (0 <sub>dec</sub> )
90n1:12	Current RMS Minimum	Minimum RMS value of the current in the last interval in A	REAL32	RO	0x00000000 (0 <sub>dec</sub> )
90n1:13	Current RMS Maximum	Maximum RMS value of the current in the last interval in A	REAL32	RO	0x00000000 (0 <sub>dec</sub> )

#### Index 90n2 DPM Channel Info data Power - EL3446 (for Ch.1, n = 0; Ch.2, n = 1; Ch.3, n = 2; Ch.4, n = 3; Ch.5, n = 4; Ch.6, n = 5)

Index (hex)	Name	Meaning	Data type	Flags	Default
90n2:0	DPM Channel Info data Power	Max. subindex	UINT8	RO	0x1B (27 <sub>dec</sub> )
90n2:11	Active Power Avg	Average active phase power during the last interval in W	REAL32	RO	0x00000000 (0 <sub>dec</sub> )
90n2:12	Active Power Min	Minimum active phase power during the last interval in W	REAL32	RO	0x00000000 (0 <sub>dec</sub> )
90n2:13	Active Power Max	Maximum active phase power during the last interval in W	REAL32	RO	0x00000000 (0 <sub>dec</sub> )
90n2:14	Apparent Power Avg	Average apparent phase power during the last interval in VA	REAL32	RO	0x00000000 (0 <sub>dec</sub> )
90n2:15	Apparent Power Min	Minimum apparent phase power during the last interval in VA	REAL32	RO	0x00000000 (0 <sub>dec</sub> )
90n2:16	Apparent Power Max	Maximum apparent phase power during the last interval in VA	REAL32	RO	0x00000000 (0 <sub>dec</sub> )
90n2:17	Reactive Power Avg	Average reactive phase power during the last interval in var	REAL32	RO	0x00000000 (0 <sub>dec</sub> )
90n2:18	Reactive Power Min	Minimum reactive phase power during the last interval in var	REAL32	RO	0x00000000 (0 <sub>dec</sub> )
90n2:19	Reactive Power Max	Maximum reactive phase power during the last interval in var	REAL32	RO	0x00000000 (0 <sub>dec</sub> )
90n2:1A	Phi	Phase angle in degrees (between voltage U_Lx and the corresponding current I_Lx)	REAL32	RO	0x00000000 (0 <sub>dec</sub> )
90n2:1B	Phase angle	Phase difference in degrees (between different voltages U_Lx and U_Ly)	REAL32	RO	0x00000000 (0 <sub>dec</sub> )



**Index 90n3 DPM Channel Info data Energy - EL3446 (for Ch.1, n = 0; Ch.2, n = 1; Ch.3, n = 2; Ch.4, n = 3; Ch.5, n = 4; Ch.6, n = 5)**

Index (hex)	Name	Meaning	Data type	Flags	Default
90n3:0	DPM Channel Info data Energy	Max. subindex	UINT8	RO	0x09 (9 <sub>dec</sub> )
90n3:01	Active Energy	Recorded active phase energy in mWh	INT64	RO	
90n3:02	Positive Active Energy	Received active phase energy in mWh	UINT64	RO	
90n3:03	Negative Active Energy	Supplied active phase energy in mWh	UINT64	RO	
90n3:04	Apparent Energy	Recorded apparent phase energy in mWh	INT64	RO	
90n3:05	Positive Apparent Energy	Received apparent phase energy in mWh	UINT64	RO	
90n3:06	Negative Apparent Energy	Supplied apparent phase energy in mWh	UINT64	RO	
90n3:07	Reactive Energy	Recorded reactive phase energy in mWh	INT64	RO	
90n3:08	Positive Reactive Energy	Received reactive phase energy in mWh	UINT64	RO	
90n3:09	Negative Reactive Energy	Supplied reactive phase energy in mWh	UINT64	RO	

**Index A0n0 DPM Channel Diag data - EL3446 (for Ch.1, n = 0; Ch.2, n = 1; Ch.3, n = 2; Ch.4, n = 3; Ch.5, n = 4; Ch.6, n = 5)**

Index (hex)	Name	Meaning	Data type	Flags	Default
A0n0:0	DPM Channel Diag data	Max. subindex	UINT8	RO	0x01 (1 <sub>dec</sub> )
A0n0:01	Saturation Time Current	Time (in 0.1 ms) in which the terminal has measured an overcurrent.	UINT32	RO	0x00000000 (0 <sub>dec</sub> )

**Index F081 Download revision**

Index (hex)	Name	Meaning	Data type	Flags	Default
F081:0	Download revision	Max. subindex	UINT8	RO	0x01 (1 <sub>dec</sub> )
F010:01	Revision number	Configured revision of the terminal, (see note [► 139])	UINT32	RW	0x00000000 (0 <sub>dec</sub> )

### 6.6.3.7 Standard objects

#### Index 1000 Device type

Index (hex)	Name	Meaning	Data type	Flags	Default
1000:0	Device type	Device type of the EtherCAT slave: The Lo-Word contains the CoE profile used (5001). The Hi-Word contains the module profile according to the modular device profile.	UINT32	RO	0x01551389 (22352777 <sub>dec</sub> )

#### Index 1008 Device name

Index (hex)	Name	Meaning	Data type	Flags	Default
1008:0	Device name	Device name of the EtherCAT slave	STRING	RO	EL34xx

#### Index 1009 Hardware version

Index (hex)	Name	Meaning	Data type	Flags	Default
1009:0	Hardware version	Hardware version of the EtherCAT slave	STRING	RO	

#### Index 100A Software Version

Index (hex)	Name	Meaning	Data type	Flags	Default
100A:0	Software version	Firmware version of the EtherCAT slave	STRING	RO	

#### Index 100B Bootloader version

Index (hex)	Name	Meaning	Data type	Flags	Default
100B:0	Bootloader version	Bootloader version	STRING	RO	

#### Index 1018 Identity

Index (hex)	Name	Meaning	Data type	Flags	Default
1018:0	Identity	Length of this object	UINT8	RO	0x04 (4 <sub>dec</sub> )
1018:01	Vendor ID	Vendor ID of the EtherCAT slave	UINT32	RO	0x00000002 (2 <sub>dec</sub> )
1018:02	Product code	Product code of the EtherCAT slave	UINT32	RO	0x0D763052 (225849426 <sub>dec</sub> )
1018:03	Revision	Revision number of the EtherCAT slave; the low word (bit 0-15) indicates the special terminal number, the high word (bit 16-31) refers to the device description	UINT32	RO	0x00140000 (1310720 <sub>dec</sub> )
1018:04	Serial number	Serial number of the EtherCAT slave; the low byte (bit 0-7) of the low word contains the year of production, the high byte (bit 8-15) of the low word contains the week of production, the high word (bit 16-31) is 0	UINT32	RO	z.B. 0x00001E06 (KW 30/2006)

#### Index 10F0 Backup parameter

Index (hex)	Name	Meaning	Data type	Flags	Default
10F0:0	Backup parameter	Length of this object	UINT8	RO	0x01
10F0:01	Checksum	Checksum	UINT32	RW	0x00000000 (0 <sub>dec</sub> )

**Index 10F3 Diagnosis History**

Index	Name	Meaning	Data type	Flags	Default
10F3:0	Diagnosis History	Maximum subindex	UINT8	RO	0x15 (21 <sub>dec</sub> )
10F3:01	Maximum Messages	Maximum number of stored messages. A maximum of 50 messages can be stored	UINT8	RO	0x00 (0 <sub>dec</sub> )
10F3:02	Newest Message	Subindex of the latest message	UINT8	RO	0x00 (0 <sub>dec</sub> )
10F3:03	Newest Acknowledged Message	Subindex of the last confirmed message	UINT8	RW	0x00 (0 <sub>dec</sub> )
10F3:04	New Messages Available	Indicates that a new message is available	BOOLEAN	RO	0x00 (0 <sub>dec</sub> )
10F3:05	Flags	not used	UINT16	RW	0x0000 (0 <sub>dec</sub> )
10F3:06	Diagnosis Message 001	Message 1	OCTET STRING[28]	RO	{0}
...	...	...	...	...	...
10F3:15	Diagnosis Message 016	Message 16	OCTET STRING[28]	RO	{0}

**Index 10F8 Actual Time Stamp**

Index	Name	Meaning	Data type	Flags	Default
10F8:0	Actual Time Stamp	Time stamp	UINT64	RO	0x0000000000000000 (0 <sub>dec</sub> )

**Index 10F9 Time Distribution Object**

Index	Name	Meaning	Data type	Flags	Default
10F9:0	Time Distribution Object	Max Subindex	UINT8	RO	0x01 (1 <sub>dec</sub> )
10F9:01	Distributed Time Value	Object for time distribution by the EtherCAT Master	INT64	RW	

**Index 1600 DPM RxPDO-Map Variant Value Out**

Index (hex)	Name	Meaning	Data type	Flags	Default
1600:0	DPM RxPDO-Map Variant Value Out	PDO Mapping RxPDO 1	UINT8	RO	0x04 (4 <sub>dec</sub> )
1600:01	SubIndex 001	1. PDO Mapping entry (object 0x7060 (DPM Variant Value Out), entry 0x11 (Index 1 REAL))	UINT32	RO	0x7060:11, 16
1600:02	SubIndex 002	2. PDO Mapping entry (object 0x7060 (DPM Variant Value Out), entry 0x12 (Index 2 REAL))	UINT32	RO	0x7060:12, 16
1600:03	SubIndex 003	3. PDO Mapping entry (object 0x7060 (DPM Variant Value Out), entry 0x13 (Index 3 REAL))	UINT32	RO	0x7060:13, 16
1600:04	SubIndex 004	4. PDO Mapping entry (object 0x7060 (DPM Variant Value Out), entry 0x14 (Index 4 ULINT))	UINT32	RO	0x7060:14, 16

## Index 1601 DPM RxPDO-Map Data

Index (hex)	Name	Meaning	Data type	Flags	Default
1601:0	DPM RxPDO-Map Data	PDO Mapping RxPDO 2	UINT8	RO	0x14 (20 <sub>dec</sub> )
1601:01	SubIndex 001	1. PDO Mapping entry (object 0xF700 (DPM Data), entry 0x01 (Data 1))	UINT32	RO	0xF700:01, 32
1601:02	SubIndex 002	2. PDO Mapping entry (object 0xF700 (DPM Data), entry 0x02 (Data 2))	UINT32	RO	0xF700:02, 32
1601:03	SubIndex 003	3. PDO Mapping entry (object 0xF700 (DPM Data), entry 0x03 (Data 3))	UINT32	RO	0xF700:03, 32
1601:04	SubIndex 004	4. PDO Mapping entry (object 0xF700 (DPM Data), entry 0x04 (Data 4))	UINT32	RO	0xF700:04, 32
1601:05	SubIndex 005	5. PDO Mapping entry (object 0xF700 (DPM Data), entry 0x05 (Data 5))	UINT32	RO	0xF700:05, 32
1601:06	SubIndex 006	6. PDO Mapping entry (object 0xF700 (DPM Data), entry 0x06 (Data 6))	UINT32	RO	0xF700:06, 32
1601:07	SubIndex 007	7. PDO Mapping entry (object 0xF700 (DPM Data), entry 0x07 (Data 7))	UINT32	RO	0xF700:07, 32
1601:08	SubIndex 008	8. PDO Mapping entry (object 0xF700 (DPM Data), entry 0x08 (Data 8))	UINT32	RO	0xF700:08, 32
1601:09	SubIndex 009	9. PDO Mapping entry (object 0xF700 (DPM Data), entry 0x09 (Data 9))	UINT32	RO	0xF700:09, 32
1601:0A	SubIndex 010	10. PDO Mapping entry (object 0xF700 (DPM Data), entry 0x0A (Data 10))	UINT32	RO	0xF700:0A, 32
1601:0B	SubIndex 011	11. PDO Mapping entry (object 0xF700 (DPM Data), entry 0x0B (Data 11))	UINT32	RO	0xF700:0B, 32
1601:0C	SubIndex 012	12. PDO Mapping entry (object 0xF700 (DPM Data), entry 0x0C (Data 12))	UINT32	RO	0xF700:0C, 32
1601:0D	SubIndex 013	13. PDO Mapping entry (object 0xF700 (DPM Data), entry 0x0D (Data 13))	UINT32	RO	0xF700:0D, 32
1601:0E	SubIndex 014	14. PDO Mapping entry (object 0xF700 (DPM Data), entry 0x0E (Data 14))	UINT32	RO	0xF700:0E, 32
1601:0F	SubIndex 015	15. PDO Mapping entry (object 0xF700 (DPM Data), entry 0x0F (Data 15))	UINT32	RO	0xF700:0F, 32
1601:10	SubIndex 016	16. PDO Mapping entry (object 0xF700 (DPM Data), entry 0x10 (Data 16))	UINT32	RO	0xF700:10, 32
1601:11	SubIndex 017	17. PDO Mapping entry (object 0xF700 (DPM Data), entry 0x11 (Data 17))	UINT32	RO	0xF700:11, 32
1601:12	SubIndex 018	18. PDO Mapping entry (object 0xF700 (DPM Data), entry 0x12 (Data 18))	UINT32	RO	0xF700:12, 32
1601:13	SubIndex 019	19. PDO Mapping entry (object 0xF700 (DPM Data), entry 0x13 (Data 19))	UINT32	RO	0xF700:13, 32
1601:14	SubIndex 020	20. PDO Mapping entry (object 0xF700 (DPM Data), entry 0x14 (Data 20))	UINT32	RO	0xF700:14, 32

**Index 1A0C DPM TxPDO-Map Variant Value In**

Index (hex)	Name	Meaning	Data type	Flags	Default
1A0C:0	DPM TxPDO-Map Variant Value In	PDO Mapping TxPDO	UINT8	RO	0x0A (10 <sub>dec</sub> )
1A0C:01	SubIndex 001	reserved	UINT32	RO	0x000:00, 15
1A0C:02	SubIndex 002	1. PDO Mapping entry (object 0x606A (DPM Variant Value In), entry 0x10 (TxPDO Toggle))	UINT32	RO	0x606A:10, 1
1A0C:03	SubIndex 003	2. PDO Mapping entry (object 0x606A (DPM Variant Value In), entry 0x11 (Index 1 REAL))	UINT32	RO	0x606A:11, 16
1A0C:04	SubIndex 004	3. PDO Mapping entry (object 0x606A (DPM Variant Value In), entry 0x12 (Value 1 REAL))	UINT32	RO	0x606A:12, 32
1A0C:05	SubIndex 005	4. PDO Mapping entry (object 0x606A (DPM Variant Value In), entry 0x13 (Index 2 REAL))	UINT32	RO	0x606A:13, 16
1A0C:06	SubIndex 006	5. PDO Mapping entry (object 0x606A (DPM Variant Value In), entry 0x14 (Value 2 REAL))	UINT32	RO	0x606A:14, 32
1A0C:07	SubIndex 007	6. PDO Mapping entry (object 0x606A (DPM Variant Value In), entry 0x15 (Index 3 REAL))	UINT32	RO	0x606A:15, 16
1A0C:08	SubIndex 008	7. PDO Mapping entry (object 0x606A (DPM Variant Value In), entry 0x16 (Value 3 REAL))	UINT32	RO	0x606A:16, 32
1A0C:09	SubIndex 009	8. PDO Mapping entry (object 0x606A (DPM Variant Value In), entry 0x17 (Index 4 ULINT))	UINT32	RO	0x606A:17, 16
1A0C:0A	SubIndex 010	9. PDO Mapping entry (object 0x606A (DPM Variant Value In), entry 0x18 (Value 4 ULINT))	UINT32	RO	0x606A:18, 64

**Index 1A0n TxPDO-Map Channel (for Ch.1 n = 0; Ch.2 n = 1; Ch.3 n = 2; Ch.4 n = 3; Ch.5 n = 4; Ch.6 n = 5)**

Index (hex)	Name	Meaning	Data type	Flags	Default
1A0n:0	TxPDO-Map Channel	PDO Mapping TxPDO	UINT8	RO	0x13 (19 <sub>dec</sub> )
1A0n:01	SubIndex 001	1. PDO Mapping entry (object 0x6000 (Channel), entry 0x01 (Overcurrent))	UINT32	RO	0x600n:01, 1
1A0n:02	SubIndex 002	2. PDO Mapping entry (object 0x6000 (Channel), entry 0x02 (Inaccurate Current))	UINT32	RO	0x600n:02, 1
1A0n:03	SubIndex 003	3. PDO Mapping entry (object 0x6000 (Channel), entry 0x03 (Current Guard Warning))	UINT32	RO	0x600n:03, 1
1A0n:04	SubIndex 004	4. PDO Mapping entry (object 0x6000 (Channel), entry 0x04 (Current Guard Error))	UINT32	RO	0x600n:04, 1
1A0n:05	SubIndex 005	5. PDO Mapping entry (object 0x6000 (Channel), entry 0x05 (Apparent Power Guard Warning))	UINT32	RO	0x600n:05, 1
1A0n:06	SubIndex 006	6. PDO Mapping entry (object 0x6000 (Channel), entry 0x06 (Apparent Power Guard Error))	UINT32	RO	0x600n:06, 1
1A0n:07	SubIndex 007	7. PDO Mapping entry (object 0x6000 (Channel), entry 0x07 (Active Power Guard Warning))	UINT32	RO	0x600n:07, 1
1A0n:08	SubIndex 008	8. PDO Mapping entry (object 0x6000 (Channel), entry 0x08 (Active Power Guard Error))	UINT32	RO	0x600n:08, 1
1A0n:09	SubIndex 009	9. PDO Mapping entry (object 0x6000 (Channel), entry 0x09 (Reactive Power Guard Warning))	UINT32	RO	0x600n:09, 1
1A0n:0A	SubIndex 010	10. PDO Mapping entry (object 0x6000 (Channel), entry 0x0A (Reactive Power Guard Error))	UINT32	RO	0x600n:0A, 1
1A0n:0B	SubIndex 011	Reserved	UINT32	RO	0x0000:00, 1
1A0n:0C	SubIndex 012	12. PDO Mapping entry (object 0x6000 (Channel), entry 0x0C (DPM Timeout))	UINT32	RO	0x600n:0C, 1
1A0n:0D	SubIndex 013	Reserved	UINT32	RO	0x0000:00, 3
1A0n:0E	SubIndex 014	14. PDO Mapping entry (object 0x6000 (Channel), entry 0x10 (TxPDO Toggle))	UINT32	RO	0x600n:10, 1
1A0n:0F	SubIndex 015	15. PDO Mapping entry (object 0x6000 (Channel), entry 0x11 (Current))	UINT32	RO	0x600n:11, 32
1A0n:10	SubIndex 016	16. PDO Mapping entry (object 0x6000 (Channel), entry 0x12 (Active Power))	UINT32	RO	0x600n:12, 32
1A0n:11	SubIndex 017	17. PDO Mapping entry (object 0x6000 (Channel), entry 0x13 (Apparent Power))	UINT32	RO	0x600n:13, 32
1A0n:12	SubIndex 018	18. PDO Mapping entry (object 0x6000 (Channel), entry 0x14 (Reactive Power Fundamental))	UINT32	RO	0x600n:14, 32
1A0n:13	SubIndex 019	19. PDO Mapping entry (object 0x6000 (Channel), entry 0x15 (Active Energy))	UINT32	RO	0x600n:15, 32

**Index 1C00 Sync manager type**

Index (hex)	Name	Meaning	Data type	Flags	Default
1C00:0	Sync manager type	Length of this object	UINT8	RO	0x04 (4 <sub>dec</sub> )
1C00:01	SubIndex 001	Sync-Manager Type Channel 1: Mailbox Write	UINT8	RW	0x01 (1 <sub>dec</sub> )
1C00:02	SubIndex 002	Sync-Manager Type Channel 2: Mailbox Read	UINT8	RW	0x02 (2 <sub>dec</sub> )
1C00:03	SubIndex 003	Sync-Manager Type Channel 3: Process Data Write (Outputs)	UINT8	RW	0x03 (3 <sub>dec</sub> )
1C00:04	SubIndex 004	Sync-Manager Type Channel 4: Process Data Read (Inputs)	UINT8	RW	0x04 (4 <sub>dec</sub> )

**Index 1C12 RxPDO assign**

Index (hex)	Name	Meaning	Data type	Flags	Default
1C12:0	RxPDO assign	PDO Assign Outputs	UINT8	RW	0x02 (1 <sub>dec</sub> )
1C12:01	SubIndex 001	1. allocated RxPDO (contains the index of the associated RxPDO mapping object)	UINT16	RW	0x1600 (5632 <sub>dec</sub> )
1C12:02	SubIndex 002	2. allocated RxPDO (contains the index of the associated RxPDO mapping object)	UINT16	RW	0x1601 (5633 <sub>dec</sub> )

**Index 1C13 TxPDO assign**

Index (hex)	Name	Meaning	Data type	Flags	Default
1C13:0	TxPDO assign	PDO Assign Inputs	UINT8	RW	0x06 (6 <sub>dec</sub> )
1C13:01	SubIndex 001	1. allocated TxPDO (contains the index of the associated TxPDO mapping object)	UINT16	RW	0x1A01 (6657 <sub>dec</sub> )
1C13:02	SubIndex 002	2. allocated TxPDO (contains the index of the associated TxPDO mapping object)	UINT16	RW	0x1A03 (6659 <sub>dec</sub> )
1C13:03	SubIndex 003	3. allocated TxPDO (contains the index of the associated TxPDO mapping object)	UINT16	RW	0x1A05 (6661 <sub>dec</sub> )
1C13:04	SubIndex 004	4. allocated TxPDO (contains the index of the associated TxPDO mapping object)	UINT16	RW	0x1A07 (6663 <sub>dec</sub> )
1C13:05	SubIndex 005	5. allocated TxPDO (contains the index of the associated TxPDO mapping object)	UINT16	RW	0x1A09 (6665 <sub>dec</sub> )
1C13:06	SubIndex 006	6. allocated TxPDO (contains the index of the associated TxPDO mapping object)	UINT16	RW	0x1A0B (6667 <sub>dec</sub> )
1C13:07	SubIndex 007	7. allocated TxPDO (contains the index of the associated TxPDO mapping object)	UINT16	RW	0x0000 (0 <sub>dec</sub> )

**Index 1C32 SM output parameter**

Index	Name	Meaning	Data type	Flags	Default
1C32:0	SM output parameter	Synchronization parameters for the outputs	UINT8	RO	0x20 (32 <sub>dec</sub> )
1C32:01	Sync mode	Current synchronization mode: 0: Free Run 1: Synchron with SM 2 Event 2: DC-Mode - Synchron with SYNC0 Event 3: DC-Mode - Synchron with SYNC1 Event	UINT16	RW	0x0000 (0 <sub>dec</sub> )
1C32:02	Cycle time	Cycle time (in ns): Free Run: Cycle time of the local timer Synchron with SM 2 Event: Master cycle time DC mode: SYNC0/SYNC1 Cycle Time	UINT32	RW	0x0016E360 (1500000 <sub>dec</sub> )
1C32:03	Shift time	Time between SYNC0 event and output of the outputs (in ns, DC mode only)	UINT32	RO	0x00000384 (900 <sub>dec</sub> )
1C32:04	Sync modes supported	Supported synchronization modes: Bit 0 = 1: free run is supported Bit 1 = 1: synchronous with SM 2 event is supported Bit 2-3 = 01: DC mode is supported Bit 4-5 = 10: Output shift with SYNC1 event (only DC mode) Bit 14 = 1: dynamic times (measurement through writing of 1C32:08)	UINT16	RO	0x0805 (2053 <sub>dec</sub> )
1C32:05	Minimum cycle time	Minimum cycle time (in ns)	UINT32	RO	0x0007A120 (500000 <sub>dec</sub> )
1C32:06	Calc and copy time	Minimum time between SYNC0 and SYNC1 event (in ns, DC mode only)	UINT32	RO	0x00000384 (900 <sub>dec</sub> )
1C32:07	Minimum delay time		UINT32	RO	0x00000384 (900 <sub>dec</sub> )
1C32:08	Command	0: Measurement of the local cycle time is stopped 1: Measurement of the local cycle time is started The entries 1C32:03, 1C32:05, 1C32:06, 1C32:09, 1C33:03, 1C33:06, 1C33:09 are updated with the maximum measured values. For a subsequent measurement the measured values are reset	UINT16	RW	0x0000 (0 <sub>dec</sub> )
1C32:09	Maximum delay time	Time between SYNC1 event and output of the outputs (in ns, DC mode only)	UINT32	RO	0x00000384 (900 <sub>dec</sub> )
1C32:0B	SM event missed counter	Number of missed SM events in OPERATIONAL (DC mode only)	UINT16	RO	0x0000 (0 <sub>dec</sub> )
1C32:0C	Cycle exceeded counter	Number of occasions the cycle time was exceeded in OPERATIONAL (cycle was not completed in time or the next cycle began too early)	UINT16	RO	0x0000 (0 <sub>dec</sub> )
1C32:0D	Shift too short counter	Number of occasions that the interval between SYNC0 and SYNC1 event was too short (DC mode only)	UINT16	RO	0x0000 (0 <sub>dec</sub> )

## Index 1C33 SM input parameter

Index (hex)	Name	Meaning	Data type	Flags	Default
1C33:0	SM input parameter	Synchronization parameters for the inputs	UINT8	RO	0x20 (32 <sub>dec</sub> )
1C33:01	Sync mode	Current synchronization mode: 0: Free Run 1: Synchron with SM 3 Event (no outputs available) 2: DC - Synchron with SYNC0 Event 3: DC - Synchron with SYNC1 Event 34: Synchron with SM 2 event (outputs available)	UINT16	RW	0x0000 (0 <sub>dec</sub> )
1C33:02	Cycle time	as 1C32:02	UINT32	RW	0x0016E360 (1500000 <sub>dec</sub> )
1C33:03	Shift time	Time between SYNC0 event and reading of the inputs (in ns, only DC mode)	UINT32	RO	0x00000384 (900 <sub>dec</sub> )
1C33:04	Sync modes supported	Supported synchronization modes: Bit 0: free run is supported Bit 1: Synchron with SM 2 Event is supported (outputs available) Bit 1: Synchron with SM 3 Event is supported (no outputs available) Bit 2-3 = 01: DC mode is supported Bit 4-5 = 01: Input shift through local event (outputs available) Bit 4-5 = 10: Input shift with SYNC1 event (no outputs available) Bit 14 = 1: dynamic times (measurement through writing of 1C32:08 or 1C33:08)	UINT16	RO	0x0805 (2053 <sub>dec</sub> )
1C33:05	Minimum cycle time	as 1C32:05	UINT32	RO	0x0007A120 (500000 <sub>dec</sub> )
1C33:06	Calc and copy time	Time between reading of the inputs and availability of the inputs for the master (in ns, only DC mode)	UINT32	RO	0x0007A120 (500000 <sub>dec</sub> )
1C33:07	Minimum delay time		UINT32	RO	0x00000384 (900 <sub>dec</sub> )
1C33:08	Command	as 1C32:08	UINT16	RW	0x0000 (0 <sub>dec</sub> )
1C33:09	Maximum delay time	Time between SYNC1 event and reading of the inputs (in ns, only DC mode)	UINT32	RO	0x00000384 (900 <sub>dec</sub> )
1C33:0B	SM event missed counter	as 1C32:11	UINT16	RO	0x0000 (0 <sub>dec</sub> )
1C33:0C	Cycle exceeded counter	as 1C32:12	UINT16	RO	0x0000 (0 <sub>dec</sub> )
1C33:0D	Shift too short counter	as 1C32:13	UINT16	RO	0x0000 (0 <sub>dec</sub> )

## Index F000 Modular device profile

Index (hex)	Name	Meaning	Data type	Flags	Default
F000:0	Modular device profile	Largest subindex of this object	UINT8	RO	0x02
F000:01	Module index distance	Index distance of the objects of the individual channels	UINT16	RW	0x0010 (16 <sub>dec</sub> )
F000:02	Maximum number of modules	Number of channels	UINT16	RW	0x0007 (7 <sub>dec</sub> )

## Index F008 Code word

Index (hex)	Name	Meaning	Data type	Flags	Default
F008:0	Code word	reserved	UINT32	RW	0x00000000 (0 <sub>dec</sub> )

## Code Word

The vendor reserves the authority for the basic calibration of the terminals. The code word is therefore at present reserved.



**Index F010 Module List**

Index (hex)	Name	Meaning	Data type	Flags	Default
F010:0	Module list		UINT8	RW	0x03 (3 <sub>dec</sub> )
F010:01	SubIndex 001		UINT32	RW	0x00000155 (341 <sub>dec</sub> )
F010:02	SubIndex 002		UINT32	RW	0x00000155 (341 <sub>dec</sub> )
F010:03	SubIndex 003		UINT32	RW	0x00000155 (341 <sub>dec</sub> )

**Index F081 Download revision**

Index (hex)	Name	Meaning	Data type	Flags	Default
F081:0	Download revision	Max. subindex	UINT8	RO	0x01 (1 <sub>dec</sub> )
F010:01	Revision number	Configured revision of the terminal, (see note [▶ 139])	UINT32	RW	0x00000000 (0 <sub>dec</sub> )

Index (hex)	Name	Meaning	Data type	Flags	Default
F083:0	BTN	Beckhoff Traceability Number	STRING	RO	00000000

**6.6.3.8 Command object**

**Index FB00 PMX Command**

The command object is used for triggering an action in the terminal. The command is started by writing subindex 1 (request). Write access is disabled until the current command is completed.

Index (hex)	Name	Meaning	Data type	Flags	Default	
FB00:0	PM Command	Largest subindex of this object	UINT8	RO	0x03 (3 <sub>dec</sub> )	
FB00:01	Request	<b>Byte 0 - service request data</b>	OCTET-STRING [2]	RW	0x0000 (0 <sub>dec</sub> )	
		4 <sub>hex</sub>				Clear energy or reset all energy counter
		<b>Byte 1 - channel selection</b>				
		00 <sub>hex</sub>				all channels
		01 <sub>hex</sub>				Channel 1
		02 <sub>hex</sub>	Channel 2			
		03 <sub>hex</sub>	Channel 3			
FB00:02	Status	<b>Byte 0</b> reserved	UINT8	RW	0x00 (0 <sub>dec</sub> )	
FB00:03	Response	<b>Byte 0</b> reserved	OCTET-STRING [2]	RW	0x00000000 (0 <sub>dec</sub> )	
		<b>Byte 1</b> reserved				
		<b>Byte 2-n</b> reserved				

## 6.6.4 EL3453

### 6.6.4.1 Restore object

#### Index 1011 Restore default parameters

Index (hex)	Name	Meaning	Data type	Flags	Default
1011:0	Restore default parameters <a href="#">▶ 316</a>	Restore default parameters	UINT8	RO	0x01 (1 <sub>dec</sub> )
1011:01	SubIndex 001	If this object is set to “0x64616F6C” in the set value dialog, all backup objects are reset to their delivery state.	UINT32	RW	0x00000000 (0 <sub>dec</sub> )

### 6.6.4.2 Configuration data

#### Index 80n0 PMX settings (for ch.1, n = 0; ch.2, n = 1; ch.3, n = 2)

Index (hex)	Name	Meaning	Data type	Flags	Default
80n0:0	PMX Settings	Max. subindex	UINT8	RO	0x15 (21 <sub>dec</sub> )
80n0:11	Voltage Transformer Ratio	If a voltage transformer is used, its transmission ratio can be entered here.	REAL32	RW	1.000000 (1.000000e+000)
80n0:12	Current Transformer Ratio	The ratio of the current transformer used can be entered here.	REAL32	RW	1.000000 (1.000000e+000)
80n0:13	Current Transformer Delay	Here you can enter a possible time delay of the current transformers in milliseconds.	REAL32	RW	0x00000000 (0 <sub>dec</sub> )
80n0:14	Current Range	Selection Current range 100: 100 mA 1000: 1 A 5000: 5 A	UINT32	RW	1 A (1000)
80n0:15	Voltage Source	Selection Voltage Source: 0: Channel 1 1: Channel 2 2: Channel 3	UINT32	RW	Channel 1 (0)

#### Index 80n1 PMX Guard Settings (for ch.1, n = 0; ch.2, n = 1; ch.3, n = 2)

Index (hex)	Name	Meaning	Data type	Flags	Default
80n1:0	PMX Guard Settings	Max. subindex	UINT8	RO	0x14 (20 <sub>dec</sub> )
80n1:11	Voltage Guard Min Error	Lower limit value for a voltage error message [V]	REAL32	RW	2.000000 (2.000000e+000)
80n1:12	Voltage Guard Min Warning	Lower limit value for a voltage warning message [V]	REAL32	RW	207.000000 (2.070000e+002)
80n1:13	Voltage Guard Max Warning	Upper limit value for a voltage warning message [V]	REAL32	RW	253.000000 (2.530000e+002)
80n1:14	Voltage Guard Max Error	Upper limit value for a voltage error message [V]	REAL32	RW	278.000000 (2.780000e+002)
80n1:15	Current Guard Min Error	Lower limit value for a current error message [A]	REAL32	RW	-1.050000 (-1.050000e+000)
80n1:16	Current Guard Min Warning	Lower limit value for a current warning message [A]	REAL32	RW	-1.000000 (-1.000000e+000)
80n1:17	Current Guard Max Warning	Upper limit value for a current warning message [A]	REAL32	RW	1.000000 (1.000000e+000)
80n1:18	Current Guard Max Error	Upper limit value for a current error message [A]	REAL32	RW	1.050000 (1.050000e+000)

**Index 80n2 PMX User Scale (for ch.1, n = 0; ch.2, n = 1; ch.3, n = 2)**

Index (hex)	Name	Meaning	Data type	Flags	Default
80n2:0	PMX User Scale Ch.1	Max. subindex	UINT8	RO	0x15 (21 <sub>dec</sub> )
80n2:01	User Calibration Enable	Set to TRUE to enable user calibration data.	BOOLEAN	RW	0x00 (0 <sub>dez</sub> )
80n2:11	User Calibration Voltage Offset	Value in V	REAL32	RW	0.000000 (0.000000e+000)
80n2:12	User Calibration Voltage Gain	Factor (without unit)	REAL32	RW	1.000000 (1.000000e+000)
80n2:13	User Calibration Current Offset	Value in A	REAL32	RW	0.000000 (0.000000e+000)
80n2:14	User Calibration Current Gain	Factor (without unit)	REAL32	RW	1.000000 (1.000000e+000)
80n2:15	User Calibration Phase Offset	Value in milliseconds	REAL32	RW	0.000000 (0.000000e+000)

**Index F800 PMX Settings**

Index (hex)	Name	Meaning	Data type	Flags	Default
F800:0	PMX Settings	Max. subindex	UINT8	RO	0x17 (23 <sub>dec</sub> )
F800:01	Reset Interval	Manual restart of the measurement and statistics interval	BOOLEAN	RW	0x00 (0 <sub>dec</sub> )
F800:02	Enable Static Fund Frequency	Fixation of the fundamental frequency for harmonic calculation	BOOLEAN	RW	0x00 (0 <sub>dez</sub> )
F800:11	Reference	Timing reference for the RMS calculation Set to "Current" if a current is to be measured without an applied voltage. permitted values: 0 Voltage (default) 1 Current	UINT32	RW	0x00000000 (0 <sub>dec</sub> )
F800:12	Measurement Range	Filter setting for determining the fundamental permitted values: 0 25..65 Hz (default) 1 25..400 Hz 2 12..45 Hz	UINT32	RW	0x00000000 (0 <sub>dec</sub> )
F800:13	Frequency Source	Source of the system frequency permitted values: 0 Channel 1 (default) 1 Channel 2 2 Channel 3 3 Channel 1 + 2 + 3 4 Channel 1 + 2 + 3 fast 5 Channel 1 + 2 + 3 PT2	BIT1	RW	0x00000000 (0 <sub>dec</sub> )
F800:14	Power Calculation Threshold	Noise reduction: Here you can enter a minimum limit value in percent for the power calculation, below which all values are zeroed.	REAL32	RW	0.000000 (0.000000e+000)
F800:15	Inaccurate Threshold Voltage	Limit value for the warning bit: Inaccurate Voltage	REAL32	RW	1.720000 (1.720000e+000)
F800:16	Inaccurate Threshold Current	Limit value for the warning bit: Inaccurate Current	REAL32	RW	0.006000 (6.000000e-003)
F800:17	Voltage Guard Target	Evaluation basis voltage monitor 0: L-N Voltages 1: L-L Voltages	UINT32	RW	L-N Voltages (0)
F800:18	Filter Length	Filter length of the RMS value calculation: 0: Disable 1: 2 Samples 2: 3 Samples 3: 4 Samples 4: 5 Samples 5: 6 Samples	UINT32	RW	Disable (0)

## Index F801 PMX Total Settings PQF

Index (hex)	Name	Meaning	Data type	Flags	Default
F801:0	PMX Total Settings PQF	Max. subindex	UINT8	RO	0x13 (19 <sub>dec</sub> )
F801:11	Nominal voltage	A nominal voltage value or set value is required to calculate the power quality factor (for details see basic function principles).	REAL32	RW	230.0000000 (2.3000000e+02)
F801:12	Nominal Frequency	A nominal frequency or set value is required to calculate the power quality factor (for details see basic function principles).	REAL32	RW	50.0000000 (5.0000000e+01)
F801:13	PQF Dataset	permitted values: 0: default 1: default + unbalance	UINT32	RW	Default + Unbalance (1 <sub>dez</sub> )

**Index F802 PMX Guard Settings**

Index (hex)	Name	Meaning	Data type	Flags	Default
F802:0	PMX Guard Settings	Max. subindex	UINT8	RO	0x28 (40 <sub>dec</sub> )
F802:11	Frequency Guard Min Error	Lower limit value for a frequency error message	REAL32	RW	47.000000 (4.700000e+001)
F802:12	Frequency Guard Min Warning	Lower limit value for a frequency warning message	REAL32	RW	49.500000 (4.950000e+001)
F802:13	Frequency Guard Max Warning	Upper limit value for a frequency warning message	REAL32	RW	50.500000 (5.050000e+001)
F802:14	Frequency Guard Max Error	Upper limit value for a frequency error message	REAL32	RW	52.000000 (5.200000e+001)
F802:15	Neutral Current Guard Min Error	Lower limit value for an error message of the neutral conductor current	REAL32	RW	<b>EL3423, EL3443</b> 0.000000 (0.000000e+000) <b>EL3453</b> -1.050000 (-1.050000e+000)
F802:16	Neutral Current Guard Min Warning	Lower limit value for a warning message of the neutral conductor current	REAL32	RW	<b>EL3423, EL3443</b> 0.000000 (0.000000e+000) <b>EL3453</b> -1.000000 (-1.000000e+000)
F802:17	Neutral Current Guard Max Warning	Upper limit value for a warning message of the neutral conductor current	REAL32	RW	<b>EL3423, EL3443</b> 0.006000 (6.000000e-003) <b>EL3453</b> 1.000000 (1.000000e+000)
F802:18	Neutral Current Guard Max Error	Upper limit value for an error message of the neutral conductor current	REAL32	RW	<b>EL3423, EL3443</b> 0.030000 (3.000000e-002) <b>EL3453</b> 1.050000 (1.050000e+000)
F802:19	Active Power Guard Min Error	Lower limit value for an active power error message [W]	REAL32	RW	0.000000 (0.000000e+000)
F802:1A	Active Power Guard Min Warning	Lower limit value for an active power warning message [W]	REAL32	RW	0.000000 (0.000000e+000)
F802:1B	Active Power Guard Max Warning	Upper limit value for an active power warning message [W]	REAL32	RW	0.000000 (0.000000e+000)
F802:1C	Active Power Guard Max Error	Upper limit value for an active power error message [W]	REAL32	RW	0.000000 (0.000000e+000)
F802:1D	Apparent Power Guard Min Error	Lower limit value for an apparent power error message [VA]	REAL32	RW	0.000000 (0.000000e+000)
F802:1E	Apparent Power Guard Min Warning	Lower limit value for an apparent power warning message [VA]	REAL32	RW	0.000000 (0.000000e+000)
F802:1F	Apparent Power Guard Max Warning	Upper limit value for an apparent power warning message [VA]	REAL32	RW	0.000000 (0.000000e+000)
F802:20	Apparent Power Guard Max Error	Upper limit value for an apparent power error message [VA]	REAL32	RW	0.000000 (0.000000e+000)
F802:21	PQF Guard Min Error	Lower limit value for a power quality factor error message	REAL32	RW	0.050000 (5.000000e-002)
F802:22	PQF Guard Min Warning	Lower limit value for a power quality factor warning message	REAL32	RW	0.800000 (8.000000e-001)
F802:23	PQF Guard Max Warning	Upper limit value for a power quality factor warning message	REAL32	RW	1.000000 (1.000000e+000)
F802:24	PQF Guard Max Error	Upper limit value for a power quality factor error message	REAL32	RW	1.000000 (1.000000e+000)
F802:25	Unbalance Guard Min Error	Lower limit value for an error message due to voltage imbalance	REAL32	RW	0.000000 (0.000000e+000)
F802:26	Unbalance Guard Min Warning	Lower limit value for a warning message due to voltage imbalance	REAL32	RW	0.000000 (0.000000e+000)

Index (hex)	Name	Meaning	Data type	Flags	Default
F802:27	Unbalance Guard Max Warning	Upper limit value for a warning message due to voltage imbalance	REAL32	RW	<b>EL3423, EL3453</b> 0.000000 (0.000000e+000)  <b>EL3443</b> 2.000000 (2.000000e+000)
F802:28	Unbalance Guard Max Error	Upper limit value for an error message due to voltage imbalance	REAL32	RW	<b>EL3423, EL3453</b> 0.000000 (0.000000e+000)  <b>EL3443</b> 3.000000 (3.000000e+000)

### Index F803 PMX Time Settings

Index (hex)	Name	Meaning	Data type	Flags	Default
F803:0	PMX Time Settings	Max. subindex	UINT8	RO	0x13 (19 <sub>dec</sub> )
F803:11	Measurement Mode	permitted values: 0	UINT32	RW	0x00000000 (0 <sub>dec</sub> )
F803:12	Measurement Interval	Time in seconds to automatic restart of the measurement and statistics interval	UINT32	RW	0x00000000 (0 <sub>dec</sub> )
F803:13	Actual System Time	Shows the current system time of the terminal. Write access to the object is possible in order to change the system time.	STRING	RW	

### Index F804 PMX Settings Neutral Current

Index (hex)	Name	Meaning	Data type	Flags	Default
F804:0	PMX Settings Neutral Current	Max. subindex	UINT8	RO	0x14 (20 <sub>dec</sub> )
F804:12	Current Transformer Ratio	The transmission ratio of the current transformer used can be entered here.	REAL32	RW	1.000000 (1.000000e+000)
F804:13	Current Transformer Delay	A possible time delay of the current transformers in milliseconds can be entered here.	REAL32	RW	0.000000 (0.000000e+000)
F804:14	Current Range	Selection of the current measuring range: 100: 100 mA 1000: 1 A 5000: 5 A	UINT32	RW	1 A (1000)

### Index F805 PMX User Scale Neutral Current

Index (hex)	Name	Meaning	Data type	Flags	Default
F805:0	PMX User Scale Neutral Current	Max. subindex	UINT8	RO	0x15 (21 <sub>dec</sub> )
F805:01	User Calibration Enable	Enable user calibration	BOOLEAN	RW	0x00 (0 <sub>dec</sub> )
F805:13	User Calibration Current Offset	Value in A	REAL32	RW	0.000000 (0.000000e+000)
F805:14	User Calibration Current Gain	Factor (without unit)	REAL32	RW	1.000000 (1.000000e+000)
F805:15	User Calibration Phase Offset	Value in ms	REAL32	RW	0.000000 (0.000000e+000)

### 6.6.4.3 Configuration data (vendor-specific)

Index 80nF PMX vendor data (for ch.1, n = 0; ch.2, n = 1; ch.3, n = 2)

Index (hex)	Name	Meaning	Data type	Flags	Default
80nF:0	PMX Vendor data	Max. subindex	UINT8	RO	0x1C (28 <sub>dec</sub> )
80nF:11	Calibration Voltage Offset	Value in V	REAL32	RW	0.000000 (0.000000e+000)
80nF:12	Calibration Voltage Gain	Factor (without unit)	REAL32	RW	1.000000 (1.000000e+000)
80nF:13	Calibration Voltage Phase Offset	Value in milliseconds	REAL32	RW	0.000000 (0.000000e+000)
80nF:14	Calibration Current Offset	Value in A	REAL32	RW	0.000000 (0.000000e+000)
80nF:15	Calibration Current Gain	Factor (without unit)	REAL32	RW	1.000000 (1.000000e+000)
80nF:16	Calibration Current Phase Offset	Value in milliseconds	REAL32	RW	0.000000 (0.000000e+000)
80nF:17	Calibration Current 1 Offset	Value in A	REAL32	RW	0.000000 (0.000000e+000)
80nF:18	Calibration Current 1 Gain	Factor (without unit)	REAL32	RW	1.000000 (1.000000e+000)
80nF:19	Calibration Current 1 Phase Offset	Value in milliseconds	REAL32	RW	0.000000 (0.000000e+000)
80nF:1A	Calibration Current 2 Offset	Value in A	REAL32	RW	0.000000 (0.000000e+000)
80nF:1B	Calibration Current 2 Gain	Factor (without unit)	REAL32	RW	1.000000 (1.000000e+000)
80nF:1C	Calibration Current 2 Phase Offset	Value in milliseconds	REAL32	RW	0.000000 (0.000000e+000)

## 6.6.4.4 Input data

### Index 60n0 PMX status (n = 0, 1, 2)

Index (hex)	Name	Meaning	Data type	Flags	Default
60n0:0	PMX Status	Max. subindex	UINT8	RO	0x10 (16 <sub>dec</sub> )
60n0:01	Voltage Sign Bit	Indicates the sign of the current sine wave voltage: 1 = U > 0V 0 = U < 0V	BOOLEAN	RO	0x00 (0 <sub>dec</sub> )
60n0:02	Overvoltage	Maximum measurable voltage is exceeded.	BOOLEAN	RO	0x00 (0 <sub>dec</sub> )
60n0:03	Overcurrent	Maximum measurable current is exceeded.	BOOLEAN	RO	0x00 (0 <sub>dec</sub> )
60n0:04	Inaccurate Voltage	The measured voltage value is smaller than the value entered in CoE object "F800:15 Inaccurate Threshold Voltage".	BOOLEAN	RO	0x00 (0 <sub>dec</sub> )
60n0:05	Inaccurate Current	The measured current value is smaller than the value entered in CoE object "F800:16 Inaccurate Threshold Current".	BOOLEAN	RO	0x00 (0 <sub>dec</sub> )
60n0:06	Voltage Guard Warning	A warning limit of the voltage monitor has been breached.	BOOLEAN	RO	0x00 (0 <sub>dec</sub> )
60n0:07	Voltage Guard Error	An error limit of the voltage monitor has been breached.	BOOLEAN	RO	0x00 (0 <sub>dec</sub> )
6000:10	TxPDO Toggle	The TxPDO toggle is toggled by the slave when the data of the associated TxPDO is updated.	BOOLEAN	RO	0x00 (0 <sub>dec</sub> )

### Index 60n1 PMX Basic (n = 0, 1, 2)

Index (hex)	Name	Meaning	Data type	Flags	Default
60n1:0	PMX Basic	Max. Subindex	UINT8	RO	0x12 (18 <sub>dec</sub> )
60n1:11	Voltage	RMS value of the voltage in V	REAL32	RO	0x00000000 (0 <sub>dec</sub> )
60n1:12	Current	RMS value of the current in A	REAL32	RO	0x00000000 (0 <sub>dec</sub> )

### Index 60n2 PMX Power (n = 0, 1, 2)

Index (hex)	Name	Meaning	Data type	Flags	Default
60n2:0	PMX Power	Max Subindex	UINT8	RO	0x14 (20 <sub>dec</sub> )
60n2:11	Active power	Active power in W	REAL32	RO	0x00000000 (0 <sub>dec</sub> )
60n2:12	Apparent Power	Apparent power in VA	REAL32	RO	0x00000000 (0 <sub>dec</sub> )
60n2:13	Reactive Power	Reactive power in var	REAL32	RO	0x00000000 (0 <sub>dec</sub> )
60n2:14	Power Factor	Power factor	REAL32	RO	0x00000000 (0 <sub>dec</sub> )

### Index 60n3 PMX Power Fundamental (n = 0, 1, 2)

Index (hex)	Name	Meaning	Data type	Flags	Default
60n3:0	PMX Power Fundamental	Max. subindex	UINT8	RO	0x14 (20 <sub>dec</sub> )
60n3:11	Active power Fund	Active power in W	REAL32	RO	0x00000000 (0 <sub>dec</sub> )
60n3:12	Apparent Power Fund	Apparent power in VA	REAL32	RO	0x00000000 (0 <sub>dec</sub> )
60n3:13	Reactive Power Fund	Reactive power in var	REAL32	RO	0x00000000 (0 <sub>dec</sub> )

### Index 60n4 PMX Energy (n = 0, 1, 2)

Index (hex)	Name	Meaning	Data type	Flags	Default
60n4:0	PMX Energy	Max. subindex	UINT8	RO	0x13 (19 <sub>dec</sub> )
60n4:11	Active Energy	Active energy in mWh	INT64	RO	
60n4:12	Apparent Energy	Apparent energy in mVAh	INT64	RO	
60n4:13	Reactive Energy	Reactive energy in mvarh	INT64	RO	



**Index 60n5 PMX Energy (n = 0, 1, 2)**

Index (hex)	Name	Meaning	Data type	Flags	Default
60n5:0	PMX Energy Fundamental	Max. subindex	UINT8	RO	0x13 (19 <sub>dec</sub> )
60n5:11	Active Energy Fund	Active energy fundamental in mWh	INT64	RO	
60n5:12	Apparent Energy Fund	Apparent energy fundamental in mVAh	INT64	RO	
60n5:13	Reactive Energy Fund	Reactive energy fundamental in mvarh	INT64	RO	

**Index 60n6 PMX Timing (n = 0, 1, 2)**

Index (hex)	Name	Meaning	Data type	Flags	Default
60n6:0	PMX Timing	Max Subindex	UINT8	RO	0x12 (18 <sub>dec</sub> )
60n6:12	Voltage Last Zero Crossing	Last detected voltage zero crossing as distributed clock time	UINT64	RO	
60n6:12	Current Last Zero Crossing	Last detected current zero crossing as distributed clock time	UINT64	RO	

**Index 60n7 PMX Advanced (n = 0, 1, 2)**

Index (hex)	Name	Meaning	Data type	Flags	Default
60n7:0	PMX Advanced	Max Subindex	UINT8	RO	0x14 (20 <sub>dec</sub> )
60n7:10	TxPDO Toggle	The TxPDO toggle is toggled by the slave when the data of the associated TxPDO is updated.	BOOLEAN	RO	0x00 (0 <sub>dec</sub> )
60n7:11	Voltage Total Harmonic Distortion	"Total Harmonic Distortion" is the distortion factor of the voltage. It indicates the ratio of the harmonic components of an oscillation relative to its fundamental in %.	REAL32	RO	0x00000000 (0 <sub>dec</sub> )
60n7:12	Current Distortion Factor	The "Current Distortion Factor" is also referred to as TDD (Total Demand Distortion). It indicates the ratio between the current harmonics and the maximum current (EL3443: 1A and EL3443-0010: 5A). Specified in % of the maximum current.	REAL32	RO	0x00000000 (0 <sub>dec</sub> )
60n7:13	Current Total Harmonic Distortion	"Total Harmonic Distortion" is the distortion factor of the current. It indicates the ratio of the harmonic components of an oscillation relative to its fundamental in %.	REAL32	RO	0x00000000 (0 <sub>dec</sub> )
60n7:14	Cos phi	Phase angle of the fundamental wave in degrees	REAL32	RO	0x00000000 (0 <sub>dec</sub> )

**Index 60n8 PMX Statistic Voltage (n = 0, 1, 2)**

Index (hex)	Name	Meaning	Data type	Flags	Default
60n8:0	PMX Statistic Voltage	Max Subindex	UINT8	RO	0x13 (19 <sub>dec</sub> )
60n8:11	Voltage Peak	Peak value of the instantaneous voltage in the last interval in V	REAL32	RO	0x00000000 (0 <sub>dec</sub> )
60n8:12	Voltage RMS Minimum	Minimum RMS value of the voltage in the last interval in V	REAL32	RO	0x00000000 (0 <sub>dec</sub> )
60n8:13	Voltage RMS Maximum	Maximum RMS value of the voltage in the last interval in V	REAL32	RO	0x00000000 (0 <sub>dec</sub> )

**Index 60n9 PMX Statistic Current (n = 0, 1, 2)**

Index (hex)	Name	Meaning	Data type	Flags	Default
60n9:0	PMX Statistic Current	Max Subindex	UINT8	RO	0x13 (19 <sub>dec</sub> )
60n9:11	Current Peak	Peak value of the instantaneous current in the last interval in A	REAL32	RO	0x00000000 (0 <sub>dec</sub> )
60n9:12	Current RMS Minimum	Minimum RMS value of the current in the last interval in A	REAL32	RO	0x00000000 (0 <sub>dec</sub> )
60n9:13	Current RMS Maximum	Maximum RMS value of the current in the last interval in A	REAL32	RO	0x00000000 (0 <sub>dec</sub> )

## Index 60nA PMX Statistic Power (n = 0, 1, 2)

Index (hex)	Name	Meaning	Data type	Flags	Default
60nA:0	PMX Statistic Power	Max Subindex	UINT8	RO	0x19 (25 <sub>dec</sub> )
60nA:11	Active Power Avg	Average active power during the last interval in W	REAL32	RO	0x00000000 (0 <sub>dec</sub> )
60nA:12	Active Power Min	Minimum active power in the last interval in W	REAL32	RO	0x00000000 (0 <sub>dec</sub> )
60nA:13	Active Power Max	Maximum active power in the last interval in W	REAL32	RO	0x00000000 (0 <sub>dec</sub> )
60nA:14	Apparent Power Avg	Average apparent power during the last interval in VA	REAL32	RO	0x00000000 (0 <sub>dec</sub> )
60nA:15	Apparent Power Max	Maximum apparent power in the last interval in VA	REAL32	RO	0x00000000 (0 <sub>dec</sub> )
60nA:16	Reactive Power Avg	Average reactive power average during the last interval in var	REAL32	RO	0x00000000 (0 <sub>dec</sub> )
60nA:17	Reactive Power Min	Minimum reactive power in the last interval in var	REAL32	RO	0x00000000 (0 <sub>dec</sub> )
60nA:18	Reactive Power Max	Maximum reactive power in the last interval in var	REAL32	RO	0x00000000 (0 <sub>dec</sub> )
60nA:19	Apparent Power Min	Minimum apparent power in the last interval in VA	REAL32	RO	0x00000000 (0 <sub>dec</sub> )

## Index 60nB PMX Classic (n = 0, 1, 2)

Index (hex)	Name	Meaning	Data type	Flags	Default
600B:0	PMX Classic	Max. subindex	UINT8	RO	0x16 (22 <sub>dec</sub> )
600B:10	TxPDO Toggle	The TxPDO toggle is toggled by the slave when the data of the associated TxPDO is updated.	BOOLEAN	RO	0x00 (0 <sub>dec</sub> )
600B:11	Voltage	RMS value of the voltage in 0.001 V	INT32	RO	0x00000000 (0 <sub>dec</sub> )
600B:12	Current	RMS value of the current in 0.0001 A	INT32	RO	0x00000000 (0 <sub>dec</sub> )
600B:13	Frequency	Frequency of the fundamental in 0.001 Hz	INT32	RO	0x00000000 (0 <sub>dec</sub> )
600B:14	Active Power	Active power in 0.001 W	INT32	RO	0x00000000 (0 <sub>dec</sub> )
600B:15	Apparent Power	Apparent power in 0.001 VA	INT32	RO	0x00000000 (0 <sub>dec</sub> )
600B:16	Reactive Power	Reactive power in 0.001 var	INT32	RO	0x00000000 (0 <sub>dec</sub> )

## Index F600 PMX Total Status

Index (hex)	Name	Meaning	Data type	Flags	Default
F600:0	PMX Total Status	Max. subindex	UINT8	RO	0x11 (17 <sub>dec</sub> )
F600:01	System State	Overall system state (as a logical disjunction of voltage guard errors, phase sequence, overvoltage, overcurrent and frequency guard errors)	BOOLEAN	RO	0x00 (0 <sub>dec</sub> )
F600:02	Grid Direction	Phase sequence L1 - L2 - L3 correctly detected (with clockwise 3-phase mains)	BOOLEAN	RO	0x00 (0 <sub>dec</sub> )
F600:03	Frequency Guard Warning	A warning limit of the frequency monitor has been breached.	BOOLEAN	RO	0x00 (0 <sub>dec</sub> )
F600:04	Frequency Guard Error	An error limit of the frequency monitor has been breached.	BOOLEAN	RO	0x00 (0 <sub>dec</sub> )
F600:05	Neutral Current Guard Warning	A warning limit of the neutral conductor current monitor has been breached.	BOOLEAN	RO	0x00 (0 <sub>dec</sub> )
F600:06	Neutral Current Guard Error	An error limit of the neutral conductor current monitor has been breached.	BOOLEAN	RO	0x00 (0 <sub>dec</sub> )
F600:07	Active Power Guard Warning	A warning limit of the active power monitor has been breached.	BOOLEAN	RO	0x00 (0 <sub>dec</sub> )
F600:08	Active Power Guard Error	An error limit of the active power monitor has been breached.	BOOLEAN	RO	0x00 (0 <sub>dec</sub> )
F600:09	Apparent Power Guard Warning	A warning limit of the apparent power monitor has been breached.	BOOLEAN	RO	0x00 (0 <sub>dec</sub> )
F600:0A	Apparent Power Guard Error	An error limit of the apparent power monitor has been breached.	BOOLEAN	RO	0x00 (0 <sub>dec</sub> )
F600:0B	Power Quality Guard Warning	A warning limit of the PQF monitor has been breached.	BOOLEAN	RO	0x00 (0 <sub>dec</sub> )
F600:0C	Power Quality Guard Error	An error limit of the PQF monitor has been breached.	BOOLEAN	RO	0x00 (0 <sub>dec</sub> )
F600:0F	TxPDO State	TRUE for general error	BOOLEAN	RO	0x00 (0 <sub>dec</sub> )
F600:10	TxPDO Toggle	The TxPDO toggle is toggled by the slave when the data of the associated TxPDO is updated.	BOOLEAN	RO	0x00 (0 <sub>dec</sub> )
F600:11	Power Quality Factor	Analog value of the voltage quality between 1.0 and 0 (see basic function principles - Power Quality Factor)	REAL32	RO	0x00000000 (0 <sub>dec</sub> )

**Index F601 PMX Total Basic**

Index (hex)	Name	Meaning	Data type	Flags	Default
F601:0	PMX Total Basic	Max. subindex	UINT8	RO	0x13 (19 <sub>dec</sub> )
F601:11	Frequency	Frequency in Hz	REAL32	RO	0x00000000 (0 <sub>dec</sub> )
F601:12	Power Factor	Power factor	REAL32	RO	0x00000000 (0 <sub>dec</sub> )
F601:14	Calculated Error Current	Calculated residual current ( $I_{L1} + I_{L2} + I_{L3} + I_N + I_{Err} = 0$ ) in A	REAL32	RO	0x00000000 (0 <sub>dec</sub> )
F601:15	Neutral line Current	Measured RMS value of neutral current in A	REAL32	RO	0x00000000 (0 <sub>dec</sub> )
F601:16	ROCOF	Rate of change of frequency (ROCOF or df/dt) in Hz/s	REAL32	RO	0x00000000 (0 <sub>dec</sub> )

**Index F602 PMX Total Advanced**

Index (hex)	Name	Meaning	Data type	Flags	Default
F602:0	PMX Total Advanced	Max. subindex	UINT8	RO	0x14 (20 <sub>dec</sub> )
F602:01	Unbalance Guard Warning	A warning limit of the unbalance monitor has been breached.	BOOLEAN	RO	0x00 (0 <sub>dec</sub> )
F602:02	Unbalance Guard Error	An error limit of the unbalance monitor has been breached.	BOOLEAN	RO	0x00 (0 <sub>dec</sub> )
F602:10	TxPDO Toggle	The TxPDO toggle is toggled by the slave when the data of the associated TxPDO is updated.	BOOLEAN	RO	0x00 (0 <sub>dec</sub> )
F602:11	Max Voltage Harmonic Distortion	Maximum distortion factor of all three phase voltages in %.	REAL32	RO	0x00000000 (0 <sub>dec</sub> )
F602:12	Max Current Harmonic Distortion	Maximum distortion factor of all three phase currents in %	REAL32	RO	0x00000000 (0 <sub>dec</sub> )
F602:13	Max Current Distortion Factor	Maximum "Total Demand Distortion" value of all three phases in %	REAL32	RO	0x00000000 (0 <sub>dec</sub> )
F602:14	Voltage Unbalance	Ratio between negative and positive voltage system in %	REAL32	RO	0x00000000 (0 <sub>dec</sub> )

**Index F603 PMX Total Active**

Index (hex)	Name	Meaning	Data type	Flags	Default
F603:0	PMX Total Active	Max. subindex	UINT8	RO	0x14 (20 <sub>dec</sub> )
F603:11	Active Power	Active power in W	REAL32	RO	
F603:12	Active Energy	Recorded active energy in mWh	INT64	RO	
F603:13	Active Positive Energy	Received active energy in mWh	INT64	RO	
F603:14	Active Negative Energy	Supplied active energy in mWh	INT64	RO	

**Index F604 PMX Total Active Fundamental**

Index (hex)	Name	Meaning	Data type	Flags	Default
F604:0	PMX Total Active Fundamental	Max. subindex	UINT8	RO	0x14 (20 <sub>dec</sub> )
F604:11	Active Power Fund	Active power of the fundamental oscillation in W	INT64	RO	
F604:12	Active Energy Fund	Balanced active energy fundamental oscillation in mWh	INT64	RO	
F604:13	Active Positive Energy Fund	Related active energy of the fundamental oscillation in mWh	INT64	RO	
F604:14	Active Negative Energy Fund	Active energy fed into the system of the fundamental oscillation in mWh	INT64	RO	

**Index F605 PMX Total Apparent**

Index (hex)	Name	Meaning	Data type	Flags	Default
F605:0	PMX Total Apparent	Max. subindex	UINT8	RO	0x14 (20 <sub>dec</sub> )
F605:11	Apparent Power	Balanced apparent power in VA	INT64	RO	
F605:12	Apparent Energy	Recorded apparent energy in mWh	INT64	RO	
F605:13	Apparent Positive Energy	Received apparent energy in mWh	UINT64	RO	
F605:14	Apparent Negative Energy	Supplied apparent energy in mWh	UINT64	RO	

**Index F606 PMX Total Apparent Fundamental**

Index (hex)	Name	Meaning	Data type	Flags	Default
F606:0	PMX Total Apparent Fundamental	Max. subindex	UINT8	RO	0x14 (20 <sub>dec</sub> )
F606:11	Apparent Power Fund	Apparent power fundamental in VA	INT64	RO	
F606:12	Apparent Energy	Recorded apparent energy in mWh	INT64	RO	
F606:13	Apparent Positive Energy	Received apparent energy in mWh	UINT64	RO	
F606:14	Apparent Negative Energy	Supplied apparent energy in mWh	UINT64	RO	

**Index F607 PMX Total Reactive**

Index (hex)	Name	Meaning	Data type	Flags	Default
F607:0	PMX Total Reactive	Max. subindex	UINT8	RO	0x14 (20 <sub>dec</sub> )
F607:11	Reactive Power	Balanced reactive power in Var	INT64	RO	
F607:12	Reactive Energy	Recorded reactive energy in mWh	INT64	RO	
F607:13	Reactive Positive Energy	Received reactive energy in mWh	UINT64	RO	
F607:14	Reactive Negative Energy	Supplied reactive energy in mWh	UINT64	RO	

**Index F608 PMX Total Reactive Fundamental**

Index (hex)	Name	Meaning	Data type	Flags	Default
F608:0	PMX Total Reactive Fundamental	Max. subindex	UINT8	RO	0x14 (20 <sub>dec</sub> )
F608:11	Reactive Power Fund	Balanced reactive power of the fundamental oscillation in Var	INT64	RO	
F608:12	Reactive Energy	Recorded reactive energy in mWh	INT64	RO	
F608:13	Reactive Positive Energy	Received reactive energy in mWh	UINT64	RO	
F608:14	Reactive Negative Energy	Supplied reactive energy in mWh	UINT64	RO	

**Index F609 PMX Total L-L Voltages**

Index (hex)	Name	Meaning	Data type	Flags	Default
F609:0	PMX Total L-L Voltages	Max. subindex	UINT8	RO	0x13 (19 <sub>dec</sub> )
F609:11	L1-L2 Voltage	RMS value of the phase-to-phase voltage between L1 and L2 in V	REAL32	RO	0x00000000 (0 <sub>dec</sub> )
F609:12	L2-L3 Voltage	RMS value of the phase-to-phase voltage between L2 and L3 in V	REAL32	RO	0x00000000 (0 <sub>dec</sub> )
F609:13	L3-L1 Voltage	RMS value of the phase-to-phase voltage between L3 and L1 in V	REAL32	RO	0x00000000 (0 <sub>dec</sub> )

**Index F60A PMX Variant Value In**

Index (hex)	Name	Meaning	Data type	Flags	Default
F60A:0	PMX Variant Value In	Max. subindex	UINT8	RO	0x18 (24 <sub>dec</sub> )
F60A:10	TxPDO Toggle	The TxPDO toggle is toggled by the slave when the data of the associated TxPDO is updated.	BOOLEAN	RO	0x00 (0 <sub>dec</sub> )
F60A:11	Index 1 REAL	Acknowledge for variable output value 1	UINT16	RO	0x0000 (0 <sub>dec</sub> )
F60A:12	Value 1 REAL	variable output value channel 1	REAL32	RO	0x00000000 (0 <sub>dec</sub> )
F60A:13	Index 2 REAL	Acknowledge for variable output value 2	UINT16	RO	0x0000 (0 <sub>dec</sub> )
F60A:14	Value 2 REAL	variable output value channel 2	REAL32	RO	0x00000000 (0 <sub>dec</sub> )
F60A:15	Index 3 REAL	Acknowledge for variable output value 3	UINT16	RO	0x0000 (0 <sub>dec</sub> )
F60A:16	Value 3 REAL	variable output value channel 3	REAL32	RO	0x00000000 (0 <sub>dec</sub> )
F60A:17	Index 4 ULINT	Acknowledge for variable output value 4	UINT16	RO	0x0000 (0 <sub>dec</sub> )
F60A:18	Value 4 ULINT	variable output value channel 4	UINT64	RO	

**Index F60B PMX Total Statistic Power**

Index (hex)	Name	Meaning	Data type	Flags	Default
F60B:0	PMX Total Statistic Power	Max. subindex	UINT8	RO	0x19 (25 <sub>dec</sub> )
F60B:11	Active Power Avg	Average total active power during the last interval in W	REAL32	RO	0x00000000 (0 <sub>dec</sub> )
F60B:12	Active Power Min	Minimum total active power in the last interval in W	REAL32	RO	0x00000000 (0 <sub>dec</sub> )
F60B:13	Active Power Max	Maximum total active power in the last interval in W	REAL32	RO	0x00000000 (0 <sub>dec</sub> )
F60B:14	Apparent Power Avg	Average total apparent power during the last interval in VA	REAL32	RO	0x00000000 (0 <sub>dec</sub> )
F60B:15	Apparent Power Min	Minimum total apparent power in the last interval in VA	REAL32	RO	0x00000000 (0 <sub>dec</sub> )
F60B:16	Apparent Power Max	Maximum total apparent power in the last interval in VA	REAL32	RO	0x00000000 (0 <sub>dec</sub> )
F60B:17	Reactive Power Avg	Average total reactive power average during the last interval in Var	REAL32	RO	0x00000000 (0 <sub>dec</sub> )
F60B:18	Reactive Power Min	Minimum total reactive power in the last interval in Var	REAL32	RO	0x00000000 (0 <sub>dec</sub> )
F60B:19	Reactive Power Max	Maximum total reactive power in the last interval in Var	REAL32	RO	0x00000000 (0 <sub>dec</sub> )

**Index F60C PMX Total Statistic PQF**

Index (hex)	Name	Meaning	Data type	Flags	Default
F60C:0	PMX Total Statistic PQF	Max. subindex	UINT8	RO	0x13 (19 <sub>dec</sub> )
F60C:11	PQF Avg	Average value of the power quality factor during the last interval	REAL32	RO	0x00000000 (0 <sub>dec</sub> )
F60C:12	PQF Min	Minimum power quality factor in the last interval	REAL32	RO	0x00000000 (0 <sub>dec</sub> )
F60C:13	PQF Max	Maximum power quality factor in the last interval	REAL32	RO	0x00000000 (0 <sub>dec</sub> )

**Index F60D PMX Total Interval Energy**

Index (hex)	Name	Meaning	Data type	Flags	Default
F60D:0	PMX Total Interval Energy	Max. subindex	UINT8	RO	0x19 (25 <sub>dec</sub> )
F60D:10	TxPDO Toggle	The TxPDO toggle is toggled by the slave when the data of the associated TxPDO is updated.	BOOLEAN	RO	0x00 (0 <sub>dec</sub> )
F60D:11	Active Energy	Recorded total active energy during the last interval in mWh	REAL32	RO	0x00000000 (0 <sub>dec</sub> )
F60D:12	Active Energy Positive	Received total active energy during the last interval in mWh	REAL32	RO	0x00000000 (0 <sub>dec</sub> )
F60D:13	Active Energy Negative	Supplied total active energy during at last interval in mWh	REAL32	RO	0x00000000 (0 <sub>dec</sub> )
F60D:14	Apparent Energy	Recorded total apparent energy during the last interval in mWh	REAL32	RO	0x00000000 (0 <sub>dec</sub> )
F60D:15	Apparent Energy Positive	Received total apparent energy during the last interval in mWh	REAL32	RO	0x00000000 (0 <sub>dec</sub> )
F60D:16	Apparent Energy Negative	Supplied total apparent energy during the last interval in mWh	REAL32	RO	0x00000000 (0 <sub>dec</sub> )
F60D:17	Reactive Energy	Recorded total reactive energy during the last interval in mWh	REAL32	RO	0x00000000 (0 <sub>dec</sub> )
F60D:18	Reactive Energy Positive	Received total reactive energy during the last interval in mWh	REAL32	RO	0x00000000 (0 <sub>dec</sub> )
F60D:19	Reactive Energy Negative	Supplied total reactive energy during the last interval in mWh	REAL32	RO	0x00000000 (0 <sub>dec</sub> )

## Index F60E PMX Total Interval Energy Fundamental

Index (hex)	Name	Meaning	Data type	Flags	Default
F60E:0	PMX Total Interval Energy Fundamental	Max. subindex	UINT8	RO	0x19 (25 <sub>dec</sub> )
F60E:10	TxPDO Toggle	The TxPDO toggle is toggled by the slave when the data of the associated TxPDO is updated.	BOOLEAN	RO	0x00 (0 <sub>dec</sub> )
F60E:11	Active Energy Fund	Balanced total effective energy of the fundamental in the last interval in Wh	REAL32	RO	0x00000000 (0 <sub>dec</sub> )
F60E:12	Active Energy Positive Fund	Total active energy related of the fundamental in the last interval in Wh	REAL32	RO	0x00000000 (0 <sub>dec</sub> )
F60E:13	Active Energy Negative Fund	Total active energy of the fundamental in the last interval fed in Wh	REAL32	RO	0x00000000 (0 <sub>dec</sub> )
F60E:14	Apparent Energy Fund	Balanced total apparent energy of the fundamental in the last interval in VA	REAL32	RO	0x00000000 (0 <sub>dec</sub> )
F60E:15	Apparent Energy Positive Fund	Total apparent energy related of the fundamental in the last interval in VA	REAL32	RO	0x00000000 (0 <sub>dec</sub> )
F60E:16	Apparent Energy Negative Fund	Total apparent energy of the fundamental in the last interval fed in VA	REAL32	RO	0x00000000 (0 <sub>dec</sub> )
F60E:17	Reactive Energy Fund	Balanced total reactive energy of the fundamental in the last interval in var	REAL32	RO	0x00000000 (0 <sub>dec</sub> )
F60E:18	Reactive Energy Positive Fund	Total reactive energy related of the fundamental in the last interval in var	REAL32	RO	0x00000000 (0 <sub>dec</sub> )
F60E:19	Reactive Energy Negative Fund	Total reactive energy of the fundamental in the last interval fed in var	REAL32	RO	0x00000000 (0 <sub>dec</sub> )

## Index F60F PMX Total System Angles

Index (hex)	Name	Meaning	Data type	Flags	Default
F60F:0	PMX Total System Angles	Max. subindex	UINT8	RO	0x15 (21 <sub>dec</sub> )
F60F:11	Voltage Angle L1 L2	Angle between the phase voltages of L1 and L2	REAL32	RO	0x00000000 (0 <sub>dec</sub> )
F60F:12	Voltage Angle L1 L3	Angle between the phase voltages of L1 and L3	REAL32	RO	0x00000000 (0 <sub>dec</sub> )
F60F:13	Current Angle L1	Phase angle of the current of L1	REAL32	RO	0x00000000 (0 <sub>dec</sub> )
F60F:14	Current Angle L2	Phase angle of the current of L2	REAL32	RO	0x00000000 (0 <sub>dec</sub> )
F60F:15	Current Angle L3	Phase angle of the current of L3	REAL32	RO	0x00000000 (0 <sub>dec</sub> )

## Index F610 PMX Total System

Index (hex)	Name	Meaning	Data type	Flags	Default
F610:0	PMX Total System	Max. subindex	UINT8	RO	0x13 (19 <sub>dec</sub> )
F610:11	Positive Sequence	Voltage of the co-system	REAL32	RO	0x00000000 (0 <sub>dec</sub> )
F610:12	Negative Sequence	Voltage of the opposing system	REAL32	RO	0x00000000 (0 <sub>dec</sub> )
F610:13	Zero Sequence	Zero system voltage	REAL32	RO	0x00000000 (0 <sub>dec</sub> )

**Index F611 PMX Total Statistic Power Fundamental**

Index (hex)	Name	Meaning	Data type	Flags	Default
F611:0	PMX Total Statistic Power Fundamental	Max. subindex	UINT8	RO	0x18 (24 <sub>dec</sub> )
F611:10	Active Power Avg Fund	Average total active power of the fundamental of the last interval in W	REAL32	RO	0x00000000 (0 <sub>dez</sub> )
F611:11	Active Power Min Fund	Total active power minimum of the fundamental in the last interval in W	REAL32	RO	0x00000000 (0 <sub>dez</sub> )
F611:12	Active Power Max Fund	Total active power maximum of the fundamental in the last interval in W	REAL32	RO	0x00000000 (0 <sub>dez</sub> )
F611:13	Apparent Power Avg Fund	Average total apparent power of the fundamental of the last interval in VA	REAL32	RO	0x00000000 (0 <sub>dez</sub> )
F611:14	Apparent Power Min Fund	Total apparent power minimum of the fundamental in the last interval in VA	REAL32	RO	0x00000000 (0 <sub>dez</sub> )
F611:15	Apparent Power Max Fund	Total apparent power maximum of the fundamental in the last interval in VA	REAL32	RO	0x00000000 (0 <sub>dez</sub> )
F611:16	Reactive Power Avg Fund	Average total reactive power of the fundamental of the last interval in var	REAL32	RO	0x00000000 (0 <sub>dez</sub> )
F611:17	Reactive Power Min Fund	Total reactive power minimum of the fundamental in the last interval in var	REAL32	RO	0x00000000 (0 <sub>dez</sub> )
F611:18	Reactive Power Max Fund	Total reactive power maximum of the fundamental in the last interval in var	REAL32	RO	0x00000000 (0 <sub>dez</sub> )

**6.6.4.5 Output data**

**Index F700 PMX Variant Value Out**

Index (hex)	Name	Meaning	Data type	Flags	Default
F700:0	PMX Variant Value Out	Max. subindex	UINT8	RO	0x14 (20 <sub>dec</sub> )
F700:11	Index 1 REAL	Request for variable output value 1 (REAL) Can be used for all non-energy values (details see settings)	UINT16	RO	0x0000 (0 <sub>dec</sub> )
F700:12	Index 2 REAL	Request for variable output value 2 (REAL) Can be used for all non-energy values (details see settings)	UINT16	RO	0x0000 (0 <sub>dec</sub> )
F700:13	Index 3 REAL	Request for variable output value 3 (REAL) Can be used for all non-energy values (details see settings)	UINT16	RO	0x0000 (0 <sub>dec</sub> )
F700:14	Index 4 ULINT	Request for variable output value 4 (ULINT) Can be used for all energy values (which are output as ULINT): 45-59 and 1069-1083	UINT16	RO	0x0000 (0 <sub>dec</sub> )

**Index F701 PMX Interval**

Index (hex)	Name	Meaning	Data type	Flags	Default
F701:0	PMX Interval	Max. subindex	UINT8	RO	0x01 (1 <sub>dec</sub> )
F701:01	Reset Interval	Manual option for resetting the interval (see basic function principles – Statistical evaluation)	BOOLEAN	RO	0x00 (0 <sub>dec</sub> )

**6.6.4.6 Information and diagnostic data**

**Index 90n0 PMX info data voltage (for ch.1, n = 0; ch.2, n = 1; ch.3, n = 2)**

Index (hex)	Name	Meaning	Data type	Flags	Default
90n0:0	PMX Info data Voltage	Max. subindex	UINT8	RO	0x13 (19 <sub>dec</sub> )
90n0:11	Voltage Peak	Peak value of the instantaneous voltage in the last interval in V	REAL32	RO	0x00000000 (0 <sub>dec</sub> )
90n0:12	Voltage RMS Minimum	Minimum RMS value of the voltage in the last interval in V	REAL32	RO	0x00000000 (0 <sub>dec</sub> )
90n0:13	Voltage RMS Maximum	Maximum RMS value of the voltage in the last interval in V	REAL32	RO	0x00000000 (0 <sub>dec</sub> )

**Index 90n1 PMX info data current (for ch.1, n = 0; ch.2, n = 1; ch.3, n = 2)**

Index (hex)	Name	Meaning	Data type	Flags	Default
90n1:0	PMX Info data Current	Max. subindex	UINT8	RO	0x13 (19 <sub>dec</sub> )
90n1:11	Current Peak	Peak value of the instantaneous current in the last interval in A	REAL32	RO	0x00000000 (0 <sub>dec</sub> )
90n1:12	Current RMS Minimum	Minimum RMS value of the current in the last interval in A	REAL32	RO	0x00000000 (0 <sub>dec</sub> )
90n1:13	Current RMS Maximum	Maximum RMS value of the current in the last interval in A	REAL32	RO	0x00000000 (0 <sub>dec</sub> )

**Index 90n2 PMX info data power (for ch.1, n = 0; ch.2, n = 1; ch.3, n = 2)**

Index (hex)	Name	Meaning	Data type	Flags	Default
90n2:0	PMX Info data Power	Max. subindex	UINT8	RO	0x1B (27 <sub>dec</sub> )
90n2:11	Active Power Avg	Average active phase power during the last interval in W	REAL32	RO	0x00000000 (0 <sub>dec</sub> )
90n2:12	Active Power Min	Minimum active phase power during the last interval in W	REAL32	RO	0x00000000 (0 <sub>dec</sub> )
90n2:13	Active Power Max	Maximum active phase power during the last interval in W	REAL32	RO	0x00000000 (0 <sub>dec</sub> )
90n2:14	Apparent Power Avg	Average apparent phase power during the last interval in VA	REAL32	RO	0x00000000 (0 <sub>dec</sub> )
90n2:15	Apparent Power Min	Minimum apparent phase power during the last interval in VA	REAL32	RO	0x00000000 (0 <sub>dec</sub> )
90n2:16	Apparent Power Max	Maximum apparent phase power during the last interval in VA	REAL32	RO	0x00000000 (0 <sub>dec</sub> )
90n2:17	Reactive Power Avg	Average reactive phase power during the last interval in var	REAL32	RO	0x00000000 (0 <sub>dec</sub> )
90n2:18	Reactive Power Min	Minimum reactive phase power during the last interval in var	REAL32	RO	0x00000000 (0 <sub>dec</sub> )
90n2:19	Reactive Power Max	Maximum reactive phase power during the last interval in var	REAL32	RO	0x00000000 (0 <sub>dec</sub> )
90n2:1A	Phi	Phase angle in degrees (between voltage U_Lx and the corresponding current I_Lx)	REAL32	RO	0x00000000 (0 <sub>dec</sub> )
90n2:1B	Phase angle	Phase difference in degrees (between different voltages U_Lx and U_Ly)	REAL32	RO	0x00000000 (0 <sub>dec</sub> )

**Index 90n3 PMX info data energy (for ch.1, n = 0; ch.2, n = 1; ch.3, n = 2)**

Index (hex)	Name	Meaning	Data type	Flags	Default
90n3:0	PMX info data energy ch.1	Max. subindex	UINT8	RO	0x19 (25 <sub>dec</sub> )
90n3:11	Active Energy	Recorded active phase energy in mWh	INT64	RO	
90n3:12	Positive Active Energy	Received active phase energy in mWh	UINT64	RO	
90n3:13	Negative Active Energy	Supplied active phase energy in mWh	UINT64	RO	
90n3:14	Apparent Energy	Recorded apparent phase energy in mWh	INT64	RO	
90n3:15	Positive Apparent Energy	Received apparent phase energy in mWh	UINT64	RO	
90n3:16	Negative Apparent Energy	Supplied apparent phase energy in mWh	UINT64	RO	
90n3:17	Reactive Energy	Recorded reactive phase energy in mWh	INT64	RO	
90n3:18	Positive Reactive Energy	Received reactive phase energy in mWh	UINT64	RO	
90n3:19	Negative Reactive Energy	Supplied reactive phase energy in mWh	UINT64	RO	



**Index 90n4 PMX Harmonic Voltage (for ch.1, n = 0; ch.2, n = 1; ch.3, n = 2)**

Index (hex)	Name	Meaning	Data type	Flags	Default
90n4:0	PMX Harmonic Voltage Ch.1	Max. subindex	UINT8	RO	0x40 (64 <sub>dec</sub> )
90n4:01	Harmonic 0	DC component of the oscillation in % of the fundamental wave	REAL32	RO	0x00000000 (0 <sub>dec</sub> )
90n4:02	Harmonic 1	Fundamental wave	REAL32	RO	0x00000000 (0 <sub>dec</sub> )
90n4:03	Harmonic 2	2nd harmonic in % of the fundamental wave	REAL32	RO	0x00000000 (0 <sub>dec</sub> )
90n4:04	Harmonic 3	3rd harmonic in % of the fundamental wave	REAL32	RO	0x00000000 (0 <sub>dec</sub> )
...	...	...	...	...	...
90n4:40	Harmonic 63	63rd harmonic in % of the fundamental wave	REAL32	RO	0x00000000 (0 <sub>dec</sub> )

**Index 90n5 PMX Harmonic Current (for ch.1, n = 0; ch.2, n = 1; ch.3, n = 2)**

Index (hex)	Name	Meaning	Data type	Flags	Default
90n5:0	PMX Harmonic Voltage Ch.1	Max. subindex	UINT8	RO	0x40 (64 <sub>dec</sub> )
90n5:01	Harmonic 0	DC component of the oscillation in % of the fundamental wave	REAL32	RO	0x00000000 (0 <sub>dec</sub> )
90n5:02	Harmonic 1	Fundamental wave	REAL32	RO	0x00000000 (0 <sub>dec</sub> )
90n5:03	Harmonic 2	2nd harmonic in % of the fundamental wave	REAL32	RO	0x00000000 (0 <sub>dec</sub> )
90n5:04	Harmonic 3	3rd harmonic in % of the fundamental wave	REAL32	RO	0x00000000 (0 <sub>dec</sub> )
...	...	...	...	...	...
90n5:40	Harmonic 63	63rd harmonic in % of the fundamental wave	REAL32	RO	0x00000000 (0 <sub>dec</sub> )

**Index 90n6 PMX Info data Fundamental (for ch.1, n = 0; ch.2, n = 1; ch.3, n = 2)**

Index (hex)	Name	Meaning	Data type	Flags	Default
90n6:0	PMX Info data Fundamental Ch.1	Max. subindex	UINT8	RO	0x13 (19 <sub>dec</sub> )
90n6:10	Voltage Fundamental RMS	Effective voltage of the fundamental wave from the harmonic calculation	REAL32	RO	0.000000 (0.000000e+000)
90n6:11	Voltage Fundamental Frequency	Frequency of the fundamental voltage wave from the harmonic calculation	REAL32	RO	0.000000 (0.000000e+000)
90n6:12	Current Fundamental RMS	Effective current of the fundamental wave from the harmonic calculation	REAL32	RO	0.000000 (0.000000e+000)
90n6:13	Current Fundamental Frequency	Frequency of the fundamental current wave from the harmonic calculation	REAL32	RO	0.000000 (0.000000e+000)

**Index A0n0 PMX Diag data (for ch.1, n = 0; ch.2, n = 1; ch.3, n = 2)**

Index (hex)	Name	Meaning	Data type	Flags	Default
A0n0:0	PMX diag data ch.1	Max. subindex	UINT8	RO	0x12 (18 <sub>dec</sub> )
A0n0:11	Saturation Time Voltage	Time (in 0.1 ms) in which the terminal has measured an overvoltage.	UINT32	RO	0x00000000 (0 <sub>dec</sub> )
A0n0:12	Saturation Time Current	Time (in 0.1 ms) in which the terminal has measured an overcurrent.	UINT32	RO	0x00000000 (0 <sub>dec</sub> )

**Index F081 Download revision**

Index (hex)	Name	Meaning	Data type	Flags	Default
F081:0	Download revision	Max. subindex	UINT8	RO	0x01 (1 <sub>dec</sub> )
F010:01	Revision number	Configured revision of the terminal, (see note [► 139])	UINT32	RW	0x00000000 (0 <sub>dec</sub> )

## Index F80F PMX vendor data (for ch.1, n = 0; ch.2, n = 1; ch.3, n = 2)

Index (hex)	Name	Meaning	Data type	Flags	Default
F80F:0	PMX Vendor data	Max. subindex	UINT8	RO	0x1A (26 <sub>dec</sub> )
F80F:11	Type	Vendor-specific data	UINT32	RW	0x00000000
F80F:12	Calibration Current Offset	Value in A	REAL32	RW	0.000000 (0.000000e+000)
F80F:13	Calibration Current Gain	Factor (without unit)	REAL32	RW	1.000000 (1.000000e+000)
F80F:14	Calibration Current Phase Offset	Value in milliseconds	REAL32	RW	0.000000 (0.000000e+000)
F80F:15	Calibration Current 1 Offset	Value in A	REAL32	RW	0.000000 (0.000000e+000)
F80F:16	Calibration Current 1 Gain	Factor (without unit)	REAL32	RW	1.000000 (1.000000e+000)
F80F:17	Calibration Current 1 Phase Offset	Value in milliseconds	REAL32	RW	0.000000 (0.000000e+000)
F80F:18	Calibration Current 2 Offset	Value in A	REAL32	RW	0.000000 (0.000000e+000)
F80F:19	Calibration Current 2 1 Gain	Factor (without unit)	REAL32	RW	1.000000 (1.000000e+000)
F80F:1A	Calibration Current 2 Phase Offset	Value in milliseconds	REAL32	RW	0.000000 (0.000000e+000)

## Index F902 PMX Total Info data Power

Index (hex)	Name	Meaning	Data type	Flags	Default
F902:0	PMX Total Info data Power	Max. subindex	UINT8	RO	0x19 (25 <sub>dec</sub> )
F902:11	Active Power Avg	Average total active power during the last interval in W	REAL32	RO	0x00000000 (0 <sub>dec</sub> )
F902:12	Active Power Min	Minimum total active power in the last interval in W	REAL32	RO	0x00000000 (0 <sub>dec</sub> )
F902:13	Active Power Max	Maximum total active power in the last interval in W	REAL32	RO	0x00000000 (0 <sub>dec</sub> )
F902:14	Apparent Power Avg	Average total apparent power during the last interval in VA	REAL32	RO	0x00000000 (0 <sub>dec</sub> )
F902:15	Apparent Power Min	Minimum total apparent power in the last interval in VA	REAL32	RO	0x00000000 (0 <sub>dec</sub> )
F902:16	Apparent Power Max	Maximum total apparent power in the last interval in VA	REAL32	RO	0x00000000 (0 <sub>dec</sub> )
F902:17	Reactive Power Avg	Average total reactive power average during the last interval in var	REAL32	RO	0x00000000 (0 <sub>dec</sub> )
F902:18	Reactive Power Min	Minimum total reactive power in the last interval in var	REAL32	RO	0x00000000 (0 <sub>dec</sub> )
F902:19	Reactive Power Max	Maximum total reactive power in the last interval in var	REAL32	RO	0x00000000 (0 <sub>dec</sub> )

## Index F903 PMX Total Info data Energy

Index (hex)	Name	Meaning	Data type	Flags	Default
F903:0	PMX Total Info data Energy	Max. subindex	UINT8	RO	0x19 (25 <sub>dec</sub> )
F903:11	Active Energy	Recorded total active energy in mWh	INT64	RO	
F903:12	Positive Active Energy	Received total active energy in mWh	UINT64	RO	
F903:13	Negative Active Energy	Supplied total active energy in mWh	UINT64	RO	
F903:14	Apparent Energy	Recorded total apparent energy in mWh	INT64	RO	
F903:15	Positive Apparent Energy	Received total apparent energy in mWh	UINT64	RO	
F903:16	Negative Apparent Energy	Supplied total apparent energy in mWh	UINT64	RO	
F903:17	Reactive Energy	Recorded total reactive energy in mWh	INT64	RO	
F903:18	Positive Reactive Energy	Received total reactive energy in mWh	UINT64	RO	
F903:19	Negative Reactive Energy	Supplied total reactive energy in mWh	UINT64	RO	

**Index F904 PMX Total Info data PQF**

Index (hex)	Name	Meaning	Data type	Flags	Default
F904:0	PMX Total Info data PQF	Max. subindex	UINT8	RO	0x13 (19 <sub>dec</sub> )
F904:11	PQF Avg	Average value of the power quality factor during the last interval	REAL32	RO	0x00000000 (0 <sub>dec</sub> )
F904:12	PQF Min	Minimum power quality factor in the last interval	REAL32	RO	0x00000000 (0 <sub>dec</sub> )
F904:13	PQF Max	Maximum power quality factor in the last interval	REAL32	RO	0x00000000 (0 <sub>dec</sub> )

**Index F905 PMX Total Info data Power Fundamental**

Index (hex)	Name	Meaning	Data type	Flags	Default
F905:0	PMX Grid Info data Power Fundamental	Max. subindex	UINT8	RO	0x19 (25 <sub>dec</sub> )
F905:11	Active Power Avg Fund	Total active power average of fundamental oscillation of the last interval in W	REAL32	RO	0x00000000 (0 <sub>dec</sub> )
F905:12	Active Power Min Fund	Total active power minimum of fundamental oscillation in the last interval in W	REAL32	RO	0x00000000 (0 <sub>dec</sub> )
F905:13	Active Power Max Fund	Total active power maximum of fundamental oscillation in the last interval in W	REAL32	RO	0x00000000 (0 <sub>dec</sub> )
F905:14	Apparent Power Avg Fund	Total apparent power average of fundamental oscillation of the last interval in VA	REAL32	RO	0x00000000 (0 <sub>dec</sub> )
F905:15	Apparent Power Min Fund	Total apparent power minimum of fundamental oscillation of the last interval in VA	REAL32	RO	0x00000000 (0 <sub>dec</sub> )
F905:16	Apparent Power Max Fund	Total apparent power maximum of fundamental oscillation of the last interval in VA	REAL32	RO	0x00000000 (0 <sub>dec</sub> )
F905:17	Reactive Power Avg Fund	Total reactive power average of fundamental oscillation of the last interval in var	REAL32	RO	0x00000000 (0 <sub>dec</sub> )
F905:18	Reactive Power Min Fund	Total reactive power minimum of fundamental oscillation of the last interval in var	REAL32	RO	0x00000000 (0 <sub>dec</sub> )
F905:19	Reactive Power Max Fund	Total reactive power maximum of fundamental oscillation of the last interval in var	REAL32	RO	0x00000000 (0 <sub>dec</sub> )

**Index FA00 PMX Diag data**

Index (hex)	Name	Meaning	Data type	Flags	Default
FA00:0	PMX Diag data	Max. subindex	UINT8	RO	0x13 (19 <sub>dec</sub> )
FA00:11	Min CPU Die Temperature	Minimum CPU temperature measured so far	REAL32	RO	0x00000000 (0 <sub>dec</sub> )
FA00:12	Max CPU Die Temperature	Maximum CPU temperature measured so far	REAL32	RO	0x00000000 (0 <sub>dec</sub> )
FA00:13	EBUS Voltage	Current E-bus voltage	REAL32	RO	0x00000000 (0 <sub>dec</sub> )

**6.6.4.7 Standard objects**

**Index 1000 Device type**

Index (hex)	Name	Meaning	Data type	Flags	Default
1000:0	Device type	Device type of the EtherCAT slave: The Lo-Word contains the CoE profile used (5001). The Hi-Word contains the module profile according to the modular device profile.	UINT32	RO	0x01551389 (22352777 <sub>dec</sub> )

**Index 1008 Device name**

Index (hex)	Name	Meaning	Data type	Flags	Default
1008:0	Device name	Device name of the EtherCAT slave	STRING	RO	EL34xx

**Index 1009 Hardware version**

Index (hex)	Name	Meaning	Data type	Flags	Default
1009:0	Hardware version	Hardware version of the EtherCAT slave	STRING	RO	

**Index 100A Software Version**

Index (hex)	Name	Meaning	Data type	Flags	Default
100A:0	Software version	Firmware version of the EtherCAT slave	STRING	RO	

**Index 100B Bootloader version**

Index (hex)	Name	Meaning	Data type	Flags	Default
100B:0	Bootloader version	Bootloader version	STRING	RO	

**Index 1018 Identity**

Index (hex)	Name	Meaning	Data type	Flags	Default
1018:0	Identity	Information for identifying the slave	UINT8	RO	0x04 (4 <sub>dec</sub> )
1018:01	Vendor ID	Vendor ID of the EtherCAT slave	UINT32	RO	0x00000002 (2 <sub>dec</sub> )
1018:02	Product code	Product code of the EtherCAT slave	UINT32	RO	0x0D733052 (225652818 <sub>dez</sub> )
1018:03	Revision	Revision number of the EtherCAT slave; the low word (bit 0-15) indicates the special terminal number, the high word (bit 16-31) refers to the device description	UINT32	RO	0x00000000 (0 <sub>dec</sub> )
1018:04	Serial number	Serial number of the EtherCAT slave; the low byte (bit 0-7) of the low word contains the year of production, the high byte (bit 8-15) of the low word contains the week of production, the high word (bit 16-31) is 0	UINT32	RO	e.g. 0x00001E06 (KW 30/2006)

**Index 10F0 Backup parameter**

Index (hex)	Name	Meaning	Data type	Flags	Default
10F0:0	Backup parameter	Length of this object	UINT8	RO	0x01
10F0:01	Checksum	Checksum	UINT32	RW	0x00000000 (0 <sub>dec</sub> )

**Index 10F3 Diagnosis History**

Index	Name	Meaning	Data type	Flags	Default
10F3:0	Diagnosis History	Maximum subindex	UINT8	RO	0x15 (21 <sub>dec</sub> )
10F3:01	Maximum Messages	Maximum number of stored messages. A maximum of 50 messages can be stored	UINT8	RO	0x00 (0 <sub>dec</sub> )
10F3:02	Newest Message	Subindex of the latest message	UINT8	RO	0x00 (0 <sub>dec</sub> )
10F3:03	Newest Acknowledged Message	Subindex of the last confirmed message	UINT8	RW	0x00 (0 <sub>dec</sub> )
10F3:04	New Messages Available	Indicates that a new message is available	BOOLEAN	RO	0x00 (0 <sub>dec</sub> )
10F3:05	Flags	not used	UINT16	RW	0x0000 (0 <sub>dec</sub> )
10F3:06	Diagnosis Message 001	Message 1	OCTET STRING[28]	RO	{0}
...	...	...	...	...	...
10F3:15	Diagnosis Message 016	Message 16	OCTET STRING[28]	RO	{0}

**Index 10F8 Actual Time Stamp**

Index	Name	Meaning	Data type	Flags	Default
10F8:0	Actual Time Stamp	Time stamp	UINT64	RO	0x0000000000000000 00 (0 <sub>dec</sub> )

**Index 1600 Total RxPDO-Map Outputs Device**

Index (hex)	Name	Meaning	Data type	Flags	Default
1600:0	Total RxPDO-Map Outputs Device	PDO Mapping RxPDO 1	UINT8	RO	0x04 (4 <sub>dec</sub> )
1600:01	SubIndex 001	1. PDO Mapping entry (object 0xF700 (PMX Variant Value Out), entry 0x11 (Index 1 REAL))	UINT32	RO	0xF700:11, 16
1600:02	SubIndex 002	2. PDO Mapping entry (object 0xF700 (PMX Variant Value Out), entry 0x12 (Index 2 REAL))	UINT32	RO	0xF700:12, 16
1600:03	SubIndex 003	3. PDO Mapping entry (object 0xF700 (PMX Variant Value Out), entry 0x13 (Index 3 REAL))	UINT32	RO	0xF700:13, 16
1600:04	SubIndex 004	4. PDO Mapping entry (object 0xF700 (PMX Variant Value Out), entry 0x14 (Index 4 ULINT))	UINT32	RO	0xF700:14, 16

**Index 1601 Total RxPDO-Map Interval**

Index (hex)	Name	Meaning	Data type	Flags	Default
1601:0	Total RxPDO-Map Interval	PDO Mapping RxPDO 2	UINT8	RO	0x02 (2 <sub>dec</sub> )
1601:01	SubIndex 001	1. PDO Mapping entry (object 0xF701 (PMX Interval), entry 0x01 (Reset Interval))	UINT32	RO	0xF701:01, 1
1601:02	SubIndex 002	2. PDO Mapping entry (15 bits align)	UINT32	RO	0x0000:00, 15

**Index 1App TxPDO-Map Status (for L1, pp = 00; L2, pp = 0C; L3, pp = 18)**

Index (hex)	Name	Meaning	Data type	Flags	Default
1App:0	TxPDO-Map Status	PDO Mapping TxPDO	UINT8	RO	0x0B (11 <sub>dec</sub> )
1App:01	SubIndex 001	1. PDO Mapping entry (object 0x60n0 (PMX Status), entry 0x01 (Voltage Sign Bit))	UINT32	RO	0x60n0:01, 1**
1App:02	SubIndex 002	2. PDO Mapping entry (object 0x60n0 (PMX Status), entry 0x02 (Overvoltage))	UINT32	RO	0x60n0:02, 1**
1App:03	SubIndex 003	3. PDO Mapping entry (object 0x60n0 (PMX Status), entry 0x03 (Overcurrent))	UINT32	RO	0x60n0:03, 1**
1App:04	SubIndex 004	4. PDO Mapping entry (object 0x60n0 (PMX Status), entry 0x04 (Inaccurate Voltage))	UINT32	RO	0x60n0:04, 1**
1App:05	SubIndex 005	5. PDO Mapping entry (object 0x60n0 (PMX Status), entry 0x05 (Inaccurate Current))	UINT32	RO	0x60n0:05, 1**
1App:06	SubIndex 006	6. PDO Mapping entry (object 0x60n0 (PMX Status), entry 0x06 (Voltage Guard Warning))	UINT32	RO	0x60n0:06, 1**
1App:07	SubIndex 007	7. PDO Mapping entry (object 0x60n0 (PMX Status), entry 0x07 (Voltage Guard Error))	UINT32	RO	0x60n0:07, 1**
1App:08	SubIndex 008	8. PDO Mapping entry (object 0x60n0 (PMX Status), entry 0x08 (Current Guard Warning))	UINT32	RO	0x60n0:08, 1**
1App:09	SubIndex 009	9. PDO Mapping entry (object 0x60n0 (PMX Status), entry 0x09 (Current Guard Error))	UINT32	RO	0x60n0:09, 1**
1App:0A	SubIndex 010	10. PDO Mapping entry (6 bits align)	UINT32	RO	0x00n0:00, 6**
1App:0B	SubIndex 011	11. PDO Mapping entry (object 0x60n0 (PMX Status), entry 0x10 (TxPDO Toggle))	UINT32	RO	0x60n0:10, 1**

\*\* ) for L1, n = 0; L2, n = 1; L3, n = 2)

**Index 1App TxPDO-Map Basic (for L1, pp = 01; L2, pp = 0D; L3, pp = 19)**

Index (hex)	Name	Meaning	Data type	Flags	Default
1App:0	TxPDO-Map Statistic Basic	PDO Mapping TxPDO	UINT8	RO	0x02 (2 <sub>dec</sub> )
1App:01	SubIndex 001	1. PDO Mapping entry (object 0x60n1 (PMX Basic), entry 0x11 (Voltage))	UINT32	RO	0x60n1:11, 32**
1App:02	SubIndex 002	2. PDO Mapping entry (object 0x60n1 (PMX Basic), entry 0x12 (Current))	UINT32	RO	0x60n1:12, 32**

\*\* ) for L1, n = 0; L2, n = 1; L3, n = 2)

**Index 1App TxPDO-Map Power (for L1, pp = 02; L2, pp = 0E; L3, pp = 1A)**

Index (hex)	Name	Meaning	Data type	Flags	Default
1App:0	TxPDO-Map Power	PDO Mapping TxPDO	UINT8	RO	0x04 (4 <sub>dec</sub> )
1App:01	SubIndex 001	1. PDO Mapping entry (object 0x60n2 (PMX Power), entry 0x11 (Active Power))	UINT32	RO	0x60n2:11, 32**
1App:02	SubIndex 002	2. PDO Mapping entry (object 0x60n2 (PMX Power), entry 0x12 (Apparent Power))	UINT32	RO	0x60n2:12, 32**
1App:03	SubIndex 001	1. PDO Mapping entry (object 0x60n2 (PMX Power), entry 0x13 (Reactive Power))	UINT32	RO	0x60n2:13, 32**
1App:04	SubIndex 002	2. PDO Mapping entry (object 0x60n2 (PMX Power), entry 0x14 (Power Factor))	UINT32	RO	0x60n2:14, 32**

\*\*\*) for L1, n = 0; L2, n = 1; L3, n = 2)

**Index 1App TxPDO-Map Power Fundamental (for L1, pp = 03; L2, pp = 0F; L3, pp = 1B)**

Index (hex)	Name	Meaning	Data type	Flags	Default
1App:0	TxPDO-Map Power Fundamental	PDO Mapping TxPDO	UINT8	RO	0x03 (3 <sub>dec</sub> )
1App:01	SubIndex 001	1. PDO Mapping entry (object 0x60n3 (PMX Power Fundamental), entry 0x11 (Active Power Fund))	UINT32	RO	0x60n3:11, 32**
1App:02	SubIndex 002	2. PDO Mapping entry (object 0x60n3 (PMX Power Fundamental), entry 0x12 (Apparent Power Fund))	UINT32	RO	0x60n3:12, 32**
1App:03	SubIndex 001	1. PDO Mapping entry (object 0x60n3 (PMX Power Fundamental), entry 0x13 (Reactive Power Fund))	UINT32	RO	0x60n3:13, 32**

\*\*\*) for L1, n = 0; L2, n = 1; L3, n = 2)

**Index 1App TxPDO-Map Energy (for L1, pp = 04; L2, pp = 10; L3, pp = 1C)**

Index (hex)	Name	Meaning	Data type	Flags	Default
1App:0	TxPDO-Map Energy	PDO Mapping TxPDO	UINT8	RO	0x03 (3 <sub>dec</sub> )
1App:01	SubIndex 001	1. PDO Mapping entry (object 0x60n4 (PMX Energy), entry 0x11 (Active Energy))	UINT32	RO	0x60n4:11, 64**
1App:02	SubIndex 002	2. PDO Mapping entry (object 0x60n4 (PMX Energy), entry 0x12 (Apparent Energy))	UINT32	RO	0x60n4:12, 64**
1App:03	SubIndex 003	3. PDO Mapping entry (object 0x60n4 (PMX Energy), entry 0x13 (Reactive Energy))	UINT32	RO	0x60n4:13, 64**

\*\*\*) for L1, n = 0; L2, n = 1; L3, n = 2)

**Index 1App TxPDO-Map Energy Fundamental (for L1, pp = 05; L2, pp = 11; L3, pp = 1D)**

Index (hex)	Name	Meaning	Data type	Flags	Default
1App:0	TxPDO-Map Energy Fundamental	PDO Mapping TxPDO	UINT8	RO	0x03 (3 <sub>dec</sub> )
1App:01	SubIndex 001	1. PDO Mapping entry (object 0x60n4 (PMX Energy), entry 0x11 (Active Energy))	UINT32	RO	0x60n4:11, 64**
1App:02	SubIndex 002	2. PDO Mapping entry (object 0x60n4 (PMX Energy), entry 0x12 (Apparent Energy))	UINT32	RO	0x60n4:12, 64**
1App:03	SubIndex 003	3. PDO Mapping entry (object 0x60n4 (PMX Energy), entry 0x13 (Reactive Energy))	UINT32	RO	0x60n4:13, 64**

\*\*\*) for L1, n = 0; L2, n = 1; L3, n = 2)

**Index 1App TxPDO-Map Timing (for L1, pp = 06; L2, pp = 12; L3, pp = 1E)**

Index (hex)	Name	Meaning	Data type	Flags	Default
1App:0	TxPDO-Map Statistic Timing	PDO Mapping TxPDO	UINT8	RO	0x02 (2 <sub>dec</sub> )
1App:01	SubIndex 001	1. PDO Mapping entry (object 0x60n6 (PMX Timing), entry 0x11 (Voltage Last Zero Crossing))	UINT32	RO	0x60n6:11, 64**
1App:02	SubIndex 002	1. PDO Mapping entry (object 0x60n6 (PMX Timing), entry 0x12 (Current Last Zero Crossing))	UINT32	RO	0x60n6:12, 64**

\*\*) for L1, n = 0; L2, n = 1; L3, n = 2)

**Index 1App TxPDO-Map Advanced (for L1, pp = 07; L2, pp = 13; L3, pp = 1F)**

Index (hex)	Name	Meaning	Data type	Flags	Default
1App:0	TxPDO-Map Advanced	PDO Mapping TxPDO	UINT8	RO	0x06 (6 <sub>dec</sub> )
1App:01	SubIndex 001	1. PDO Mapping entry (15 bits align)	UINT32	RO	0x00n0:00, 15**
1App:02	SubIndex 002	2. PDO Mapping entry (object 0x60n7 (PMX Advanced), entry 0x10 (TxPDO Toggle))	UINT32	RO	0x60n7:10, 1**
1App:03	SubIndex 003	3. PDO Mapping entry (object 0x60n7 (PMX Advanced), entry 0x11 (Voltage Total Harmonic Distortion))	UINT32	RO	0x60n7:11, 32**
1App:04	SubIndex 004	4. PDO Mapping entry (object 0x60n7 (PMX Advanced), entry 0x12 (Current Distortion Factor))	UINT32	RO	0x60n7:12, 32**
1App:05	SubIndex 005	5. PDO Mapping entry (object 0x60n7 (PMX Advanced), entry 0x13 (Current Total Harmonic Distortion))	UINT32	RO	0x60n7:13, 32**
1App:06	SubIndex 006	6. PDO Mapping entry (object 0x60n7 (PMX Advanced), entry 0x14 (Cos Phi))	UINT32	RO	0x60n7:14, 32**

\*\*) for L1, n = 0; L2, n = 1; L3, n = 2)

**Index 1App TxPDO-Map Statistic Voltage (for L1, pp = 08; L2, pp = 14; L3, pp = 20)**

Index (hex)	Name	Meaning	Data type	Flags	Default
1App:0	TxPDO-Map Statistic Voltage	PDO Mapping TxPDO	UINT8	RO	0x03 (3 <sub>dec</sub> )
1App:01	SubIndex 001	1. PDO Mapping entry (object 0x60n8 (PMX Statistic Voltage), entry 0x11 (Voltage Peak))	UINT32	RO	0x60n8:11, 32**
1App:02	SubIndex 002	2. PDO Mapping entry (object 0x60n8 (PMX Statistic Voltage), entry 0x12 (Voltage RMS Minimum))	UINT32	RO	0x60n8:12, 32**
1App:03	SubIndex 003	3. PDO Mapping entry (object 0x60n8 (PMX Statistic Voltage), entry 0x13 (Voltage RMS Maximum))	UINT32	RO	0x60n8:13, 32**

\*\*) for L1, n = 0; L2, n = 1; L3, n = 2)

**Index 1App TxPDO-Map Statistic Current (for L1, pp = 09; L2, pp = 15; L3, pp = 21)**

Index (hex)	Name	Meaning	Data type	Flags	Default
1App:0	L1 TxPDO-Map Statistic Current	PDO Mapping TxPDO 8	UINT8	RO	0x03 (3 <sub>dec</sub> )
1App:01	SubIndex 001	1. PDO Mapping entry (object 0x60n9 (PMX Statistic Current), entry 0x11 (Current Peak))	UINT32	RO	0x60n9:11, 32**
1App:02	SubIndex 002	2. PDO Mapping entry (object 0x60n9 (PMX Statistic Current), entry 0x12 (Current RMS Minimum))	UINT32	RO	0x60n9:12, 32**
1App:03	SubIndex 003	3. PDO Mapping entry (object 0x60n9 (PMX Statistic Current), entry 0x13 (Current RMS Maximum))	UINT32	RO	0x60n9:13, 32**

\*\*) for L1, n = 0; L2, n = 1; L3, n = 2)

**Index 1App TxPDO-Map Statistic Power (for L1, pp = 0A; L2, pp = 16; L3, pp = 22)**

Index (hex)	Name	Meaning	Data type	Flags	Default
1App:0	TxPDO-Map Statistic Power	PDO Mapping TxPDO	UINT8	RO	0x09 (9 <sub>dec</sub> )
1App:01	SubIndex 001	1. PDO Mapping entry (object 0x60nA (PMX Statistic Power), entry 0x11 (Active Power Avg))	UINT32	RO	0x60nA:11, 32**
1App:02	SubIndex 002	2. PDO Mapping entry (object 0x60nA (PMX Statistic Power), entry 0x12 (Active Power Min))	UINT32	RO	0x60nA:12, 32**
1App:03	SubIndex 003	3. PDO Mapping entry (object 0x60nA (PMX Statistic Power), entry 0x13 (Active Power Max))	UINT32	RO	0x60nA:13, 32**
1App:04	SubIndex 004	4. PDO Mapping entry (object 0x60nA (PMX Statistic Power), entry 0x14 (Apparent Power Avg))	UINT32	RO	0x60nA:14, 32**
1App:05	SubIndex 005	5. PDO Mapping entry (object 0x60nA (PMX Statistic Power), entry 0x15 (Apparent Power Max))	UINT32	RO	0x60nA:15, 32**
1App:06	SubIndex 006	6. PDO Mapping entry (object 0x60nA (PMX Statistic Power), entry 0x16 (Reactive Power Avg))	UINT32	RO	0x60nA:16, 32**
1App:07	SubIndex 007	7. PDO Mapping entry (object 0x60nA (PMX Statistic Power), entry 0x17 (Reactive Power Min))	UINT32	RO	0x60nA:17, 32**
1App:08	SubIndex 008	8. PDO Mapping entry (object 0x60nA (PMX Statistic Power), entry 0x18 (Reactive Power Max))	UINT32	RO	0x60nA:18, 32**
1App:09	SubIndex 009	9. PDO Mapping entry (object 0x60nA (PMX Statistic Power), entry 0x19 (Apparent Power Min))	UINT32	RO	0x60nA:19, 32**

\*\* ) for L1, n = 0; L2, n = 1; L3, n = 2)

**Index 1App TxPDO-Map Classic (for L1, pp = 0B; L2, pp = 17; L3, pp = 23)**

Index (hex)	Name	Meaning	Data type	Flags	Default
1App:0	TxPDO-Map Classic	PDO Mapping TxPDO	UINT8	RO	0x08 (8 <sub>dec</sub> )
1App:01	SubIndex 001	1. PDO Mapping entry (15 bits align)	UINT32	RO	0x00n0:00, 15**
1App:02	SubIndex 002	2. PDO Mapping entry (object 0x60nB (PMX Classic), entry 0x10 (TxPDO Toggle))	UINT32	RO	0x60nB:10, 1**
1App:03	SubIndex 003	3. PDO Mapping entry (object 0x60nB (PMX Classic), entry 0x11 (Voltage))	UINT32	RO	0x60nB:11, 32**
1App:04	SubIndex 004	4. PDO Mapping entry (object 0x60nB (PMX Classic), entry 0x12 (Current))	UINT32	RO	0x60nB:12, 32**
1App:05	SubIndex 005	5. PDO Mapping entry (object 0x60nB (PMX Classic), entry 0x13 (Frequency))	UINT32	RO	0x60nB:13, 32**
1App:06	SubIndex 006	6. PDO Mapping entry (object 0x60nB (PMX Classic), entry 0x14 (Active Power))	UINT32	RO	0x60nB:14, 32**
1App:07	SubIndex 007	7. PDO Mapping entry (object 0x60nB (PMX Classic), entry 0x15 (Apparent Power))	UINT32	RO	0x60nB:15, 32**
1App:08	SubIndex 008	8. PDO Mapping entry (object 0x60nB (PMX Classic), entry 0x16 (Reactive Power))	UINT32	RO	0x60nB:16, 32**

\*\* ) for L1, n = 0; L2, n = 1; L3, n = 2)



**Index 1A24 Total TxPDO-Map Status**

Index (hex)	Name	Meaning	Data type	Flags	Default
1A24:0	Total TxPDO-Map Status	PDO Mapping TxPDO 31	UINT8	RO	0x10 (16 <sub>dec</sub> )
1A24:01	SubIndex 001	1. PDO Mapping entry (object 0xF600 (PMX Total Status), entry 0x01 (System State))	UINT32	RO	0xF600:01, 1
1A24:02	SubIndex 002	2. PDO Mapping entry (object 0xF600 (PMX Total Status), entry 0x02 (Grid Direction))	UINT32	RO	0xF600:02, 1
1A24:03	SubIndex 003	3. PDO Mapping entry (object 0xF600 (PMX Total Status), entry 0x03 (Frequency Guard Warning))	UINT32	RO	0xF600:03, 1
1A24:04	SubIndex 004	4. PDO Mapping entry (object 0xF600 (PMX Total Status), entry 0x04 (Frequency Guard Error))	UINT32	RO	0xF600:04, 1
1A24:05	SubIndex 005	5. PDO Mapping entry (object 0xF600 (PMX Total Status), entry 0x05 (Neutral Current Guard Warning))	UINT32	RO	0xF600:05, 1
1A24:06	SubIndex 006	6. PDO Mapping entry (object 0xF600 (PMX Total Status), entry 0x06 (Neutral Current Guard Error))	UINT32	RO	0xF600:06, 1
1A24:07	SubIndex 007	7. PDO Mapping entry (object 0xF600 (PMX Total Status), entry 0x07 (Active Power Guard Warning))	UINT32	RO	0xF600:07, 1
1A24:08	SubIndex 008	8. PDO Mapping entry (object 0xF600 (PMX Total Status), entry 0x08 (Active Power Guard Error))	UINT32	RO	0xF600:08, 1
1A24:09	SubIndex 009	9. PDO Mapping entry (object 0xF600 (PMX Total Status), entry 0x09 (Apparent Power Guard Warning))	UINT32	RO	0xF600:09, 1
1A24:0A	SubIndex 010	10. PDO Mapping entry (object 0xF600 (PMX Total Status), entry 0x0A (Apparent Power Guard Error))	UINT32	RO	0xF600:0A, 1
1A24:0B	SubIndex 011	11. PDO Mapping entry (object 0xF600 (PMX Total Status), entry 0x0B (Power Quality Guard Warning))	UINT32	RO	0xF600:0B, 1
1A24:0C	SubIndex 012	12. PDO Mapping entry (object 0xF600 (PMX Total Status), entry 0x0C (Power Quality Guard Error))	UINT32	RO	0xF600:0C, 1
1A24:0D	SubIndex 013	13. PDO Mapping entry (2 bits align)	UINT32	RO	0x0000:00, 2
1A24:0E	SubIndex 014	14. PDO Mapping entry (object 0xF600 (PMX Total Status), entry 0x0F (TxPDO State))	UINT32	RO	0xF600:0F, 1
1A24:0F	SubIndex 015	15. PDO Mapping entry (object 0xF600 (PMX Total Status), entry 0x10 (TxPDO Toggle))	UINT32	RO	0xF600:10, 1
1A24:10	SubIndex 016	16. PDO Mapping entry (object 0xF600 (PMX Total Status), entry 0x11 (Power Quality Factor))	UINT32	RO	0xF600:11, 32

**Index 1A26 Total TxPDO-Map Advanced**

Index (hex)	Name	Meaning	Data type	Flags	Default
1A26:0	Total TxPDO-Map Advanced	PDO Mapping TxPDO 33	UINT8	RO	0x08 (8 <sub>dec</sub> )
1A26:01	SubIndex 001	1. PDO Mapping entry (object 0xF602 (PMX Grid Advanced), entry 0x11 (Max Voltage Harmonic Distortion))	UINT32	RO	0xF602:01, 1
1A26:02	SubIndex 002	2. PDO Mapping entry (object 0xF602 (PMX Grid Advanced), entry 0x12 (Max Current Harmonic Distortion))	UINT32	RO	0xF602:02, 1
1A26:03	SubIndex 003	3. PDO Mapping entry (object 0xF602 (PMX Grid Advanced), entry 0x13 (Max Current Distortion Factor))	UINT32	RO	0x0000:00, 13
1A26:04	SubIndex 004	4. PDO Mapping entry (object 0xF602 (PMX Grid Advanced), entry 0x14 (Voltage Unbalance))	UINT32	RO	0xF602:10, 1
1A26:05	SubIndex 005	5. PDO Mapping entry (object 0xF602 (PMX Total Advanced), entry 0x11 (Max Voltage Harmonic Distortion))	UINT32	RO	0xF602:11, 32
1A26:06	SubIndex 006	6. PDO Mapping entry (object 0xF602 (PMX Total Advanced), entry 0x12 (Max Current Harmonic Distortion))	UINT32	RO	0xF602:12, 32
1A26:07	SubIndex 007	7. PDO Mapping entry (object 0xF602 (PMX Total Advanced), entry 0x13 (Max Current Distortion Factor))	UINT32	RO	0xF602:13, 32
1A26:08	SubIndex 008	8. PDO Mapping entry (object 0xF602 (PMX Total Advanced), entry 0x14 (Voltage Unbalance))	UINT32	RO	0xF602:14, 32

**Index 1A27 Total TxPDO-Map Active**

Index (hex)	Name	Meaning	Data type	Flags	Default
1A27:0	Total TxPDO-Map Active	PDO Mapping TxPDO 34	UINT8	RO	0x04 (4 <sub>dec</sub> )
1A27:01	SubIndex 001	1. PDO Mapping entry (32 bits align)	UINT32	RO	0x0000:00, 32
1A27:02	SubIndex 002	2. PDO Mapping entry (object 0xF603 (PMX Total Active), entry 0x12 (Active Energy))	UINT32	RO	0xF603:12, 64
1A27:03	SubIndex 003	3. PDO Mapping entry (object 0xF603 (PMX Total Active), entry 0x13 (Active Positive Energy))	UINT32	RO	0xF603:13, 64
1A27:04	SubIndex 004	4. PDO Mapping entry (object 0xF603 (PMX Total Active), entry 0x14 (Active Negative Energy))	UINT32	RO	0xF603:14, 64

**Index 1A28 Total TxPDO-Map Active Fundamental**

Index (hex)	Name	Meaning	Data type	Flags	Default
1A28:0	Total TxPDO-Map Active Fundamental	PDO Mapping TxPDO 34	UINT8	RO	0x04 (4 <sub>dec</sub> )
1A28:01	SubIndex 001	1. PDO Mapping entry (object 0xF604 (PMX Total Active Fundamental), entry 0x11 (Active Power Fund))	UINT32	RO	0xF604:11, 32
1A28:02	SubIndex 002	2. PDO Mapping entry (object 0xF604 (PMX Total Active Fundamental), entry 0x12 (Active Energy Fund))	UINT32	RO	0xF604:12, 64
1A28:03	SubIndex 003	3. PDO Mapping entry (object 0xF604 (PMX Total Active Fundamental), entry 0x13 (Active Positive Energy Fund))	UINT32	RO	0xF604:13, 64
1A28:04	SubIndex 004	4. PDO Mapping entry (object 0xF604 (PMX Total Active Fundamental), entry 0x14 (Active Negative Energy Fund))	UINT32	RO	0xF604:14, 64

**Index 1A29 Total TxPDO-Map Apparent**

Index (hex)	Name	Meaning	Data type	Flags	Default
1A29:0	Total TxPDO-Map Apparent	PDO Mapping TxPDO 35	UINT8	RO	0x04 (4 <sub>dec</sub> )
1A29:01	SubIndex 001	1. PDO Mapping entry (32 bits align)	UINT32	RO	0x0000:00, 32
1A29:02	SubIndex 002	2. PDO Mapping entry (object 0xF605 (PMX Total Apparent), entry 0x12 (Apparent Energy))	UINT32	RO	0xF605:12, 64
1A29:03	SubIndex 003	3. PDO Mapping entry (object 0xF605 (PMX Total Apparent), entry 0x13 (Apparent Positive Energy))	UINT32	RO	0xF605:13, 64
1A29:04	SubIndex 004	4. PDO Mapping entry (object 0xF605 (PMX Total Apparent), entry 0x14 (Apparent Negative Energy))	UINT32	RO	0xF605:14, 64

**Index 1A2A Total TxPDO-Map Apparent Fundamental**

Index (hex)	Name	Meaning	Data type	Flags	Default
1A2A:0	Total TxPDO-Map Apparent Fundamental	PDO Mapping TxPDO 35	UINT8	RO	0x04 (4 <sub>dec</sub> )
1A2A:01	SubIndex 001	1. PDO Mapping entry (object 0xF606 (PMX Total Apparent Fundamental), entry 0x11 (Apparent Power Fund))	UINT32	RO	0xF606:11, 32
1A2A:02	SubIndex 002	2. PDO Mapping entry (object 0xF606 (PMX Total Apparent Fundamental), entry 0x12 (Apparent Energy Fund))	UINT32	RO	0xF606:12, 64
1A2A:03	SubIndex 003	3. PDO Mapping entry (object 0xF606 (PMX Total Apparent Fundamental), entry 0x13 (Apparent Positive Energy Fund))	UINT32	RO	0xF606:13, 64
1A2A:04	SubIndex 004	4. PDO Mapping entry (object 0xF606 (PMX Total Apparent Fundamental), entry 0x14 (Apparent Negative Energy Fund))	UINT32	RO	0xF606:14, 64

**Index 1A2B Total TxPDO-Map Reactive**

Index (hex)	Name	Meaning	Data type	Flags	Default
1A2B:0	Total TxPDO-Map Reactive	PDO Mapping TxPDO 36	UINT8	RO	0x04 (4 <sub>dec</sub> )
1A2B:01	SubIndex 001	1. PDO Mapping entry (object 0xF607 (PMX Total Reactive), entry 0x11 (Reactive Power))	UINT32	RO	0xF607:11, 32
1A2B:02	SubIndex 002	2. PDO Mapping entry (object 0xF607 (PMX Total Reactive), entry 0x12 (Reactive Energy))	UINT32	RO	0xF607:12, 64
1A2B:03	SubIndex 003	3. PDO Mapping entry (object 0xF607 (PMX Total Reactive), entry 0x13 (Reactive Positive Energy))	UINT32	RO	0xF607:13, 64
1A2B:04	SubIndex 004	4. PDO Mapping entry (object 0xF607 (PMX Total Reactive), entry 0x14 (Reactive Negative Energy))	UINT32	RO	0xF607:14, 64

**Index 1A2C Total TxPDO-Map Reactive**

Index (hex)	Name	Meaning	Data type	Flags	Default
1A2C:0	Total TxPDO-Map Reactive Fundamental	PDO Mapping TxPDO 36	UINT8	RO	0x04 (4 <sub>dec</sub> )
1A2C:01	SubIndex 001	1. PDO Mapping entry (object 0xF608 (PMX Total Reactive Fundamental), entry 0x11 (Reactive Power Fund))	UINT32	RO	0xF608:11, 32
1A2C:02	SubIndex 002	2. PDO Mapping entry (object 0xF608 (PMX Total Reactive Fundamental), entry 0x12 (Reactive Energy Fund))	UINT32	RO	0xF608:12, 64
1A2C:03	SubIndex 003	3. PDO Mapping entry (object 0xF608 (PMX Total Reactive Fundamental), entry 0x13 (Reactive Positive Energy Fund))	UINT32	RO	0xF608:13, 64
1A2C:04	SubIndex 004	4. PDO Mapping entry (object 0xF608 (PMX Total Reactive Fundamental), entry 0x14 (Reactive Negative Energy Fund))	UINT32	RO	0xF608:14, 64

**Index 1A2D Total TxPDO-Map L-L Voltage**

Index (hex)	Name	Meaning	Data type	Flags	Default
1A2D:0	Total TxPDO-Map L-L Voltage	PDO Mapping TxPDO 37	UINT8	RO	0x03 (3 <sub>dec</sub> )
1A2D:01	SubIndex 001	1. PDO Mapping entry (object 0xF609 (PMX Total L-L Voltages), entry 0x11 (L1-L2 Voltage))	UINT32	RO	0xF609:11, 32
1A2D:02	SubIndex 002	2. PDO Mapping entry (object 0xF609 (PMX Total L-L Voltages), entry 0x12 (L2-L3 Voltage))	UINT32	RO	0xF609:12, 32
1A2D:03	SubIndex 003	3. PDO Mapping entry (object 0xF609 (PMX Total L-L Voltages), entry 0x13 (L3-L1 Voltage))	UINT32	RO	0xF609:13, 32

## Index 1A2E Total TxPDO-Map Variant Value In

Index (hex)	Name	Meaning	Data type	Flags	Default
1A2E:0	Total TxPDO-Map Variant Value In	PDO Mapping TxPDO 38	UINT8	RO	0x0A (10 <sub>dec</sub> )
1A2E:01	SubIndex 001	1. PDO Mapping entry (15 bits align)	UINT32	RO	0x0000:00, 15
1A2E:02	SubIndex 002	2. PDO Mapping entry (object 0xF60A (PMX Variant Value In), entry 0x10 (TxPDO Toggle))	UINT32	RO	0xF60A:10, 1
1A2E:03	SubIndex 003	3. PDO Mapping entry (object 0xF60A (PMX Variant Value In), entry 0x11 (Index 1 REAL))	UINT32	RO	0xF60A:11, 16
1A2E:04	SubIndex 004	4. PDO Mapping entry (object 0xF60A (PMX Variant Value In), entry 0x12 (Value 1 REAL))	UINT32	RO	0xF60A:12, 32
1A2E:05	SubIndex 005	5. PDO Mapping entry (object 0xF60A (PMX Variant Value In), entry 0x13 (Index 2 REAL))	UINT32	RO	0xF60A:13, 16
1A2E:06	SubIndex 006	6. PDO Mapping entry (object 0xF60A (PMX Variant Value In), entry 0x14 (Value 2 REAL))	UINT32	RO	0xF60A:14, 32
1A2E:07	SubIndex 007	7. PDO Mapping entry (object 0xF60A (PMX Variant Value In), entry 0x13 (Index 3 REAL))	UINT32	RO	0xF60A:15, 16
1A2E:08	SubIndex 008	8. PDO Mapping entry (object 0xF60A (PMX Variant Value In), entry 0x16 (Value 3 REAL))	UINT32	RO	0xF60A:16, 32
1A2E:09	SubIndex 009	9. PDO Mapping entry (object 0xF60A (PMX Variant Value In), entry 0x17 (Index 4 ULINT))	UINT32	RO	0xF60A:17, 16
1A2E:0A	SubIndex 010	10. PDO Mapping entry (object 0xF60A (PMX Variant Value In), entry 0x18 (Value 4 ULINT))	UINT32	RO	0xF60A:18, 64

## Index 1A2F Total TxPDO-Map Statistic Power

Index (hex)	Name	Meaning	Data type	Flags	Default
1A2F:0	Total TxPDO-Map Statistic Power	PDO Mapping TxPDO 39	UINT8	RO	0x09 (9 <sub>dec</sub> )
1A2F:01	SubIndex 001	1. PDO Mapping entry (object 0xF60B (PMX Total Statistic Power), entry 0x11 (Active Power Avg))	UINT32	RO	0xF60B:11, 32
1A2F:02	SubIndex 002	2. PDO Mapping entry (object 0xF60B (PMX Total Statistic Power), entry 0x12 (Active Power Min))	UINT32	RO	0xF60B:12, 32
1A2F:03	SubIndex 003	3. PDO Mapping entry (object 0xF60B (PMX Total Statistic Power), entry 0x13 (Active Power Max))	UINT32	RO	0xF60B:13, 32
1A2F:04	SubIndex 004	4. PDO Mapping entry (object 0xF60B (PMX Total Statistic Power), entry 0x14 (Apparent Power Avg))	UINT32	RO	0xF60B:14, 32
1A2F:05	SubIndex 005	5. PDO Mapping entry (object 0xF60B (PMX Total Statistic Power), entry 0x15 (Apparent Power Min))	UINT32	RO	0xF60B:15, 32
1A2F:06	SubIndex 006	6. PDO Mapping entry (object 0xF60B (PMX Total Statistic Power), entry 0x16 (Apparent Power Max))	UINT32	RO	0xF60B:16, 32
1A2F:07	SubIndex 007	7. PDO Mapping entry (object 0xF60B (PMX Total Statistic Power), entry 0x17 (Reactive Power Avg))	UINT32	RO	0xF60B:17, 32
1A2F:08	SubIndex 008	8. PDO Mapping entry (object 0xF60B (PMX Total Statistic Power), entry 0x18 (Reactive Power Min))	UINT32	RO	0xF60B:18, 32
1A2F:09	SubIndex 009	9. PDO Mapping entry (object 0xF60B (PMX Total Statistic Power), entry 0x19 (Reactive Power Max))	UINT32	RO	0xF60B:19, 32

## Index 1A30 Total TxPDO-Map Statistic PQF

Index (hex)	Name	Meaning	Data type	Flags	Default
1A30:0	Total TxPDO-Map Statistic PQF	PDO Mapping TxPDO 40	UINT8	RO	0x03 (3 <sub>dec</sub> )
1A30:01	SubIndex 001	1. PDO Mapping entry (object 0xF60C (PMX Total Statistic PQF), entry 0x11 (PQF Avg))	UINT32	RO	0xF60C:11, 32
1A30:02	SubIndex 002	2. PDO Mapping entry (object 0xF60C (PMX Total Statistic PQF), entry 0x12 (PQF Min))	UINT32	RO	0xF60C:12, 32
1A30:03	SubIndex 003	3. PDO Mapping entry (object 0xF60C (PMX Total Statistic PQF), entry 0x13 (PQF Max))	UINT32	RO	0xF60C:13, 32

**Index 1A31 Total TxPDO-Map Interval Energy**

Index (hex)	Name	Meaning	Data type	Flags	Default
1A31:0	Total TxPDO-Map Interval Energy	PDO Mapping TxPDO 41	UINT8	RO	0x0B (11 <sub>dec</sub> )
1A31:01	SubIndex 001	1. PDO Mapping entry (15 bits align)	UINT32	RO	0x0000:00, 15
1A31:02	SubIndex 002	2. PDO Mapping entry (object 0xF60D (PMX Total Interval Energy), entry 0x10 (TxPDO Toggle))	UINT32	RO	0xF60D:10, 1
1A31:03	SubIndex 003	3. PDO Mapping entry (object 0xF60D (PMX Total Interval Energy), entry 0x11 (Active Energy))	UINT32	RO	0xF60D:11, 32
1A31:04	SubIndex 004	4. PDO Mapping entry (object 0xF60D (PMX Total Interval Energy), entry 0x12 (Active Energy Positive))	UINT32	RO	0xF60D:12, 32
1A31:05	SubIndex 005	5. PDO Mapping entry (object 0xF60D (PMX Total Interval Energy), entry 0x13 (Active Energy Negative))	UINT32	RO	0xF60D:13, 32
1A31:06	SubIndex 006	6. PDO Mapping entry (object 0xF60D (PMX Total Interval Energy), entry 0x14 (Apparent Energy))	UINT32	RO	0xF60D:14, 32
1A31:07	SubIndex 007	7. PDO Mapping entry (object 0xF60D (PMX Total Interval Energy), entry 0x15 (Apparent Energy Positive))	UINT32	RO	0xF60D:15, 32
1A31:08	SubIndex 008	8. PDO Mapping entry (object 0xF60D (PMX Total Interval Energy), entry 0x16 (Apparent Energy Negative))	UINT32	RO	0xF60D:16, 32
1A31:09	SubIndex 009	9. PDO Mapping entry (object 0xF60D (PMX Total Interval Energy), entry 0x17 (Reactive Energy))	UINT32	RO	0xF60D:17, 32
1A31:0A	SubIndex 010	10. PDO Mapping entry (object 0xF60D (PMX Total Interval Energy), entry 0x18 (Reactive Energy Positive))	UINT32	RO	0xF60D:18, 32
1A31:0B	SubIndex 011	11. PDO Mapping entry (object 0xF60D (PMX Total Interval Energy), entry 0x19 (Reactive Energy Negative))	UINT32	RO	0xF60D:19, 32

**Index 1A32 Total TxPDO-Map Interval Energy Fundamental**

Index (hex)	Name	Meaning	Data type	Flags	Default
1A32:0	Total TxPDO-Map Interval Energy Fundamental	PDO Mapping TxPDO 41	UINT8	RO	0x0B (11 <sub>dec</sub> )
1A32:01	SubIndex 001	1. PDO Mapping entry (15 bits align)	UINT32	RO	0x0000:00, 15
1A32:02	SubIndex 002	2. PDO Mapping entry (object 0xF60E (PMX Total Interval Energy Fundamental), entry 0x10 (TxPDO Toggle Fund))	UINT32	RO	0xF60E:10, 1
1A32:03	SubIndex 003	3. PDO Mapping entry (object 0xF60E (PMX Total Interval Energy Fundamental), entry 0x11 (Active Energy Fund))	UINT32	RO	0xF60E:11, 32
1A32:04	SubIndex 004	4. PDO Mapping entry (object 0xF60E (PMX Total Interval Energy Fundamental), entry 0x12 (Active Energy Positive Fund))	UINT32	RO	0xF60E:12, 32
1A32:05	SubIndex 005	5. PDO Mapping entry (object 0xF60E (PMX Total Interval Energy Fundamental), entry 0x13 (Active Energy Negative Fund))	UINT32	RO	0xF60E:13, 32
1A32:06	SubIndex 006	6. PDO Mapping entry (object 0xF60E (PMX Total Interval Energy Fundamental), entry 0x14 (Apparent Energy Fund))	UINT32	RO	0xF60E:14, 32
1A32:07	SubIndex 007	7. PDO Mapping entry (object 0xF60E (PMX Total Interval Energy Fundamental), entry 0x15 (Apparent Energy Positive Fund))	UINT32	RO	0xF60E:15, 32
1A32:08	SubIndex 008	8. PDO Mapping entry (object 0xF60E (PMX Total Interval Energy Fundamental), entry 0x16 (Apparent Energy Negative Fund))	UINT32	RO	0xF60E:16, 32
1A32:09	SubIndex 009	9. PDO Mapping entry (object 0xF60E (PMX Total Interval Energy Fundamental), entry 0x17 (Reactive Energy Fund))	UINT32	RO	0xF60E:17, 32
1A32:0A	SubIndex 010	10. PDO Mapping entry (object 0xF60E (PMX Total Interval Energy Fundamental), entry 0x18 (Reactive Energy Positive Fund))	UINT32	RO	0xF60E:18, 32
1A32:0B	SubIndex 011	11. PDO Mapping entry (object 0xF60E (PMX Total Interval Energy Fundamental), entry 0x19 (Reactive Energy Negative Fund))	UINT32	RO	0xF60E:19, 32

**Index 1A33 Total TxPDO-Map System Angles**

Index (hex)	Name	Meaning	Data type	Flags	Default
1A33:0	Total TxPDO-Map System Angles	PDO Mapping TxPDO 41	UINT8	RO	0x05 (5 <sub>dec</sub> )
1A33:01	SubIndex 001	1. PDO Mapping entry (object 0xF60F (PMX Total System Angles), entry 0x11 (Voltage Angle L1L2))	UINT32	RO	0xF60F:11, 32
1A33:02	SubIndex 002	2. PDO Mapping entry (object 0xF60F (PMX Total System Angles), entry 0x12 (Voltage Angle L1L3))	UINT32	RO	0xF60F:12, 32
1A33:03	SubIndex 003	3. PDO Mapping entry (object 0xF60F (PMX Total System Angles), entry 0x13 (Current Angle L1))	UINT32	RO	0xF60F:13, 32
1A33:04	SubIndex 004	4. PDO Mapping entry (object 0xF60F (PMX Total System Angles), entry 0x14 (Current Angle L2))	UINT32	RO	0xF60F:14, 32
1A33:05	SubIndex 005	5. PDO Mapping entry (object 0xF60F (PMX Total System Angles), entry 0x15 (Current Angle L3))	UINT32	RO	0xF60F:15, 32

**Index 1A34 Total TxPDO-Map System**

Index (hex)	Name	Meaning	Data type	Flags	Default
1A34:0	Total TxPDO-Map System	PDO Mapping TxPDO 41	UINT8	RO	0x03 (3 <sub>dec</sub> )
1A34:01	SubIndex 001	1. PDO Mapping entry (object 0xF610 (PMX Total System ), entry 0x11 (Positive Sequence))	UINT32	RO	0xF610:11, 32
1A34:02	SubIndex 002	2. PDO Mapping entry (object 0xF610 (PMX Total System ), entry 0x12 (Negative Sequence))	UINT32	RO	0xF610:12, 32
1A34:03	SubIndex 003	3. PDO Mapping entry (object 0xF610 (PMX Total System ), entry 0x13 (Zero Sequence))	UINT32	RO	0xF610:13, 32

**Index 1A35 Total TxPDO-Map Statistic Power Fundamental**

Index (hex)	Name	Meaning	Data type	Flags	Default
1A35:0	Total TxPDO-Map Statistic Power Fundamental	PDO Mapping TxPDO 39	UINT8	RO	0x09 (9 <sub>dec</sub> )
1A35:01	SubIndex 001	1. PDO Mapping entry (object 0xF611 (PMX Total Statistic Power Fundamental), entry 0x10 (Active Power Avg Fund))	UINT32	RO	0xF611:10, 32
1A35:02	SubIndex 002	2. PDO Mapping entry (object 0xF611 (PMX Total Statistic Power Fundamental), entry 0x11 (Active Power Min Fund))	UINT32	RO	0xF611:11, 32
1A35:03	SubIndex 003	3. PDO Mapping entry (object 0xF611 (PMX Total Statistic Power Fundamental), entry 0x12 (Active Power Max Fund))	UINT32	RO	0xF611:12, 32
1A35:04	SubIndex 004	4. PDO Mapping entry (object 0xF611 (PMX Total Statistic Power Fundamental), entry 0x13 (Apparent Power Avg Fund))	UINT32	RO	0xF611:13, 32
1A35:05	SubIndex 005	5. PDO Mapping entry (object 0xF611 (PMX Total Statistic Power Fundamental), entry 0x14 (Apparent Power Min Fund))	UINT32	RO	0xF611:14, 32
1A35:06	SubIndex 006	6. PDO Mapping entry (object 0xF611 (PMX Total Statistic Power Fundamental), entry 0x15 (Apparent Power Max Fund))	UINT32	RO	0xF611:15, 32
1A35:07	SubIndex 007	7. PDO Mapping entry (object 0xF611 (PMX Total Statistic Power Fundamental), entry 0x16 (Reactive Power Avg Fund))	UINT32	RO	0xF611:16, 32
1A35:08	SubIndex 008	8. PDO Mapping entry (object 0xF611 (PMX Total Statistic Power Fundamental), entry 0x17 (Reactive Power Min))	UINT32	RO	0xF611:17, 32
1A35:09	SubIndex 009	9. PDO Mapping entry (object 0xF611 (PMX Total Statistic Power Fundamental), entry 0x18 (Reactive Power Max))	UINT32	RO	0xF611:18, 32

**Index 1C00 Sync manager type**

Index (hex)	Name	Meaning	Data type	Flags	Default
1C00:0	Sync manager type	Length of this object	UINT8	RO	0x04 (4 <sub>dec</sub> )
1C00:01	SubIndex 001	Sync-Manager Type Channel 1: Mailbox Write	UINT8	RW	0x01 (1 <sub>dec</sub> )
1C00:02	SubIndex 002	Sync-Manager Type Channel 2: Mailbox Read	UINT8	RW	0x02 (2 <sub>dec</sub> )
1C00:03	SubIndex 003	Sync-Manager Type Channel 3: Process Data Write (Outputs)	UINT8	RW	0x03 (3 <sub>dec</sub> )
1C00:04	SubIndex 004	Sync-Manager Type Channel 4: Process Data Read (Inputs)	UINT8	RW	0x04 (4 <sub>dec</sub> )

**Index 1C12 RxPDO assign**

Index (hex)	Name	Meaning	Data type	Flags	Default
1C12:0	RxPDO assign	PDO Assign Outputs	UINT8	RW	0x01 (1 <sub>dec</sub> )
1C12:01	SubIndex 001	1. allocated RxPDO (contains the index of the associated RxPDO mapping object)	UINT16	RW	0x1600 (5632 <sub>dec</sub> )

**Index 1C13 TxPDO assign**

Index (hex)	Name	Meaning	Data type	Flags	Default
1C13:0	TxPDO assign	PDO Assign Inputs	UINT8	RW	0x0B (11 <sub>dec</sub> )
1C13:01	Subindex 001	1. allocated TxPDO (contains the index of the associated TxPDO mapping object)	UINT16	RW	0x1A00 (6656 <sub>dec</sub> )
1C13:02	Subindex 002	2. allocated TxPDO (contains the index of the associated TxPDO mapping object)	UINT16	RW	0x1A01 (6657 <sub>dec</sub> )
1C13:03	Subindex 003	3. allocated TxPDO (contains the index of the associated TxPDO mapping object)	UINT16	RW	0x1A02 (6658 <sub>dec</sub> )
1C13:04	Subindex 004	4. allocated TxPDO (contains the index of the associated TxPDO mapping object)	UINT16	RW	0x1A0C (6668 <sub>dec</sub> )
1C13:05	Subindex 005	5. allocated TxPDO (contains the index of the associated TxPDO mapping object)	UINT16	RW	0x1A0D (6669 <sub>dec</sub> )
1C13:06	Subindex 006	6. allocated TxPDO (contains the index of the associated TxPDO mapping object)	UINT16	RW	0x1A0E (6670 <sub>dec</sub> )
1C13:07	Subindex 007	7. allocated TxPDO (contains the index of the associated TxPDO mapping object)	UINT16	RW	0x1A18 (6680 <sub>dec</sub> )
1C13:08	Subindex 008	8. allocated TxPDO (contains the index of the associated TxPDO mapping object)	UINT16	RW	0x1A19 (6681 <sub>dec</sub> )
1C13:09	Subindex 009	9. allocated TxPDO (contains the index of the associated TxPDO mapping object)	UINT16	RW	0x1A1A (6682 <sub>dec</sub> )
1C13:0A	Subindex 010	10. allocated TxPDO (contains the index of the associated TxPDO mapping object)	UINT16	RW	0x1A24 (6692 <sub>dec</sub> )
1C13:0B	Subindex 011	11. allocated TxPDO (contains the index of the associated TxPDO mapping object)	UINT16	RW	0x1A3A (6714 <sub>dec</sub> )
...					
1C13:36	Subindex 054	54. allocated TxPDO (contains the index of the associated TxPDO mapping object)	UINT16	RW	0x0000 (0 <sub>dec</sub> )

## Index 1C32 SM output parameter

Index	Name	Meaning	Data type	Flags	Default
1C32:0	SM output parameter	Synchronization parameters for the outputs	UINT8	RO	0x20 (32 <sub>dec</sub> )
1C32:01	Sync mode	Current synchronization mode: 0: Free Run 1: Synchron with SM 2 Event 2: DC-Mode - Synchron with SYNC0 Event 3: DC-Mode - Synchron with SYNC1 Event	UINT16	RW	0x0000 (0 <sub>dec</sub> )
1C32:02	Cycle time	Cycle time (in ns): Free Run: Cycle time of the local timer Synchron with SM 2 Event: Master cycle time DC mode: SYNC0/SYNC1 Cycle Time	UINT32	RW	0x0016E360 (1500000 <sub>dec</sub> )
1C32:03	Shift time	Time between SYNC0 event and output of the outputs (in ns, DC mode only)	UINT32	RO	0x00000384 (900 <sub>dec</sub> )
1C32:04	Sync modes supported	Supported synchronization modes: Bit 0 = 1: free run is supported Bit 1 = 1: synchronous with SM 2 event is supported Bit 2-3 = 01: DC mode is supported Bit 4-5 = 10: Output shift with SYNC1 event (only DC mode) Bit 14 = 1: dynamic times (measurement through writing of 1C32:08)	UINT16	RO	0x0805 (2053 <sub>dec</sub> )
1C32:05	Minimum cycle time	Minimum cycle time (in ns)	UINT32	RO	0x0007A120 (500000 <sub>dec</sub> )
1C32:06	Calc and copy time	Minimum time between SYNC0 and SYNC1 event (in ns, DC mode only)	UINT32	RO	0x00000384 (900 <sub>dec</sub> )
1C32:07	Minimum delay time		UINT32	RO	0x00000384 (900 <sub>dec</sub> )
1C32:08	Command	0: Measurement of the local cycle time is stopped 1: Measurement of the local cycle time is started The entries 1C32:03, 1C32:05, 1C32:06, 1C32:09, 1C33:03, 1C33:06, 1C33:09 are updated with the maximum measured values. For a subsequent measurement the measured values are reset	UINT16	RW	0x0000 (0 <sub>dec</sub> )
1C32:09	Maximum delay time	Time between SYNC1 event and output of the outputs (in ns, DC mode only)	UINT32	RO	0x00000384 (900 <sub>dec</sub> )
1C32:0B	SM event missed counter	Number of missed SM events in OPERATIONAL (DC mode only)	UINT16	RO	0x0000 (0 <sub>dec</sub> )
1C32:0C	Cycle exceeded counter	Number of occasions the cycle time was exceeded in OPERATIONAL (cycle was not completed in time or the next cycle began too early)	UINT16	RO	0x0000 (0 <sub>dec</sub> )
1C32:0D	Shift too short counter	Number of occasions that the interval between SYNC0 and SYNC1 event was too short (DC mode only)	UINT16	RO	0x0000 (0 <sub>dec</sub> )



**Index 1C33 SM input parameter**

Index (hex)	Name	Meaning	Data type	Flags	Default
1C33:0	SM input parameter	Synchronization parameters for the inputs	UINT8	RO	0x20 (32 <sub>dec</sub> )
1C33:01	Sync mode	Current synchronization mode: 0: Free Run 1: Synchron with SM 3 Event (no outputs available) 2: DC - Synchron with SYNC0 Event 3: DC - Synchron with SYNC1 Event 34: Synchron with SM 2 event (outputs available)	UINT16	RW	0x0000 (0 <sub>dec</sub> )
1C33:02	Cycle time	as 1C32:02	UINT32	RW	0x0016E360 (1500000 <sub>dec</sub> )
1C33:03	Shift time	Time between SYNC0 event and reading of the inputs (in ns, only DC mode)	UINT32	RO	0x00000384 (900 <sub>dec</sub> )
1C33:04	Sync modes supported	Supported synchronization modes: Bit 0: free run is supported Bit 1: Synchron with SM 2 Event is supported (outputs available) Bit 1: Synchron with SM 3 Event is supported (no outputs available) Bit 2-3 = 01: DC mode is supported Bit 4-5 = 01: Input shift through local event (outputs available) Bit 4-5 = 10: Input shift with SYNC1 event (no outputs available) Bit 14 = 1: dynamic times (measurement through writing of 1C32:08 or 1C33:08)	UINT16	RO	0x0805 (2053 <sub>dec</sub> )
1C33:05	Minimum cycle time	as 1C32:05	UINT32	RO	0x0007A120 (500000 <sub>dec</sub> )
1C33:06	Calc and copy time	Time between reading of the inputs and availability of the inputs for the master (in ns, only DC mode)	UINT32	RO	0x0007A120 (500000 <sub>dec</sub> )
1C33:07	Minimum delay time		UINT32	RO	0x00000384 (900 <sub>dec</sub> )
1C33:08	Command	as 1C32:08	UINT16	RW	0x0000 (0 <sub>dec</sub> )
1C33:09	Maximum delay time	Time between SYNC1 event and reading of the inputs (in ns, only DC mode)	UINT32	RO	0x00000384 (900 <sub>dec</sub> )
1C33:0B	SM event missed counter	as 1C32:11	UINT16	RO	0x0000 (0 <sub>dec</sub> )
1C33:0C	Cycle exceeded counter	as 1C32:12	UINT16	RO	0x0000 (0 <sub>dec</sub> )
1C33:0D	Shift too short counter	as 1C32:13	UINT16	RO	0x0000 (0 <sub>dec</sub> )

## 6.6.4.8 Command object

### Index FB00 PMX Command

The command object is used for triggering an action in the terminal. The command is started by writing subindex 1 (request). Write access is disabled until the current command is completed.

Index (hex)	Name	Meaning	Data type	Flags	Default	
FB00:0	PM Command	Largest subindex of this object	UINT8	RO	0x03 (3 <sub>dec</sub> )	
FB00:01	Request	<b>Byte 0 - service request data</b>	OCTET-STRING [2]	RW	0x0000 (0 <sub>dec</sub> )	
		4 <sub>hex</sub>				Clear energy or reset all energy counters
		<b>Byte 1 - channel selection</b>				
		00 <sub>hex</sub>				all channels
		01 <sub>hex</sub>				Channel 1
		02 <sub>hex</sub>				Channel 2
03 <sub>hex</sub>	Channel 3					
FB00:02	Status	<b>Byte 0</b> reserved	UINT8	RW	0x00 (0 <sub>dec</sub> )	
FB00:03	Response	<b>Byte 0</b> reserved	OCTET-STRING [2]	RW	0x00000000 (0 <sub>dec</sub> )	
		<b>Byte 1</b> reserved				
		<b>Byte 2-n</b> reserved				

## 6.6.5 EL3483-00xx

### 6.6.5.1 Restore object

#### Index 1011 Restore default parameters

Index (hex)	Name	Meaning	Data type	Flags	Default
1011:0	Restore default parameters <a href="#">▶ 316</a>	Restore default parameters	UINT8	RO	0x01 (1 <sub>dec</sub> )
1011:01	SubIndex 001	If this object is set to “ <b>0x64616F6C</b> ” in the set value dialog, all backup objects are reset to their delivery state.	UINT32	RW	0x00000000 (0 <sub>dec</sub> )

### 6.6.5.2 Configuration data

#### Index 80n0 PMX settings (for ch.1, n = 0; ch.2, n = 1; ch.3, n = 2)

Index (hex)	Name	Meaning	Data type	Flags	Default
80n0:0	PMX Settings	Max. subindex	UINT8	RO	0x13 (19 <sub>dec</sub> )
80n0:11	Voltage Transformer Ratio	If a voltage transformer is used, its transmission ratio can be entered here.	REAL32	RW	0x3F800000 (1065353216 <sub>dec</sub> )

#### Index 80n1 PMX Guard Settings (for ch.1, n = 0; ch.2, n = 1; ch.3, n = 2)

Index (hex)	Name	Meaning	Data type	Flags	Default
80n1:0	PMX Guard Settings	Max. subindex	UINT8	RO	0x14 (20 <sub>dec</sub> )
80n1:11	Voltage Guard Min Error	Lower limit value for a voltage error message [V]	REAL32	RW	0x40000000 (1073741824 <sub>dec</sub> )
80n1:12	Voltage Guard Min Warning	Lower limit value for a voltage warning message [V]	REAL32	RW	0x434F0000 (1129250816 <sub>dec</sub> )
80n1:13	Voltage Guard Max Warning	Upper limit value for a voltage warning message [V]	REAL32	RW	0x437D0000 (1132265472 <sub>dec</sub> )
80n1:14	Voltage Guard Max Error	Upper limit value for a voltage error message [V]	REAL32	RW	0x438B0000 (1133182976 <sub>dec</sub> )

#### Index F800 PMX Settings

Index (hex)	Name	Meaning	Data type	Flags	Default	
F800:0	PMX Settings	Max. subindex	UINT8	RO	0x15 (21 <sub>dec</sub> )	
F800:01	Reset Interval	Manual restart of the measurement and statistics interval	BOOLEAN	RW	0x00 (0 <sub>dec</sub> )	
F800:12	Measurement Range	Filter setting for determining the fundamental permitted values:	UINT32	RW	0x00000000 (0 <sub>dec</sub> )	
		0				25..65 Hz (default)
		1				25..400 Hz
		2				12..45 Hz
F800:13	Frequency Source	Source of the system frequency	BIT1	RW	0x00000000 (0 <sub>dec</sub> )	
		permitted values:				
		0				Channel 1 (default)
		1				Channel 2
		2	Channel 3			
F800:15	Inaccurate Threshold Voltage	Limit value for the warning bit: Inaccurate Voltage	REAL32	RW	0x3FDC28F6 (1071393014 <sub>dec</sub> )	

## Index F801 PMX Total Settings PQF

Index (hex)	Name	Meaning	Data type	Flags	Default
F801:0	PMX Total Settings PQF	Max. subindex	UINT8	RO	0x13 (19 <sub>dec</sub> )
F801:11	Nominal voltage	A nominal voltage value or set value is required to calculate the power quality factor (for details see basic function principles).	REAL32	RW	230.0000000 (2.3000000e+02)
F801:12	Nominal Frequency	A nominal frequency or set value is required to calculate the power quality factor (for details see basic function principles).	REAL32	RW	50.0000000 (5.0000000e+01)
F801:13	PQF Dataset	permitted values: 0: default 1: default + unbalance	UINT32	RW	Default + Unbalance (1 <sub>dez</sub> )

## Index F802 PMX Guard Settings

Index (hex)	Name	Meaning	Data type	Flags	Default
F802:0	PMX Guard Settings	Max. subindex	UINT8	RO	0x28 (40 <sub>dec</sub> )
F802:11	Frequency Guard Min Error	Lower limit value for a frequency error message	REAL32	RW	0x423C0000 (1111228416 <sub>dec</sub> )
F802:12	Frequency Guard Min Warning	Lower limit value for a frequency warning message	REAL32	RW	0x42460000 (1111883776 <sub>dec</sub> )
F802:13	Frequency Guard Max Warning	Upper limit value for a frequency warning message	REAL32	RW	0x424A0000 (1112145920 <sub>dec</sub> )
F802:14	Frequency Guard Max Error	Upper limit value for a frequency error message	REAL32	RW	0x42500000 (1112539136 <sub>dec</sub> )
F802:21	PQF Guard Min Error	Lower limit value for a power quality factor error message	REAL32	RW	0x3D4CCCCD (1028443341 <sub>dec</sub> )
F802:22	PQF Guard Min Warning	Lower limit value for a power quality factor warning message	REAL32	RW	0x3F4CCCCD (1061997773 <sub>dec</sub> )
F802:23	PQF Guard Max Warning	Upper limit value for a power quality factor warning message	REAL32	RW	0x3F800000 (1065353216 <sub>dec</sub> )
F802:24	PQF Guard Max Error	Upper limit value for a power quality factor error message	REAL32	RW	0x3F800000 (1065353216 <sub>dec</sub> )
F802:25	Unbalance Guard Min Error	Lower limit value for an error message due to voltage imbalance	REAL32	RW	0x00000000 (0 <sub>dec</sub> )
F802:26	Unbalance Guard Min Warning	Lower limit value for a warning message due to voltage imbalance	REAL32	RW	0x00000000 (0 <sub>dec</sub> )
F802:27	Unbalance Guard Max Warning	Upper limit value for a warning message due to voltage imbalance	REAL32	RW	0x00000000 (0 <sub>dec</sub> )
F802:28	Unbalance Guard Max Error	Upper limit value for an error message due to voltage imbalance	REAL32	RW	0x00000000 (0 <sub>dec</sub> )

## 6.6.5.3 Configuration data (vendor-specific)

## Index 80nF PMX vendor data (for ch.1, n = 0; ch.2, n = 1; ch.3, n = 2)

Index (hex)	Name	Meaning	Data type	Flags	Default
80nF:0	PMX Vendor data	Max. subindex	UINT8	RO	0x13 (19 <sub>dec</sub> )
80nF:11	Calibration Voltage Offset	Value in V	REAL32	RW	0x00000000 (0 <sub>dec</sub> )
80nF:12	Calibration Voltage Gain	Factor (without unit)	REAL32	RW	0x3F800000 (1065353216 <sub>dec</sub> )
80nF:13	Calibration Voltage Phase Offset	Value in milliseconds	REAL32	RW	0x00000000 (0 <sub>dec</sub> )

### 6.6.5.4 Input data

#### Index 60n0 PMX status (n = 0, 1, 2)

Index (hex)	Name	Meaning	Data type	Flags	Default
60n0:0	PMX Status	Max. subindex	UINT8	RO	0x10 (16 <sub>dec</sub> )
60n0:02	Overvoltage	Maximum measurable voltage is exceeded.	BOOLEAN	RO	0x00 (0 <sub>dec</sub> )
60n0:04	Inaccurate Voltage	The measured voltage value is smaller than the value entered in CoE object "F800:15 Inaccurate Threshold Voltage".	BOOLEAN	RO	0x00 (0 <sub>dec</sub> )
60n0:06	Voltage Guard Warning	A warning limit of the voltage monitor has been breached.	BOOLEAN	RO	0x00 (0 <sub>dec</sub> )
60n0:07	Voltage Guard Error	An error limit of the voltage monitor has been breached.	BOOLEAN	RO	0x00 (0 <sub>dec</sub> )
6000:10	TxPDO Toggle	The TxPDO toggle is toggled by the slave when the data of the associated TxPDO is updated.	BOOLEAN	RO	0x00 (0 <sub>dec</sub> )

#### Index 60n1\*\*\* PMX Basic (n = 0, 1, 2)

Index (hex)	Name	Meaning	Data type	Flags	Default
60n1:0	PMX Basic	Max. Subindex	UINT8	RO	0x11 (17 <sub>dec</sub> )
60n1:11	Voltage	RMS value of the voltage in V	REAL32	RO	0x00000000 (0 <sub>dec</sub> )

\*\*\*) only for EL3483-0060

#### Index F600 PMX Total Status

Index (hex)	Name	Meaning	Data type	Flags	Default
F600:0	PMX Total Status	Max. subindex	UINT8	RO	0x11 (17 <sub>dec</sub> )
F600:01	System State	Overall system state (as a logical disjunction of voltage guard errors, phase sequence, overvoltage, overcurrent and frequency guard errors)	BOOLEAN	RO	0x00 (0 <sub>dec</sub> )
F600:02	Grid Direction	Phase sequence L1 - L2 - L3 correctly detected (with clockwise 3-phase mains)	BOOLEAN	RO	0x00 (0 <sub>dec</sub> )
F600:03	Frequency Guard Warning	A warning limit of the frequency monitor has been breached.	BOOLEAN	RO	0x00 (0 <sub>dec</sub> )
F600:04	Frequency Guard Error	An error limit of the frequency monitor has been breached.	BOOLEAN	RO	0x00 (0 <sub>dec</sub> )
F600:05	Neutral Current Guard Warning	A warning limit of the neutral conductor current monitor has been breached.	BOOLEAN	RO	0x00 (0 <sub>dec</sub> )
F600:06	Neutral Current Guard Error	An error limit of the neutral conductor current monitor has been breached.	BOOLEAN	RO	0x00 (0 <sub>dec</sub> )
F600:07	Active Power Guard Warning	A warning limit of the active power monitor has been breached.	BOOLEAN	RO	0x00 (0 <sub>dec</sub> )
F600:08	Active Power Guard Error	An error limit of the active power monitor has been breached.	BOOLEAN	RO	0x00 (0 <sub>dec</sub> )
F600:09	Apparent Power Guard Warning	A warning limit of the apparent power monitor has been breached.	BOOLEAN	RO	0x00 (0 <sub>dec</sub> )
F600:0A	Apparent Power Guard Error	An error limit of the apparent power monitor has been breached.	BOOLEAN	RO	0x00 (0 <sub>dec</sub> )
F600:0B	Power Quality Guard Warning	A warning limit of the PQF monitor has been breached.	BOOLEAN	RO	0x00 (0 <sub>dec</sub> )
F600:0C	Power Quality Guard Error	An error limit of the PQF monitor has been breached.	BOOLEAN	RO	0x00 (0 <sub>dec</sub> )
F600:0F	TxPDO State	TRUE for general error	BOOLEAN	RO	0x00 (0 <sub>dec</sub> )
F600:10	TxPDO Toggle	The TxPDO toggle is toggled by the slave when the data of the associated TxPDO is updated.	BOOLEAN	RO	0x00 (0 <sub>dec</sub> )
F600:11	Power Quality Factor	Analog value of the voltage quality between 1.0 and 0 (see basic function principles - Power Quality Factor)	REAL32	RO	0x00000000 (0 <sub>dec</sub> )

**Index F602 PMX Total Advanced**

Index (hex)	Name	Meaning	Data type	Flags	Default
F602:0	PMX Total Advanced	Max. subindex	UINT8	RO	0x02 (2 <sub>dec</sub> )
F602:01	Unbalance Guard Warning	A warning limit of the unbalance monitor has been breached.	BOOLEAN	RO	0x00 (0 <sub>dec</sub> )
F602:02	Unbalance Guard Error	An error limit of the unbalance monitor has been breached.	BOOLEAN	RO	0x00 (0 <sub>dec</sub> )

### 6.6.5.5 Information and diagnostic data

#### Index A0n0 PMX Diag data (for ch.1, n = 0; ch.2, n = 1; ch.3, n = 2)

Index (hex)	Name	Meaning	Data type	Flags	Default
A0n0:0	PMX diag data ch.1	Max. subindex	UINT8	RO	0x11 (17 <sub>dec</sub> )
A0n0:11	Saturation Time Voltage	Time (in 0.1 ms) in which the terminal has measured an overvoltage.	UINT32	RO	0x00000000 (0 <sub>dec</sub> )

#### Index F081 Download revision

Index (hex)	Name	Meaning	Data type	Flags	Default
F081:0	Download revision	Max. subindex	UINT8	RO	0x01 (1 <sub>dec</sub> )
F010:01	Revision number	Configured revision of the terminal, (see note [▶ 139])	UINT32	RW	0x00000000 (0 <sub>dec</sub> )

#### Index F80F PM Vendor data

Index (hex)	Name	Meaning	Data type	Flags	Default
F80F:0	PMX Vendor data	Max. subindex	UINT8	RO	0x11 (17 <sub>dec</sub> )
F80F:11	Type	Vendor-specific data	UINT32	RW	0x00000000 (0 <sub>dec</sub> )

#### Index F904 PMX Total Info data PQF

Index (hex)	Name	Meaning	Data type	Flags	Default
F904:0	PMX Total Info data PQF	Max. subindex	UINT8	RO	0x13 (19 <sub>dec</sub> )
F904:11	PQF Avg	Average value of the power quality factor during the last interval	REAL32	RO	0x00000000 (0 <sub>dec</sub> )
F904:12	PQF Min	Minimum power quality factor in the last interval	REAL32	RO	0x00000000 (0 <sub>dec</sub> )
F904:13	PQF Max	Maximum power quality factor in the last interval	REAL32	RO	0x00000000 (0 <sub>dec</sub> )

#### Index FA00 PMX Diag data

Index (hex)	Name	Meaning	Data type	Flags	Default
FA00:0	PMX Diag data	Max. subindex	UINT8	RO	0x13 (19 <sub>dec</sub> )
FA00:11	Min CPU Die Temperature	Minimum CPU temperature measured so far	REAL32	RO	0x00000000 (0 <sub>dec</sub> )
FA00:12	Max CPU Die Temperature	Maximum CPU temperature measured so far	REAL32	RO	0x00000000 (0 <sub>dec</sub> )
FA00:13	EBUS Voltage	Current E-bus voltage	REAL32	RO	0x00000000 (0 <sub>dec</sub> )

## 6.6.5.6 Standard objects

### Standard objects (0x1000-0x1FFF)

The standard objects have the same meaning for all EtherCAT slaves.

#### Index 1000 Device type

Index (hex)	Name	Meaning	Data type	Flags	Default
1000:0	Device type	Device type of the EtherCAT slave: The Lo-Word contains the CoE profile used (5001). The Hi-Word contains the module profile according to the modular device profile.	UINT32	RO	0x01551389 (22352777 <sub>dec</sub> )

#### Index 1008 Device name

Index (hex)	Name	Meaning	Data type	Flags	Default
1008:0	Device name	Device name of the EtherCAT slave	STRING	RO	EL34xx

#### Index 1009 Hardware version

Index (hex)	Name	Meaning	Data type	Flags	Default
1009:0	Hardware version	Hardware version of the EtherCAT slave	STRING	RO	

#### Index 100A Software Version

Index (hex)	Name	Meaning	Data type	Flags	Default
100A:0	Software version	Firmware version of the EtherCAT slave	STRING	RO	

#### Index 100B Bootloader version

Index (hex)	Name	Meaning	Data type	Flags	Default
100B:0	Bootloader version	Bootloader version	STRING	RO	

#### Index 1018 Identity

Index (hex)	Name	Meaning	Data type	Flags	Default
1018:0	Identity	Information for identifying the slave	UINT8	RO	0x04 (4 <sub>dec</sub> )
1018:01	Vendor ID	Vendor ID of the EtherCAT slave	UINT32	RO	0x00000002 (2 <sub>dec</sub> )
1018:02	Product code	Product code of the EtherCAT slave	UINT32	RO	0x0D9B3052 (228274258 <sub>dec</sub> )
1018:03	Revision	Revision number of the EtherCAT slave; the low word (bit 0-15) indicates the special terminal number, the high word (bit 16-31) refers to the device description	UINT32	RO	0x00000000 (0 <sub>dec</sub> )
1018:04	Serial number	Serial number of the EtherCAT slave; the low byte (bit 0-7) of the low word contains the year of production, the high byte (bit 8-15) of the low word contains the week of production, the high word (bit 16-31) is 0	UINT32	RO	0x00000000 (0 <sub>dec</sub> )

#### Index 10F0 Backup parameter

Index (hex)	Name	Meaning	Data type	Flags	Default
10F0:0	Backup parameter	Length of this object	UINT8	RO	0x01
10F0:01	Checksum	Checksum	UINT32	RW	0x00000000 (0 <sub>dec</sub> )



**Index 10F3 Diagnosis History**

Index	Name	Meaning	Data type	Flags	Default
10F3:0	Diagnosis History	Maximum subindex	UINT8	RO	0x15 (21 <sub>dec</sub> )
10F3:01	Maximum Messages	Maximum number of stored messages. A maximum of 50 messages can be stored	UINT8	RO	0x00 (0 <sub>dec</sub> )
10F3:02	Newest Message	Subindex of the latest message	UINT8	RO	0x00 (0 <sub>dec</sub> )
10F3:03	Newest Acknowledged Message	Subindex of the last confirmed message	UINT8	RW	0x00 (0 <sub>dec</sub> )
10F3:04	New Messages Available	Indicates that a new message is available	BOOLEAN	RO	0x00 (0 <sub>dec</sub> )
10F3:05	Flags	not used	UINT16	RW	0x0000 (0 <sub>dec</sub> )
10F3:06	Diagnosis Message 001	Message 1	OCTET STRING[28]	RO	{0}
...	...	...	...	...	...
10F3:15	Diagnosis Message 016	Message 16	OCTET STRING[28]	RO	{0}

**Index 10F8 Actual Time Stamp**

Index	Name	Meaning	Data type	Flags	Default
10F8:0	Actual Time Stamp	Time stamp	UINT64	RO	0x0000000000000000 (0 <sub>dec</sub> )

**Index 1App TxPDO-Map Status (for L1, pp = 00; L2, pp = 0A; L3, pp = 14)**

Index (hex)	Name	Meaning	Data type	Flags	Default
1App:0	TxPDO-Map Status	PDO Mapping TxPDO	UINT8	RO	0x09 (9 <sub>dec</sub> )
1App:01	SubIndex 001	1. PDO Mapping entry (1 bits align)	UINT32	RO	0x0000:00, 1
1App:02	SubIndex 002	2. PDO Mapping entry (object 0x60n0 (PMX Status), entry 0x02 (Overvoltage))	UINT32	RO	0x60n0:02, 1**
1App:03	SubIndex 003	3. PDO Mapping entry (object 0x60n0 (PMX Status), entry 0x03 (Overcurrent))	UINT32	RO	0x60n0:03, 1**
1App:04	SubIndex 004	4. PDO Mapping entry (object 0x60n0 (PMX Status), entry 0x04 (Inaccurate Voltage))	UINT32	RO	0x60n0:04, 1**
1App:05	SubIndex 005	5. PDO Mapping entry (object 0x60n0 (PMX Status), entry 0x05 (Inaccurate Current))	UINT32	RO	0x60n0:05, 1**
1App:06	SubIndex 006	6. PDO Mapping entry (object 0x60n0 (PMX Status), entry 0x06 (Voltage Guard Warning))	UINT32	RO	0x60n0:06, 1**
1App:07	SubIndex 007	7. PDO Mapping entry (object 0x60n0 (PMX Status), entry 0x07 (Voltage Guard Error))	UINT32	RO	0x60n0:07, 1**
1App:08	SubIndex 008	8. PDO Mapping entry (8 bits align)	UINT32	RO	0x0000:00, 8**
1App:09	SubIndex 009	9. PDO Mapping entry (object 0x60n0 (PMX Status), entry 0x10 (TxPDO Toggle))	UINT32	RO	0x60n0:10, 1**

\*\* ) for L1, n = 0; L2, n = 1; L3, n = 2)

**Index 1A01\*\*\* L1 TxPDO-Map Status**

Index (hex)	Name	Meaning	Data type	Flags	Default
1A01:0	L1 TxPDO-Map Status	PDO Mapping TxPDO	UINT8	RO	0x01 (1 <sub>dec</sub> )
1A01:01	SubIndex 001	1. PDO Mapping entry (object 0x6001 (PMX Basic), entry 0x01 (Voltage))	UINT32	RO	0x6001:11, 32

\*\*\* ) only for EL3483-0060

**Index 1A0B\*\*\* L2 TxPDO-Map Status**

Index (hex)	Name	Meaning	Data type	Flags	Default
1A0B:0	L2 TxPDO-Map Status	PDO Mapping TxPDO	UINT8	RO	0x01 (1 <sub>dec</sub> )
1A0B:01	SubIndex 001	1. PDO Mapping entry (object 0x6011 (PMX Basic), entry 0x01 (Voltage))	UINT32	RO	0x6011:11, 32

\*\*\*) only for EL3483-0060

**Index 1A15\*\*\* L3 TxPDO-Map Status**

Index (hex)	Name	Meaning	Data type	Flags	Default
1A15:0	L3 TxPDO-Map Status	PDO Mapping TxPDO	UINT8	RO	0x01 (1 <sub>dec</sub> )
1A15:01	SubIndex 001	1. PDO Mapping entry (object 0x6021 (PMX Basic), entry 0x01 (Voltage))	UINT32	RO	0x6021:11, 32

\*\*\*) only for EL3483-0060

**Index 1A1E Total TxPDO-Map Total Status**

Index (hex)	Name	Meaning	Data type	Flags	Default
1A1E:0	Total TxPDO-Map Total Status	PDO Mapping TxPDO 31	UINT8	RO	0x10 (16 <sub>dec</sub> )
1A1E:01	SubIndex 001	1. PDO Mapping entry (object 0xF600 (PMX Total Status), entry 0x01 (System State))	UINT32	RO	0xF600:01, 1
1A1E:02	SubIndex 002	2. PDO Mapping entry (object 0xF600 (PMX Total Status), entry 0x02 (Grid Direction))	UINT32	RO	0xF600:02, 1
1A1E:03	SubIndex 003	3. PDO Mapping entry (object 0xF600 (PMX Total Status), entry 0x03 (Frequency Guard Warning))	UINT32	RO	0xF600:03, 1
1A1E:04	SubIndex 004	4. PDO Mapping entry (object 0xF600 (PMX Total Status), entry 0x04 (Frequency Guard Error))	UINT32	RO	0xF600:04, 1
1A1E:05	SubIndex 005	5. PDO Mapping entry (object 0xF600 (PMX Total Status), entry 0x05 (Neutral Current Guard Warning))	UINT32	RO	0xF600:05, 1
1A1E:06	SubIndex 006	6. PDO Mapping entry (object 0xF600 (PMX Total Status), entry 0x06 (Neutral Current Guard Error))	UINT32	RO	0xF600:06, 1
1A1E:07	SubIndex 007	7. PDO Mapping entry (object 0xF600 (PMX Total Status), entry 0x07 (Active Power Guard Warning))	UINT32	RO	0xF600:07, 1
1A1E:08	SubIndex 008	8. PDO Mapping entry (object 0xF600 (PMX Total Status), entry 0x08 (Active Power Guard Error))	UINT32	RO	0xF600:08, 1
1A1E:09	SubIndex 009	9. PDO Mapping entry (object 0xF600 (PMX Total Status), entry 0x09 (Apparent Power Guard Warning))	UINT32	RO	0xF600:09, 1
1A1E:0A	SubIndex 010	10. PDO Mapping entry (object 0xF600 (PMX Total Status), entry 0x0A (Apparent Power Guard Error))	UINT32	RO	0xF600:0A, 1
1A1E:0B	SubIndex 011	11. PDO Mapping entry (object 0xF600 (PMX Total Status), entry 0x0B (Power Quality Guard Warning))	UINT32	RO	0xF600:0B, 1
1A1E:0C	SubIndex 012	12. PDO Mapping entry (object 0xF600 (PMX Total Status), entry 0x0C (Power Quality Guard Error))	UINT32	RO	0xF600:0C, 1
1A1E:0D	SubIndex 013	13. PDO Mapping entry (2 bits align)	UINT32	RO	0x0000:00, 2
1A1E:0E	SubIndex 014	14. PDO Mapping entry (object 0xF600 (PMX Total Status), entry 0x0E (TxPDO State))	UINT32	RO	0xF600:0E, 1
1A1E:0F	SubIndex 015	15. PDO Mapping entry (object 0xF600 (PMX Total Status), entry 0x10 (TxPDO Toggle))	UINT32	RO	0xF600:10, 1
1A1E:10	SubIndex 016	16. PDO Mapping entry (object 0xF600 (PMX Total Status), entry 0x11 (Power Quality Factor))	UINT32	RO	0xF600:11, 32

**Index 1A20 Total TxPDO-Map Total Advanced**

Index (hex)	Name	Meaning	Data type	Flags	Default
1A20:0	Total TxPDO-Map Total Advanced	PDO Mapping TxPDO 33	UINT8	RO	0x03 (3 <sub>dec</sub> )
1A20:01	SubIndex 001	1. PDO Mapping entry (object 0xF602 (PMX Total Advanced), entry 0x01 (Unbalance Guard Warning))	UINT32	RO	0xF602:01, 1
1A20:02	SubIndex 002	2. PDO Mapping entry (object 0xF602 (PMX Total Advanced), entry 0x02 (Unbalance Guard Error))	UINT32	RO	0xF602:02, 1
1A20:03	SubIndex 003	3. PDO Mapping entry (14 bits align)	UINT32	RO	0x0000:00, 14

**Index 1A24\*\*\* Total TxPDO-Map Total L-L Voltage**

Index (hex)	Name	Meaning	Data type	Flags	Default
1A24:0	Total TxPDO-Map Total L-L Voltage	PDO Mapping TxPDO 37	UINT8	RO	0x03 (3 <sub>dec</sub> )
1A24:01	SubIndex 001	1. PDO Mapping entry (object 0xF609 (PMX Grid L-L Voltages), entry 0x11 (L1-L2 Voltage))	UINT32	RO	0xF609:11, 32
1A24:02	SubIndex 002	2. PDO Mapping entry (object 0xF609 (PMX Grid L-L Voltages), entry 0x12 (L2-L3 Voltage))	UINT32	RO	0xF609:12, 32
1A24:03	SubIndex 003	3. PDO Mapping entry (object 0xF609 (PMX Grid L-L Voltages), entry 0x13 (L3-L1 Voltage))	UINT32	RO	0xF609:13, 32

\*\*\*) only for EL3483-0060

**Index 1C00 Sync manager type**

Index (hex)	Name	Meaning	Data type	Flags	Default
1C00:0	Sync manager type	Length of this object	UINT8	RO	0x04 (4 <sub>dec</sub> )
1C00:01	SubIndex 001	Sync-Manager Type Channel 1: Mailbox Write	UINT8	RW	0x01 (1 <sub>dec</sub> )
1C00:02	SubIndex 002	Sync-Manager Type Channel 2: Mailbox Read	UINT8	RW	0x02 (2 <sub>dec</sub> )
1C00:03	SubIndex 003	Sync-Manager Type Channel 3: Process Data Write (Outputs)	UINT8	RW	0x03 (3 <sub>dec</sub> )
1C00:04	SubIndex 004	Sync-Manager Type Channel 4: Process Data Read (Inputs)	UINT8	RW	0x04 (4 <sub>dec</sub> )

**Index 1C12 RxPDO assign**

Index (hex)	Name	Meaning	Data type	Flags	Default
1C12:0	RxPDO assign	PDO Assign Outputs	UINT8	RW	0x00 (0 <sub>dec</sub> )

**Index 1C13 TxPDO assign**

Index (hex)	Name	Meaning	Data type	Flags	Default
1C13:0	TxPDO assign	PDO Assign Inputs	UINT8	RW	0x04 (4 <sub>dec</sub> )
1C13:01	SubIndex 001	1. allocated TxPDO (contains the index of the associated TxPDO mapping object)	UINT16	RW	0x1A00 (6656 <sub>dec</sub> )
1C13:02	SubIndex 002	2. allocated TxPDO (contains the index of the associated TxPDO mapping object)	UINT16	RW	0x1A0A (6666 <sub>dec</sub> )
1C13:03	SubIndex 003	3. allocated TxPDO (contains the index of the associated TxPDO mapping object)	UINT16	RW	0x1A14 (6676 <sub>dec</sub> )
1C13:04	SubIndex 004	4. allocated TxPDO (contains the index of the associated TxPDO mapping object)	UINT16	RW	0x1A1E (6686 <sub>dec</sub> )
1C13:05	SubIndex 005	5. allocated TxPDO (contains the index of the associated TxPDO mapping object)	UINT16	RW	0x0000 (0 <sub>dec</sub> )

## Index 1C33 SM input parameter

Index (hex)	Name	Meaning	Data type	Flags	Default
1C33:0	SM input parameter	Synchronization parameters for the inputs	UINT8	RO	0x20 (32 <sub>dec</sub> )
1C33:01	Sync mode	Current synchronization mode: 0: Free Run 1: Synchron with SM 3 Event (no outputs available) 2: DC - Synchron with SYNC0 Event 3: DC - Synchron with SYNC1 Event 34: Synchron with SM 2 event (outputs available)	UINT16	RW	0x0000 (0 <sub>dec</sub> )
1C33:02	Cycle time	as 1C32:02	UINT32	RW	0x0016E360 (1500000 <sub>dec</sub> )
1C33:03	Shift time	Time between SYNC0 event and reading of the inputs (in ns, only DC mode)	UINT32	RO	0x00000384 (900 <sub>dec</sub> )
1C33:04	Sync modes supported	Supported synchronization modes: Bit 0: free run is supported Bit 1: Synchron with SM 2 Event is supported (outputs available) Bit 1: Synchron with SM 3 Event is supported (no outputs available) Bit 2-3 = 01: DC mode is supported Bit 4-5 = 01: Input shift through local event (outputs available) Bit 4-5 = 10: Input shift with SYNC1 event (no outputs available) Bit 14 = 1: dynamic times (measurement through writing of 1C32:08 or 1C33:08)	UINT16	RO	0x0805 (2053 <sub>dec</sub> )
1C33:05	Minimum cycle time	as 1C32:05	UINT32	RO	0x0007A120 (500000 <sub>dec</sub> )
1C33:06	Calc and copy time	Time between reading of the inputs and availability of the inputs for the master (in ns, only DC mode)	UINT32	RO	0x0007A120 (500000 <sub>dec</sub> )
1C33:07	Minimum delay time		UINT32	RO	0x00000384 (900 <sub>dec</sub> )
1C33:08	Command	as 1C32:08	UINT16	RW	0x0000 (0 <sub>dec</sub> )
1C33:09	Maximum delay time	Time between SYNC1 event and reading of the inputs (in ns, only DC mode)	UINT32	RO	0x00000384 (900 <sub>dec</sub> )
1C33:0B	SM event missed counter	as 1C32:11	UINT16	RO	0x0000 (0 <sub>dec</sub> )
1C33:0C	Cycle exceeded counter	as 1C32:12	UINT16	RO	0x0000 (0 <sub>dec</sub> )
1C33:0D	Shift too short counter	as 1C32:13	UINT16	RO	0x0000 (0 <sub>dec</sub> )

## Index F000 Modular device profile

Index (hex)	Name	Meaning	Data type	Flags	Default
F000:0	Modular device profile	Largest subindex of this object	UINT8	RO	0x02 (2 <sub>dec</sub> )
F000:01	Module index distance	Index distance of the objects of the individual channels	UINT16	RW	0x0010 (16 <sub>dec</sub> )
F000:02	Maximum number of modules	Number of channels	UINT16	RW	0x0003 (3 <sub>dec</sub> )

## Index F008 Code word

Index (hex)	Name	Meaning	Data type	Flags	Default
F008:0	Code word	reserved	UINT32	RW	0x00000000 (0 <sub>dec</sub> )

## **i** Code Word

The vendor reserves the authority for the basic calibration of the terminals. The code word is therefore at present reserved.

**Index F010 Module List**

Index (hex)	Name	Meaning	Data type	Flags	Default
F010:0	Module list		UINT8	RW	0x03 (3 <sub>dec</sub> )
F010:01	SubIndex 001		UINT32	RW	0x00000155 (341 <sub>dec</sub> )
F010:02	SubIndex 002		UINT32	RW	0x00000155 (341 <sub>dec</sub> )
F010:03	SubIndex 003		UINT32	RW	0x00000155 (341 <sub>dec</sub> )

**6.6.5.7 Command object**

**Index FB00 PMX Command**

The command object is used for triggering an action in the terminal. The command is started by writing subindex 1 (request). Write access is disabled until the current command is completed.

Index (hex)	Name	Meaning	Data type	Flags	Default	
FB00:0	PM Command	Largest subindex of this object	UINT8	RO	0x03 (3 <sub>dec</sub> )	
FB00:01	Request	<b>Byte 0 - service request data</b>	OCTET-STRING [2]	RW	0x0000 (0 <sub>dec</sub> )	
		4 <sub>hex</sub>				Clear energy or reset all energy counters
		<b>Byte 1 - channel selection</b>				
		00 <sub>hex</sub>				all channels
		01 <sub>hex</sub>				Channel 1
		02 <sub>hex</sub>	Channel 2			
		03 <sub>hex</sub>	Channel 3			
FB00:02	Status	<b>Byte 0</b> reserved	UINT8	RW	0x00 (0 <sub>dec</sub> )	
FB00:03	Response	<b>Byte 0</b> reserved	OCTET-STRING [2]	RW	0x00000000 (0 <sub>dec</sub> )	
		<b>Byte 1</b> reserved				
		<b>Byte 2-n</b> reserved				

## 7 Application examples

### 7.1 Power measurement on motor with 2 or 3 current transformers

#### ⚠ WARNING

##### WARNING: Risk of electric shock!

If you do not connect terminal point N with the neutral conductor of your mains supply, you have to earth terminal point N, in order to avoid dangerous overvoltages in the event of a fault with a current transformer!

#### NOTICE

##### Attention! Risk of device damage!

Avoid confusing the current and voltage circuit during connection, since the direct connection of mains voltage to the terminal points for the current transformers (typical input resistance 220 mΩ) would destroy the power measurement terminal!

#### EL3443

- The voltage is measured via the connections L1, L2 and L3.
- The current is measured with two current transformers [► 49] (e.g. the SCT series from Beckhoff) via the connections  $I_{L1}$  and  $I_{L2}$ .
- The sum of all currents in the 3-phase mains network is 0. The value in circuit  $I_{L3}$  can be obtained accordingly by wiring the EL3443.

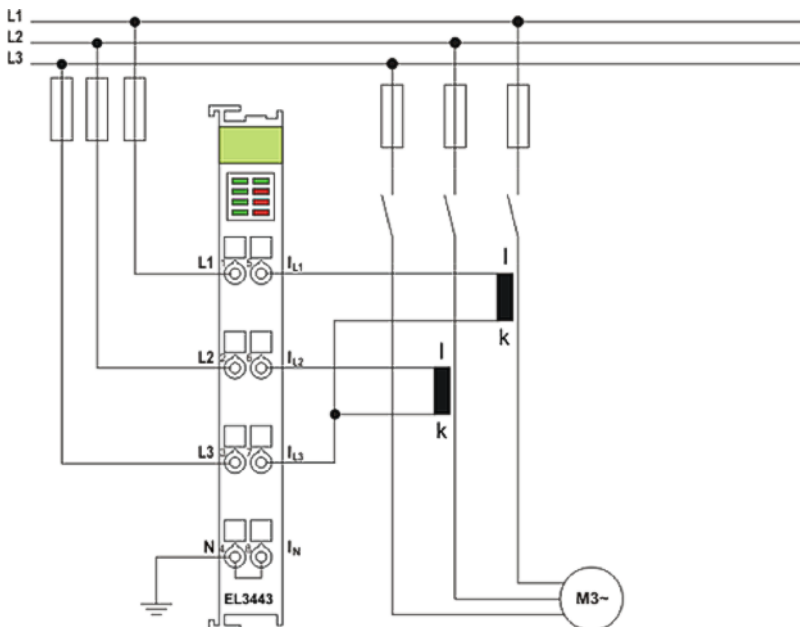

Fig. 154: EL3443, Power measurement with 2 current transformers on a motor

In the circuit shown above (Fig. *EL3443, power measurement with 2 current transformers on a motor*), ensure that the three-phase system is either earth-free or has an earthed star point. Alternatively a transformer can be included in a Yy0 circuit.

EL3453

- The voltage is measured via the connections L1, L2 and L3.
- The current is measured with three current transformers [▶ 49] e.g. the SCT series from Beckhoff) via the connections  $I_{L1}$ ,  $I_{L2}$  and  $I_{L3}$

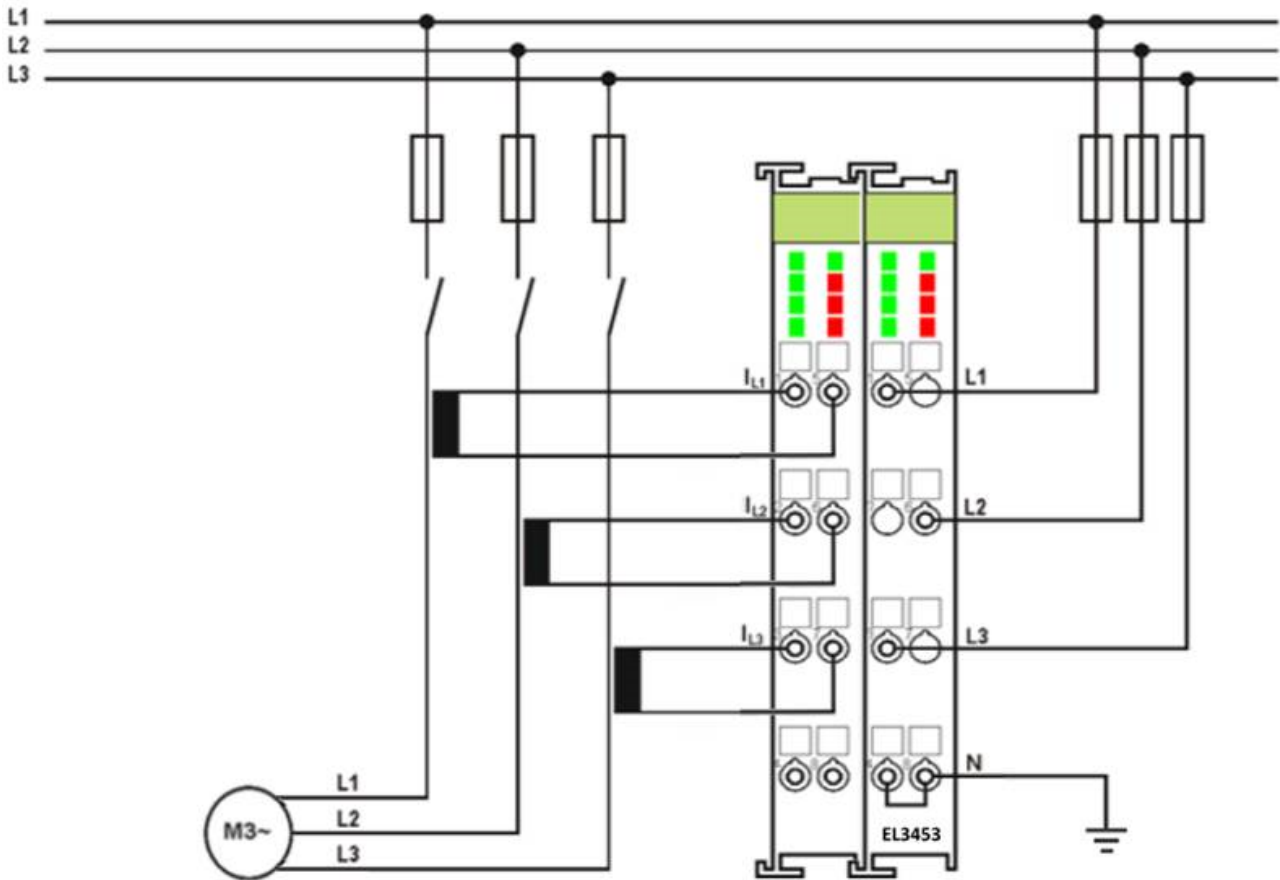

Fig. 155: EL3453, Power measurement with 3 current transformers on a motor

In the circuit shown above (Fig. *EL3453, Power measurement with 3 current transformers on a motor*), ensure that the three-phase system is either earth-free or has an earthed star point. Alternatively a transformer can be included in a Yy0 circuit.

## 7.2 Power measurement at a machine

### ⚠ WARNING

#### WARNING: Risk of electric shock!

Bring the Bus Terminal system into a safe, voltage-free state before starting mounting, disassembly or wiring of the Bus Terminals!

### NOTICE

#### Attention! Risk of device damage!

Avoid confusing the current and voltage circuit during connection, since the direct connection of mains voltage to the terminal points for the current transformers (typical input resistance 100 mΩ) would destroy the power measurement terminal!

#### EL3443

- The voltage is measured via connections L1, L2, L3 and N.
- The current is measured via three current transformers (e.g. from the Beckhoff SCT series) and the connections  $I_{L1}$ ,  $I_{L2}$ ,  $I_{L3}$  and  $I_N$  (star point of the current transformers).

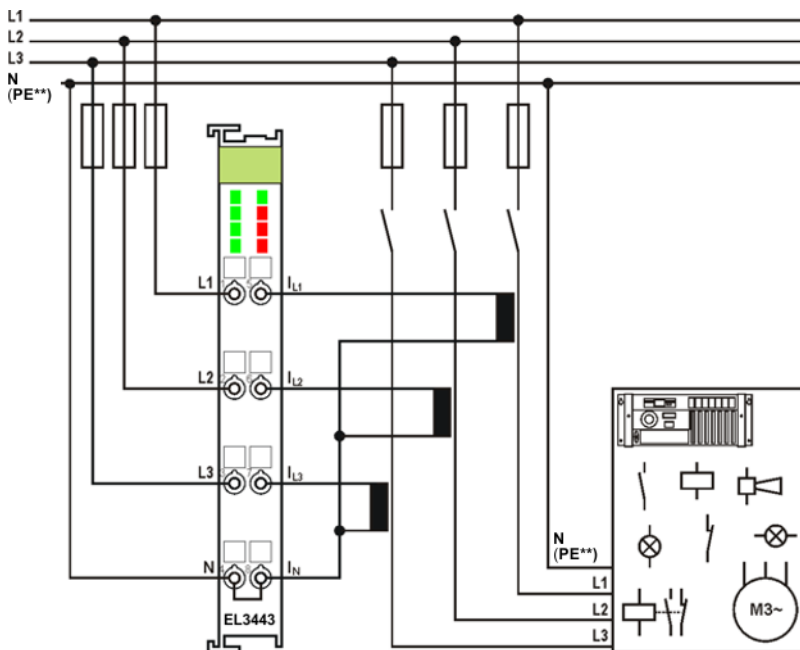

Fig. 156: EL3443, power measurement at a machine

#### ● Fuse protection of the terminal

**i** The voltage measurement inputs L1 - L3 are high-impedance; a minimum measurement current flows. The fuses to the connection points L1 - L3 are therefore only to be designed according to the connection cross-section.

For the current measurement inputs  $I_{L1}$  -  $I_{L2}$ , the fuse protection must be adapted according to the device to be measured.

The secondary currents of the transformers are not fused, see figure.

#### ● \*\*) PE as star point for 3-phase systems without neutral line

**i** Depending on the current transformers used, PE must be connected as star point in 3-phase systems without neutral line as shown in Fig. "EL3443, power measurement at a machine".

Observe the regulations of the manufacturer of the current transformers!

#### ● Negative power values

**i** If negative power values are measured on a circuit, please check whether the associated current transformer circuit is connected correctly.



EL3453

- The voltage is measured via connections L1, L2, L3 and N.
- The current is measured via 4 current transformers (e.g. from the Beckhoff SCT series) and the connections  $I_{L1}$ ,  $I_{L2}$ ,  $I_{L3}$  and  $I_N$  (star point of the current transformers).

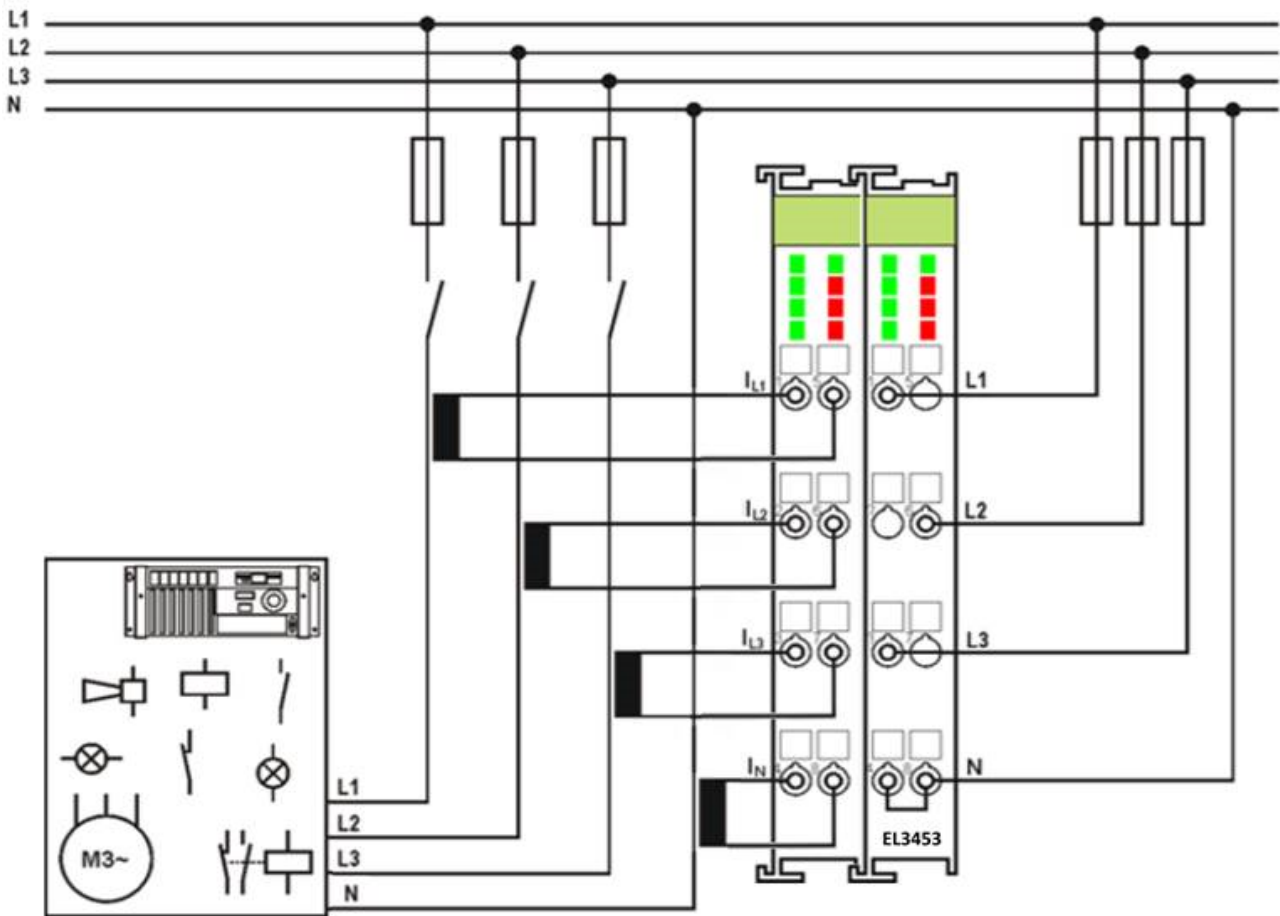

Fig. 157: EL3453, power measurement at a machine

**i Negative power values**

If negative power values are measured on a circuit, please check whether the associated current transformer circuit is connected correctly.

### 7.3 Power measurement in a single-phase mains network

- The voltage is measured via connections L1, L2, L3 and N.
- The current is measured via three [current transformers](#) [▶ 49] (e.g. the [SCT](#) series from Beckhoff) and the connections  $I_{L1}$ ,  $I_{L2}$ ,  $I_{L3}$  and  $I_N$  (star point of the current transformers).

#### ⚠ WARNING

##### WARNING: Risk of electric shock!

Bring the Bus Terminal system into a safe, voltage-free state before starting mounting, disassembly or wiring of the Bus Terminals!

#### NOTICE

##### Attention! Risk of device damage!

Avoid confusing the current and voltage circuit during connection, since the direct connection of mains voltage to the terminal points for the current transformers (typical input resistance 220 mΩ) would destroy the power measurement terminal!

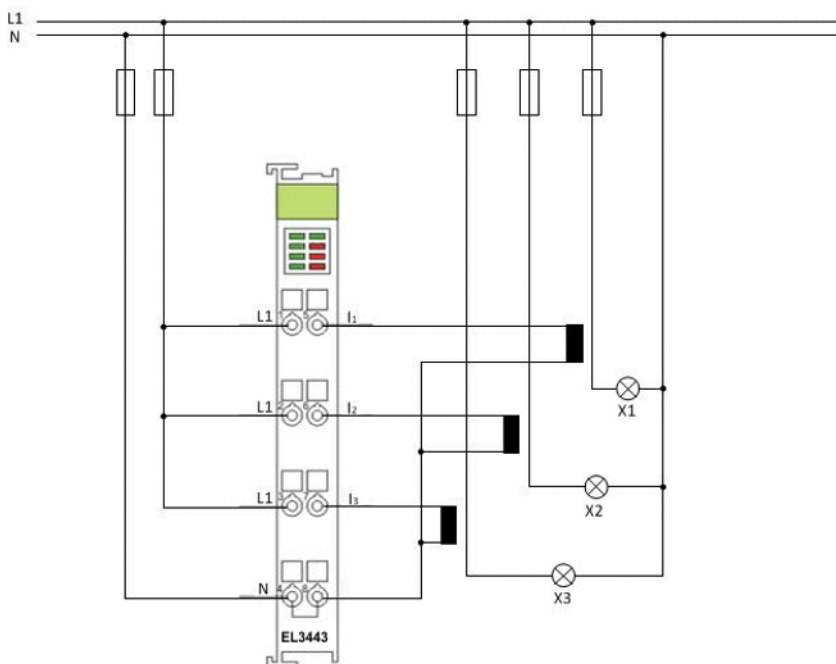

Fig. 158: Power measurement in a single-phase mains network

## 7.4 Power measurement at a fieldbus station

**⚠ WARNING**

**Risk of injury through electric shock and damage to the device!**

Bring the Bus Terminal system into a safe, voltage-free state before starting mounting, disassembly or wiring of the Bus Terminals!

The example illustrates power measurement at three circuits of the fieldbus station. The terminal measures the:

- Power consumption of the Bus Coupler and E-bus supply
- Power consumption of the power contacts
- Power consumption AS-i over the AS-i potential feed terminal (EL9520)

**NOTICE**

**Note rated current!**

In the example, the special type EL3443-0010 is used with an extended current measuring range (5 A max.). The standard EL3443 type is not suitable for this application example because the current measuring range is too small (1 A)!

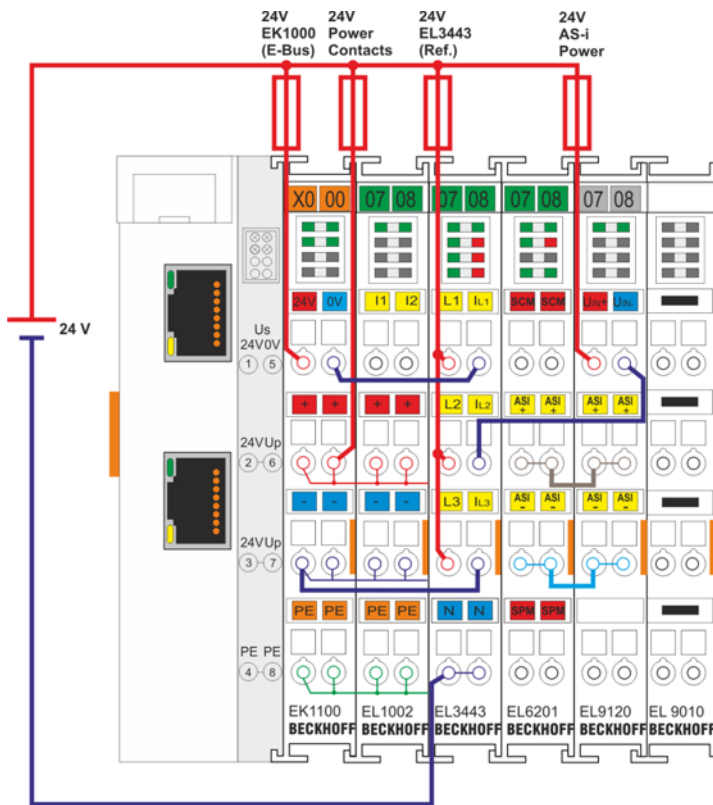

Fig. 159: Application example - power measurement at a fieldbus station

## 7.5 Power measurement at three-phase motors controlled by a frequency converter

### ⚠ WARNING

#### Risk of injury through electric shock and damage to the device!

Bring the Bus Terminal system into a safe, voltage-free state before starting mounting, disassembly or wiring of the Bus Terminals!

The example illustrates power measurement at several three-phase motors that are controlled by a frequency converter (AC converter), e.g. at a conveyor system. Each motor is monitored by a EL3443.

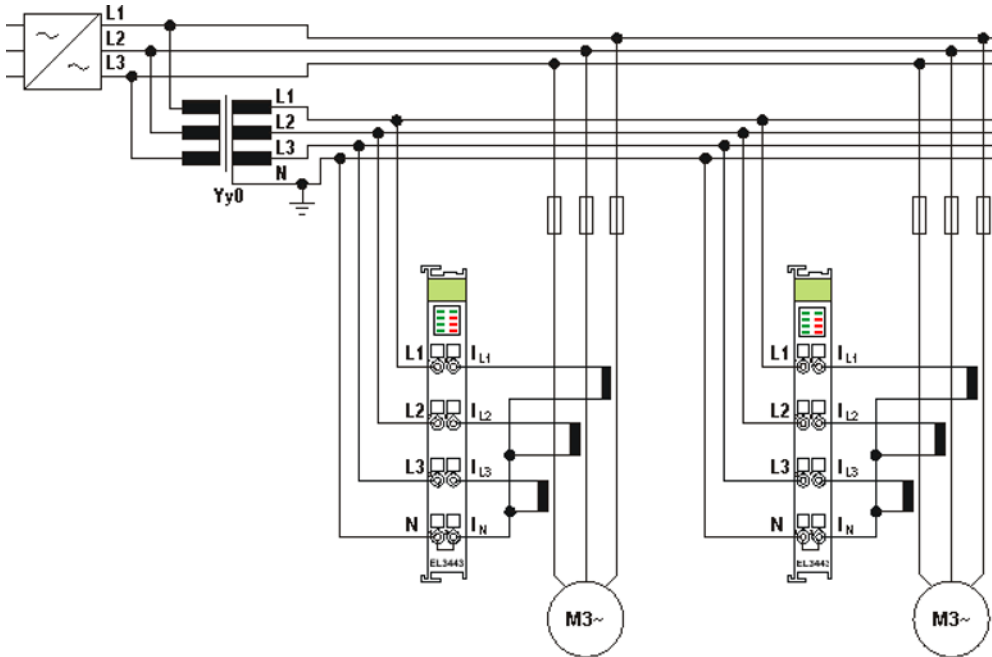

Fig. 160: Application example with frequency converter

The electrical isolation of the three-phase-transformer (Yy0) operated by the voltage circuit of the power measurement terminals enables measurement after the frequency converter.

### ● Measuring error in the lower frequency range

**i** If the power measurement takes place after the frequency converter, a larger measuring error is possible in the lower frequency range, particularly for voltage measurement. This error also affects the power calculation.

The three-phase transformer should have a ratio of 1:1. It must not cause a phase shift of the signal! Since high-frequency components only have little influence on the motors, any distortions caused by the three-phase transformer have little effect on the practical measurement during the transfer of the harmonics created by the frequency converter.

The power distribution is mapped very well by using a dedicated power measurement terminal for each motor. Excessive current consumption of an individual motor can be detected in good time.

It is not possible to use this method for measuring direct voltage/DC (e.g. holding currents of synchronous motors)! Practical results can be obtained for voltages/currents with a frequency above 12 Hz, depending on the three-phase transformer and current transformers used.

### ⚠ CAUTION

#### The terminal points N must be grounded!

Due to the electrical isolation through the three-phase transformer, the terminal points N of the power measurement terminals have to be grounded, in order to avoid dangerous overvoltages in the event of a fault in a current transformer!

## 7.6 Power measurement on loads with phase-to-phase voltages

In some cases it may be useful, for the purpose of increasing the power, to operate some consumers in a three-phase network with the phase-to-phase voltage. As this is larger than the phase voltages by a factor of  $\sqrt{3}$ , the power also increases by a factor of  $\sqrt{3}$  with the same current or, as the case may be, the same power can be achieved with a lower current.

When using the EL3443 and EL3453, the limitation of the maximum measuring voltage between  $U_{Lx}$  and N has been taken into account. The technical measuring range of the EL3453 is approx. 130 % larger than the nominal measuring range. Therefore, phase-to-phase voltages of up to 277 V can be measured with the EL3443, and nominally up to 400 V and technically up to 520 V with the EL3453. In the case of the EL3453, the maximum time for voltages above 500 V must be taken into account if the nominal measuring range is exceeded (see [EL3453-0x00](#) [▶ 31])

As standard, the EL3443 and EL3453 measure the phase voltages and currents. If wired correctly, however, the phase-to-phase voltages and the currents through the connected consumers can also be measured and the associated power values calculated. In order to measure the voltage and current correctly and thus to determine the correct power values, the EL3443 or EL3453 respectively must be wired as follows:

### EL3443

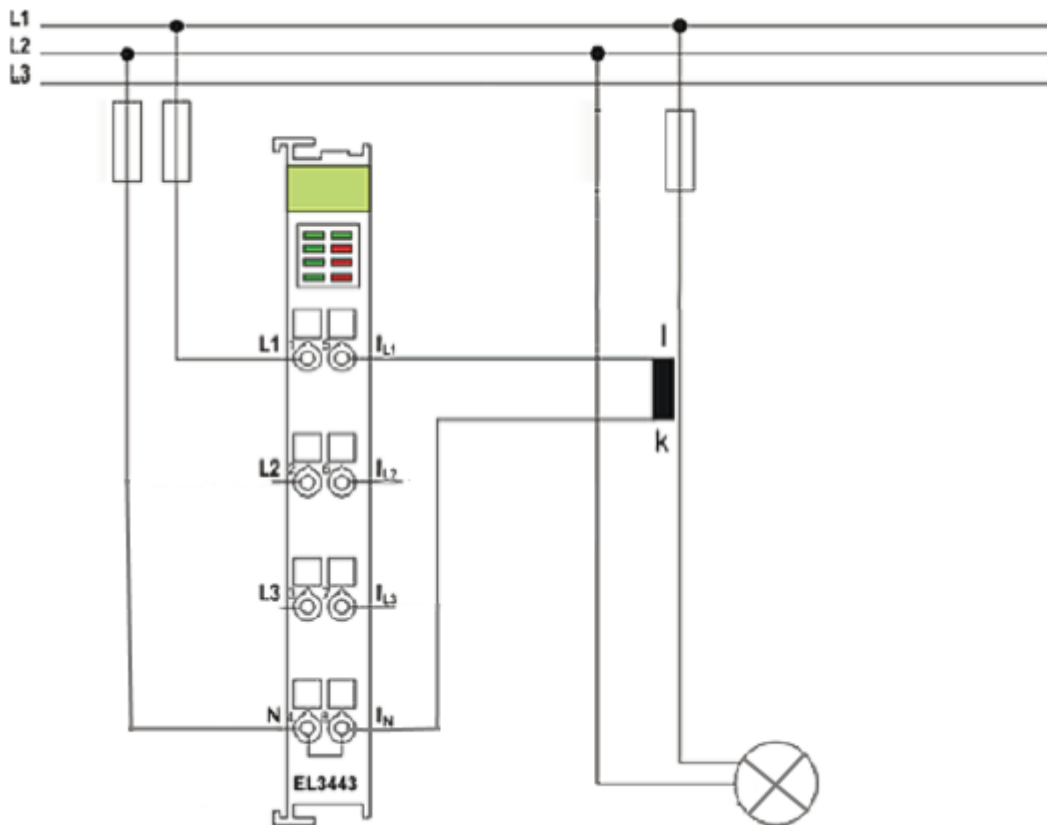

Fig. 161: EL3443 – wiring for measurement of the phase-to-phase voltage

The phase-to-phase voltage between L1 and L2 is measured on the terminal between L1 and N. The voltage of phase L2 is thus the reference potential for phase L1 in order to be able to measure the voltage between the phases.

The current is measured between the current measuring channel for the first phase and the current measuring channel for N or the reference point respectively. When the current between L1 and L2 is measured, the terminal expects the current of phase L1. In a setup with only one consumer, this corresponds to the current that flows through the consumer. If there are several consumers, however, the current is divided at each node accordingly.

## EL3453

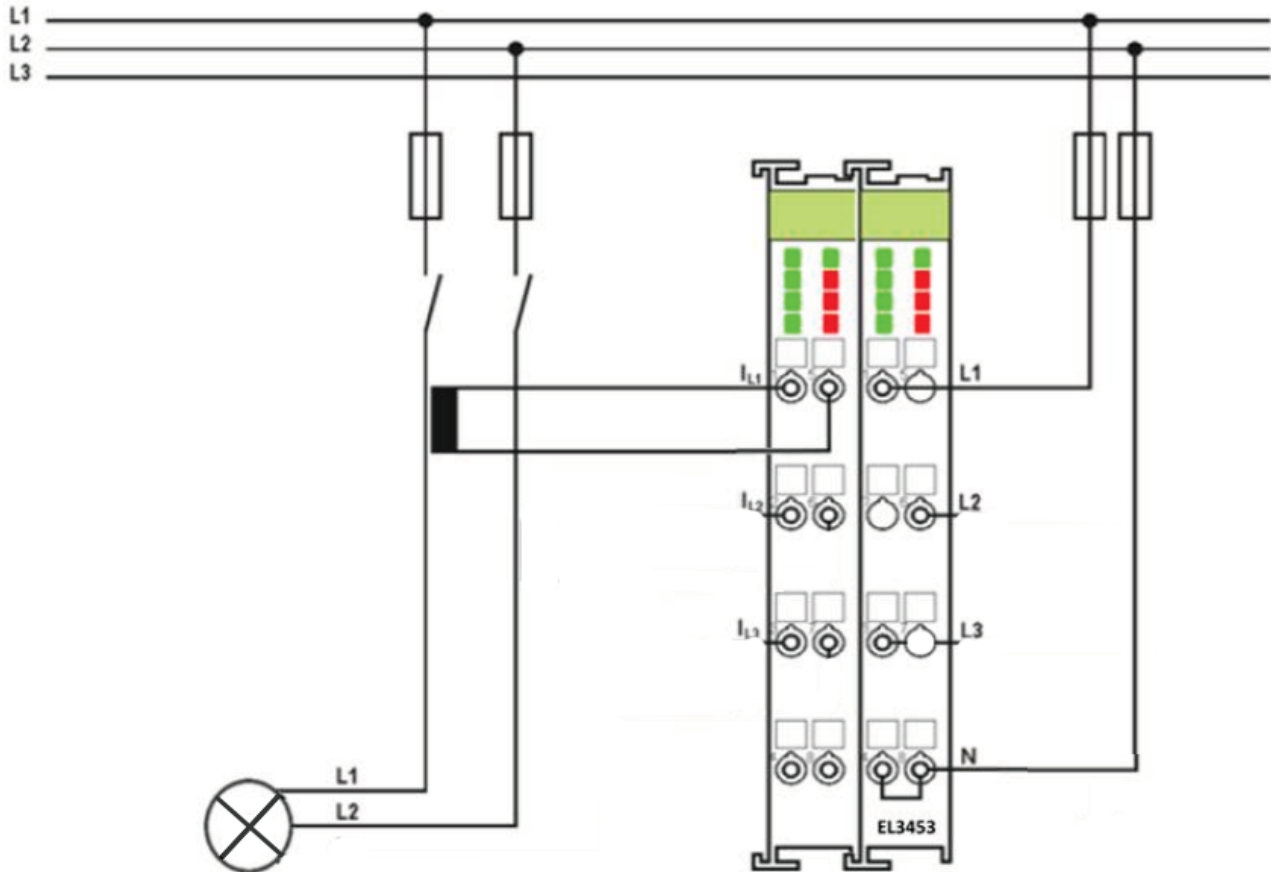

Fig. 162: EL3453 – wiring for measurement of the phase-to-phase voltage

The phase-to-phase voltage between L1 and L2 is measured on the terminal between L1 and N. The voltage of phase L2 is thus the reference potential for phase L1 in order to be able to measure the voltage between the phases.

The current to be measured is the current through the consumer. This is the current that flows from phase 1 through the consumer to phase 2. Using a current transformer, this current can be measured differentially with the EL3453 on the current measuring channel  $I_{L1}$ , so that the associated power and energy values can be calculated.

## 7.7 Power measurement including differential current measurement

- The voltage is measured via connections L1, L2, L3 and N.
- The current is measured via three or four current transformers [► 49] (e.g. the SCT series from Beckhoff) and the connections  $I_{L1}$ ,  $I_{L1'}$ ,  $I_{L2}$ ,  $I_{L2'}$ ,  $I_{L3}$ ,  $I_{L3'}$  and  $I_N$ ,  $I_{N'}$ .

**⚠ WARNING**

**WARNING: Risk of electric shock!**

Bring the Bus Terminal system into a safe, voltage-free state before starting mounting, disassembly or wiring of the Bus Terminals!

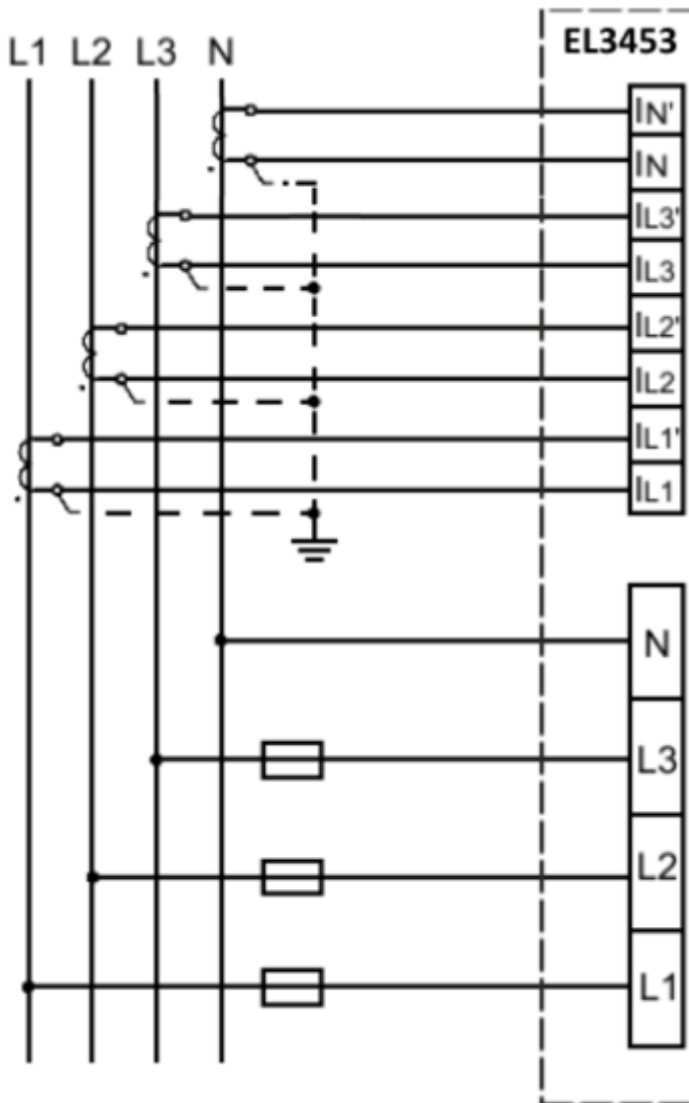

Fig. 163: Common wiring of the EL3453 power measurement terminal

In the following diagram, the current measuring channel  $I_N$  is used to measure the neutral conductor current.



Fig. 164: Conventional converter arrangement for the EL3453 power measurement terminal including neutral conductor measurement

Diagram of a different transducer arrangement for direct measurement of the differential current:

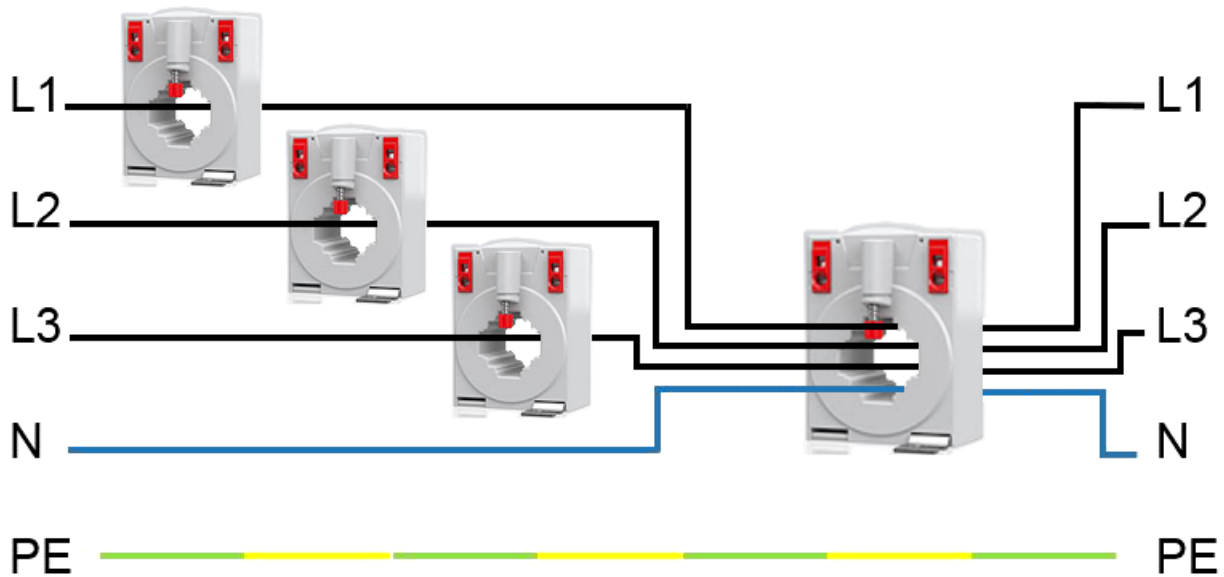

Fig. 165: Transformer configuration of the EL3453 for differential current measurement

The secondary current path of the differential current transformer must be connected to the terminal contacts  $I_N$  (and  $I_{N'}$ ).

For correct calculation of the differential current value, the corresponding transformer ratio must be entered in CoE object 0xF804:12.

Example: Transformer ratio 1A:50A corresponds to value to be entered 0.02



## 7.8 Example program for the evaluation of the EL34xx

Example program EL34xx:  <https://infosys.beckhoff.com/content/1033/el34xx/Resources/9766054667/.zip>

The sample program presented here contains function blocks for reading out the measured values for all terminals listed below:

- EL3423
- EL3443
- EL3443 Distributed Power Measurement (DPM)
- EL3446 Distributed Power Measurement (DPM)
- EL3453
- EL3483
- EL3483-0060

The read-out measured values are written into a structure which can then be read out in the program.

With the EL3423, EL3483 and EL3483-0060 terminals, all values from the process data are written into the structure. With the EL3443, EL3446 and EL3453 terminals, the variant values are read out in addition to the process data and also written to a structure. This results in a total number of more than 600 possible measured values, depending on the terminal.

Detailed information and instructions for parameterization of the terminal for the respective module to be used can be found in the module itself. The description in the form of a comment is located above the variable declaration. The necessary information about the "Predefined PDO Assignment" and the setting of the distributed clocks is also given there.

## 7.9 Example Function Blocks for evaluation using the PLC data types

Example function block (FB\_example\_evaluation)  <https://infosys.beckhoff.com/content/1033/el34xx/Resources/8338281227/.zip>

### **i** User note

Due to the complexity of this sample program, it is recommended to use these function blocks only as an experienced user. Alternative function blocks can be found in the chapter [Example program for the evaluation \[► 289\]](#) of the EL34xx.

This function block handles the complete reading of the available values from the EL3443 and EL3453 power measurement terminals and stores them in a STRUCT provided for this purpose:

```

1  TYPE stEL3453_ch :
2  STRUCT
3      fULrms      : REAL; // [V]
4      fUL_peak   : REAL; // [V]
5      ulUL_ZC    : ULINT; // [ns]
6      fULrms_min : REAL; // [V]
7      fULrms_max : REAL; // [V]
8      fUL_THD    : REAL; // [% of fundamental rms]
9      fULrms_fund : REAL; // [V]
10     fUL_harm    : ARRAY [0..63] OF REAL; // [% of fundamental rms]
11     fUL_harmrf  : REAL; // [Hz]
12
13     fIrms       : REAL; // [A]
14     fI_peak     : REAL; // [A]
15     ulI_ZC      : ULINT; // [ns]
16     fIrms_min   : REAL; // [A]
17     fIrms_max   : REAL; // [A]
18     fI_THD      : REAL; // [% of fundamental rms]
19     fI_TDD      : REAL; // [% of max rms]
20     fIrms_fund  : REAL; // [A]
21     fIL_harm    : ARRAY [0..63] OF REAL; // [% of fundamental rms]
22     fIL_harmrf  : REAL; // [Hz]
23
24     fFreq       : REAL; // [Hz]
25     fPhi        : REAL; // [°]
26     fCosPhi     : REAL; // [ ]
27     fPF         : REAL; // [ ]
28
29     fP          : REAL; // [W]
30     fP_avg      : REAL; // [W]
31     fP_min      : REAL; // [W]
32     fP_max      : REAL; // [W]
33     fP_fund     : REAL; // [W]

```

Fig. 166: STRUCT representation

To use the function module

- the predefined PDO assignment "Default + Variant" under "Process Data" for the terminal must be selected.

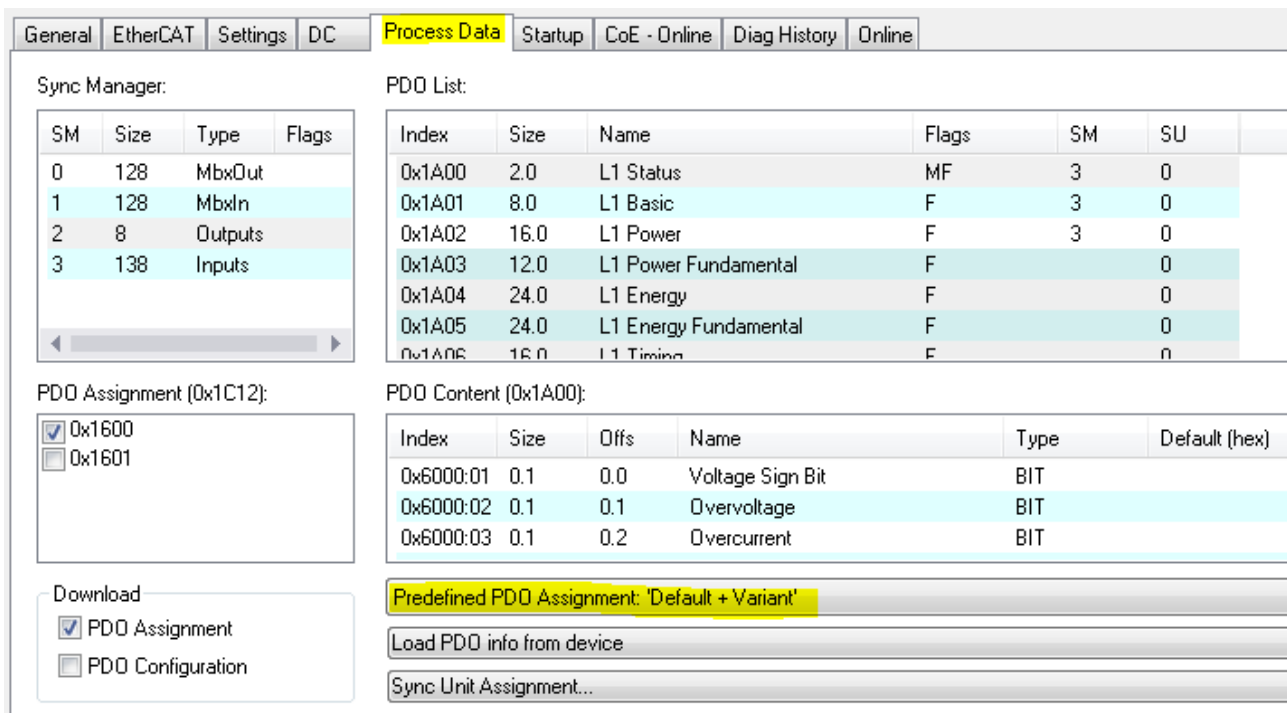

Fig. 167: Selection predefined PDO assignment "Default + Variant"

- Then the PLC data type (structure from the process data) must be activated in the "PLC" tab.

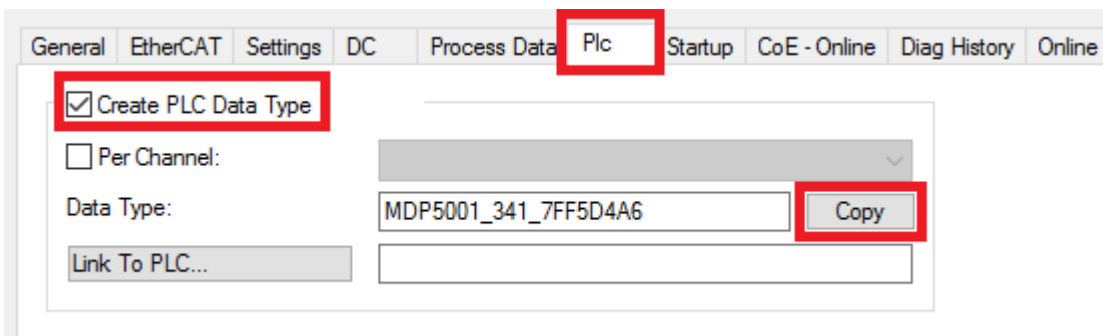

Fig. 168: Activate the PLC data type

- After downloading the sample function block it may be added to the PLC project.

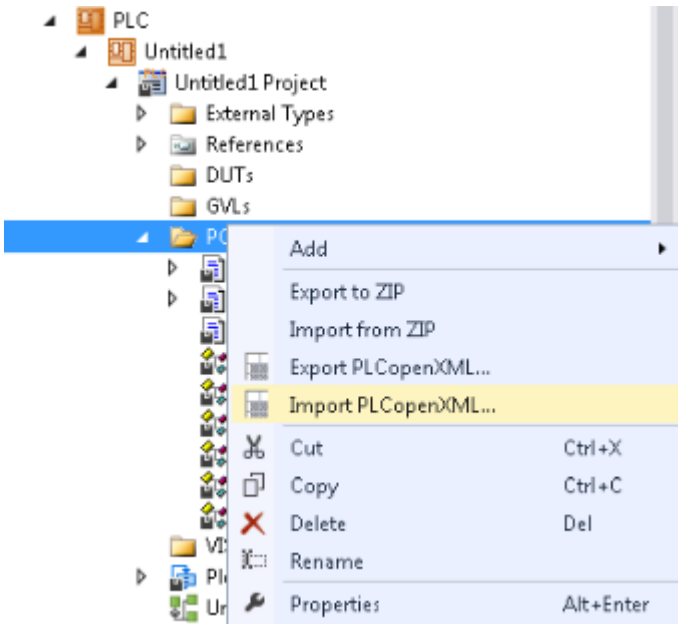

Fig. 169: Import of the PLCopenXML

- You can then create and call an instance of the added function module in MAIN.

```

FB_EL3443  MAIN*
1  PROGRAM MAIN
2  VAR
3      fbEL3443      : FB_EL3443;
4      stEL3443     : stEL3443;
5  END_VAR

1  fbEL3443 (pOut := ADR (stEL3443));
    
```

Fig. 170: Exemplary instance of FB EL3443 in the MAIN

- Then the process data structure from the PLC must be linked to the hardware.

```

EL3443      : MDP5001_341_7FF5D4A6;
    
```

Fig. 171: Variable for linking

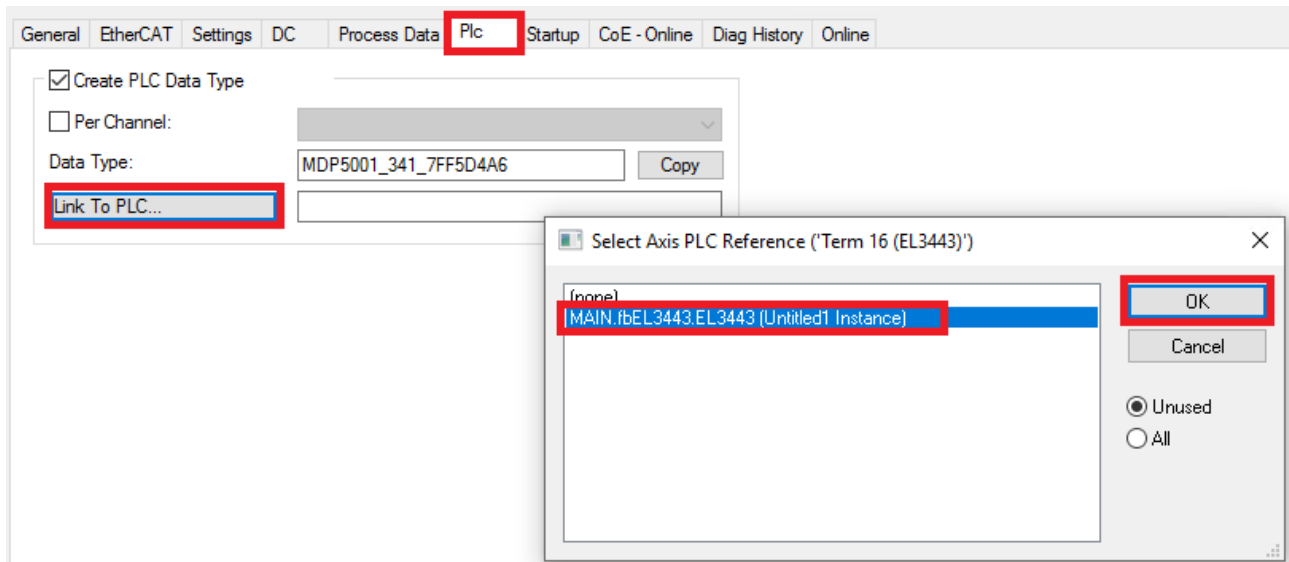

Fig. 172: Linking the structure to the hardware

- After activating and starting, all values in the overall structure must then be read out:

Expression	Type	Value	Prepared value	Address	Comment
st_autoread_EL3453	stEL3453				
Lx	ARRAY [1..3] OF st...				
Lx[1]	stEL3453_ch				
Lx[2]	stEL3453_ch				
Lx[3]	stEL3453_ch				
Total	stEL3453_tot				
fInrms	REAL	0			[A]
fIerrmsCalc	REAL	0.0405872837			[A]
fPF	REAL	0.0245103			[ ]
fFreq	REAL	49.97204			[Hz]
fUL12	REAL	0.06805244			[V]
fUL23	REAL	0.10243167			[V]
fUL31	REAL	0.0449457765			[V]
fP	REAL	0.265307069			[W]

View of the complete structure

In this example function block all variables that are present in both the PDOs and the Variant Values are read out via the PDOs, so that these values are updated every cycle. Due to the multiplexing of the values in the Variant Values, the reading of the terminal information requires several PLC cycles. Cyclic reading of all possible data from the PDOs reduces the time required for complete readout. Compared with multiplexing over several cycles, cyclical reading of the PDOs also makes it easier to detect peak values of variables. The following figure shows a scope recording of the power factor in comparison with the PDOs and the Variant Values.



Fig. 173: Comparison of the PDOs with values from the Variant Value

## 8 Appendix

### 8.1 TcEventLogger and IO

The TwinCAT 3 EventLogger provides an interface for the exchange of messages between TwinCAT components and non-TwinCAT components.

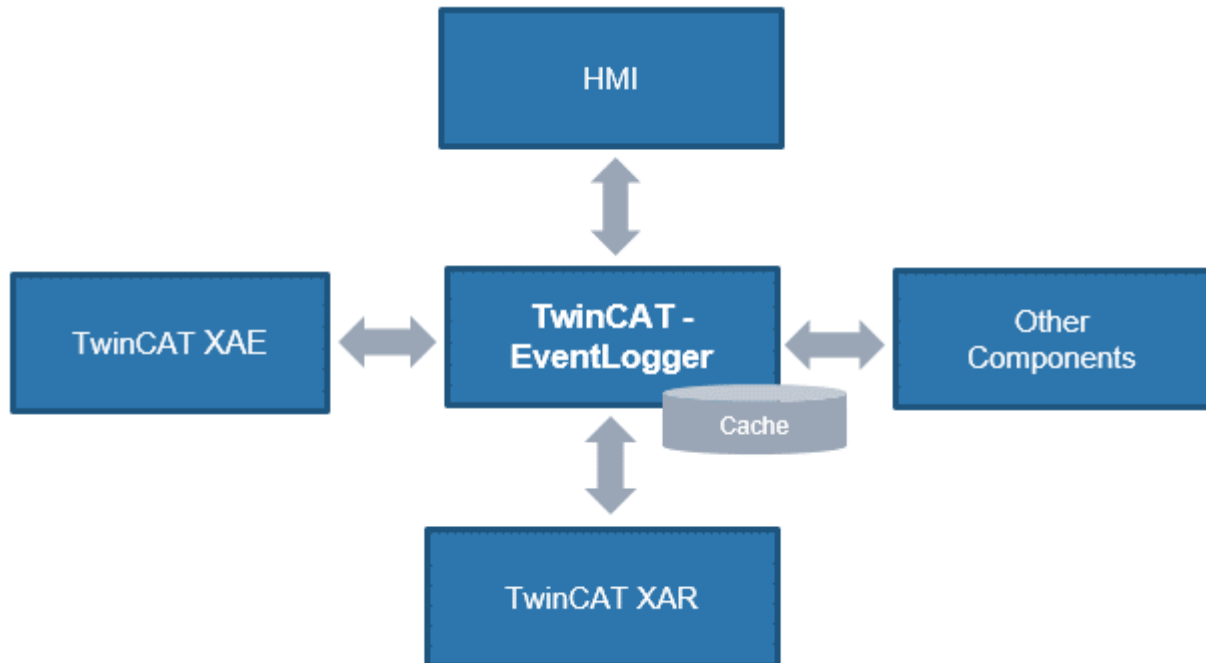

Fig. 174: Schematic representation TcEventLogger

Refer to the explanations in the TwinCAT EventLogger documentation, e.g. in the Beckhoff InfoSys <https://infosys.beckhoff.com/> → TwinCAT 3 → TE1000 XAE → Technologies → EventLogger.

The EventLogger saves to a local database under `..\TwinCAT\3.1\Boot\LoggedEvents.db` and, unlike the VisualStudio Error Window, is designed for continuous recording.

IO devices can also be a source of messages. If so-called DiagMessages are generated in the IO device, they can be collected by TwinCAT over EtherCAT and displayed in the TcEventLogger with the appropriate device setting. This facilitates the central management of events that hinder operation, as a textual diagnosis no longer needs to be programmed out in the application for each individual IO device. The messages/events can be displayed directly in the TwinCAT HMI, for example, and thus facilitate the diagnosis.

Notes:

- This feature is supported from TwinCAT 3.1 build 4022.16.
- TwinCAT may be in the RUN or CONFIG mode
- On the manufacturer side, the IO device regarded must (1) generate local DiagMessages and (2) be fundamentally capable of transmitting them as events over EtherCAT. This is not the case with all EtherCAT IO devices/terminals/box modules from Beckhoff.

The messages managed by the EventLogger can be output in or read from

- the HMI → EventGrid
- C#
- the PLC
- TwinCAT Engineering → Logged Events

The use of the EventLogger with EtherCAT IO with TwinCAT 3.1 build 4022.22 during commissioning is explained below.

- The EventLogger window may need to be displayed in the TwinCAT Engineering

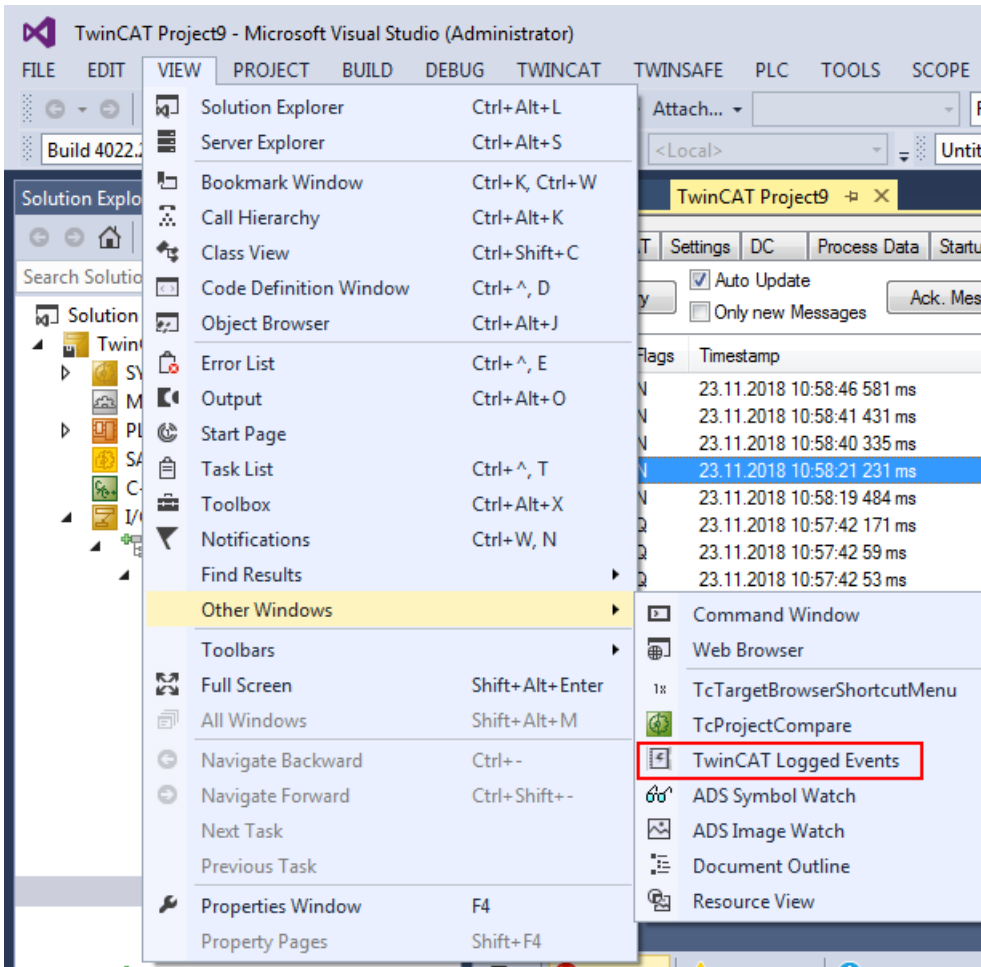

Fig. 175: Display EventLogger window

- Some DiagMessages and the resulting Logged Events are shown below, taking an ELM3602-0002 as an example



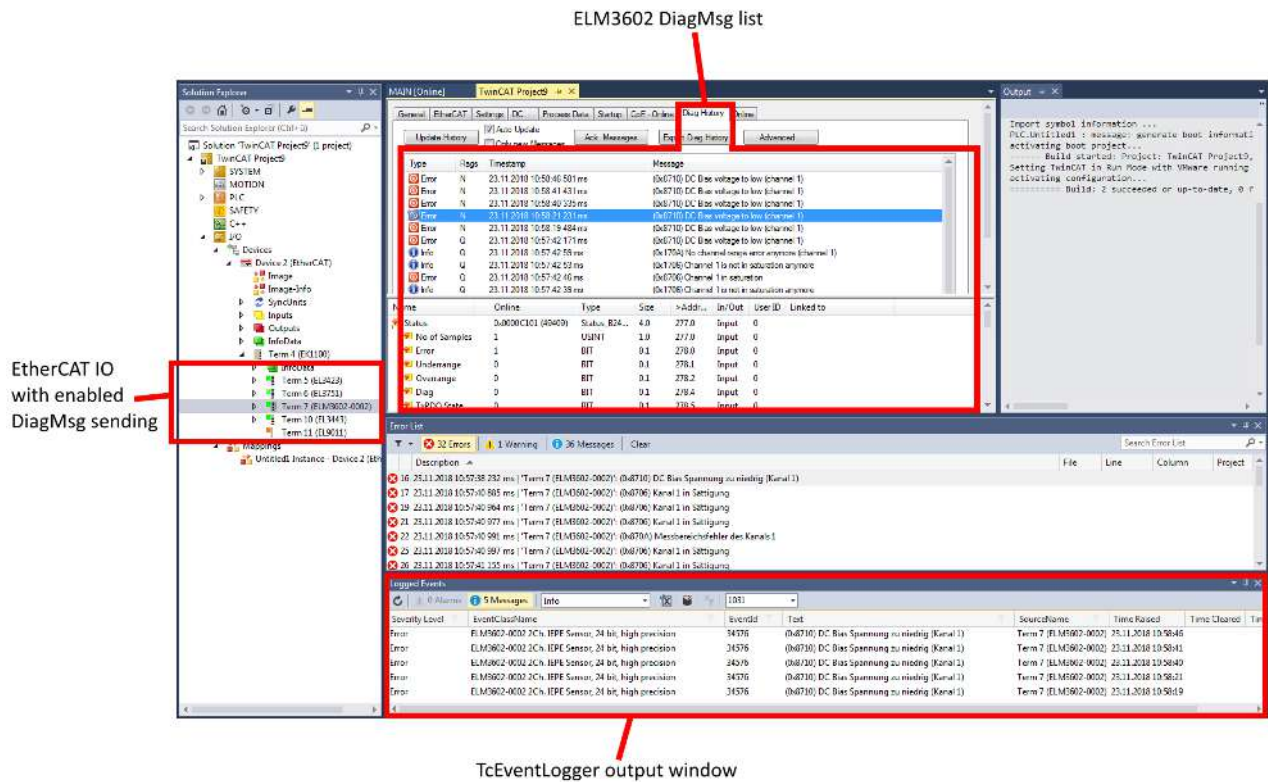

Fig. 176: Display DiagMessages and Logged Events

- Filtering by entries and language is possible in the Logger window.  
 German: 1031  
 English: 1033

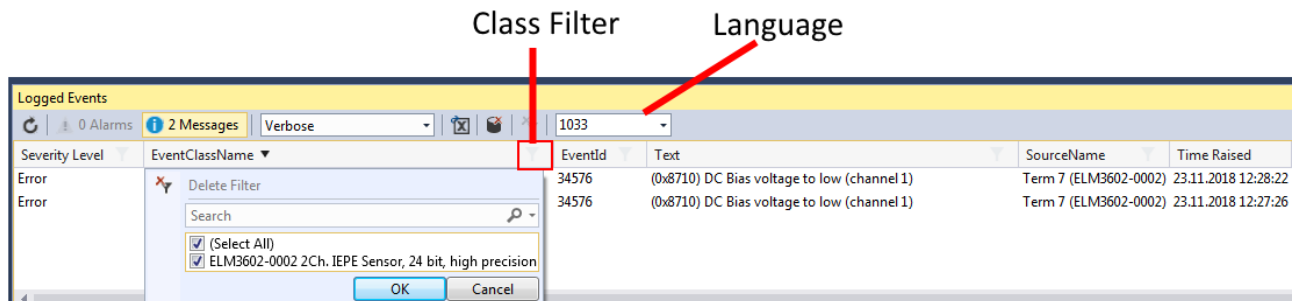

Fig. 177: Setting filter language

- If an EtherCAT slave is enabled by default to transmit DiagMessages as events over EtherCAT, this can be activated/deactivated for each individual slave in the CoE 0x10F3:05. TRUE means that the slave provides events for collection via EtherCAT, while FALSE deactivates the function.

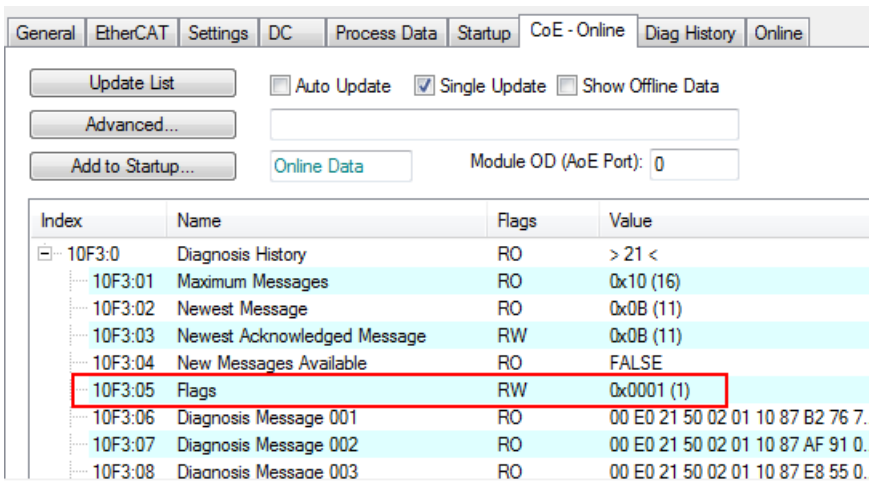

Fig. 178: Activating/deactivating event transmission

- In the respective EtherCAT slave, various "causes" can lead to it transmitting DiagMessages or events. If only some of these are to be generated, you can read in the device documentation whether and how individual causes can be deactivated, e.g. through CoE settings.
- Settings for the TwinCAT EventLogger can be found under Tools/Options

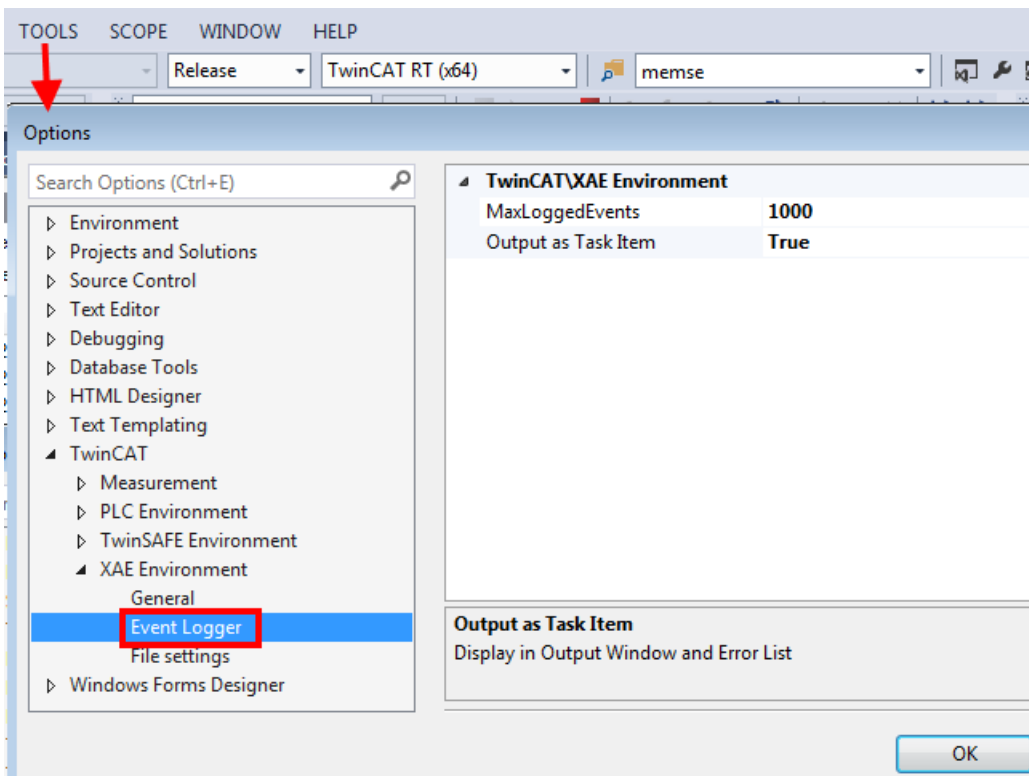

Fig. 179: Settings TwinCAT EventLogger

## 8.2 EtherCAT AL Status Codes

For detailed information please refer to the [EtherCAT system description](#).

## 8.3 Firmware compatibility

Beckhoff EtherCAT devices are delivered with the latest available firmware version. Compatibility of firmware and hardware is mandatory; not every combination ensures compatibility. The overview below shows the hardware versions on which a firmware can be operated.

### Note

- It is recommended to use the newest possible firmware for the respective hardware
- Beckhoff is not under any obligation to provide customers with free firmware updates for delivered products.

### NOTICE

#### Risk of damage to the device!

Pay attention to the instructions for firmware updates on the [separate page \[▶ 304\]](#).

If a device is placed in BOOTSTRAP mode for a firmware update, it does not check when downloading whether the new firmware is suitable.

This can result in damage to the device! Therefore, always make sure that the firmware is suitable for the hardware version!

EL3423				
Hardware (HW)	Firmware	Revision no.	Date of release	
01 - 03*	01	EL3423-0000-0016	2018/06	
	02	EL3423-0000-0017	2018/08	
	03	EL3423-0000-0018	2018/12	
	04			2019/01
			EL3423-0000-0019	2019/01
	05	EL3423-0000-0020	2019/03	
	06		2019/05	
	07	EL3423-0000-0021	2020/10	
	08		2020/12	
	09		2021/05	
	10	EL3443-0000-0022	2022/06	
	11		2022/09	
12*		2024/02		

EL3443				
Hardware (HW)	Firmware	Revision no.	Date of release	
01 - 04*	01	EL3443-0000-0016	2018/06	
	02	EL3443-0000-0017	2018/08	
	03	EL3443-0000-0018	2018/12	
	04			2019/01
			EL3443-0000-0019	2019/01
	05	EL3443-0000-0020	2019/03	
	06		2019/05	
	07	EL3443-0000-0021	2020/10	
	08		2020/12	
	09		2021/05	
	10	EL3443-0000-0022	2022/06	
	11		2022/09	
12*		2024/02		

<b>EL3443-0010</b>				
<b>Hardware (HW)</b>	<b>Firmware</b>	<b>Revision no.</b>	<b>Date of release</b>	
01 - 04*	01	EL3443-0010-0016	2018/06	
	02	EL3443-0010-0017	2018/08	
	03	EL3443-0010-0018	2018/12	
	04			2019/01
			EL3443-0010-0019	2019/01
	05	EL3443-0010-0020	2019/03	
	06		2019/05	
	07	EL3443-0010-0021	2020/10	
	08		2020/12	
	09		2021/05	
	10	EL3443-0010-0022	2022/06	
	11		2022/09	
12*		2024/02		

<b>EL3443-0011</b>			
<b>Hardware (HW)</b>	<b>Firmware</b>	<b>Revision no.</b>	<b>Date of release</b>
00 - 02*	03	EL3443-0011-0018	2018/12
	04		2019/01
			EL3443-0011-0019
	05	EL3443-0011-0020	2019/03
	06		2019/07
	07	EL3443-0011-0021	2020/10
	08		2020/12
	09		2021/05
	10	EL3443-0011-0022	2022/06
	11		2022/09
	12*		2024/02

<b>EL3443-0013</b>			
<b>Hardware (HW)</b>	<b>Firmware</b>	<b>Revision no.</b>	<b>Date of release</b>
00 - 03*	03	EL3443-0013-0018	2018/12
	04		2019/01
			EL3443-0013-0019
	05	EL3443-0013-0020	2019/03
	06		2019/07
	07	EL3443-0013-0021	2020/10
	08		2020/12
	09		2021/05
	10	EL3443-0013-0022	2022/06
	11		2022/09
	12*		2024/02

<b>EL3446</b>			
<b>Hardware (HW)</b>	<b>Firmware</b>	<b>Revision no.</b>	<b>Date of release</b>
00 - 01*	01	EL3446-0000-0016	2019/11
	02	EL3446-0000-0017	2021/02
	03		2022/03
	04		2022/06
	05*		2024/02

<b>EL3453</b>			
<b>Hardware (HW)</b>	<b>Firmware</b>	<b>Revision no.</b>	<b>Date of release</b>
00 - 01		EL3453-0000-0016	2018/07
	01	EL3453-0000-0017	2018/12
	02	EL3453-0000-0018	2019/02
01 - 07*	03		2019/05
	04	EL3453-0000-0019	2019/10
	05		2019/12
	06	EL3453-0000-0020	2019/12
	07		2020/05
	08	EL3453-0000-0021	2021/05
	09	EL3453-0000-0022	2022/02
	10		2022/08
	11		2022/10
	12*		2024/02

<b>EL3453-0100</b>			
<b>Hardware (HW)</b>	<b>Firmware</b>	<b>Revision no.</b>	<b>Date of release</b>
04 - 06*	07	EL3453-0100-0020	2020/07
	08	EL3453-0100-0021	2021/05
	09	EL3453-0100-0022	2022/02
	10		2022/08
	11		2022/10
	12*		2024/02

<b>EL3483</b>				
<b>Hardware (HW)</b>	<b>Firmware</b>	<b>Revision no.</b>	<b>Date of release</b>	
01 - 04*	01	EL3483-0000-0016	2018/06	
	02	EL3483-0000-0017	2018/08	
	03	EL3483-0000-0018	2018/12	
	04			2019/01
			EL3483-0000-0019	2019/01
	05	EL3483-0000-0020	2019/03	
	06		2019/05	
	07	EL3483-0000-0021	2020/10	
	08		2020/12	
	09		2021/05	
	10	EL3483-0000-0022	2022/06	
	11		2022/09	
12*		2024/02		

<b>EL3483-0060</b>			
<b>Hardware (HW)</b>	<b>Firmware</b>	<b>Revision no.</b>	<b>Date of release</b>
01 - 03*	06	EL3483-0060-0020	2019/05
	07	EL3483-0060-0021	2020/10
	08		2020/12
	09		2021/05
	10	EL3483-0060-0022	2022/06
	11		2022/09
	12*		2024/02

\*) This is the current compatible firmware/hardware version at the time of the preparing this documentation. Check on the Beckhoff web page whether more up-to-date [documentation](#) is available.

## 8.4 Firmware Update EL/ES/EM/ELM/EP/EPP/ERPxxxx

This section describes the device update for Beckhoff EtherCAT slaves from the EL/ES, ELM, EM, EK, EP, EPP and ERP series. A firmware update should only be carried out after consultation with Beckhoff support.

### NOTICE

#### Only use TwinCAT 3 software!

A firmware update of Beckhoff IO devices must only be performed with a TwinCAT 3 installation. It is recommended to build as up-to-date as possible, available for free download on the [Beckhoff website](#).

To update the firmware, TwinCAT can be operated in the so-called FreeRun mode, a paid license is not required.

The device to be updated can usually remain in the installation location, but TwinCAT has to be operated in the FreeRun. Please make sure that EtherCAT communication is trouble-free (no LostFrames etc.).

Other EtherCAT master software, such as the EtherCAT Configurator, should not be used, as they may not support the complexities of updating firmware, EEPROM and other device components.

### Storage locations

An EtherCAT slave stores operating data in up to three locations:

- Each EtherCAT slave has a device description, consisting of identity (name, product code), timing specifications, communication settings, etc.  
This device description (ESI; EtherCAT Slave Information) can be downloaded from the Beckhoff website in the download area as a [zip file](#) and used in EtherCAT masters for offline configuration, e.g. in TwinCAT.  
Above all, each EtherCAT slave carries its device description (ESI) electronically readable in a local memory chip, the so-called **ESI EEPROM**. When the slave is switched on, this description is loaded locally in the slave and informs it of its communication configuration; on the other hand, the EtherCAT master can identify the slave in this way and, among other things, set up the EtherCAT communication accordingly.

### NOTICE

#### Application-specific writing of the ESI-EEPROM

The ESI is developed by the device manufacturer according to ETG standard and released for the corresponding product.

- Meaning for the ESI file: Modification on the application side (i.e. by the user) is not permitted.
- Meaning for the ESI EEPROM: Even if a writeability is technically given, the ESI parts in the EEPROM and possibly still existing free memory areas must not be changed beyond the normal update process. Especially for cyclic memory processes (operating hours counter etc.), dedicated memory products such as EL6080 or IPC's own NOVDRAM must be used.

- Depending on functionality and performance EtherCAT slaves have one or several local controllers for processing I/O data. The corresponding program is the so-called **firmware** in \*.efw format.
- In some EtherCAT slaves the EtherCAT communication may also be integrated in these controllers. In this case the controller is usually a so-called **FPGA** chip with \*.rbf firmware.

Customers can access the data via the EtherCAT fieldbus and its communication mechanisms. Acyclic mailbox communication or register access to the ESC is used for updating or reading of these data.

The TwinCAT System Manager offers mechanisms for programming all three parts with new data, if the slave is set up for this purpose. Generally the slave does not check whether the new data are suitable, i.e. it may no longer be able to operate if the data are unsuitable.

### Simplified update by bundle firmware

The update using so-called **bundle firmware** is more convenient: in this case the controller firmware and the ESI description are combined in a \*.efw file; during the update both the firmware and the ESI are changed in the terminal. For this to happen it is necessary

- for the firmware to be in a packed format: recognizable by the file name, which also contains the revision number, e.g. ELxxxx-xxxx\_REV0016\_SW01.efw



- for password=1 to be entered in the download dialog. If password=0 (default setting) only the firmware update is carried out, without an ESI update.
- for the device to support this function. The function usually cannot be retrofitted; it is a component of many new developments from year of manufacture 2016.

Following the update, its success should be verified

- ESI/Revision: e.g. by means of an online scan in TwinCAT ConfigMode/FreeRun – this is a convenient way to determine the revision
- Firmware: e.g. by looking in the online CoE of the device

**NOTICE**

**Risk of damage to the device!**

- ✓ Note the following when downloading new device files
  - a) Firmware downloads to an EtherCAT device must not be interrupted
  - b) Flawless EtherCAT communication must be ensured. CRC errors or LostFrames must be avoided.
  - c) The power supply must adequately dimensioned. The signal level must meet the specification.
- ⇒ In the event of malfunctions during the update process the EtherCAT device may become unusable and require re-commissioning by the manufacturer.

### 8.4.1 Device description ESI file/XML

**NOTICE**

**Attention regarding update of the ESI description/EEPROM**

Some slaves have stored calibration and configuration data from the production in the EEPROM. These are irretrievably overwritten during an update.

The ESI device description is stored locally on the slave and loaded on start-up. Each device description has a unique identifier consisting of slave name (9 characters/digits) and a revision number (4 digits). Each slave configured in the System Manager shows its identifier in the EtherCAT tab:

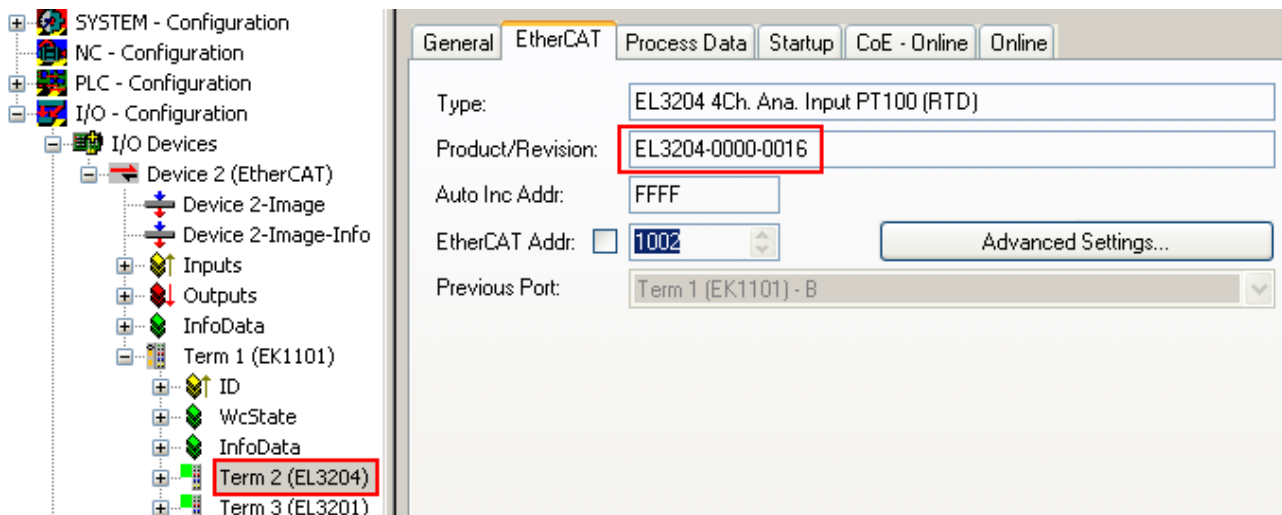

Fig. 180: Device identifier consisting of name EL3204-0000 and revision -0016

The configured identifier must be compatible with the actual device description used as hardware, i.e. the description which the slave has loaded on start-up (in this case EL3204). Normally the configured revision must be the same or lower than that actually present in the terminal network.

For further information on this, please refer to the [EtherCAT system documentation](#).

## **i** Update of XML/ESI description

The device revision is closely linked to the firmware and hardware used. Incompatible combinations lead to malfunctions or even final shutdown of the device. Corresponding updates should only be carried out in consultation with Beckhoff support.

### Display of ESI slave identifier

The simplest way to ascertain compliance of configured and actual device description is to scan the EtherCAT boxes in TwinCAT mode Config/FreeRun:

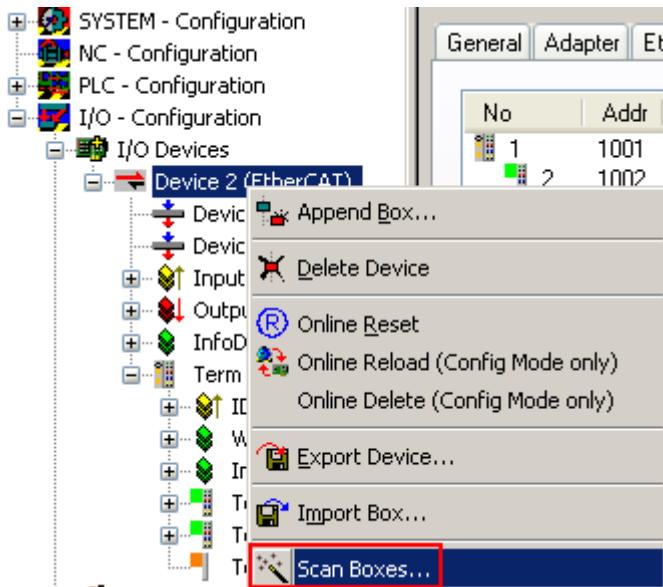

Fig. 181: Scan the subordinate field by right-clicking on the EtherCAT device

If the found field matches the configured field, the display shows



Fig. 182: Configuration is identical

otherwise a change dialog appears for entering the actual data in the configuration.

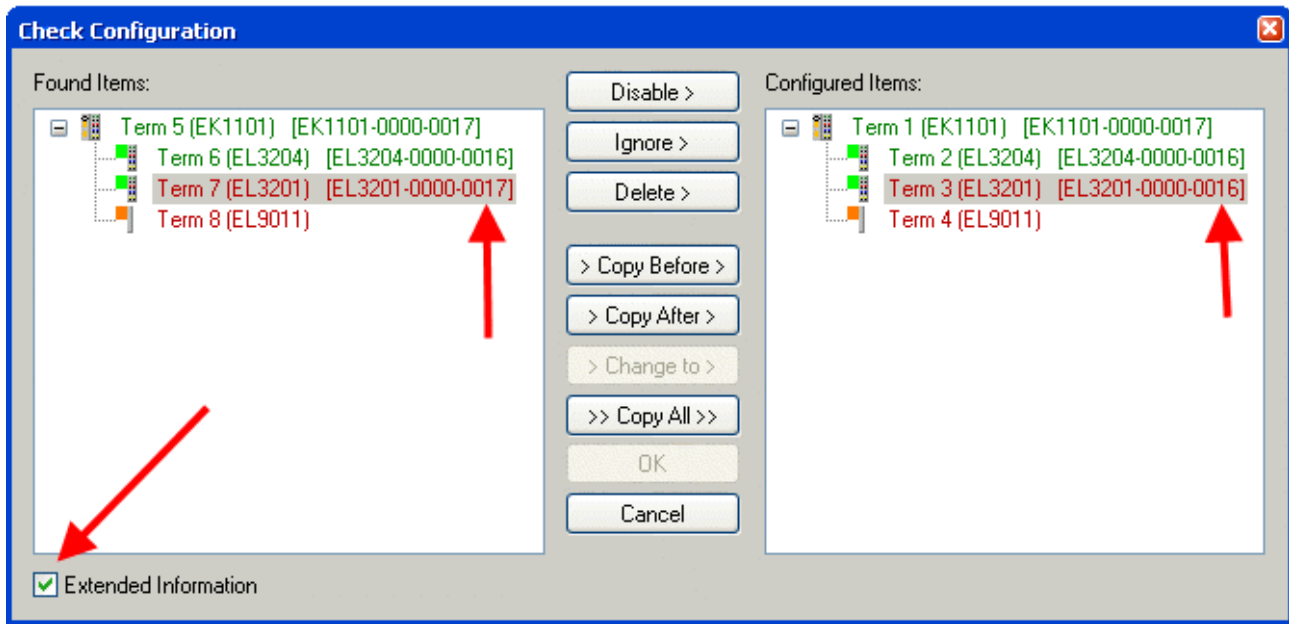

Fig. 183: Change dialog

In this example in Fig. *Change dialog*, an EL3201-0000-0017 was found, while an EL3201-0000-0016 was configured. In this case the configuration can be adapted with the *Copy Before* button. The *Extended Information* checkbox must be set in order to display the revision.

**Changing the ESI slave identifier**

The ESI/EEPROM identifier can be updated as follows under TwinCAT:

- Trouble-free EtherCAT communication must be established with the slave.
- The state of the slave is irrelevant.
- Right-clicking on the slave in the online display opens the *EEPROM Update* dialog, Fig. *EEPROM Update*

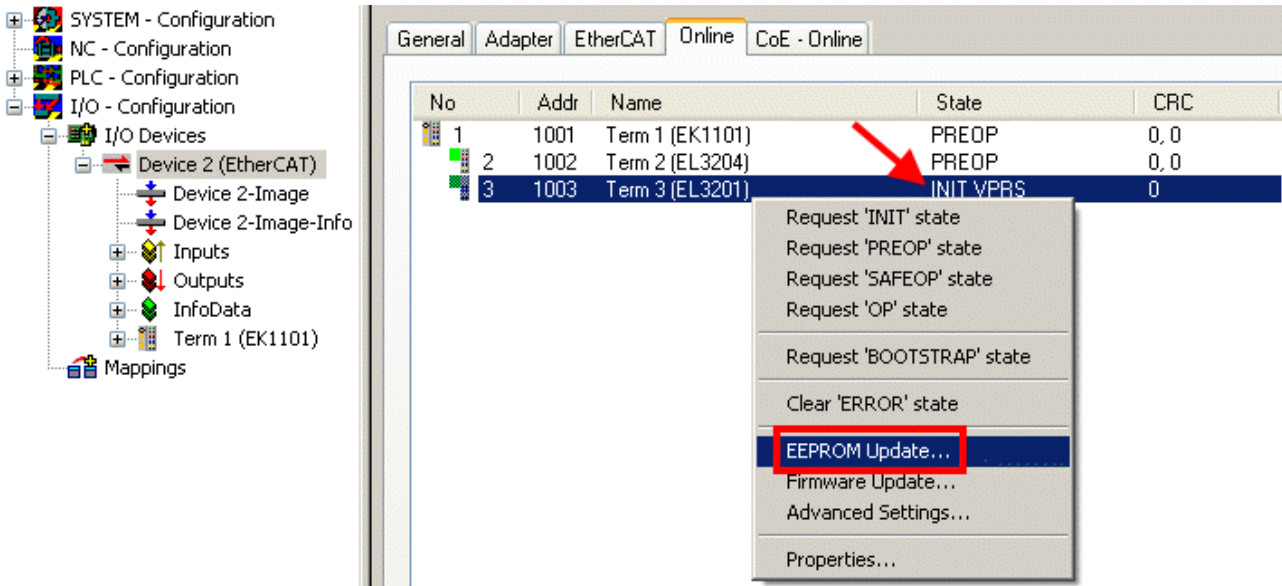

Fig. 184: EEPROM Update

The new ESI description is selected in the following dialog, see Fig. *Selecting the new ESI*. The checkbox *Show Hidden Devices* also displays older, normally hidden versions of a slave.

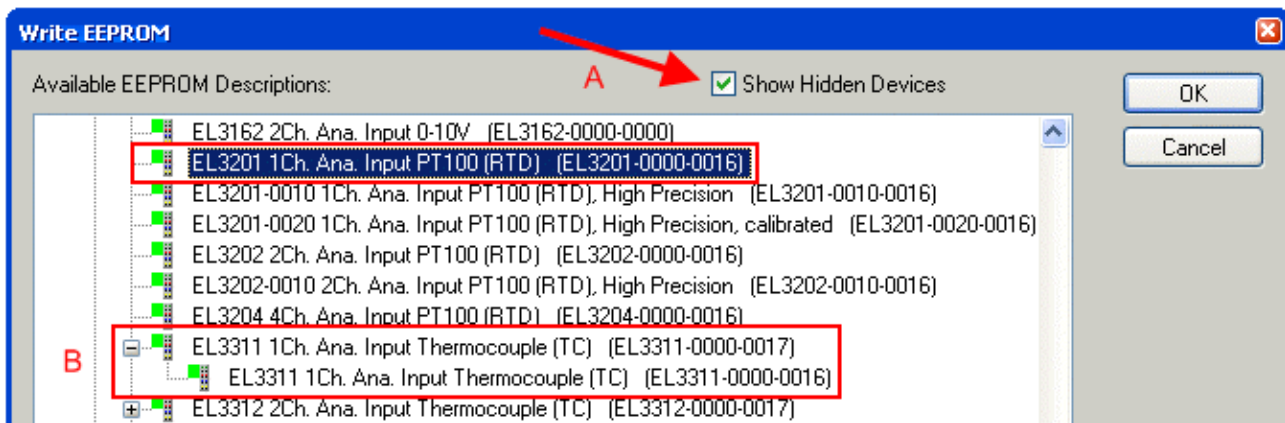

Fig. 185: Selecting the new ESI

A progress bar in the System Manager shows the progress. Data are first written, then verified.

**i** **The change only takes effect after a restart.**

Most EtherCAT devices read a modified ESI description immediately or after startup from the INIT. Some communication settings such as distributed clocks are only read during power-on. The EtherCAT slave therefore has to be switched off briefly in order for the change to take effect.

## 8.4.2 Firmware explanation

### Determining the firmware version

#### Determining the version via the System Manager

The TwinCAT System Manager shows the version of the controller firmware if the master can access the slave online. Click on the E-Bus Terminal whose controller firmware you want to check (in the example terminal 2 (EL3204)) and select the tab *CoE Online* (CAN over EtherCAT).

**i** **CoE Online and Offline CoE**

Two CoE directories are available:

- **online:** This is offered in the EtherCAT slave by the controller, if the EtherCAT slave supports this. This CoE directory can only be displayed if a slave is connected and operational.
- **offline:** The EtherCAT Slave Information ESI/XML may contain the default content of the CoE. This CoE directory can only be displayed if it is included in the ESI (e.g. "Beckhoff EL5xxx.xml").

The Advanced button must be used for switching between the two views.

In Fig. *Display of EL3204 firmware version* the firmware version of the selected EL3204 is shown as 03 in CoE entry 0x100A.

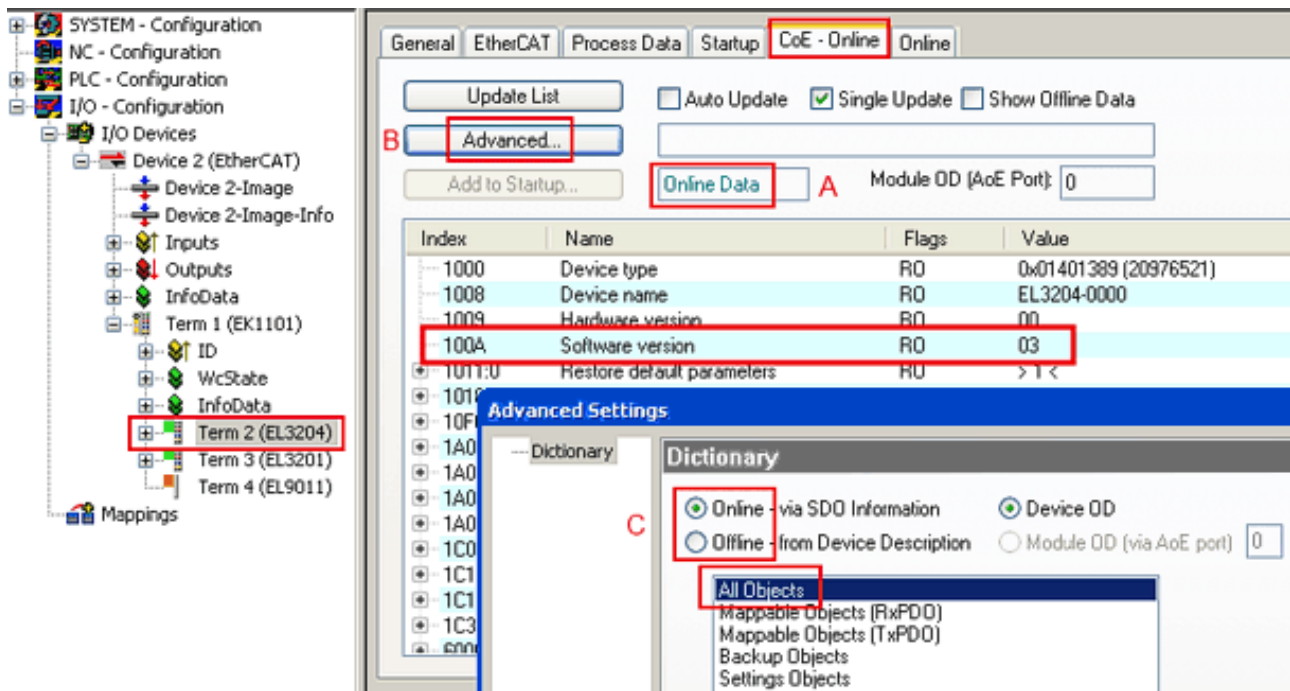

Fig. 186: Display of EL3204 firmware version

In (A) TwinCAT 2.11 shows that the Online CoE directory is currently displayed. If this is not the case, the Online directory can be loaded via the *Online* option in Advanced Settings (B) and double-clicking on *AllObjects*.

### 8.4.3 Updating controller firmware \*.efw

#### ● CoE directory

**i** The Online CoE directory is managed by the controller and stored in a dedicated EEPROM, which is generally not changed during a firmware update.

Switch to the *Online* tab to update the controller firmware of a slave, see Fig. *Firmware Update*.

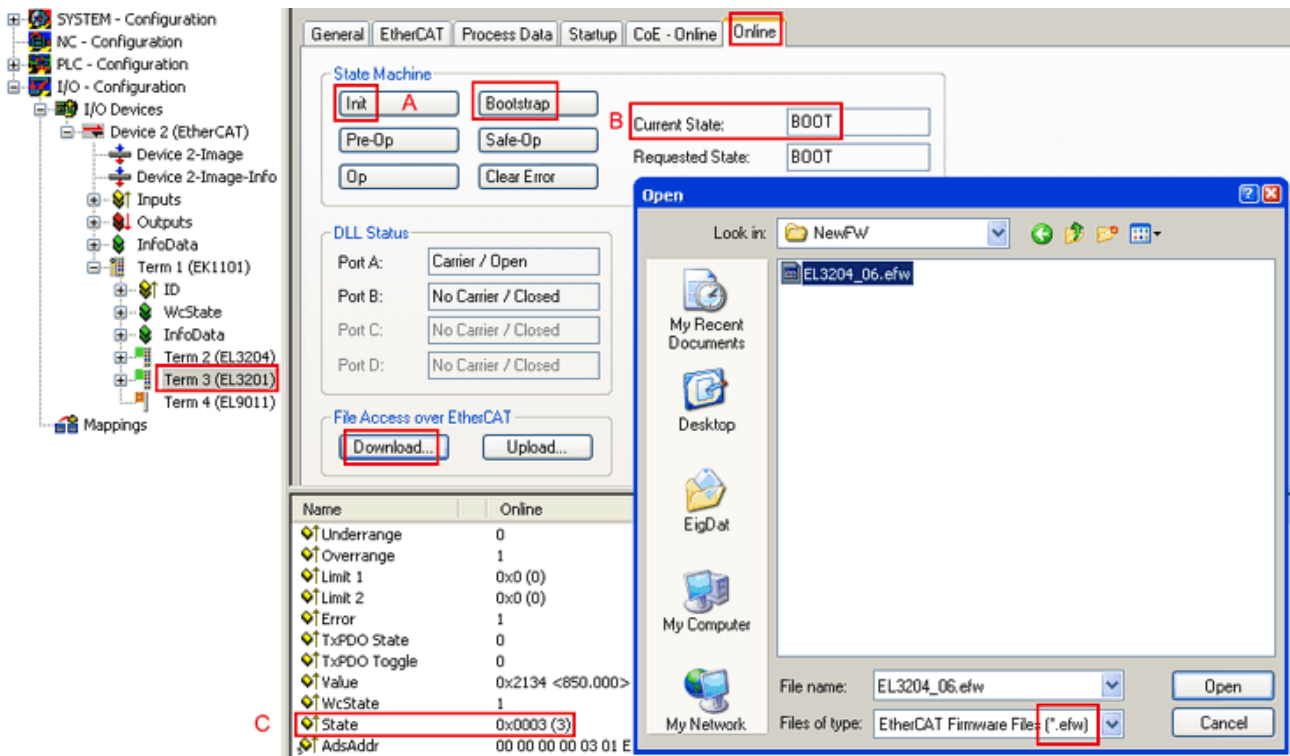
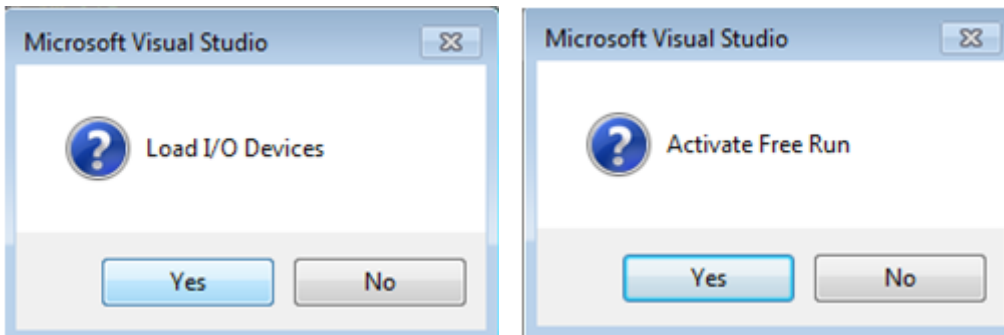

Fig. 187: Firmware Update

Proceed as follows, unless instructed otherwise by Beckhoff support. Valid for TwinCAT 2 and 3 as EtherCAT master.

- Switch TwinCAT system to ConfigMode/FreeRun with cycle time  $\geq 1$  ms (default in ConfigMode is 4 ms). A FW-Update during real time operation is not recommended.



- Switch EtherCAT Master to PreOP

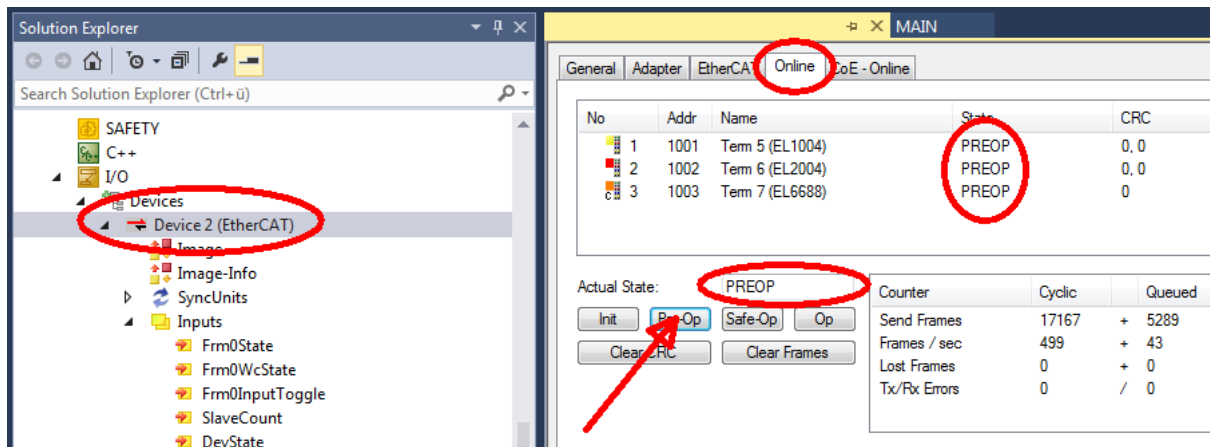

- Switch slave to INIT (A)
- Switch slave to BOOTSTRAP

- Check the current status (B, C)
- Download the new \*efw file (wait until it ends). A password will not be necessary usually.

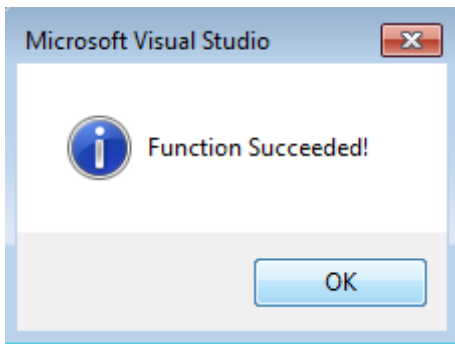

- After the download switch to INIT, then PreOP
- Switch off the slave briefly (don't pull under voltage!)
- Check within CoE 0x100A, if the FW status was correctly overtaken.

#### 8.4.4 FPGA firmware \*.rbf

If an FPGA chip deals with the EtherCAT communication an update may be accomplished via an \*.rbf file.

- Controller firmware for processing I/O signals
- FPGA firmware for EtherCAT communication (only for terminals with FPGA)

The firmware version number included in the terminal serial number contains both firmware components. If one of these firmware components is modified this version number is updated.

##### Determining the version via the System Manager

The TwinCAT System Manager indicates the FPGA firmware version. Click on the Ethernet card of your EtherCAT strand (Device 2 in the example) and select the *Online* tab.

The *Reg:0002* column indicates the firmware version of the individual EtherCAT devices in hexadecimal and decimal representation.

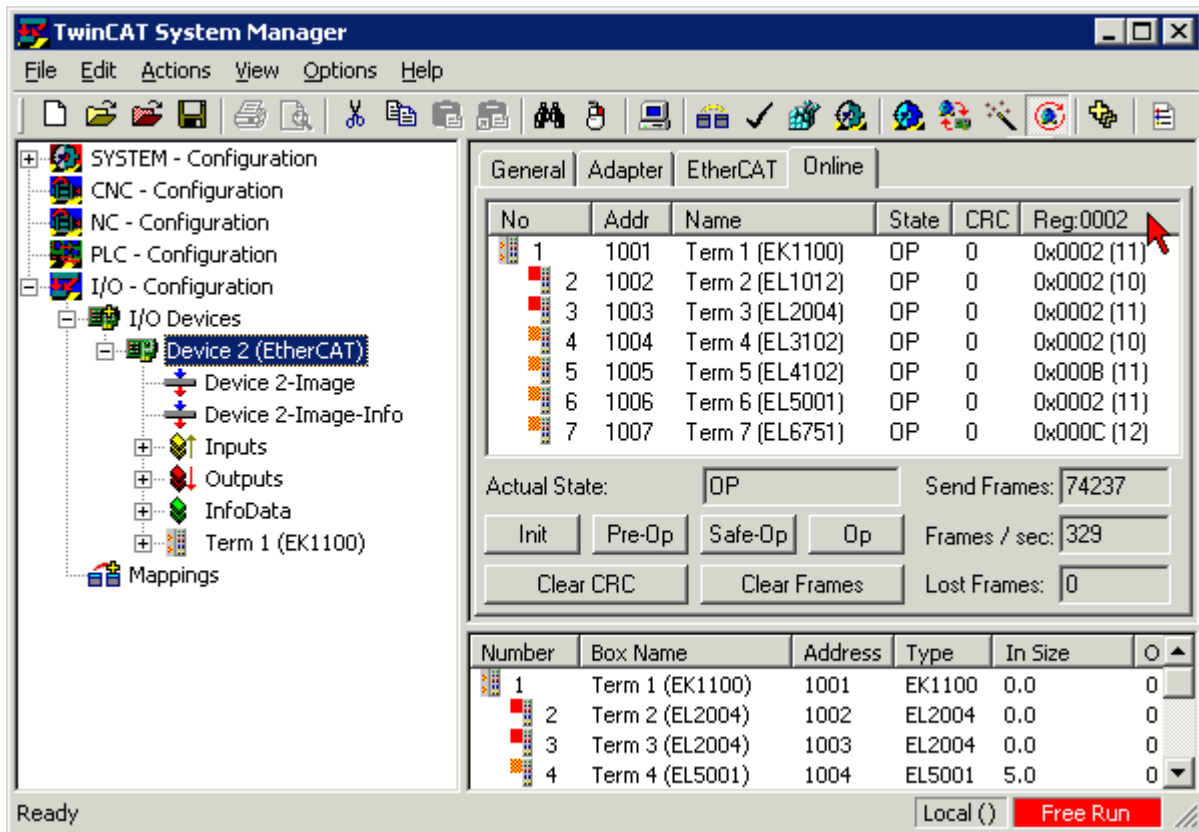

Fig. 188: FPGA firmware version definition

If the column *Reg:0002* is not displayed, right-click the table header and select *Properties* in the context menu.

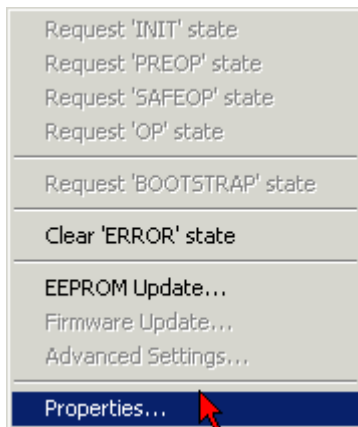

Fig. 189: Context menu *Properties*

The *Advanced Settings* dialog appears where the columns to be displayed can be selected. Under *Diagnosis/Online View* select the *'0002 ETxxxx Build'* check box in order to activate the FPGA firmware version display.



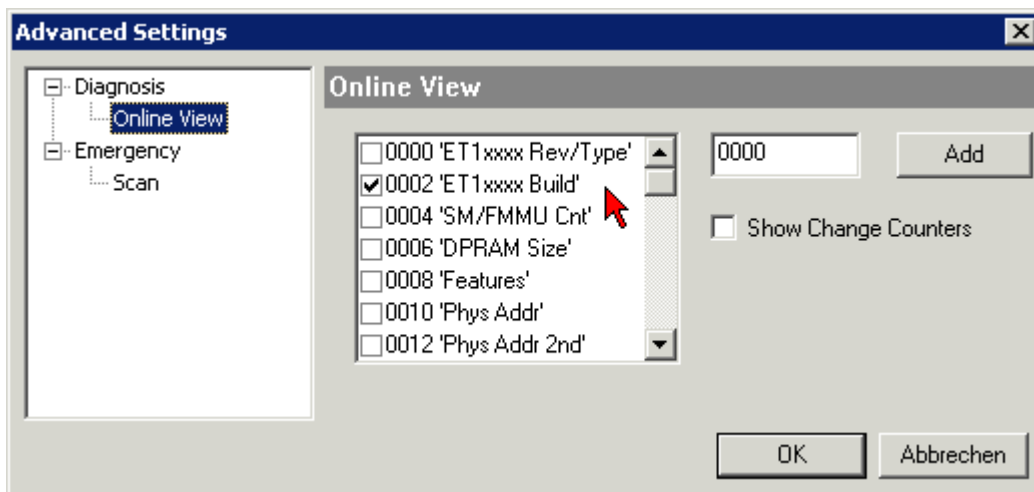

Fig. 190: Dialog *Advanced Settings*

### Update

For updating the FPGA firmware

- of an EtherCAT coupler the coupler must have FPGA firmware version 11 or higher;
- of an E-Bus Terminal the terminal must have FPGA firmware version 10 or higher.

Older firmware versions can only be updated by the manufacturer!

### Updating an EtherCAT device

The following sequence order have to be met if no other specifications are given (e.g. by the Beckhoff support):

- Switch TwinCAT system to ConfigMode/FreeRun with cycle time  $\geq 1$  ms (default in ConfigMode is 4 ms). A FW-Update during real time operation is not recommended.

- In the TwinCAT System Manager select the terminal for which the FPGA firmware is to be updated (in the example: Terminal 5: EL5001) and click the *Advanced Settings* button in the *EtherCAT* tab:

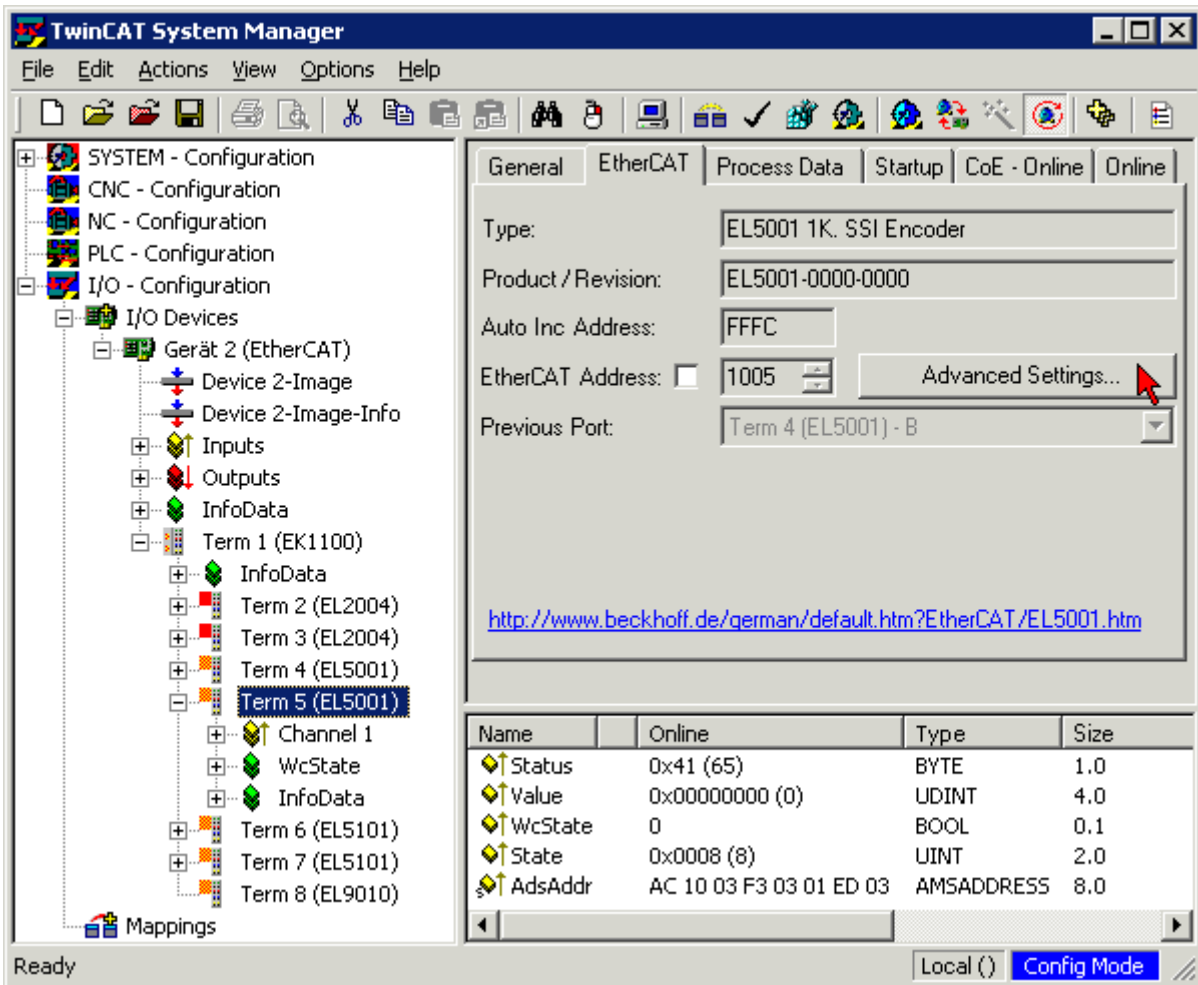

- The *Advanced Settings* dialog appears. Under *ESC Access/E<sup>2</sup>PROM/FPGA* click on *Write FPGA* button:

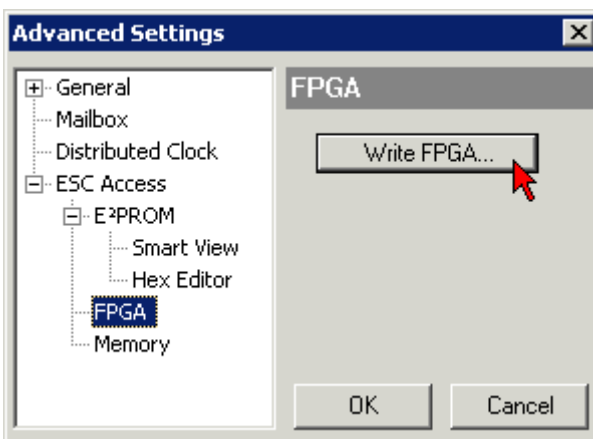

- Select the file (\*.rbf) with the new FPGA firmware, and transfer it to the EtherCAT device:

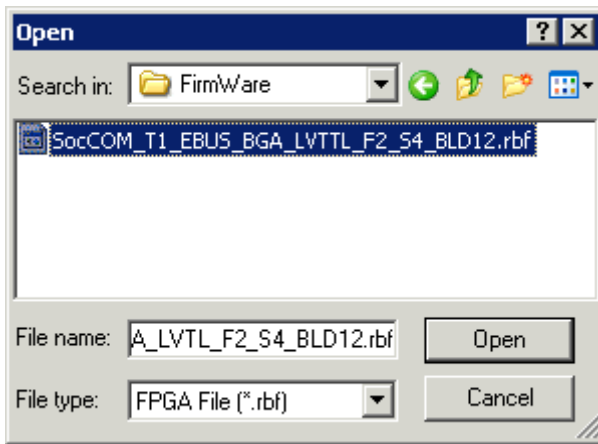

- Wait until download ends
- Switch slave current less for a short time (don't pull under voltage!). In order to activate the new FPGA firmware a restart (switching the power supply off and on again) of the EtherCAT device is required.
- Check the new FPGA status

**NOTICE**

**Risk of damage to the device!**

A download of firmware to an EtherCAT device must not be interrupted in any case! If you interrupt this process by switching off power supply or disconnecting the Ethernet link, the EtherCAT device can only be recommissioned by the manufacturer!

### 8.4.5 Simultaneous updating of several EtherCAT devices

The firmware and ESI descriptions of several devices can be updated simultaneously, provided the devices have the same firmware file/ESI.

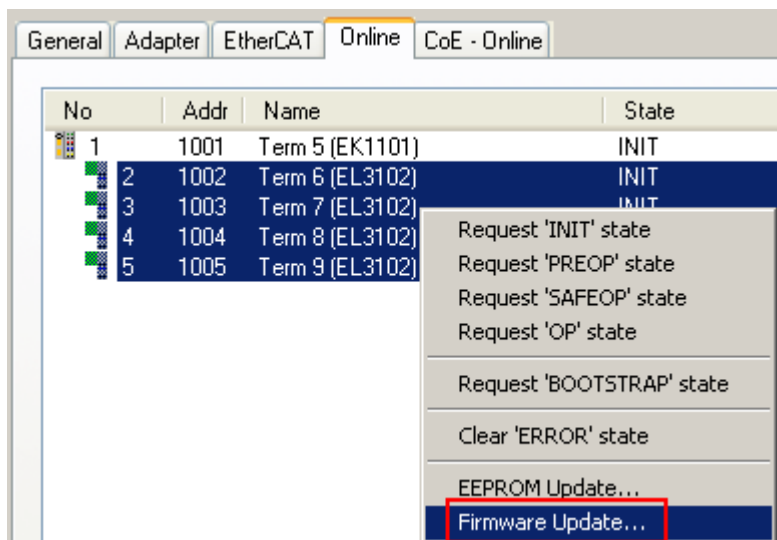

Fig. 191: Multiple selection and firmware update

Select the required slaves and carry out the firmware update in BOOTSTRAP mode as described above.

## 8.5 Restoring the delivery state

To restore the delivery state (factory settings) of CoE objects for EtherCAT devices (“slaves”), the CoE object *Restore default parameters*, SubIndex 001 can be used via EtherCAT master (e.g. TwinCAT) (see Fig. *Selecting the Restore default parameters PDO*).

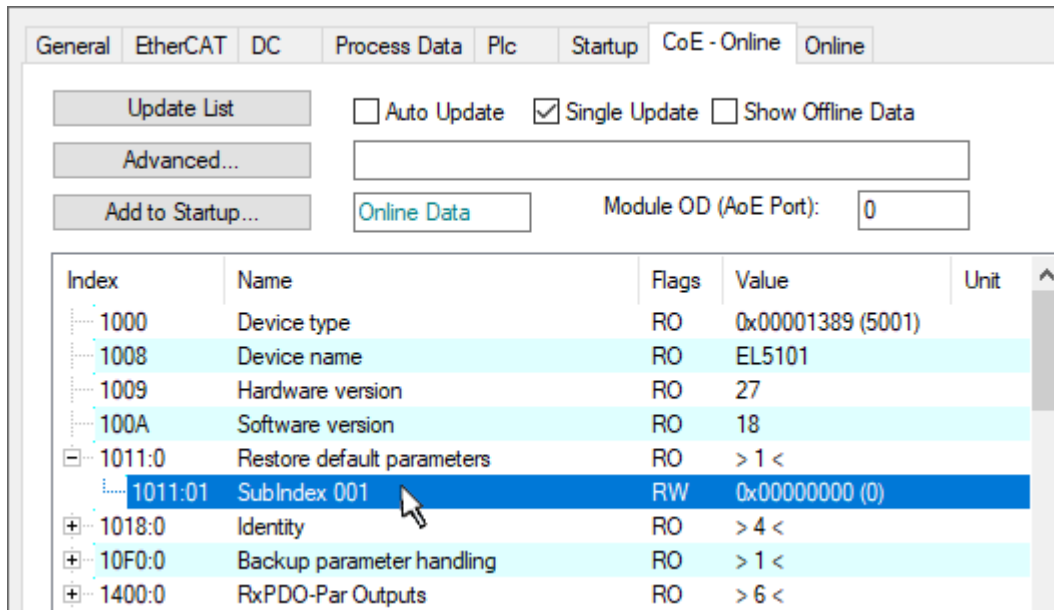

Fig. 192: Selecting the *Restore default parameters* PDO

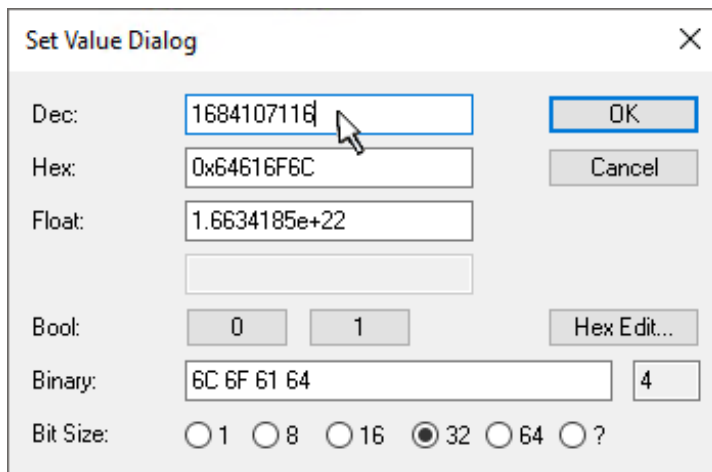

Fig. 193: Entering a restore value in the Set Value dialog

Double-click on *SubIndex 001* to enter the Set Value dialog. Enter the reset value **1684107116** in field *Dec* or the value **0x64616F6C** in field *Hex* (ASCII: “load”) and confirm with *OK* (Fig. *Entering a restore value in the Set Value dialog*).

- All changeable entries in the slave are reset to the default values.
- The values can only be successfully restored if the reset is directly applied to the online CoE, i.e. to the slave. No values can be changed in the offline CoE.
- TwinCAT must be in the RUN or CONFIG/Freerun state for this; that means EtherCAT data exchange takes place. Ensure error-free EtherCAT transmission.
- No separate confirmation takes place due to the reset. A changeable object can be manipulated beforehand for the purposes of checking.
- This reset procedure can also be adopted as the first entry in the startup list of the slave, e.g. in the state transition PREOP->SAFEOP or, as in Fig. *CoE reset as a startup entry*, in SAFEOP->OP.

All backup objects are reset to the delivery state.

**i** **Alternative restore value**

In some older terminals (FW creation approx. before 2007) the backup objects can be switched with an alternative restore value: Decimal value: 1819238756, Hexadecimal value: 0x6C6F6164.

An incorrect entry for the restore value has no effect.

---

## 8.6 Support and Service

Beckhoff and their partners around the world offer comprehensive support and service, making available fast and competent assistance with all questions related to Beckhoff products and system solutions.

### Beckhoff's branch offices and representatives

Please contact your Beckhoff branch office or representative for local support and service on Beckhoff products!

The addresses of Beckhoff's branch offices and representatives round the world can be found on her internet pages: [www.beckhoff.com](http://www.beckhoff.com)

You will also find further documentation for Beckhoff components there.

### Support

The Beckhoff Support offers you comprehensive technical assistance, helping you not only with the application of individual Beckhoff products, but also with other, wide-ranging services:

- support
- design, programming and commissioning of complex automation systems
- and extensive training program for Beckhoff system components

Hotline: +49 5246 963 157  
e-mail: [support@beckhoff.com](mailto:support@beckhoff.com)  
web: [www.beckhoff.com/support](http://www.beckhoff.com/support)

### Service

The Beckhoff Service Center supports you in all matters of after-sales service:

- on-site service
- repair service
- spare parts service
- hotline service

Hotline: +49 5246 963 460  
e-mail: [service@beckhoff.com](mailto:service@beckhoff.com)  
web: [www.beckhoff.com/service](http://www.beckhoff.com/service)

### Headquarters Germany

Beckhoff Automation GmbH & Co. KG

Hülshorstweg 20  
33415 Verl  
Germany

Phone: +49 5246 963 0  
e-mail: [info@beckhoff.com](mailto:info@beckhoff.com)  
web: [www.beckhoff.com](http://www.beckhoff.com)



More Information:  
[www.beckhoff.com/EL3xxx](http://www.beckhoff.com/EL3xxx)

Beckhoff Automation GmbH & Co. KG  
Hülshorstweg 20  
33415 Verl  
Germany  
Phone: +49 5246 9630  
[info@beckhoff.com](mailto:info@beckhoff.com)  
[www.beckhoff.com](http://www.beckhoff.com)

