

# BECKHOFF New Automation Technology

Short documentation | EN

## EL3751

1-channel multi-functional input for measurement technology, 24 bit, 10 kbps





# Table of contents

<b>1</b>	<b>Foreword</b> .....	<b>7</b>
1.1	Notes on the documentation .....	7
1.2	Safety instructions .....	8
1.3	Documentation Issue Status .....	9
1.4	Guide through documentation .....	10
1.5	Version identification of EtherCAT devices .....	11
1.5.1	General notes on marking.....	11
1.5.2	Version identification of EL terminals.....	11
1.5.3	Beckhoff Identification Code (BIC).....	12
1.5.4	Electronic access to the BIC (eBIC).....	13
1.5.5	BIC within CoE of EL3751.....	16
<b>2</b>	<b>Product overview</b> .....	<b>17</b>
2.1	Description .....	17
2.2	Technical data.....	18
2.2.1	Common technical data .....	18
2.2.2	Process data interpretation .....	20
2.2.3	General Information on Measuring Accuracy/Measurement Uncertainty.....	22
2.2.4	Measurement $\pm 30$ V.....	26
2.2.5	Measurement $\pm 10$ V.....	28
2.2.6	Measurement $\pm 5$ V.....	30
2.2.7	Measurement $\pm 2.5$ V.....	32
2.2.8	Measurement $\pm 1.25$ V.....	34
2.2.9	Measurement $\pm 640$ mV.....	36
2.2.10	Measurement $\pm 320$ mV.....	38
2.2.11	Measurement $\pm 160$ mV.....	40
2.2.12	Measurement $\pm 80$ mV.....	42
2.2.13	Measurement $\pm 40$ mV.....	44
2.2.14	Measurement $\pm 20$ mV.....	46
2.2.15	Measurement $\pm 10$ mV.....	48
2.2.16	Measurement $\pm 5$ mV.....	50
2.2.17	Measurement 0...5 V.....	52
2.2.18	Measurement 0...10 V.....	54
2.2.19	Measurement $\pm 20$ mA.....	56
2.2.20	Measurement 0...20 mA.....	58
2.2.21	Measurement 4...20 mA.....	60
2.2.22	Measurement 3.6...21 mA (NAMUR NE43).....	63
2.2.23	Measurement resistance 0...5 k $\Omega$ .....	65
2.2.24	RTD measurement.....	69
2.2.25	Potentiometer measurement.....	72
2.2.26	Measurement SG 1/1 bridge (full bridge) 4/6-wire connection.....	74
2.2.27	Measurement SG 1/2 bridge (half bridge) 3/5-wire connection.....	79
2.2.28	Measurement SG 1/4 bridge (quarter bridge) 120 $\Omega$ 2/3-wire connection .....	85
2.2.29	Measurement SG 1/4 bridge (quarter bridge) 350 $\Omega$ 2/3-wire connection .....	89
<b>3</b>	<b>Commissioning</b> .....	<b>93</b>

3.1	Notes to short documentation .....	93
3.2	CoE overview .....	94
3.2.1	0x6000 PAI Status Ch.1 .....	94
3.2.2	0x6001 PAI Samples Ch.1 .....	94
3.2.3	0x6002 PAI Synchronous Oversampling Ch.1 .....	94
3.2.4	0x7000 PAI Control Ch.1 .....	94
3.2.5	0x8000 PAI Settings Ch.1 .....	95
3.2.6	0x8001 PAI Filter 1 Settings Ch.1 .....	97
3.2.7	0x8003 PAI Filter 2 Settings Ch.1 .....	97
3.2.8	0x8005 Scaler Settings Ch.1 .....	97
3.2.9	0x800E PAI User Calibration Data Ch.1 .....	98
3.2.10	0x800F PAI Vendor Calibration Data Ch.1 .....	98
3.2.11	0x9000 PAI Internal Data Ch.1 .....	99
3.2.12	0x900F PAI Calibration Dates Ch.1 .....	101
3.2.13	0xF000 Modular device profile .....	103
3.2.14	0xF008 Code word .....	103
3.2.15	0xF009 Password Protection .....	103
3.2.16	0xF010 Module list .....	103
3.2.17	0xF600 PAI Timestamp .....	103
3.2.18	0xF900 PAI Info Data .....	104
3.2.19	0xF912 filter info .....	104
3.2.20	0xFB00 PAI Command .....	104
3.3	Sample programs .....	105
3.3.1	Sample program 1 and 2 (offset/gain) .....	107
3.3.2	Sample program 3 (write LookUp table) .....	113
3.3.3	Sample program 4 (generate LookUp table) .....	114
3.3.4	Sample program 5 (write filter coefficients) .....	116
3.3.5	Sample program 6 (interlacing of measured values) .....	118
3.3.6	Sample program 7 (general decimation in the PLC) .....	123
3.3.7	Sample program 8 (FB for real time diagnosis) .....	128
3.3.8	Sample program 9 (R/W signature of calibration) .....	131
<b>4</b>	<b>EL3751 Features .....</b>	<b>133</b>
<b>5</b>	<b>Commissioning on EtherCAT Master .....</b>	<b>134</b>
5.1	General Commissioning Instructions for an EtherCAT Slave .....	134
5.2	TwinCAT Quick Start .....	142
5.2.1	TwinCAT 2 .....	144
5.2.2	TwinCAT 3 .....	154
5.3	TwinCAT Development Environment .....	167
5.3.1	Installation of the TwinCAT real-time driver .....	168
5.3.2	Notes regarding ESI device description .....	174
5.3.3	TwinCAT ESI Updater .....	178
5.3.4	Distinction between Online and Offline .....	178
5.3.5	OFFLINE configuration creation .....	179
5.3.6	ONLINE configuration creation .....	184
5.3.7	EtherCAT subscriber configuration .....	192



5.3.8	Import/Export of EtherCAT devices with SCI and XTI.....	201
5.4	EtherCAT basics .....	207
5.5	EtherCAT cabling – wire-bound .....	207
5.6	General notes for setting the watchdog .....	208
5.7	EtherCAT State Machine .....	210
5.8	CoE Interface .....	212
5.9	Distributed Clock .....	217
<b>6</b>	<b>Mounting and wiring .....</b>	<b>218</b>
6.1	Installation positions .....	218
6.2	Positioning of passive Terminals.....	219
6.3	ATEX - Special conditions (standard temperature range).....	221
6.4	Notes regarding connectors and wiring.....	222
6.5	Shielding concept.....	223
6.6	Installation on mounting rails.....	225
6.7	Connection .....	228
6.7.1	Connection system.....	228
6.7.2	Wiring.....	231
6.7.3	Shielding .....	232
6.8	Note - Power supply .....	232
6.9	LED indicators - meanings .....	232
6.10	Connection .....	233
6.11	Disposal .....	234
<b>7</b>	<b>Appendix .....</b>	<b>235</b>
7.1	Diagnostics - basic principles of diag messages.....	235
7.2	TcEventLogger and IO .....	242
7.3	UL notice .....	246
7.4	Continuative documentation for ATEX and IECEx.....	248
7.5	EtherCAT AL Status Codes .....	248
7.6	Firmware Update EL/ES/EM/ELM/EPxxxx.....	248
7.6.1	Device description ESI file/XML .....	249
7.6.2	Firmware explanation.....	252
7.6.3	Updating controller firmware *.efw .....	253
7.6.4	FPGA firmware *.rbf.....	255
7.6.5	Simultaneous updating of several EtherCAT devices .....	259
7.7	Firmware compatibility .....	260
7.8	Firmware compatibility - passive terminals .....	260
7.9	Restoring the delivery state.....	260
7.10	Notes on analog aspects to EL3751/ ELM3xxx .....	261
7.11	Continuative documentation for I/O components with analog in and outputs .....	262
7.12	Support and Service.....	263
7.13	Reshipment and return.....	263



# 1 Foreword

## NOTICE

Within this short documentation some chapters are only available in a shortened version. For the complete documentation please contact the Beckhoff sales department responsible for you.

## 1.1 Notes on the documentation

### Intended audience

This description is only intended for the use of trained specialists in control and automation engineering who are familiar with the applicable national standards.

It is essential that the documentation and the following notes and explanations are followed when installing and commissioning these components.

It is the duty of the technical personnel to use the documentation published at the respective time of each installation and commissioning.

The responsible staff must ensure that the application or use of the products described satisfy all the requirements for safety, including all the relevant laws, regulations, guidelines and standards.

### Disclaimer

The documentation has been prepared with care. The products described are, however, constantly under development.

We reserve the right to revise and change the documentation at any time and without prior announcement.

No claims for the modification of products that have already been supplied may be made on the basis of the data, diagrams and descriptions in this documentation.

### Trademarks

Beckhoff®, TwinCAT®, TwinCAT/BSD®, TC/BSD®, EtherCAT®, EtherCAT G®, EtherCAT G10®, EtherCAT P®, Safety over EtherCAT®, TwinSAFE®, XFC®, XTS® and XPlanar® are registered trademarks of and licensed by Beckhoff Automation GmbH. Other designations used in this publication may be trademarks whose use by third parties for their own purposes could violate the rights of the owners.

### Patent Pending

The EtherCAT Technology is covered, including but not limited to the following patent applications and patents: EP1590927, EP1789857, EP1456722, EP2137893, DE102015105702 with corresponding applications or registrations in various other countries.



EtherCAT® is registered trademark and patented technology, licensed by Beckhoff Automation GmbH, Germany.

### Copyright

© Beckhoff Automation GmbH & Co. KG, Germany.

The reproduction, distribution and utilization of this document as well as the communication of its contents to others without express authorization are prohibited.

Offenders will be held liable for the payment of damages. All rights reserved in the event of the grant of a patent, utility model or design.

## 1.2 Safety instructions

### Safety regulations

Please note the following safety instructions and explanations!  
Product-specific safety instructions can be found on following pages or in the areas mounting, wiring, commissioning etc.

### Exclusion of liability

All the components are supplied in particular hardware and software configurations appropriate for the application. Modifications to hardware or software configurations other than those described in the documentation are not permitted, and nullify the liability of Beckhoff Automation GmbH & Co. KG.

### Personnel qualification

This description is only intended for trained specialists in control, automation and drive engineering who are familiar with the applicable national standards.

### Description of instructions

In this documentation the following instructions are used.  
These instructions must be read carefully and followed without fail!

#### DANGER

##### **Serious risk of injury!**

Failure to follow this safety instruction directly endangers the life and health of persons.

#### WARNING

##### **Risk of injury!**

Failure to follow this safety instruction endangers the life and health of persons.

#### CAUTION

##### **Personal injuries!**

Failure to follow this safety instruction can lead to injuries to persons.

#### NOTICE

##### **Damage to environment/equipment or data loss**

Failure to follow this instruction can lead to environmental damage, equipment damage or data loss.

#### Tip or pointer

**i** This symbol indicates information that contributes to better understanding.

## 1.3 Documentation Issue Status

Version	Comment
3.9	<ul style="list-style-type: none"><li>• “Guide through documentation“ within foreword added</li><li>• Chapter “Product overview” and subchapter “Mounting and wiring”/ “LED indicators – meanings” updated</li><li>• Subchapter “Commissioning”/ “CoE overview” updated</li></ul>

## 1.4 Guide through documentation

### NOTICE



#### Further components of documentation

This documentation describes device-specific content. It is part of the modular documentation concept for Beckhoff I/O components. For the use and safe operation of the device / devices described in this documentation, additional cross-product descriptions are required, which can be found in the following table.

Title	Description
<b>EtherCAT System Documentation</b> ( <a href="#">PDF</a> )	<ul style="list-style-type: none"> <li>• System overview</li> <li>• EtherCAT basics</li> <li>• Cable redundancy</li> <li>• Hot Connect</li> <li>• EtherCAT devices configuration</li> </ul>
<b>I/O Analog Manual</b> ( <a href="#">PDF</a> )	Notes on I/O components with analog in and outputs
<b>Explosion Protection for Terminal Systems</b> ( <a href="#">PDF</a> )	Notes on the use of the Beckhoff terminal systems in hazardous areas according to ATEX and IECEx
<b>Infrastructure for EtherCAT/Ethernet</b> ( <a href="#">PDF</a> )	Technical recommendations and notes for design, implementation and testing
<b>Software Declarations I/O</b> ( <a href="#">PDF</a> )	Open source software declarations for Beckhoff I/O components

The documentations can be viewed at and downloaded from the Beckhoff website ([www.beckhoff.com](http://www.beckhoff.com)) via:

- the “Documentation and Download” area of the respective product page,
- the [Download finder](#),
- the [Beckhoff Information System](#).



## 1.5 Version identification of EtherCAT devices

### 1.5.1 General notes on marking

#### Designation

A Beckhoff EtherCAT device has a 14-digit designation, made up of

- family key
- type
- version
- revision

Example	Family	Type	Version	Revision
EL3314-0000-0016	EL terminal 12 mm, non-pluggable connection level	3314 4-channel thermocouple terminal	0000 basic type	0016
ES3602-0010-0017	ES terminal 12 mm, pluggable connection level	3602 2-channel voltage measurement	0010 high-precision version	0017
CU2008-0000-0000	CU device	2008 8-port fast ethernet switch	0000 basic type	0000

#### Notes

- The elements mentioned above result in the **technical designation**. EL3314-0000-0016 is used in the example below.
- EL3314-0000 is the order identifier, in the case of “-0000” usually abbreviated to EL3314. “-0016” is the EtherCAT revision.
- The **order identifier** is made up of
  - family key (EL, EP, CU, ES, KL, CX, etc.)
  - type (3314)
  - version (-0000)
- The **revision** -0016 shows the technical progress, such as the extension of features with regard to the EtherCAT communication, and is managed by Beckhoff.  
In principle, a device with a higher revision can replace a device with a lower revision, unless specified otherwise, e.g. in the documentation.  
Associated and synonymous with each revision there is usually a description (ESI, EtherCAT Slave Information) in the form of an XML file, which is available for download from the Beckhoff web site.  
From 2014/01 the revision is shown on the outside of the IP20 terminals, see Fig. “EL5021 EL terminal, standard IP20 IO device with batch number and revision ID (since 2014/01)”.
- The type, version and revision are read as decimal numbers, even if they are technically saved in hexadecimal.

### 1.5.2 Version identification of EL terminals

The serial number/ data code for Beckhoff IO devices is usually the 8-digit number printed on the device or on a sticker. The serial number indicates the configuration in delivery state and therefore refers to a whole production batch, without distinguishing the individual modules of a batch.

Structure of the serial number: **KK YY FF HH**

KK - week of production (CW, calendar week)  
 YY - year of production  
 FF - firmware version  
 HH - hardware version

Example with serial number 12 06 3A 02:

12 - production week 12  
 06 - production year 2006  
 3A - firmware version 3A  
 02 - hardware version 02



Fig. 1: EL2872 with revision 0022 and serial number 01200815

### 1.5.3 Beckhoff Identification Code (BIC)

The Beckhoff Identification Code (BIC) is increasingly being applied to Beckhoff products to uniquely identify the product. The BIC is represented as a Data Matrix Code (DMC, code scheme ECC200), the content is based on the ANSI standard MH10.8.2-2016.

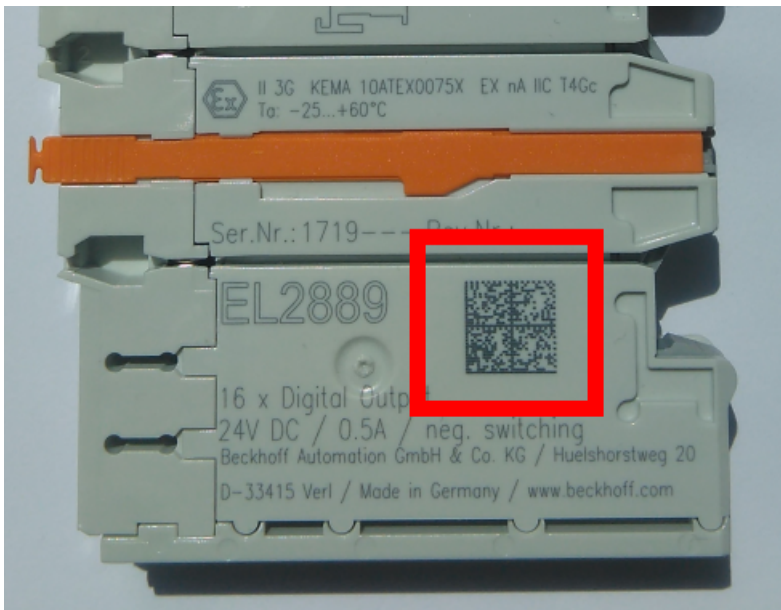

Fig. 2: BIC as data matrix code (DMC, code scheme ECC200)

The BIC will be introduced step by step across all product groups.

Depending on the product, it can be found in the following places:

- on the packaging unit
- directly on the product (if space suffices)
- on the packaging unit and the product

The BIC is machine-readable and contains information that can also be used by the customer for handling and product management.

Each piece of information can be uniquely identified using the so-called data identifier (ANSI MH10.8.2-2016). The data identifier is followed by a character string. Both together have a maximum length according to the table below. If the information is shorter, spaces are added to it.

Following information is possible, positions 1 to 4 are always present, the other according to need of production:

Position	Type of information	Explanation	Data identifier	Number of digits incl. data identifier	Example
1	Beckhoff order number	<b>Beckhoff order number</b>	1P	8	1P072222

Position	Type of information	Explanation	Data identifier	Number of digits incl. data identifier	Example
2	Beckhoff Traceability Number (BTN)	<b>Unique serial number, see note below</b>	SBTN	12	<b>S</b> BTNk4p562d7
3	Article description	<b>Beckhoff article description, e.g. EL1008</b>	1K	32	<b>1</b> KEL1809
4	Quantity	<b>Quantity in packaging unit, e.g. 1, 10, etc.</b>	Q	6	<b>Q</b> 1
5	Batch number	Optional: Year and week of production	2P	14	<b>2P</b> 401503180016
6	ID/serial number	Optional: Present-day serial number system, e.g. with safety products	51S	12	<b>51S</b> 678294
7	Variant number	Optional: Product variant number on the basis of standard products	30P	32	<b>30P</b> F971, 2*K183
...					

Further types of information and data identifiers are used by Beckhoff and serve internal processes.

**Structure of the BIC**

Example of composite information from positions 1 to 4 and with the above given example value on position 6. The data identifiers are highlighted in bold font:

**1P**072222**S**BTNk4p562d7**1K**EL1809 **Q**1 **51S**678294

Accordingly as DMC:



Fig. 3: Example DMC **1P072222SBTNk4p562d71KEL1809 Q1 51S678294**

**BTN**

An important component of the BIC is the Beckhoff Traceability Number (BTN, position 2). The BTN is a unique serial number consisting of eight characters that will replace all other serial number systems at Beckhoff in the long term (e.g. batch designations on IO components, previous serial number range for safety products, etc.). The BTN will also be introduced step by step, so it may happen that the BTN is not yet coded in the BIC.

<b>NOTICE</b>
This information has been carefully prepared. However, the procedure described is constantly being further developed. We reserve the right to revise and change procedures and documentation at any time and without prior notice. No claims for changes can be made from the information, illustrations and descriptions in this information.

**1.5.4 Electronic access to the BIC (eBIC)**

**Electronic BIC (eBIC)**

The Beckhoff Identification Code (BIC) is applied to the outside of Beckhoff products in a visible place. If possible, it should also be electronically readable.

Decisive for the electronic readout is the interface via which the product can be electronically addressed.

### K-bus devices (IP20, IP67)

Currently, no electronic storage and readout is planned for these devices.

### EtherCAT devices (IP20, IP67)

All Beckhoff EtherCAT devices have a so-called ESI-EEPROM, which contains the EtherCAT identity with the revision number. Stored in it is the EtherCAT slave information, also colloquially known as ESI/XML configuration file for the EtherCAT master. See the corresponding chapter in the EtherCAT system manual ([Link](#)) for the relationships.

The eBIC is also stored in the ESI-EEPROM. The eBIC was introduced into the Beckhoff I/O production (terminals, box modules) from 2020; widespread implementation is expected in 2021.

The user can electronically access the eBIC (if existent) as follows:

- With all EtherCAT devices, the EtherCAT master (TwinCAT) can read the eBIC from the ESI-EEPROM
  - From TwinCAT 3.1 build 4024.11, the eBIC can be displayed in the online view.
  - To do this, check the checkbox "Show Beckhoff Identification Code (BIC)" under EtherCAT → Advanced Settings → Diagnostics:

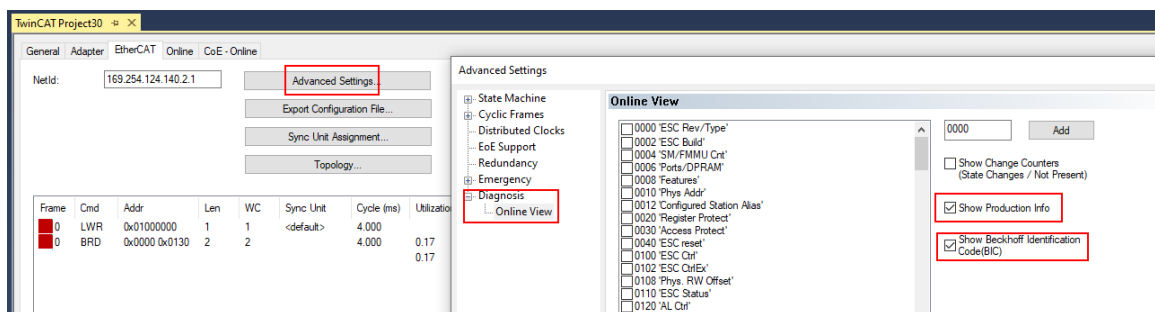

- The BTN and its contents are then displayed:

No	Addr	Name	State	CRC	Fw	Hw	Production Data	ItemNo	BTN	Description	Quantity	BatchNo	SerialNo
1	1001	Term 1 (EK1100)	OP	0,0	0	0	—	—	—	—	—	—	—
2	1002	Term 2 (EL1018)	OP	0,0	0	0	2020 KW36 Fr	072222	k4p562d7	EL1809	1	—	678294
3	1003	Term 3 (EL3204)	OP	0,0	7	6	2012 KW24 Sa	—	—	—	—	—	—
4	1004	Term 4 (EL2004)	OP	0,0	0	0	—	072223	k4p562d7	EL2004	1	—	678295
5	1005	Term 5 (EL1008)	OP	0,0	0	0	—	—	—	—	—	—	—
6	1006	Term 6 (EL2008)	OP	0,0	0	12	2014 KW14 Mo	—	—	—	—	—	—
7	1007	Term 7 (EK1110)	OP	0	1	8	2012 KW25 Mo	—	—	—	—	—	—

- Note: as can be seen in the illustration, the production data HW version, FW version and production date, which have been programmed since 2012, can also be displayed with "Show Production Info".
- From TwinCAT 3.1. build 4024.24 the functions *FB\_EcReadBIC* and *FB\_EcReadBTN* for reading into the PLC and further eBIC auxiliary functions are available in the Tc2\_EtherCAT Library from v3.3.19.0.
- In the case of EtherCAT devices with CoE directory, the object 0x10E2:01 can additionally be used to display the device's own eBIC; the PLC can also simply access the information here:

- The device must be in PREOP/SAFEOP/OP for access:

Index	Name	Flags	Value
1000	Device type	RO	0x015E1389 (22942601)
1008	Device name	RO	ELM3704-0000
1009	Hardware version	RO	00
100A	Software version	RO	01
100B	Bootloader version	RO	J0.1.27.0
1011:0	Restore default parameters	RO	> 1 <
1018:0	Identity	RO	> 4 <
10E2:0	Manufacturer-specific Identification C...	RO	> 1 <
10E2:01	SubIndex 001	RO	1P158442SBTN0008jekp1KELM3704 Q1 2P482001000016
10F0:0	Backup parameter handling	RO	> 1 <
10F3:0	Diagnosis History	RO	> 21 <
10F8	Actual Time Stamp	RO	0x170bf277e

- the object 0x10E2 will be introduced into stock products in the course of a necessary firmware revision.
- From TwinCAT 3.1. build 4024.24 the functions *FB\_EcCoEReadBIC* and *FB\_EcCoEReadBTN* for reading into the PLC and further eBIC auxiliary functions are available in the *Tc2\_EtherCAT Library* from v3.3.19.0.
- Note: in the case of electronic further processing, the BTN is to be handled as a string(8); the identifier "SBTN" is not part of the BTN.
- Technical background  
The new BIC information is additionally written as a category in the ESI-EEPROM during the device production. The structure of the ESI content is largely dictated by the ETG specifications, therefore the additional vendor-specific content is stored with the help of a category according to ETG.2010. ID 03 indicates to all EtherCAT masters that they must not overwrite these data in case of an update or restore the data after an ESI update.  
The structure follows the content of the BIC, see there. This results in a memory requirement of approx. 50..200 bytes in the EEPROM.
- Special cases
  - If multiple, hierarchically arranged ESCs are installed in a device, only the top-level ESC carries the eBIC Information.
  - If multiple, non-hierarchically arranged ESCs are installed in a device, all ESCs carry the eBIC Information.
  - If the device consists of several sub-devices with their own identity, but only the top-level device is accessible via EtherCAT, the eBIC of the top-level device is located in the CoE object directory 0x10E2:01 and the eBICs of the sub-devices follow in 0x10E2:nn.

**PROFIBUS, PROFINET, DeviceNet devices etc.**

Currently, no electronic storage and readout is planned for these devices.

## **1.5.5 BIC within CoE of EL3751**

Overview of BIC support: CoE object 0x10E2 (BIC) has been included since FW13.

For unique identification, the object 0x10E2 is to be used instead of the 0xF083, which was previously partially available.



## 2 Product overview

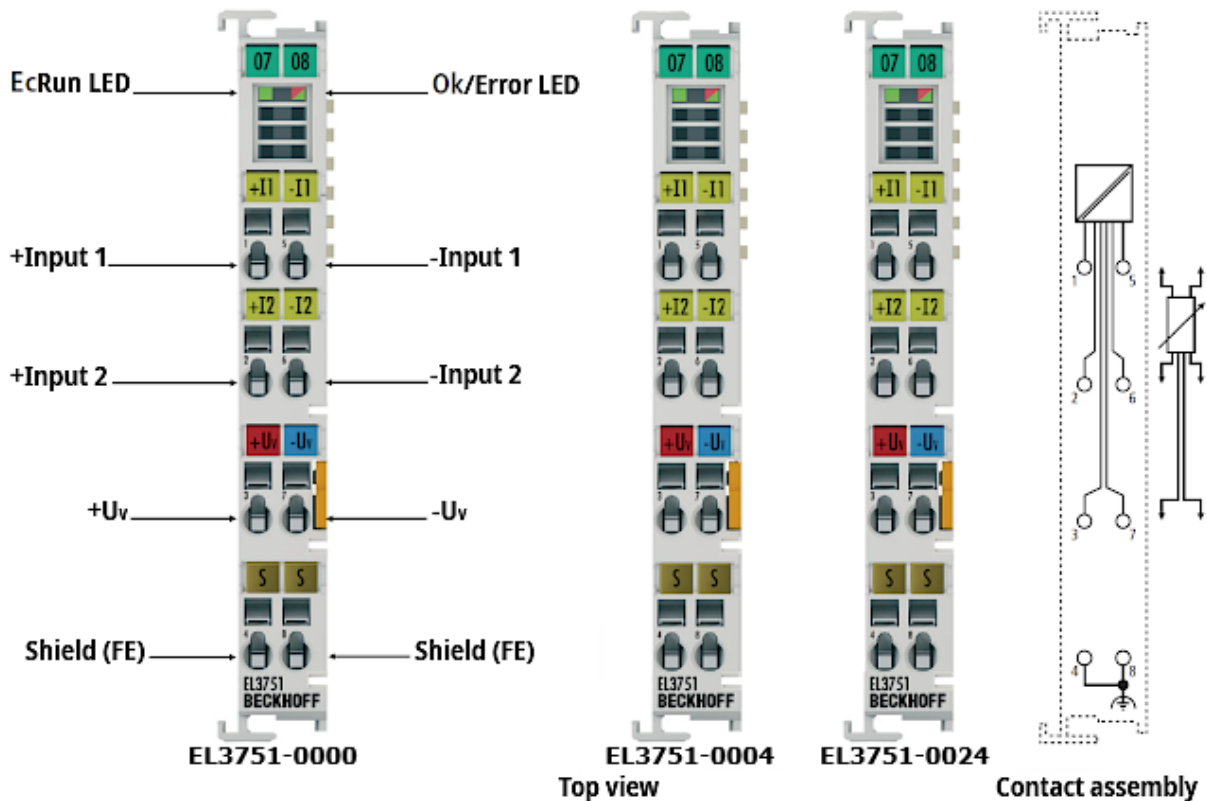

Fig. 4: EL3751, EL3751-0004, EL3751-0024; LEDs, connections and assignment

**1-channel multi-functional input for analog measurement technology, 24 bit, 10 ksp/s, differential inputs, oversampling**

### 2.1 Description

This documentation covers the following device descriptions

- EL3751-0000 multifunctional terminal
- EL3751-0020 like EL3751-0000, additionally with Beckhoff factory calibration certificate
- EL3751-0004 reduced to resistance measurement variant of EL3751-0000 for resistance measurement up to 5 kΩ and RTD-based (temperature) measurement, technical features there like EL3751-0000
- EL3751-0024 like EL3751-0004, additionally with Beckhoff factory calibration certificate

As a multi-functional input for analog measurement technology, the EL3751-0000 analog input terminal can be used for measuring electrical parameters in several measuring ranges. The respective nominal measuring ranges are:

- Voltage between ±5 mV and ±30 V, 0..10 V, 0..5 V
- Current in the range ±20 mA , 4..20 mA, 0..20 mA, NAMUR NE43
- Resistor bridge, strain gauge (SG): 1/4 bridge (350 Ω + 120 Ω), 1/2 bridge (±16 mV/V) and 1/1 bridge (±32 mV/V) in 2-6 wire connection
- Electrical resistance R / temperature with RTD (PT100 etc.): 0...5 kΩ in 2-4 wire connection
- Potentiometer up to 1 kΩ

The nominal measuring range referred to above is part of the total available and usable technical measuring range, which for the EL3751 is approx. ±107%, depending on the measuring range. The "extended range" property can be disabled, in order to make the behavior compatible with the EL30/31/36xx "legacy range".

The measurement takes place via a differential input channel. It is digitized with a resolution of 24 bit and 10 ksp/s and transported electrically isolated from the fieldbus to the higher-level automation device with optional oversampling. The integrated supply and the switchable auxiliary resistors enable direct connection of a resistor bridge (strain gauge SG) or load cell with 2-/3-/4-/6-wire connection technology, a fixed resistor, a PTC or a potentiometer. The signal state of the EtherCAT Terminal is indicated by light emitting diodes.

If a lower sampling rate is required, a data rate reduction (referred to as decimation) can be set internally, based on the fixed analog sampling rate of 10 ksp/s. The sampling rate of  $\leq 10$  ksp/s achieved in this way can then be transferred to the controller via EtherCAT, based on the task cycle time and a suitable oversampling factor.

The terminal has two configurable numeric software filters up to FIR 39<sup>th</sup> order (40 taps) or IIR 6<sup>th</sup> order. The first filter is applied to the 10 ksp/s raw data, the second filter is based on the user-settable decimation, with a view to suppressing aliasing effects. Both filters can be set based on an integrated list (a number of low-pass, high-pass, mean value filters) or a freely selectable coefficient table.

Non-linear characteristic sensor curves can be corrected flexibly through an integrated sampling points table. Simple mathematical operations are also possible.

Each terminal has a unique ID number, which is printed and electronically readable. The optionally available factory calibration certificate (EL3751-0020, EL3751-0024) can be assigned via this ID number; re-calibration is possible.

## 2.2 Technical data

### 2.2.1 Common technical data

Technical data	EL3751
Analog inputs	1 channel
Connection technology	2 - 6 wire
Resolution	24 bit including sign, 32 bit display
Sampling type	simultaneous
Ground reference	differential
Selection of oversampling factors	1, 2, 4, 5, 8, 10, 16, 20, 25, 32, 40, 50, 64
ADC conversion method	deltaSigma $\Delta\Sigma$ , 1.28 msp/s (internal sampling rate)
Limit frequency input filter hardware	Before AD converter: 30 kHz hardware filter Within ADC after conversion: -3dB @ 3.2 kHz, mean value filter 5th order
Measuring error	Typically $\pm 0.01\%$ @ 23°C, exceptions for individual measuring ranges, details see function tables and <sup>2)</sup> below.
Max. sampling rate/conversion time	10 ksp/s/ 100 $\mu$ s (fixed, additionally free downsampling in firmware through decimation factor)
Supported EtherCAT cycle time (depending on the operation mode)	DistributedClocks: min. 100 $\mu$ s, max. 25 ms (max. 10 ms recommended) FrameTriggered/Synchron: min. 200 $\mu$ s, max. 100 ms FreeRun: not supported
Signal delay (step response)	tbd.
Signal delay (linear)	tbd. Phase response linear, constant envelope delay
Acquisition method	Simultaneous (1 channel, simultaneous with DC synchronization of several terminals)
Dielectric strength - destruction limit	max. permitted short-term/continuous voltage • Voltage between each contact point $\pm I1$ , $\pm I2$ , $+U_v$ , and $-U_v$ ; non-supplied $\pm 40$ V, supplied $\pm 36$ V

Technical data	EL3751
	<ul style="list-style-type: none"> <li>Voltage between every contact point and SGND (shield, mounting rail): see information to electrical isolation</li> </ul> <p>Note: <math>-U_v</math>, corresponds to internal GND</p>
Recommended operation voltage range to compliance with specification ( $U_{CM}$ , common mode)	<p>max. permitted voltage during specified normal operation</p> <ul style="list-style-type: none"> <li><math>\pm I1</math> and <math>\pm I2</math>: typ. <math>\pm 10</math> V against <math>-U_v</math>,</li> </ul> <p>Note: <math>-U_v</math>, corresponds to internal GND</p>
Distributed Clocks	Yes, with oversampling
Electrical isolation bus/channel	500 V DC (1 min. typical test voltage)
Electrical isolation channel/channel	(not applicable since 1 channel)
Bit width of the process image (default setting)	32 bit / per value
Supports CoE Interface [ <a href="#">▶ 213</a> ] function	Yes
Special features	<p>integrated switchable <math>\frac{1}{4}</math> bridge extension for 120 and 350 <math>\Omega</math></p> <p>Higher-order synchronization, PeakHold drag indicator, predefined and freely configurable software filters, TrueRMS, freely selectable downsampling, 2-stage integrator/differentiator, free scaling function (also non-linear), end value limiter, extended/legacy range, line compensation</p> <p>Available with factory calibration certificate on request</p>
Internal surge voltage protection of the inputs related to $-U_v$ (internal ground)	<p>+IN1, -IN1: at approx. <math>12 \pm 0.5</math> V (within 30 V-Mode at approx. <math>37 \pm 1</math> V)</p> <p>+IN2, -IN2: at approx. <math>&lt; -0.3</math> V or <math>&gt; +5.3</math> V</p>
Supply voltage for electronic	via the E-bus
Current consumption via E-bus	typ. 260 mA
Thermal power dissipation	typ. 1.2 W
Current consumption from the power contacts	none
Permissible operating altitude range	0 to 2000 m (derating at higher altitudes on request)
Weight	approx. 65 g
Permissible ambient temperature range during operation	<p>0...+55 °C (in horizontal installation position)</p> <p>0...+45 °C (all other installation positions)</p>
Permissible ambient temperature range during storage	-25...+85 °C
Installation position	Operation possible in all installation positions; compliance with full accuracy only possible in horizontal/standard position.
Permissible relative humidity	95 %, no condensation
Max. sensor wire length	The wire length from the EtherCAT terminal to the sensor/encoder must have max. 30 m without any action of protection. For larger wire lengths a proper over voltage protection (surge protection) is required.
Dimensions (W x H x D)	approx. 15 mm x 100 mm x 70 mm (width aligned: 12 mm)
Mounting	on 35 mm mounting rail conforms to EN 60715
Vibration/shock resistance	conforms to EN 60068-2-6 / EN 60068-2-27
EMC immunity/emission	conforms to EN 61000-6-2 / EN 61000-6-4
Protection class	IP20
Approvals/ markings *)	CE, UKCA, EAC, <a href="#">UL</a> [ <a href="#">▶ 246</a> ], <a href="#">ATEX</a> [ <a href="#">▶ 221</a> ]

\*) Real applicable approvals/markings see type plate on the side (product marking).

2) Dominant part of the basic accuracy is its offset specification (see following tables). The process described in the Offset correction section eliminates this proportion and increases the measurement accuracy considerably.

**Ex marking**

Standard	Marking
ATEX	II 3 G Ex nA IIC T4 Gc

**2.2.2 Process data interpretation**

The entire measurement range is constituted as follows with regard to the output of the cyclic process data:

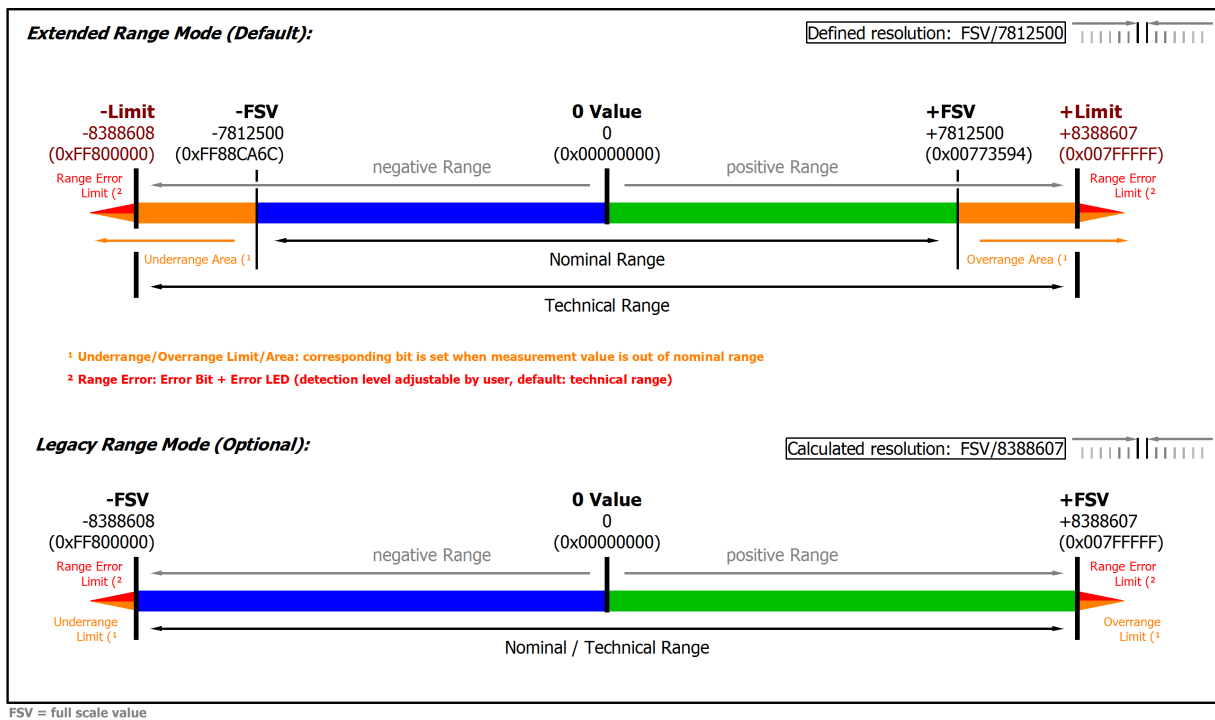

Fig. 5: Basic range of a process data value

The channel for this terminal features an option to set the measuring range either to the conventional Beckhoff type, up until now: "nominal full-scale value = PDO end value: LegacyRange" or the new method "technical full-scale value = PDO end value: ExtendedRange".

- For Extended Range mode, the following applies:
  - technical full scale value = PDO end value 0x007FFFFFFF.
  - for information purposes, the channel can measure up to approx. 107% beyond the nominal range, although accuracy specifications etc. are then no longer valid.
  - outside the nominal measuring range, the Overrange or Underrange bit is set.
  - for further diagnosis, the error bit and the error LED are set if configurable limits are exceeded or not reached. By default, the limits are set to the technical measuring range, although they can be narrowed by the customer.  
Example: In the 4...20 mA measuring range, the lower limit is set to 0 mA, although it can be customized in the CoE by the customer, e.g. set to 3.6 mA, in order to enable earlier detection of potential sensor faults.
  - The Extended Range mode is the default setting for the terminal ex works.
  - The mode is defined through the non-periodic rational LSB step size **and** an integer end value. This enables the step size to be used in a PLC program without a rounding error.
- For Legacy Range mode, the following applies:

- nominal full scale value = PDO end value.
- compatible with existing interface from EL30xx/EL31xx/EL36xx.
- Overrange/Underrange, Error bit and Error LED are set simultaneously if the nominal/technical measuring range is exceeded or not met.
- can be optionally activated in the terminal.
- this mode is defined by an integer end value; assuming that the LSB step is no longer a whole number.

## 2.2.3 General Information on Measuring Accuracy/Measurement Uncertainty

For basic information regarding the explanatory notes below, please refer to chapter "Notes on analog data values" under Continuative documentation for I/O components with analog in and outputs [► 262], particularly for full scale value.

*This guidance should be read and followed in order to save extra work, time and, presumably, money.*

*In-depth familiarization with these instructions will make it easy to master this technology and thus facilitate your work.*

### Basic information on measurement technology:

Measuring devices are used to try to determine the true value of a measured variable, e.g. ambient temperature, with the amount of effort put into this varying. For various practical reasons this cannot be performed conclusively. Depending on the work involved, the measurement/measured value is subject to a random measuring error that cannot be eliminated. With its practically determined specification data, Beckhoff provides an approach that can be used to calculate the residual measurement uncertainty in the individual case. The following paragraphs elucidate this.

### General notes

No special maintenance required, although an annual inspection is recommended for the terminal.

If a factory calibration certificate is available for the device, a one-year recalibration interval is recommended, unless otherwise specified.

### Notes regarding the specification data:

- Measurement specifications are usually specified as "% of nominal full scale value" = "% full scale value (%<sub>FSV</sub>)", unless otherwise specified.
- With regard to an individual value, "typical" means that on average, this parameter has the specified value. For individual terminals, the parameter may deviate from the typical value. Current consumption is an example of this.
- In the context of a limit (parameter is typically max./min. X) or with two limits (parameter is typically between X and Y), "typical" means that this parameter predominantly between the limits for the individual terminals. However, deviations may occur: see confidence level. Noise is an example of this. Usually, no measurements are taken, in order to be able to make statements about standard deviations or result frequencies. A typical value is usually indicated with the abbreviation "typ." after the unit.
- The confidence level is 95%, unless otherwise specified.
- When operating in EMC-disturbed environments, twisted and shielded signal cables which are grounded at one end, at minimum, must be used in order to comply with the specification. The use of Beckhoff shielding accessories ZB8511 or ZS9100-0002 is recommended:

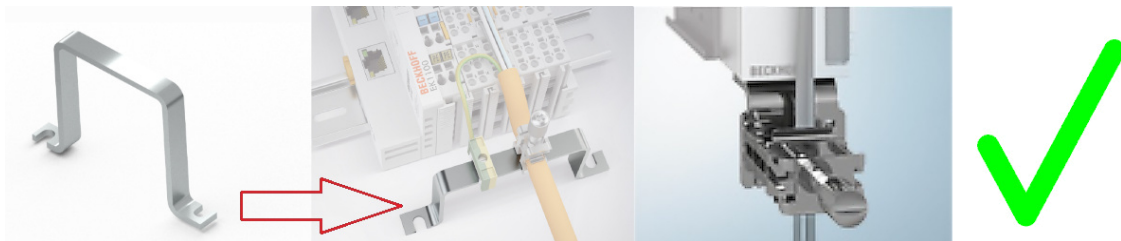

The ZB8520 DIN rail fastening is not recommended with regard to the analog protective effect:





- Unless otherwise specified, measurement errors etc. will be stated in electrical DC operation (no use of AC values). During measurement of an AC value, the frequency slope of the analog input influences the measurement itself.

### Note on temperature

The internal/external temperature of the device affects the measurement through the electronics. A measuring setup is generally characterized by a temperature dependence, which is specified in the form of a temperature drift, for example. The specifications apply for a constant ambient temperature. Variable conditions (e.g. heating of the control cabinet, sudden temperature drop due to opening of the control cabinet in cold weather) resulting in a temperature change may alter the measured values through dynamic and heterogeneous temperature distribution. To rectify such effects, the internal temperature of the device can be read online from the CoE and used for calculation. Some devices also electrically indicate that they have thermally stabilized; see diagnostic features.

### The specification data apply:

- after a warm-up time under operating voltage and in fieldbus mode of least 60 minutes at constant ambient temperature
  - practical note: after power-on, the device generally heats up exponentially such that the major proportion of the heating has occurred within a short period of approximately 10 to 15 minutes, depending on the device, and the measuring properties shift within the specification limits.
  - for clarification: typical trend of an internal temperature (no significance for a particular device):

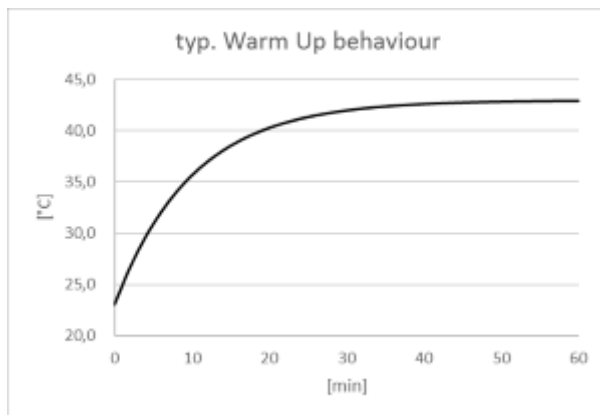

- some devices display that they are internally thermally stabilized and  $\Delta T$  within the device is very small in the [CoE object 0xF900:02](#) [► 104]. This can be evaluated by an application,
- in horizontal installation position, taking the minimum distances into consideration,
- under natural convection (no forced ventilation),
- provided the specifications are adhered to.

Under different conditions, user-specific adjustment is required.

### Notes on calculation with the specification data:

The independent specification data can be divided into two groups:

- the data on offset/gain deviation, non-linearity, and repeatability, whose effect on the measurement cannot be influenced by the user. These are summarized by Beckhoff according to the calculation below, at "basic accuracy at 23°C".
- the specification data whose effect on the measurement can be influenced by the user, namely
  - noise: effect can be influenced by sample rate, filtering and
  - the temperature: effect can be influenced by control cabinet air conditioning, shielding, cooling, etc.

The independent individual accuracy data are to be added quadratically according to the formula below in order to determine the total measurement accuracy – if there are no special conditions that contraindicate a uniform distribution and thus the quadratic approach (RSS – root sum squared method).

$$E_{\text{Total}} = \sqrt{(E_{\text{Gain}} \cdot \frac{MV}{FSV})^2 + (Tc_{\text{Gain}} \cdot \Delta T \cdot \frac{MV}{FSV})^2 + E_{\text{Offset}}^2 + E_{\text{Lin}}^2 + E_{\text{Rep}}^2 + (\frac{1}{2} \cdot E_{\text{Noise, PtP}})^2 + (Tc_{\text{Offset}} \cdot \Delta T)^2 + (E_{\text{Age}} \cdot N_{\text{Years}})^2}$$

For measurement ranges where the temperature coefficient is only given as  $Tc_{\text{Terminal}}$ :

$$E_{\text{Total}} = \sqrt{(E_{\text{Gain}} \cdot \frac{MV}{FSV})^2 + E_{\text{Offset}}^2 + E_{\text{Lin}}^2 + E_{\text{Rep}}^2 + (\frac{1}{2} \cdot E_{\text{Noise, PtP}})^2 + (Tc_{\text{Terminal}} \cdot \Delta T)^2 + (E_{\text{Age}} \cdot N_{\text{Years}})^2}$$

$E_{\text{Offset}}$	: Offset specification (at 23°C)
$E_{\text{Gain}}$	: Gain/scale specification (at 23°C)
$E_{\text{Noise, PtP}}$	: Noise specification as a peak-to-peak value (applies to all temperatures)
MV	: Measured value
FSV	: Full scale value
$E_{\text{Lin}}$	: Non-linearity error over the entire measuring range (applies for all temperatures)
$E_{\text{Rep}}$	: Repeatability (applies to all temperatures)
$Tc_{\text{Offset}}$	: Temperature coefficient offset
$Tc_{\text{Gain}}$	: Temperature coefficient gain
$Tc_{\text{Terminal}}$	: Temperature coefficient of the terminal
$\Delta T$	: Difference between the ambient temperature and the specified basic temperature (23°C unless otherwise specified)
$E_{\text{Age}}$	: Error coefficient for ageing
$N_{\text{Years}}$	: Number of years
$E_{\text{Total}}$	: Theoretically calculated total error

For example, if the following values are obtained at a determined measured value MV of 8.13 V in the 10 V measurement range (FSV = 10 V) ( $N_{\text{Years}} = 0$ ):

- Gain specification:  $E_{\text{Gain}} = 60 \text{ ppm}$
- Offset specification:  $E_{\text{Offset}} = 70 \text{ ppm}_{\text{FSV}}$
- Non-linearity:  $E_{\text{Lin}} = 25 \text{ ppm}_{\text{FSV}}$
- Repeatability:  $E_{\text{Rep}} = 20 \text{ ppm}_{\text{FSV}}$
- Noise (without filtering):  $E_{\text{Noise, PtP}} = 100 \text{ ppm}_{\text{peak-to-peak}}$
- Temperature coefficients:
  - $Tc_{\text{Gain}} = 8 \text{ ppm/K}$
  - $Tc_{\text{Offset}} = 5 \text{ ppm}_{\text{FSV}/\text{K}}$

then the theoretical possible total measurement accuracy at  $\Delta T = 12\text{K}$  for the basic temperature can be calculated as follows:

$$E_{\text{Total}} = \sqrt{(60 \text{ ppm} \cdot 0.813)^2 + (12\text{K} \cdot 8 \text{ ppm/K} \cdot 0.813)^2 + (70 \text{ ppm}_{\text{FSV}})^2 + (25 \text{ ppm}_{\text{FSV}})^2 + (20 \text{ ppm}_{\text{FSV}})^2 + (50 \text{ ppm}_{\text{FSV}})^2 + (12\text{K} \cdot 5 \text{ ppm}_{\text{FSV}/\text{K}})^2}$$

$$= 143.16 \text{ ppm}_{\text{FSV}}$$

or =  $\pm 0.0143 \text{ \%}_{\text{FSV}}$

Remarks:  $\text{ppm} \triangleq 10^{-6}$        $\% \triangleq 10^{-2}$

In general, you can calculate this as follows:

- if use at 23°C alone is to be considered:  
Total measurement accuracy = basic accuracy & noise according to above formula
- If use at 23°C is to be considered with slow measurement (=averaging/filtering):  
Total measurement accuracy = basic accuracy
- If general use within a known temperature range and incl. noise is to be considered:  
Total measurement accuracy = basic accuracy & noise & temperature values according to above formula

Beckhoff usually gives the specification data symmetrically in  $[\pm\%]$ , i.e.  $\pm 0.01\%$  or  $\pm 100 \text{ ppm}$ . Accordingly, therefore, the unsigned total range would be double this given value. A peak-to-peak specification is a total range specification; the symmetrical value is thus half of it. In the quadratic calculation below, the symmetrical value for "one side" is to be inserted without a sign. Noise is usually specified in peak-to-peak form, therefore the equation for the noise value already contains the division factor 2.

Example:

- symmetrical specification:  $\pm 0.01\%$  (equivalent to  $\pm 100$  ppm) e.g. for offset specification
- total range:  $0.02\%$  (200 ppm)
- to be used in the equation:  $0.01\%$  (100 ppm)

The total measurement accuracy calculated in this way is also to be considered as a symmetrical maximum value and thus to be provided with  $\pm$  and  $\leq$  for further use.

Example:

- $E_{\text{Total}} = 100$  ppm
- For further use: " $\leq \pm 100$  ppm"

Expressed in words: "The offset of the individual accuracy specifications under the given conditions produced a range of 200 ppm that lies symmetrically around the individual measured value. The measured value specification  $x$  thus has an uncertainty of  $x \pm 100$  ppm; it is thus 95% certain that the true value thus lies in this range".

### ● The noise component can be omitted

**i** The noise component  $F_{\text{Noise}}$  can be omitted from the above equation ( $= 0$  ppm) if the average value for a set of samples is used instead of a single sample. The averaging can take place in the PLC, or it can be done by a filter in the analog channel. The output value of a moving average of many samples has a noise component that is almost entirely eliminated. The achievable accuracy thus increases when the noise component is decreased.

## NOTICE

### Error coefficient of ageing

If the specification value for aging from Beckhoff has not (yet) been specified, it must be assumed to be 0 ppm when considering measurement uncertainty, as in the above example, even if in reality it can be assumed that the measurement uncertainty of the device under consideration changes over the operating time, or colloquially stated, the measured value "drifts".

Experience has shown that the basic accuracy of the instrument under consideration, provided it is operated according to specifications, can be taken as the order of magnitude for an annual change (10,000 h). This is an informative statement, does not constitute a specification, and exceptions may occur. In general, the change in ageing will be very application-specific. A general ageing specification from Beckhoff is therefore to be regarded as a guideline rather than a guaranteed upper limit, when published.

If the measurement uncertainty consideration in the application shows that aging over the desired operating time can put the measurement accuracy at risk, Beckhoff recommends a cyclical check (recalibration) of the measurement channel, with regard to sensors, cabling and the Beckhoff measurement terminals. In this way, potential long-term changes in the measurement chain can be detected early and, in some cases, the trigger (e.g. overtemperature) can even be eliminated. See also [Continuative documentation for I/O components with analog in and outputs \[► 262\]](#).

### ● Basic accuracy, extended basic accuracy, and averaging

- i** ✓ The basic accuracy will be designated separately to simplify usage.
- a) The basic accuracy includes the offset/gain deviation, non-linearity and repeatability, but not the temperature coefficient nor the noise and is thereby a subset of the aforementioned complete calculation. It is possible to increase the measurement accuracy beyond the basic accuracy by means of the offset correction.  
Note: the "extended basic accuracy" also includes the temperature behavior across the specified operating temperature range, e.g.  $0 \dots 60^\circ\text{C}$ , via the temperature coefficient.
  - b) "Averaging" means that the value has been obtained from the arithmetic average of 100,000 (usually) values to eliminate noise. The averaging function integrated into the box module does not necessarily need to be used. If resources are available, averaging can also be executed within the PLC.

**i Measurement accuracy of the measured value (from reading)**

In several cases, the "Accuracy based on the up-to-date measured value" (percentage of reading), i.e. "Accuracy of value", is sought instead of the "Accuracy related to the full scale value (FSV)" (percentage of range).

This value could easily be calculated from the data given by the specification, as the total accuracy consists of a measured value and full scale value dependent component and an exclusively full scale value dependent component, according to the formula:

$$E_{\text{Total}} = \sqrt{\underbrace{\left( E_{\text{Gain}} \cdot \frac{\text{MV}}{\text{FSV}} \right)^2 + \left( T_{\text{CGain}} \cdot \Delta T \cdot \frac{\text{MV}}{\text{FSV}} \right)^2 + E_{\text{Offset}}^2 + E_{\text{Lin}}^2 + E_{\text{Rep}}^2}_{\text{Error content, depending on the measurement value}} + \underbrace{\left( \frac{1}{2} \cdot E_{\text{Noise, PTP}} \right)^2 + \left( T_{\text{COffset}} \cdot \Delta T \right)^2 + \left( E_{\text{Age}} \cdot N_{\text{Years}} \right)^2}_{\text{Error content, exclusive depending on the full scale value}}}$$

**2.2.4 Measurement ±30 V**

Measurement mode		±30 V	
Measuring range, nominal		-30...+30 V	
Measuring range, end value (full scale value)		30 V	
Measuring range, technically usable		-32.212...+32.212 V	
PDO resolution		24 bit (including sign)	
PDO LSB (Extended Range)		3.84 µV	
PDO LSB (Legacy Range)		3.576.. µV	
Basic accuracy: Measuring deviation at 23°C, with averaging		< ±0.01% <sub>FSV</sub> = ±100 ppm <sub>FSV</sub>	
Offset/Zero Point deviation (at 23°C)	E <sub>Offset</sub>	< 65 ppm <sub>FSV</sub>	
Gain/scale/amplification deviation (at 23°C)	E <sub>Gain</sub>	< 65 ppm	
Non-linearity over the whole measuring range	E <sub>Lin</sub>	< 45 ppm <sub>FSV</sub>	
Repeatability	E <sub>Rep</sub>	< 20 ppm <sub>FSV</sub>	
Noise (without filtering)	E <sub>Noise, PTP</sub>	< 100 ppm <sub>FSV</sub>	< 781 [digits]
	E <sub>Noise, RMS</sub>	< 18 ppm <sub>FSV</sub>	< 141 [digits]
	Max. SNR	> 94.9 dB	
	Noisedensity@1kHz	< 7.64 $\frac{\mu\text{V}}{\sqrt{\text{Hz}}}$	
Noise (with 50Hz FIR filtering)	E <sub>Noise, PTP</sub>	< 10 ppm <sub>FSV</sub>	< 78 [digits]
	E <sub>Noise, RMS</sub>	< 2.5 ppm <sub>FSV</sub>	< 20 [digits]
	Max. SNR	> 112.0 dB	
Temperature coefficient	T <sub>CGain</sub>	< 11 ppm/K typ.	
	T <sub>COffset</sub>	< 10 ppm <sub>FSV</sub> /K typ.	
Common-mode rejection ratio (without filtering)		DC: >68 dB typ.	50 Hz: >68 dB typ. 1 kHz: >52 dB typ.
Common-mode rejection ratio (with 50Hz FIR filtering)		DC: >68 dB typ.	50 Hz: >100 dB typ. 1 kHz: >100 dB typ.
Largest short-term deviation during a specified electrical interference test		±0.05% <sub>FSV</sub> = ±500 ppm <sub>FSV</sub> typ.	
Input impedance ±Input 1 (Internal resistance)		Differential 570 kΩ    11 nF typ. CommonMode 140 kΩ    40 nF typ. Methodology: Resistor against -U <sub>V</sub> , capacitance against SGND	
Input impedance ±Input 2		No usage of this input in this mode	

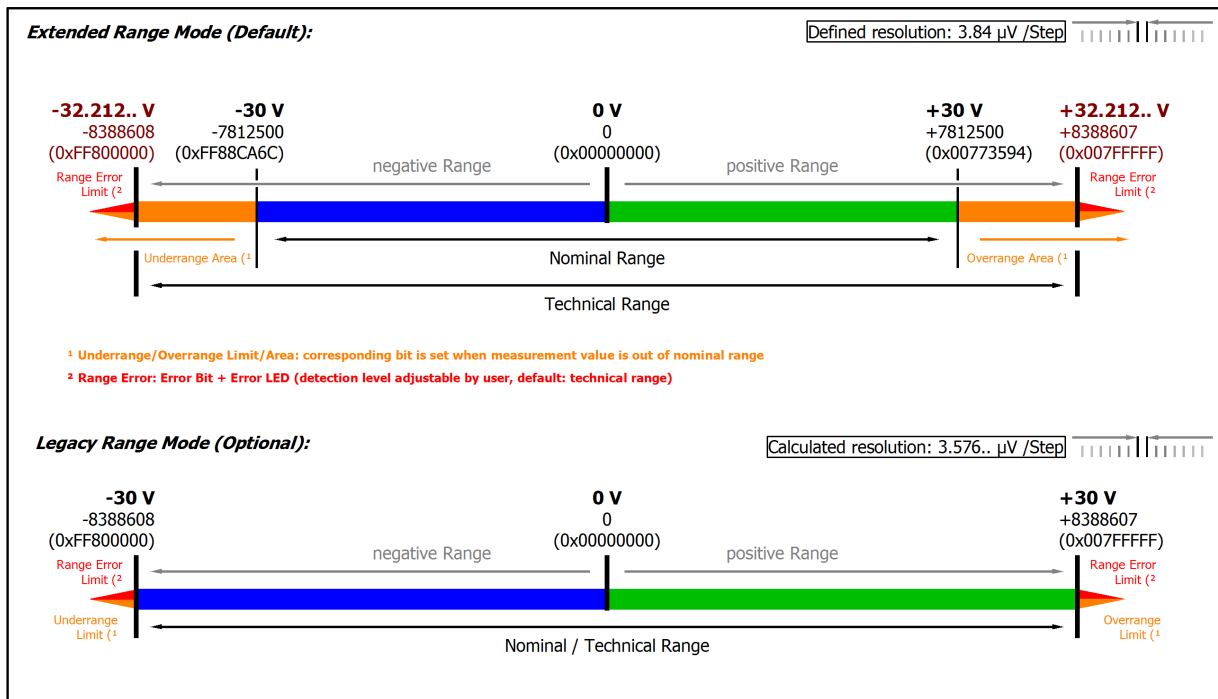

Fig. 6: Representation  $\pm 30\text{ V}$  measurement range

Note: In Extended Range Mode the Underrange/Overrange display in the PDO status has the character of an information/warning when the nominal measuring range is exceeded, i.e. no *Error* is displayed in the PDO status and LED. If the technical measuring range is also exceeded, *Error = TRUE* is also displayed. The detection limit for Underrange/Overrange *Error* can be set in the CoE.

In Legacy Range mode, an Underrange/Overrange event also leads to an *Error* in the PDO status.

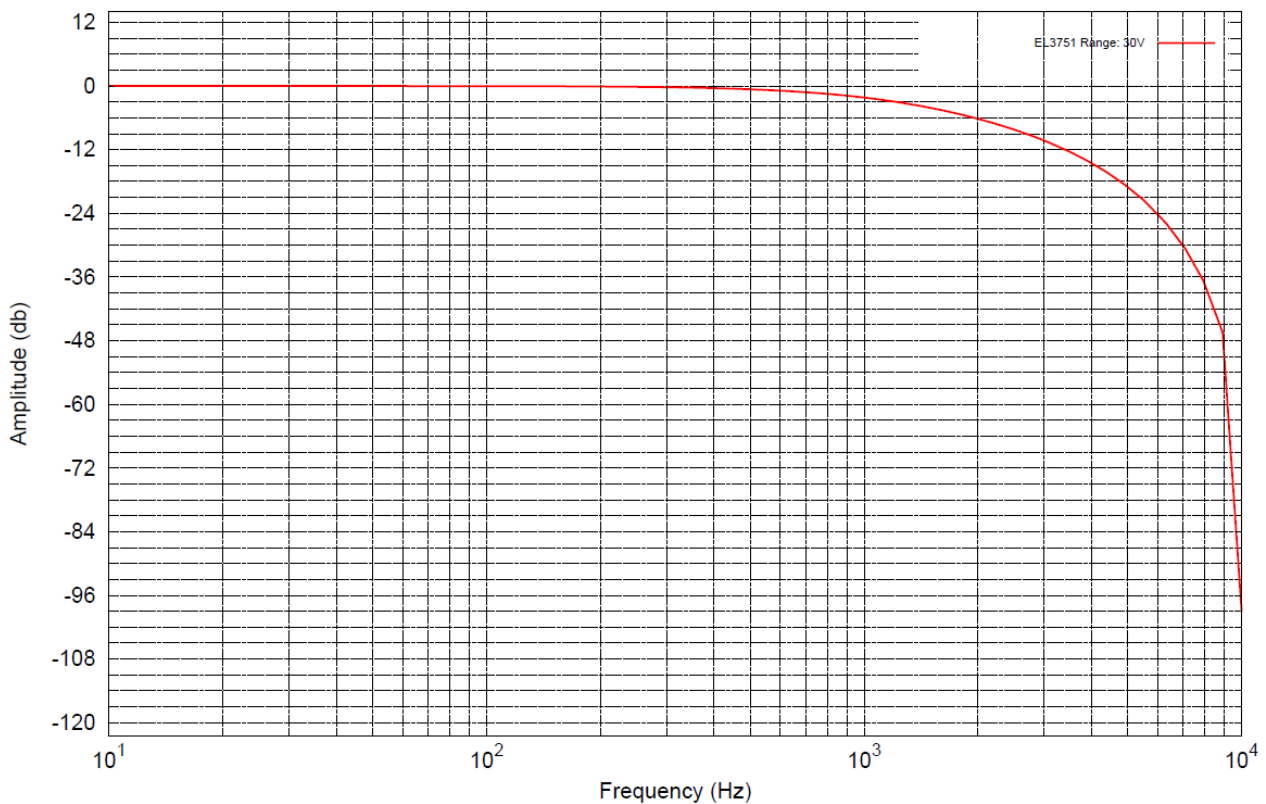

Fig. 7: Frequency response  $\pm 30\text{ V}$  measurement range,  $f_{\text{sampling}} = 10\text{ kHz}$ , integrated filter 1/2 deactivated

## 2.2.5 Measurement $\pm 10$ V

Measurement mode		$\pm 10$ V	
Measuring range, nominal		-10...+10 V	
Measuring range, end value (full scale value)		10 V	
Measuring range, technically usable		-10.737...+10.737 V	
PDO resolution		24 bit (including sign)	
PDO LSB (Extended Range)		1.28 $\mu$ V	
PDO LSB (Legacy Range)		1.192.. $\mu$ V	
Basic accuracy: Measuring deviation at 23°C, with averaging		$< \pm 0.01\%_{\text{FSV}} = \pm 100 \text{ ppm}_{\text{FSV}}$	
Offset/Zero Point deviation (at 23°C)	$E_{\text{Offset}}$	$< 70 \text{ ppm}_{\text{FSV}}$	
Gain/scale/amplification deviation (at 23°C)	$E_{\text{Gain}}$	$< 60 \text{ ppm}$	
Non-linearity over the whole measuring range	$E_{\text{Lin}}$	$< 25 \text{ ppm}_{\text{FSV}}$	
Repeatability	$E_{\text{Rep}}$	$< 20 \text{ ppm}_{\text{FSV}}$	
Noise (without filtering)	$E_{\text{Noise, PtP}}$	$< 100 \text{ ppm}_{\text{FSV}}$	$< 781$ [digits]
	$E_{\text{Noise, RMS}}$	$< 18 \text{ ppm}_{\text{FSV}}$	$< 141$ [digits]
	Max. SNR	$> 94.9 \text{ dB}$	
	Noisedensity@1kHz	$< 2.55 \frac{\mu\text{V/V}}{\sqrt{\text{Hz}}}$	
Noise (with 50Hz FIR filtering)	$E_{\text{Noise, PtP}}$	$< 10 \text{ ppm}_{\text{FSV}}$	$< 78$ [digits]
	$E_{\text{Noise, RMS}}$	$< 2.0 \text{ ppm}_{\text{FSV}}$	$< 16$ [digits]
	Max. SNR	$> 114.0 \text{ dB}$	
Temperature coefficient	$T_{\text{C Gain}}$	$< 8 \text{ ppm/K typ.}$	
	$T_{\text{C Offset}}$	$< 5 \text{ ppm}_{\text{FSV}}/\text{K typ.}$	
Common-mode rejection ratio (without filtering)		DC: $> 115 \text{ dB typ.}$	50 Hz: $> 105 \text{ dB typ.}$ 1 kHz: $> 80 \text{ dB typ.}$
Common-mode rejection ratio (with 50Hz FIR filtering)		DC: $> 115 \text{ dB typ.}$	50 Hz: $> 115 \text{ dB typ.}$ 1 kHz: $> 115 \text{ dB typ.}$
Largest short-term deviation during a specified electrical interference test		$\pm 0.05\%_{\text{FSV}} = \pm 500 \text{ ppm}_{\text{FSV typ.}}$	
Input impedance $\pm$ Input 1 (Internal resistance)		Differential 4.1 M $\Omega$    11 nF typ. CommonMode 1 M $\Omega$    40 nF typ. Methodology: Resistor against -U <sub>V</sub> , capacitance against SGND	
Input impedance $\pm$ Input 2		No usage of this input in this mode	

According to the Beckhoff „measurement error” a reference value can be calculated as specified in section “General information on measuring accuracy/measurement uncertainty” [► 22].

That result is for the measurement range  $\pm 10$ V by the above given data and an environment temperature of  $T_{\text{Environment,max}} = 55^\circ\text{C}$  to  $\pm 321 \text{ ppm}_{\text{FSV}}$  (or  $0.032\%_{\text{FSV}}$ ).

See also measurement error/measurement deviation/measurement uncertainty, output uncertainty under Continuative documentation for I/O components with analog in and outputs [► 262].



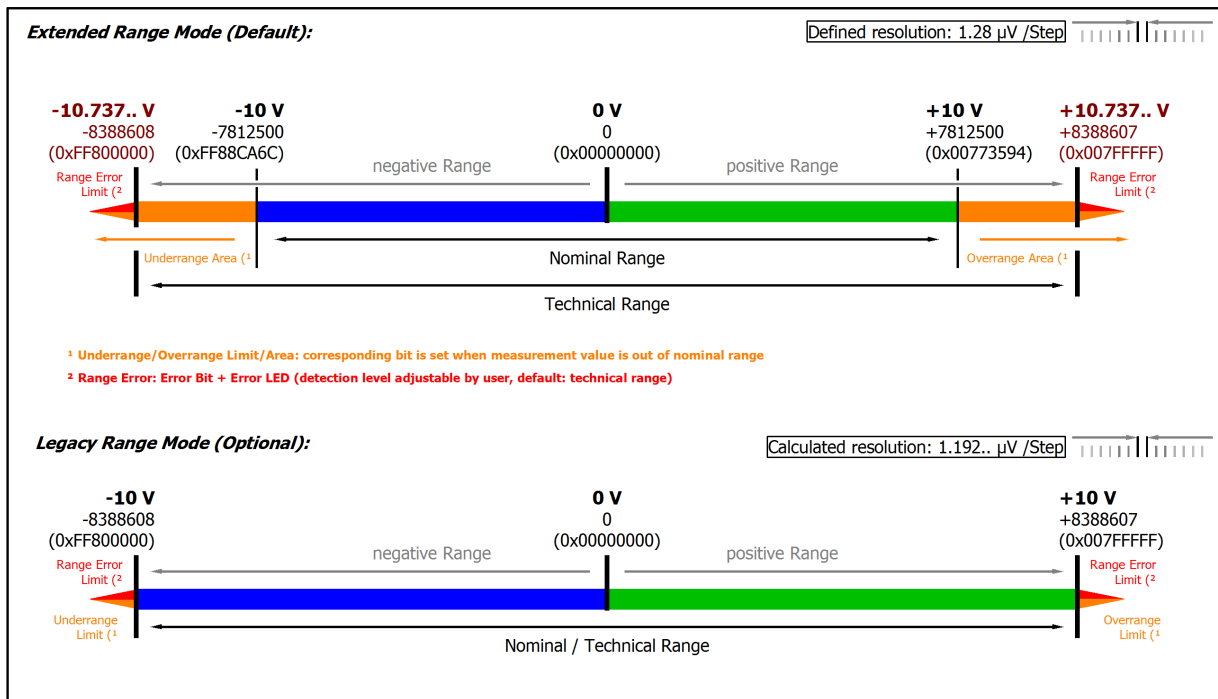

Fig. 8: Representation ±10 V measurement range

Note: In Extended Range Mode the Underrange/Overrange display in the PDO status has the character of an information/warning when the nominal measuring range is exceeded, i.e. no *Error* is displayed in the PDO status and LED. If the technical measuring range is also exceeded, *Error = TRUE* is also displayed. The detection limit for Underrange/Overrange *Error* can be set in the CoE.

In Legacy Range mode, an Underrange/Overrange event also leads to an *Error* in the PDO status.

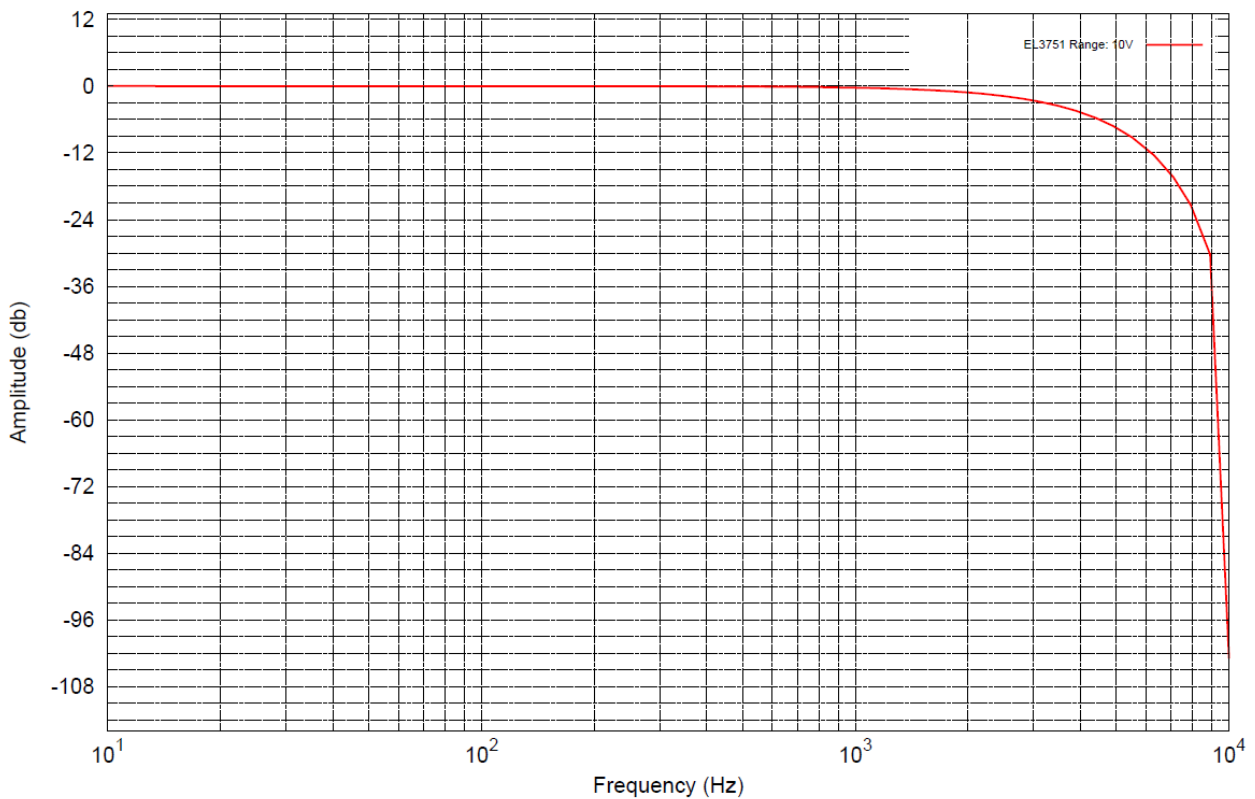

Fig. 9: Frequency response ±10 V measurement range,  $f_{\text{sampling}} = 10 \text{ kHz}$ , integrated filter 1/2 deactivated

## 2.2.6 Measurement $\pm 5$ V

Measurement mode		$\pm 5$ V		
Measuring range, nominal		-5...+5 V		
Measuring range, end value (full scale value)		5 V		
Measuring range, technically usable		-5.368...+5.368 V		
PDO resolution		24 bit (including sign)		
PDO LSB (Extended Range)		640 nV		
PDO LSB (Legacy Range)		596.. nV		
Basic accuracy: Measuring deviation at 23°C, with averaging		$< \pm 0.01\%_{\text{FSV}} = \pm 100 \text{ ppm}_{\text{FSV}}$		
Offset/Zero Point deviation (at 23°C)	$E_{\text{Offset}}$	$< 70 \text{ ppm}_{\text{FSV}}$		
Gain/scale/amplification deviation (at 23°C)	$E_{\text{Gain}}$	$< 55 \text{ ppm}$		
Non-linearity over the whole measuring range	$E_{\text{Lin}}$	$< 25 \text{ ppm}_{\text{FSV}}$		
Repeatability	$E_{\text{Rep}}$	$< 20 \text{ ppm}_{\text{FSV}}$		
Noise (without filtering)	$E_{\text{Noise, PtP}}$	$< 100 \text{ ppm}_{\text{FSV}}$	$< 781$ [digits]	
	$E_{\text{Noise, RMS}}$	$< 18 \text{ ppm}_{\text{FSV}}$	$< 141$ [digits]	
	Max. SNR	$> 94.9 \text{ dB}$		
	Noisedensity@1kHz	$< 1.27 \frac{\mu\text{V}/\text{V}}{\sqrt{\text{Hz}}}$		
Noise (with 50Hz FIR filtering)	$E_{\text{Noise, PtP}}$	$< 10 \text{ ppm}_{\text{FSV}}$	$< 78$ [digits]	
	$E_{\text{Noise, RMS}}$	$< 2.0 \text{ ppm}_{\text{FSV}}$	$< 16$ [digits]	
	Max. SNR	$> 114.0 \text{ dB}$		
Temperature coefficient	$T_{\text{C Gain}}$	$< 8 \text{ ppm}/\text{K typ.}$		
	$T_{\text{C Offset}}$	$< 5 \text{ ppm}_{\text{FSV}}/\text{K typ.}$		
Common-mode rejection ratio (without filtering)		DC: $> 115 \text{ dB typ.}$	50 Hz: $> 105 \text{ dB typ.}$	1 kHz: $> 80 \text{ dB typ.}$
Common-mode rejection ratio (with 50Hz FIR filtering)		DC: $> 115 \text{ dB typ.}$	50 Hz: $> 115 \text{ dB typ.}$	1 kHz: $> 115 \text{ dB typ.}$
Largest short-term deviation during a specified electrical interference test		$\pm 0.05\%_{\text{FSV}} = \pm 500 \text{ ppm}_{\text{FSV typ.}}$		
Input impedance $\pm$ Input 1 (Internal resistance)		Differential $4.1 \text{ M}\Omega \parallel 11 \text{ nF typ.}$		
		CommonMode $1 \text{ M}\Omega \parallel 40 \text{ nF typ.}$ Methodology: Resistor against $-U_{\text{V}}$ , capacitance against SGND		
Input impedance $\pm$ Input 2		No usage of this input in this mode		

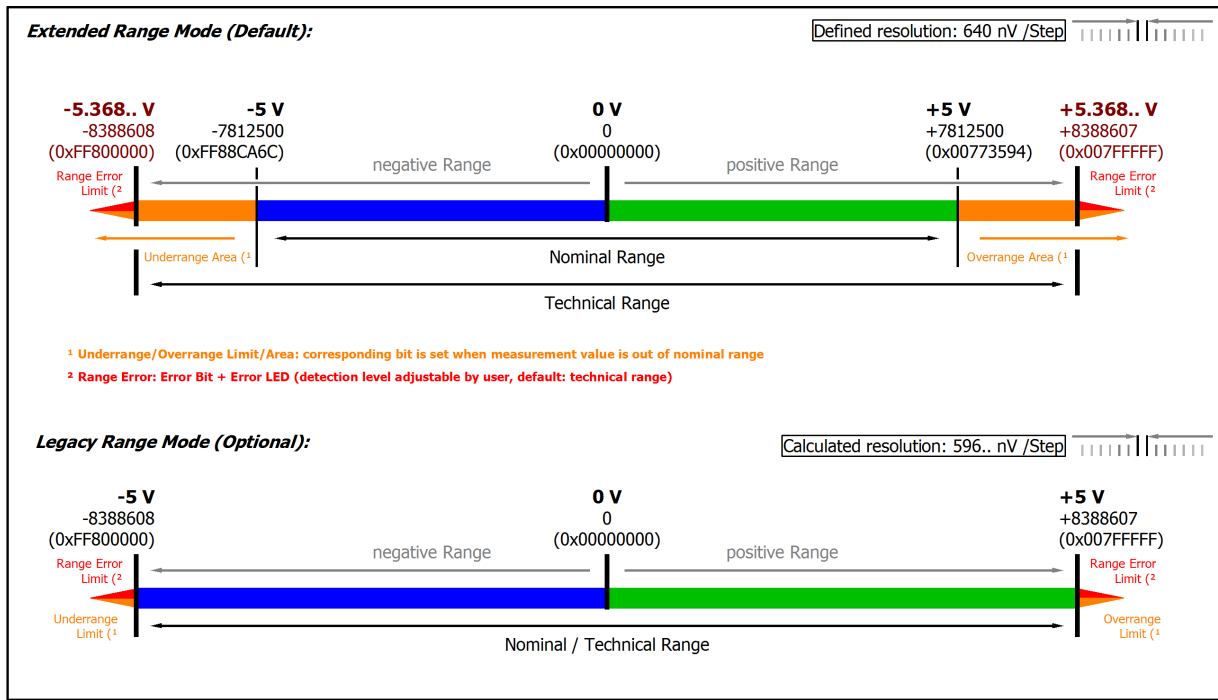

Fig. 10: Representation ±5 V measurement range

Note: In Extended Range Mode the Underrange/Overrange display in the PDO status has the character of an information/warning when the nominal measuring range is exceeded, i.e. no *Error* is displayed in the PDO status and LED. If the technical measuring range is also exceeded, *Error = TRUE* is also displayed. The detection limit for Underrange/Overrange *Error* can be set in the CoE.

In Legacy Range mode, an Underrange/Overrange event also leads to an *Error* in the PDO status.

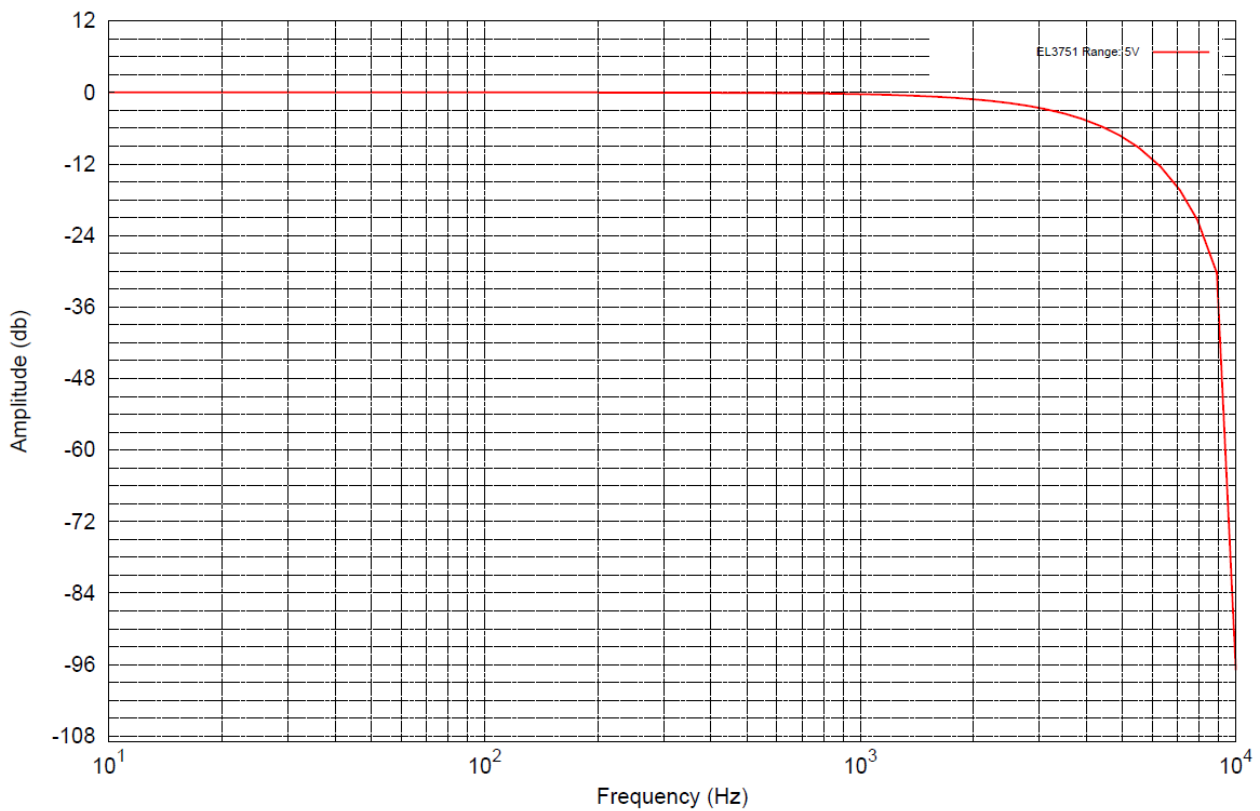

Fig. 11: Frequency response ±5 V measurement range,  $f_{\text{sampling}} = 10 \text{ kHz}$ , integrated filter 1/2 deactivated

## 2.2.7 Measurement $\pm 2.5$ V

Measurement mode		$\pm 2.5$ V		
Measuring range, nominal		-2.5 ... +2.5 V		
Measuring range, end value (full scale value)		2.5 V		
Measuring range, technically usable		-2.684...+2.684 V		
PDO resolution		24 bit (including sign)		
PDO LSB (Extended Range)		320 nV		
PDO LSB (Legacy Range)		298.. nV		
Basic accuracy: Measuring deviation at 23°C, with averaging		$< \pm 0.01\%_{\text{FSV}} = \pm 100 \text{ ppm}_{\text{FSV}}$		
Offset/Zero Point deviation (at 23°C)	$E_{\text{Offset}}$	$< 70 \text{ ppm}_{\text{FSV}}$		
Gain/scale/amplification deviation (at 23°C)	$E_{\text{Gain}}$	$< 55 \text{ ppm}$		
Non-linearity over the whole measuring range	$E_{\text{Lin}}$	$< 25 \text{ ppm}_{\text{FSV}}$		
Repeatability	$E_{\text{Rep}}$	$< 20 \text{ ppm}_{\text{FSV}}$		
Noise (without filtering)	$E_{\text{Noise, PtP}}$	$< 90 \text{ ppm}_{\text{FSV}}$	$< 703$ [digits]	
	$E_{\text{Noise, RMS}}$	$< 17 \text{ ppm}_{\text{FSV}}$	$< 133$ [digits]	
	Max. SNR	$> 95.4 \text{ dB}$		
	Noisedensity@1kHz	$< 0.60 \frac{\mu\text{V/V}}{\sqrt{\text{Hz}}}$		
Noise (with 50Hz FIR filtering)	$E_{\text{Noise, PtP}}$	$< 9 \text{ ppm}_{\text{FSV}}$	$< 70$ [digits]	
	$E_{\text{Noise, RMS}}$	$< 2.0 \text{ ppm}_{\text{FSV}}$	$< 16$ [digits]	
	Max. SNR	$> 114.0 \text{ dB}$		
Temperature coefficient	$T_{\text{C Gain}}$	$< 8 \text{ ppm/K typ.}$		
	$T_{\text{C Offset}}$	$< 5 \text{ ppm}_{\text{FSV}}/\text{K typ.}$		
Common-mode rejection ratio (without filtering)		DC: $> 115 \text{ dB typ.}$	50 Hz: $> 105 \text{ dB typ.}$	1 kHz: $> 80 \text{ dB typ.}$
Common-mode rejection ratio (with 50Hz FIR filtering)		DC: $> 115 \text{ dB typ.}$	50 Hz: $> 115 \text{ dB typ.}$	1 kHz: $> 115 \text{ dB typ.}$
Largest short-term deviation during a specified electrical interference test		$\pm 0.05\%_{\text{FSV}} = \pm 500 \text{ ppm}_{\text{FSV}} \text{ typ.}$		
Input impedance $\pm$ Input 1 (Internal resistance)		Differential $4.1 \text{ M}\Omega \parallel 11 \text{ nF typ.}$ CommonMode $1 \text{ M}\Omega \parallel 40 \text{ nF typ.}$ Methodology: Resistor against $-U_V$ , capacitance against SGND		
Input impedance $\pm$ Input 2		No usage of this input in this mode		

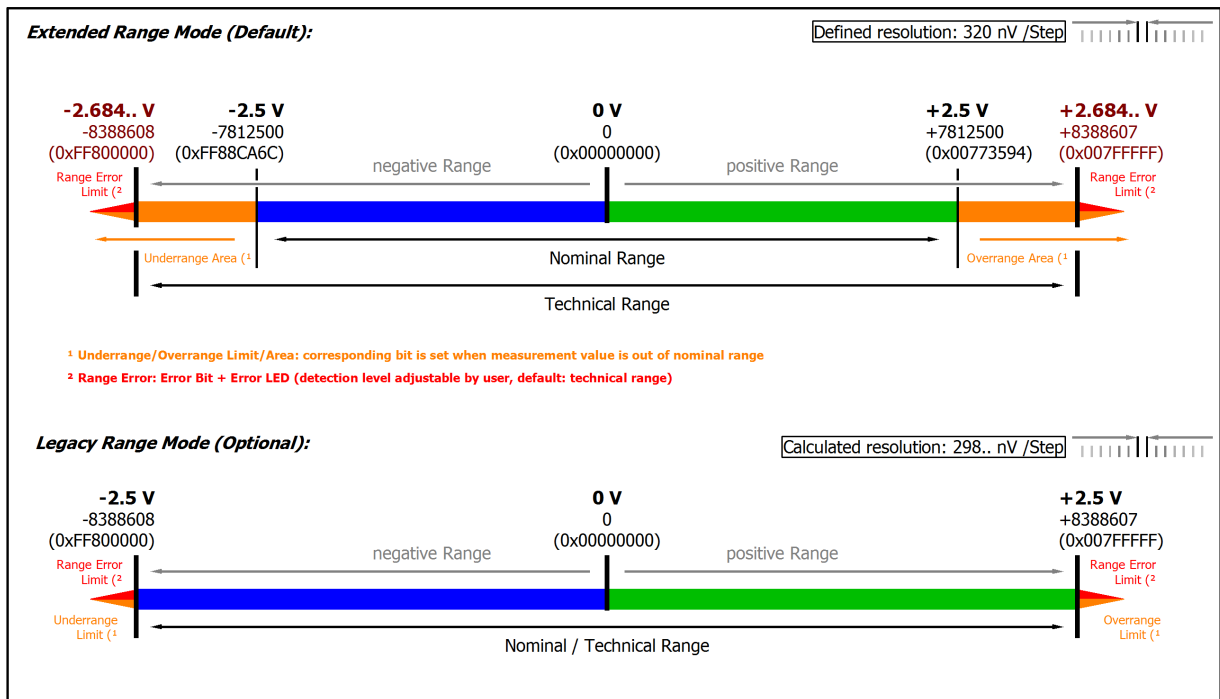

Fig. 12: Representation ±2.5 V measurement range

Note: In Extended Range Mode the Underrange/Overrange display in the PDO status has the character of an information/warning when the nominal measuring range is exceeded, i.e. no *Error* is displayed in the PDO status and LED. If the technical measuring range is also exceeded, *Error = TRUE* is also displayed. The detection limit for Underrange/Overrange *Error* can be set in the CoE.

In Legacy Range mode, an Underrange/Overrange event also leads to an *Error* in the PDO status.

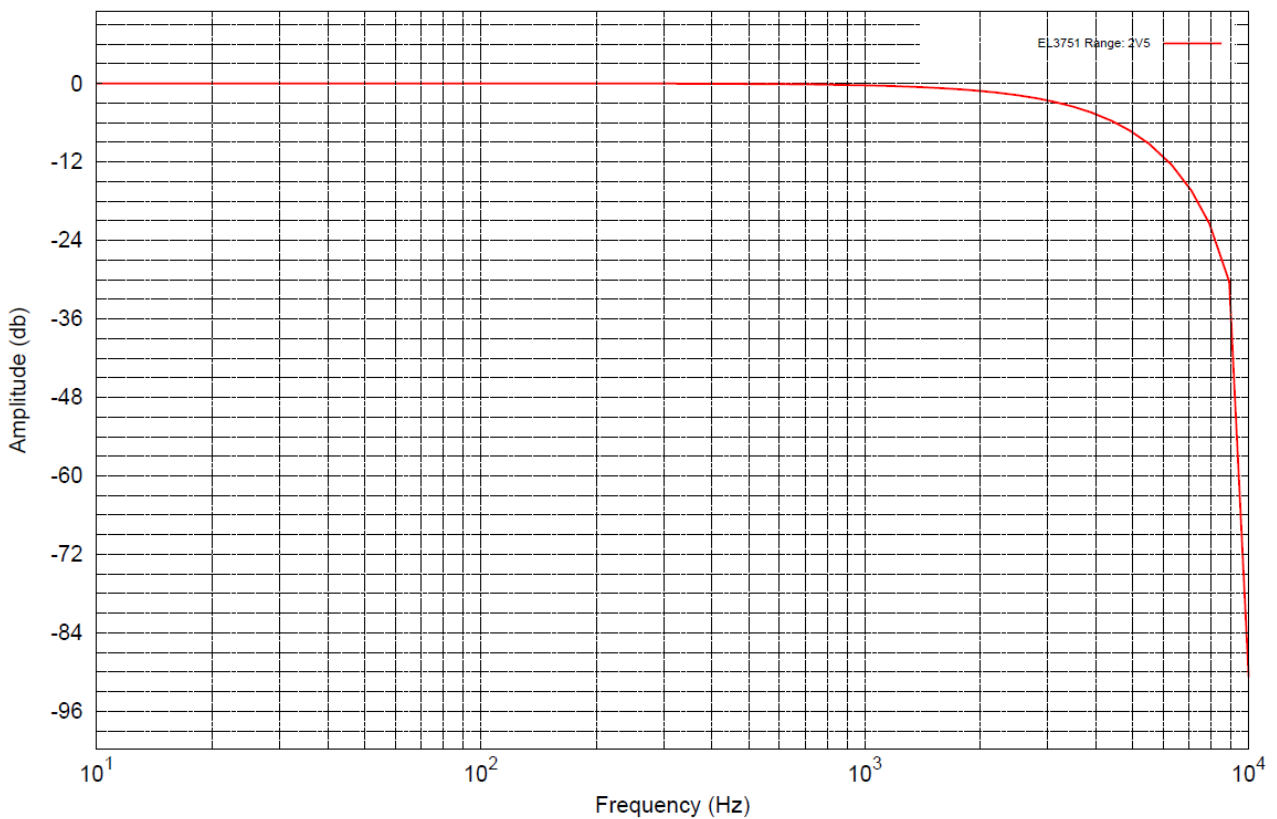

Fig. 13: Frequency response ±2.5 V measurement range,  $f_{\text{sampling}} = 10 \text{ kHz}$ , integrated filter 1/2 deactivated

## 2.2.8 Measurement $\pm 1.25$ V

Measurement mode		$\pm 1.25$ V	
Measuring range, nominal		-1.25...+1.25 V	
Measuring range, end value (full scale value)		1.25 V	
Measuring range, technically usable		-1.490...+1.490 V	
PDO resolution		24 bit (including sign)	
PDO LSB (Extended Range)		160 nV	
PDO LSB (Legacy Range)		149.. nV	
Basic accuracy: Measuring deviation at 23°C, with averaging		$< \pm 0.01\%_{\text{FSV}} = \pm 100 \text{ ppm}_{\text{FSV}}$	
Offset/Zero Point deviation (at 23°C)	$E_{\text{Offset}}$	$< 70 \text{ ppm}_{\text{FSV}}$	
Gain/scale/amplification deviation (at 23°C)	$E_{\text{Gain}}$	$< 55 \text{ ppm}$	
Non-linearity over the whole measuring range	$E_{\text{Lin}}$	$< 25 \text{ ppm}_{\text{FSV}}$	
Repeatability	$E_{\text{Rep}}$	$< 20 \text{ ppm}_{\text{FSV}}$	
Noise (without filtering)	$E_{\text{Noise, PTP}}$	$< 90 \text{ ppm}_{\text{FSV}}$	$< 703$ [digits]
	$E_{\text{Noise, RMS}}$	$< 17 \text{ ppm}_{\text{FSV}}$	$< 133$ [digits]
	Max. SNR	$> 95.4 \text{ dB}$	
	Noisedensity@1kHz	$< 0.30 \frac{\mu\text{V}/\text{V}}{\sqrt{\text{Hz}}}$	
Noise (with 50Hz FIR filtering)	$E_{\text{Noise, PTP}}$	$< 9 \text{ ppm}_{\text{FSV}}$	$< 70$ [digits]
	$E_{\text{Noise, RMS}}$	$< 2.0 \text{ ppm}_{\text{FSV}}$	$< 16$ [digits]
	Max. SNR	$> 114.0 \text{ dB}$	
Temperature coefficient	$T_{\text{CGain}}$	$< 8 \text{ ppm}/\text{K typ.}$	
	$T_{\text{COffset}}$	$< 5 \text{ ppm}_{\text{FSV}}/\text{K typ.}$	
Common-mode rejection ratio (without filtering)		DC: $>115 \text{ dB typ.}$	50 Hz: $>105 \text{ dB typ.}$ 1 kHz: $>80 \text{ dB typ.}$
Common-mode rejection ratio (with 50Hz FIR filtering)		DC: $>115 \text{ dB typ.}$	50 Hz: $>115 \text{ dB typ.}$ 1 kHz: $>115 \text{ dB typ.}$
Largest short-term deviation during a specified electrical interference test		$\pm 0.05\%_{\text{FSV}} = \pm 500 \text{ ppm}_{\text{FSV typ.}}$	
Input impedance $\pm$ Input 1 (Internal resistance)		Differential $4.1 \text{ M}\Omega \parallel 11 \text{ nF typ.}$ CommonMode $1 \text{ M}\Omega \parallel 40 \text{ nF typ.}$ Methodology: Resistor against $-U_V$ , capacitance against SGND	
Input impedance $\pm$ Input 2		No usage of this input in this mode	

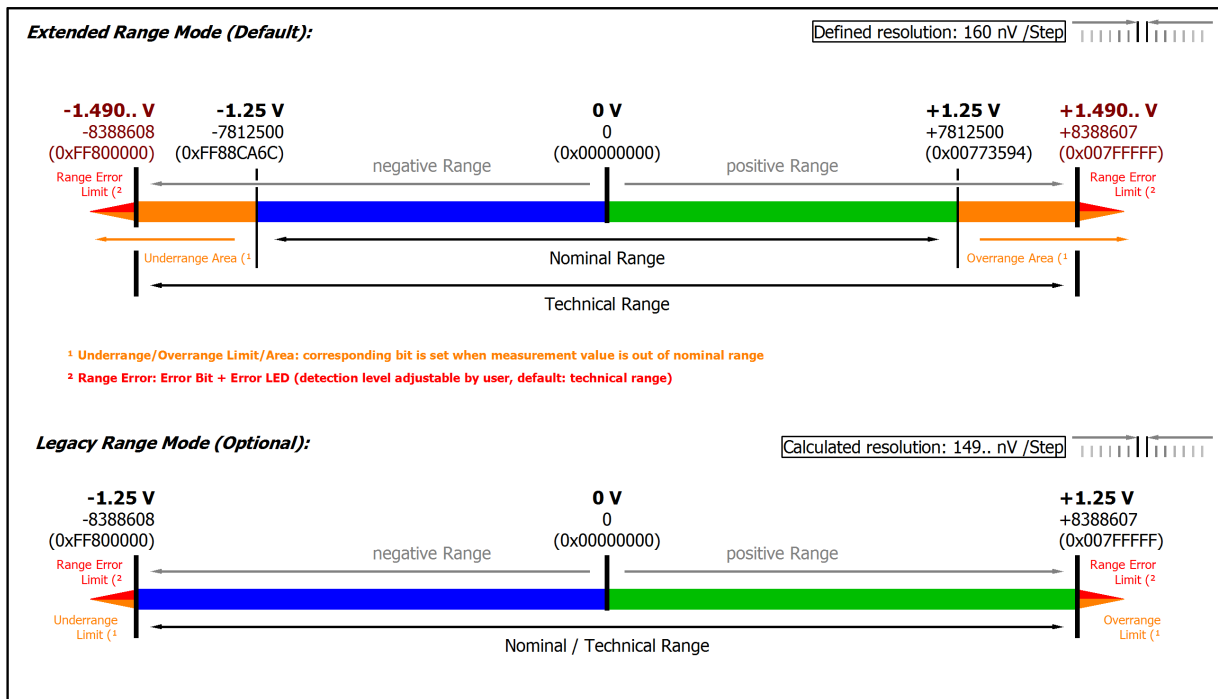

Fig. 14: Representation ±1.25 V measurement range

Note: In Extended Range Mode the Underrange/Overrange display in the PDO status has the character of an information/warning when the nominal measuring range is exceeded, i.e. no *Error* is displayed in the PDO status and LED. If the technical measuring range is also exceeded, *Error = TRUE* is also displayed. The detection limit for Underrange/Overrange *Error* can be set in the CoE.

In Legacy Range mode, an Underrange/Overrange event also leads to an *Error* in the PDO status.

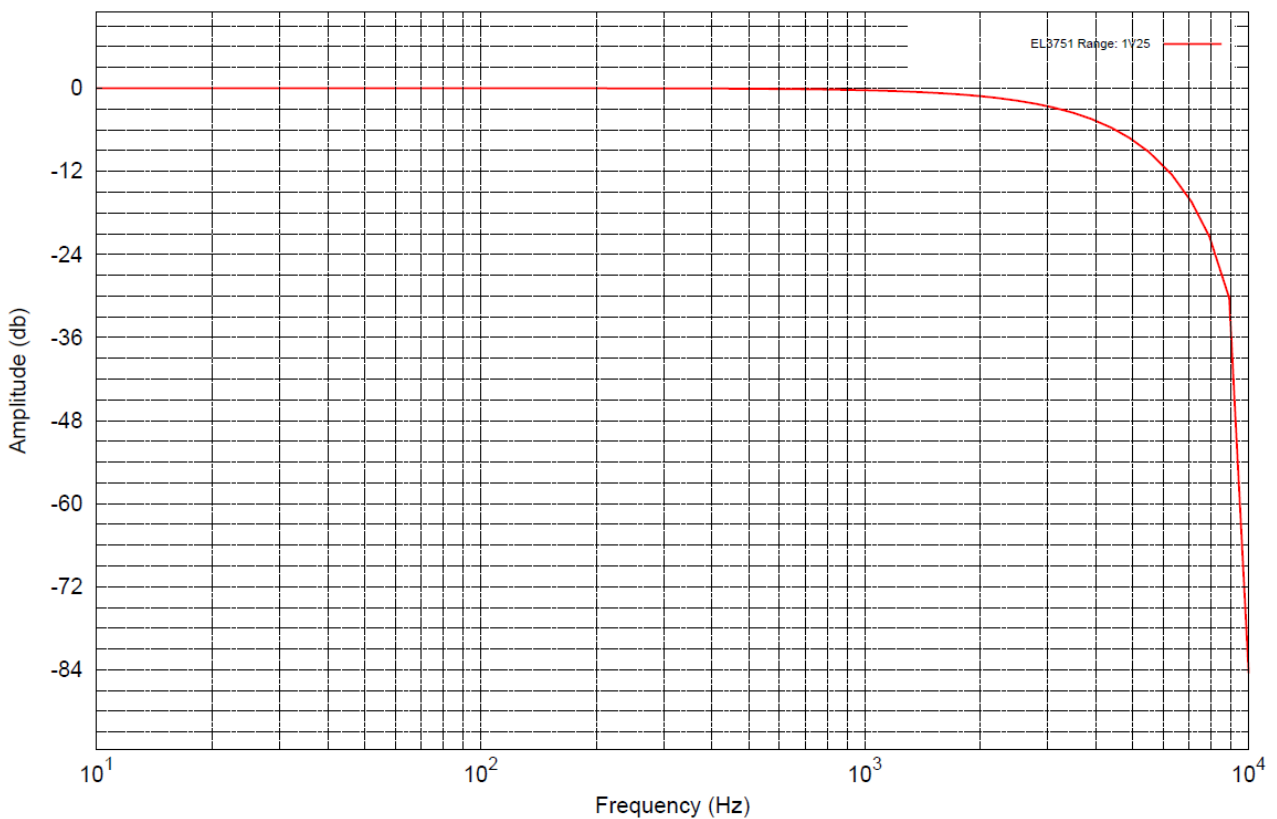

Fig. 15: Frequency response ±1.25 V measurement range,  $f_{\text{sampling}} = 10 \text{ kHz}$ , integrated filter 1/2 deactivated

## 2.2.9 Measurement $\pm 640$ mV

Measurement mode		$\pm 640$ mV		
Measuring range, nominal		-640...+640 mV		
Measuring range, end value (full scale value)		640 mV		
Measuring range, technically usable		-687.2...+687.2 mV		
PDO resolution		24 bit (including sign)		
PDO LSB (Extended Range)		81.92 nV		
PDO LSB (Legacy Range)		76.29.. nV		
Basic accuracy: Measuring deviation at 23°C, with averaging		$< \pm 0.01\%_{\text{FSV}} = \pm 100 \text{ ppm}_{\text{FSV}}$		
Offset/Zero Point deviation (at 23°C)	$E_{\text{Offset}}$	$< 70 \text{ ppm}_{\text{FSV}}$		
Gain/scale/amplification deviation (at 23°C)	$E_{\text{Gain}}$	$< 55 \text{ ppm}$		
Non-linearity over the whole measuring range	$E_{\text{Lin}}$	$< 25 \text{ ppm}_{\text{FSV}}$		
Repeatability	$E_{\text{Rep}}$	$< 20 \text{ ppm}_{\text{FSV}}$		
Noise (without filtering)	$E_{\text{Noise, PTP}}$	$< 90 \text{ ppm}_{\text{FSV}}$	$< 703$ [digits]	
	$E_{\text{Noise, RMS}}$	$< 17 \text{ ppm}_{\text{FSV}}$	$< 133$ [digits]	
	Max. SNR	$> 95.4$ dB		
	Noisedensity@1kHz	$< 0.15 \frac{\mu\text{V}/\text{V}}{\sqrt{\text{Hz}}}$		
Noise (with 50Hz FIR filtering)	$E_{\text{Noise, PTP}}$	$< 9 \text{ ppm}_{\text{FSV}}$	$< 70$ [digits]	
	$E_{\text{Noise, RMS}}$	$< 2.0 \text{ ppm}_{\text{FSV}}$	$< 16$ [digits]	
	Max. SNR	$> 114.0$ dB		
Temperature coefficient	$T_{\text{C}_{\text{Gain}}}$	$< 8 \text{ ppm}/\text{K}$ typ.		
	$T_{\text{C}_{\text{Offset}}}$	$< 5 \text{ ppm}_{\text{FSV}}/\text{K}$ typ.		
Common-mode rejection ratio (without filtering)		DC: $> 115$ dB typ.	50 Hz: $> 105$ dB typ.	1 kHz: $> 80$ dB typ.
Common-mode rejection ratio (with 50Hz FIR filtering)		DC: $> 115$ dB typ.	50 Hz: $> 115$ dB typ.	1 kHz: $> 115$ dB typ.
Largest short-term deviation during a specified electrical interference test		$\pm 0.05\%_{\text{FSV}} = \pm 500 \text{ ppm}_{\text{FSV}}$ typ.		
Input impedance $\pm$ Input 1 (Internal resistance)		Differential $4.1 \text{ M}\Omega \parallel 11 \text{ nF}$ typ.		
		CommonMode $1 \text{ M}\Omega \parallel 40 \text{ nF}$ typ. Methodology: Resistor against $-U_{\text{V}}$ , capacitance against SGND		
Input impedance $\pm$ Input 2		No usage of this input in this mode		



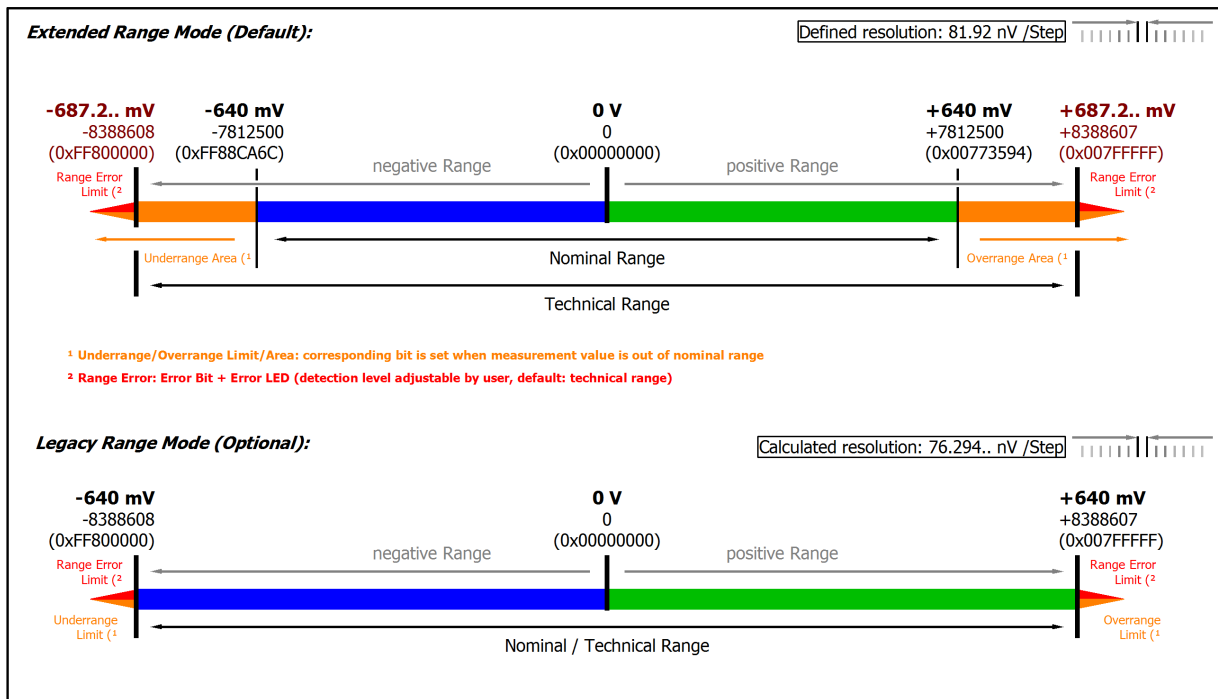

Fig. 16: Representation ±640 mV measurement range

Note: In Extended Range Mode the Underrange/Overrange display in the PDO status has the character of an information/warning when the nominal measuring range is exceeded, i.e. no Error is displayed in the PDO status and LED. If the technical measuring range is also exceeded, Error = TRUE is also displayed. The detection limit for Underrange/Overrange Error can be set in the CoE.

In Legacy Range mode, an Underrange/Overrange event also leads to an Error in the PDO status.

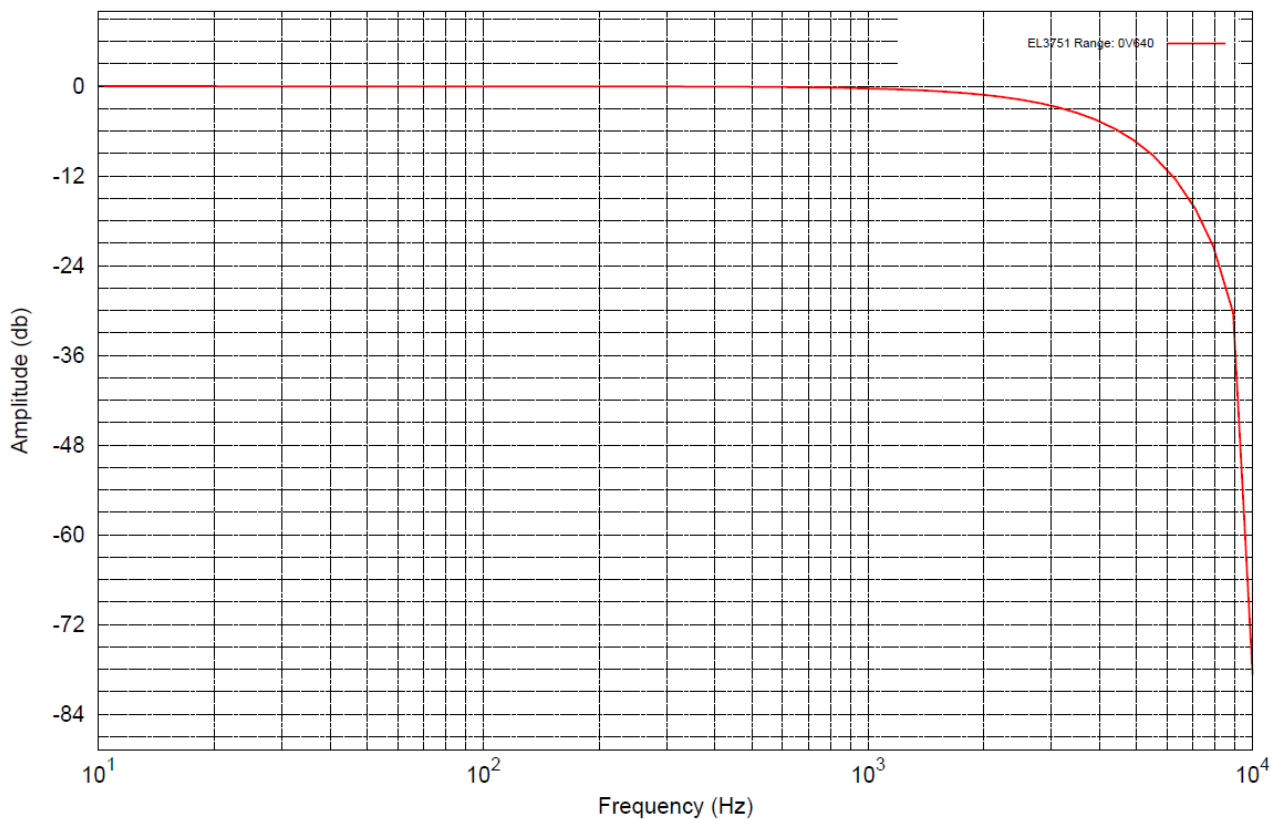

Fig. 17: Frequency response ±640 mV measurement range,  $f_{\text{sampling}} = 10 \text{ kHz}$ , integrated filter 1/2 deactivated

## 2.2.10 Measurement $\pm 320$ mV

Measurement mode		$\pm 320$ mV		
Measuring range, nominal		-320...+320 mV		
Measuring range, end value (full scale value)		320 mV		
Measuring range, technically usable		-343.6...+343.6 mV		
PDO resolution		24 bit (including sign)		
PDO LSB (Extended Range)		40.96 nV		
PDO LSB (Legacy Range)		38.14.. nV		
Basic accuracy: Measuring deviation at 23°C, with averaging		$< \pm 0.01\%_{\text{FSV}} = \pm 100 \text{ ppm}_{\text{FSV}}$		
Offset/Zero Point deviation (at 23°C)	$E_{\text{Offset}}$	$< 70 \text{ ppm}_{\text{FSV}}$		
Gain/scale/amplification deviation (at 23°C)	$E_{\text{Gain}}$	$< 55 \text{ ppm}$		
Non-linearity over the whole measuring range	$E_{\text{Lin}}$	$< 25 \text{ ppm}_{\text{FSV}}$		
Repeatability	$E_{\text{Rep}}$	$< 20 \text{ ppm}_{\text{FSV}}$		
Noise (without filtering)	$E_{\text{Noise, PtP}}$	$< 90 \text{ ppm}_{\text{FSV}}$	$< 703$ [digits]	
	$E_{\text{Noise, RMS}}$	$< 17 \text{ ppm}_{\text{FSV}}$	$< 133$ [digits]	
	Max. SNR	$> 95.4 \text{ dB}$		
	Noisedensity@1kHz	$< 76.93 \frac{\text{nV}}{\sqrt{\text{Hz}}}$		
Noise (with 50Hz FIR filtering)	$E_{\text{Noise, PtP}}$	$< 9 \text{ ppm}_{\text{FSV}}$	$< 70$ [digits]	
	$E_{\text{Noise, RMS}}$	$< 2.0 \text{ ppm}_{\text{FSV}}$	$< 16$ [digits]	
	Max. SNR	$> 114.0 \text{ dB}$		
Temperature coefficient	$T_{\text{C Gain}}$	$< 8 \text{ ppm/K typ.}$		
	$T_{\text{C Offset}}$	$< 5 \text{ ppm}_{\text{FSV}}/\text{K typ.}$		
Common-mode rejection ratio (without filtering)		DC: $> 115 \text{ dB typ.}$	50 Hz: $> 105 \text{ dB typ.}$	1 kHz: $> 80 \text{ dB typ.}$
Common-mode rejection ratio (with 50Hz FIR filtering)		DC: $> 115 \text{ dB typ.}$	50 Hz: $> 115 \text{ dB typ.}$	1 kHz: $> 115 \text{ dB typ.}$
Largest short-term deviation during a specified electrical interference test		$\pm 0.05\%_{\text{FSV}} = \pm 500 \text{ ppm}_{\text{FSV}} \text{ typ.}$		
Input impedance $\pm$ Input 1 (Internal resistance)		Differential 4.1 M $\Omega$    11 nF typ. CommonMode 1 M $\Omega$    40 nF typ. Methodology: Resistor against -U <sub>v</sub> , capacitance against SGND		
Input impedance $\pm$ Input 2		No usage of this input in this mode		

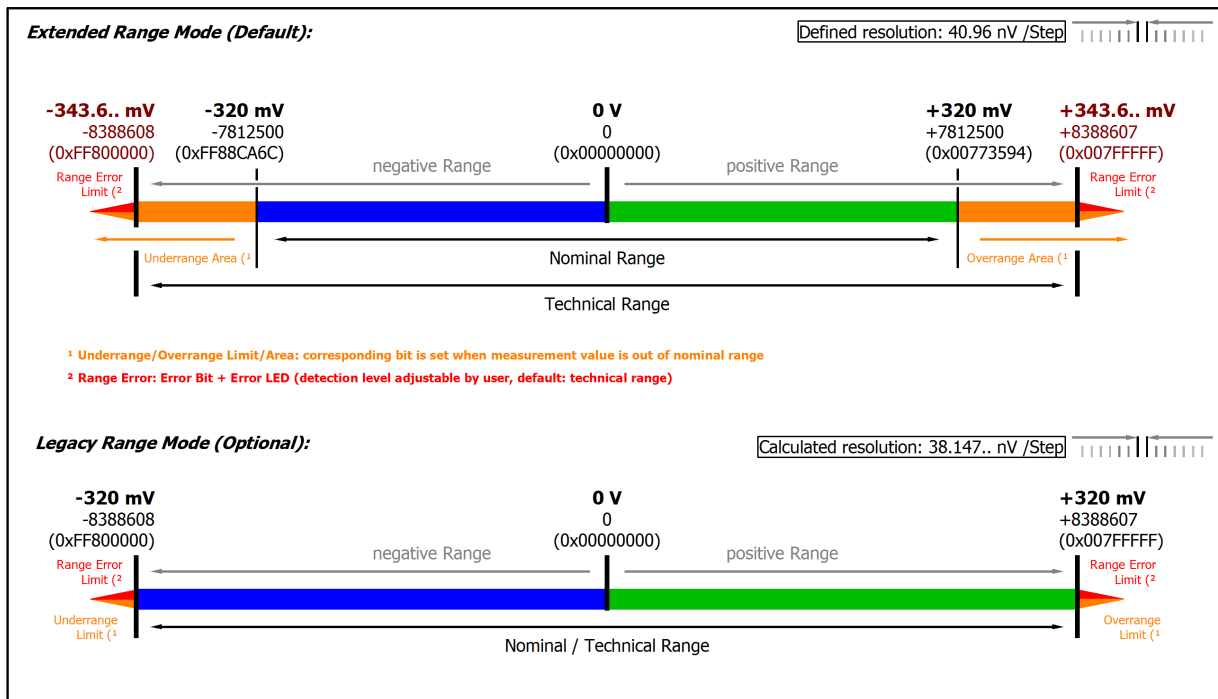

Fig. 18: Representation ±320 mV measurement range

Note: In Extended Range Mode the Underrange/Overrange display in the PDO status has the character of an information/warning when the nominal measuring range is exceeded, i.e. no *Error* is displayed in the PDO status and LED. If the technical measuring range is also exceeded, *Error = TRUE* is also displayed. The detection limit for Underrange/Overrange *Error* can be set in the CoE.

In Legacy Range mode, an Underrange/Overrange event also leads to an *Error* in the PDO status.

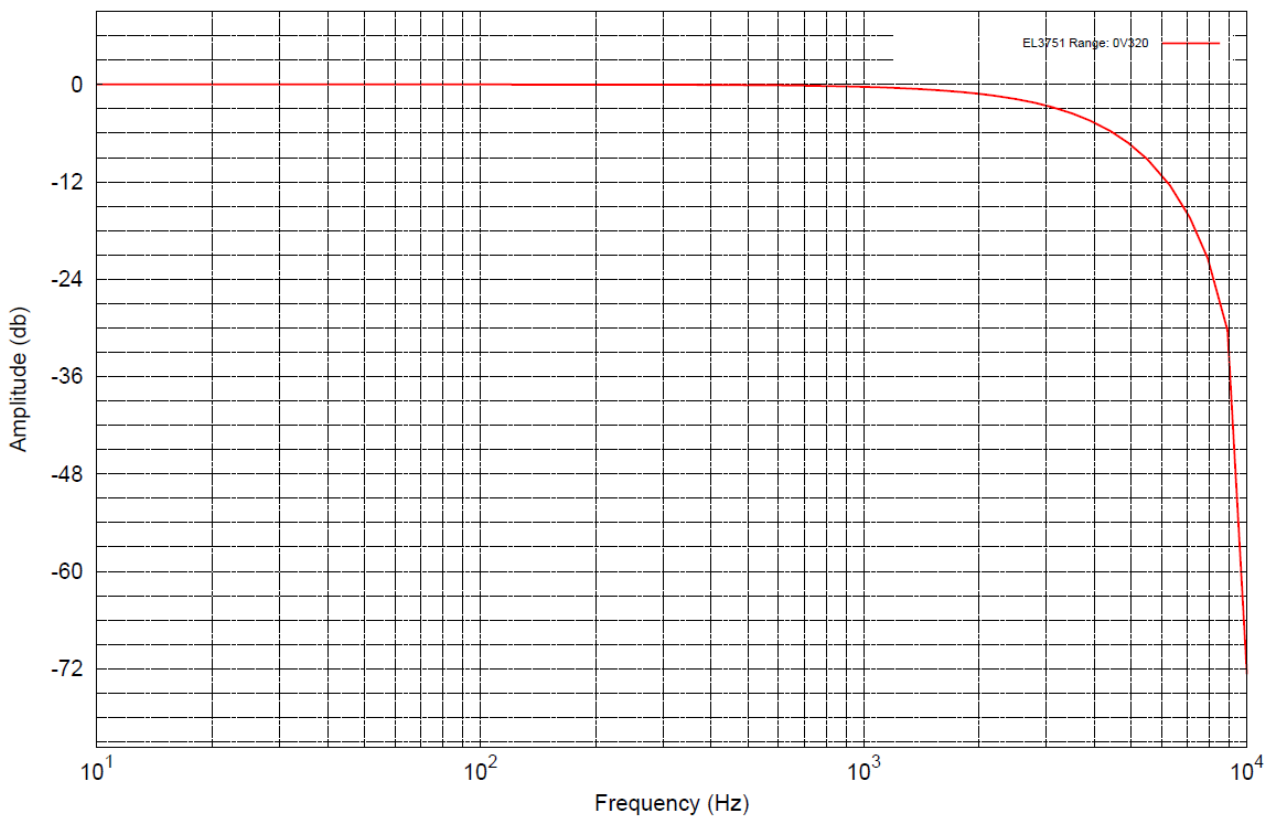

Fig. 19: Frequency response ±320 mV measurement range,  $f_{\text{sampling}} = 10 \text{ kHz}$ , integrated filter 1/2 deactivated

## 2.2.11 Measurement $\pm 160$ mV

Measurement mode		$\pm 160$ mV		
Measuring range, nominal		-160...+160 mV		
Measuring range, end value (full scale value)		160 mV		
Measuring range, technically usable		-171.8...+171.8 mV		
PDO resolution		24 bit (including sign)		
PDO LSB (Extended Range)		20.48 nV		
PDO LSB (Legacy Range)		19.07.. nV		
Basic accuracy: Measuring deviation at 23°C, with averaging		$< \pm 0.01\%_{\text{FSV}} = \pm 100 \text{ ppm}_{\text{FSV}}$		
Offset/Zero Point deviation (at 23°C)	$E_{\text{Offset}}$	$< 70 \text{ ppm}_{\text{FSV}}$		
Gain/scale/amplification deviation (at 23°C)	$E_{\text{Gain}}$	$< 55 \text{ ppm}$		
Non-linearity over the whole measuring range	$E_{\text{Lin}}$	$< 25 \text{ ppm}_{\text{FSV}}$		
Repeatability	$E_{\text{Rep}}$	$< 20 \text{ ppm}_{\text{FSV}}$		
Noise (without filtering)	$E_{\text{Noise, PtP}}$	$< 120 \text{ ppm}_{\text{FSV}}$	$< 938$ [digits]	
	$E_{\text{Noise, RMS}}$	$< 22 \text{ ppm}_{\text{FSV}}$	$< 172$ [digits]	
	Max. SNR	$> 93.2 \text{ dB}$		
	Noisedensity@1kHz	$< 49.78 \frac{\text{nV}}{\sqrt{\text{Hz}}}$		
Noise (with 50Hz FIR filtering)	$E_{\text{Noise, PtP}}$	$< 13 \text{ ppm}_{\text{FSV}}$	$< 102$ [digits]	
	$E_{\text{Noise, RMS}}$	$< 2.5 \text{ ppm}_{\text{FSV}}$	$< 20$ [digits]	
	Max. SNR	$> 112.0 \text{ dB}$		
Temperature coefficient	$T_{\text{C Gain}}$	$< 8 \text{ ppm/K typ.}$		
	$T_{\text{C Offset}}$	$< 5 \text{ ppm}_{\text{FSV}}/\text{K typ.}$		
Common-mode rejection ratio (without filtering)		DC: $> 115 \text{ dB typ.}$	50 Hz: $> 105 \text{ dB typ.}$	1 kHz: $> 80 \text{ dB typ.}$
Common-mode rejection ratio (with 50Hz FIR filtering)		DC: $> 115 \text{ dB typ.}$	50 Hz: $> 115 \text{ dB typ.}$	1 kHz: $> 115 \text{ dB typ.}$
Largest short-term deviation during a specified electrical interference test		$\pm 0.05\%_{\text{FSV}} = \pm 500 \text{ ppm}_{\text{FSV}} \text{ typ.}$		
Input impedance $\pm$ Input 1 (Internal resistance)		Differential $4.1 \text{ M}\Omega \parallel 11 \text{ nF typ.}$ CommonMode $1 \text{ M}\Omega \parallel 40 \text{ nF typ.}$ Methodology: Resistor against $-U_V$ , capacitance against SGND		
Input impedance $\pm$ Input 2		No usage of this input in this mode		

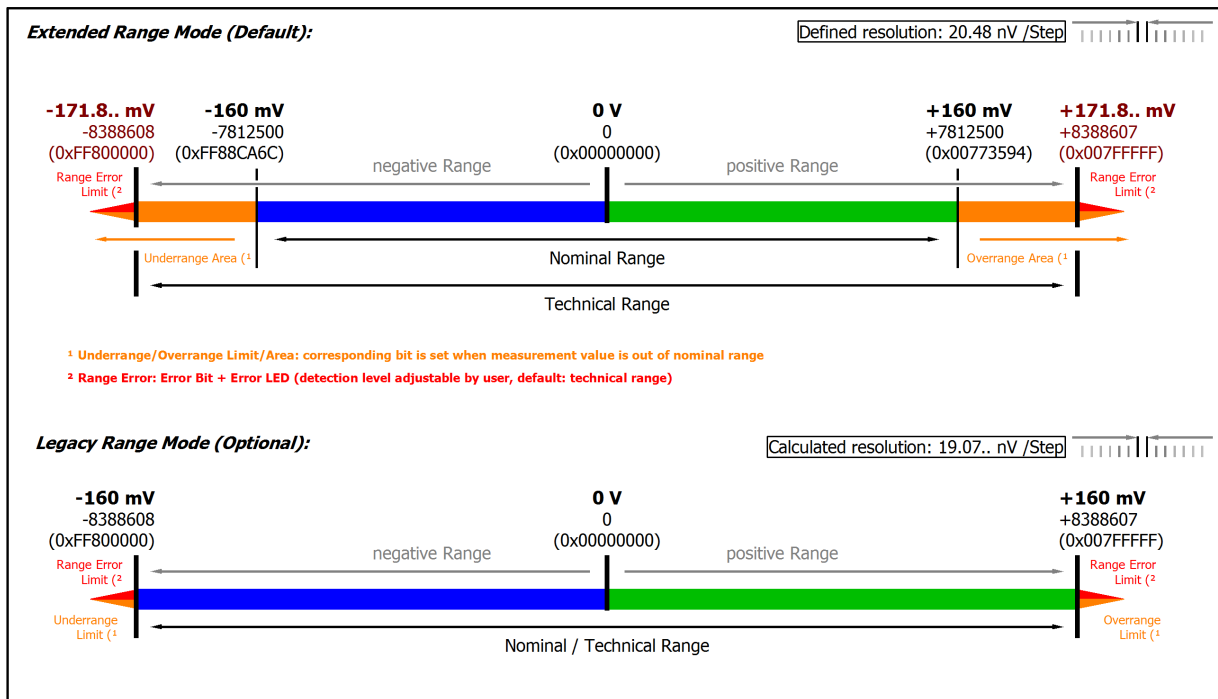

Fig. 20: Representation ±160 mV measurement range

Note: In Extended Range Mode the Underrange/Overrange display in the PDO status has the character of an information/warning when the nominal measuring range is exceeded, i.e. no *Error* is displayed in the PDO status and LED. If the technical measuring range is also exceeded, *Error = TRUE* is also displayed. The detection limit for Underrange/Overrange *Error* can be set in the CoE.

In Legacy Range mode, an Underrange/Overrange event also leads to an *Error* in the PDO status.

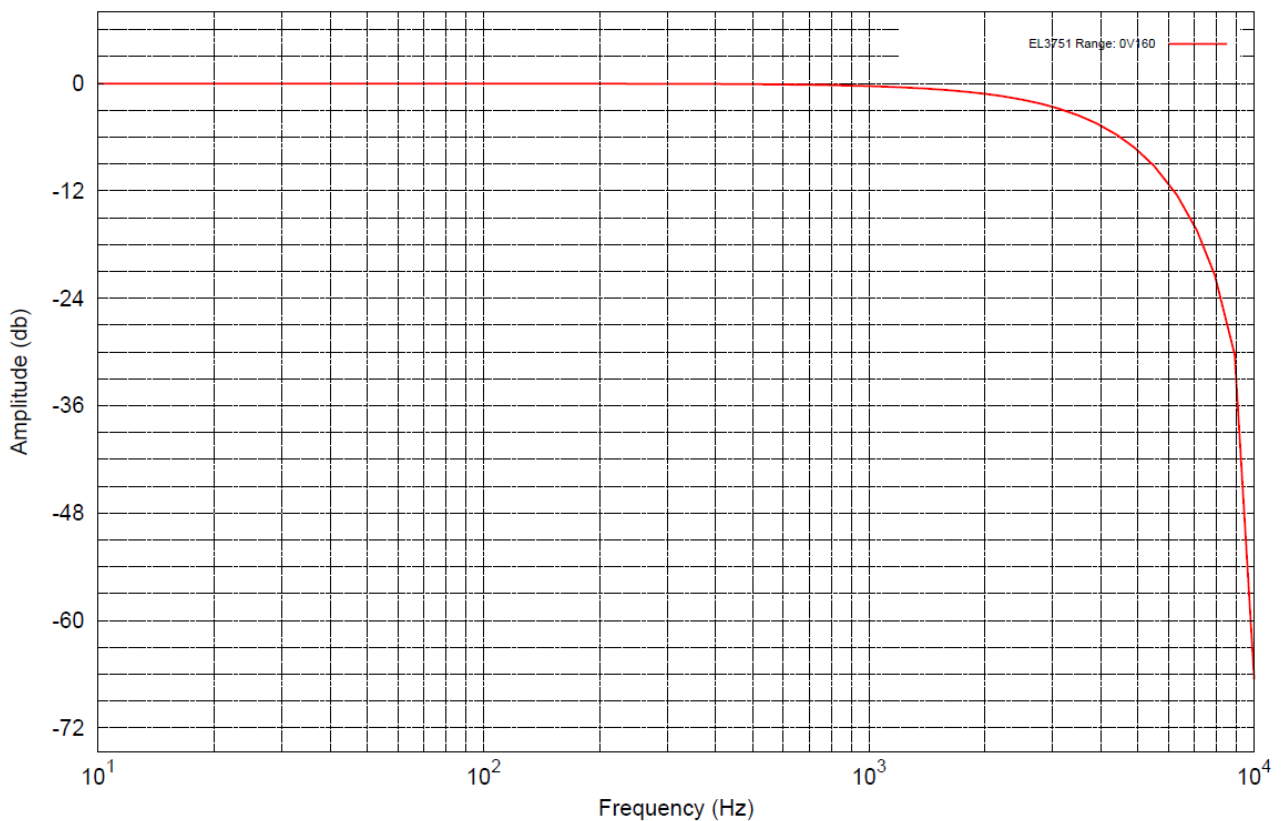

Fig. 21: Frequency response ±160 mV measurement range,  $f_{\text{sampling}} = 10 \text{ kHz}$ , integrated filter 1/2 deactivated

## 2.2.12 Measurement $\pm 80$ mV

Measurement mode		$\pm 80$ mV		
Measuring range, nominal		-80...+80 mV		
Measuring range, end value (full scale value)		80 mV		
Measuring range, technically usable		-85.9...+85.9 mV		
PDO resolution		24 bit (including sign)		
PDO LSB (Extended Range)		10.24 nV		
PDO LSB (Legacy Range)		9.536.. nV		
Basic accuracy: Measuring deviation at 23°C, with averaging		$< \pm 0.01\%_{\text{FSV}} = \pm 100 \text{ ppm}_{\text{FSV}}$		
Offset/Zero Point deviation (at 23°C)	$E_{\text{Offset}}$	$< 70 \text{ ppm}_{\text{FSV}}$		
Gain/scale/amplification deviation (at 23°C)	$E_{\text{Gain}}$	$< 55 \text{ ppm}$		
Non-linearity over the whole measuring range	$E_{\text{Lin}}$	$< 25 \text{ ppm}_{\text{FSV}}$		
Repeatability	$E_{\text{Rep}}$	$< 20 \text{ ppm}_{\text{FSV}}$		
Noise (without filtering)	$E_{\text{Noise, PtP}}$	$< 160 \text{ ppm}_{\text{FSV}}$	$< 1250$ [digits]	
	$E_{\text{Noise, RMS}}$	$< 37 \text{ ppm}_{\text{FSV}}$	$< 289$ [digits]	
	Max. SNR	$> 88.6 \text{ dB}$		
	Noisedensity@1kHz	$< 41.86 \frac{\text{nV}}{\sqrt{\text{Hz}}}$		
Noise (with 50Hz FIR filtering)	$E_{\text{Noise, PtP}}$	$< 18 \text{ ppm}_{\text{FSV}}$	$< 141$ [digits]	
	$E_{\text{Noise, RMS}}$	$< 3.5 \text{ ppm}_{\text{FSV}}$	$< 27$ [digits]	
	Max. SNR	$> 109.1 \text{ dB}$		
Temperature coefficient	$T_{\text{C Gain}}$	$< 8 \text{ ppm/K typ.}$		
	$T_{\text{C Offset}}$	$< 5 \text{ ppm}_{\text{FSV}}/\text{K typ.}$		
Common-mode rejection ratio (without filtering)		DC: $> 115 \text{ dB typ.}$	50 Hz: $> 105 \text{ dB typ.}$	1 kHz: $> 80 \text{ dB typ.}$
Common-mode rejection ratio (with 50Hz FIR filtering)		DC: $> 115 \text{ dB typ.}$	50 Hz: $> 115 \text{ dB typ.}$	1 kHz: $> 115 \text{ dB typ.}$
Largest short-term deviation during a specified electrical interference test		$\pm 0.05\%_{\text{FSV}} = \pm 500 \text{ ppm}_{\text{FSV}} \text{ typ.}$		
Input impedance $\pm$ Input 1 (Internal resistance)		Differential 4.1 M $\Omega$    11 nF typ. CommonMode 1 M $\Omega$    40 nF typ. Methodology: Resistor against -U <sub>v</sub> , capacitance against SGND		
Input impedance $\pm$ Input 2		No usage of this input in this mode		

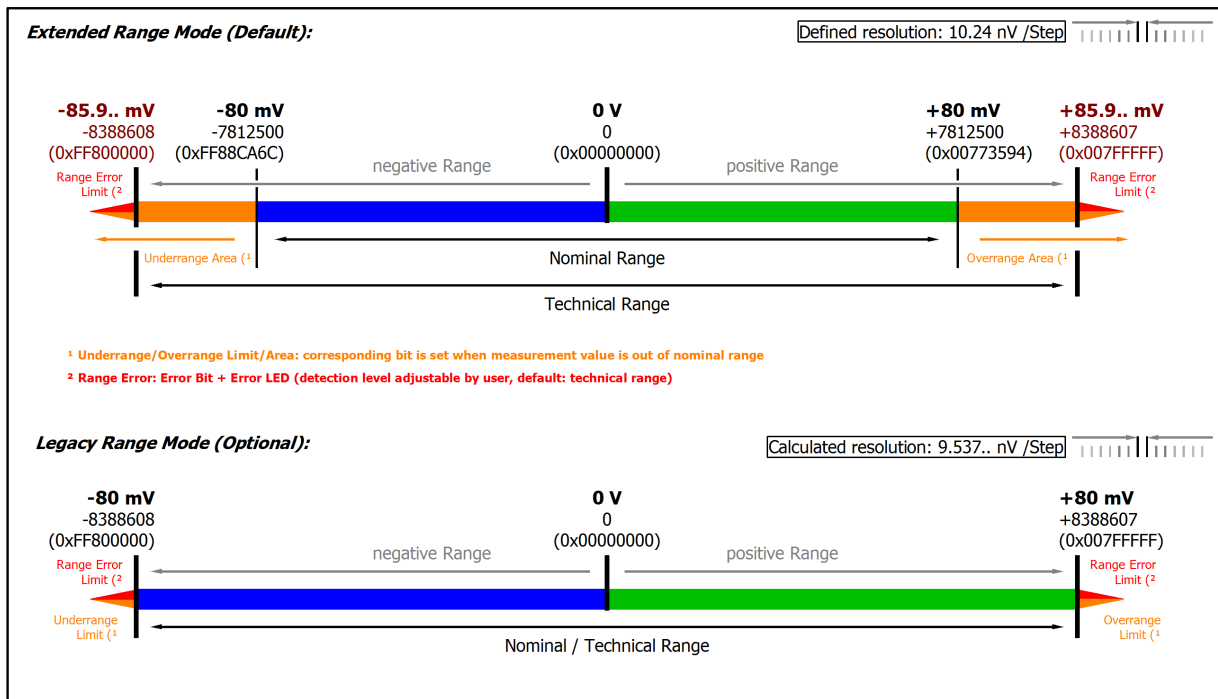

Fig. 22: Representation ±80 mV measurement range

Note: In Extended Range Mode the Underrange/Overrange display in the PDO status has the character of an information/warning when the nominal measuring range is exceeded, i.e. no *Error* is displayed in the PDO status and LED. If the technical measuring range is also exceeded, *Error = TRUE* is also displayed. The detection limit for Underrange/Overrange *Error* can be set in the CoE.

In Legacy Range mode, an Underrange/Overrange event also leads to an *Error* in the PDO status.

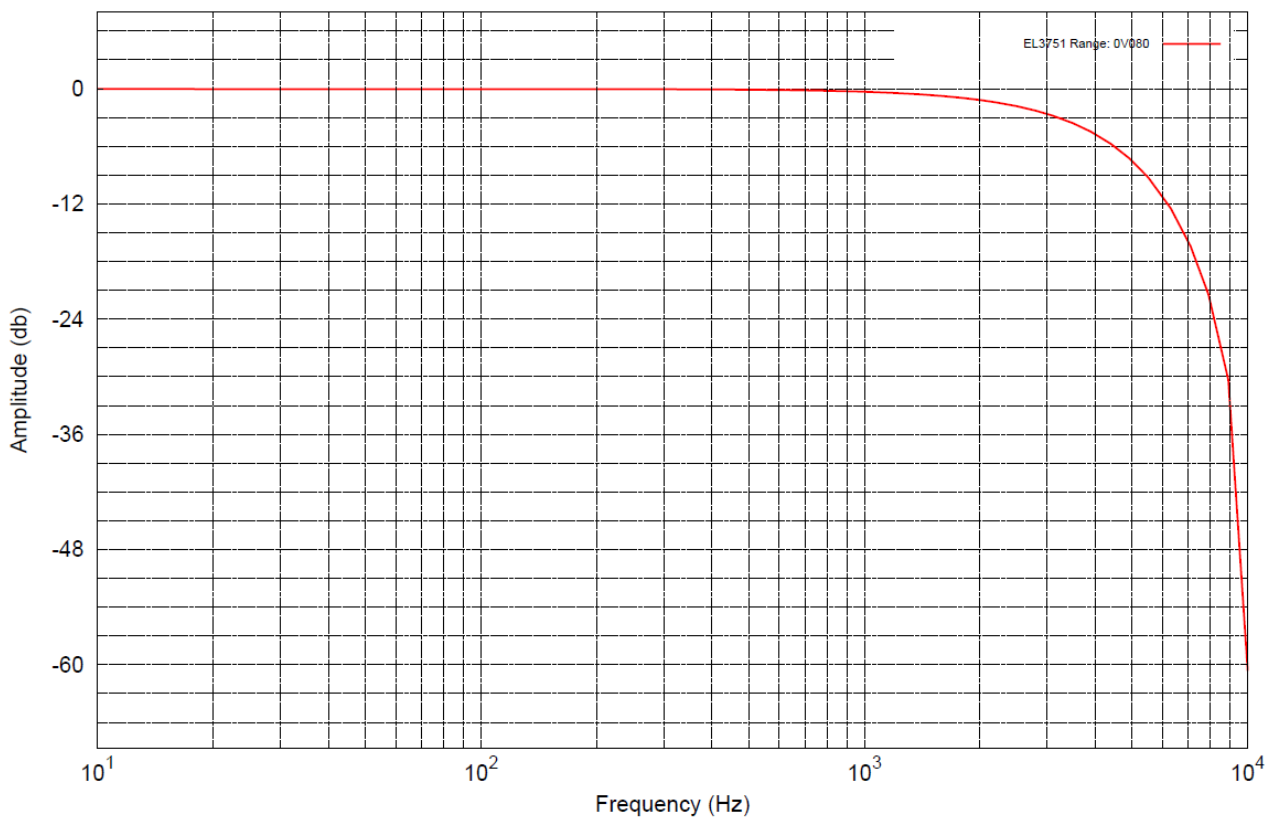

Fig. 23: Frequency response ±80 mV measurement range,  $f_{\text{sampling}} = 10 \text{ kHz}$ , integrated filter 1/2 deactivated

## 2.2.13 Measurement $\pm 40$ mV

Measurement mode		$\pm 40$ mV		
Measuring range, nominal		-40...+40 mV		
Measuring range, end value (full scale value)		40 mV		
Measuring range, technically usable		-42.95...+42.95 V		
PDO resolution		24 bit (including sign)		
PDO LSB (Extended Range)		5.12 nV		
PDO LSB (Legacy Range)		4.768.. nV		
Basic accuracy: Measuring deviation at 23°C, with averaging		$< \pm 0.02\%_{\text{FSV}} = \pm 200 \text{ ppm}_{\text{FSV}}$		
Offset/Zero Point deviation (at 23°C)	$E_{\text{Offset}}$	$< 175 \text{ ppm}_{\text{FSV}}$		
Gain/scale/amplification deviation (at 23°C)	$E_{\text{Gain}}$	$< 65 \text{ ppm}$		
Non-linearity over the whole measuring range	$E_{\text{Lin}}$	$< 45 \text{ ppm}_{\text{FSV}}$		
Repeatability	$E_{\text{Rep}}$	$< 30 \text{ ppm}_{\text{FSV}}$		
Noise (without filtering)	$E_{\text{Noise, PtP}}$	$< 375 \text{ ppm}_{\text{FSV}}$	$< 2930$ [digits]	
	$E_{\text{Noise, RMS}}$	$< 75 \text{ ppm}_{\text{FSV}}$	$< 586$ [digits]	
	Max. SNR	$> 82.5 \text{ dB}$		
	Noisedensity@1kHz	$< 42.43 \frac{\text{nV}}{\sqrt{\text{Hz}}}$		
Noise (with 50Hz FIR filtering)	$E_{\text{Noise, PtP}}$	$< 40 \text{ ppm}_{\text{FSV}}$	$< 313$ [digits]	
	$E_{\text{Noise, RMS}}$	$< 5.5 \text{ ppm}_{\text{FSV}}$	$< 43$ [digits]	
	Max. SNR	$> 105.2 \text{ dB}$		
Temperature coefficient	$T_{\text{C Gain}}$	$< 8 \text{ ppm/K typ.}$		
	$T_{\text{C Offset}}$	$< 6 \text{ ppm}_{\text{FSV}}/\text{K typ.}$		
Common-mode rejection ratio (without filtering)		DC: $> 115 \text{ dB typ.}$	50 Hz: $> 105 \text{ dB typ.}$	1 kHz: $> 80 \text{ dB typ.}$
Common-mode rejection ratio (with 50Hz FIR filtering)		DC: $> 115 \text{ dB typ.}$	50 Hz: $> 115 \text{ dB typ.}$	1 kHz: $> 115 \text{ dB typ.}$
Largest short-term deviation during a specified electrical interference test		$\pm 0.1\%_{\text{FSV}} = \pm 1000 \text{ ppm}_{\text{FSV typ.}}$		
Input impedance $\pm$ Input 1 (Internal resistance)		Differential $4.1 \text{ M}\Omega \parallel 11 \text{ nF typ.}$ CommonMode $1 \text{ M}\Omega \parallel 40 \text{ nF typ.}$ Methodology: Resistor against $-U_V$ , capacitance against SGND		
Input impedance $\pm$ Input 2		No usage of this input in this mode		



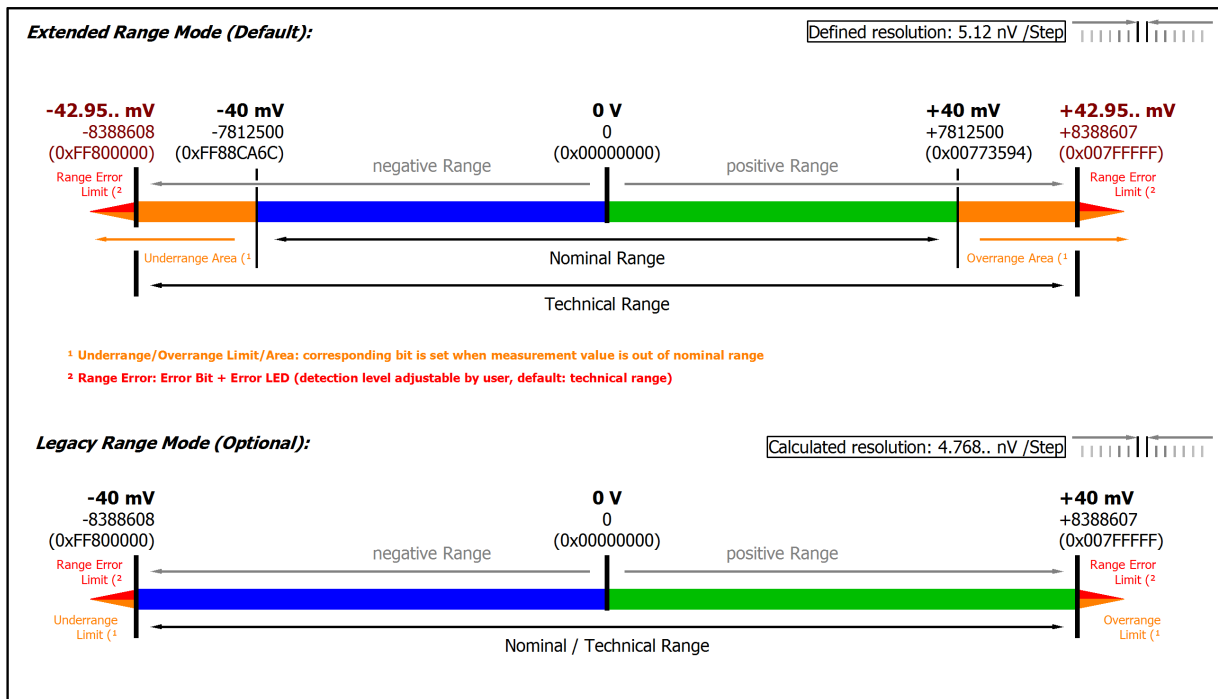

Fig. 24: Representation ±40 mV measurement range

Note: In Extended Range Mode the Underrange/Overrange display in the PDO status has the character of an information/warning when the nominal measuring range is exceeded, i.e. no *Error* is displayed in the PDO status and LED. If the technical measuring range is also exceeded, *Error = TRUE* is also displayed. The detection limit for Underrange/Overrange *Error* can be set in the CoE.

In Legacy Range mode, an Underrange/Overrange event also leads to an *Error* in the PDO status.

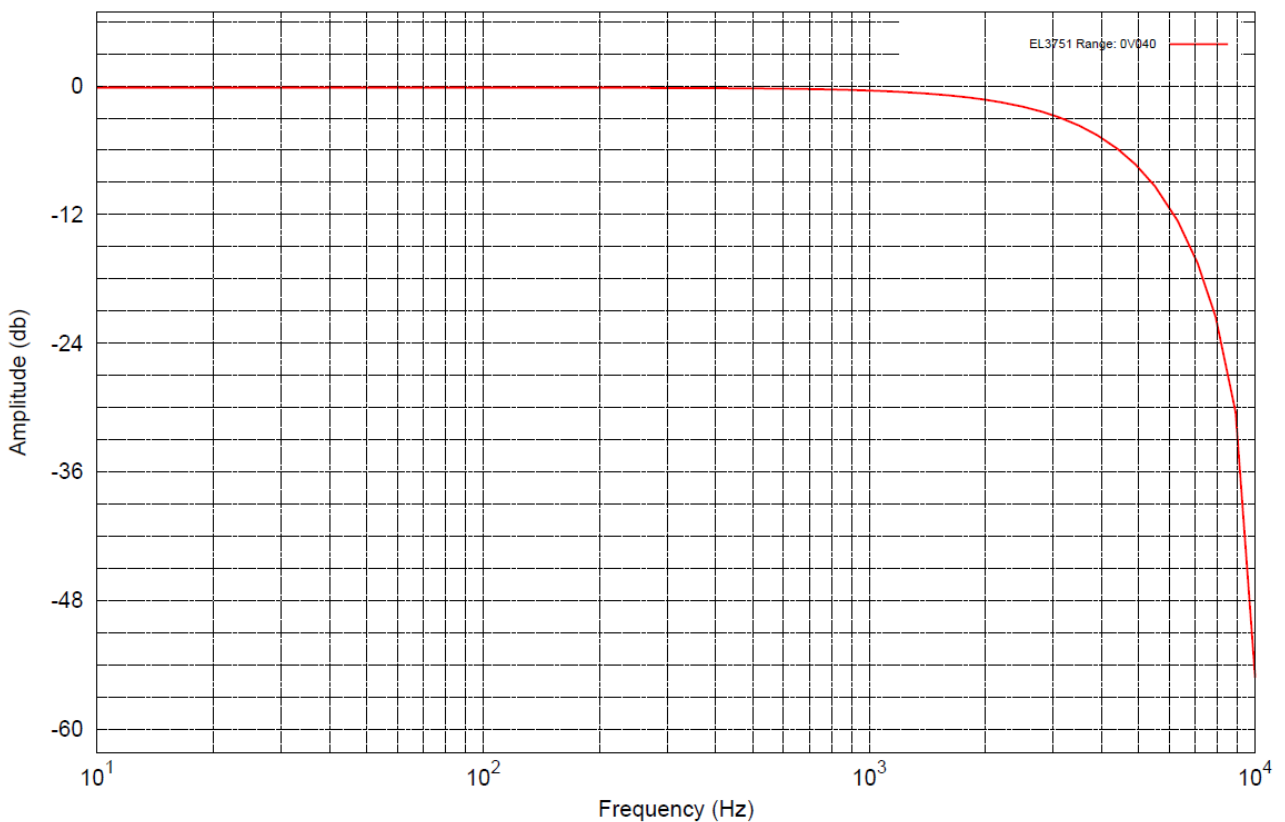

Fig. 25: Frequency response ±40 mV measurement range,  $f_{\text{sampling}} = 10 \text{ kHz}$ , integrated filter 1/2 deactivated

## 2.2.14 Measurement $\pm 20$ mV

Measurement mode		$\pm 20$ mV		
Measuring range, nominal		-20...+20 mV		
Measuring range, end value (full scale value)		20 mV		
Measuring range, technically usable		-21.474...+21.474 mV		
PDO resolution		24 bit (including sign)		
PDO LSB (Extended Range)		2.56 nV		
PDO LSB (Legacy Range)		2.384.. nV		
Basic accuracy: Measuring deviation at 23°C, with averaging		$< \pm 0.03\%_{\text{FSV}} = \pm 300 \text{ ppm}_{\text{FSV}}$		
Offset/Zero Point deviation (at 23°C)	$E_{\text{Offset}}$	$< 260 \text{ ppm}_{\text{FSV}}$		
Gain/scale/amplification deviation (at 23°C)	$E_{\text{Gain}}$	$< 100 \text{ ppm}$		
Non-linearity over the whole measuring range	$E_{\text{Lin}}$	$< 90 \text{ ppm}_{\text{FSV}}$		
Repeatability	$E_{\text{Rep}}$	$< 35 \text{ ppm}_{\text{FSV}}$		
Noise (without filtering)	$E_{\text{Noise, PtP}}$	$< 750 \text{ ppm}_{\text{FSV}}$	$< 5859$ [digits]	
	$E_{\text{Noise, RMS}}$	$< 150 \text{ ppm}_{\text{FSV}}$	$< 1172$ [digits]	
	Max. SNR	$> 76.5 \text{ dB}$		
	Noisedensity@1kHz	$< 42.43 \frac{\text{nV}}{\sqrt{\text{Hz}}}$		
Noise (with 50Hz FIR filtering)	$E_{\text{Noise, PtP}}$	$< 75 \text{ ppm}_{\text{FSV}}$	$< 586$ [digits]	
	$E_{\text{Noise, RMS}}$	$< 11.5 \text{ ppm}_{\text{FSV}}$	$< 90$ [digits]	
	Max. SNR	$> 98.8 \text{ dB}$		
Temperature coefficient	$T_{\text{C Gain}}$	$< 12 \text{ ppm/K typ.}$		
	$T_{\text{C Offset}}$	$< 12 \text{ ppm}_{\text{FSV}}/\text{K typ.}$		
Common-mode rejection ratio (without filtering)		DC: $> 115 \text{ dB typ.}$	50 Hz: $> 105 \text{ dB typ.}$	1 kHz: $> 80 \text{ dB typ.}$
Common-mode rejection ratio (with 50Hz FIR filtering)		DC: $> 115 \text{ dB typ.}$	50 Hz: $> 115 \text{ dB typ.}$	1 kHz: $> 115 \text{ dB typ.}$
Largest short-term deviation during a specified electrical interference test		$\pm 0.1\%_{\text{FSV}} = \pm 1000 \text{ ppm}_{\text{FSV}} \text{ typ.}$		
Input impedance $\pm$ Input 1 (Internal resistance)		Differential $4.1 \text{ M}\Omega \parallel 11 \text{ nF typ.}$ CommonMode $1 \text{ M}\Omega \parallel 40 \text{ nF typ.}$ Methodology: Resistor against $-U_v$ , capacitance against SGND		
Input impedance $\pm$ Input 2		No usage of this input in this mode		

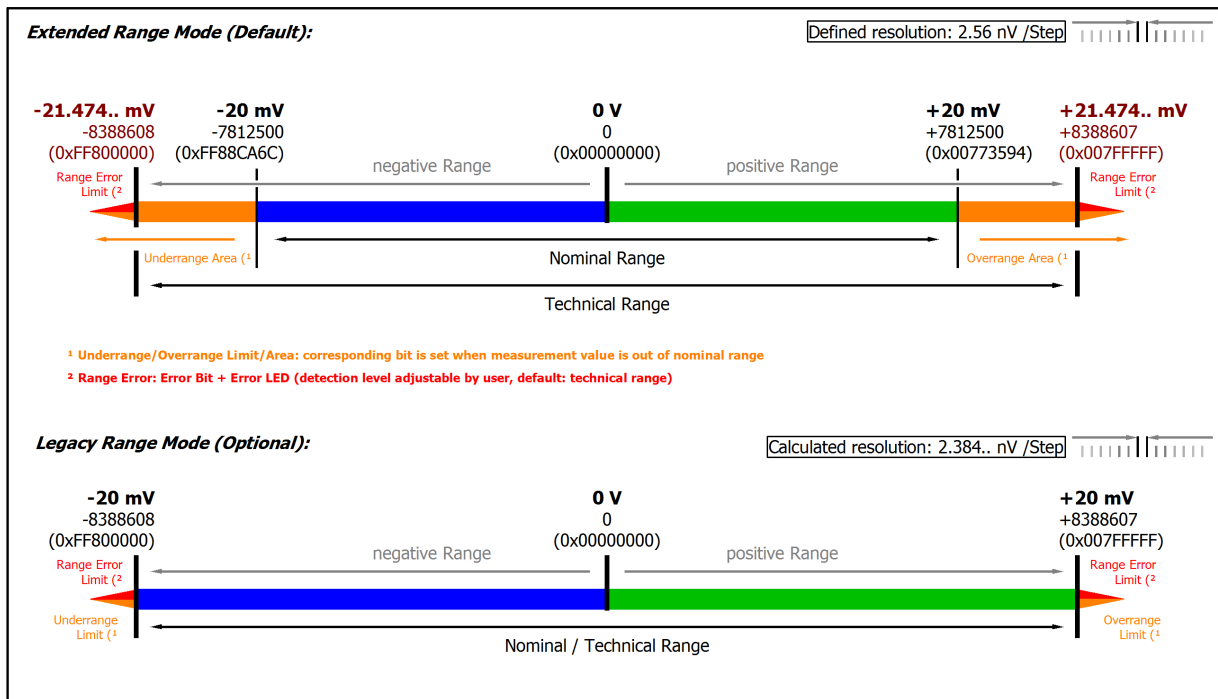

Fig. 26: Representation ±20 mV measurement range

Note: In Extended Range Mode the Underrange/Overrange display in the PDO status has the character of an information/warning when the nominal measuring range is exceeded, i.e. no *Error* is displayed in the PDO status and LED. If the technical measuring range is also exceeded, *Error = TRUE* is also displayed. The detection limit for Underrange/Overrange *Error* can be set in the CoE.

In Legacy Range mode, an Underrange/Overrange event also leads to an *Error* in the PDO status.

## 2.2.15 Measurement $\pm 10$ mV

Measurement mode		$\pm 10$ mV		
Measuring range, nominal		-10...+10 mV		
Measuring range, end value (full scale value)		10 mV		
Measuring range, technically usable		-10.737...+10.737 mV		
PDO resolution		24 bit (including sign)		
PDO LSB (Extended Range)		1.28 nV		
PDO LSB (Legacy Range)		1.192.. nV		
Basic accuracy: Measuring deviation at 23°C, with averaging		$< \pm 0.06\%_{\text{FSV}} = \pm 600 \text{ ppm}_{\text{FSV}}$		
Offset/Zero Point deviation (at 23°C)	$E_{\text{Offset}}$	$< 550 \text{ ppm}_{\text{FSV}}$		
Gain/scale/amplification deviation (at 23°C)	$E_{\text{Gain}}$	$< 150 \text{ ppm}$		
Non-linearity over the whole measuring range	$E_{\text{Lin}}$	$< 160 \text{ ppm}_{\text{FSV}}$		
Repeatability	$E_{\text{Rep}}$	$< 50 \text{ ppm}_{\text{FSV}}$		
Noise (without filtering)	$E_{\text{Noise, PtP}}$	$< 1200 \text{ ppm}_{\text{FSV}}$	$< 9375$ [digits]	
	$E_{\text{Noise, RMS}}$	$< 200 \text{ ppm}_{\text{FSV}}$	$< 1563$ [digits]	
	Max. SNR	$> 74.0 \text{ dB}$		
	Noisedensity@1kHz	$< 28.28 \frac{\text{nV}}{\sqrt{\text{Hz}}}$		
Noise (with 50Hz FIR filtering)	$E_{\text{Noise, PtP}}$	$< 120 \text{ ppm}_{\text{FSV}}$	$< 938$ [digits]	
	$E_{\text{Noise, RMS}}$	$< 21.0 \text{ ppm}_{\text{FSV}}$	$< 164$ [digits]	
	Max. SNR	$> 93.6 \text{ dB}$		
Temperature coefficient	$T_{\text{C Gain}}$	$< 22 \text{ ppm/K typ.}$		
	$T_{\text{C Offset}}$	$< 20 \text{ ppm}_{\text{FSV}}/\text{K typ.}$		
Common-mode rejection ratio (without filtering)		DC: $> 115 \text{ dB typ.}$	50 Hz: $> 105 \text{ dB typ.}$	1 kHz: $> 80 \text{ dB typ.}$
Common-mode rejection ratio (with 50Hz FIR filtering)		DC: $> 115 \text{ dB typ.}$	50 Hz: $> 115 \text{ dB typ.}$	1 kHz: $> 115 \text{ dB typ.}$
Largest short-term deviation during a specified electrical interference test		$\pm 0.2\%_{\text{FSV}} = \pm 2000 \text{ ppm}_{\text{FSV}} \text{ typ.}$		
Input impedance $\pm$ Input 1 (Internal resistance)		Differential $4.1 \text{ M}\Omega \parallel 11 \text{ nF typ.}$ CommonMode $1 \text{ M}\Omega \parallel 40 \text{ nF typ.}$ Methodology: Resistor against $-U_V$ , capacitance against SGND		
Input impedance $\pm$ Input 2		No usage of this input in this mode		

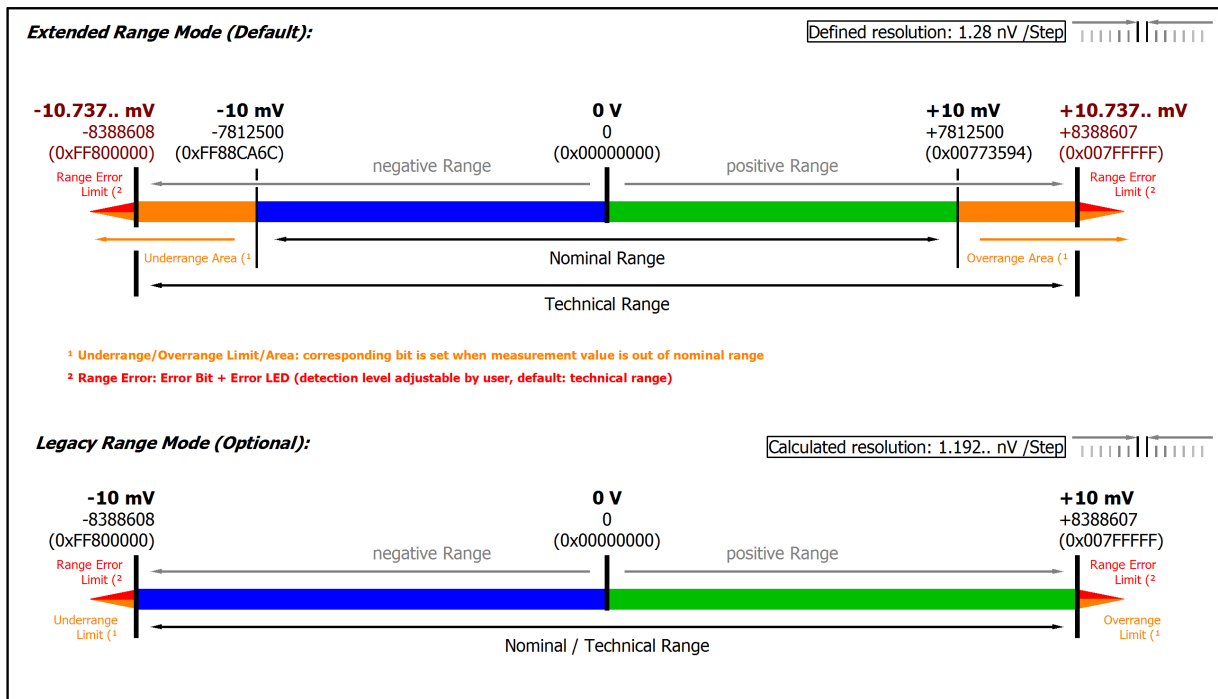

Fig. 27: Representation ±10 mV measurement range

Note: In Extended Range Mode the Underrange/Overrange display in the PDO status has the character of an information/warning when the nominal measuring range is exceeded, i.e. no *Error* is displayed in the PDO status and LED. If the technical measuring range is also exceeded, *Error = TRUE* is also displayed. The detection limit for Underrange/Overrange *Error* can be set in the CoE.

In Legacy Range mode, an Underrange/Overrange event also leads to an *Error* in the PDO status.

## 2.2.16 Measurement $\pm 5$ mV

Measurement mode		$\pm 5$ mV		
Measuring range, nominal		-5...+5 mV		
Measuring range, end value (full scale value)		5 mV		
Measuring range, technically usable		-5.368...+5.368 mV		
PDO resolution		24 bit (including sign)		
PDO LSB (Extended Range)		0.64 nV		
PDO LSB (Legacy Range)		0.596.. nV		
Basic accuracy: Measuring deviation at 23°C, with averaging		$< \pm 0.12\%_{\text{FSV}} = \pm 1200 \text{ ppm}_{\text{FSV}}$		
Offset/Zero Point deviation (at 23°C)	$E_{\text{Offset}}$	$< 1120 \text{ ppm}_{\text{FSV}}$		
Gain/scale/amplification deviation (at 23°C)	$E_{\text{Gain}}$	$< 290 \text{ ppm}$		
Non-linearity over the whole measuring range	$E_{\text{Lin}}$	$< 290 \text{ ppm}_{\text{FSV}}$		
Repeatability	$E_{\text{Rep}}$	$< 90 \text{ ppm}_{\text{FSV}}$		
Noise (without filtering)	$E_{\text{Noise, PtP}}$	$< 2400 \text{ ppm}_{\text{FSV}}$	$< 18750$ [digits]	
	$E_{\text{Noise, RMS}}$	$< 380 \text{ ppm}_{\text{FSV}}$	$< 2969$ [digits]	
	Max. SNR	$> 68.4 \text{ dB}$		
	Noisedensity@1kHz	$< 26.87 \frac{\text{nV}}{\sqrt{\text{Hz}}}$		
Noise (with 50Hz FIR filtering)	$E_{\text{Noise, PtP}}$	$< 240 \text{ ppm}_{\text{FSV}}$	$< 1875$ [digits]	
	$E_{\text{Noise, RMS}}$	$< 42.0 \text{ ppm}_{\text{FSV}}$	$< 328$ [digits]	
	Max. SNR	$> 87.5 \text{ dB}$		
Temperature coefficient	$T_{\text{C Gain}}$	$< 35 \text{ ppm/K typ.}$		
	$T_{\text{C Offset}}$	$< 35 \text{ ppm}_{\text{FSV}}/\text{K typ.}$		
Common-mode rejection ratio (without filtering)		DC: $> 115 \text{ dB typ.}$	50 Hz: $> 105 \text{ dB typ.}$	1 kHz: $> 80 \text{ dB typ.}$
Common-mode rejection ratio (with 50Hz FIR filtering)		DC: $> 115 \text{ dB typ.}$	50 Hz: $> 115 \text{ dB typ.}$	1 kHz: $> 115 \text{ dB typ.}$
Largest short-term deviation during a specified electrical interference test		$\pm 0.2\%_{\text{FSV}} = \pm 2000 \text{ ppm}_{\text{FSV}} \text{ typ.}$		
Input impedance $\pm$ Input 1 (Internal resistance)		Differential $4.1 \text{ M}\Omega \parallel 11 \text{ nF typ.}$ CommonMode $1 \text{ M}\Omega \parallel 40 \text{ nF typ.}$ Methodology: Resistor against $-U_v$ , capacitance against SGND		
Input impedance $\pm$ Input 2		No usage of this input in this mode		

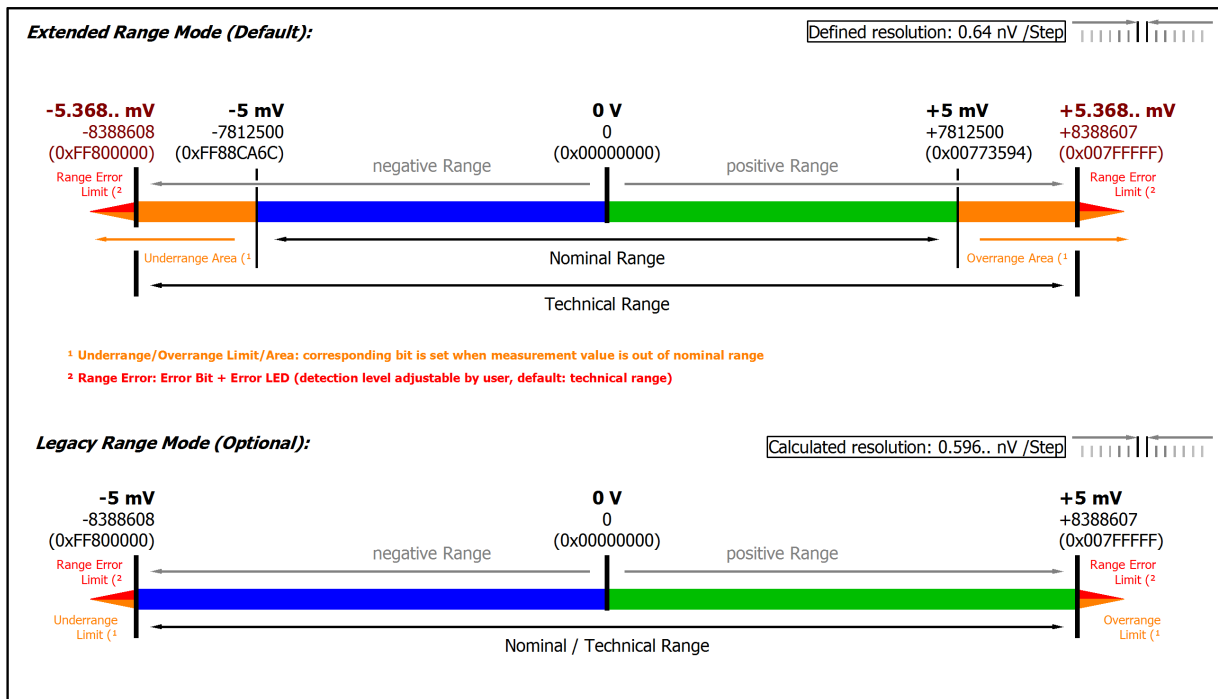

Fig. 28: Representation ±5 mV measurement range

Note: In Extended Range Mode the Underrange/Overrange display in the PDO status has the character of an information/warning when the nominal measuring range is exceeded, i.e. no *Error* is displayed in the PDO status and LED. If the technical measuring range is also exceeded, *Error = TRUE* is also displayed. The detection limit for Underrange/Overrange *Error* can be set in the CoE.

In Legacy Range mode, an Underrange/Overrange event also leads to an *Error* in the PDO status.

## 2.2.17 Measurement 0...5 V

Measurement mode		0...5 V		
Measuring range, nominal		0...5 V		
Measuring range, end value (full scale value)		5 V		
Measuring range, technically usable		0...5.368 V		
PDO resolution		23 bit (unsigned)		
PDO LSB (Extended Range)		0.64 $\mu$ V		
Basic accuracy: Measuring deviation at 23°C, with averaging		$< \pm 0.01\%_{\text{FSV}} = \pm 100 \text{ ppm}_{\text{FSV}}$		
Offset/Zero Point deviation (at 23°C)	$E_{\text{Offset}}$	$< 70 \text{ ppm}_{\text{FSV}}$		
Gain/scale/amplification deviation (at 23°C)	$E_{\text{Gain}}$	$< 55 \text{ ppm}$		
Non-linearity over the whole measuring range	$E_{\text{Lin}}$	$< 25 \text{ ppm}_{\text{FSV}}$		
Repeatability	$E_{\text{Rep}}$	$< 20 \text{ ppm}_{\text{FSV}}$		
Noise (without filtering)	$E_{\text{Noise, PtP}}$	$< 100 \text{ ppm}_{\text{FSV}}$	$< 781 \text{ [digits]}$	
	$E_{\text{Noise, RMS}}$	$< 18 \text{ ppm}_{\text{FSV}}$	$< 141 \text{ [digits]}$	
	Max. SNR	$> 94.9 \text{ dB}$		
	Noisedensity@1kHz	$< 1.27 \frac{\mu\text{V}/\text{V}}{\sqrt{\text{Hz}}}$		
Noise (with 50Hz FIR filtering)	$E_{\text{Noise, PtP}}$	$< 10 \text{ ppm}_{\text{FSV}}$	$< 78 \text{ [digits]}$	
	$E_{\text{Noise, RMS}}$	$< 2.0 \text{ ppm}_{\text{FSV}}$	$< 16 \text{ [digits]}$	
	Max. SNR	$> 114.0 \text{ dB}$		
Temperature coefficient	$T_{\text{C Gain}}$	$< 8 \text{ ppm/K typ.}$		
	$T_{\text{C Offset}}$	$< 5 \text{ ppm}_{\text{FSV}}/\text{K typ.}$		
Common-mode rejection ratio (without filtering)		DC: $> 115 \text{ dB typ.}$	50 Hz: $> 105 \text{ dB typ.}$	1 kHz: $> 80 \text{ dB typ.}$
Common-mode rejection ratio (with 50Hz FIR filtering)		DC: $> 115 \text{ dB typ.}$	50 Hz: $> 115 \text{ dB typ.}$	1 kHz: $> 115 \text{ dB typ.}$
Largest short-term deviation during a specified electrical interference test		$\pm 0.05\%_{\text{FSV}} = \pm 500 \text{ ppm}_{\text{FSV}} \text{ typ.}$		
Input impedance $\pm$ Input 1 (Internal resistance)		Differential $4.1 \text{ M}\Omega \parallel 11 \text{ nF typ.}$ CommonMode $1 \text{ M}\Omega \parallel 40 \text{ nF typ.}$ Methodology: Resistor against $-U_{\text{V}}$ , capacitance against SGND		
Input impedance $\pm$ Input 2		No usage of this input in this mode		



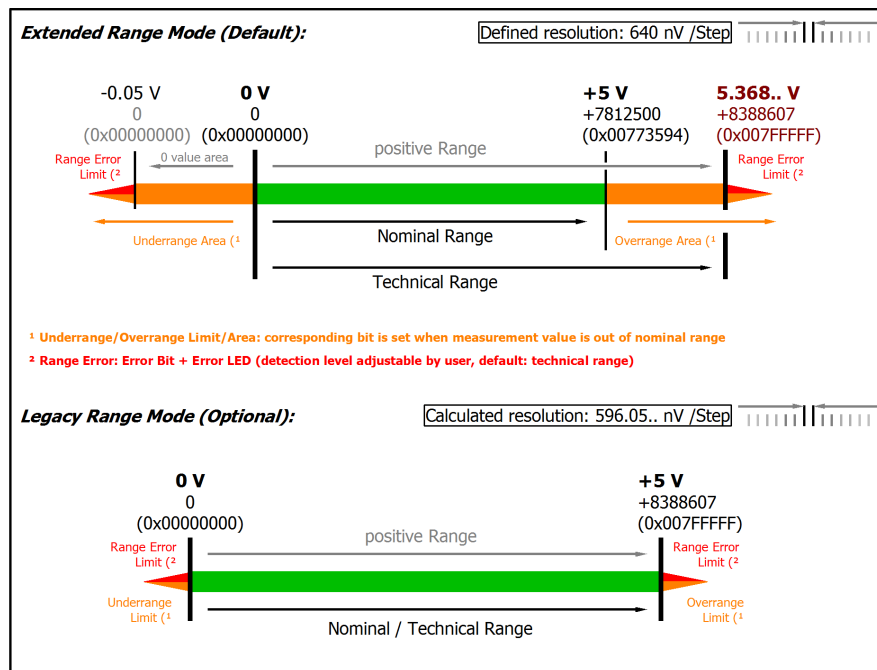

Fig. 29: Representation 0...5 V measurement range

Note: The channel also works in electrically bipolar mode and records negative values in the unipolar measuring ranges (measurement from 0 V, 0 mA, 4 mA, 0 Ω). This enables the channel to provide a precise diagnosis even with signals < 0. In these measuring ranges the limit value for the "Underrange Error" in Extended Mode is -1% of the full scale value (FSV). The limit value can be set in CoE object 0x80n0:32 [▶ 95]. This avoids irritating error messages if the channel is not wired (e.g. without sensor) or the electrical signal fluctuates slightly around zero. The process data value of 0x00000000 is not undershot.

If the "UnderrangeError" detection is to be set even less sensitive, the magnitude of the negative limit value in the CoE object referred to above can be set even higher.

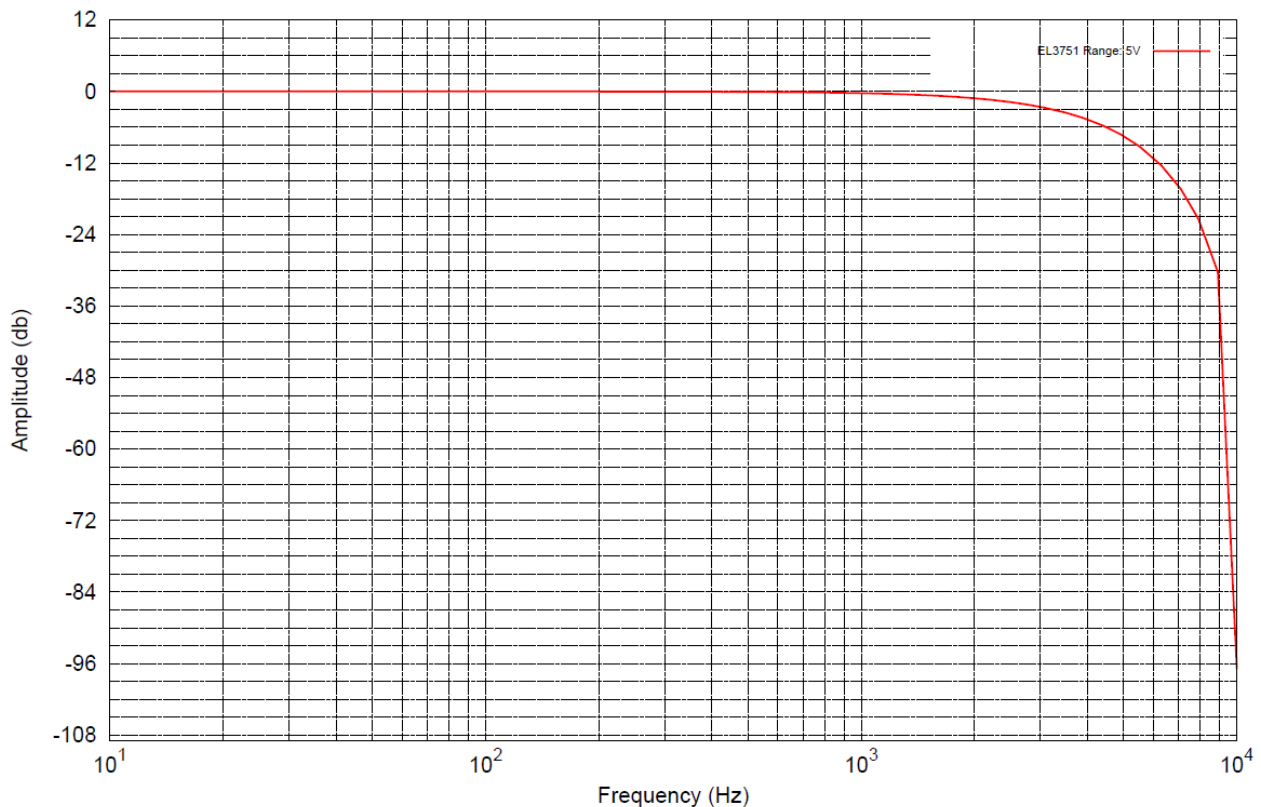

Fig. 30: Frequency response 0...5 V measurement range,  $f_{\text{sampling}} = 10 \text{ kHz}$ , integrated filter 1/2 deactivated

## 2.2.18 Measurement 0...10 V

Measurement mode		0...10 V		
Measuring range, nominal		0...10 V		
Measuring range, end value (full scale value)		10 V		
Measuring range, technically usable		0...+10.737 V		
PDO resolution		23 bit (unsigned)		
PDO LSB (Extended Range)		1.28 $\mu$ V		
Basic accuracy: Measuring deviation at 23°C, with averaging		< $\pm 0.01\%_{\text{FSV}} = \pm 100 \text{ ppm}_{\text{FSV}}$		
Offset/Zero Point deviation (at 23°C)	$E_{\text{Offset}}$	< 70 $\text{ppm}_{\text{FSV}}$		
Gain/scale/amplification deviation (at 23°C)	$E_{\text{Gain}}$	< 60 ppm		
Non-linearity over the whole measuring range	$E_{\text{Lin}}$	< 25 $\text{ppm}_{\text{FSV}}$		
Repeatability	$E_{\text{Rep}}$	< 20 $\text{ppm}_{\text{FSV}}$		
Noise (without filtering)	$E_{\text{Noise, PtP}}$	< 100 $\text{ppm}_{\text{FSV}}$	< 781 [digits]	
	$E_{\text{Noise, RMS}}$	< 18 $\text{ppm}_{\text{FSV}}$	< 141 [digits]	
	Max. SNR	> 94.9 dB		
	Noisedensity@1kHz	< $2.55 \frac{\mu\text{V}/\text{V}}{\sqrt{\text{Hz}}}$		
Noise (with 50Hz FIR filtering)	$E_{\text{Noise, PtP}}$	< 10 $\text{ppm}_{\text{FSV}}$	< 78 [digits]	
	$E_{\text{Noise, RMS}}$	< 2.0 $\text{ppm}_{\text{FSV}}$	< 16 [digits]	
	Max. SNR	> 114.0 dB		
Temperature coefficient	$T_{\text{C}_{\text{Gain}}}$	< 8 ppm/K typ.		
	$T_{\text{C}_{\text{Offset}}}$	< 5 $\text{ppm}_{\text{FSV}}/\text{K}$ typ.		
Common-mode rejection ratio (without filtering)		DC: >115 dB typ.	50 Hz: >105 dB typ.	1 kHz: >80 dB typ.
Common-mode rejection ratio (with 50Hz FIR filtering)		DC: >115 dB typ.	50 Hz: >115 dB typ.	1 kHz: >115 dB typ.
Largest short-term deviation during a specified electrical interference test		$\pm 0.05\%_{\text{FSV}} = \pm 500 \text{ ppm}_{\text{FSV}}$ typ.		
Input impedance $\pm$ Input 1 (Internal resistance)		Differential 4.1 M $\Omega$    11 nF typ. CommonMode 1 M $\Omega$    40 nF typ. Methodology: Resistor against -U <sub>v</sub> , capacitance against SGND		
Input impedance $\pm$ Input 2		No usage of this input in this mode		

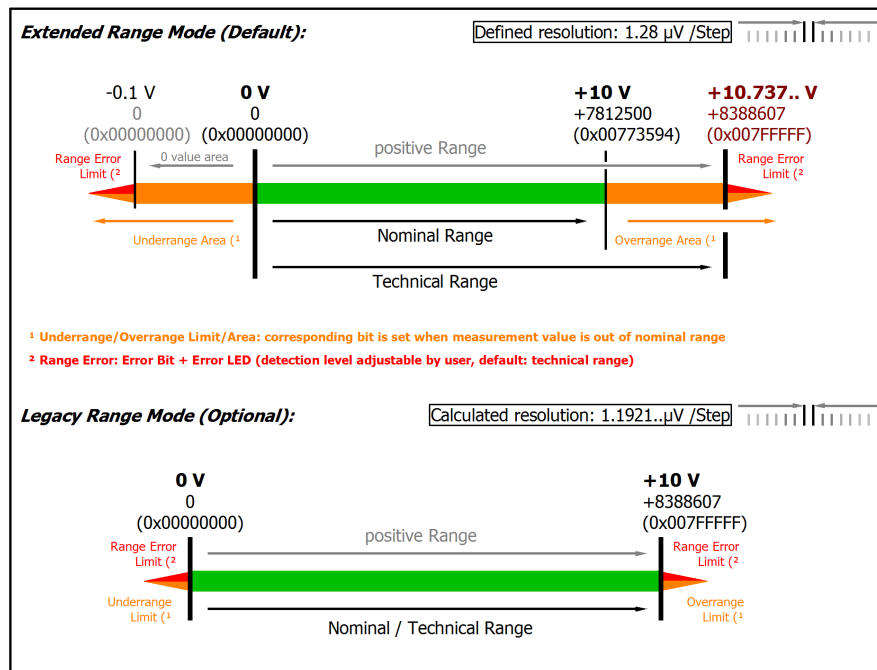

Fig. 31: Representation 0...10 V measurement range

Note: The channel also works in electrically bipolar mode and records negative values in the unipolar measuring ranges (measurement from 0 V, 0 mA, 4 mA, 0 Ω). This enables the channel to provide a precise diagnosis even with signals < 0. In these measuring ranges the limit value for the "Underrange Error" in Extended Mode is -1% of the full scale value (FSV). The limit value can be set in CoE object 0x80n0:32 [▶ 95]. This avoids irritating error messages if the channel is not wired (e.g. without sensor) or the electrical signal fluctuates slightly around zero. The process data value of 0x00000000 is not undershot.

If the "UnderrangeError" detection is to be set even less sensitive, the magnitude of the negative limit value in the CoE object referred to above can be set even higher.

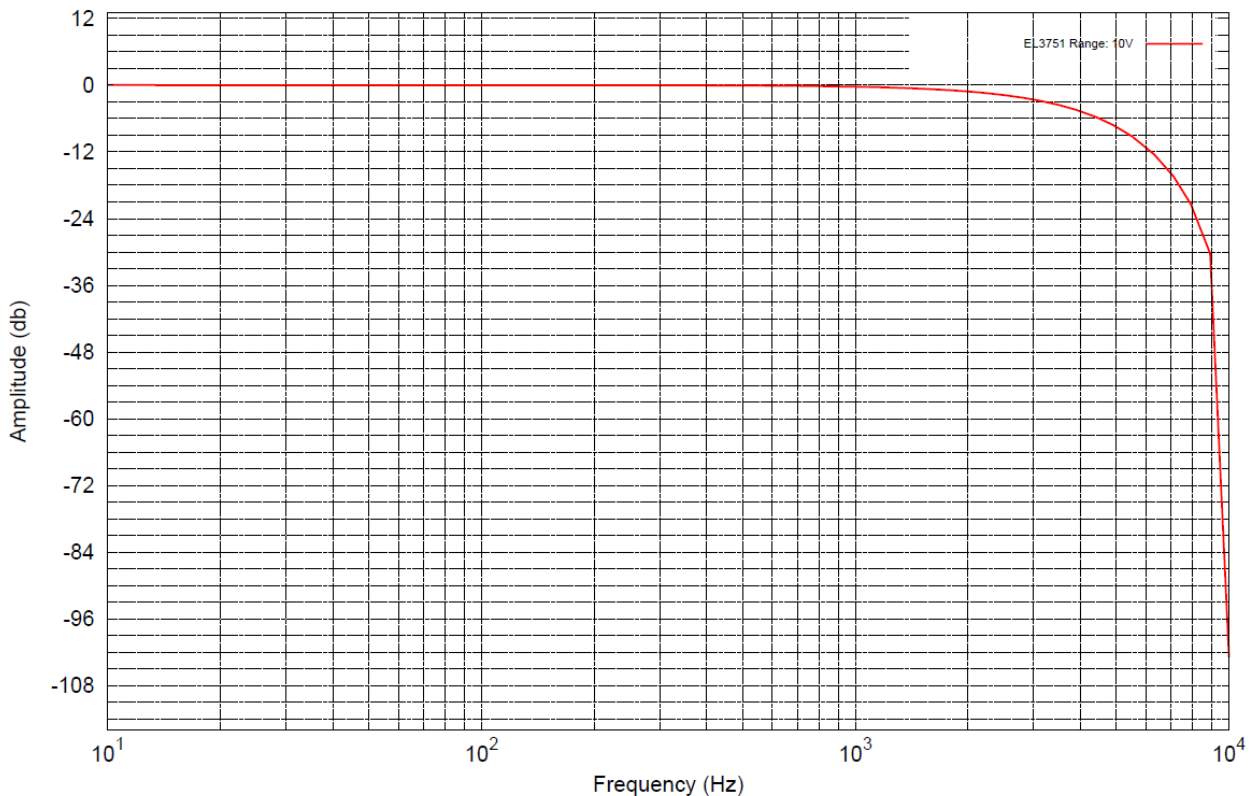

Fig. 32: Frequency response 0...10 V measurement range,  $f_{\text{sampling}} = 10 \text{ kHz}$ , integrated filter 1/2 deactivated

## 2.2.19 Measurement $\pm 20$ mA

Measurement mode		$\pm 20$ mA		
Measuring range, nominal		-20...+20 mA		
Measuring range, end value (full scale value)		20 mA		
Measuring range, technically usable		-21.474...+21.474 mA, overcurrent-protected		
Fuse protection		Internal overload limiting, continuous current resistant		
PDO resolution		24 bit (including sign)		
PDO LSB (Extended Range)		2.56 nA		
PDO LSB (Legacy Range)		2.384.. nA		
Common-mode voltage $V_{cm}$		max. +/- 10V related to -U <sub>v</sub> (internal ground)		
Basic accuracy: Measuring deviation at 23°C, with averaging		$< \pm 0.01\%_{FSV} = \pm 100 \text{ ppm}_{FSV}$		
Offset/Zero Point deviation (at 23°C)	$E_{Offset}$	$< 65 \text{ ppm}_{FSV}$		
Gain/scale/amplification deviation (at 23°C)	$E_{Gain}$	$< 50 \text{ ppm}$		
Non-linearity over the whole measuring range	$E_{Lin}$	$< 40 \text{ ppm}_{FSV}$		
Repeatability	$E_{Rep}$	$< 40 \text{ ppm}_{FSV}$		
Noise (without filtering)	$E_{Noise, PTP}$	$< 100 \text{ ppm}_{FSV}$	$< 781$ [digits]	
	$E_{Noise, RMS}$	$< 18 \text{ ppm}_{FSV}$	$< 141$ [digits]	
	Max. SNR	$> 94.9 \text{ dB}$		
	Noisedensity@1kHz	$< 5.09 \frac{\text{nA}}{\sqrt{\text{Hz}}}$		
Noise (with 50Hz FIR filtering)	$E_{Noise, PTP}$	$< 10 \text{ ppm}_{FSV}$	$< 78$ [digits]	
	$E_{Noise, RMS}$	$< 2.0 \text{ ppm}_{FSV}$	$< 16$ [digits]	
	Max. SNR	$> 114.0 \text{ dB}$		
Temperature coefficient	$Tc_{Gain}$	$< 15 \text{ ppm/K typ.}$		
	$Tc_{Offset}$	$< 5 \text{ ppm}_{FSV}/K \text{ typ.}$		
Common-mode rejection ratio (without filtering)		DC: $< 3 \text{ nA/V typ.}$	50 Hz: $< 5 \text{ nA/V typ.}$	1 kHz: $< 80 \text{ nA/V typ.}$
Common-mode rejection ratio (with 50Hz FIR filtering)		DC: $< 3 \text{ nA/V typ.}$	50 Hz: $< 3 \text{ nA/V typ.}$	1 kHz: $< 3 \text{ nA/V typ.}$
Largest short-term deviation during a specified electrical interference test		$\pm 0.05\%_{FSV} = \pm 500 \text{ ppm}_{FSV} \text{ typ.}$		
Input impedance $\pm$ Input 1 (Internal resistance)		Differential $200 \Omega \parallel 11 \text{ nF typ.}$ CommonMode $1 \text{ M}\Omega \parallel 40 \text{ nF typ.}$ Methodology: Resistor against -U <sub>v</sub> , capacitance against SGND		
Input impedance $\pm$ Input 2		No usage of this input in this mode		

Current measurement range  $\pm 20$  mA

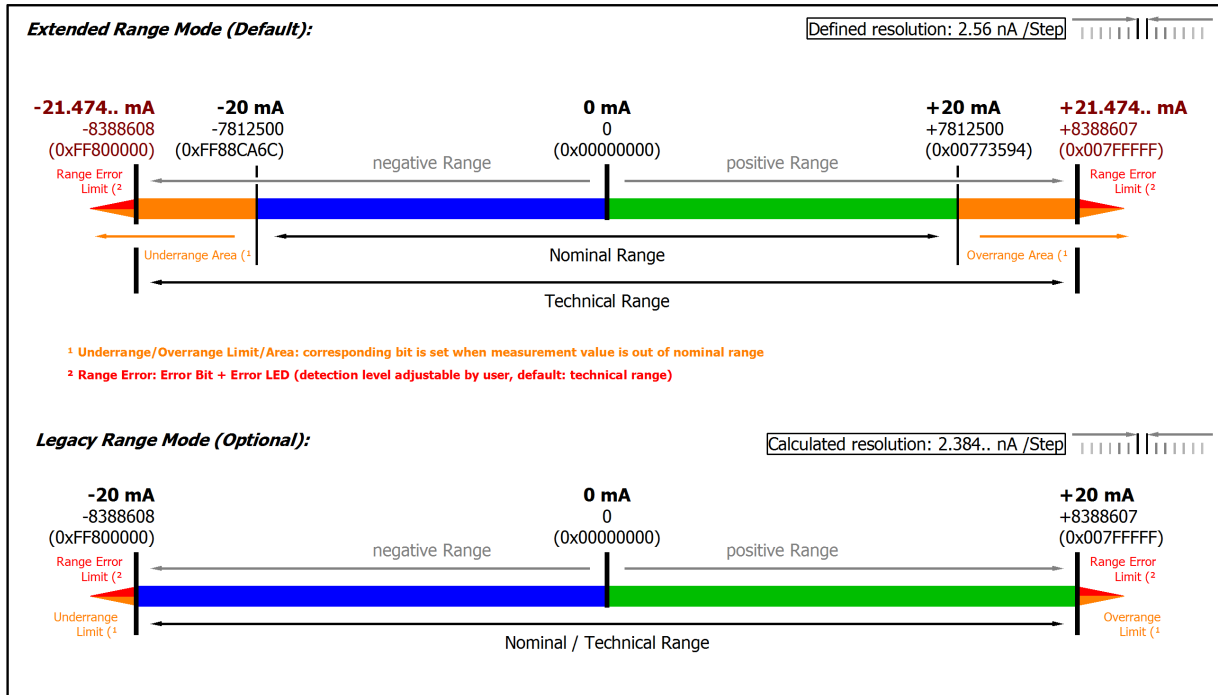

Fig. 33: Representation current measurement range  $\pm 20$  mA

Note: In Extended Range Mode the Underrange/Overrange display in the PDO status has the character of an information/warning when the nominal measuring range is exceeded, i.e. no Error is displayed in the PDO status and LED. If the technical measuring range is also exceeded, Error = TRUE is also displayed. The detection limit for Underrange/Overrange Error can be set in the CoE.

In Legacy Range mode, an Underrange/Overrange event also leads to an Error in the PDO status.

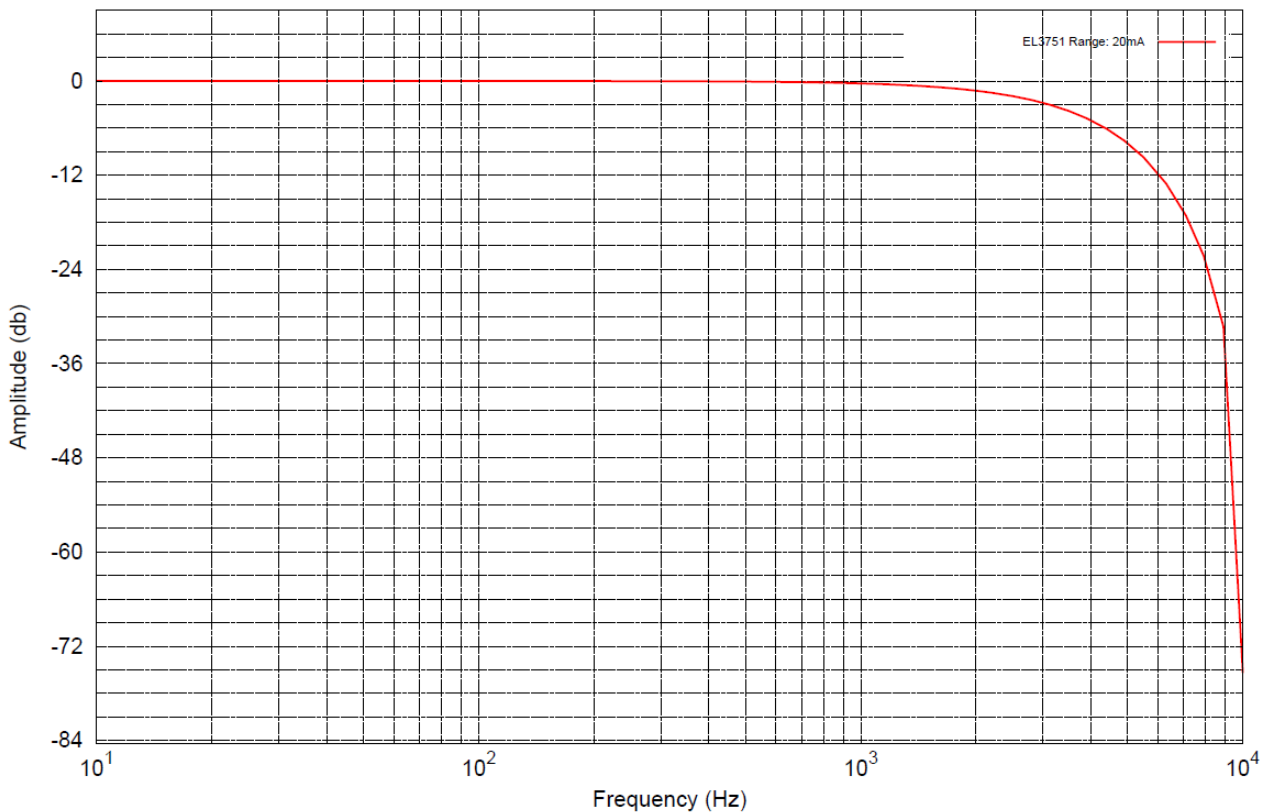

Fig. 34: Frequency response  $\pm 20$  mA measurement range,  $f_{\text{sampling}} = 10$  kHz, integrated filter 1/2 deactivated

## 2.2.20 Measurement 0...20 mA

Measurement mode		0...20 mA		
Measuring range, nominal		0...20 mA		
Measuring range, end value (full scale value)		20 mA		
Measuring range, technically usable		0 ...21.474 mA		
Fuse protection		Internal overload limiting, continuous current resistant		
PDO resolution		23 bit (unsigned)		
PDO LSB (Extended Range)		2.56 nA		
PDO LSB (Legacy Range)		2.384.. nA		
Common-mode voltage $V_{cm}$		max. +/- 10V related to -U <sub>v</sub> (internal ground)		
Basic accuracy: Measuring deviation at 23°C, with averaging		< $\pm 0.01\%_{FSV} = \pm 100 \text{ ppm}_{FSV}$		
Offset/Zero Point deviation (at 23°C)	$E_{Offset}$	< 65 ppm <sub>FSV</sub>		
Gain/scale/amplification deviation (at 23°C)	$E_{Gain}$	< 50 ppm		
Non-linearity over the whole measuring range	$E_{Lin}$	< 40 ppm <sub>FSV</sub>		
Repeatability	$E_{Rep}$	< 40 ppm <sub>FSV</sub>		
Noise (without filtering)	$E_{Noise, PTP}$	< 100 ppm <sub>FSV</sub>	< 781 [digits]	
	$E_{Noise, RMS}$	< 18 ppm <sub>FSV</sub>	< 141 [digits]	
	Max. SNR	> 94.9 dB		
	Noisedensity@1kHz	< $5.09 \frac{nA}{\sqrt{Hz}}$		
Noise (with 50Hz FIR filtering)	$E_{Noise, PTP}$	< 10 ppm <sub>FSV</sub>	< 78 [digits]	
	$E_{Noise, RMS}$	< 2.0 ppm <sub>FSV</sub>	< 16 [digits]	
	Max. SNR	> 114.0 dB		
Temperature coefficient	$Tc_{Gain}$	< 15 ppm/K typ.		
	$Tc_{Offset}$	< 5 ppm <sub>FSV</sub> /K typ.		
Common-mode rejection ratio (without filtering)		DC: < 3 nA/V typ.	50 Hz: < 5 nA/V typ.	1 kHz: < 80 nA/V typ.
Common-mode rejection ratio (with 50Hz FIR filtering)		DC: < 3 nA/V typ.	50 Hz: < 3 nA/V typ.	1 kHz: < 3 nA/V typ.
Largest short-term deviation during a specified electrical interference test		$\pm 0.05\%_{FSV} = \pm 500 \text{ ppm}_{FSV}$ typ.		
Input impedance $\pm$ Input 1 (Internal resistance)	Differential 200 $\Omega$    11 nF typ.			
	CommonMode 1 M $\Omega$    40 nF typ. Methodology: Resistor against -U <sub>v</sub> , capacitance against SGND			
Input impedance $\pm$ Input 2		No usage of this input in this mode		

Current measurement range 0...20 mA

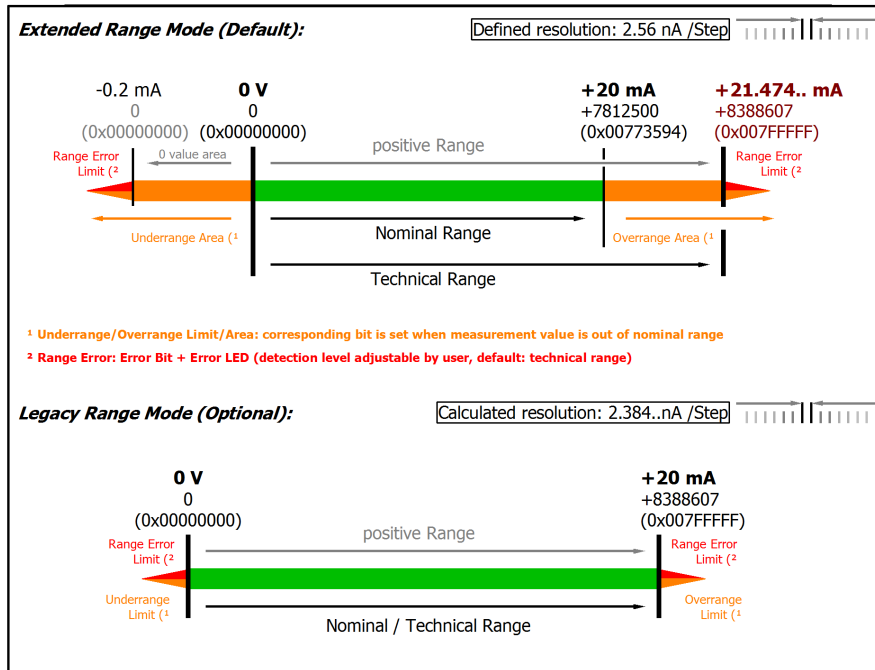

Fig. 35: Representation current measurement range 0...20 mA

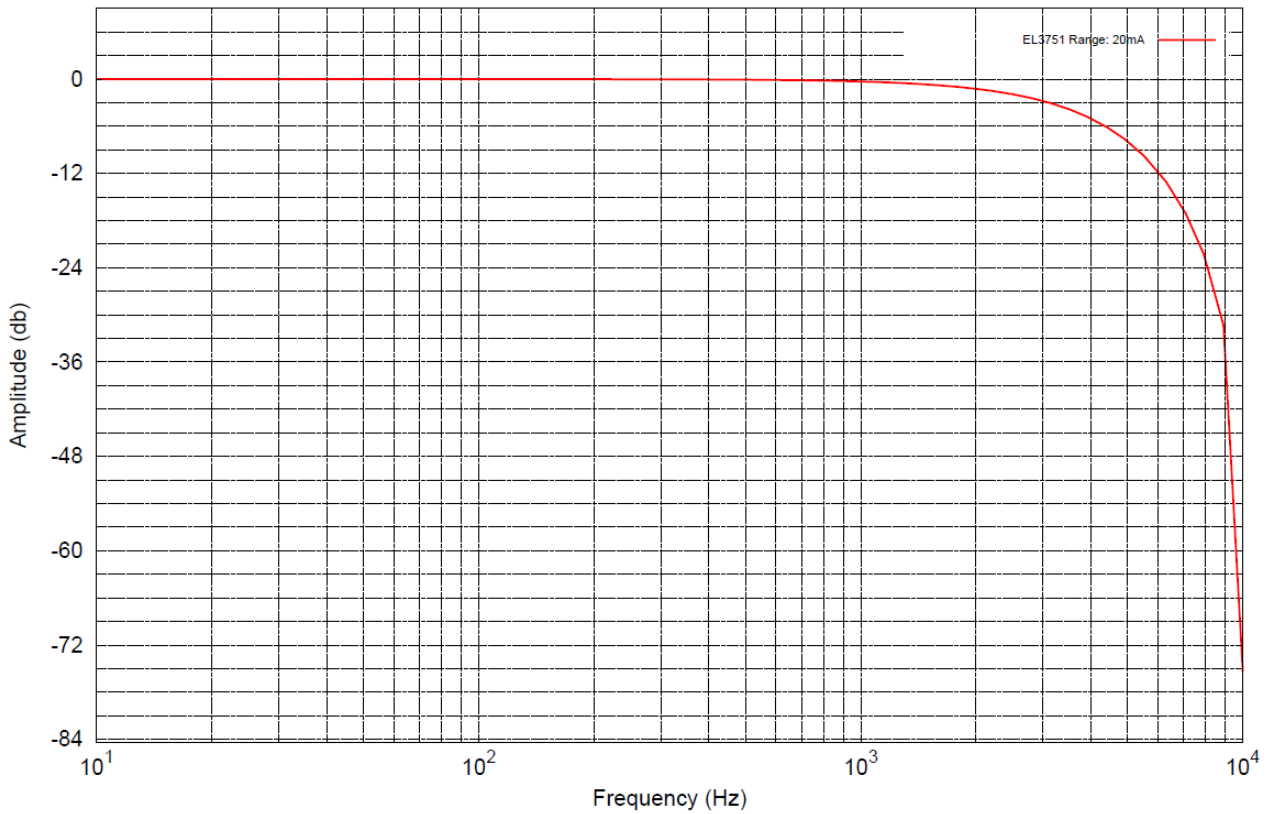

Fig. 36: Frequency response 0...20 mA measurement range,  $f_{\text{sampling}} = 10 \text{ kHz}$ , integrated filter 1/2 deactivated

## 2.2.21 Measurement 4...20 mA

Measurement mode		4...20 mA		
Measuring range, nominal		4...20 mA		
Measuring range, end value (full scale value)		20 mA		
Measuring range, technically usable		0...21.179 mA		
Fuse protection		Internal overload limiting, continuous current resistant		
PDO resolution		24 Bit		
PDO LSB (Extended Range)		2.048 nA		
PDO LSB (Legacy Range)		1.907.. nA		
Common-mode voltage $V_{cm}$		max. +/- 10V related to -U <sub>v</sub> (internal ground)		
Basic accuracy: Measuring deviation at 23°C, with averaging		< $\pm 0.01\%_{FSV} = \pm 100 \text{ ppm}_{FSV}$		
Offset/Zero Point deviation (at 23°C)	$E_{Offset}$	< 65 ppm <sub>FSV</sub>		
Gain/scale/amplification deviation (at 23°C)	$E_{Gain}$	< 50 ppm		
Non-linearity over the whole measuring range	$E_{Lin}$	< 40 ppm <sub>FSV</sub>		
Repeatability	$E_{Rep}$	< 40 ppm <sub>FSV</sub>		
Noise (without filtering)	$E_{Noise, PTP}$	< 100 ppm <sub>FSV</sub>	< 781 [digits]	
	$E_{Noise, RMS}$	< 18 ppm <sub>FSV</sub>	< 141 [digits]	
	Max. SNR	> 94.9 dB		
	Noisedensity@1kHz	< $5.09 \frac{nA}{\sqrt{Hz}}$		
Noise (with 50Hz FIR filtering)	$E_{Noise, PTP}$	< 10 ppm <sub>FSV</sub>	< 78 [digits]	
	$E_{Noise, RMS}$	< 2.0 ppm <sub>FSV</sub>	< 16 [digits]	
	Max. SNR	> 114.0 dB		
Temperature coefficient	$Tc_{Gain}$	< 15 ppm/K typ.		
	$Tc_{Offset}$	< 5 ppm <sub>FSV</sub> /K typ.		
Common-mode rejection ratio (without filtering)		DC: < 3 nA/V typ.	50 Hz: < 5 nA/V typ.	1 kHz: < 80 nA/V typ.
Common-mode rejection ratio (with 50Hz FIR filtering)		DC: < 3 nA/V typ.	50 Hz: < 3 nA/V typ.	1 kHz: < 3 nA/V typ.
Largest short-term deviation during a specified electrical interference test		$\pm 0.05\%_{FSV} = \pm 500 \text{ ppm}_{FSV}$ typ.		
Input impedance $\pm$ Input 1 (Internal resistance)	Differential 200 $\Omega$    11 nF typ.			
	CommonMode 1 M $\Omega$    40 nF typ. Methodology: Resistor against -U <sub>v</sub> , capacitance against SGND			
Input impedance $\pm$ Input 2		No usage of this input in this mode		



Current measurement range 4...20 mA

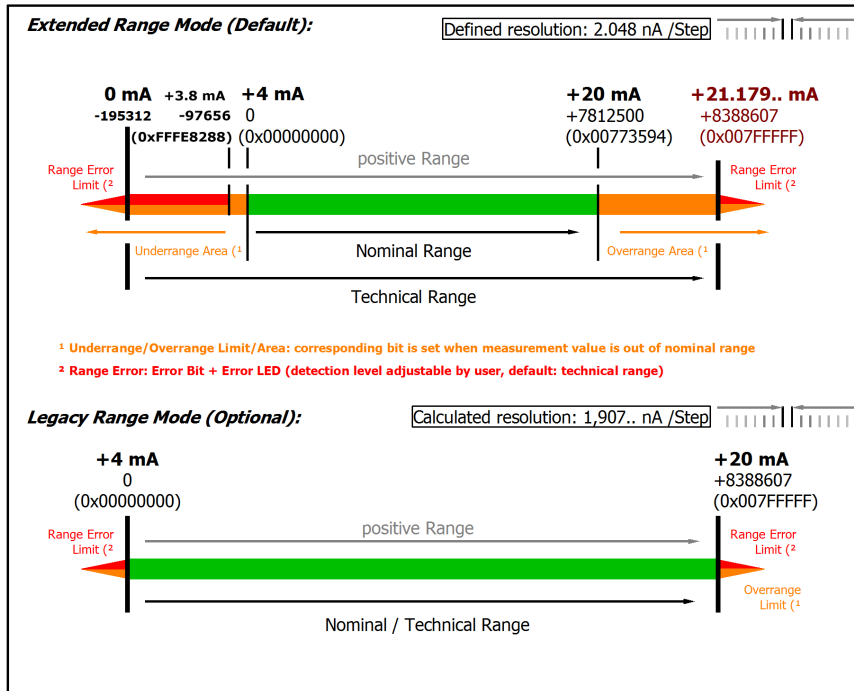

Fig. 37: Representation current measurement range 4...20 mA

Note: The channel also works in electrically bipolar mode and records negative values in the unipolar measuring ranges (measurement from 0 V, 0 mA, 4 mA, 0 Ω). This enables the channel to provide a precise diagnosis even with signals < 0. In these measuring ranges the limit value for the "Underrange Error" in Extended Mode is -1% of the full scale value (FSV). The limit value can be set in CoE object 0x80n0:32 [▶ 95]. This avoids irritating error messages if the channel is not wired (e.g. without sensor) or the electrical signal fluctuates slightly around zero. The process data value of 0x00000000 is not undershot.

If the "UnderrangeError" detection is to be set even less sensitive, the magnitude of the negative limit value in the CoE object referred to above can be set even higher.

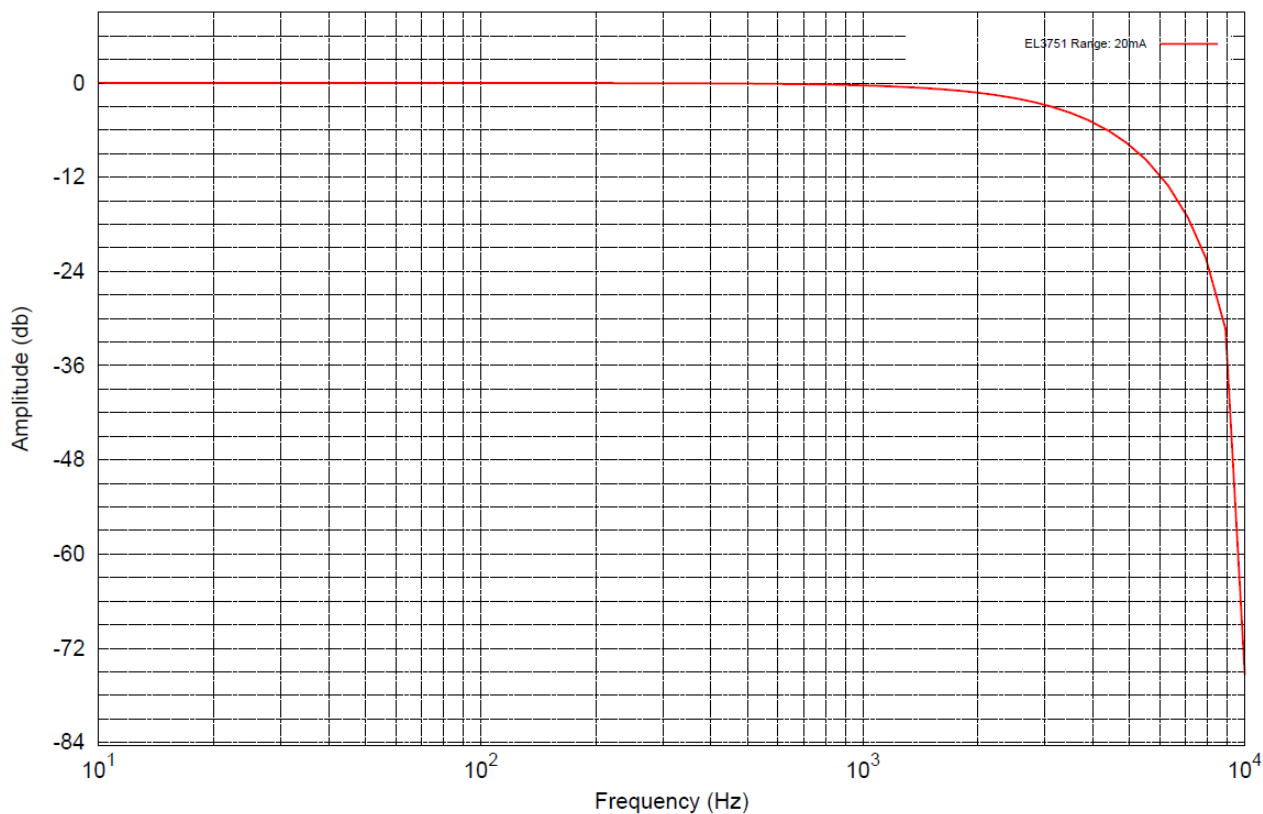

Fig. 38: Frequency response 4...20 mA measurement range,  $f_{\text{sampling}} = 10 \text{ kHz}$ , integrated filter 1/2 deactivated

## 2.2.22 Measurement 3.6...21 mA (NAMUR NE43)

Measurement mode		3.6...21 mA (NAMUR NE43)		
Measuring range, nominal		4...20 mA		
Measuring range, end value (full scale value)		20 mA		
Measuring range, technically usable		3.6...21 mA		
Fuse protection		Internal overload limiting, continuous current resistant		
PDO resolution		24 Bit		
PDO LSB (Extended Range)		2.048 nA		
PDO LSB (Legacy Range)		n.a.		
Common-mode voltage $V_{cm}$		max. +/- 10V related to -U <sub>v</sub> (internal ground)		
Basic accuracy: Measuring deviation at 23°C, with averaging		< ±0.01% <sub>FSV</sub> = ±100 ppm <sub>FSV</sub>		
Offset/Zero Point deviation (at 23°C)	$E_{Offset}$	< 65 ppm <sub>FSV</sub>		
Gain/scale/amplification deviation (at 23°C)	$E_{Gain}$	< 50 ppm		
Non-linearity over the whole measuring range	$E_{Lin}$	< 40 ppm <sub>FSV</sub>		
Repeatability	$E_{Rep}$	< 40 ppm <sub>FSV</sub>		
Noise (without filtering)	$E_{Noise, PTP}$	< 100 ppm <sub>FSV</sub>	< 781 [digits]	
	$E_{Noise, RMS}$	< 18 ppm <sub>FSV</sub>	< 141 [digits]	
	Max. SNR	> 94.9 dB		
	Noisedensity@1kHz	< 5.09 $\frac{nA}{\sqrt{Hz}}$		
Noise (with 50Hz FIR filtering)	$E_{Noise, PTP}$	< 10 ppm <sub>FSV</sub>	< 78 [digits]	
	$E_{Noise, RMS}$	< 2.0 ppm <sub>FSV</sub>	< 16 [digits]	
	Max. SNR	> 114.0 dB		
Temperature coefficient	$Tc_{Gain}$	< 15 ppm/K typ.		
	$Tc_{Offset}$	< 5 ppm <sub>FSV</sub> /K typ.		
Common-mode rejection ratio (without filtering)		DC: < 3 nA/V typ.	50 Hz: < 5 nA/V typ.	1 kHz: < 80 nA/V typ.
Common-mode rejection ratio (with 50Hz FIR filtering)		DC: < 3 nA/V typ.	50 Hz: < 3 nA/V typ.	1 kHz: < 3 nA/V typ.
Largest short-term deviation during a specified electrical interference test		±0.05% <sub>FSV</sub> = ±500 ppm <sub>FSV</sub> typ.		
Input impedance ±Input 1 (Internal resistance)		Differential 200 Ω    11 nF typ. CommonMode 1 MΩ    40 nF typ. Methodology: Resistor against -U <sub>v</sub> , capacitance against SGND		
Input impedance ±Input 2		No usage of this input in this mode		

**Current measuring range 3.6...21 mA (NAMUR)**

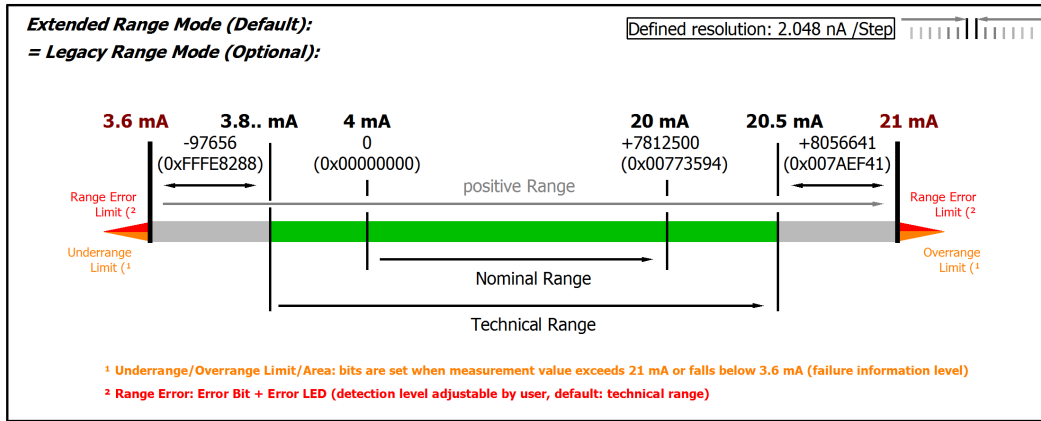

Fig. 39: Chart: current measuring range 3.6...21 mA (NAMUR)

**i Only Extended Range mode for measuring range 4 mA NAMUR**

Legacy Range mode is not available for this measurement range. The Extended Range Mode will be set automatically and although a corresponding write access to the CoE Object `0x8000:2E (Scaler)` [► 95] is not declined, the parameter is not changed.

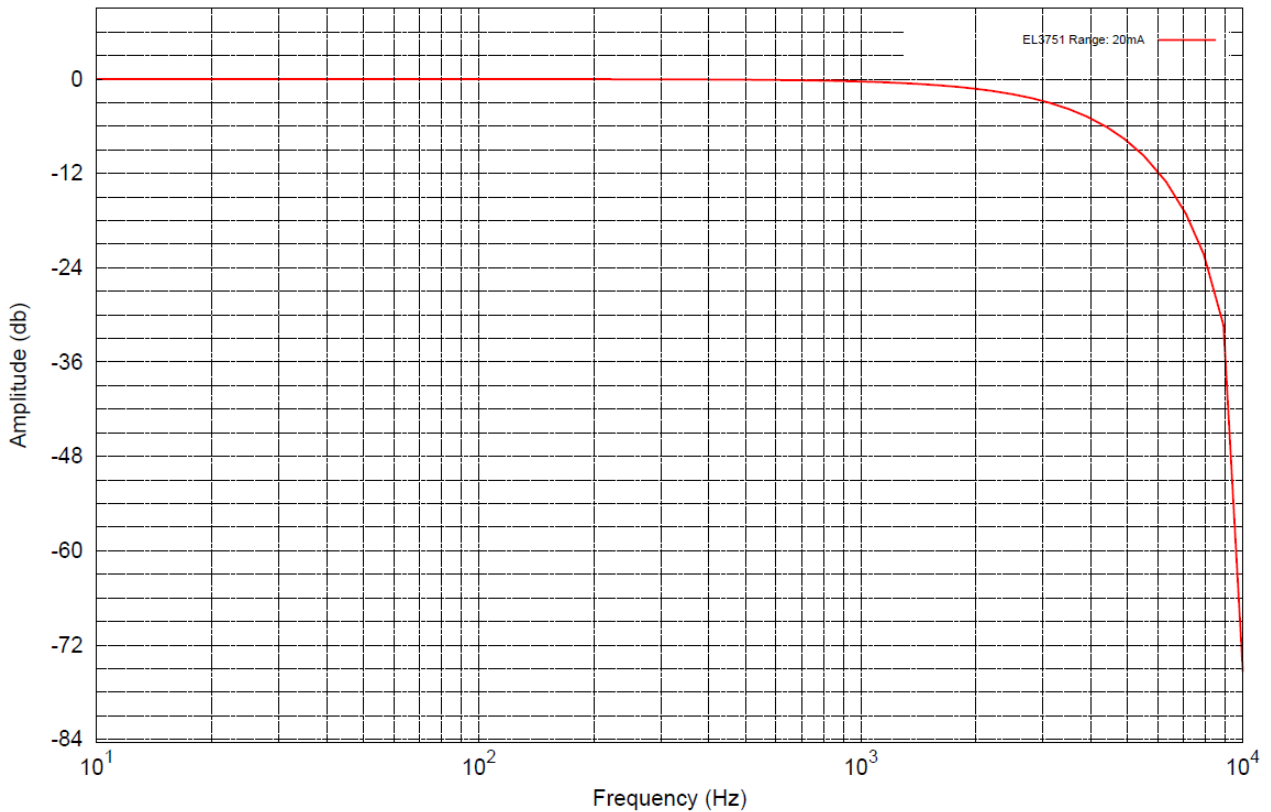

Fig. 40: Frequency response 20 mA measurement range,  $f_{\text{sampling}} = 10 \text{ kHz}$ , integrated filter 1/2 deactivated

## 2.2.23 Measurement resistance 0...5 kΩ

### Note on measuring resistances or resistance ratios

With **2-wire measurement**, the line resistance of the sensor supply lines influences the measured value. If a reduction of this systematic error component is desirable for 2-wire measurements, the resistance of the supply line to the measuring resistance should be taken into account, in which case the resistance of the supply line has to be determined first.

Taking into account the uncertainty associated with this supply line resistance, it can then be included statically in the calculation, in the EL3751 via [0x8000:13 \[► 95\]](#) and in the ELM350x/ ELM370x via [0x80n0:13 \[► 95\]](#).

Any change in resistance of the supply line due to ageing, for example, is not taken into account automatically. Just the temperature dependency of copper lines with approx. 4000 ppm/K (corresponds to 0.4%/K!) is not insignificant during 24/7 operation.

A **3-wire measurement** enables the systematic component to be eliminated, assuming that the two supply lines are identical. With this type of measurement, the lead resistance of a supply line is measured continuously. The value determined in this way is then deducted twice from the measurement result, thereby eliminating the line resistance. Technically, this leads to a significantly more reliable measurement. However, taking into account the measurement uncertainty, the gain from the 3-wire connection is less significant, since this assumption is subject to high uncertainty, in view of the fact that the individual line that was not measured may be damaged, or a varying resistance may have gone unnoticed.

Therefore, although technically the 3-wire connection is a tried and tested approach, for measurements that are methodological assessed based on measurement uncertainty, we strongly recommend fully-compensated **4-wire connection**.

With both 2-wire and 3-wire connection, the contact resistances of the terminal contacts influence the measuring process. The measuring accuracy can be further increased by a user-side adjustment with the signal connection plugged in.

### NOTICE

#### Measurement of small resistances

Especially for measurements in the range  $< 10 \Omega$ , the 4-wire connection is absolutely necessary due to the relatively high supply and contact resistances. It should also be considered that with such low resistances the relative measurement error in relation to the full scale value (FSV) can become high - for such measurements resistance measurement terminals with small measuring ranges such as EL3692 in 4-wire measurement should be used if necessary.

Corresponding considerations also lead to the common connection methods in bridge operation:

- Full bridge: 4-wire connection without line compensation, 6-wire connection with full line compensation
- Half bridge: 3-wire connection without line compensation, 5-wire connection with full line compensation
- Quarter bridge: 2-wire connection without line compensation, 3-wire connection with theoretical line compensation and 4-wire connection with full line compensation

Measurement mode	Electrical resistance
Operation mode	2.5 V feed voltage, fixed setting n +Uv 5 kΩ reference resistance at -I2 Supply current is given by: $2.5 \text{ V} / (5 \text{ k}\Omega + R_{\text{measurement}})$
Measuring range, nominal	0...5 kΩ
Measuring range, end value (full scale value)	5 kΩ
Measuring range, technically usable	0 Ω...5.368 kΩ
PDO resolution	23 bit (unsigned)
PDO LSB (Extended Range)	640 μΩ
PDO LSB (Legacy Range)	596.. μΩ

Measurement mode		Electrical resistance
Basic accuracy: Measuring deviation at 23°C, with averaging		2-wire connection ±0.05% typ. (full scale value) 3-wire connection ±0.03% typ. (full scale value) 4-wire connection ±0.01% typ. (full scale value)
Temperature coefficient (Terminal)	T <sub>C</sub> Terminal	< 10 ppm/K typ.

Measurement mode		Electrical resistance (2 wire)		
Offset/Zero Point deviation (at 23°C)	E <sub>Offset</sub>	< 475 [ppm <sub>FSV</sub> ]		
Gain/scale/amplification deviation (at 23°C)	E <sub>Gain</sub>	< 150 [ppm]		
Non-linearity over the whole measuring range	E <sub>Lin</sub>	< 25 [ppm <sub>FSV</sub> ]		
Repeatability	E <sub>Rep</sub>	< 20 [ppm <sub>FSV</sub> ]		
Noise (without filtering)	E <sub>Noise, PTP</sub>	< 220 [ppm <sub>FSV</sub> ]	< 1719 [digits]	
	E <sub>Noise, RMS</sub>	< 45 [ppm <sub>FSV</sub> ]	< 352 [digits]	
	Max. SNR	> 86.9 [dB]		
	Noisedensity@1kHz	$< 3.18 \frac{m\Omega}{\sqrt{Hz}}$		
Noise (with 50 Hz FIR filtering)	E <sub>Noise, PTP</sub>	< 12 [ppm <sub>FSV</sub> ]	< 94 [digits]	
	E <sub>Noise, RMS</sub>	< 3.0 [ppm <sub>FSV</sub> ]	< 23 [digits]	
	Max. SNR	> 110.5 [dB]		
Common-mode rejection ratio (without filtering) <sup>3)</sup>		DC: < 150 Ω/V typ.	50 Hz: < 0.6 kΩ/V typ.	1 kHz: < 3.5 kΩ/V typ.
Common-mode rejection ratio (with 50 Hz FIR filtering) <sup>3)</sup>		DC: < 150 Ω/V typ.	50 Hz: < 20 Ω/V typ.	1 kHz: < 0.1 Ω/V typ.
Largest short-term deviation during a specified electrical interference test		±0.1% <sub>FSV</sub> = ±1000 ppm <sub>FSV</sub> typ.		

<sup>3)</sup> Values related to a common mode interference between SGND and internal ground.

Measurement mode		Electrical resistance (3 wire)		
Offset/Zero Point deviation (at 23°C)	E <sub>Offset</sub>	< 280 [ppm <sub>FSV</sub> ]		
Gain/scale/amplification deviation (at 23°C)	E <sub>Gain</sub>	< 100 [ppm]		
Non-linearity over the whole measuring range	E <sub>Lin</sub>	< 25 [ppm <sub>FSV</sub> ]		
Repeatability	E <sub>Rep</sub>	< 20 [ppm <sub>FSV</sub> ]		
Noise (without filtering)	E <sub>Noise, PTP</sub>	< 185 [ppm <sub>FSV</sub> ]	< 1445 [digits]	
	E <sub>Noise, RMS</sub>	< 35 [ppm <sub>FSV</sub> ]	< 273 [digits]	
	Max. SNR	> 89.1 [dB]		
	Noisedensity@1kHz	$< 2.47 \frac{m\Omega}{\sqrt{Hz}}$		
Noise (with 50 Hz FIR filtering)	E <sub>Noise, PTP</sub>	< 11 [ppm <sub>FSV</sub> ]	< 86 [digits]	
	E <sub>Noise, RMS</sub>	< 3.0 [ppm <sub>FSV</sub> ]	< 23 [digits]	
	Max. SNR	> 110.5 [dB]		
Common-mode rejection ratio (without filtering) <sup>3)</sup>		DC: < 150 Ω/V typ.	50 Hz: < 0.6 kΩ/V typ.	1 kHz: < 3.5 kΩ/V typ.

Measurement mode	Electrical resistance (3 wire)		
Common-mode rejection ratio (with 50 Hz FIR filtering) <sup>3</sup>	DC: < 150 Ω/V typ.	50 Hz: < 20 Ω/V typ.	1 kHz: < 0.1 Ω/V typ.
Largest short-term deviation during a specified electrical interference test	±0.1% <sub>F<sub>SV</sub></sub> = 1000 ppm <sub>F<sub>SV</sub></sub> typ.		

<sup>3)</sup> Values related to a common mode interference between SGND and internal ground.

Measurement mode	Electrical resistance (4 wire)		
Offset/Zero Point deviation (at 23°C)	E <sub>Offset</sub>	< 70 [ppm <sub>F<sub>SV</sub></sub> ]	
Gain/scale/amplification deviation (at 23°C)	E <sub>Gain</sub>	< 70 [ppm]	
Non-linearity over the whole measuring range	E <sub>Lin</sub>	< 15 [ppm <sub>F<sub>SV</sub></sub> ]	
Repeatability	E <sub>Rep</sub>	< 10 [ppm <sub>F<sub>SV</sub></sub> ]	
Noise (without filtering)	E <sub>Noise, PTP</sub>	< 155 [ppm <sub>F<sub>SV</sub></sub> ]	< 1211 [digits]
	E <sub>Noise, RMS</sub>	< 30 [ppm <sub>F<sub>SV</sub></sub> ]	< 234 [digits]
	Max. SNR	> 90.5 [dB]	
	Noisedensity@1kHz	$< 2.12 \frac{m\Omega}{\sqrt{Hz}}$	
Noise (with 50 Hz FIR filtering)	E <sub>Noise, PTP</sub>	< 9 [ppm <sub>F<sub>SV</sub></sub> ]	< 70 [digits]
	E <sub>Noise, RMS</sub>	< 3.0 [ppm <sub>F<sub>SV</sub></sub> ]	< 23 [digits]
	Max. SNR	> 110.5 [dB]	
Common-mode rejection ratio (without filtering) <sup>3</sup>	DC: < 150 Ω/V typ.	50 Hz: < 0.6 kΩ/V typ.	1 kHz: < 3.5 kΩ/V typ.
Common-mode rejection ratio (with 50 Hz FIR filtering) <sup>3</sup>	DC: < 150 Ω/V typ.	50 Hz: < 20 Ω/V typ.	1 kHz: < 0.1 Ω/V typ.
Largest short-term deviation during a specified electrical interference test	±0.1% = 1000 ppm <sub>F<sub>SV</sub></sub> typ.		

<sup>3)</sup> Values related to a common mode interference between SGND and internal ground.

**Resistance measurement range 5 kΩ**

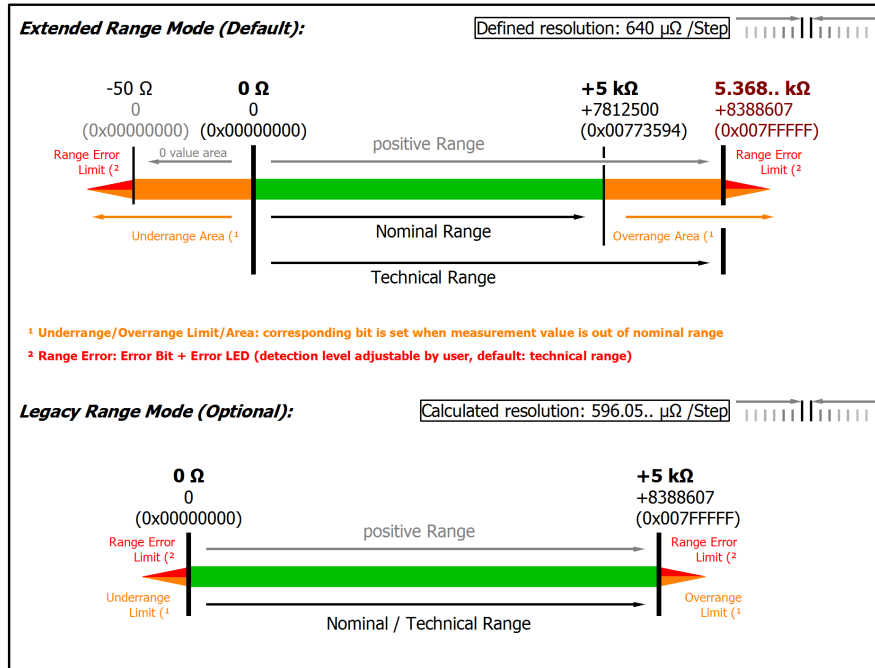

Fig. 41: Representation resistance measurement range 5 kΩ

Note: The channel also works in electrically bipolar mode and records negative values in the unipolar measuring ranges (measurement from 0 V, 0 mA, 4 mA, 0 Ω). This enables the channel to provide a precise diagnosis even with signals < 0. In these measuring ranges the limit value for the "Underrange Error" in Extended Mode is -1% of the full scale value (FSV). The limit value can be set in CoE object 0x80n0:32 [► 95]. This avoids irritating error messages if the channel is not wired (e.g. without sensor) or the electrical signal fluctuates slightly around zero. The process data value of 0x00000000 is not undershot.

If the "UnderrangeError" detection is to be set even less sensitive, the magnitude of the negative limit value in the CoE object referred to above can be set even higher.

Note: In Extended Range Mode the Underrange/Overrange display in the PDO status has the character of an information/warning when the nominal measuring range is exceeded, i.e. no Error is displayed in the PDO status and LED. If the technical measuring range is also exceeded, Error = TRUE is also displayed. The detection limit for Underrange/Overrange Error can be set in the CoE.

In Legacy Range mode, an Underrange/Overrange event also leads to an Error in the PDO status.



## 2.2.24 RTD measurement

In RTD measurement range, the measured resistance is internally converted to a temperature based on a set transformation. Since the channel internally measures based on 5 kΩ, the corresponding measurement error should be applied in this measuring range.

In some ranges a (relatively) higher measuring accuracy is achieved, which is why in the table below better temperature accuracy values may be specified for individual sensor types than can be calculated from the 5 kΩ accuracy<sup>1)</sup>.

Please refer to the note on 2/3/4-wire measurement in the preceding chapter "Resistance".

Measurement mode	RTD
Operation mode	2.5 V feed voltage, fixed setting n +Uv 5 kΩ reference resistance at -I2 Supply current is given by: $2.5 \text{ V} / (5 \text{ k}\Omega + R_{\text{measurement}}) \rightarrow \text{max. } 0.5 \text{ mA}$
PDO resolution	0.01°C/digit

The transition resistance values of the terminal contacts affect the measurement. The measuring error can be reduced further through compensation by the user, with active signal connection.

The temperature end value corresponds to the nominal full scale value.

### RTD measuring range

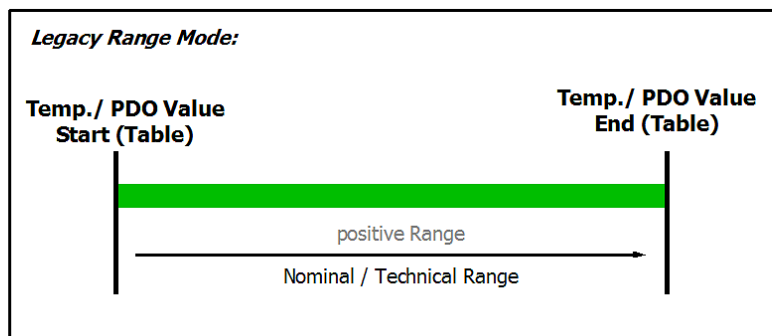

Fig. 42: Chart: RTD measuring range

### Data of the sensor types in the following table

The data of the sensor types in the following table is provided for information only and serve as help for orientation. All details of data are without warranty and have to be verified with the data sheet of the respective used sensor.

CoE Enum RTD Element	RTD Type	Temperature Starting value [°C]	Temperature End value [°C]	Achievable accuracy @ sensor temperature (full scale value). 3-wire connection <sup>(2)</sup>	Achievable accuracy @ sensor temperature (full scale value). 4-wire connection <sup>(2)</sup>	Temperature coefficient (terminal-specific drift)	Measured value starting value [Ω]	Measured value end value [Ω]
0	None	-	-	-	-	-	-	-
1	PT100	-200	850	±1K (-200...+850°C) see 1)	±0.5K (-200...+850°C) see 1)	approx. 0.13 K/K	18.52	390.48
2	NI100	-60	250	approx. ±2.68K @ 0°C	approx. ±0.83K @ 0°C	approx. 0.083 K/K	69.52	289.2
3	PT1000	-200	850	approx. ±0.38K @ 0°C	approx. ±0.13K @ 0°C	approx. 0.013 K/K	185.2	3904.8
4	PT500	-200	850	approx. ±1.03K @ 0°C	approx. ±0.34K @ 0°C	approx. 0.034 K/K	92.6	1952.4
5	PT200	-200	850	approx. ±1.96K @ 0°C	approx. ±0.65K @ 0°C	approx. 0.065 K/K	37.04	780.96

CoE Enum RTD Element	RTD Type	Temperature Starting value [°C]	Temperature End value [°C]	Achievable accuracy @ sensor temperature (full scale value). 3-wire connection <sup>2)</sup>	Achievable accuracy @ sensor temperature (full scale value). 4-wire connection <sup>2)</sup>	Temperature coefficient (terminal-specific drift)	Measured value starting value [Ω]	Measured value end value [Ω]
6	NI1000	-60	250	approx. ±0.34K @ 0°C	approx. ±0.11K @ 0°C	approx. 0.011 K/K	695.2	2892.6
7	NI1000 (TK5000, 100°C: 1500 Ω)	-30	160	approx. ±0.27K @ 100°C	approx. ±0.089K @ 100°C	approx. 0.009 K/K	871.7	1863.6
8	NI120	-60	320	-	-	-	80.94	461.04
9	KT100/110/130/210/230 KTY10/11/13/16/19	-50	150	approx. ±0.109K @ 0°C	approx. ±0.036K @ 0°C	approx. 0.0036 K/K	1036	4470
10	KTY81/82-110.120.150	-50	150	approx. ±0.216K @ 0°C	approx. ±0.072K @ 0°C	approx. 0.0072 K/K	515	2211
11	KTY81-121	-50	150	approx. ±0.219K @ 0°C	approx. ±0.073K @ 0°C	approx. 0.0073 K/K	510	2189
12	KTY81-122	-50	150	approx. ±0.214K @ 0°C	approx. ±0.071K @ 0°C	approx. 0.0071 K/K	520	2233
13	KTY81-151	-50	150	approx. ±0.222K @ 0°C	approx. ±0.074K @ 0°C	approx. 0.0074 K/K	502	2156
14	KTY81-152	-50	150	approx. ±0.211K @ 0°C	approx. ±0.070K @ 0°C	approx. 0.0070 K/K	528	2266
15	KTY81/82-210.220.250	-50	150	approx. ±0.108K @ 0°C	approx. ±0.036K @ 0°C	approx. 0.0036 K/K	1030	4280
16	KTY81-221	-50	150	approx. ±0.109K @ 0°C			1019	4237
17	KTY81-222	-50	150	approx. ±0.107K @ 0°C	approx. ±0.036K @ 0°C	approx. 0.0036 K/K	1040	4323
18	KTY81-251	-50	150	approx. ±0.111K @ 0°C	approx. ±0.037K @ 0°C	approx. 0.0037 K/K	1004	4173
19	KTY81-252	-50	150	approx. ±0.105K @ 0°C	approx. ±0.035K @ 0°C	approx. 0.0035 K/K	1055	4387
20	KTY83-110.120.150	-50	175	approx. ±0.222K @ 0°C	approx. ±0.074K @ 0°C	approx. 0.0074 K/K	525	2535
21	KTY83-121	-50	175	approx. ±0.224K @ 0°C	approx. ±0.075K @ 0°C	approx. 0.0075 K/K	519	2509
22	KTY83-122	-50	175	approx. ±0.221K @ 0°C	approx. ±0.074K @ 0°C	approx. 0.0074 K/K	530	2560
23	KTY83-151	-50	175	approx. ±0.225K @ 0°C	approx. ±0.075K @ 0°C	approx. 0.0075 K/K	512	2471
24	KTY83-152	-50	175	approx. ±0.216K @ 0°C	approx. ±0.072K @ 0°C	approx. 0.0072 K/K	538	2598
25	KTY84-130.150	-40	300	approx. ±0.384K @ 0°C	approx. ±0.128K @ 0°C	approx. 0.013 K/K	359	2624
26	KTY84-151	-40	300	approx. ±0.396K @ 0°C	approx. ±0.132K @ 0°C	approx. 0.013 K/K	350	2558
27	KTY21/23-6	-50	150	approx. ±0.22K @ 0°C	approx. ±0.072K @ 0°C	approx. 0.0072 K/K	518	2235
28	KTY1x-5	-50	150	approx. ±0.110K @ 0°C	approx. ±0.037K @ 0°C	approx. 0.0037 K/K	1020	4403
29	KTY1x-7	-50	150	approx. ±0.107K @ 0°C	approx. ±0.036K @ 0°C	approx. 0.0036 K/K	1052	4537
30	KTY21/23-5	-50	150	approx. ±0.220K @ 0°C	approx. ±0.073K @ 0°C	approx. 0.0073 K/K	510	2202
31	KTY21/23-7	-50	150	approx. ±0.214K @ 0°C	approx. ±0.071K @ 0°C	approx. 0.0071 K/K	526	2268

<sup>1)</sup> Achievable at negligible offset part, e.g. through cross reference offset correction/ zero offset (ELM3xxx: zero offset function).

Higher measuring accuracy for individual sensor types whose resistance is in the smaller subrange of 0..5 kΩ.

<sup>2)</sup> Relative error according to the slope of the respective RTD characteristic diagram at 23°C ambient terminal temperature (not taking into account temperature drift of the sensor).

**NOTICE****Extended Range mode not available**

The Extended Range mode is not available for RTD measurement.

- Until FW07: Object `0x8000:2E (Scaler) [▶ 95]` will be ignored by this setting. The “Legacy Range Mode” applies in the background.
- From FW08: Object `0x8000:2E (Scaler) [▶ 95]` will then be set to the “Legacy Range Mode”. A change is not possible as long RTD measurement range is selected.

## 2.2.25 Potentiometer measurement

The potentiometer should be supplied with the integrated power supply unit (max. 5 V, configurable). The slider voltage is then measured relative to the supply voltage and output in %. Technically, the measurement is similar to a strain gauge half bridge.

Potentiometers from 1 k $\Omega$  can be used.

### Diagnostics

- Slider breakage: full-scale deflection or 0 display
- Supply interruption: full-scale deflection or 0 display

Measurement mode		Potentiometer (3/ 5 wire)		
Operation mode		The supply voltage is configurable via CoE, 0.5...5 V		
Measuring range, nominal		-1...1 V/V		
Measuring range, end value (full scale value)		1 V/V		
Measuring range, technically usable		-1...1 V/V		
PDO resolution		24 bit (incl. sign)		
PDO LSB (Extended Range)		0.128 ppm		
PDO LSB (Legacy Range)		0.119... ppm		
Basic accuracy: Measuring deviation at 23°C, with averaging		< $\pm 0.05\%_{\text{FSV}} = \pm 500 \text{ ppm}_{\text{FSV}}$		
Temperature coefficient (Terminal)	$T_{\text{C}_{\text{Terminal}}}$	< 15 ppm/K typ.		
Input impedance $\pm$ Input 1 (Internal resistance)		Differential 4.1 M $\Omega$    11 nF typ.		
		CommonMode 1 M $\Omega$    40 nF typ. Methodology: Resistor against $-U_V$ , capacitance against SGND		
Input impedance $\pm$ Input 2 (Internal resistance)		Differential 5 M $\Omega$    10 nF typ.		
		CommonMode 1.25 M $\Omega$    40 nF typ. Methodology: Resistor against $-U_V (+2.5V)$ , capacitance against SGND		
Offset/Zero Point deviation (at 23°C)	$E_{\text{Offset}}$	< 480 [ppm $_{\text{FSV}}$ ]		
Gain/scale/amplification deviation (at 23°C)	$E_{\text{Gain}}$	< 100 [ppm]		
Non-linearity over the whole measuring range	$E_{\text{Lin}}$	< 75 [ppm $_{\text{FSV}}$ ]		
Repeatability	$E_{\text{Rep}}$	< 50 [ppm $_{\text{FSV}}$ ]		
Noise (peak-to-peak, without filtering)	$E_{\text{Noise, PTP}}$	< 150 [ppm $_{\text{FSV}}$ ]	< 1172 [digits]	
	$E_{\text{Noise, RMS}}$	< 22 [ppm $_{\text{FSV}}$ ]	< 172 [digits]	
	Max. SNR	> 93.2 [dB]		
	Noisedensity @1kHz	< $0.31 \frac{\text{ppm}}{\sqrt{\text{Hz}}}$		
Noise (peak-to-peak, with 50Hz filtering)	$E_{\text{Noise, PTP}}$	< 14 [ppm $_{\text{FSV}}$ ]	< 109 [digits]	
	$E_{\text{Noise, RMS}}$	< 2.5 [ppm $_{\text{FSV}}$ ]	< 20 [digits]	
	Max. SNR	> 112 [dB]		
Common-mode rejection ratio (without filtering) <sup>3</sup>		DC: $< 3 \frac{\text{mV/V}}{\text{V}} \text{ typ.}$	50 Hz: $< 9 \frac{\text{mV/V}}{\text{V}} \text{ typ.}$	1 kHz: $< 140 \frac{\text{mV/V}}{\text{V}} \text{ typ.}$
Common-mode rejection ratio (with 50Hz filtering) <sup>3</sup>		DC: $< 3 \frac{\text{mV/V}}{\text{V}} \text{ typ.}$	50 Hz: $< 0.2 \frac{\text{mV/V}}{\text{V}} \text{ typ.}$	1 kHz: $< 5 \frac{\mu\text{V/V}}{\text{V}} \text{ typ.}$

Measurement mode	Potentiometer (3/ 5 wire)
Largest short-term deviation during a specified electrical interference test	$\pm 0.2\%_{FSV} = \pm 2000 \text{ ppm}_{FSV} \text{ typ.}$

<sup>3)</sup> Values related to a common mode interference between SGND and internal ground.

Potentiometer measurement range

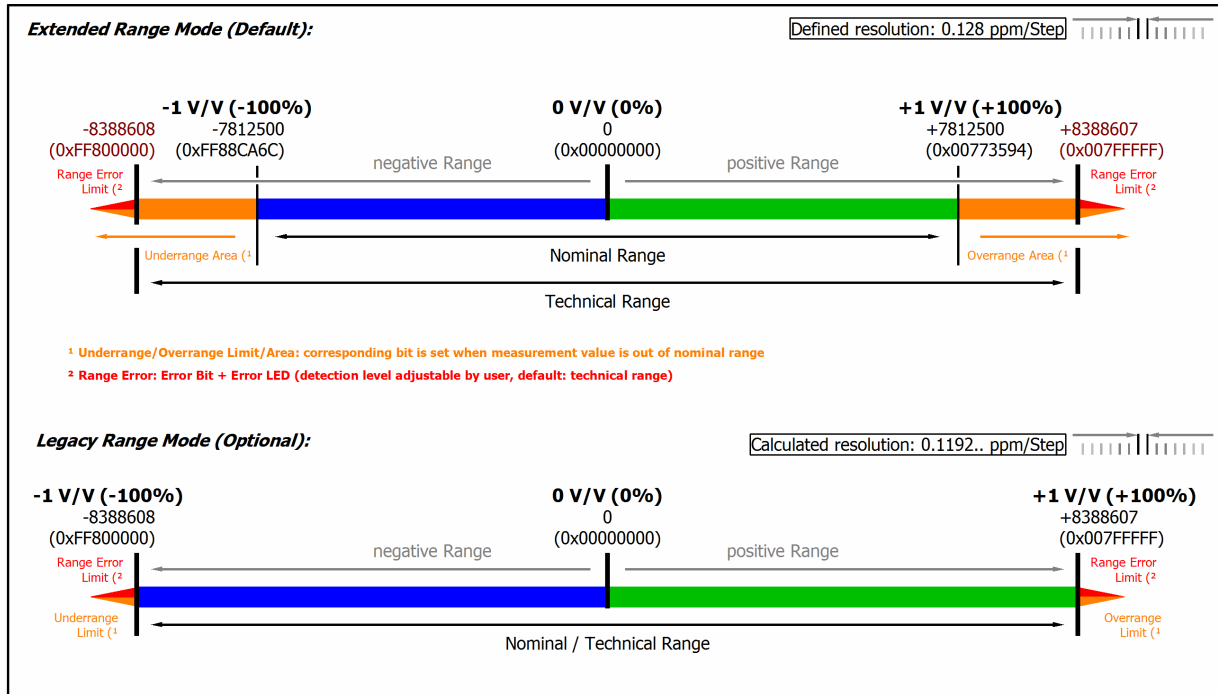

Fig. 43: Representation potentiometer measurement range

Note: In Extended Range Mode the Underrange/Overage display in the PDO status has the character of an information/warning when the nominal measuring range is exceeded, i.e. no *Error* is displayed in the PDO status and LED. If the technical measuring range is also exceeded, *Error = TRUE* is also displayed. The detection limit for Underrange/Overage *Error* can be set in the CoE. In Legacy Range mode, an Underrange/Overage event also leads to an *Error* in the PDO status.

## 2.2.26 Measurement SG 1/1 bridge (full bridge) 4/6-wire connection

To determine the measuring error:

The nominal/technical measuring range is specified in "mV/V"; the maximum permitted supply voltage is 5 V.

The maximum nominal measuring range that can be used for the bridge voltage is therefore  $\pm 32 \text{ mV/V} \cdot 5 \text{ V} = \pm 160 \text{ mV}$ ; the internal circuits are configured accordingly.

The internal measurement is ratiometric, i.e. the feed voltage and the bridge voltage are not measured absolutely, but as a ratio.

The integrated supply can be used as power supply. An external supply is permitted, as long as 5 V is not exceeded.

The transition resistance values of the terminal contacts affect the measurement. The measuring error can be reduced further through compensation by the user, with active signal connection.

Full bridge calculation:

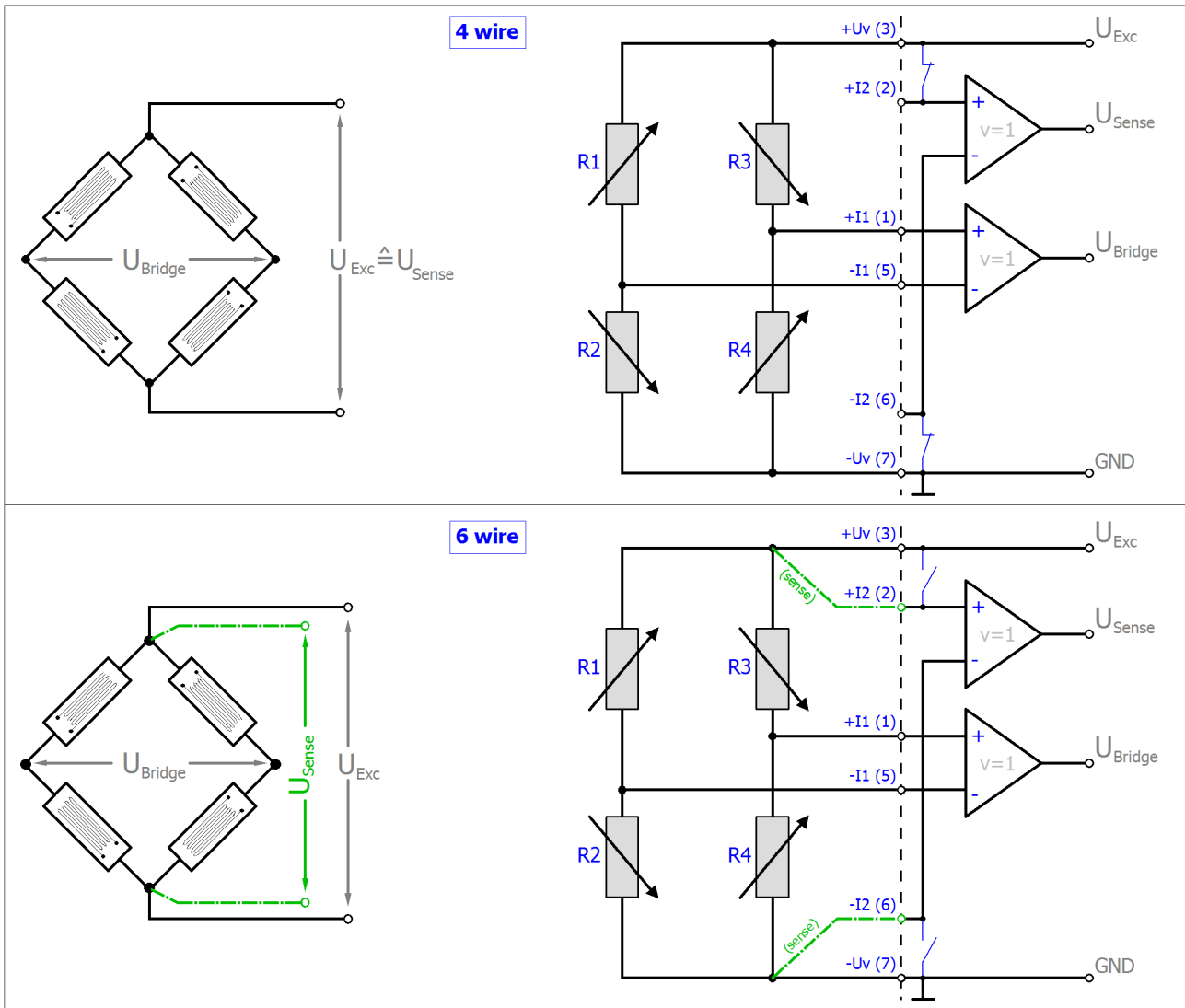

The strain relationship ( $\mu\text{Strain}$ ,  $\mu\epsilon$ ) is as follows:

$$\frac{U_{Bridge}}{U_{Exc}} = \frac{Nk\epsilon}{4}$$

$$N = 1, 2, 4, 1 - \vartheta, 1 + \vartheta, 2(1 - \vartheta), 2(1 + \vartheta)$$

Note: specifications apply for 2.5 V SG excitation.

Measurement mode		SG 1/1 bridge
Measuring range, nominal		-32...+32 mV/V
Measuring range, end value (full scale value)		32 mV/V
Measuring range, technically usable		-34.359...+34.359 mV/V
PDO resolution		24 bit (including sign)
PDO LSB (Extended Range)		4.096 nV/V
PDO LSB (Legacy Range)		3.814.. nV/V
Basic accuracy: Measuring deviation at 23°C, with averaging <sup>(2)</sup>		4-wire connection: $\pm 0.09\%_{\text{FSV}} = \pm 900 \text{ ppm}_{\text{FSV}}$ typ. 6-wire connection: $\pm 0.05\%_{\text{FSV}} = \pm 500 \text{ ppm}_{\text{FSV}}$ typ.
Integrated power supply		0.5...5 V adjustable, max. supply/excitation 21 mA (internal electronic overload protection) therefore <ul style="list-style-type: none"> <li>120R strain gauge: up to 2.5 V</li> <li>350R strain gauge: up to 5.0 V</li> </ul>
Temperature coefficient	T <sub>C</sub> Terminal	< 20 ppm/K typ.

<sup>2)</sup> Dominant part of the basic accuracy is its offset specification (see following tables). The process described in the Offset correction section eliminates this proportion and increases the measurement accuracy considerably.

Measurement mode		SG 1/1 bridge (4 wire)		
Offset/Zero Point deviation (at 23°C)	E <sub>Offset</sub>	< 850 [ppm <sub>FSV</sub> ]		
Gain/scale/amplification deviation (at 23°C)	E <sub>Gain</sub>	< 200 [ppm]		
Non-linearity over the whole measuring range	E <sub>Lin</sub>	< 120 [ppm <sub>FSV</sub> ]		
Repeatability	E <sub>Rep</sub>	< 15 [ppm <sub>FSV</sub> ]		
Noise (without filtering)	E <sub>Noise, PtP</sub>	< 320 [ppm <sub>FSV</sub> ]	< 2500 [digits]	
	E <sub>Noise, RMS</sub>	< 56 [ppm <sub>FSV</sub> ]	< 438 [digits]	
	Max. SNR	> 85 [dB]		
	Noisedensity@1kHz	$< 25.34 \frac{\text{nV/V}}{\sqrt{\text{Hz}}}$		
Noise (with 50 Hz FIR filtering)	E <sub>Noise, PtP</sub>	< 18 [ppm <sub>FSV</sub> ]	< 141 [digits]	
	E <sub>Noise, RMS</sub>	< 3.5 [ppm <sub>FSV</sub> ]	< 27 [digits]	
	Max. SNR	> 109.1 [dB]		
Common-mode rejection ratio (without filtering) <sup>3)</sup>		DC: $< 0.15 \frac{\mu\text{V/V}}{\text{V}}$ typ.	50 Hz: $< 0.5 \frac{\mu\text{V/V}}{\text{V}}$ typ.	1 kHz: $< 10 \frac{\mu\text{V/V}}{\text{V}}$ typ.
Common-mode rejection ratio (with 50 Hz FIR filtering) <sup>3)</sup>		DC: $< 100 \frac{\text{nV/V}}{\text{V}}$ typ.	50 Hz: $< 10 \frac{\text{nV/V}}{\text{V}}$ typ.	1 kHz: $< 1 \frac{\text{nV/V}}{\text{V}}$ typ.
Largest short-term deviation during a specified electrical interference test		$\pm 0.1\%_{\text{FSV}} = \pm 1000 \text{ ppm}_{\text{FSV}}$ typ.		
Input impedance ±Input 1 (Internal resistance)		Differential 4.1 MΩ    11 nF typ. CommonMode 1 MΩ    40 nF typ. Methodology: Resistor against -U <sub>V</sub> , capacitance against SGND		
Input impedance ±Input 2		No usage of this input in this mode		

<sup>3)</sup> Values related to a common mode interference between SGND and internal ground.



Measurement mode		SG 1/1 bridge (6 wire)	
Offset/Zero Point deviation (at 23°C)	$E_{\text{Offset}}$	< 470 [ppm <sub>FSV</sub> ]	
Gain/scale/amplification deviation (at 23°C)	$E_{\text{Gain}}$	< 120 [ppm]	
Non-linearity over the whole measuring range	$E_{\text{Lin}}$	< 120 [ppm <sub>FSV</sub> ]	
Repeatability	$E_{\text{Rep}}$	< 15 [ppm <sub>FSV</sub> ]	
Noise (without filtering) <sup>4</sup>	$E_{\text{Noise, PtP}}$	< 230 [ppm <sub>FSV</sub> ]	< 1797 [digits]
	$E_{\text{Noise, RMS}}$	< 38 [ppm <sub>FSV</sub> ]	< 297 [digits]
	Max. SNR	> 88.4 [dB]	
	Noisedensity@1kHz	$\frac{\text{nV/V}}{\sqrt{\text{Hz}}}$ < 17.2	
Noise (with 50 Hz FIR filtering) <sup>4</sup>	$E_{\text{Noise, PtP}}$	< 18 [ppm <sub>FSV</sub> ]	< 141 [digits]
	$E_{\text{Noise, RMS}}$	< 3.5 [ppm <sub>FSV</sub> ]	< 27 [digits]
	Max. SNR	> 109.1 [dB]	
Common-mode rejection ratio (without filtering) <sup>3</sup>	DC:	50 Hz:	1 kHz:
	$< 0.15 \frac{\mu\text{V/V}}{\text{V}}$ typ.	$< 0.5 \frac{\mu\text{V/V}}{\text{V}}$ typ.	$< 10 \frac{\mu\text{V/V}}{\text{V}}$ typ.
Common-mode rejection ratio (with 50 Hz FIR filtering) <sup>3</sup>	DC:	50 Hz:	1 kHz:
	$< 100 \frac{\text{nV/V}}{\text{V}}$ typ.	$< 10 \frac{\text{nV/V}}{\text{V}}$ typ.	$< 1 \frac{\text{nV/V}}{\text{V}}$ typ.
Largest short-term deviation during a specified electrical interference test	$\pm 0.1\%_{\text{FSV}} = \pm 1000 \text{ ppm}_{\text{FSV}}$ typ.		
Input impedance ±Input 1 (Internal resistance)	Differential 4.1 MΩ    11 nF typ.		
	CommonMode 1 MΩ    40 nF typ. Methodology: Resistor against -U <sub>v</sub> , capacitance against SGND		
Input impedance ±Input 2 (Internal resistance)	Differential 5 MΩ    10 nF typ.		
	CommonMode 1.25 MΩ    40 nF typ. Methodology: Resistor against -U <sub>v</sub> (+2.5V), capacitance against SGND		

<sup>3)</sup> Values related to a common mode interference between SGND and internal ground.

<sup>4)</sup> Specifications valid for HW Version ≥ 10, only! Valid specifications until HW Version 10 are as follows:

Measurement mode		SG 1/1 bridge (6 wire), < HW10	
Noise (without filtering)	$E_{\text{Noise, PtP}}$	< 960 [ppm <sub>FSV</sub> ]	< 7500 [digits]
	$E_{\text{Noise, RMS}}$	< 170 [ppm <sub>FSV</sub> ]	< 1328 [digits]
	Max. SNR	> 75.4 [dB]	
	Noisedensity@1kHz	$\frac{\text{nV/V}}{\sqrt{\text{Hz}}}$ < 76.93	
Noise (with 50 Hz FIR filtering)	$E_{\text{Noise, PtP}}$	< 77 [ppm <sub>FSV</sub> ]	< 602 [digits]
	$E_{\text{Noise, RMS}}$	< 15 [ppm <sub>FSV</sub> ]	< 117 [digits]
	Max. SNR	> 96.5 [dB]	

The channel value (PDO) is interpreted directly [mV/V]:

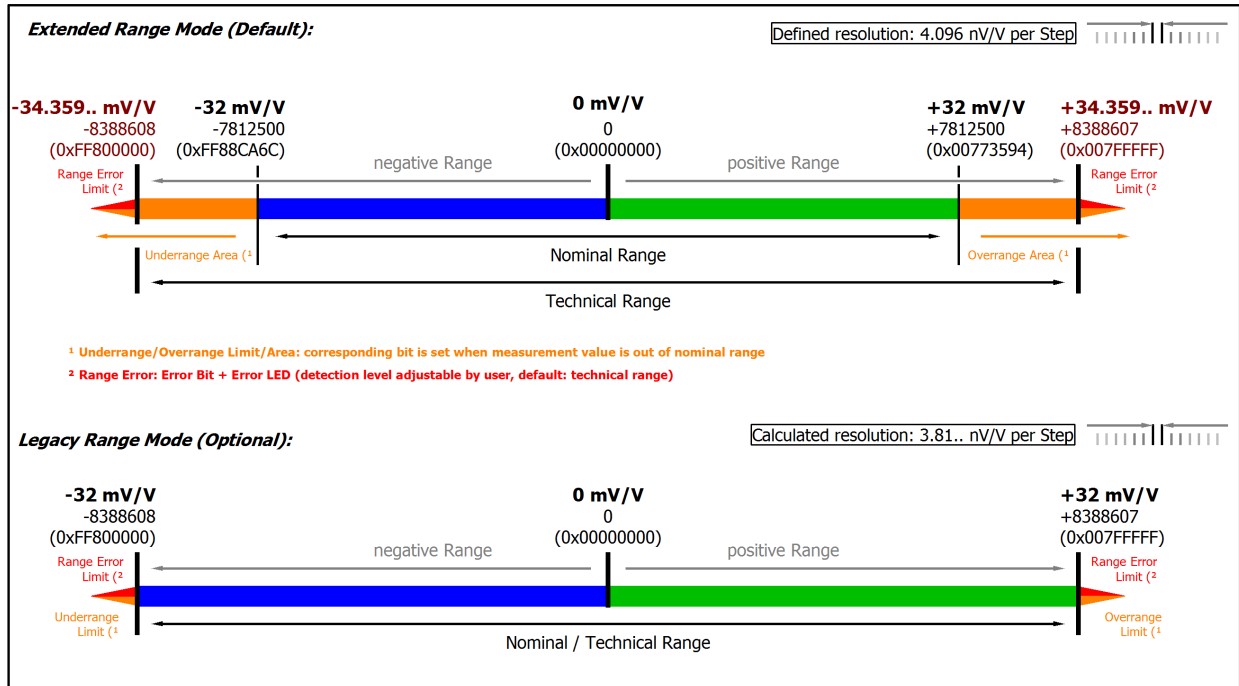

Fig. 44: Representation measuring range SG 1/1 bridge

## 2.2.27 Measurement SG 1/2 bridge (half bridge) 3/5-wire connection

To determine the measuring error:

The nominal/technical measuring range is specified in "mV/V"; the maximum permitted supply voltage is 5 V.

The maximum nominal measuring range that can be used for the bridge voltage is therefore  $\pm 16 \text{ mV/V} \cdot 5 \text{ V} = \pm 80 \text{ mV}$  the internal circuits are designed for the 160 mV of the full bridge measurement.

The internal measurement is ratiometric, i.e. the feed voltage and the bridge voltage are not measured absolutely, but as a ratio.

The integrated supply can be used as power supply. An external supply is permitted, as long as 5 V is not exceeded.

The transition resistance values of the terminal contacts affect the measurement. The measuring error can be reduced further through compensation by the user, with active signal connection.

---

### **i** Validity of property values

The resistor of the bridge is positioned parallel to the internal resistor of the terminal and leads to an offset shifting respectively. The Beckhoff factory calibration will be carried out with the half bridge 350  $\Omega$ , thus the values specified above are directly valid for the 350  $\Omega$  half bridge. By connection of another dimensioned half-bridge is to:

- perform a balancing (offset correction) by the terminal itself or the control/PLC on application side
  - or the abstract offset error have to be entered into the balancing parameter S0 of the terminal. Example: a 350  $\Omega$  half bridge correlates by the compensated effect of the input resistor (2 M $\Omega$ ) during factory calibration 0.26545 %<sub>FSV</sub> (16 mV/V), that corresponds to 20738 digits.
-

Half bridge calculation:

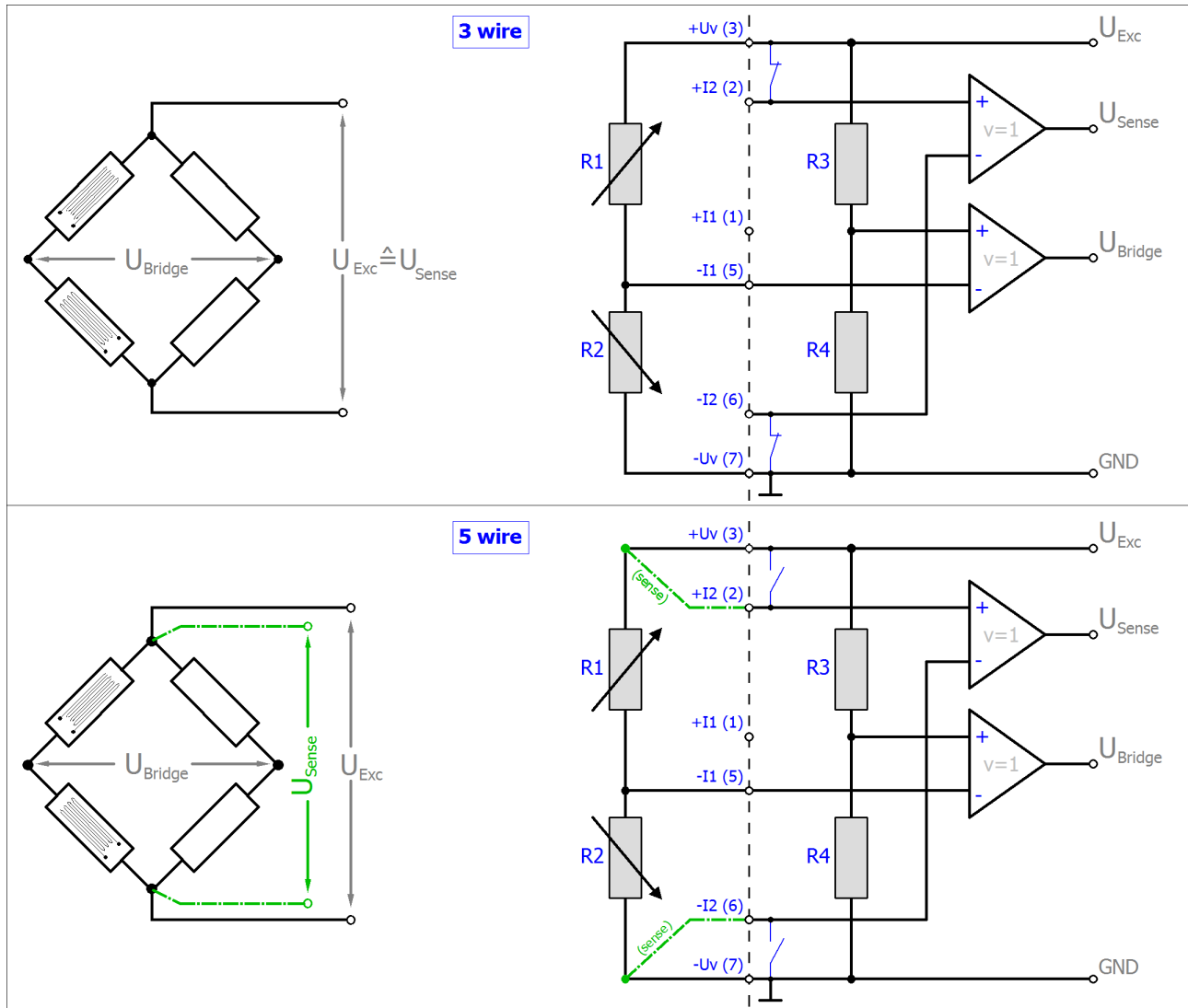

$R_{3/4}$  are the internal switchable input resistors of the terminal. Other configurations (e.g.  $R_{1/4}$  or  $R_{1/3}$  variable) of half bridges are not supported

The strain relationship ( $\mu\text{Strain}$ ,  $\mu\epsilon$ ) is as follows:

$$\frac{U_{Bridge}}{U_{Exc}} = \frac{Nk\epsilon}{4}$$

$$N = 1, 2, 4, 1 - \vartheta, 1 + \vartheta$$

N should be chosen based on the mechanical configuration of the variable resistors (Poisson, 2 active uniaxial, ...).

Note: specifications apply for 2.5 V SG excitation.

Measurement mode		SG 1/2 bridge
Measuring range, nominal		-16...+16 mV/V [corresponds to ±16000 µε at K=2, N=2]
Measuring range, end value (full scale value)		16 mV/V
Measuring range, technically usable		-17.179...+17.179 mV/V
PDO resolution		24 bit (including sign)
PDO LSB (Extended Range)		2.048 nV/V
PDO LSB (Legacy Range)		1.907.. nV/V
Basic accuracy: Measuring deviation at 23°C, with averaging (²)		3-wire connection: ±0.27% typ. (relative to full scale value, q.v. note [► 79]) 5-wire connection: ±0.09% typ. (relative to full scale value, q.v. note [► 79])
Integrated power supply		0.5...5 V adjustable, max. supply/excitation 21 mA (internal electronic overload protection) therefore • 120R strain gauge: up to 2.5V • 350R strain gauge: up to 5.0V
Temperature coefficient	T <sub>C</sub> Terminal	<75 ppm/K typ. (rel. to full scale value, since production 2016 week 10; refer to serial number) <250 ppm/K typ. (rel. to full scale value, production until 2016 week 09; refer to serial number)
Input impedance ±Input 1 (Internal resistance)		Differential 4.1 MΩ    11 nF typ. CommonMode 1 MΩ    40 nF typ. Methodology: Resistor against -U <sub>V</sub> , capacitance against SGND
Input impedance ±Input 2 (Internal resistance)		Differential 5 MΩ    10 nF typ. CommonMode 1.25 MΩ    40 nF typ. Methodology: Resistor against -U <sub>V</sub> (+2.5V), capacitance against SGND

²) Dominant part of the basic accuracy is its offset specification (see following tables). The process described in the Offset correction section eliminates this proportion and increases the measurement accuracy considerably.

Measurement mode		SG 1/2 bridge (3 wire)	
Offset/Zero Point deviation (at 23°C)	E <sub>Offset</sub>	< 2650 ppm <sub>FSV</sub> (valid since 2018 week 01; value before 2018 week 01: < 3600 ppm <sub>FSV</sub> )	
Gain/scale/amplification deviation (at 23°C)	E <sub>Gain</sub>	< 290 ppm	
Non-linearity over the whole measuring range	E <sub>Lin</sub>	< 390 ppm <sub>FSV</sub>	
Repeatability	E <sub>Rep</sub>	< 50 ppm <sub>FSV</sub>	
Noise (without filtering) <sup>4</sup>	E <sub>Noise, PtP</sub>	< 950 ppm <sub>FSV</sub>	< 7422 [digits]
	E <sub>Noise, RMS</sub>	< 145 ppm <sub>FSV</sub>	< 1133 [digits]
	Max. SNR	> 76.8 dB	
	Noisedensity @1kHz	< 32.81 $\frac{nV/V}{\sqrt{Hz}}$	
Noise (with 50 Hz FIR filtering) <sup>4</sup>	E <sub>Noise, PtP</sub>	< 70 ppm <sub>FSV</sub>	< 547 [digits]
	E <sub>Noise, RMS</sub>	< 15 ppm <sub>FSV</sub>	< 117 [digits]

Measurement mode		SG 1/2 bridge (3 wire)		
	Max. SNR	> 96.5 dB		
Common-mode rejection ratio (without filtering) <sup>3</sup>		DC: $< 150 \frac{\mu V/V}{V}$ typ.	50 Hz: $< 600 \frac{\mu V/V}{V}$ typ.	1 kHz: $< 10 \frac{mV/V}{V}$ typ.
Common-mode rejection ratio (with 50 Hz FIR filtering) <sup>3</sup>		DC: $< 100 \frac{\mu V/V}{V}$ typ.	50 Hz: $< 20 \frac{\mu V/V}{V}$ typ.	1 kHz: $< 0.1 \frac{\mu V/V}{V}$ typ.
Largest short-term deviation during a specified electrical interference test		$\pm 0.2\%_{FSV} = \pm 2000 \text{ ppm}_{FSV}$ typ.		

<sup>3)</sup> Values related to a common mode interference between SGND and internal ground.

<sup>4)</sup> Specifications valid for HW Version  $\geq 10$ , only! Valid specifications until HW Version 10 are as follows:

Measurement mode		SG 1/2 bridge (3 wire), < HW10	
Noise (without filtering)	$E_{\text{Noise. PtP}}$	< 1100 ppm <sub>FSV</sub>	< 8594 [digits]
	$E_{\text{Noise. RMS}}$	< 160 ppm <sub>FSV</sub>	< 1250 [digits]
	Max. SNR	> 75.9 dB	
	Noisedensity @1kHz	$< 36.2 \frac{nV/V}{\sqrt{\text{Hz}}}$	
Noise (with 50 Hz FIR filtering)	$E_{\text{Noise. PtP}}$	< 120 ppm <sub>FSV</sub>	< 938 [digits]
	$E_{\text{Noise. RMS}}$	< 19 ppm <sub>FSV</sub>	< 148 [digits]
	Max. SNR	> 94.4 dB	

Measurement mode		SG 1/2 bridge (5 wire)		
Offset/Zero Point deviation (at 23°C)	$E_{\text{Offset}}$	< 750 ppm <sub>FSV</sub> (valid since 2018 week 01; value before 2018 week 01: < 1100 ppm <sub>FSV</sub> )		
Gain/scale/amplification deviation (at 23°C)	$E_{\text{Gain}}$	< 290 ppm		
Non-linearity over the whole measuring range	$E_{\text{Lin}}$	< 390 ppm <sub>FSV</sub>		
Repeatability	$E_{\text{Rep}}$	< 50 ppm <sub>FSV</sub>		
Noise (without filtering) <sup>4</sup>	$E_{\text{Noise. PtP}}$	< 1200 ppm <sub>FSV</sub>	< 9375 [digits]	
	$E_{\text{Noise. RMS}}$	< 175 ppm <sub>FSV</sub>	< 1367 [digits]	
	Max. SNR	> 75.1 dB		
	Noisedensity @1kHz	$< 39.6 \frac{nV/V}{\sqrt{\text{Hz}}}$		
Noise (with 50 Hz FIR filtering) <sup>4</sup>	$E_{\text{Noise. PtP}}$	< 70 ppm <sub>FSV</sub>	< 547 [digits]	
	$E_{\text{Noise. RMS}}$	< 14 ppm <sub>FSV</sub>	< 109 [digits]	
	Max. SNR	> 97.1 dB		
Common-mode rejection ratio (without filtering) <sup>3</sup>		DC: $< 150 \frac{\mu V/V}{V}$ typ.	50 Hz: $< 600 \frac{\mu V/V}{V}$ typ.	1 kHz: $< 10 \frac{mV/V}{V}$ typ.
Common-mode rejection ratio (with 50 Hz FIR filtering) <sup>3</sup>		DC: $< 100 \frac{\mu V/V}{V}$ typ.	50 Hz: $< 20 \frac{\mu V/V}{V}$ typ.	1 kHz: $< 0.1 \frac{\mu V/V}{V}$ typ.
Largest short-term deviation during a specified electrical interference test		$\pm 0.2\%_{FSV} = \pm 2000 \text{ ppm}_{FSV}$ typ.		

<sup>3)</sup> Values related to a common mode interference between SGND and internal ground.

<sup>4)</sup> Specifications valid for HW Version  $\geq 10$ , only! Valid specifications until HW Version 10 are as follows:

Measurement mode		SG 1/2 bridge (5 wire), < HW10	
Noise (without filtering)	$E_{\text{Noise. PtP}}$	< 1600 ppm <sub>FSV</sub>	< 12500 [digits]
	$E_{\text{Noise. RMS}}$	< 240 ppm <sub>FSV</sub>	< 1875 [digits]
	Max. SNR	> 72.4 dB	
	Noisedensity @1kHz	< 54.31 $\frac{\text{nV/V}}{\sqrt{\text{Hz}}}$	
Noise (with 50 Hz FIR filtering)	$E_{\text{Noise. PtP}}$	< 96 ppm <sub>FSV</sub>	< 750 [digits]
	$E_{\text{Noise. RMS}}$	< 16 ppm <sub>FSV</sub>	< 125 [digits]
	Max. SNR	> 95.9 dB	

The channel value (PDO) is interpreted directly [mV/V]:

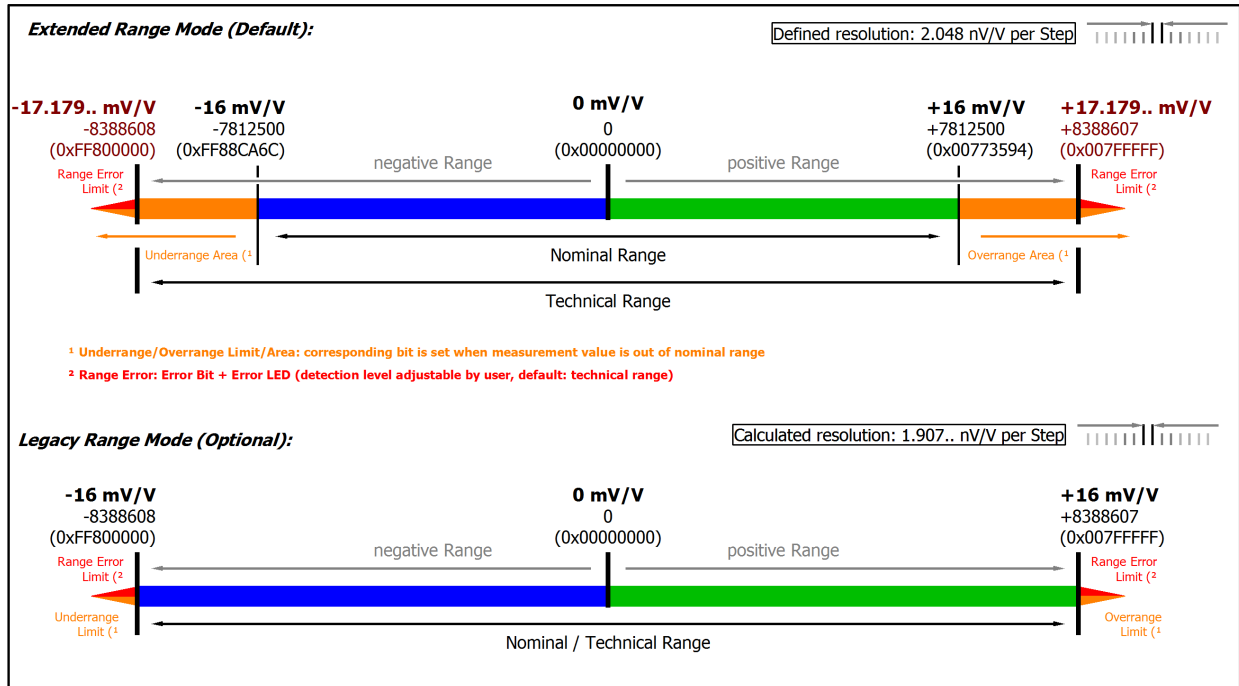

Fig. 45: Representation measuring range SG 1/2 bridge



## 2.2.28 Measurement SG 1/4 bridge (quarter bridge) 120 Ω 2/3-wire connection

To determine the measuring error:

The transition resistance values of the terminal contacts affect the measurement. The measuring error can be reduced further through compensation by the user, with active signal connection.

The temperature coefficient (Terminal) can be significantly improved through an external, more temperature-stable auxiliary resistor and the terminal in half/full bridge operation.

Quarter bridge calculation:

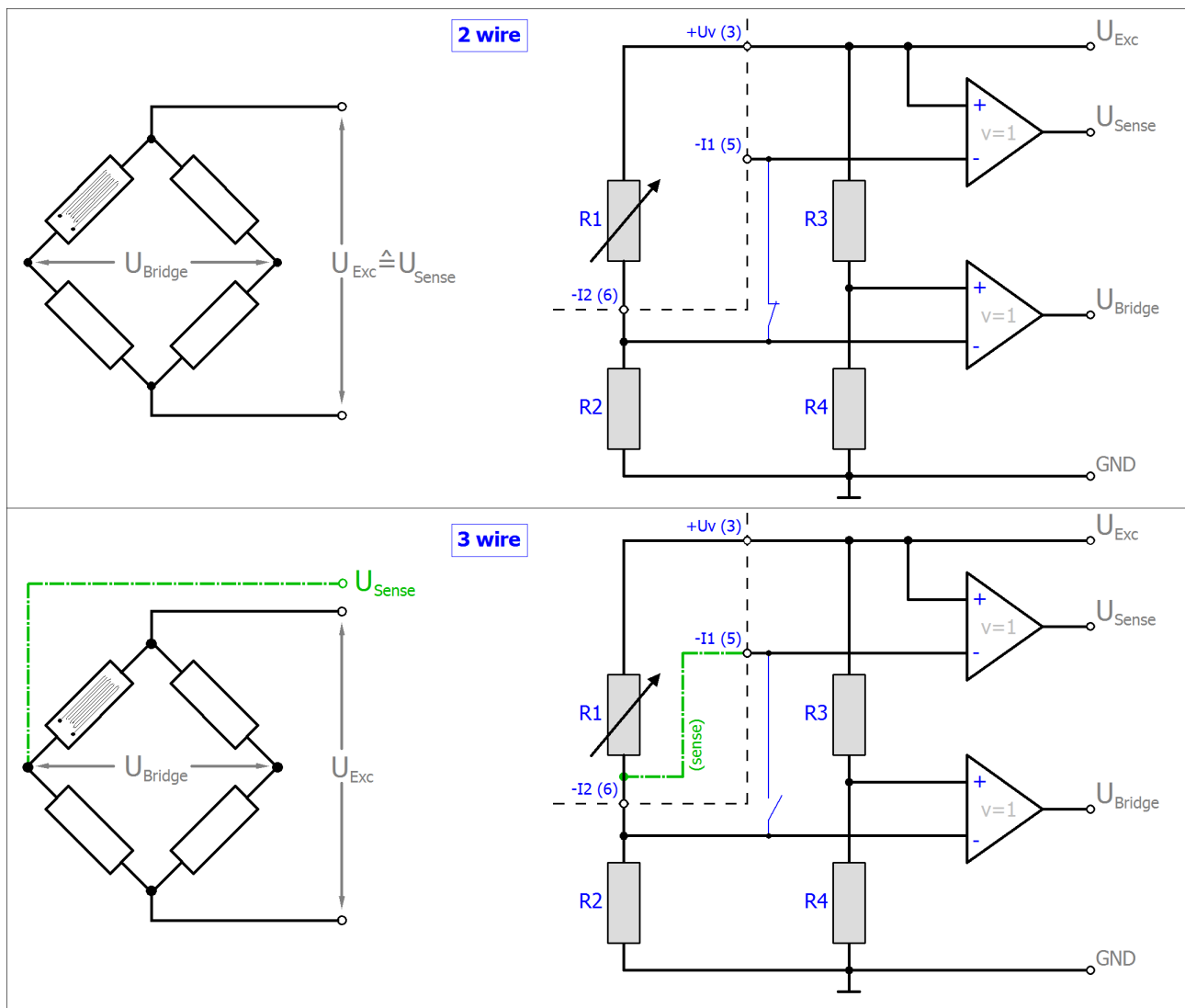

R<sub>2/3/4</sub> are the internal switchable input resistors of the terminal.

The strain relationship (μStrain, με) is as follows:

$$\frac{U_{Bridge}}{U_{Exc}} = \frac{N \Delta R_1}{4 R_1} = \frac{N k \epsilon}{4}$$

$$N = 1$$

For the quarter bridge, N=1 always applies.

Note: specifications apply for 2.5 V SG excitation.

Measurement mode		SG 1/4 bridge 120 Ω
Measuring range, nominal		120 ± 12 Ω or ±25 mV/V [corresponds to 108 Ω...132 Ω] [corresponds to ±50000 µε at K=2]
Measuring range, end value (full scale value)		132 Ω
Measuring range, technically usable		120 ± 12.88.. Ω
PDO resolution		24 bit (including sign)
PDO LSB (Extended Range)		1.536 µΩ/Step
PDO LSB (Legacy Range)		1.430.. µΩ/Step
Basic accuracy: Measuring deviation at 23°C, with averaging <sup>(2)</sup>		2-wire connection: 0.05% typ. (relative to full scale value) 3-wire connection: 0.04% typ. (relative to full scale value) 4-wire connection: not possible
Integrated power supply		0.5...2.5 V adjustable, max. supply/excitation 21 mA (internal electronic overload protection)
Temperature coefficient <sup>(1)</sup> [► 86]	T <sub>C-Terminal</sub>	<8 ppm/K typ. (rel. to full scale value, from HW Version 06; refer to serial number) <12 ppm/K typ. (rel. to full scale value, HW Version 04, since production 2016 week 10; refer to serial number) <60 ppm/K typ. (rel. to full scale value, HW Version 01-04, production until 2016 week 09; refer to serial number)

1) Please see the remarks to 2/3/4 wire measurement within [section for resistance measurement \[► 65\]](#) of section “technical data”.

2) Dominant part of the basic accuracy is its offset specification (see following tables). The process described in the Offset correction section eliminates this proportion and increases the measurement accuracy considerably.

Measurement mode		SG 1/4 bridge 120 Ω (2 wire)	
Offset/Zero Point deviation (at 23°C)	E <sub>Offset</sub>	< 420 [ppm <sub>FSV</sub> ]	
Gain/scale/amplification deviation (at 23°C)	E <sub>Gain</sub>	< 250 [ppm]	
Non-linearity over the whole measuring range	E <sub>Lin</sub>	< 50 [ppm <sub>FSV</sub> ]	
Repeatability (at 23°C)	E <sub>Rep</sub>	< 15 [ppm <sub>FSV</sub> ]	
Noise (without filtering, at 23°C)	E <sub>Noise, PtP</sub>	< 160 [ppm <sub>FSV</sub> ]	< 13750 [digits]
	E <sub>Noise, RMS</sub>	< 20 [ppm <sub>FSV</sub> ]	< 1720 [digits]
	Max. SNR	> 73.1 [dB]	
	Noisedensity @1kHz	< 37.36 $\frac{m\Omega}{\sqrt{Hz}}$	
Noise (with 50 Hz FIR filtering, at 23°C)	E <sub>Noise, PtP</sub>	< 6 [ppm <sub>FSV</sub> ]	< 520 [digits]
	E <sub>Noise, RMS</sub>	< 1 [ppm <sub>FSV</sub> ]	< 86 [digits]
	Max. SNR	> 99.2 [dB]	

Measurement mode	SG 1/4 bridge 120 Ω (2 wire)		
Common-mode rejection ratio (without filtering) <sup>3</sup>	DC: < 0.3 Ω/V typ.	50 Hz: < 1 Ω/V typ.	1 kHz: < 20 Ω/V typ.
Common-mode rejection ratio (with 50 Hz FIR filtering) <sup>3</sup>	DC: < 300 mΩ/V typ.	50 Hz: < 40 mΩ/V typ.	1 kHz: < 0.5 mΩ/V typ.
Largest short-term deviation during a specified electrical interference test	±1% <sub>F<sub>SV</sub></sub> typ.		

<sup>3</sup>) Values related to a common mode interference between SGND and internal ground.

Measurement mode	SG 1/4 bridge 120 Ω (3 wire)		
Offset/Zero Point deviation (at 23°C)	E <sub>Offset</sub>	< 360 [ppm <sub>F<sub>SV</sub></sub> ]	
Gain/scale/amplification deviation (at 23°C)	E <sub>Gain</sub>	< 150 [ppm]	
Non-linearity over the whole measuring range	E <sub>Lin</sub>	< 50 [ppm <sub>F<sub>SV</sub></sub> ]	
Repeatability (at 23°C)	E <sub>Rep</sub>	< 15 [ppm <sub>F<sub>SV</sub></sub> ]	
Noise (without filtering, at 23°C)	E <sub>Noise, PTP</sub>	< 160 [ppm <sub>F<sub>SV</sub></sub> ]	< 13750 [digits]
	E <sub>Noise, RMS</sub>	< 20 [ppm <sub>F<sub>SV</sub></sub> ]	< 1720 [digits]
	Max. SNR	> 73.1 [dB]	
	Noisedensity @1kHz	$< 37.36 \frac{m\Omega}{\sqrt{Hz}}$	
Noise (with 50 Hz FIR filtering, at 23°C)	E <sub>Noise, PTP</sub>	< 6 [ppm <sub>F<sub>SV</sub></sub> ]	< 520 [digits]
	E <sub>Noise, RMS</sub>	< 1 [ppm <sub>F<sub>SV</sub></sub> ]	< 86 [digits]
	Max. SNR	> 99.2 [dB]	
Common-mode rejection ratio (without filtering) <sup>3</sup>	DC: < 0.3 Ω/V typ.	50 Hz: < 1 Ω/V typ.	1 kHz: < 20 Ω/V typ.
Common-mode rejection ratio (with 50 Hz FIR filtering) <sup>3</sup>	DC: < 300 mΩ/V typ.	50 Hz: < 40 mΩ/V typ.	1 kHz: < 0.5 mΩ/V typ.
Largest short-term deviation during a specified electrical interference test	±1% <sub>F<sub>SV</sub></sub> typ.		

<sup>3</sup>) Values related to a common mode interference between SGND and internal ground.

The channel value (PDO) can be interpolated in ±12 Ω or ±25 mV/V:

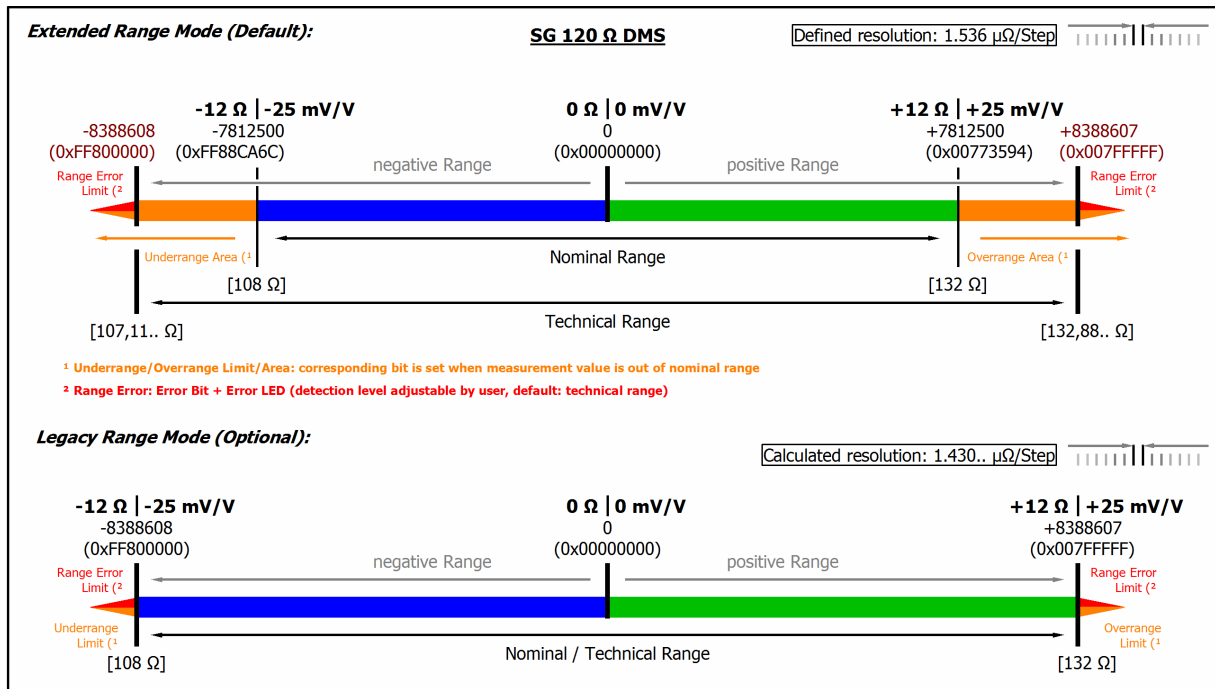

Fig. 46: Representation measuring range SG 1/4 bridge 120 Ω

## 2.2.29 Measurement SG 1/4 bridge (quarter bridge) 350 Ω 2/3-wire connection

To determine the measuring error:

The transition resistance values of the terminal contacts affect the measurement. The measuring error can be reduced further through compensation by the user, with active signal connection.

The temperature coefficient (Terminal) can be significantly improved through an external, more temperature-stable auxiliary resistor and the terminal in half/full bridge operation.

Quarter bridge calculation:

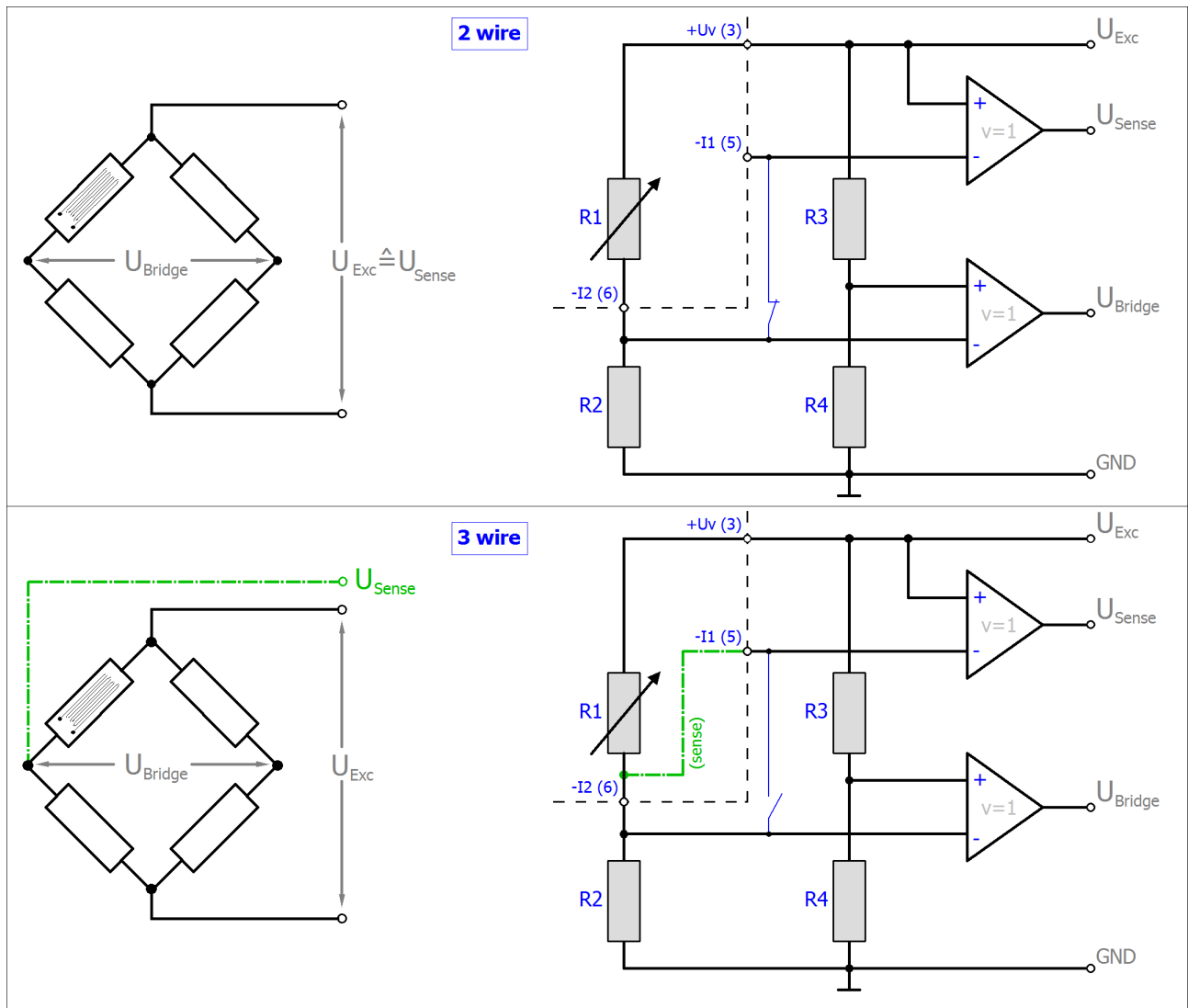

$R_{2/3/4}$  are the internal switchable input resistors of the terminal.

The strain relationship ( $\mu\text{Strain}$ ,  $\mu\epsilon$ ) is as follows:

$$\frac{U_{Bridge}}{U_{Exc}} = \frac{N \Delta R_1}{4 R_1} = \frac{N k \epsilon}{4}$$

$$N = 1$$

For the quarter bridge,  $N=1$  always applies.

Note: specifications apply for 2.5 V SG excitation.

Measurement mode		SG 1/4 bridge 350 Ω
Measuring range, nominal		350 ± 12 Ω or ±8.571 mV/V [corresponds to 338 Ω...362 Ω] [corresponds to ±17142 µε at K=2]
Measuring range, end value (full scale value)		362 Ω
Measuring range, technically usable		350 ± 12.88.. Ω
PDO resolution		24 bit (including sign)
PDO LSB (Extended Range)		1.536 µΩ/Step
PDO LSB (Legacy Range)		1.430.. µΩ/Step
Basic accuracy: Measuring deviation at 23°C, with averaging <sup>(2)</sup>		2-wire connection: 0.03% typ. (relative to full scale value) 3-wire connection: 0.02% typ. (relative to full scale value) 4-wire connection: not possible
Integrated power supply		0.5...5V adjustable, max. supply/excitation 21 mA (internal electronic overload protection)
Temperature coefficient <sup>(1)</sup> [▶ 90]	T <sub>C_Terminal</sub>	<8 ppm/K typ. (rel. to full scale value, since production 2016 week 10; refer to serial number) <40 ppm/K typ. (rel. to full scale value, production until 2016 week 09; refer to serial number)

1) Please see the remarks to 2/3/4 wire measurement within section for resistance measurement [▶ 65] of section “technical data”.

2) Dominant part of the basic accuracy is its offset specification (see following tables). The process described in the Offset correction section eliminates this proportion and increases the measurement accuracy considerably.

Measurement mode		SG 1/4 bridge 350 Ω (2 wire)		
Offset/Zero Point deviation (at 23°C)	E <sub>Offset</sub>	< 250 [ppm <sub>FSV</sub> ]		
Gain/scale/amplification deviation (at 23°C)	E <sub>Gain</sub>	< 150 [ppm]		
Non-linearity over the whole measuring range	E <sub>Lin</sub>	< 40 [ppm <sub>FSV</sub> ]		
Repeatability (at 23°C)	E <sub>Rep</sub>	< 10 [ppm <sub>FSV</sub> ]		
Noise (without filtering, at 23°C)	E <sub>Noise, PtP</sub>	< 105 [ppm <sub>FSV</sub> ]	< 24750 [digits]	
	E <sub>Noise, RMS</sub>	< 18 [ppm <sub>FSV</sub> ]	< 4240 [digits]	
	Max. SNR	> 65.3 [dB]		
	Noisedensity @1kHz	< 92.1 $\frac{m\Omega}{\sqrt{Hz}}$		
Noise (with 50 Hz FIR filtering, at 23°C)	E <sub>Noise, PtP</sub>	< 6 [ppm <sub>FSV</sub> ]	< 1400 [digits]	
	E <sub>Noise, RMS</sub>	< 1 [ppm <sub>FSV</sub> ]	< 236 [digits]	
	Max. SNR	> 90.4 [dB]		
Common-mode rejection ratio (without filtering) <sup>3</sup>		DC: < 2 Ω/V typ.	50 Hz: < 8 Ω/V typ.	1 kHz: < 150 Ω/V typ.
Common-mode rejection ratio (with 50 Hz FIR filtering) <sup>3</sup>		DC: < 700 mΩ/V typ.	50 Hz: < 90 mΩ/V typ.	1 kHz: < 0.5 mΩ/V typ.

Measurement mode	SG 1/4 bridge 350 Ω (2 wire)
Largest short-term deviation during a specified electrical interference test	$\pm 1\%_{\text{FSV}}$ typ.

<sup>3)</sup> Values related to a common mode interference between SGND and internal ground.

Measurement mode		SG 1/4 bridge 350 Ω (3 wire)		
Offset/Zero Point deviation (at 23°C)	$E_{\text{Offset}}$	< 140 [ppm <sub>FSV</sub> ]		
Gain/scale/amplification deviation (at 23°C)	$E_{\text{Gain}}$	< 130 [ppm]		
Non-linearity over the whole measuring range	$E_{\text{Lin}}$	< 40 [ppm <sub>FSV</sub> ]		
Repeatability (at 23°C)	$E_{\text{Rep}}$	< 10 [ppm <sub>FSV</sub> ]		
Noise (without filtering, at 23°C)	$E_{\text{Noise, PtP}}$	< 105 [ppm <sub>FSV</sub> ]	< 24750 [digits]	
	$E_{\text{Noise, RMS}}$	< 18 [ppm <sub>FSV</sub> ]	< 4240 [digits]	
	Max. SNR	> 65.3 [dB]		
	Noisedensity @1kHz	< 92.1 $\frac{\text{m}\Omega}{\sqrt{\text{Hz}}}$		
Noise (with 50 Hz FIR filtering, at 23°C)	$E_{\text{Noise, PtP}}$	< 6 [ppm <sub>FSV</sub> ]	< 1400 [digits]	
	$E_{\text{Noise, RMS}}$	< 1 [ppm <sub>FSV</sub> ]	< 236 [digits]	
	Max. SNR	> 90.4 [dB]		
Common-mode rejection ratio (without filtering) <sup>3)</sup>		DC: < 2 Ω/V typ.	50 Hz: < 8 Ω/V typ.	1 kHz: < 150 Ω/V typ.
Common-mode rejection ratio (with 50 Hz FIR filtering) <sup>3)</sup>		DC: < 700 mΩ/V typ.	50 Hz: < 90 mΩ/V typ.	1 kHz: < 0.5 mΩ/V typ.
Largest short-term deviation during a specified electrical interference test		$\pm 1\%_{\text{FSV}}$ typ.		

<sup>3)</sup> Values related to a common mode interference between SGND and internal ground.

The channel value (PDO) can be interpolated in  $\pm 12 \Omega$  or  $\pm 8.571 \text{ mV/V}$ :

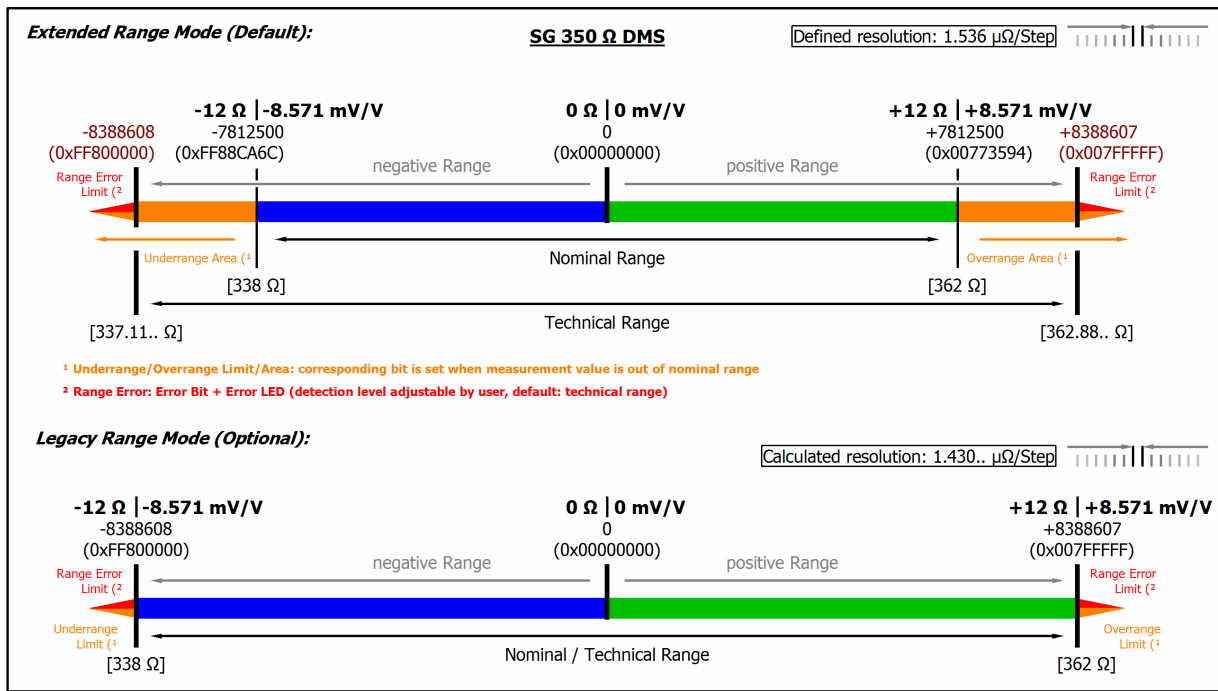

Fig. 47: Representation measuring range SG 1/4 bridge 350 Ω



## 3 Commissioning

### 3.1 Notes to short documentation

#### *NOTICE*

This short documentation does not contain any further information within this chapter. For the complete documentation please contact the Beckhoff sales department responsible for you.

## 3.2 CoE overview

### 3.2.1 0x6000 PAI Status Ch.1

Index (hex)	Name	Meaning	Data type	Flags	Default
6000:0	PAI Status Ch.1		UINT8	RO	0x0F (15 <sub>dec</sub> )
6000:01	No of Samples	Number of valid samples within the PDO samples	UINT8	RO	0x00 (0 <sub>dec</sub> )
6000:09	Error	TRUE: General error	BOOLEAN	RO	0x00 (0 <sub>dec</sub> )
6000:0A	Underrange	TRUE: Measurement event underflow	BOOLEAN	RO	0x00 (0 <sub>dec</sub> )
6000:0B	Overrange	TRUE: Measurement event overflow	BOOLEAN	RO	0x00 (0 <sub>dec</sub> )
6000:0D	Diag	TRUE: New diagnostic message available	BOOLEAN	RO	0x00 (0 <sub>dec</sub> )
6000:0E	TxPDO State	TRUE: data invalid	BOOLEAN	RO	0x00 (0 <sub>dec</sub> )
6000:0F	Input cycle counter	Incremented by one when values have changed	BIT2	RO	0x00 (0 <sub>dec</sub> )

### 3.2.2 0x6001 PAI Samples Ch.1

Index (hex)	Name	Meaning	Data type	Flags	Default
6001:0	PAI Samples Ch.1		UINT8	RO	0x64 (100 <sub>dec</sub> )
6001:01	Sample	Samples	INT32	RO	0x00000000 (0 <sub>dec</sub> )
...	...	...	...	...	...
6001:64	Sample	Samples	INT32	RO	0x00000000 (0 <sub>dec</sub> )

### 3.2.3 0x6002 PAI Synchronous Oversampling Ch.1

Index (hex)	Name	Meaning	Data type	Flags	Default
6002:0	PAI Synchronous Oversampling Ch.1		UINT8	RO	0x01 (1 <sub>dec</sub> )
6002:01	Internal Buffer		UINT16	RO	0x0000 (0 <sub>dec</sub> )

### 3.2.4 0x7000 PAI Control Ch.1

Index (hex)	Name	Meaning	Data type	Flags	Default
7000:0	PAI Control Ch.1		UINT8	RO	0x02 (2 <sub>dec</sub> )
7000:01	Integrator Reset	Restart of the integration with rising edge	BOOLEAN	RO	0x00 (0 <sub>dec</sub> )
7000:02	Peak Hold Reset	Start new peak value detection with rising edge	BOOLEAN	RO	0x00 (0 <sub>dec</sub> )

### 3.2.5 0x8000 PAI Settings Ch.1

Index (hex)	Name	Meaning	Data type	Flags	Default
8000:0	PAI Settings Ch.1		UINT8	RO	0x34 (52 <sub>dec</sub> ) 0x41 (65 <sub>dec</sub> ) <sup>2)</sup>
8000:01	Interface	Selection of the measurement configuration: 0 - None 1 - V ±30V 2 - V ±10V 3 - V ±5V 4 - V ±2.5V 5 - V ±1.25V 6 - V ±640mV 7 - V ±320mV 8 - V ±160mV 9 - V ±80mV 10 - V ±40mV 11 - V ±20mV 12 - V ±10mV 13 - V ±5mV 14 - V 0...10V 15 - V 0...5V 17 - I ±20mA 18 - I 0-20mA 19 - I 4-20mA 20 - I 4-20mA NAMUR 33 - RTD/R 2Wire 34 - RTD/R 3Wire 35 - RTD/R 4Wire 49 - SG 1/4 2Wire 350R 50 - SG 1/4 2Wire 120R 51 - SG 1/4 3Wire 350R 52 - SG 1/4 3Wire 120R 53 - SG 1/2 3Wire 54 - SG 1/2 5Wire 55 - SG 1/1 4Wire 56 - SG 1/1 6Wire 65 - Poti 3Wire 66 - Poti 5Wire	UINT16	RW	0x0000 (0 <sub>dec</sub> )
8000:02	SG Voltage	Selection of the SG voltage: 0 - 0 V 1 - 0.5 V 2 - 1.0 V 3 - 1.5 V 4 - 2.0 V 5 - 2.5 V 6 - 3.0 V 7 - 3.5 V 8 - 4.0 V 9 - 4.5 V 10 - 5.0 V	UINT16	RW	0x0000 (0 <sub>dec</sub> )
8000:04	Wire Break Detection	Broken wire detection TRUE = on FALSE = off (see section "Broken wire detection/ optional connection diagnosis")	BOOLEAN	RW	0x00 (FALSE)
8000:13	Wire Resistance Compensation 640 μΩ/ Step	Compensation of the wire resistance with resolution 640 μΩ/ step (only in 2-wire mode, "R/RTD 2-wire" possible)	UINT16	RW	0x0000 (0 <sub>dec</sub> )
8000:14	RTD Element	Selection of the RTD element: 0 - None 1 - PT100 (-200...850°C) 2 - NI100 (-60...250°C) 3 - PT1000 (-200...850°C) 4 - PT500 (-200...850°C) 5 - PT200 (-200...850°C) 6 - NI1000 (-60...250°C) 7 - NI1000 TK5000 or rather 100°C: 1500Ohm (-30...160°C) 8 - NI120 (-60...320°C) 9 - KT100/110/130/210/230 KTY10/11/13/16/19 (-50...150°C) 10 - KTY81/82-110,120,150 (-50...150°C) 11 - KTY81-121 (-50...150°C)	UINT16	RW	0x0000 (0 <sub>dec</sub> )

Index (hex)	Name	Meaning	Data type	Flags	Default
		12 - KTY81-122 (-50...150°C) 13 - KTY81-151 (-50...150°C) 14 - KTY81-152 (-50...150°C) 15 - KTY81/82-210,220,250 (-50...150°C) 16 - KTY81-221 (-50...150°C) 17 - KTY81-222 (-50...150°C) 18 - KTY81-251 (-50...150°C) 19 - KTY81-252 (-50...150°C) 20 - KTY83-110,120,150 (-50...175°C) 21 - KTY83-121 (-50...175°C) 22 - KTY83-122 (-50...175°C) 23 - KTY83-151 (-50...175°C) 24 - KTY83-152 (-50...175°C) 25 - KTY84-130,150 (-40...300°C) 26 - KTY84-151 (-40...300°C) 27 - KTY21/23-6 (-50...150°C) 28 - KTY1x-5 (-50...150°C) 29 - KTY1x-7 (-50...150°C) 30 - KTY21/23-5 (-50...150°C) 31 - KTY21/23-7 (-50...150°C)			
8000:16	Filter 1	Options for filter 1: 0 - None 1 - FIR Notch 50 Hz 2 - FIR Notch 60 Hz 3 - FIR LP 100 Hz 4 - FIR LP 1000 Hz 5 - FIR HP 150 Hz 6 - FIR HP 1500 Hz 16 - IIR Notch 50 Hz 17 - IIR Notch 60 Hz 18 - IIR Butterw. LP 5th Ord. 1 Hz 19 - IIR Butterw. LP 5th Ord. 25 Hz 20 - IIR Butterw. LP 5th Ord. 100 Hz 21 - IIR Butterw. LP 5th Ord. 250 Hz 22 - IIR Butterw. LP 5th Ord. 1000 Hz 32 - User defined FIR Filter 33 - User defined IIR Filter 34 - User defined Average Filter	UINT16	RW	0x0000 (0 <sub>dec</sub> )
8000:17	Average Filter 1 No of Samples	Number of samples for user-defined Average Filter 1	UINT16	RW	0x0001 (1 <sub>dec</sub> )
8000:18	Decimation Factor	Factor for individual sampling rate (min. 1)	UINT16	RW	0x0001 (1 <sub>dec</sub> )
8000:19	Filter 2	Options for filter 2: 0 - None 1 - IIR 1 2 - IIR 2 3 - IIR 3 4 - IIR 4 5 - IIR 5 6 - IIR 6 7 - IIR 7 8 - IIR 8 16 - User defined FIR Filter 17 - User defined IIR Filter 18 - User defined Average Filter	UINT16	RW	0x0000 (0 <sub>dec</sub> )
8000:1A	Average Filter 2 No of Samples	Number of samples for user-defined Average Filter 2	UINT16	RW	0x0001 (1 <sub>dec</sub> )
8000:1B	True RMS No. of Samples	Number of samples for "True RMS" calculation (min. 1, max. 1000); also see chapter TrueRMS	UINT16	RW	0x00C2 (200 <sub>dec</sub> )
8000:1C	Enable True RMS	Activation of "True RMS" calculation	BOOLEAN	RW	0x00 (FALSE)
8000:2B	Extended Functions	Options for future functions /settings	UINT16	RW	0x0000 (0 <sub>dec</sub> )
8000:2C	Integrator/Differentiator	Options: 0 - Off 1 - Integrator 1x 2 - Integrator 2x <sup>1)</sup> 3 - Differentiator 1x 4 - Differentiator 2x <sup>1)</sup>	UINT16	RW	0x0000 (0 <sub>dec</sub> )
8000:2D	Differentiator Samples Delta	Distance of samples for the differentiation	UINT16	RW	0x0001 (1 <sub>dec</sub> )
8000:2E	Scaler	Scaling (enum): 0 - Extended Range 1 - Linear	UINT16	RW	0x0000 (0 <sub>dec</sub> )

Index (hex)	Name	Meaning	Data type	Flags	Default
		2 - Lookup Table 3 - Legacy Range 4 - Lookup Table (additive)			
8000:30	Low Limiter	Smallest PDO output value	INT32	RW	0x80000000 (-2147483648 <sub>dec</sub> )
8000:31	High Limiter	Largest PDO output value	INT32	RW	0x7FFFFFFF (2147483647 <sub>dec</sub> )
8000:32	Low Range Error	Lowest limit at which the error bit and the error LED are set	INT32	RW	0xFF800000 (-8388608 <sub>dec</sub> )
8000:33	High Range Error	Highest limit at which the error bit and the error LED are set	INT32	RW	0x007FFFFFFF (8388607 <sub>dec</sub> )
8000:34	Timestamp Correction	Value for correcting StartNextLatchTime (timestamp of the first sample)	INT32	RW	0xFFFB6C20 (-300000 <sub>dec</sub> )
8000:40	Filter 1 Type Info	Filter 1 type information <sup>2)</sup>	STRING	RW	N/A
8000:41	Filter 2 Type Info	Filter 2 type information <sup>2)</sup>	STRING	RW	N/A

<sup>1)</sup> Functionality is only available from FW03

<sup>2)</sup> Functionality is only available from FW11, revision -0022

### 3.2.6 0x8001 PAI Filter 1 Settings Ch.1

Index (hex)	Name	Meaning	Data type	Flags	Default
8001:0	PAI Filter 1 Settings Ch.1		UINT8	RO	0x28 (40 <sub>dec</sub> )
8001:01	Filter Coefficient 1	Coefficients for filter 1	INT32	RO	0x00000000 (0 <sub>dec</sub> )
...	...	...	...	...	...
8001:28	Filter Coefficient 40	Coefficients for filter 1	INT32	RO	0x00000000 (0 <sub>dec</sub> )

### 3.2.7 0x8003 PAI Filter 2 Settings Ch.1

Index (hex)	Name	Meaning	Data type	Flags	Default
8003:0	PAI Filter 2 Settings Ch.1		UINT8	RO	0x28 (40 <sub>dec</sub> )
8003:01	Filter Coefficient 1	Coefficients for filter 2	INT32	RO	0x00000000 (0 <sub>dec</sub> )
...	...	...	...	...	...
8003:28	Filter Coefficient 40	Coefficients for filter 2	INT32	RO	0x00000000 (0 <sub>dec</sub> )

### 3.2.8 0x8005 Scaler Settings Ch.1

Index (hex)	Name	Meaning	Data type	Flags	Default
8005:0	PAI Scaler Settings Ch.1	Scaling values offset/gain or LookUp table with 50 x/y value pairs	UINT8	RO	0x64 (100 <sub>dec</sub> )
8005:01	Scaler Offset/ Scaler Value 1	Scaling offset or LookUp x-value 1	INT32	RW	0x00000000 (0 <sub>dec</sub> )
8005:02	Scaler-Gain/ Scaler Value 2	Scaling gain or LookUp y-value 1	INT32	RW	0x00000000 (0 <sub>dec</sub> )
8005:03	Scaler Value 3	LookUp x-value 2	INT32	RW	0x00000000 (0 <sub>dec</sub> )

Index (hex)	Name	Meaning	Data type	Flags	Default
8005:04	Scaler Value 4	LookUp y-value 2	INT32	RW	0x00000000 (0 <sub>dec</sub> )
..	..	..	..	..	..
8005:63	Scaler Value 99	LookUp x-value 50	INT32	RW	0x00000000 (0 <sub>dec</sub> )
8005:64	Scaler Value 100	LookUp y-value 50	INT32	RW	0x00000000 (0 <sub>dec</sub> )

### 3.2.9 0x800E PAI User Calibration Data Ch.1

Index (hex)	Name	Meaning	Data type	Flags	Default
800E:0	PAI User Calibration Data Ch.1		UINT8	RO	0x0C (12 <sub>dec</sub> )
800E:01	Calibration Date	Date of calibration	OCTET-STRING[4]	RW	-
800E:02	Signature	Signature of the calibration values	OCTET-STRING[256]	RW	-
800E:03	S0	Offset	REAL32	RW	0x00000000 (0.0 <sub>dec</sub> )
800E:04	S1	Coefficient for first-order samples (S1 * sample)	REAL32	RW	0x3F800000 (1.0 <sub>dec</sub> )
800E:05	S2	Coefficient for second-order samples (S2 * sample <sup>2</sup> )	REAL32	RW	0x00000000 (0.0 <sub>dec</sub> )
800E:06	S3	Coefficient for third-order samples (S3 * sample <sup>3</sup> )	REAL32	RW	0x00000000 (0.0 <sub>dec</sub> )
800E:07	T1	Temperature coefficient for first-order temperature value (T1 * temp)	REAL32	RW	0x00000000 (0.0 <sub>dec</sub> )
800E:08	T1S1	Combined coefficient for first-order gain and temperature values (T1S1 * temp * sample)	REAL32	RW	0x00000000 (0.0 <sub>dec</sub> )
800E:09	T2	Temperature coefficient for second-order temperature value (T2 * temp <sup>2</sup> )	REAL32	RW	0x00000000 (0.0 <sub>dec</sub> )
800E:0A	T2S1	Combined coefficient for second-order gain and temperature values (T2S1 * temp <sup>2</sup> * sample)	REAL32	RW	0x00000000 (0.0 <sub>dec</sub> )
800E:0B	T3	Temperature coefficient for third-order temperature value (T3 * temp <sup>3</sup> )	REAL32	RW	0x00000000 (0.0 <sub>dec</sub> )
800E:0C	T3S1	Combined coefficient for third-order gain and temperature values (T3S1 * temp <sup>3</sup> * sample)	REAL32	RW	0x00000000 (0.0 <sub>dec</sub> )

### 3.2.10 0x800F PAI Vendor Calibration Data Ch.1

Index (hex)	Name	Meaning	Data type	Flags	Default
800F:0	PAI Vendor Calibration Data Ch.1		UINT8	RO	0x0C (12 <sub>dec</sub> )
800F:01	Calibration Date	Date of calibration	OCTET-STRING[4]	RW	-

Index (hex)	Name	Meaning	Data type	Flags	Default
800F:02	Signature	Signature of the calibration values	OCTET-STRING[256]	RW	-
800F:03	S0	Offset	REAL32	RW	0x00000000 (0.0 <sub>dec</sub> )
800F:04	S1	Coefficient for first-order samples (S1 * sample)	REAL32	RW	0x3F800000 (1.0 <sub>dec</sub> )
800F:05	S2	Coefficient for second-order samples (S2 * sample <sup>2</sup> )	REAL32	RW	0x00000000 (0.0 <sub>dec</sub> )
800F:06	S3	Coefficient for third-order samples (S3 * sample <sup>3</sup> )	REAL32	RW	0x00000000 (0.0 <sub>dec</sub> )
800F:07	T1	Temperature coefficient for first-order temperature value (T1 * temp)	REAL32	RW	0x00000000 (0.0 <sub>dec</sub> )
800F:08	T1S1	Combined coefficient for first-order gain and temperature values (T1S1 * temp * sample)	REAL32	RW	0x00000000 (0.0 <sub>dec</sub> )
800F:09	T2	Temperature coefficient for second-order temperature value (T2 * temp <sup>2</sup> )	REAL32	RW	0x00000000 (0.0 <sub>dec</sub> )
800F:0A	T2S1	Combined coefficient for second-order gain and temperature values (T2S1 * temp <sup>2</sup> * sample)	REAL32	RW	0x00000000 (0.0 <sub>dec</sub> )
800F:0B	T3	Temperature coefficient for third-order temperature value (T3 * temp <sup>3</sup> )	REAL32	RW	0x00000000 (0.0 <sub>dec</sub> )
800F:0C	T3S1	Combined coefficient for third-order gain and temperature values (T3S1 * temp <sup>3</sup> * sample)	REAL32	RW	0x00000000 (0.0 <sub>dec</sub> )

### 3.2.11 0x9000 PAI Internal Data Ch.1

Index (hex)	Name	Meaning	Data type	Flags	Default
9000:0	PAI Internal Data Ch.1		UINT8	RO	0x12 (18 <sub>dec</sub> ) 0x13 (19 <sub>dec</sub> ) <sup>1)</sup> 0x15 (21 <sub>dec</sub> ) <sup>2)</sup>
9000:01	Temperature Value	Temperature value of the channel	INT16	RO	0x0000 (0 <sub>dec</sub> )
9000:02	ADC Raw Value	ADC Raw Value	INT32	RO	0x00000000 (0 <sub>dec</sub> )
9000:03	Calibration Value	Value after calibration	INT32	RO	0x00000000 (0 <sub>dec</sub> )
9000:04	Resistor Value	Value after resistance calculation	INT32	RO	0x00000000 (0 <sub>dec</sub> )
9000:05	RTD Element Value	Value after RTD element calculation	INT32	RO	0x00000000 (0 <sub>dec</sub> )
9000:06	Actual Negative Peak Hold	Current absolute minimum value	INT32	RO	0x00000000 (0 <sub>dec</sub> )
9000:07	Actual Positive Peak Hold	Current absolute maximum value	INT32	RO	0x00000000 (0 <sub>dec</sub> )
9000:08	Previous Negative Peak Hold	Absolute minimum value up to last rising edge of "Peak Hold Reset"	INT32	RO	0x00000000 (0 <sub>dec</sub> )

Index (hex)	Name	Meaning	Data type	Flags	Default
9000:09	Previous Positive Peak Hold	Absolute maximum value up to last rising edge of "Peak Hold Reset"	INT32	RO	0x00000000 (0 <sub>dec</sub> )
9000:0A	Filter 1 Value	Value after filter 1	INT32	RO	0x00000000 (0 <sub>dec</sub> )
9000:0B	Filter 2 Value	Value after filter 2	INT32	RO	0x00000000 (0 <sub>dec</sub> )
9000:0C	True RMS Value	Value after "True RMS" calculation	INT32	RO	0x00000000 (0 <sub>dec</sub> )
9000:0D	Extended Functions Value	Value after advanced (optional) function	INT32	RO	0x00000000 (0 <sub>dec</sub> )
9000:0E	Integrator/ Differentiator Value	Value after integration or differentiation	INT32	RO	0x00000000 (0 <sub>dec</sub> )
9000:0F	Scaler Value	Value after scaling	INT32	RO	0x00000000 (0 <sub>dec</sub> )
9000:10	Limiter Value	Value after limitation	INT32	RO	0x00000000 (0 <sub>dec</sub> )
9000:11	Overload Time	<p>Absolute time during overload</p> <p>"Overload" means that the channel is electrically overloaded. This is a non-recommendable condition that may eventually lead to atypical aging or even damage. This condition should be avoided</p> <p>Its accumulated duration is displayed here informatively.</p>	UINT32	RO	0x00000000 (0 <sub>dec</sub> )
9000:12	Saturation Time	<p>Absolute time during saturation</p> <p>"Saturation" means that the measuring range of the ADC of the channel is fully utilized, the ADC thus outputs its maximum value and the measured value can no longer be used. "Saturation" is therefore a pre-deregistration, with further signal increase it comes to "overload".</p> <p>The saturation state is not fundamentally harmful, but it indicates an insufficient dimensioning of the measurement channel.</p> <p>Its accumulated response time is displayed here informatively.</p>	UINT32	RO	0x00000000 (0 <sub>dec</sub> )
9000:13	Effective Sample Rate	Effective sampling frequency <sup>1)</sup>	UINT32	RO	Online calculated
9000:14	Vendor Calibration Counter	Writing counter for vendor calibration data <sup>2)</sup>	UINT16	RO	0x0000 (0 <sub>dec</sub> )
9000:15	User Calibration Counter	Writing counter for user calibration data <sup>2)</sup>	UINT16	RO	0x0000 (0 <sub>dec</sub> )

<sup>1)</sup> available from revision -0019

<sup>2)</sup> available from revision -0020



### 3.2.12 0x900F PAI Calibration Dates Ch.1

Index (hex)	Name	Meaning	Data type	Flags	Default
900F:0	PAI Calibration Dates		UINT8	RO	0xC2 (194 <sub>dec</sub> )
900F:01	Vendor ±30V		OCTET-STRING[4]	RO	{0}
900F:02	Vendor ±10V		OCTET-STRING[4]	RO	{0}
900F:03	Vendor ±5V		OCTET-STRING[4]	RO	{0}
900F:04	Vendor ±2.5V		OCTET-STRING[4]	RO	{0}
900F:05	Vendor ±1.25V		OCTET-STRING[4]	RO	{0}
900F:06	Vendor ±640mV		OCTET-STRING[4]	RO	{0}
900F:07	Vendor ±320mV		OCTET-STRING[4]	RO	{0}
900F:08	Vendor ±160mV		OCTET-STRING[4]	RO	{0}
900F:09	Vendor ±80mV		OCTET-STRING[4]	RO	{0}
900F:0A	Vendor ±40mV		OCTET-STRING[4]	RO	{0}
900F:0B	Vendor ±20mV		OCTET-STRING[4]	RO	{0}
900F:0C	Vendor ±10mV		OCTET-STRING[4]	RO	{0}
900F:0D	Vendor ±5mV		OCTET-STRING[4]	RO	{0}
900F:11	Vendor ±20mA		OCTET-STRING[4]	RO	{0}
900F:21	Vendor RTD/R 2Wire		OCTET-STRING[4]	RO	{0}
900F:22	Vendor RTD/R 3Wire		OCTET-STRING[4]	RO	{0}
900F:23	Vendor RTD/R 4Wire		OCTET-STRING[4]	RO	{0}
900F:31	Vendor SG 1/4 2Wire 350R		OCTET-STRING[4]	RO	{0}
900F:32	Vendor SG 1/4 2Wire 120R		OCTET-STRING[4]	RO	{0}
900F:33	Vendor SG 1/4 3Wire 350R		OCTET-STRING[4]	RO	{0}
900F:34	Vendor SG 1/4 3Wire 120R		OCTET-STRING[4]	RO	{0}
900F:35	Vendor SG 1/2 3Wire		OCTET-STRING[4]	RO	{0}
900F:36	Vendor SG 1/2 5Wire		OCTET-STRING[4]	RO	{0}
900F:37	Vendor SG 1/1 4Wire		OCTET-STRING[4]	RO	{0}

Index (hex)	Name	Meaning	Data type	Flags	Default
900F:38	Vendor SG 1/1 6Wire		OCTET- STRING[4]	RO	{0}
900F:41	Vendor Poti 3Wire		OCTET- STRING[4]	RO	{0}
900F:42	Vendor Poti 5Wire		OCTET- STRING[4]	RO	{0}
900F:81	User ±30V		OCTET- STRING[4]	RO	{0}
900F:82	User ±10V		OCTET- STRING[4]	RO	{0}
900F:83	User ±5V		OCTET- STRING[4]	RO	{0}
900F:84	User ±2.5V		OCTET- STRING[4]	RO	{0}
900F:85	User ±1.25V		OCTET- STRING[4]	RO	{0}
900F:86	User ±640mV		OCTET- STRING[4]	RO	{0}
900F:87	User ±320mV		OCTET- STRING[4]	RO	{0}
900F:88	User ±160mV		OCTET- STRING[4]	RO	{0}
900F:89	User ±80mV		OCTET- STRING[4]	RO	{0}
900F:8A	User ±40mV		OCTET- STRING[4]	RO	{0}
900F:8B	User ±20mV		OCTET- STRING[4]	RO	{0}
900F:8C	User ±10mV		OCTET- STRING[4]	RO	{0}
900F:8D	User ±5mV		OCTET- STRING[4]	RO	{0}
900F:91	User ±20mA		OCTET- STRING[4]	RO	{0}
900F:A1	User RTD/R 2Wire		OCTET- STRING[4]	RO	{0}
900F:A2	User RTD/R 3Wire		OCTET- STRING[4]	RO	{0}
900F:A3	User RTD/R 4Wire		OCTET- STRING[4]	RO	{0}
900F:B1	User SG 1/4 2Wire 350R		OCTET- STRING[4]	RO	{0}
900F:B2	User SG 1/4 2Wire 120R		OCTET- STRING[4]	RO	{0}
900F:B3	User SG 1/4 3Wire 350R		OCTET- STRING[4]	RO	{0}
900F:B4	User SG 1/4 3Wire 120R		OCTET- STRING[4]	RO	{0}
900F:B5	User SG 1/2 3Wire		OCTET- STRING[4]	RO	{0}
900F:B6	User SG 1/2 5Wire		OCTET- STRING[4]	RO	{0}

Index (hex)	Name	Meaning	Data type	Flags	Default
900F:B7	User SG 1/1 4Wire		OCTET-STRING[4]	RO	{0}
900F:B8	User SG 1/1 6Wire		OCTET-STRING[4]	RO	{0}
900F:C1	User Poti 3Wire		OCTET-STRING[4]	RO	{0}
900F:C2	User Poti 5Wire		OCTET-STRING[4]	RO	{0}

### 3.2.13 0xF000 Modular device profile

Index (hex)	Name	Meaning	Data type	Flags	Default
F000:0	Modular device profile	General information for the modular device profile	UINT8	RO	0x02 (2 <sub>dec</sub> )
F000:01	Module index distance	Index distance of the objects of the individual channels	UINT16	RO	0x0010 (16 <sub>dec</sub> )
F000:02	Maximum number of modules	Number of channels	UINT16	RO	0x0001 (1 <sub>dec</sub> )

### 3.2.14 0xF008 Code word

Index (hex)	Name	Meaning	Data type	Flags	Default
F008:0	Code word		UINT32	RW	0x00000000 (0 <sub>dec</sub> )

### 3.2.15 0xF009 Password Protection

Index (hex)	Name	Meaning	Data type	Flags	Default
F009:0	Password protection		UINT32	RW	0x00000000 (0 <sub>dec</sub> )

### 3.2.16 0xF010 Module list

Index (hex)	Name	Meaning	Data type	Flags	Default
F010:0	Module list		UINT8	RW	0x01 (1 <sub>dec</sub> )
F010:01	Subindex 001		UINT32	RW	0x0000015E (350 <sub>dec</sub> )

### 3.2.17 0xF600 PAI Timestamp

Index (hex)	Name	Meaning	Data type	Flags	Default
F600:0	PAI Timestamp		UINT8	RO	0x02 (2 <sub>dec</sub> )
F600:01	Low	Timestamp (low)	UINT32	RO	0x00000000 (0 <sub>dec</sub> )
F600:02	Hi	Timestamp (hi)	UINT32	RO	0x00000000 (0 <sub>dec</sub> )

### 3.2.18 0xF900 PAI Info Data

Index (hex)	Name	Meaning	Data type	Flags	Default
F900:0	PAI Info Data		UINT8	RO	0x22 (34 <sub>dec</sub> )
F900:01	CPU Usage	CPU load in [%] <sup>1)</sup>	UINT16	RO	0x0000 (0 <sub>dec</sub> )
F900:02	Operating Time	Operating time in [min]	UINT32	RO	0x00000000 (0 <sub>dec</sub> )
F900:03	Overtemperature Time	Time of overtemperature of the device <sup>2)</sup>	UINT32	RO	0x00000000 (0 <sub>dec</sub> )
F900:11	Device Temperature Sensor 1	Measured temperature in the terminal	INT16	RO	0x0000 (0 <sub>dec</sub> )
F900:21	Min. Temperature Sensor 1	Lowest measured temperature in the terminal	INT16	RO	0x0000 (0 <sub>dec</sub> )
F900:22	Max. Temperature Sensor 1	Highest measured temperature in the terminal	INT16	RO	0x0000 (0 <sub>dec</sub> )

<sup>1)</sup> This value depends of additional enabled features (Filters, True RMS, ...); the more functions of the terminal are in use, the greater is the value. Notice amongst others the „Input cycle counter“ (PAI Status Ch1. [► 94]). The CPU load is an informative value with particularly regard to the "Device-specific Diag messages".

<sup>2)</sup> available from revision -0021

### 3.2.19 0xF912 filter info

Index (hex)	Name	Meaning	Data type	Flags	Default
F912:0	Filter info		UINT8	RO	0x03 (3 <sub>dec</sub> )
F912:01	Info header	Basic information for the filter designer	OCTET-STRING[8]	RO	{0}
F912:02	Filter 1	Informations for the filter designer	OCTET-STRING[30]	RO	{0}
F912:03	Filter 2	Informations for the filter designer	OCTET-STRING[30]	RO	{0}

**Note:** CoE object "0xF912 Filter info" is available from FW11, revision -0022

### 3.2.20 0xFB00 PAI Command

Index (hex)	Name	Meaning	Data type	Flags	Default
FB00:0	PAI Command		UINT8	RO	0x03 (3 <sub>dec</sub> )
FB00:01	Request	Command request The respective functional chapters explain which value is to be entered here.	OCTET-STRING[2]	RW	{0}
FB00:02	Status	Command status This indicates that the command is still running or has been executed. Functional dependent, see respective sections. Otherwise: 0: Command not existing 1: executed without errors 2,3: executed not successful	UINT8	RO	0x00 (0 <sub>dec</sub> )

Index (hex)	Name	Meaning	Data type	Flags	Default
		100..200: indicates the execution progress (100 = 0% etc.)			
FB00:03	Response	Command response If the transferred command returns a response, it will be displayed here. Functional dependent, see respective sections.	OCTET-STRING[4]	RO	{0}

### 3.3 Sample programs

#### **i** Using the sample programs

This document contains sample applications of our products for certain areas of application. The application notes provided here are based on typical features of our products and only serve as examples. The notes contained in this document explicitly do not refer to specific applications. The customer is therefore responsible for assessing and deciding whether the product is suitable for a particular application. We accept no responsibility for the completeness and correctness of the source code contained in this document. We reserve the right to modify the content of this document at any time and accept no responsibility for errors and missing information.

#### Preparations for starting the sample programs (tnzip file / TwinCAT 3)

- Click on the download button to save the Zip archive locally on your hard disk, then unzip the \*.tnzip archive file in a temporary folder.

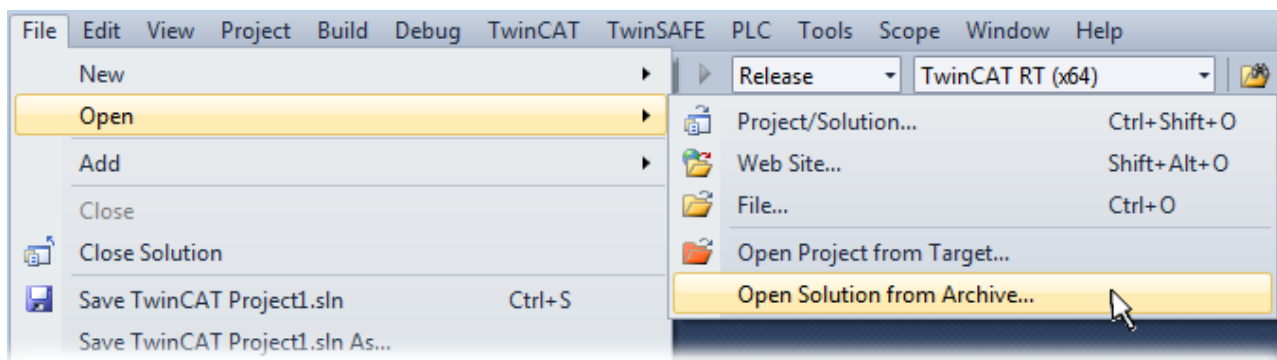

Fig. 48: Opening the \*.tnzip archive

- Select the .tnzip file (sample program).
- A further selection window opens. Select the destination directory for storing the project.
- For a description of the general PLC commissioning procedure and starting the program please refer to the terminal documentation or the EtherCAT system documentation.
- The EtherCAT device of the example should usually be declared your present system. After selection of the EtherCAT device in the “Solutionexplorer” select the “Adapter” tab and click on “Search...”:

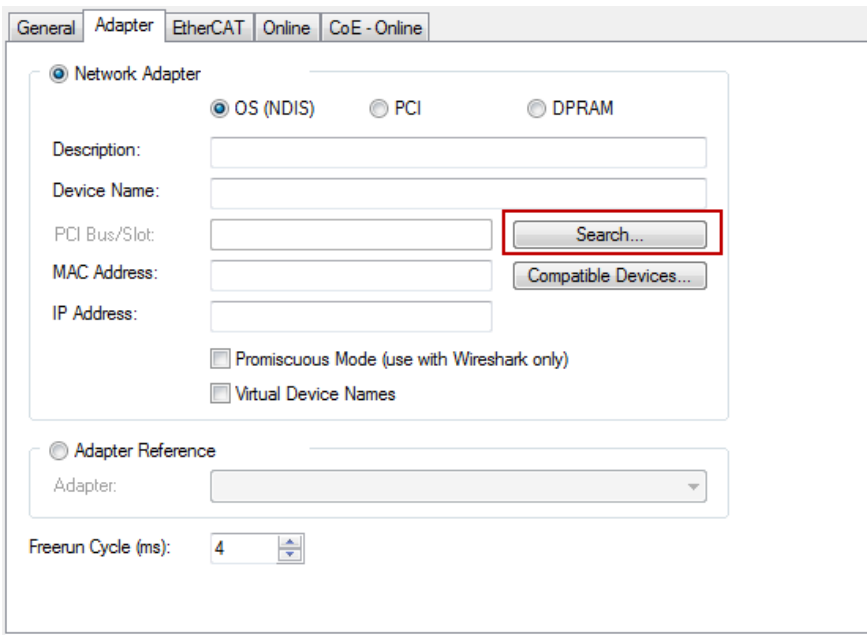
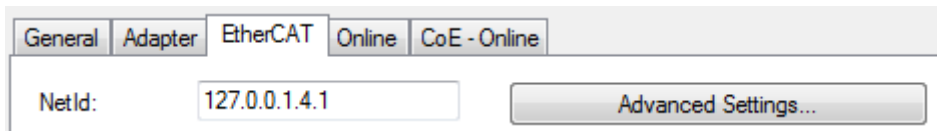

Fig. 49: Search of the existing HW configuration for the EtherCAT configuration of the example

- Checking NetId: the “EtherCAT” tab of the EtherCAT device shows the configured NetId:



The first four numbers must be identical with the project NetId of the target system. The project NetId can be viewed within the TwinCAT environment above, where a pull down menu can be opened to choose a target system (by clicking right in the text field). The number blocks are placed in brackets there next to each computer name of a target system.

- Modify the NetId: By right clicking on “EtherCAT device” within the solution explorer a context menu opens where “Change NetId...” have to be selected. The first four numbers of the NetId of the target computer must be entered; both last values are 4.1 usually.

Example:

- NetId of project: myComputer (123.45.67.89.1.1)
- Entry via „Change NetId...“: 123.45.67.89.4.1

**Preparation to start the sample program (tzip file/ TwinCAT 3)**

- After clicking the Download button, save the zip file locally on your hard disk, and unzip the \*.tzip -archive file into a temporary working folder.
- Create a new TwinCAT project as described in section: [TwinCAT Quickstart, TwinCAT 3, Startup \[► 154\]](#)
- Open the context menu of "PLC" within the "Solutionexplorer" and select "Add Existing Item..."

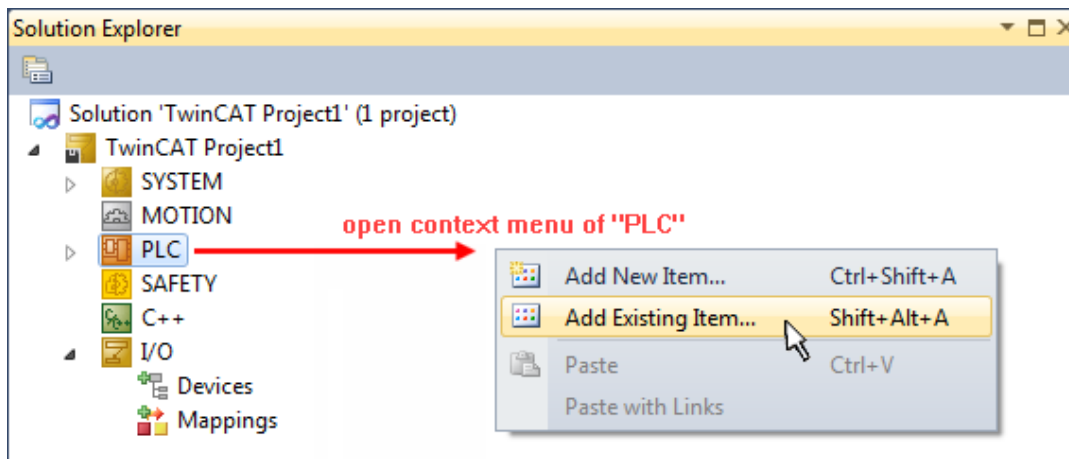

- Select the beforehand unpacked .tpzip file (sample program).

### 3.3.1 Sample program 1 and 2 (offset/gain)

Download TwinCAT 3 project:

<https://infosys.beckhoff.com/content/1033/el3751/Resources/2152667403/.zip>

#### Program description / function:

- Calculation of an *Offset* (correction) value on the basis of the amplitudes of an AC input voltage (DC component  $\neq 0$ ) until a deviation of the offset smaller than "wOFFSET\_MIN\_VAL\_REF" (in digits) is achieved.
- Calculation of a *Gain* correction value by presetting via "nPRESET\_MAX\_VAL" (in digits).

The configuration of the minimum permitted input frequency, the order of the Gain and Offset calculations, and the direct writing to the CoE directory ("PAI Scaler Settings" object) can be done in this sample program (see Variable declaration).

#### The following procedure is foreseen:

1. Configuration of "*bWriteToCoEEnable*" = TRUE, i.e. on completion of the calculation of the correction values, they are written to the CoE object "PAI Scaler Settings".
2. Set the terminal to "Extended Range" (0) via the object "PAI Settings Ch. 1" 0x8000:2E in the CoE directory.
3. Connect a periodic signal (triangle, sine, square, ...) to the terminal within the selected voltage/current range via the PAI Settings object 0x8000:01 (Interface).
4. Start the program by setting "*bEnable*" to "TRUE".
5. The end of the execution is recognizable by the variables "*bScaleGainDone*" and "*bScaleOffsetDone*", which are then both TRUE.
6. If writing is enabled in the CoE ("*bWriteToCoEEnable*" = TRUE), the values determined should have been written to the object "PAI Scaler Settings" in the CoE directory (see variable "*bError*").
7. If 6<sup>th</sup> was executed, the terminal can be set to "Linear" (1) via the object "PAI Settings Ch. 1" 0x8000:2E in the CoE directory. As a result, the terminal also performs the correction calculation internally (see: "*nScaledSampleVal*").

#### Comments:

Alternatively, the TC3 Analytics Library (TF3510) can be used instead of the function block "FB\_GET\_MIN\_MAX". The function block "FB\_ALY\_MinMaxAvg\_1Ch" can also be used for the determination of the min./max. values. The total calculation can then also be modified in this program by using the mean value provided by this function block.

In the case of the ELM350x/ ELM370x terminals, the "PAI Scaler Settings" object is 0x80n6, in addition to which the *nOffset* and *nGain* variables can also be directly written without the type conversion (REAL to DINT); scaling of the amplitude correction values with 65536 is also no longer necessary.

**Example program 1 and 2 program code:**

```

PROGRAM MAIN
VAR_INPUT
  bEnable          :BOOL; // Start the code (Offset / Gain adjust)
  nPAI_Sample AT%I* :DINT; // Input samples of the measurement value
END_VAR
VAR
  // Enter your Net-Id here:
  userNetId        :T_AmsNetId := 'a.b.c.d.x.y';
  // Enter EtherCAT device address here:
  nUserSlaveAddr   :UINT := 1002; // Check, if correct
  // Configurations:
  fMinFrequencyIn  :REAL:=1.5; // Hz
  bScalingOrder    :BOOL:=FALSE; // TRUE: Start scale offset first
  bWriteToCoEEnable :BOOL:=FALSE; // TRUE: Enable writing to CoE
  // =====
  // "Main" State controlling Offset/Gain adjusting:
  nMainCal_State   :BYTE:=0;
  // For CoE Object 0x8005 access:
  fb_coe_write     :FB_EcCoESdoWrite; // FB for writing to CoE
  nSTATE_WRITE_COE :BYTE := 0;
  nSubIndex        :BYTE;
  nCoEIndexScaler  :WORD := 16#8005; // Use channel 1
  // For ELM3xxx this is 0x8006
  nSubIndScalGain  :BYTE := 16#02;
  nSubIndScalOffs  :BYTE := 16#01;
  nADSErrId        :UDINT; // Copy of ADS-Error ID
  // =====
  fb_get_min_max   :FB_GET_MIN_MAX; // Min/Max values needed
  // Note: you may also use "FB_ALY_MinMaxAvg_1Ch" of TwinCAT analytics)
  // instead; there avg (average values can also be determined
  // Variables used for offset scaling:
  nSTATE_SCALE_OFFSET :INT := 0;
  bScaleOffsetStart   :BOOL := FALSE;
  bScaleOffsetDone    :BOOL := FALSE;
  fOffsetDeviationVal :REAL;
  nOFFSET_MIN_VAL_REF :WORD := 200; // Max. limit value for offset
  // Variables used for gain scaling:
  nSTATE_SCALE_GAIN   :INT := 0;
  bScaleGainStart     :BOOL := FALSE;
  bScaleGainDone      :BOOL := FALSE;
  nPRESET_MAX_VAL     :REAL := 3000000; // Target amplitude value
  // =====
  // Variables for evaluating of gain and offset:
  nOffset             :REAL := 0; // Offset value
  nGain               :REAL := 1; // Gain value
  nScaledSampleVal    :REAL;
  nDINT_Value         :DINT;
  fb_trig_bEnable     :R_TRIG; // Trigger FB for Enable
  bError              :BOOL := FALSE; // Evaluate..
END_VAR

```

**Execution part:**

```
// THIS CODE IS ONLY AN EXAMPLE - YOU HAVE TO CHECK APTITUDE FOR YOUR APPLICATION
```



```

// Example program 1 and 2 program code:
// =====
// 1. PAI setting of 0x80n0:2E must be "Extended Range" at first
// 2. When writing of scaling values were done, switch to "Linear"

// Calculation of the temporary value (..and use for ScopeView to check)
nScaledSampleVal := nOffset + nGain * DINT_TO_REAL(nPAI_Sample);
// Main-State Procedure:
CASE nMainCal_State OF
  0:
    fb_trig_bEnable(CLK:=(bEnable AND NOT bError));
    IF fb_trig_bEnable.Q THEN // Poll switch or button
      // Initialize temporary offset and gain values:
      nOffset:= 0;
      nGain := 1;
      bScaleOffsetStart := bScalingOrder;
      bScaleGainStart := NOT bScalingOrder;

      fb_get_min_max.nMinFreqInput := fMinFrequencyIn;

      nMainCal_State := 10; // Start
    END_IF
  10:
    IF (bScaleGainDone AND NOT bScalingOrder)
      OR (bScaleOffsetDone AND bScalingOrder) THEN
      bScaleOffsetStart := NOT bScalingOrder;
      bScaleGainStart := bScalingOrder;
      nMainCal_State := nMainCal_State + 10;
    END_IF
  20:
    IF bScaleGainDone AND bScaleOffsetDone THEN
      nMainCal_State :=0; // All done, initialization for next start
    END_IF
END_CASE

// ----- Offset scaling (program 1) -----
IF bScaleOffsetStart THEN
  CASE nSTATE_SCALE_OFFSET OF
    0:
      bScaleOffsetDone := FALSE; // Initialization of confirmation flag
      // Get min/max values within a period of the signal:
      fb_get_min_max(nInputValue:=nScaledSampleVal);
      IF fb_get_min_max.bRESULT THEN // Wait if Limit-Values are valid
        // Min/Max Values valid, continue..
        // calculate current offset deviation:
        fOffsetDeviationVal :=
          (fb_get_min_max.nMaxVal - ABS((fb_get_min_max.nMaxVal-fb_get_min_max.nMinVal)/2));

        // Offset deviation check:
        IF ABS(fOffsetDeviationVal) < nOFFSET_MIN_VAL_REF THEN
          // Deviation in acceptable range - offset scaling done,
          // now write correction value into CoE Object:
          nDINT_Value := REAL_TO_DINT(nOffset);

          // Initiate writing to CoE:

```

```

        nSubIndex := nSubIndScalOffs;
        nSTATE_WRITE_COE := 10;
        nSTATE_SCALE_OFFSET := nSTATE_SCALE_OFFSET + 10;
    ELSE
        // Calculate new offset value (new by old with deviation)
        nOffset := nOffset - fOffsetDeviationVal;
    END_IF
END_IF
10:
    IF(nSTATE_WRITE_COE = 0) THEN
        // Scaling offset done within CoE of the device
        bScaleOffsetDone := TRUE;
        bScaleOffsetStart := FALSE;
        nSTATE_SCALE_OFFSET := 0;
    END_IF
END_CASE
END_IF

// ----- Gain scaling (program 2) -----
IF bScaleGainStart THEN
    CASE nSTATE_SCALE_GAIN OF
    0:
        bScaleGainDone := FALSE; // Initialization of confirmation flag
        // Get min/max values within a period of the signal:
        fb_get_min_max(nInputValue:=DINT_TO_REAL(nPAI_Sample));
        IF fb_get_min_max.bRESULT THEN // Wait if Limit-Values are valid

            // Calculate Gain
            nGain := nPRESET_MAX_VAL/ABS((fb_get_min_max.nMaxVal-fb_get_min_max.nMinVal)/2);
            // ..shift gain value by 16 Bit left and convert to DINT:
            nDINT_Value := REAL_TO_DINT(65536 * nGain);

            //Due to 'output = gain * input + offset', the offset have to be adapted:
            nOffset := nOffset * nGain;

            // Initiate writing to CoE:
            nSubIndex := nSubIndScalGain;
            nSTATE_WRITE_COE := 10;
            nSTATE_SCALE_GAIN := nSTATE_SCALE_GAIN + 10;
        END_IF
    10:
        IF(nSTATE_WRITE_COE = 0) THEN
            IF NOT (nOffset = 0) THEN
                // (bScalingOrder is TRUE)
                nDINT_Value := REAL_TO_DINT(nOffset);
                // Initiate writing to CoE (again):
                nSubIndex := nSubIndScalOffs;
                nSTATE_WRITE_COE := 10;
            END_IF
        END_IF
        nSTATE_SCALE_GAIN := nSTATE_SCALE_GAIN + 10;
    END_IF
    20:
        IF(nSTATE_WRITE_COE = 0) THEN
            // Scaling gain done within CoE of the device

```

```

        bScaleGainStart := FALSE;
        bScaleGainDone := TRUE;
        nSTATE_SCALE_GAIN := 0; // Set initial state
    END_IF
    END_CASE
END_IF

IF (nSTATE_WRITE_COE > 0) THEN
    IF bWriteToCoEEnable THEN
        CASE nSTATE_WRITE_COE OF
            10:
                // Prepare CoE write access
                fb_coe_write(
                    sNetId:=    userNetId,
                    nSlaveAddr:= nUserSlaveAddr,
                    nIndex:=    nCoEIndexScaler,
                    bExecute:=  FALSE,
                    tTimeout:=  T#1S
                );
                nSTATE_WRITE_COE := nSTATE_WRITE_COE + 10;
            20:
                // Write nDINT_Value to CoE Index "Scaler":
                fb_coe_write(
                    nSubIndex:= nSubIndex,
                    pSrcBuf:=  ADR(nDINT_Value),
                    cbBufLen:= SIZEOF(nDINT_Value),
                    bExecute:= TRUE
                );
                nSTATE_WRITE_COE := nSTATE_WRITE_COE + 10;
            30:
                fb_coe_write();
                IF NOT fb_coe_write.bBusy THEN
                    nSTATE_WRITE_COE := 0;
                END_IF
            END_CASE
        ELSE
            nSTATE_WRITE_COE := 0;
        END_IF
    END_IF
END_IF

IF(fb_coe_write.bError) AND NOT bError THEN
    bError := TRUE;
    nADSErrId := fb_coe_write.nErrId;
    // CoE write access error occurred: reset all
    nSTATE_WRITE_COE := nMainCal_State := 0;
    bScaleOffsetDone := bScaleOffsetStart := FALSE;
    bScaleGainDone := bScaleGainStart := FALSE;
END_IF

```

### 3.3.1.1 Function block FB\_GET\_MIN\_MAX

#### Declaration part:

```

FUNCTION_BLOCK FB_GET_MIN_MAX
VAR CONSTANT

```

```

    CMAXinit      :REAL := -3.402823E+38;
    CMINinit      :REAL :=  3.402823E+38;
END_VAR
VAR_INPUT
    bInit         :BOOL := TRUE;
    nInputValue   :REAL;
    nMinFreqInput :REAL;
END_VAR
VAR_OUTPUT
    bRESULT       :BOOL;
    nMaxVal       :REAL;
    nMinVal       :REAL;
END_VAR
VAR
    CMMcnt        :UINT;
    nMaxValCnt    :UINT;
    nMinValCnt    :UINT;
    bValidMinVal  :BOOL;
    bValidMaxVal  :BOOL;
    fbGetCurTaskIdx : GETCURTASKINDEX;
END_VAR

```

**Execution part:**

```

IF bInit THEN
    // Counter initialization:
    // [counter value] > [1/(<input frequency> * TaskCycleTime)]
    fbGetCurTaskIdx();
    CMMcnt := REAL_TO_UINT(
        1.1E7/(nMinFreqInput*UDINT_TO_REAL(
            _TaskInfo[fbGetCurTaskIdx.index].CycleTime)));
    // At least an entire period have to be sampled for min/max determination
    // Initialization, go on:
    nMaxValCnt :=CMMcnt;
    nMinValCnt :=CMMcnt;
    nMaxVal :=CMAXinit;
    nMinVal :=CMINinit;
    bInit := FALSE;
END_IF
// Assertions: new min/max values exists:
bValidMaxVal := TRUE;
bValidMinVal := TRUE;
// Filter min/max values
IF (nMaxVal < nInputValue) THEN
    bValidMaxVal := FALSE;
    nMaxVal := nInputValue; // Max value was found
END_IF
IF (nMinVal > nInputValue) THEN
    bValidMinVal := FALSE;
    nMinVal := nInputValue; // Min value was found
END_IF
// Count down, if no new value come in:
IF (bValidMaxVal AND (nMaxValCnt > 0)) THEN
    nMaxValCnt := nMaxValCnt - 1;
END_IF
// Count down, if no new value come in:

```

```

IF (bValidMinVal AND (nMinValCnt > 0)) THEN
  nMinValCnt := nMinValCnt - 1;
END_IF
IF ((nMaxValCnt = 0) AND (nMinValCnt = 0)) THEN
  // Consequence: min/max determined
  bInit := TRUE; // Prepare next call
  bRESULT := NOT (nMaxVal = nMinVal); // Sign valid results
ELSE
  bRESULT := FALSE; // Sign still invalid results
END_IF

```

### 3.3.2 Sample program 3 (write LookUp table)

Download TwinCAT 3 project: <https://infosys.beckhoff.com/content/1033/el3751/Resources/2152669707.zip>

#### Program description

Transmission of LookUp table interpolation values for mapping of an equation  $f(x) = x^3$  via CoE into the terminal.

#### Variable declaration sample program 3

```

PROGRAM MAIN
VAR
  //LookUp-Table (LUT) generated by: MBE * x³
  aLUT:ARRAY[0..99] OF DINT :=
  [
    -7812500,-7812500,-7493593,-6894382,
    -7174765,-6051169,-6855859,-5279674,-6536953,-4576709,
    -6218125,-3939087,-5899218,-3363620,-5580390,-2847120,
    -5261484,-2386402,-4942578,-1978275,-4623750,-1619555,
    -4304843,-1307052,-3985937,-1037580,-3667109,-807951,
    -3348203,-614978,-3029375,-455472,-2710468,-326248,
    -2391562,-224117,-2072734,-145892,-1753828,-88385,
    -1434921,-48409,-1116093,-22776,-797187,-8300,
    -478281,-1792,-159453,-66,159453,66,
    478281,1792,797187,8300,1116093,22776,
    1434921,48409,1753828,88385,2072734,145892,
    2391562,224117,2710468,326248,3029375,455472,
    3348203,614978,3667109,807951,3985937,1037580,
    4304843,1307052,4623750,1619555,4942578,1978275,
    5261484,2386402,5580390,2847120,5899218,3363620,
    6218125,3939087,6536953,4576709,6855859,5279674,
    7174765,6051169,7493593,6894382,7812500,7812500
  ];
  // For CoE 0x8000 and 0x8005 - write values:
  // =====
  wCoEIndexScaler :WORD := 16#8005; // CoE Index
  wState           :BYTE := 0; // Write status
  fb_coe_writeEx  :FB_EcCoESdoWriteEx; // Function Block for writing in CoE
  userNetId       :T_AmsNetId := '172.128.1.1.5.1'; // Have to be entered
  userSlaveAddr   :UINT := 1003; // Have to be entered
  bWriteLUT2CoE  :BOOL:=FALSE; // Sign for start writing
  bError          :BOOL:=FALSE; // Sign for any error
END_VAR

```

**Remarks:**

- The variable "startWrite" (BOOL) is also declared in sample program 4.
- The variable 'userNetId' must include the EtherCAT net ID of the device. It can be viewed in the "EtherCAT" tab under "Device (EtherCAT)".
- The variable "userSlaveAddr" must contain the EtherCAT address of the terminal.

**Sample program for transferring the LookUp table:****Execution part:**

```
// Example program 3:
// ##### Write LookUp table into CoE object 0x8005: #####
IF bWriteLUT2CoE THEN
CASE wState OF
  0:
    fb_coe_writeEx(bExecute := FALSE); // Prepare CoE-Access
    wState := wState + 1; // Next state
  1:
    // Write 100 X/Y LookUp-Table entries
    fb_coe_writeEx(
      sNetId:= userNetId,
      nSlaveAddr:= userSlaveAddr,
      nSubIndex:= 1,
      nIndex:= wCoEIndexScaler,
      pSrcBuf:= ADR(aLUT),
      cbBufLen:= SIZEOF(aLUT),
      bCompleteAccess:= TRUE,
      bExecute:= TRUE
    );
    wState := wState + 1; // Next state
  2:
    // Proceed with writing to CoE
    fb_coe_writeEx();
    IF NOT fb_coe_writeEx.bBusy THEN
      wState := 0; // Done
      bWriteLUT2CoE := FALSE;
      bError := fb_coe_writeEx.bError; // See nErrId if TRUE
    END_IF
END_CASE
END_IF
```

A simple variable query, e.g., via button linked with bEnable, can be used to initiate the transfer. The variable declaration must contain

```
VAR_INPUT
  bEnable AT%I* :BOOL;
END_VAR
```

and the following program lines:

```
IF bEnable AND NOT startWrite THEN
  bWriteLUT2CoE := TRUE;
END_IF
```

**3.3.3 Sample program 4 (generate LookUp table)**

Download TwinCAT 3 project: <https://infosys.beckhoff.com/content/1033/el3751/Resources/2152669707/.zip>

**Program description / function:**

Inclusion of LookUp table interpolation values from a terminal input signal to a field variable (and optional subsequent transfer of the LookUp table interpolation values via CoE access to the terminal using sample program 3).

It is envisaged to use a ramp generator with a trigger input, whose level, in conjunction with an input of a digital input terminal (e.g., EL1002) sets the variable "*bStartRecord*" to TRUE via a link (e.g., push button connected to +24 V). This allows recording of the values to be synchronized with the ramp input voltage. Alternatively, an output terminal can be used (e.g., EL2002), whose output controls the trigger input and whose output is then set to TRUE via the TwinCAT development environment ("*bStartRecord*" would then have to be declared as AT%Q\* and linked to a terminal output).

**Variable declaration sample program 4**

```
// Variable declaration for example program 4
PROGRAM MAIN
VAR CONSTANT
    nEndX                : BYTE := 50; // Number of support values
END_VAR
VAR
    nPAISampleIn        AT%I* : DINT; // PDO PAISamples
    bStartRecord        AT%I* : BOOL; // +Electrical junction to trigger ramp
    bGetMinMax          : BOOL := FALSE;
    bRecordLUT          : BOOL := FALSE;
    r_trigStartRecord   : R_TRIG;
    nX                  : BYTE := 0;
    aValues             : ARRAY[0..nEndX-1] OF DINT;
    nYstepValue         : DINT;
    tp_timer            : TP;
    ton_timer           : TON;
    nMinValue           : DINT := 7812500;
    nMaxValue           : DINT := -7812500;
    nYvalue             : DINT;
    tRepeatTimerValue   : TIME := T#51MS;
    aLUT                : ARRAY[0..99] OF DINT;
END_VAR
```

**Execution part:**

```
// Example program 4:
// ##### Recording of 50 sample points: #####
// a) Determination of min./max. values (corresponding to the value range of the sensor)
tp_timer(IN:=bGetMinMax, PT:=T#2.51S); // Periodic duration of ramp (+reserve)
IF tp_timer.Q THEN
    nMinValue := MIN(nPAISampleIn, nMinValue);
    nMaxValue := MAX(nPAISampleIn, nMaxValue);
END_IF
// b) Recording of values: Start
r_trigStartRecord(CLK:=bStartRecord);
IF r_trigStartRecord.Q THEN
    nX := 0;
    memset(ADR(aLUT), 0, 100);
    bRecordLUT := TRUE;
END_IF
ton_timer();
IF bRecordLUT OR ton_timer.Q THEN
    bRecordLUT := FALSE;
```

```

ton_timer(IN:=FALSE);
IF(nX < nEndX) THEN
  // b.1) Record of values:
  aValues[nX] := nPAISampleIn;
  nX := nX + 1;
  ton_timer(IN:=TRUE, PT:=tRepeatTimerValue); // T=2.5s/49 = 51ms
ELSE
  // b.2) Recording end:
  // Create linearized values:
  nYstepValue := (nMaxValue - nMinValue) / nEndX; // Y steps
  nYvalue := aValues[0]; // Common start value of the LUT
  FOR nX:=0 TO nEndX DO
    // Create LUT (X = actual values, Y = target values):
    aLUT[nX*2] := aValues[nX]; // X value
    aLUT[nX*2+1] := nYvalue; // Y value
    // next Y value of the LUT (make a "straight"):
    nYvalue := nYvalue + nYstepValue; // f(x) = b+x
  END_FOR
END_IF
END_IF

```

### 3.3.4 Sample program 5 (write filter coefficients)

Download TwinCAT 3 project: <https://infosys.beckhoff.com/content/1033/el3751/Resources/2152672011/.zip>

#### Program description

Transmission of exemplary filter coefficients via CoE access into the terminal.



#### General settings

- The function block "FB\_EcCoESdoWrite" requires the "Tc2\_EtherCAT" library
- <AmsNetID> must show the local device EtherCAT NetID in inverted commas (e.g. '168.57.1.1.5.1')
- <DeviceEtherCATAddress> must show the local device EtherCAT address of the EL3751/ELM3xxx terminal (e.g., 1007)

#### Variable declaration sample program 5

```

PROGRAM MAIN
// Variable declaration example program 5
VAR CONSTANT
NumOfFilterCoeff          :BYTE:=40;
END_VAR
VAR
// Function block of library "Tc2_EtherCAT" for CoE Object access:
fb_coe_write              :FB_EcCoESdoWrite;
userNetId                  :T_AmsNetId := '???';
userSlaveAddr              :UINT := ???;

// Writing PLC state for coefficients transfer (Set to 0 for start)
wState                     :BYTE:=255;
index                      :BYTE:=1; // Start index for coefficients transfer
wCoEIndexUserFilterCoeffizents :WORD:=16#8001;
aFilterCoeffs:ARRAY[0..NumOfFilterCoeff] OF LREAL :=
[
// Example filter coefficients FIR band pass: 3600..3900 Hz

```



```
// Usage: "User defined FIR Filter" (32)
0.03663651655662163,
0.04299467480848277,
-0.007880289104928245,
0.0664029021294729,
-0.0729038234874446,
-0.00005849791174519834,
0.05628409460964408,
-0.0525134329294473,
0.026329003448584205,
0.00027114381194760643,
-0.03677629552114248,
0.06743018479714939,
-0.0560894442193289,
0.0009722394088121363,
0.05676876756757213,
-0.07775650809213645,
0.05330627422911416,
0.0009941073749156226,
-0.055674804078696793,
0.07874009379691002,
-0.055674804078696793,
0.0009941073749156226,
0.05330627422911416,
-0.07775650809213645,
0.05676876756757213,
0.0009722394088121363,
-0.0560894442193289,
0.06743018479714939,
-0.03677629552114248,
0.00027114381194760643,
0.026329003448584205,
-0.0525134329294473,
0.05628409460964408,
-0.00005849791174519834,
-0.0729038234874446,
0.0664029021294729,
-0.007880289104928245,
0.04299467480848277,
0.03663651655662163,
0
];
nValue :DINT; // Temporary variable
END_VAR
```

**Execution part:**

```
// Example program 5:
// writes filter coefficients of
// "User defined FIR Filter" (32)
// incl. example coefficients for band pass
// Note: writing possible, if CoE Object
// PAI Settings Ch.1 (0x8000:16) has value 32 or 33 set, only!
// (32 = User defined FIR Filter / 33 = User defined IIR Filter)
// =====
CASE wState OF
```

```

0:
  fb_coe_write(bExecute := FALSE); // Prepare CoE access
  wState := wState + 1; // Go to next state
1:
  //nValue := REAL_TO_DINT(DINT_TO_REAL(aFilterCoeffs[index]) *16384);
  nValue := LREAL_TO_DINT(aFilterCoeffs[index] * 1073741824); // Bit-shift factor: 2^30
  // Write filter coefficients (max. 40 entries)
  fb_coe_write(
    sNetId:= userNetId,
    nSlaveAddr:= userSlaveAddr,
    nSubIndex:= index,
    nIndex:= wCoEIndexUserFilterCoeffizents,
    pSrcBuf:= ADR(nValue),
    cbBufLen:= SIZEOF(nValue),
    bExecute:= TRUE,
    tTimeout:= T#1S
  );
  wState := wState + 1; // Go to next state
2:
  // Execute writing to CoE
  fb_coe_write();
  IF fb_coe_write.bError THEN
    wState := 100; // Error case
  ELSE
    IF NOT fb_coe_write.bBusy THEN
      index := index + 1;
      IF index <= (NumOfFilterCoeff) THEN
        fb_coe_write(bExecute := FALSE); // Prepare the next CoE access
        wState := 1; // Write next value
      ELSE
        wState := 255; // Done
      END_IF
    END_IF
  END_IF
100:
  ; // Error handling
255:
  ; // Go on..
END_CASE

```

### 3.3.5 Sample program 6 (interlacing of measured values)

#### Program description / function

Note on this chapter: The use of EL3751/ELM3xxx terminals also applies accordingly to EPP35xx.

In some use cases a particularly fine temporal resolution of the signal is desired, e.g. so that many measuring points are available for an FFT. Two ways to do this are shown below:

- Use of an analog input terminal with the correspondingly high sampling rate, e.g. 20 ksps.
- Use of two analog input terminals with half the sampling rate, i.e. 10 ksps, and so-called *interlacing of measured values*; the result is likewise a 20 ksps sampling of the signal.

The second way is described in this sample: Use of two EL3751 EtherCAT Terminals, each with a maximum sampling rate of 10 kSps (and thus a conversion time of 100 µs in this case, cf. [Continuative documentation for I/O components with analog in and outputs \[▶ 262\]](#), chapter “Temporal aspects of analog/digital or

digital/analog conversion"). Due to their parallel connection, both terminals are fed the same signal simultaneously and are configured by Distributed Clocks in such a way that they sample not at the same time, but offset by half the conversion time (in this case: 50  $\mu$ s). If the two measured data streams are now combined alternately in the controller, i.e. "interlaced", the result is a net measured data stream of 20 ksp/s.

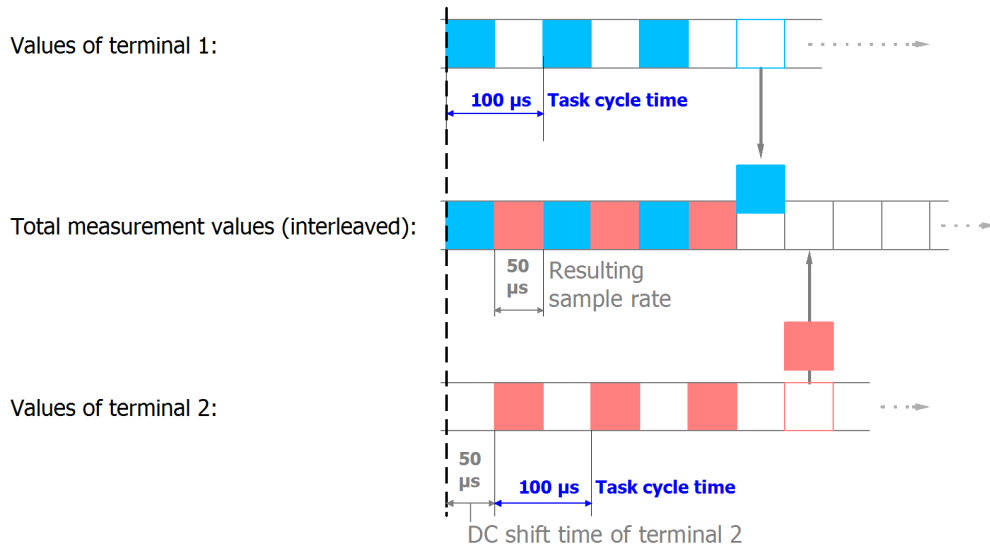

Fig. 50: Process of interlacing the input data

The following configuration is used for this purpose:

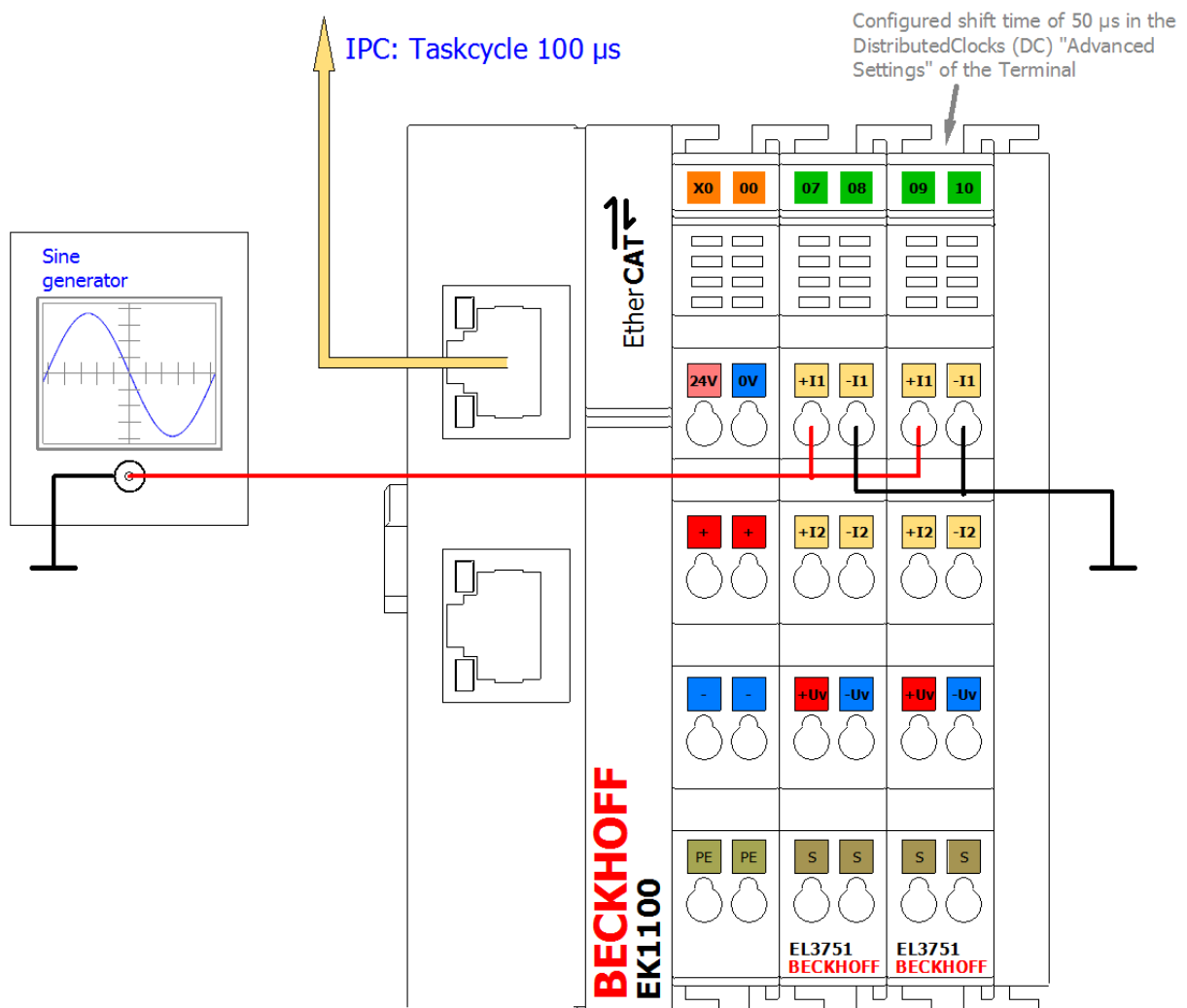

Fig. 51: Configuration and setup for sample program 6: Doubling of the sample rate with 2 x EL3751

The sample is also available with corresponding adaptations for other EL3xxx/ELM3xxx terminals or box modules. There may then be different oversampling factors, shift times, etc. The optionally existing task with 50  $\mu\text{s}$  in sample 6a may then also not be usable.

So that the input values can be successively combined to form a total value, a corresponding shift time is necessary for each channel/terminal; in this sample 50  $\mu\text{s}$  for the second terminal. This is set in the "Advanced settings" for Distributed Clocks ("DC" tab) for the second terminal:

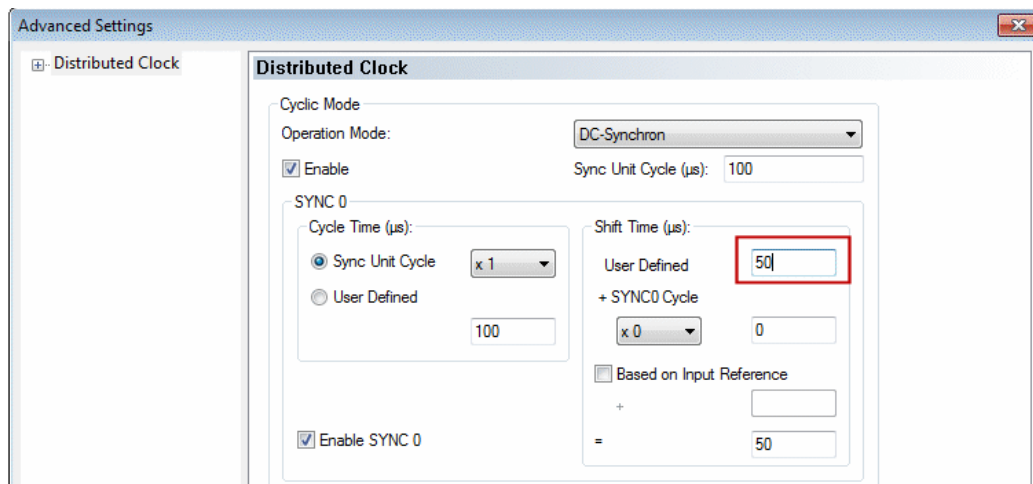

Fig. 52: Setting the DC shift time for terminal 2

### Some notes and restrictions

- This principle can be implemented with two (as described above) or more terminals; the limit is the shift time fineness of 1  $\mu\text{s}$ .
- The terminals used must support Distributed Clocks. Oversampling is helpful, but not necessary. The sampling methods simultaneous vs. multiplex must be considered; see corresponding documentation with the question: *"when the channels sample their values in relation to Distributed Clocks"*.
- Although this approach doubles the sampling rate of the signal under observation, the frequency response and attenuation specified in the technical data for the terminal still apply! It is therefore not possible to read signals that are twice as fast with twice the sampling rate. Sample: the EL3751 with a sampling rate of 10 ksps can meaningfully (alias-free) read signals up to half the sampling rate = 5 kHz. This limit remains even with multiple parallel sampling! The attenuation of -3 dB at 3 kHz given as an example also applies to the interlaced sum signal.
- Only one EtherCAT terminal can be functionally time-shifted as a whole by Distributed Clocks shift time, not the individual channel of a terminal. The shift then affects all the channels of a terminal. Therefore, for the given principle, two or more terminals/box modules must always be used; the interlacing of two channels of the same terminal/box is not possible.
- The specified measurement uncertainty must be observed: the unavoidably different real measurement uncertainty and thus the amplitude difference between the two terminals or their channels used on the same signal can become visible as a noise component after interlacing. Therefore, terminals should be used for this principle that exhibit a much smaller measurement uncertainty than is necessary for the application. It is expressly recommended to carry out an explicit user calibration of at least the offset of the two electrically interconnected channels in order to minimize this effect.
- Terminals with the same HW/FW version should be used.

### Sample program

This setting, like the base time and the task cycle time, is already configured in the sample program:

Download TwinCAT 3 project / sample program 6a: <https://infosys.beckhoff.com/content/1033/el3751/Resources/4867888523/.zip>

In the following section, the simplest form of input value interlacing in Structured Text is initially shown with oversampling = 1 for each input value: each of two elements of a field variable receives a value from a terminal. The variable can be used for further processing and is shown here in the TwinCAT ScopeView. In the EL3751 the programming instructions are assigned to a 100  $\mu\text{s}$  task:

**Variable declaration sample program 6a**

```
PROGRAM MAIN
VAR
  nSamples_1      AT%I*      :DINT; // EL3751 input with no added shift time
  nSamples_2      AT%I*      :DINT; // EL3751 input with -50 µs added shift time
  aCollectedResult :ARRAY[0..1] OF DINT;
END_VAR
```

**Execution part:**

```
// Example program 6a:
// 100 µs task
// =====
aCollectedResult[0] := nSamples_1; // Put 1st Value of sequence into array
// Pattern: 1.1.1.1...
aCollectedResult[1] := nSamples_2; // Put n-th Value of sequence into array (2nd here)
// Pattern: .2.2.2.2...
// =====
// Result pattern: 12121212... (--> see scope view dots)
```

For an input signal with sine 5 kHz and 2.5 V amplitude, for example, the TwinCAT ScopeView provides the following results:

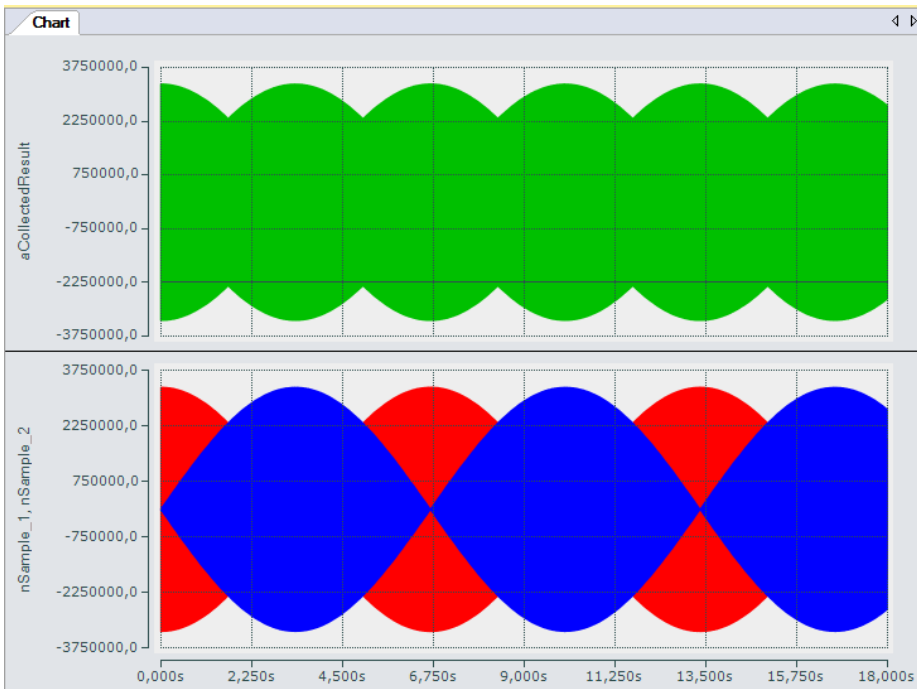

Fig. 53: Oversampling 20 ksps with 2 x EL3751 with input signals (below) and result signal (top)

The upper diagram shows the total signal and the two input signals (nSample\_1, nSample\_2), with a time shift of 50 µs relative to each other, within 18 s in compressed form. The total input signal (nCollectedResult) indicates the interlacing of the two input signals.

The following diagram (enhanced through highlighting) shows how the input signals (nSample\_1, nSample\_2) contribute to the structure of the total input signal:

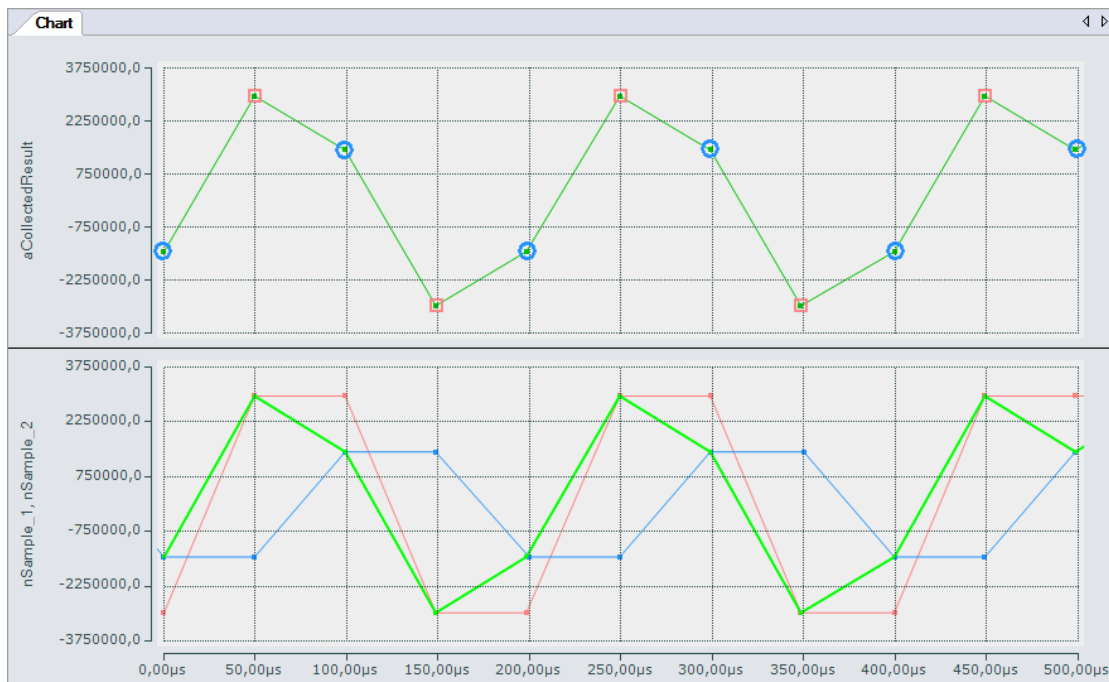

Fig. 54: Oversampling 20 ksp/s with 2 x EL3751 shows input value 1 and input value 2 alternately for a result value

Under certain conditions, both inputs can be combined into a single variable in a correspondingly fast task. For this purpose the sample program contains an additional task with 50 µs cycle time, which is required for representing the input signals in the ScopeView and contains a variable (nCollected) to which both inputs are assigned alternately:

```
// 50 µs task
// =====
// Junction of the two inputs
nCollected := SEL(nToggle, MAIN.nSamples_1_, MAIN.nSamples_2_);
nToggle := NOT nToggle;
```

The input variables required for the ScopeView are read in this task from the 100 µs task, so that the individual values can be represented at 50 µs intervals.

### Variant with 2 x oversampling 10 = oversampling 20

If, for example, an oversampling factor of 10 is used for both input terminals, a field variable is used for the total measured value. A simple loop can be used for interlacing the input values, which reads the values sequentially into a field variable for the resulting result variable:

### Variable declaration sample program 6b

```
PROGRAM MAIN
VAR
  aSamples_1      AT%I*      :ARRAY[0..9] OF DINT; // EL3751 input with no added shift time
  aSamples_2      AT%I*      :ARRAY[0..9] OF DINT; // EL3751 input with -50 µs added shift time
  aCollectedResult
// =====
  nPos            :BYTE;
```

### Execution part:

```
// Example program 6b:
// 1 ms task
// =====
FOR nPos := 0 TO 9 DO
```

```
// Put 1st Value of sequence into array:
aCollectedResult[2*nPos] := aSamples_1[nPos];
// Put n-th value of sequence into array (2nd here):
aCollectedResult[2*nPos+1] := aSamples_2[nPos];
END_FOR
```

Download TwinCAT 3 project / sample program 6b: <https://infosys.beckhoff.com/content/1033/el3751/Resources/4867891467/.zip>

Sample program 6b returns the same result, except that the total input signal is only available in the form of a field variable with 20 elements.

### 3.3.6 Sample program 7 (general decimation in the PLC)

The EL3751/ ELM3xxx can only decimate their basic sampling rate  $f_{max}$  by integer multiples, see chapter "Decimation". To realize any other sampling rates ( $f_{target} < f_{max}$ ) for a channel, you can proceed as follows, for example:

- Operate the terminal /channel at the maximum sampling rate and transfer the data to the controller (PLC) via EtherCAT/oversampling
- In the PLC/ C++, on the time axis, convert to the desired sampling rate, e.g., by linear interpolation based on the timestamp for each input value (sample). Since the EL3751/ ELM3xxx units provide time-equidistant samples based on distributed clocks, this is easily possible.

For example, a sinusoidal signal decimated with  $50/44.1 = 1/0.882$  can be represented as follows:

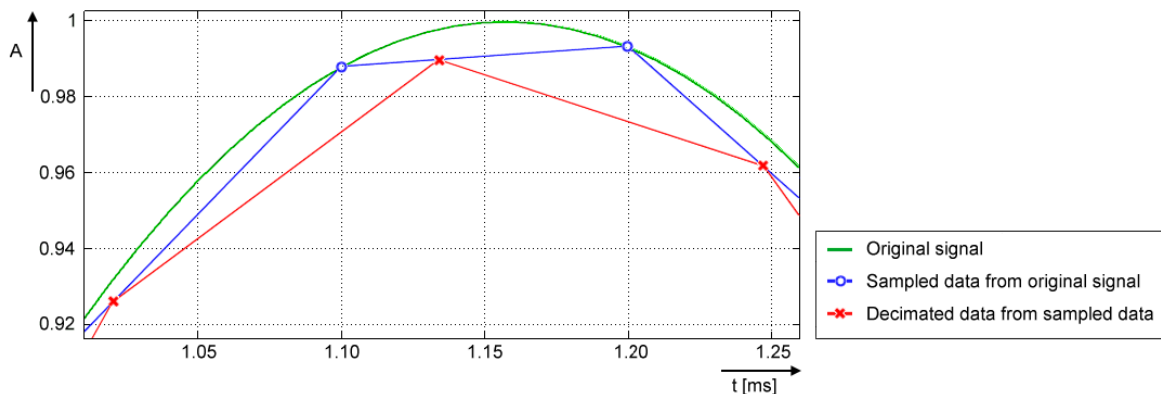

- Green: corresponds to original analog signal (input), approx. 432 Hz
- Blue (O): corresponds to sampling of the EL3751/ ELM3xxx with  $f_{max}$  of 10,000 sps; a sampling interval of 100  $\mu$ s
- Red (X): corresponds to signal converted by PLC to 8820 sps (factor 0.882) and thus a time interval of approx. 113.37..  $\mu$ s
- Note: The term "decimation" is applied both to the calculation in the terminal (see chapter "Decimation") and to the conversion in the PLC program. The following refers to the conversion in the PLC.
- Since the time interval of the desired sampling after decimation in the PLC is usually no longer an integer (finite) number, value/time pairs are used for representation in the PLC/Scope, i.e., an X time value is assigned to each Y value. Such value/time pairs can easily be displayed with TwinCAT ScopeView in XY mode. See also [infosys.beckhoff.com](https://infosys.beckhoff.com):  
TwinCAT3 → TExxxx | TC3 Engineering → TE13xx | TC3 ScopeView → Configuration → XY-Graph
- The conversion also has consequences for further processing in PLC/C/ADS:
  - A PLC/EtherCAT/TwinCAT system tends to be set up such that a constant number of samples is processed per cycle. Usually this is now no longer the case: a different number of samples has to be processed from cycle to cycle (specified by the program variable *nResultNoOfSamples*).
  - While a time stamp per signal value has so far remained relatively insignificant, the method of conversion of the decimation process used here, however, means that the respective timestamp per signal value must be taken into account in an elementary manner.

- The non-constant number of samples is not visible in the TwinCAT XY Scope because some values are sporadically drawn twice, and this should be taken into account; it may be advisable to use an intermediate buffer for further processing.
- For orientation of the currently valid number of samples per task cycle, the program provides the variable *nResultNoOfSamples*. It indicates which values in the array variable contain valid values in a task cycle (indicates the field number - 1).

The following **sample program**, which also contains the XY representation in the TwinCAT Scope, serves as a guide. Due to the above-mentioned problem relating to the non-constant number of valid samples, the program returns the array pair *aVarDecResult\_TS* and *aVarDecResult* for the Scope with the same number of elements as for the input value *aSamples\_1* (value = *nOVS*). If there are fewer values in a task run, the last value is simply entered repeatedly (similar to "sample & hold"). The ScopeView was configured as follows for the recording:

Property	Value	
ScopeNodeProperties	ViewDetailLevel	ExtendedXYOnly
	Record time	00:00:00:05
ChartXYNodeProperties	Default Display Width	0,00:00:00,050:000
	Max Data Points	200000
XYChannelNodeProperties	Marks	On
	Mark Size	5
	Mark Color	(other than line color)

For an illustrative representation, the ScopeView recording was started first and then the program, which limits the decimated values to one second:

```

IF nOVS_CycleCount = 1000000000 THEN
;
bEnable := FALSE;// Stop after 1s just for recording
ELSE
...

```

This line can, of course, be commented out for further adjustments:

```
//bEnable := FALSE;// Stop after 1s just for recording
```

**Notes:**

- the target sampling rate  $f_{target}$  should be close to the sample rate  $f_{max}$ , so that it is possible to evaluate a time interval between two decimated values. The desired decimation may require further parameters such as task cycle time, oversampling factor etc. to be adjusted both in the configuration and as variable initialization in the sample program (see figure "Process of variable decimation of the sample program", which illustrates the functionality of the program code).
- Basically, the conversion process in this sample program causes distortions in the result in relation to the original signal shape when decimating with fractional rational factors (see signal curve). In concrete terms, deviations from the original signal curve only occur in those sections where the time derivative value (the slope) is not constant. For example, input values of a sine signal in the non-linear sections are distorted by the interpolation performed in the program:

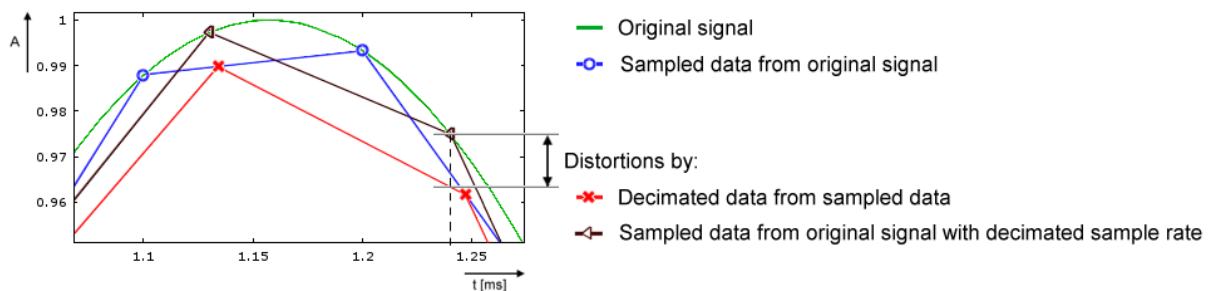



In the frequency spectrum, for example by a calculation with 20 Hz sinus signal, sampled with 500 sps and decimated to 441 sps, this is illustrated as follows:

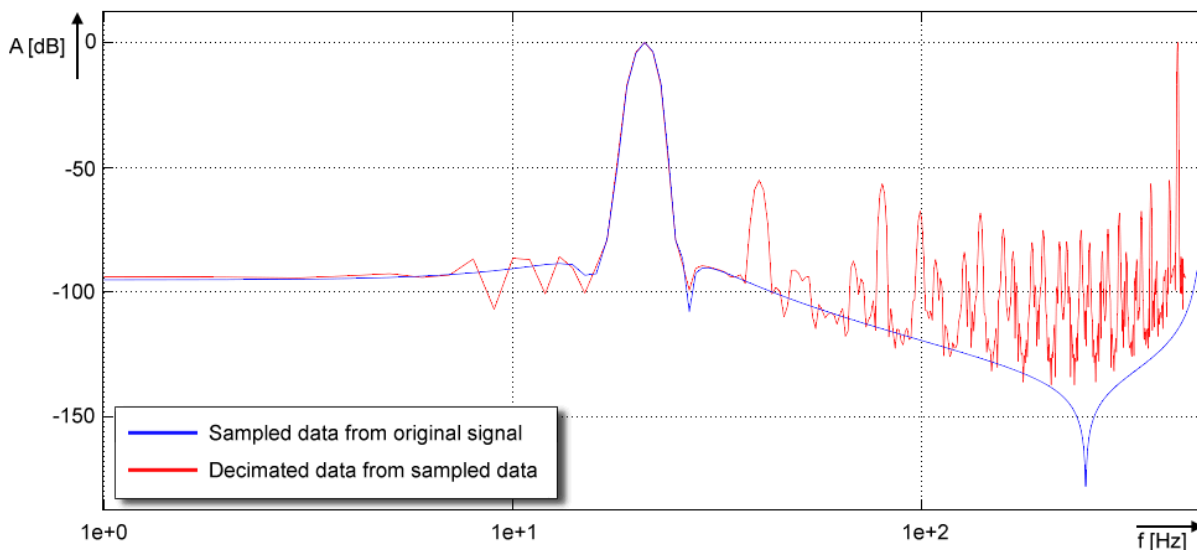

- If no low-pass filtering corresponding to  $f_{target}$  is performed on the data stream, aliasing effects will occur! It is therefore advisable to perform low-pass filtering in the PLC, e.g. with the TC3 Controller Toolbox or the TC3 Filter Library, before the conversion/decimation is performed. Suitable filters can easily be created with the TE1310 FilterDesigner. For more information, see [www.beckhoff.com](http://www.beckhoff.com): Automation → TwinCAT 3 → TE1xxx | TC3 Engineering → TE1310 | TC3 Filter Designer. Alternatively, the filters available in the EL3751/ ELM3xxx can, of course, be set to the suitable low-pass frequency; the TwinCAT Filter Designer is also helpful for this.
- Entries of decimation factors within the program ( $nDecimationValue$ ) should have a value  $> 1$ . The program code supports down sampling only.

E.g.: If a terminal such as ELM3602-0002 (2-channel IEPE evaluation) provides a data stream with oversampling of 50 ksp/s at 100  $\mu$ s cycle time, this sample code can decimate to 44.1 ksp/s. In the sample program, the cycle ticks in the task configuration should be changed from 5 to 1 and the corresponding program variable  $nTaskCycle\_ns$  from 500000 to 100000. See the following image section of ScopeView XY:

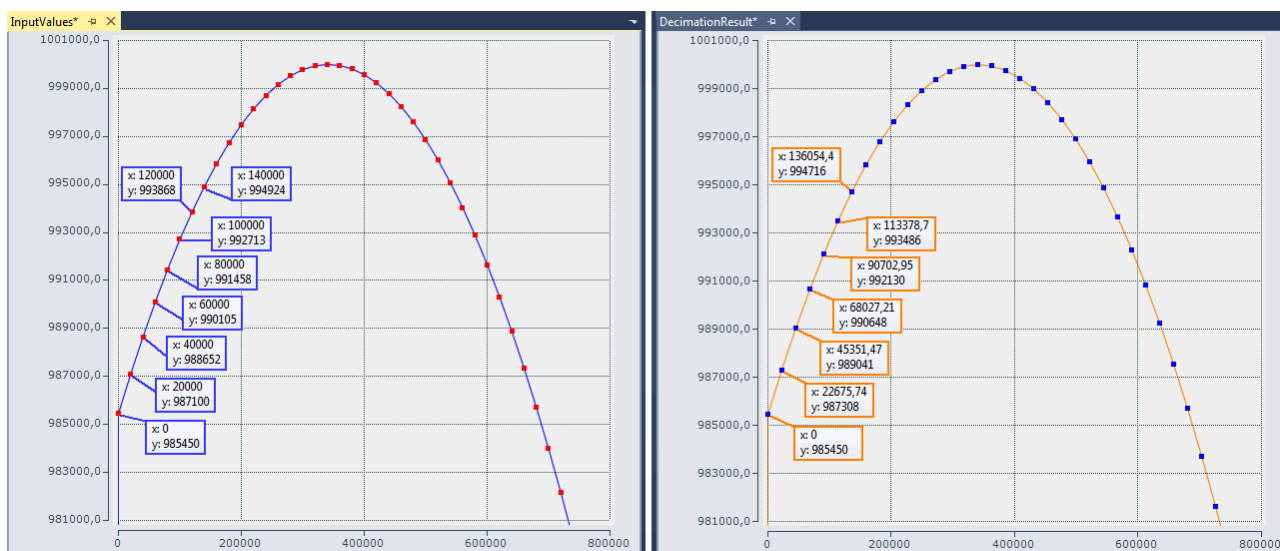

Fig. 55: Decimation from 20  $\mu$ s (left) to 22.675..  $\mu$ s (right) with ELM3602

The decimation factor is given by entering the value "50/44.1" for  $nDecimationValue$  in the sample. If this sample is used for the EL3751 with 500  $\mu$ s cycle time and 5x oversampling, the sampling interval of 100  $\mu$ s, which originates from the EL3751, is converted to approx. 113.378..  $\mu$ s. This sample is designed accordingly.

The decimation in the program is freely selectable and must be configured with an oversampling factor and a task cycle time. The variable `nOVS` must contain the same oversampling factor as set in the process data configuration.

Download sample program 7:

- Configuration: IPC + EK1100 + **EL3751** + EL9011:  
<https://infosys.beckhoff.com/content/1033/el3751/Resources/5090848011/.zip>
- Configuration: IPC + EK1100 + **ELM3602-0002** + EL9011:  
<https://infosys.beckhoff.com/content/1033/el3751/Resources/5117137291/.zip>

Note: When using an EtherCAT box like the EPP35xx, the EtherCAT coupler EK1100 is omitted.

## General information

The time at which the EtherCAT frames are passed to the terminal is subject to fluctuations, referred to as EtherCAT frame jitter. If these fluctuations are large in relation to the cycle time, it is possible that data is fetched late from the terminal, and dropouts/duplications may occur in the scope display. Such effects can be diagnosed with TwinCAT EtherCAT diagnostics. In the sample program for the ELM3602, the variable `nEqualTimeStampsCnt` is available for this kind of verification. The variable is incremented if such a failure occurs. It can be remedied by changing the DC ShiftTime of the terminal; see the EtherCAT system documentation.

## Declaration

```
// THIS CODE IS ONLY AN EXAMPLE - YOU HAVE TO CHECK APTITUDE FOR YOUR APPLICATION
PROGRAM MAIN
VAR CONSTANT
    // User decimation factor e.g. 50 to 44.1 kSps:
    nDecimationValue      :LREAL := 50/44.1; // 50/20;
    nOVS                  :BYTE := 5;      // Oversampling factor
    nTaskCycle_ns         :UDINT := 500000; // PlcTask configured cycle time in ns

    nOVSTimeInterval_ns  :UDINT := LREAL_TO_UDINT(nTaskCycle_ns/nOVS); // OVS interval
    nDecTimeInterval_ns  :LREAL := nDecimationValue * nOVSTimeInterval_ns; // Decimation interval
END_VAR
VAR
    aSamples_1 AT%I*      :ARRAY[0..nOVS-1] OF DINT; // Link to the terminal PDO
    aOVS_SampleSets       :ARRAY[0..(2*nOVS)-1] OF DINT; // 2 OVS sample sets

    nVarDecResult         :DINT; // The calculated interpolated value
    tVarDecResult         :LREAL; // Decimation timestamp

    aVarDecResult         :ARRAY[0..nOVS-1] OF DINT; // Decimation result values
    aVarDecResult_TS      :ARRAY[0..nOVS-1] OF LREAL; // Decimation result timestamps

    nResultNoOfSamples    :BYTE; // This is for the user for further processing

    nDivVar               :INT; // Value for selection of the target input element
    tDecVar_InTaskCycle   :LREAL:=0; // Time span for all decimation timestamps within a task cycle

    i                    :BYTE:=0; // Common loop counter
    nDX                   :LREAL; // X-Difference: target input element to decimation element
    nDY                   :DINT; // Y-Difference: two values for interpolation
    sVal                  :LREAL; // Slope for calculation of new value
    bEnable               :BOOL:=FALSE; // Start/Stop conversion to decimation values
    nOVS_CycleCount       :ULINT := 0; // Time value for every OVS sample

    // Values for testing
```

```

bTEST_VALUES_ENABLED :BOOL := FALSE; // No input value needed, if TRUE
nPhi                  :LREAL := 1.4; // Start angle for sinus simulation

// For visualization only:
aOVS_Samples         :ARRAY[0..nOVS-1] OF DINT; // 2 OVS sample sets (value)
aOVS_Samples_TS      :ARRAY[0..nOVS-1] OF ULINT; // 2 OVS sample sets (timestamp)
END_VAR

```

## Program

```

// 500 µs Task
FOR i:= 0 TO nOVS-1 DO
    // Shift OVS set to left and update on right:
    aOVS_SampleSets[i] := aOVS_SampleSets[i+nOVS]; // Transfer "samples set" to the left side
    IF bTEST_VALUES_ENABLED THEN
        // Simulate values:
        aOVS_SampleSets[i+nOVS] := LREAL_TO_DINT(1000000 * SIN(nPhi));
        nPhi := nPhi + 0.01;//0.003141592653;
    ELSE
        // Fill current new samples set on right:
        aOVS_SampleSets[i+nOVS] := aSamples_1[i];
    END_IF
END_FOR

IF bEnable THEN
    nResultNoOfSamples := 0; // Use for further processing

    FOR i := 0 TO nOVS-1 DO
        nDivVar := TRUNC_INT(tDecVar_InTaskCycle/nOVSTimeInterval_ns);

        // Check, if new value is in grid
        IF (nDivVar = i) THEN
            nResultNoOfSamples := nResultNoOfSamples + 1;

            // Calc slope by the left and right element values (dy/dx):
            nDY := aOVS_SampleSets[i+1] - aOVS_SampleSets[i];
            sVal := DINT_TO_LREAL(nDY)/nOVSTimeInterval_ns;

            // Get the time (difference) from the left side element start to the desired time point:
            nDX := tDecVar_InTaskCycle
                - TRUNC_INT(tDecVar_InTaskCycle/nOVSTimeInterval_ns)
                * UDINT_TO_LREAL(nOVSTimeInterval_ns);
            // Calc timestamp
            tVarDecResult := nDX + ULINT_TO_LREAL(nOVS_CycleCount);
            // Calc new value:
            nVarDecResult :=
                LREAL_TO_DINT(DINT_TO_LREAL(aOVS_SampleSets[i]) + sVal * nDX);

            // next decimation time step
            tDecVar_InTaskCycle := tDecVar_InTaskCycle + nDecTimeInterval_ns;
            tDecVar_InTaskCycle := tDecVar_InTaskCycle
                - INT_TO_UDINT(TRUNC_INT(tDecVar_InTaskCycle/nTaskCycle_ns))
                * nTaskCycle_ns;
        END_IF

        // Fill timestamp and new value allocated to the field element of its timestamp
    END_FOR

```

```

aVarDecResult_TS[i] := tVarDecResult;
aVarDecResult[i] := nVarDecResult;

// For visualization of the original input:
aOVS_Samples[i] := aOVS_SampleSets[i];
aOVS_Samples_TS[i] := nOVS_CycleCount;

// Count the task cycle timestamp
nOVS_CycleCount := nOVS_CycleCount + nOVSTimeInterval_ns;
END_FOR
END_IF

IF nOVS_CycleCount = 1000000000 THEN
  bEnable := FALSE; // Stop after 1s just for recording
  IF NOT bEnable THEN
    bEnable := TRUE; // OVS-Samples transferred complete into both array sets
  END_IF
END_IF

```

### 3.3.7 Sample program 8 (FB for real time diagnosis)

The following function block can be used as a template for a real time diagnosis application of an EtherCAT terminal analog input in TwinCAT PLC. It must be placed between the terminal and the application and evaluates the diagnostic variables coming from the terminal. The measurement values will be unchanged passed through.

The function block is written for the ELM3602-0002 with oversampling = 5 and should be understood as a functional example and must be adapted if necessary to

- other terminals or box modules if necessary other value data types
- other oversampling values

It can be extended with data-processing code or further particular diagnostics or assigned to a completely different type of a terminal (analog output EL4xxx, Encoder EL5xxx, ...).

The function block between the terminal and the PLC can be schematically illustrated as follows:

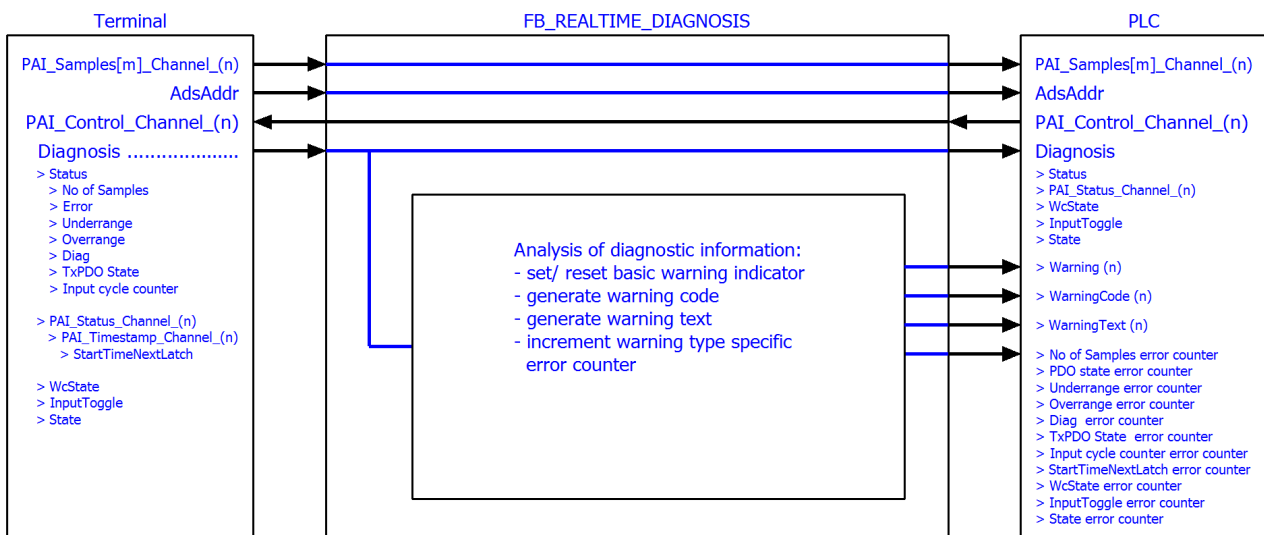
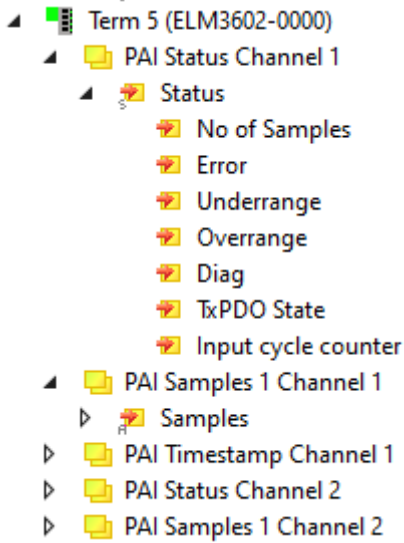

Fig. 56: Function block as an example for analysis of diagnostics information of the terminal

#### Simplified linking via structure variable

This example program takes the opportunity to describe a TwinCAT function that simplifies the linking of complex PDO structures.

This function block would have to be linked to all real time variables of the terminal: inputs and outputs; here e.g., for the ELM3602:



This time-consuming process can be simplified and accelerated by structuring in TwinCAT 3. Therefore, in this chapter two alternative variants in TwinCAT 3.1 are presented, as with a few clicks a structure can be defined in the PLC which corresponds to the **process image** of the terminal.

The respective variant of the function block FB\_REALTIME\_DIAGNOSIS is included in the two example programs. It contains variables with an application-specific data type. This is a structure created by TwinCAT 3. Because the structure generated by TwinCAT directly maps the PDO structure of the terminal, it is not necessary that a suitable structure must be elaborately created, or individual variables must be linked to individual data types. Only a link at a higher level (Status, Samples, Control, ...) is required.

This and all configurations are already included in the respective example program:

- Example program (variant A – using the “Plc” tab of the terminal):  
<https://infosys.beckhoff.com/content/1033/el3751/Resources/7161530379/.zip>
- Example program (variant B – using of “Create SM/PDO Variables” by the advanced settings of the terminal):  
<https://infosys.beckhoff.com/content/1033/el3751/Resources/7161533067/.zip>

**Variant A, “Plc” tab:**

In general, the generation of this special PDO data type is activated via the PLC settings of the terminal (tab “Plc”): there the check box “Create PLC Data Type” is set (“Copy” then transfers this character string to the clipboard):

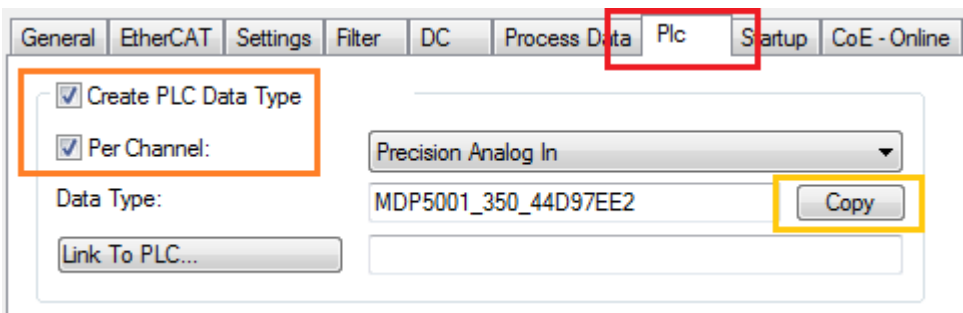

Fig. 57: Creation of PDO variables (TwinCAT version >= V3.1.4024.0)

The setting “Per Channel” can be set if not for all but for one only the structure shall be created.

The address assignments for inputs (%ATI\*) and outputs (%ATQ\*) are already within this generated structure. Inputs and outputs are therefore summarized in this structure.

The variables declaration within the function block FB\_REALTIME\_DIAGNOSIS then contains:

stELM3602Special : MDP5001\_350\_EB559ACD;

Read access is provided to the inputs of the terminal via the substructure *MDP5001\_350\_Input* and write access to the outputs via the substructure *MDP5001\_350\_Output* of the structure *stELM3602Special*.

**Variant B, "Create SM/PDO variables":**

Commonly, the generation of this specific PDO data type incl. the PDO element will be activated via the EtherCAT settings of the terminal: within the advanced settings under "General"/ "Behavior" the checkbox "Create SM/PDO Variables" in "Process Data" is to set:

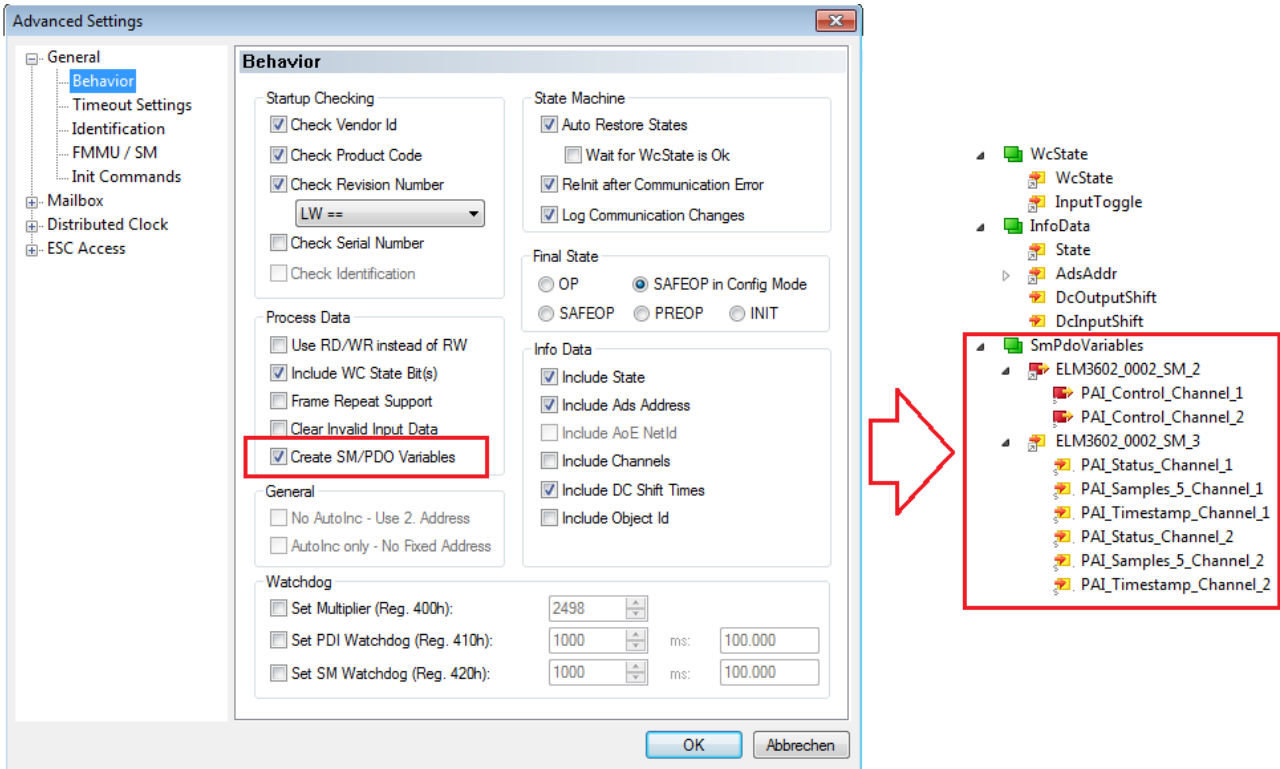

Fig. 58: Creation of the SmPdoVariables (TwinCAT version >= V3.1.4022.30)

The data type is visible by selecting the object and can be copied to the clipboard there:

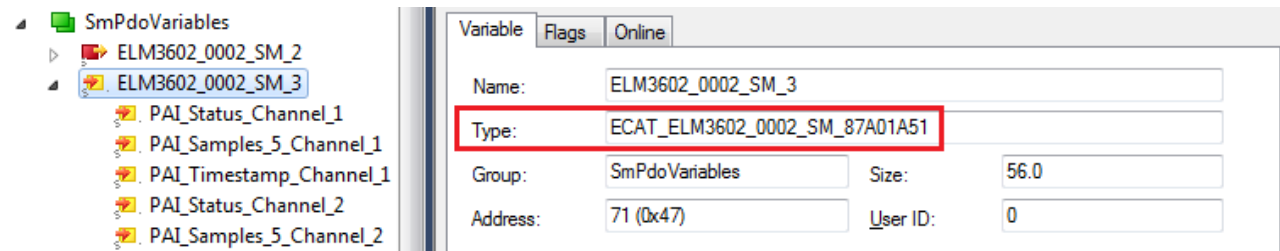

Fig. 59: Seek the generated data type of SmPdoVariables

The variables declaration within the function block FB\_REALTIME\_DIAGNOSIS then contains:

```
st_SM2      AT%Q*      : ECAT_ELM3602_0002_SM_3412CB6A;
st_SM3      AT%I*      : ECAT_ELM3602_0002_SM_87A01A51;
```

The read access to the inputs of the application is provided via the structure *st\_SM3* and write access to the outputs via the structure *st\_SM2*. These data structures corresponds to the automatically added new PDO element "SmPdoVariables".

### 3.3.8 Sample program 9 (R/W signature of calibration)

The terminal features an advanced calibration mechanism to store, among other things, an individual signature with 256 bytes, which results from the calibration data. In this way the customer could provide a calibration with a specific signature, e.g. to detect unauthorized internal manipulation of the calibration data; see also chapter "Display of data changes".

The function block described below can be used as a basis for an implementation in TwinCAT on a PLC. To simplify matters, only a CRC16 was used in this sample to serve a "signature" limited to two bytes. At a commented point in the FB implementation, another signature algorithm can be implemented, which can be up to 256 bytes long.

The sample function block is included in the TwinCAT 3 archive, which is available for download together with a visualization:

<https://infosys.beckhoff.com/content/1033/el3751/Resources/8823639307/.zip>

#### Explanatory notes for the visualization "Calibration\_Signature\_RW"

The input variables of the ADS address and the "InputToggle" must be linked again if another terminal or Box (than ELM3602) is used for the sample. This must be entered in the field after starting the sample program. Alternatively, it can be entered before the start as initialization of the input variable "sTerminalTypeIn" of the function block "FB\_VisuUpdate":

```
sTerminalTypeIn : T_MaxString := 'ELM3602';
```

#### After the program start

The function block "FB\_CalibrationSignature" is called in read mode by the visualization when channel +/- or interface +/- or "read" is actuated and in write mode when "write" is actuated. If, after reading, the calculated and the read signature match, *bCmpResult* becomes TRUE (no inequality). After a write access the entry remains in the read CoE and can be checked by reading (a write access does not change the state of *bCmpResult*).

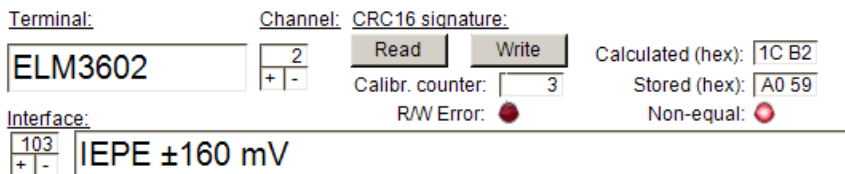

Fig. 60: Visualization of the sample implementation: Calibration signature

The variable *bError* (visualization representation: "R/W Error") provides information about a general error that has occurred when accessing the terminal as well as the failure to find stored information of the terminal (either the entry in the GVL is missing or the terminal is not present).

#### Explanatory notes for FB\_CalibrationSignature

The interface of the function block is structured as follows:

```
VAR_INPUT
  bInitialize      : BOOL := FALSE; // TRUE = Initialised
  bEnable         : BOOL := FALSE; // Activate module
  tAmsNetIdArr    : AMSADDR;      // Ads address of the terminal/ box
  nIfSlectCoE     : WORD;          // Interface number of the CoE
  nChSelectCoE    : WORD := 1;     // Channel number
  eOption         : E_CALSIG_OPTIONS; // Access get/set (read/write)
  stCoEPAIInfoDataCalCnt : ST_CoE; // Cal. counter object (EL3751/ ELM3xxx)
END_VAR

VAR_OUTPUT
  bDone           : BOOL; // Process end
  bCmpResult      : BOOL; // Signature comparision: TRUE = equal
  nInterfaceUserCalCnt : WORD; // Value of calibration counter
```

```

bError          : BOOL; // Case of error
bCancel         : BOOL; // Cancel
nErrorId        : UDINT; // Error number (all sources)
anSigDataOutCoE : ARRAY[0..(GVL_CoE.nSigLen-1)] OF BYTE; // Signature stored
anSigDataOutCalc : ARRAY[0..(GVL_CoE.nSigLen-1)] OF BYTE; // Signature calculated
END_VAR

```

For initialization the "Net Id" and "Port No." must be transferred to the variable "tAmsNetIdArr" of the FB instance. In addition, the CoE object for reading the calibration counter must be transferred via 'stCoEPAInfoDataCalCnt', since this is different for the EL3751/ ELM3xxx terminals.

A call is made with "bEnable := TRUE" for activation and with specification of the interface number (nIfSlectCoE) that applies to the terminal to be addressed, the channel (nChSelectCoE) and for reading the stored signature "eOption := E\_CALSIG\_OPTIONS.get" or for writing "eOption := E\_CALSIG\_OPTIONS.set".

Then the function block is called until the output variable "bDone" is TRUE.

The outputs anSigDataOutCalc, anSigDataOutCoE, nInterfaceUserCalCnt and bCmpResult will provide content according to the selected option and the calculated/stored data of the terminal.

To attempt to clear an error that has occurred in the case of "bError" = TRUE, the FB can be called with "bInit := FALSE" (e.g. if the channel number or the interface number has been corrected according to the addressed terminal). The "nErrorId" can be used for evaluation.

In the function block, the signature calculation can be changed/extended at the following point:

```

// Calculate signature
// ===== User code here =====
// Example: simple CRC:
nCrc := nIfSlectCoE + nChSelectCoE; // Default setting of start value
nCrc := F_DATA_TO_CRC16_CCITT(ADR(aData), nDataLen, nCrc); // Calculate "signature"
memset(ADR(anSigDataOutCalc), 16#FF, GVL_CoE.nSigLen);
memcpy(ADR(anSigDataOutCalc), ADR(nCrc), 2); // <- Dependant be the type of encryption
// =====

```



## 4 EL3751 Features

### *NOTICE*

This short documentation does not contain any further information within this chapter. For the complete documentation please contact the Beckhoff sales department responsible for you.

## 5 Commissioning on EtherCAT Master

### 5.1 General Commissioning Instructions for an EtherCAT Slave

This summary briefly deals with a number of aspects of EtherCAT Slave operation under TwinCAT. More detailed information on this may be found in the corresponding sections of, for instance, the EtherCAT System Documentation.

#### Diagnosis in real time: WorkingCounter, EtherCAT State and Status

Generally speaking an EtherCAT Slave provides a variety of diagnostic information that can be used by the controlling task.

This diagnostic information relates to differing levels of communication. It therefore has a variety of sources, and is also updated at various times.

Any application that relies on I/O data from a fieldbus being correct and up to date must make diagnostic access to the corresponding underlying layers. EtherCAT and the TwinCAT System Manager offer comprehensive diagnostic elements of this kind. Those diagnostic elements that are helpful to the controlling task for diagnosis that is accurate for the current cycle when in operation (not during commissioning) are discussed below.

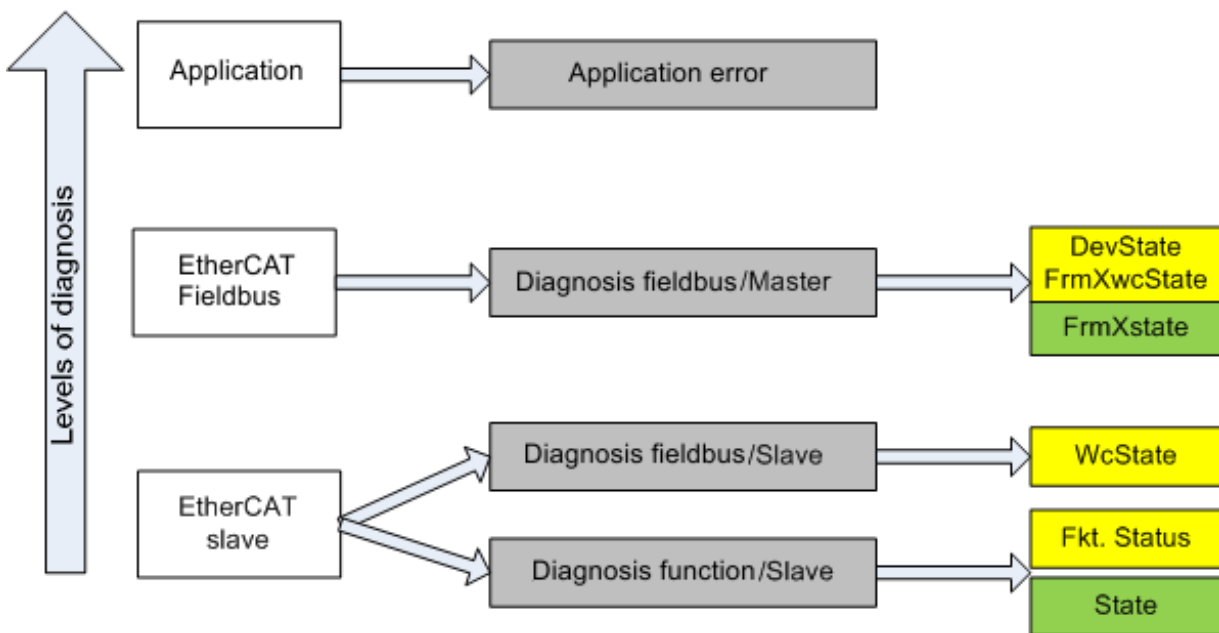

Fig. 61: Selection of the diagnostic information of an EtherCAT Slave

In general, an EtherCAT Slave offers

- communication diagnosis typical for a slave (diagnosis of successful participation in the exchange of process data, and correct operating mode)  
This diagnosis is the same for all slaves.

as well as

- function diagnosis typical for a channel (device-dependent)  
See the corresponding device documentation

The colors in Fig. *Selection of the diagnostic information of an EtherCAT Slave* also correspond to the variable colors in the System Manager, see Fig. *Basic EtherCAT Slave Diagnosis in the PLC*.

Colour	Meaning
yellow	Input variables from the Slave to the EtherCAT Master, updated in every cycle

Colour	Meaning
red	Output variables from the Slave to the EtherCAT Master, updated in every cycle
green	Information variables for the EtherCAT Master that are updated acyclically. This means that it is possible that in any particular cycle they do not represent the latest possible status. It is therefore useful to read such variables through ADS.

Fig. Basic EtherCAT Slave Diagnosis in the PLC shows an example of an implementation of basic EtherCAT Slave Diagnosis. A Beckhoff EL3102 (2-channel analogue input terminal) is used here, as it offers both the communication diagnosis typical of a slave and the functional diagnosis that is specific to a channel. Structures are created as input variables in the PLC, each corresponding to the process image.

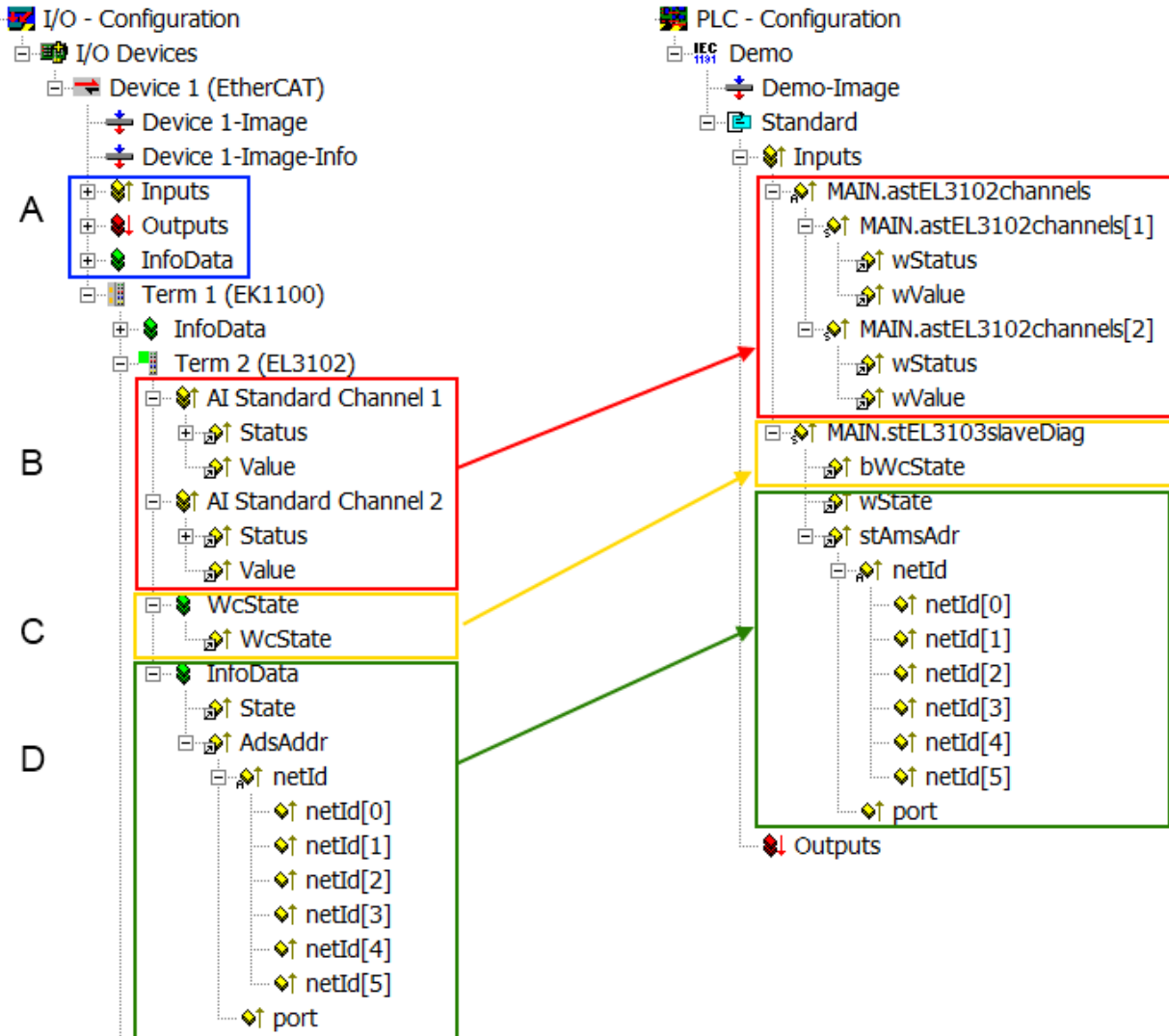

Fig. 62: Basic EtherCAT Slave Diagnosis in the PLC

The following aspects are covered here:

Code	Function	Implementation	Application/evaluation
A	The EtherCAT Master's diagnostic information updated acyclically (yellow) or provided acyclically (green).		At least the DevState is to be evaluated for the most recent cycle in the PLC.  The EtherCAT Master's diagnostic information offers many more possibilities than are treated in the EtherCAT System Documentation. A few keywords: <ul style="list-style-type: none"> <li>• CoE in the Master for communication with/through the Slaves</li> <li>• Functions from <i>TcEtherCAT.lib</i></li> <li>• Perform an OnlineScan</li> </ul>

Code	Function	Implementation	Application/evaluation
B	In the example chosen (EL3102) the EL3102 comprises two analogue input channels that transmit a single function status for the most recent cycle.	Status <ul style="list-style-type: none"> <li>the bit significations may be found in the device documentation</li> <li>other devices may supply more information, or none that is typical of a slave</li> </ul>	In order for the higher-level PLC task (or corresponding control applications) to be able to rely on correct data, the function status must be evaluated there. Such information is therefore provided with the process data for the most recent cycle.
C	For every EtherCAT Slave that has cyclic process data, the Master displays, using what is known as a WorkingCounter, whether the slave is participating successfully and without error in the cyclic exchange of process data. This important, elementary information is therefore provided for the most recent cycle in the System Manager <ol style="list-style-type: none"> <li>at the EtherCAT Slave, and, with identical contents</li> <li>as a collective variable at the EtherCAT Master (see Point A)</li> </ol> for linking.	WcState (Working Counter) <p>0: valid real-time communication in the last cycle</p> <p>1: invalid real-time communication</p> This may possibly have effects on the process data of other Slaves that are located in the same SyncUnit	In order for the higher-level PLC task (or corresponding control applications) to be able to rely on correct data, the communication status of the EtherCAT Slave must be evaluated there. Such information is therefore provided with the process data for the most recent cycle.
D	Diagnostic information of the EtherCAT Master which, while it is represented at the slave for linking, is actually determined by the Master for the Slave concerned and represented there. This information cannot be characterized as real-time, because it <ul style="list-style-type: none"> <li>is only rarely/never changed, except when the system starts up</li> <li>is itself determined acyclically (e.g. EtherCAT Status)</li> </ul>	State <p>current Status (INIT..OP) of the Slave. The Slave must be in OP (=8) when operating normally.</p> <i>AdsAddr</i> <p>The ADS address is useful for communicating from the PLC/task via ADS with the EtherCAT Slave, e.g. for reading/writing to the CoE. The AMS-NetID of a slave corresponds to the AMS-NetID of the EtherCAT Master; communication with the individual Slave is possible via the <i>port</i> (= EtherCAT address).</p>	Information variables for the EtherCAT Master that are updated acyclically. This means that it is possible that in any particular cycle they do not represent the latest possible status. It is therefore possible to read such variables through ADS.

### NOTICE

#### Diagnostic information

It is strongly recommended that the diagnostic information made available is evaluated so that the application can react accordingly.

#### CoE Parameter Directory

The CoE parameter directory (CanOpen-over-EtherCAT) is used to manage the set values for the slave concerned. Changes may, in some circumstances, have to be made here when commissioning a relatively complex EtherCAT Slave. It can be accessed through the TwinCAT System Manager, see Fig. *EL3102, CoE directory*.

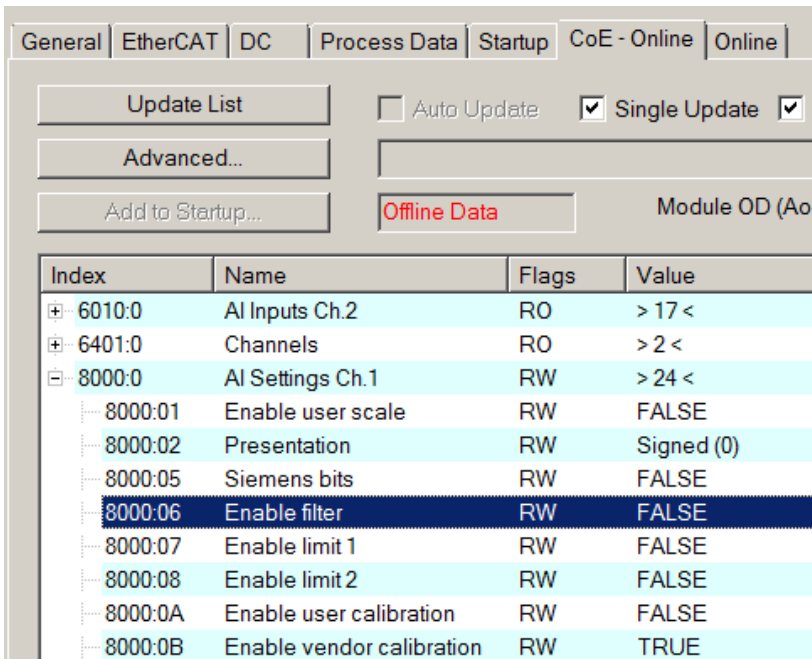

Fig. 63: EL3102, CoE directory

**● EtherCAT System Documentation**



The comprehensive description in the [EtherCAT System Documentation](#) (EtherCAT Basics --> CoE Interface) must be observed!

A few brief extracts:

- Whether changes in the online directory are saved locally in the slave depends on the device. EL terminals (except the EL66xx) are able to save in this way.
- The user must manage the changes to the StartUp list.

**Commissioning aid in the TwinCAT System Manager**

Commissioning interfaces are being introduced as part of an ongoing process for EL/EP EtherCAT devices. These are available in TwinCAT System Managers from TwinCAT 2.11R2 and above. They are integrated into the System Manager through appropriately extended ESI configuration files.

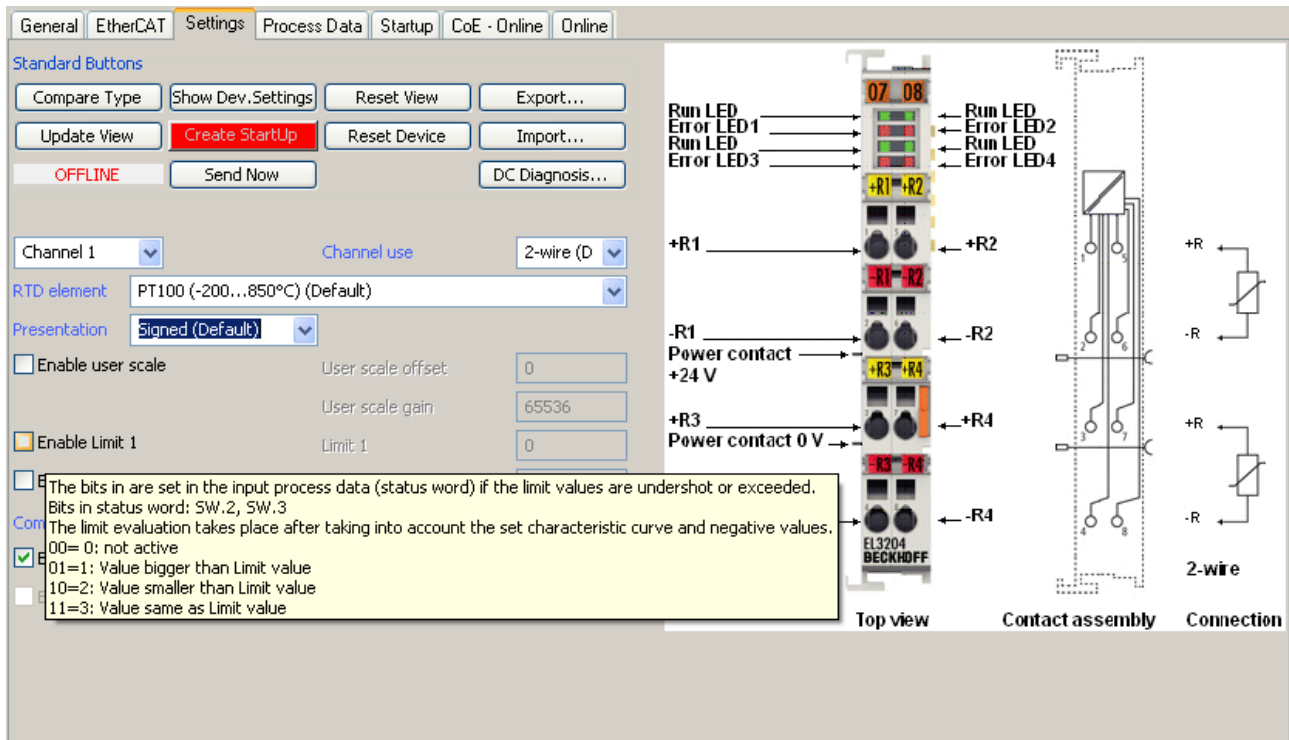

Fig. 64: Example of commissioning aid for a EL3204

This commissioning process simultaneously manages

- CoE Parameter Directory
- DC/FreeRun mode
- the available process data records (PDO)

Although the “Process Data”, “DC”, “Startup” and “CoE-Online” that used to be necessary for this are still displayed, it is recommended that, if the commissioning aid is used, the automatically generated settings are not changed by it.

The commissioning tool does not cover every possible application of an EL/EP device. If the available setting options are not adequate, the user can make the DC, PDO and CoE settings manually, as in the past.

**EtherCAT State: automatic default behaviour of the TwinCAT System Manager and manual operation**

After the operating power is switched on, an EtherCAT Slave must go through the following statuses

- INIT
- PREOP
- SAFEOP
- OP

to ensure sound operation. The EtherCAT Master directs these statuses in accordance with the initialization routines that are defined for commissioning the device by the ES/XML and user settings (Distributed Clocks (DC), PDO, CoE). See also the section on "Principles of [Communication, EtherCAT State Machine \[▶ 210\]](#)" in this connection. Depending how much configuration has to be done, and on the overall communication, booting can take up to a few seconds.

The EtherCAT Master itself must go through these routines when starting, until it has reached at least the OP target state.

The target state wanted by the user, and which is brought about automatically at start-up by TwinCAT, can be set in the System Manager. As soon as TwinCAT reaches the status RUN, the TwinCAT EtherCAT Master will approach the target states.

**Standard setting**

The advanced settings of the EtherCAT Master are set as standard:

- EtherCAT Master: OP
- Slaves: OP  
This setting applies equally to all Slaves.

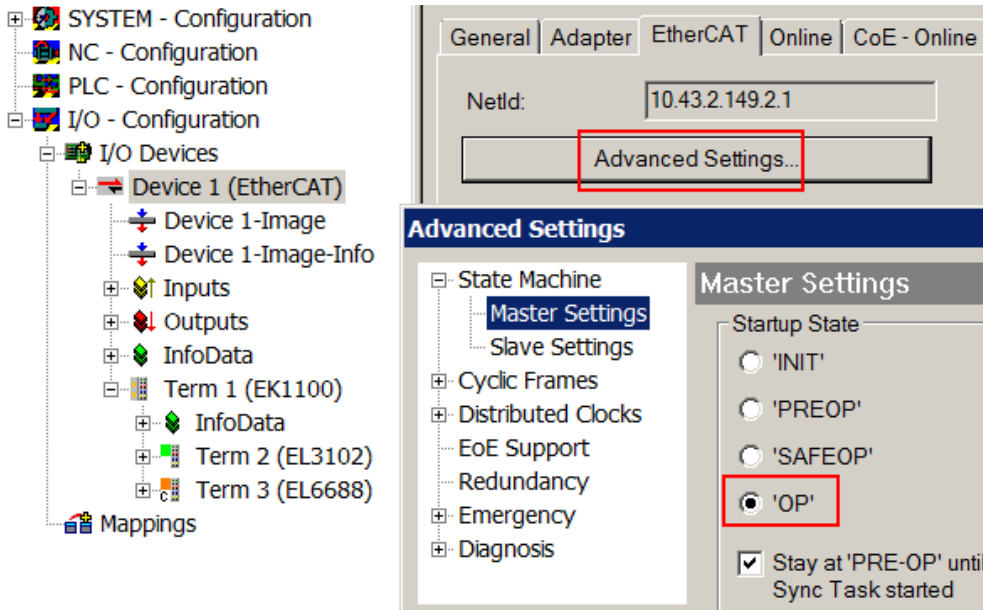

Fig. 65: Default behaviour of the System Manager

In addition, the target state of any particular Slave can be set in the “Advanced Settings” dialogue; the standard setting is again OP.

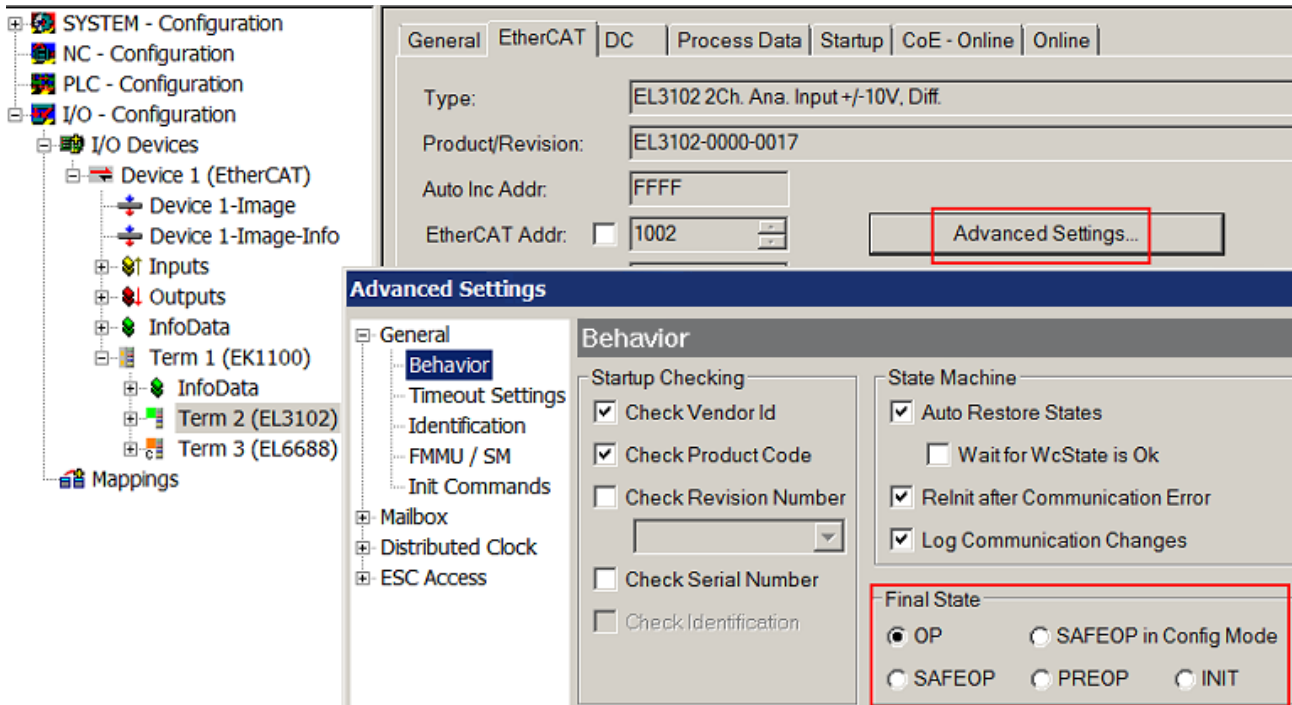

Fig. 66: Default target state in the Slave

**Manual Control**

There are particular reasons why it may be appropriate to control the states from the application/task/PLC. For instance:

- for diagnostic reasons

- to induce a controlled restart of axes
- because a change in the times involved in starting is desirable

In that case it is appropriate in the PLC application to use the PLC function blocks from the *TcEtherCAT.lib*, which is available as standard, and to work through the states in a controlled manner using, for instance, *FB\_EcSetMasterState*.

It is then useful to put the settings in the EtherCAT Master to INIT for master and slave.

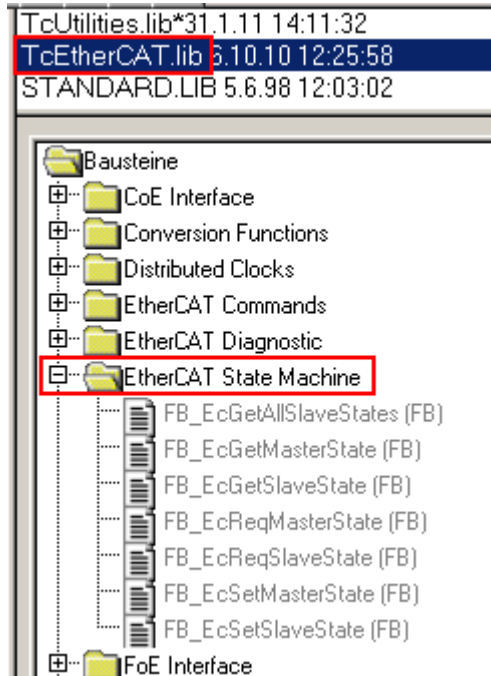

Fig. 67: PLC function blocks

### Note regarding E-Bus current

EL/ES terminals are placed on the DIN rail at a coupler on the terminal strand. A Bus Coupler can supply the EL terminals added to it with the E-bus system voltage of 5 V; a coupler is thereby loadable up to 2 A as a rule. Information on how much current each EL terminal requires from the E-bus supply is available online and in the catalogue. If the added terminals require more current than the coupler can supply, then power feed terminals (e.g. EL9410) must be inserted at appropriate places in the terminal strand.

The pre-calculated theoretical maximum E-Bus current is displayed in the TwinCAT System Manager as a column value. A shortfall is marked by a negative total amount and an exclamation mark; a power feed terminal is to be placed before such a position.



General   Adapter   EtherCAT   Online   CoE - Online						
NetId:		10.43.2.149.2.1		Advanced Settings...		
Number	Box Name	Address	Type	In Size	Out S...	E-Bus (..
1	Term 1 (EK1100)	1001	EK1100			
2	Term 2 (EL3102)	1002	EL3102	8.0		1830
3	Term 4 (EL2004)	1003	EL2004		0.4	1730
4	Term 5 (EL2004)	1004	EL2004		0.4	1630
5	Term 6 (EL7031)	1005	EL7031	8.0	8.0	1510
6	Term 7 (EL2808)	1006	EL2808		1.0	1400
7	Term 8 (EL3602)	1007	EL3602	12.0		1210
8	Term 9 (EL3602)	1008	EL3602	12.0		1020
9	Term 10 (EL3602)	1009	EL3602	12.0		830
10	Term 11 (EL3602)	1010	EL3602	12.0		640
11	Term 12 (EL3602)	1011	EL3602	12.0		450
12	Term 13 (EL3602)	1012	EL3602	12.0		260
13	Term 14 (EL3602)	1013	EL3602	12.0		70
14	Term 3 (EL6688)	1014	EL6688	22.0		-240 !

Fig. 68: Illegally exceeding the E-Bus current

From TwinCAT 2.11 and above, a warning message “E-Bus Power of Terminal...” is output in the logger window when such a configuration is activated:

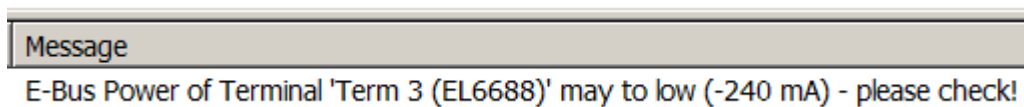

Fig. 69: Warning message for exceeding E-Bus current

**NOTICE**

**Caution! Malfunction possible!**

The same ground potential must be used for the E-Bus supply of all EtherCAT terminals in a terminal block!

## 5.2 TwinCAT Quick Start

TwinCAT is a development environment for real-time control including a multi PLC system, NC axis control, programming and operation. The whole system is mapped through this environment and enables access to a programming environment (including compilation) for the controller. Individual digital or analog inputs or outputs can also be read or written directly, in order to verify their functionality, for example.

For further information, please refer to <http://infosys.beckhoff.com>:

- **EtherCAT System Manual:**  
Fieldbus Components → EtherCAT Terminals → EtherCAT System Documentation → Setup in the TwinCAT System Manager
- **TwinCAT 2** → TwinCAT System Manager → I/O Configuration
- In particular, for TwinCAT – driver installation:  
**Fieldbus components** → Fieldbus Cards and Switches → FC900x – PCI Cards for Ethernet → Installation

Devices contain the relevant terminals for the actual configuration. All configuration data can be entered directly via editor functions (offline) or via the `scan` function (online):

- **“offline”**: The configuration can be customized by adding and positioning individual components. These can be selected from a directory and configured.
  - The procedure for the offline mode can be found under <http://infosys.beckhoff.com>:  
**TwinCAT 2** → TwinCAT System Manager → IO Configuration → Add an I/O device
- **“online”**: The existing hardware configuration is read
  - See also <http://infosys.beckhoff.com>:  
**Fieldbus components** → Fieldbus Cards and Switches → FC900x – PCI Cards for Ethernet → Installation → Searching for devices

The following relationship is envisaged between the user PC and individual control elements:

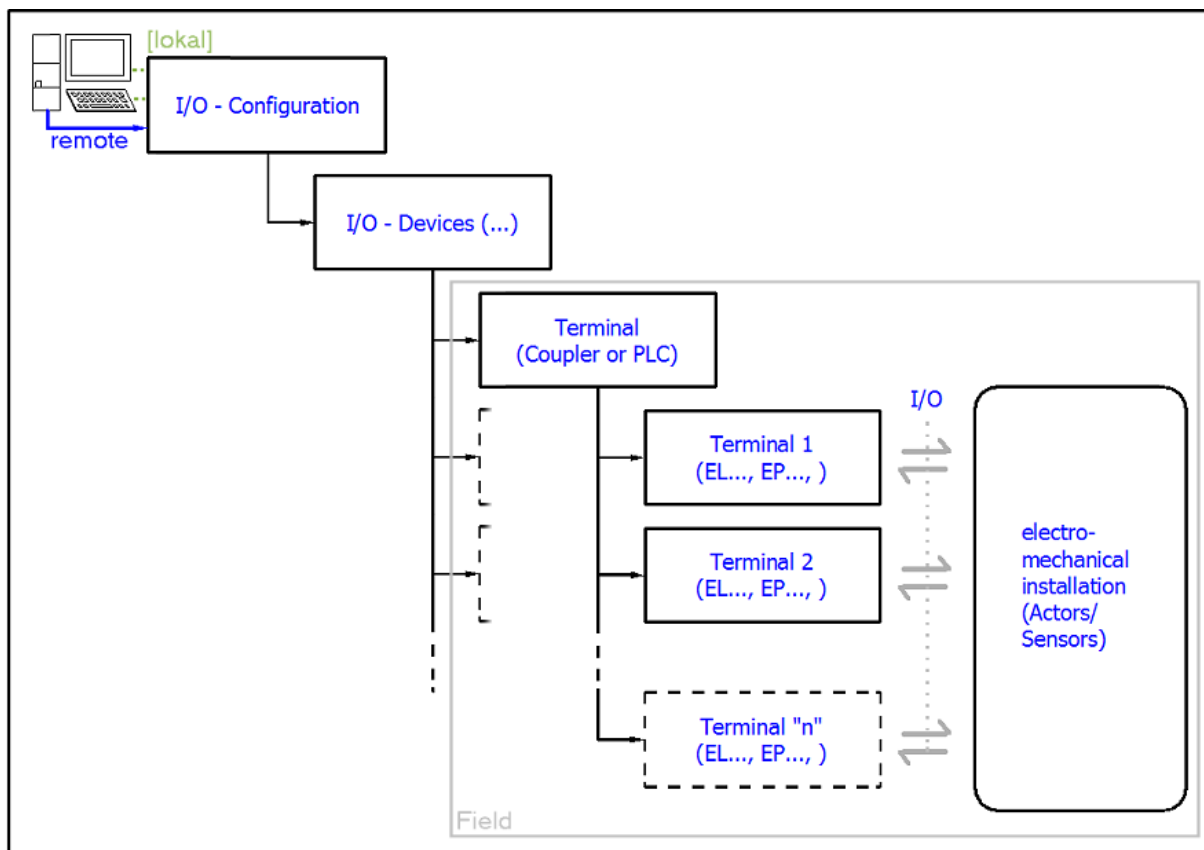

Fig. 70: Relationship between user side (commissioning) and installation

Insertion of certain components (I/O device, terminal, box...) by users functions the same way as in TwinCAT 2 and TwinCAT 3. The descriptions below relate solely to the online procedure.

**Example configuration (actual configuration)**

Based on the following example configuration, the subsequent subsections describe the procedure for TwinCAT 2 and TwinCAT 3:

- **CX2040** control system (PLC) including **CX2100-0004** power supply unit
- Connected to CX2040 on the right (E-bus): **EL1004** (4-channel digital input terminal 24 V<sub>DC</sub>)
- Linked via the X001 port (RJ-45): **EK1100** EtherCAT Coupler
- Connected to the EK1100 EtherCAT Coupler on the right (E-bus): **EL2008** (8-channel digital output terminal 24 V<sub>DC</sub>; 0.5 A)
- (Optional via X000: a link to an external PC for the user interface)

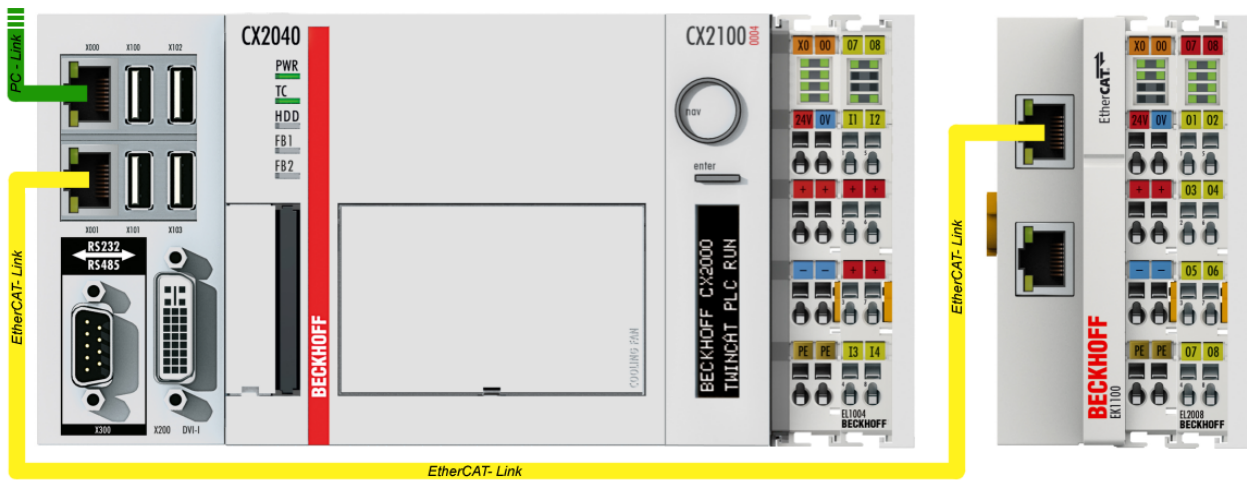

Fig. 71: Control configuration with Embedded PC, input (EL1004) and output (EL2008)

Note that all combinations of a configuration are possible; for example, the EL1004 terminal could also be connected after the coupler, or the EL2008 terminal could additionally be connected to the CX2040 on the right, in which case the EK1100 coupler wouldn't be necessary.

## 5.2.1 TwinCAT 2

### Startup

TwinCAT 2 basically uses two user interfaces: the TwinCAT System Manager for communication with the electromechanical components and TwinCAT PLC Control for the development and compilation of a controller. The starting point is the TwinCAT System Manager.

After successful installation of the TwinCAT system on the PC to be used for development, the TwinCAT 2 System Manager displays the following user interface after startup:

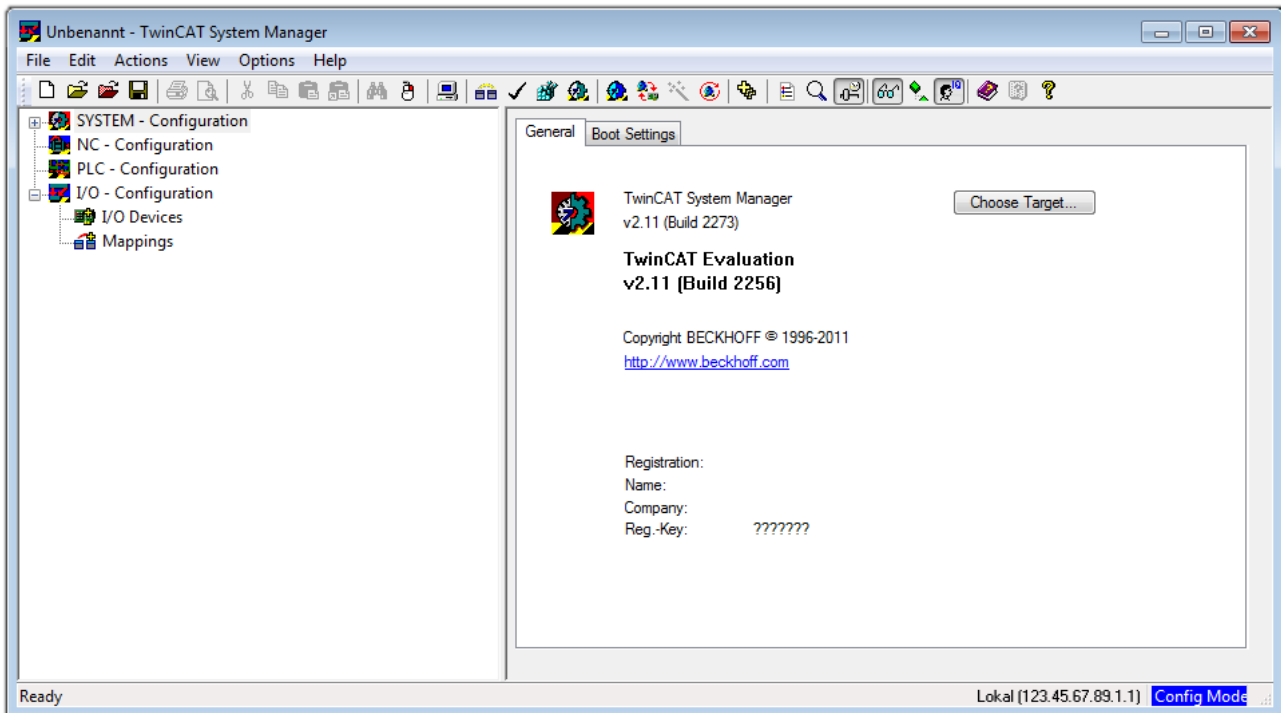



Fig. 72: Initial TwinCAT 2 user interface

Generally, TwinCAT can be used in local or remote mode. Once the TwinCAT system, including the user interface (standard) is installed on the respective PLC, TwinCAT can be used in local mode and thus the next step is “[Insert Device \[▶ 146\]](#)”.

If the intention is to address the TwinCAT runtime environment installed on a PLC remotely from another system used as a development environment, the target system must be made known first. In the menu under

“Actions” → “Choose Target System...”, the following window is opened for this via the symbol “” or the “F8” key:

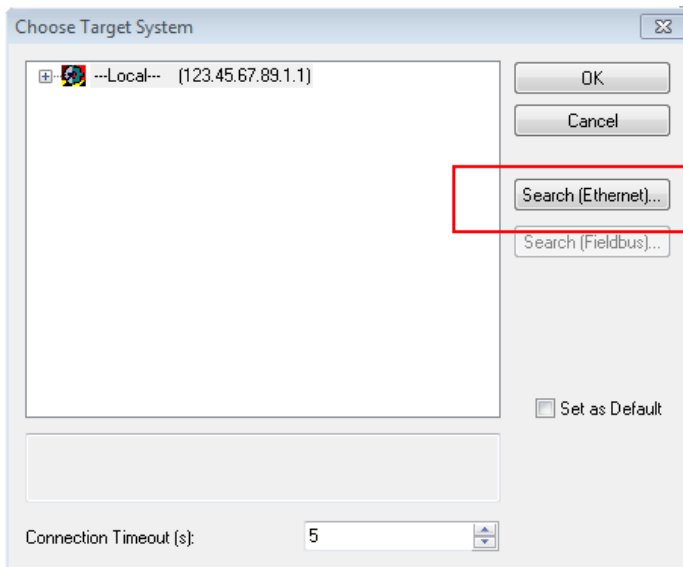

Fig. 73: Selection of the target system

Use “Search (Ethernet)...” to enter the target system. Thus another dialog opens to either:

- enter the known computer name after “Enter Host Name / IP:” (as shown in red)
- perform a “Broadcast Search” (if the exact computer name is not known)
- enter the known computer – IP or AmsNetID

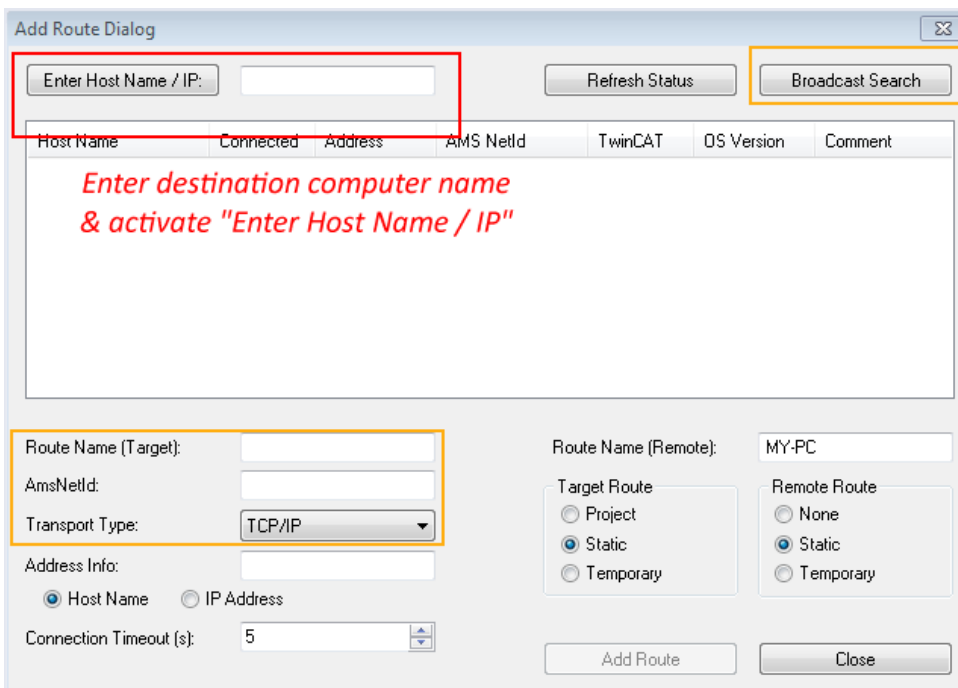
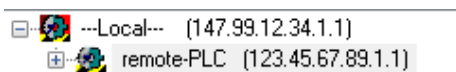

Fig. 74: specify the PLC for access by the TwinCAT System Manager: selection of the target system



Once the target system has been entered, it is available for selection as follows (a correct password may have to be entered before this):



After confirmation with “OK”, the target system can be accessed via the System Manager.

**Adding devices**

In the configuration tree of the TwinCAT 2 System Manager user interface on the left, select “I/O Devices” and then right-click to open a context menu and select “Scan Devices...”, or start the action in the menu bar

via . The TwinCAT System Manager may first have to be set to “Config Mode” via  or via the menu “Actions” → “Set/Reset TwinCAT to Config Mode...” (Shift + F4).

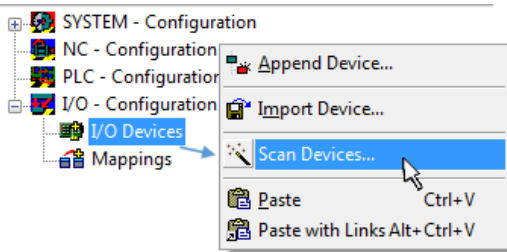

Fig. 75: Select “Scan Devices...”

Confirm the warning message, which follows, and select the “EtherCAT” devices in the dialog:

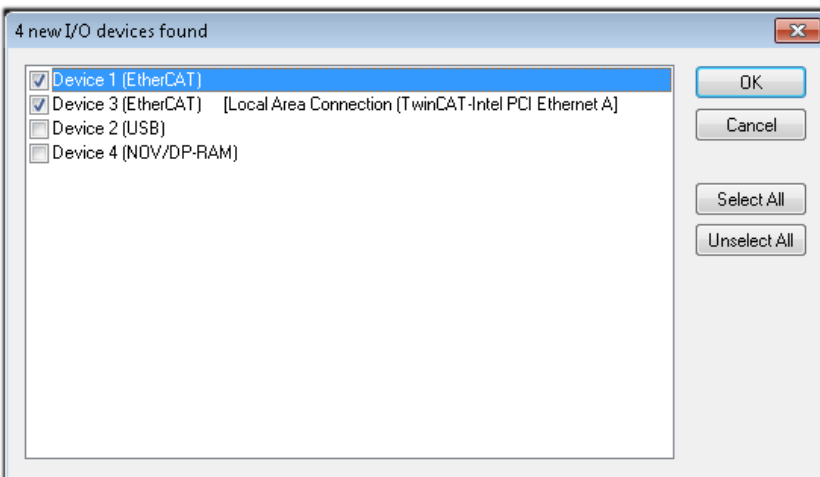

Fig. 76: Automatic detection of I/O devices: selection of the devices to be integrated

Confirm the message “Find new boxes”, in order to determine the terminals connected to the devices. “Free Run” enables manipulation of input and output values in “Config Mode” and should also be acknowledged.

Based on the [example configuration \[▶ 143\]](#) described at the beginning of this section, the result is as follows:

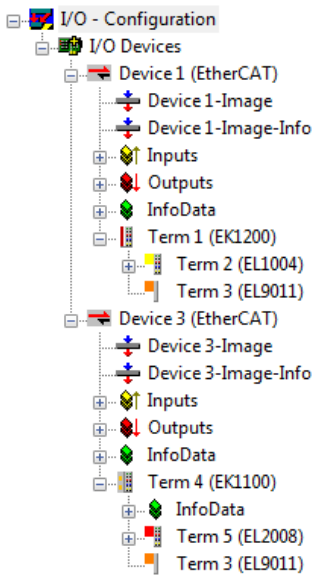

Fig. 77: Mapping of the configuration in the TwinCAT 2 System Manager

The whole process consists of two stages, which can also be performed separately (first determine the devices, then determine the connected elements such as boxes, terminals, etc.). A scan (search function) can also be initiated by selecting “Device ...” from the context menu, which then only reads the elements below which are present in the configuration:

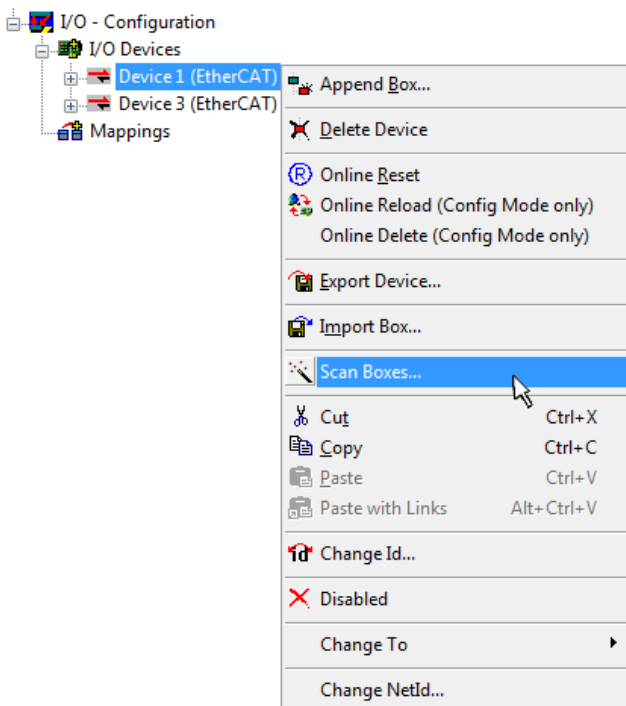

Fig. 78: Reading of individual terminals connected to a device

This functionality is useful if the actual configuration is modified at short notice.

### Programming and integrating the PLC

TwinCAT PLC Control is the development environment for generating the controller in different program environments: TwinCAT PLC Control supports all languages described in IEC 61131-3. There are two text-based languages and three graphical languages.

- **Text-based languages**
  - Instruction List (IL)
  - Structured Text (ST)

- **Graphical languages**
  - Function Block Diagram (FBD)
  - Ladder Diagram (LD)
  - The Continuous Function Chart Editor (CFC)
  - Sequential Function Chart (SFC)

The following section refers solely to Structured Text (ST).

After starting TwinCAT PLC Control, the following user interface is shown for an initial project:

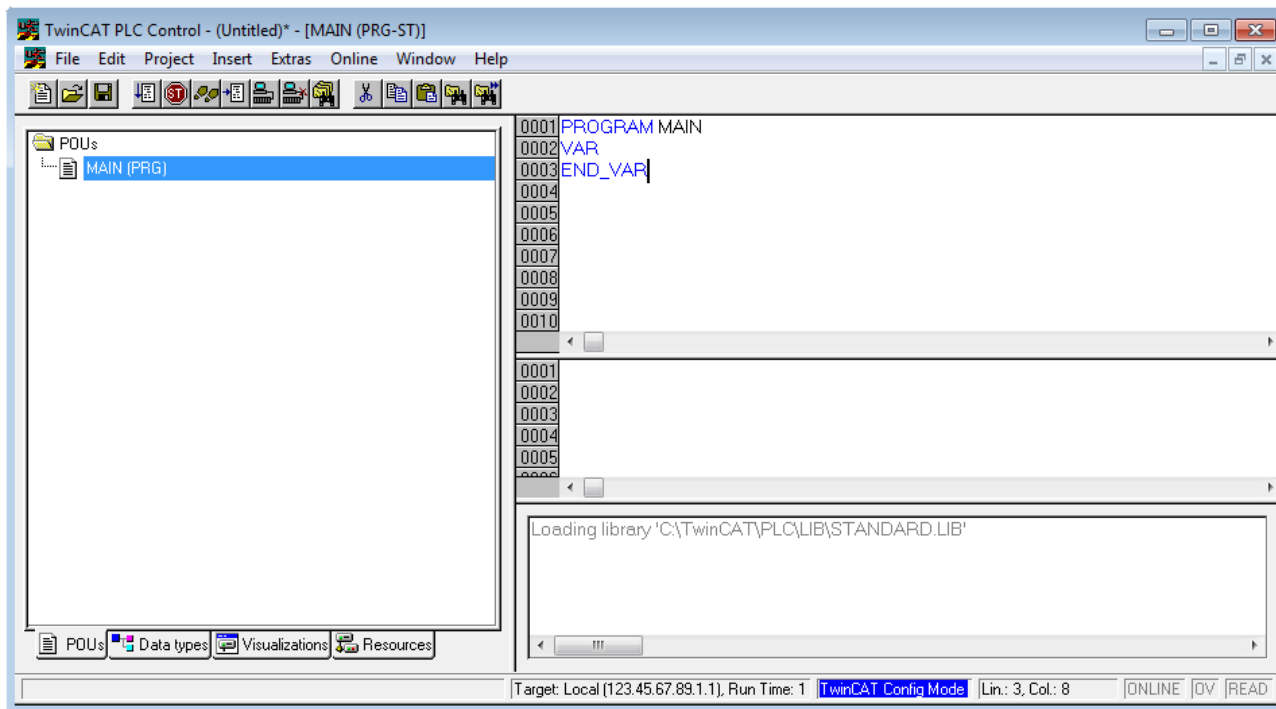

Fig. 79: TwinCAT PLC Control after startup

Example variables and an example program have been created and stored under the name “PLC\_example.pro”:



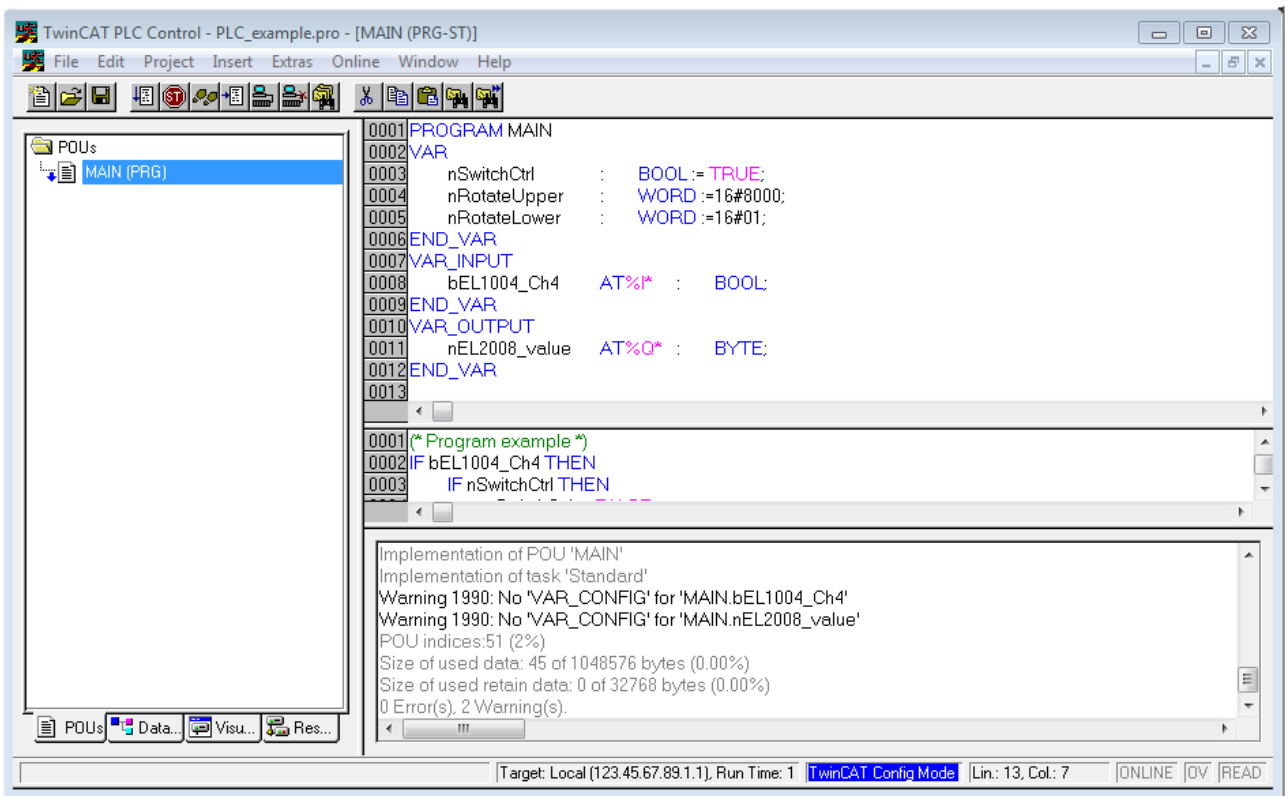

Fig. 80: Example program with variables after a compile process (without variable integration)

Warning 1990 (missing “VAR\_CONFIG”) after a compile process indicates that the variables defined as external (with the ID “AT%I\*” or “AT%Q\*”) have not been assigned. After successful compilation, TwinCAT PLC Control creates a “\*.tpy” file in the directory in which the project was stored. This file (“\*.tpy”) contains variable assignments and is not known to the System Manager, hence the warning. Once the System Manager has been notified, the warning no longer appears.

First, integrate the TwinCAT PLC Control project in the **System Manager**. This is performed via the context menu of the PLC configuration (right-click) and selecting “Append PLC Project...”:

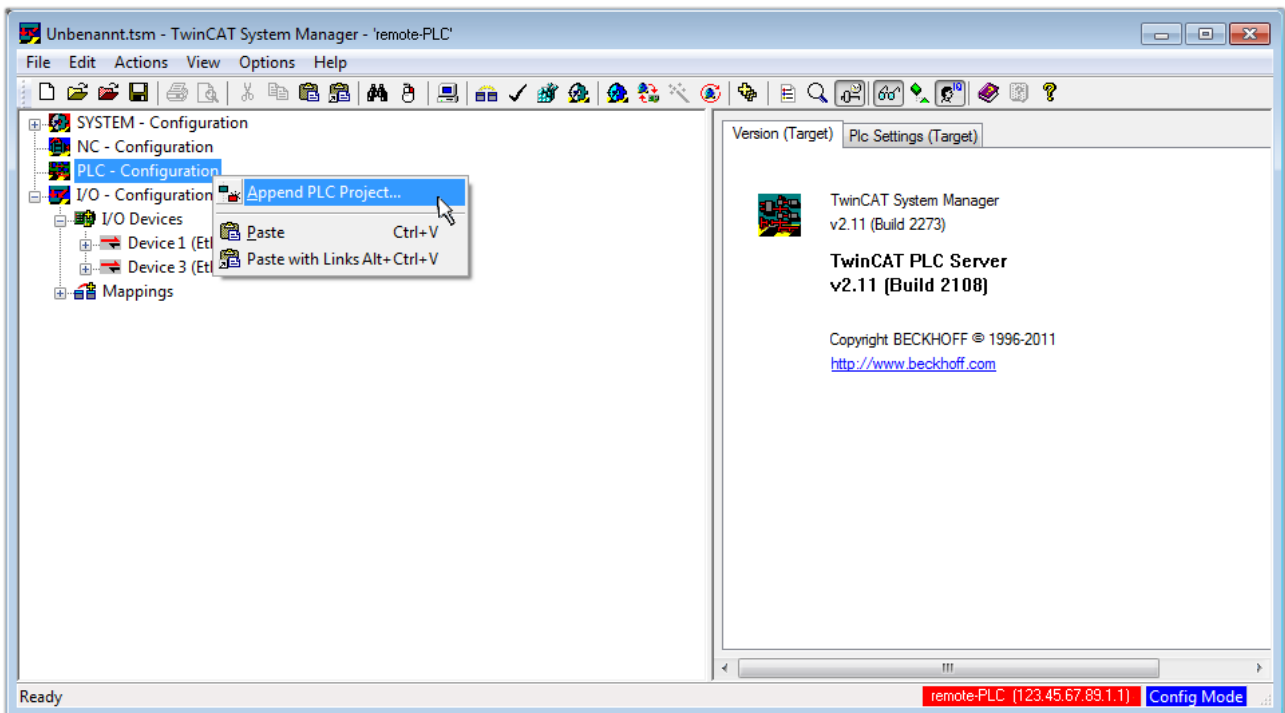

Fig. 81: Appending the TwinCAT PLC Control project

Select the PLC configuration “PLC\_example.tpy” in the browser window that opens. The project including the two variables identified with “AT” are then integrated in the configuration tree of the System Manager:

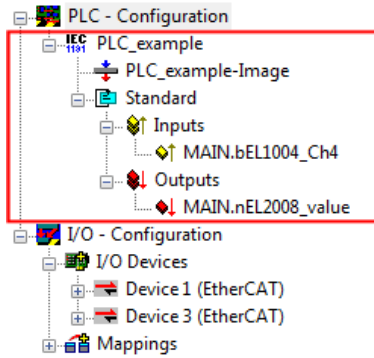

Fig. 82: PLC project integrated in the PLC configuration of the System Manager

The two variables “bEL1004\_Ch4” and “nEL2008\_value” can now be assigned to certain process objects of the I/O configuration.

**Assigning variables**

Open a window for selecting a suitable process object (PDO) via the context menu of a variable of the integrated project “PLC\_example” and via “Modify Link...” “Standard”:

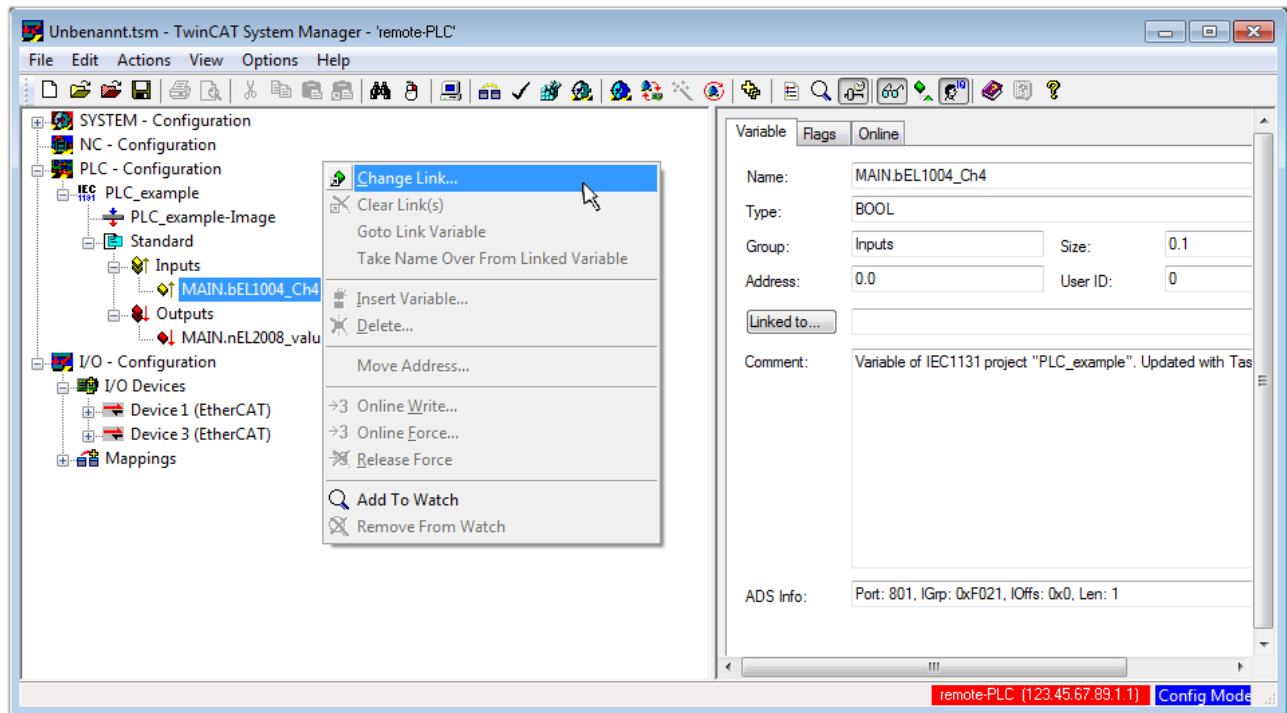

Fig. 83: Creating the links between PLC variables and process objects

In the window that opens, the process object for the “bEL1004\_Ch4” BOOL-type variable can be selected from the PLC configuration tree:

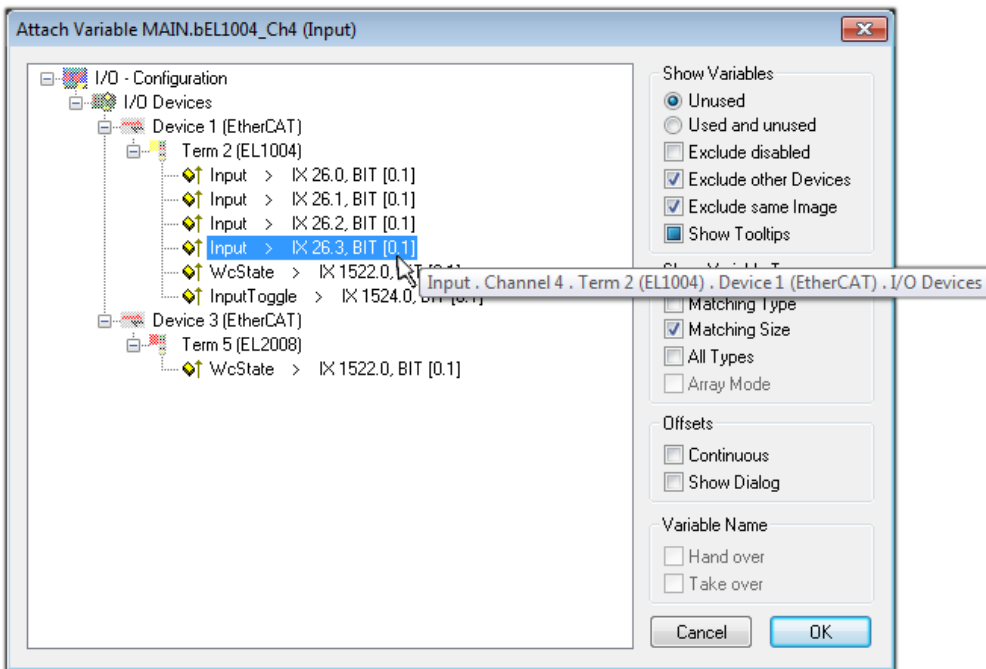

Fig. 84: Selecting BOOL-type PDO

According to the default setting, only certain PDO objects are now available for selection. In this example, the input of channel 4 of the EL1004 terminal is selected for linking. In contrast, the checkbox “All types” must be ticked to create the link for the output variables, in order to allocate a set of eight separate output bits to a byte variable in this case. The following diagram shows the whole process:

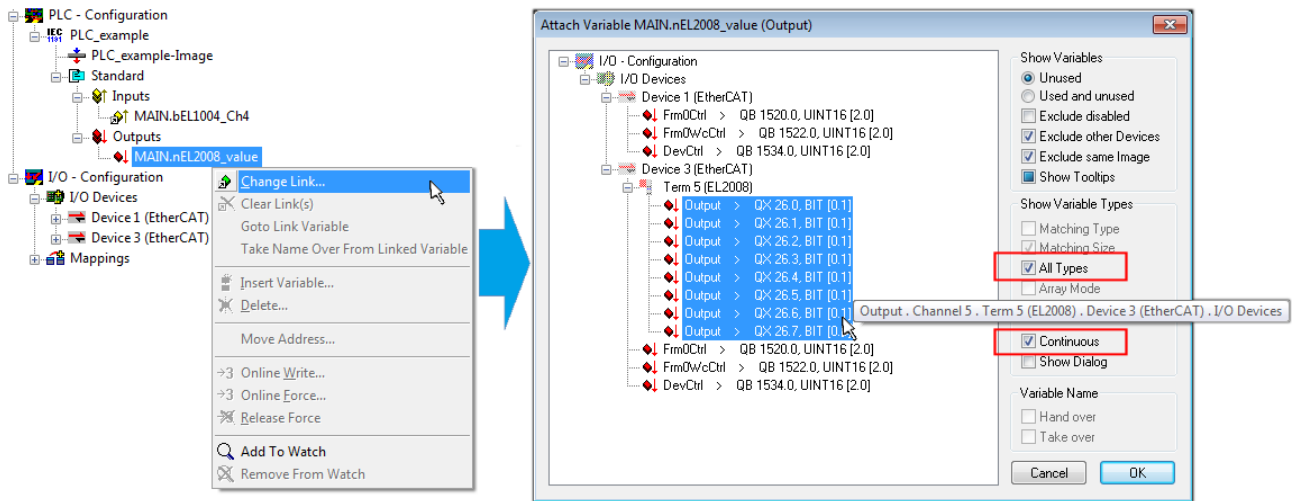



Fig. 85: Selecting several PDOs simultaneously: activate “Continuous” and “All types”

Note that the “Continuous” checkbox was also activated. This is designed to allocate the bits contained in the byte of the “nEL2008\_value” variable sequentially to all eight selected output bits of the EL2008 Terminal. It is thus possible to subsequently address all eight outputs of the terminal in the program with a byte corresponding to bit 0 for channel 1 to bit 7 for channel 8 of the PLC. A special symbol (  ) on the yellow or red object of the variable indicates that a link exists. The links can also be checked by selecting “Goto Link Variable” from the context menu of a variable. The opposite linked object, in this case the PDO, is automatically selected:

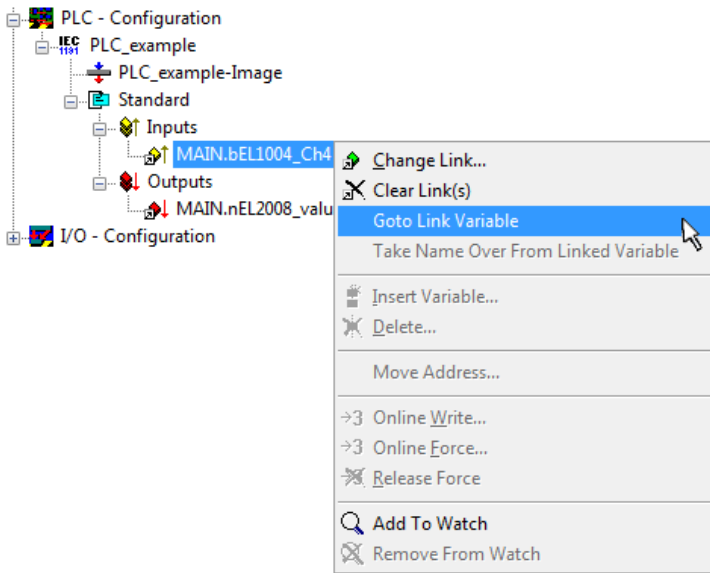

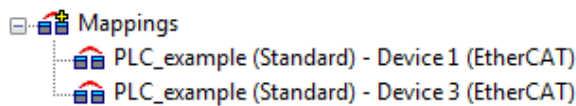

Fig. 86: Application of a “Goto Link Variable”, using “MAIN.bEL1004\_Ch4” as an example

The process of assigning variables to the PDO is completed via the menu option “Actions” → “Create assignment”, or via  .

This can be visualized in the configuration:



The process of creating links can also be performed in the opposite direction, i.e. starting with individual PDOs to a variable. However, in this example, it would not be possible to select all output bits for the EL2008, since the terminal only makes individual digital outputs available. If a terminal has a byte, word, integer or similar PDO, it is also possible to allocate this to a set of bit-standardized variables. Here, too, a “Goto Link Variable” can be executed in the other direction, so that the respective PLC instance can then be selected.

**Activation of the configuration**

The allocation of PDO to PLC variables has now established the connection from the controller to the inputs and outputs of the terminals. The configuration can now be activated. First, the configuration can be verified

via  (or via “Actions” → “Check Configuration”). If no error is present, the configuration can be

activated via  (or via “Actions” → “Activate Configuration...”) to transfer the System Manager settings to the runtime system. Confirm the messages “Old configurations will be overwritten!” and “Restart TwinCAT system in Run mode” with “OK”.

A few seconds later, the real-time status **RTime 0%** is displayed at the bottom right in the System Manager. The PLC system can then be started as described below.

**Starting the controller**

Starting from a remote system, the PLC control has to be linked with the embedded PC over the Ethernet via “Online” → “Choose Runtime System...”:

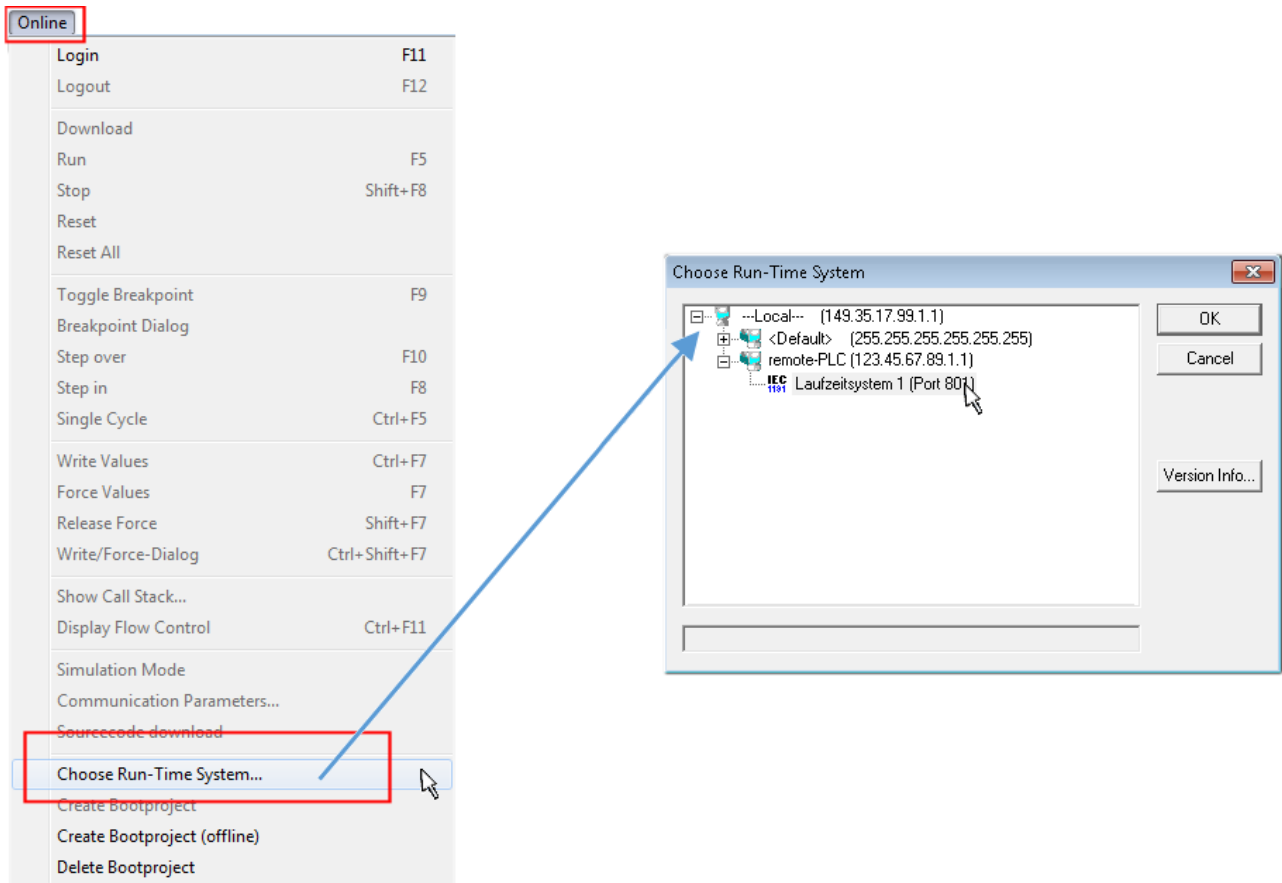



Fig. 87: Choose target system (remote)

In this example, "Runtime system 1 (port 801)" is selected and confirmed. Link the PLC with the real-time

system via the menu option "Online" → "Login", the F11 key or by clicking on the symbol . The control program can then be loaded for execution. This results in the message "No program on the controller! Should the new program be loaded?", which should be confirmed with "Yes". The runtime environment is ready for the program start:

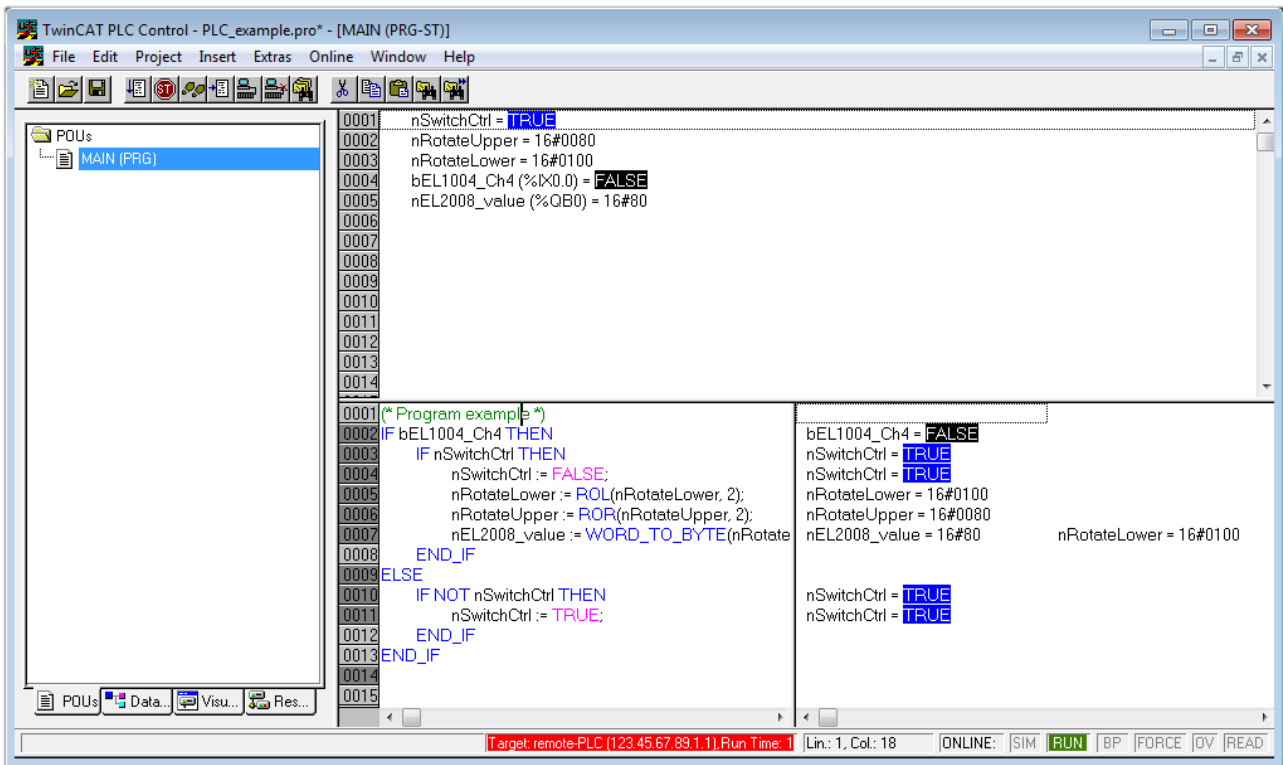

Fig. 88: PLC Control logged in, ready for program startup

The PLC can now be started via “Online” → “Run”, F5 key or .

## 5.2.2 TwinCAT 3

### Startup

TwinCAT 3 makes the development environment areas available all together, with Microsoft Visual Studio: after startup, the project folder explorer appears on the left in the general window area (see “TwinCAT System Manager” of TwinCAT 2) for communication with the electromechanical components.

After successful installation of the TwinCAT system on the PC to be used for development, TwinCAT 3 (shell) displays the following user interface after startup:



Fig. 89: Initial TwinCAT 3 user interface

First create a new project via  **New TwinCAT Project...** (or under “File”→“New”→“Project...”). In the following dialog, make the corresponding entries as required (as shown in the diagram):

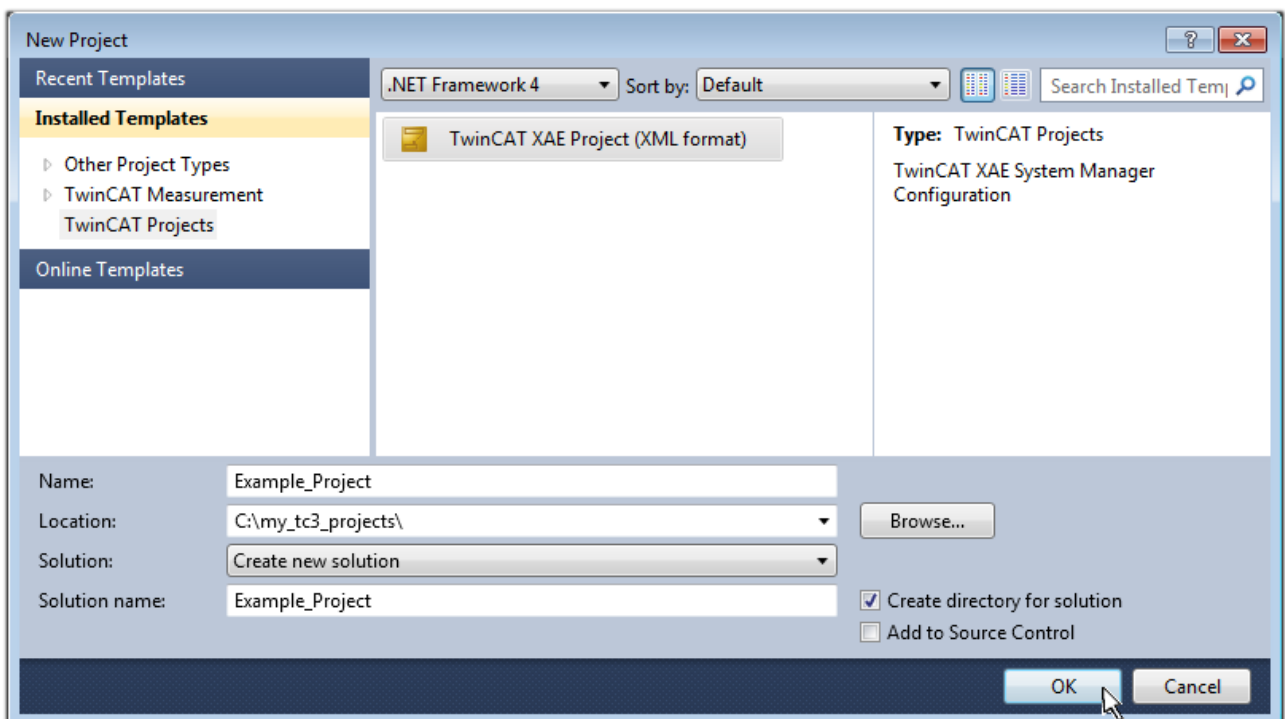

Fig. 90: Create new TwinCAT 3 project

The new project is then available in the project folder explorer:

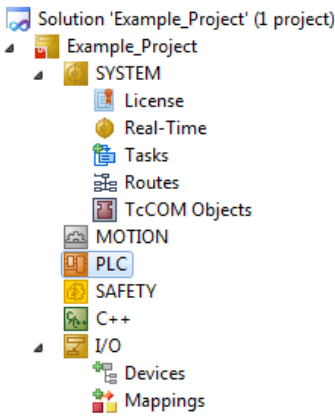
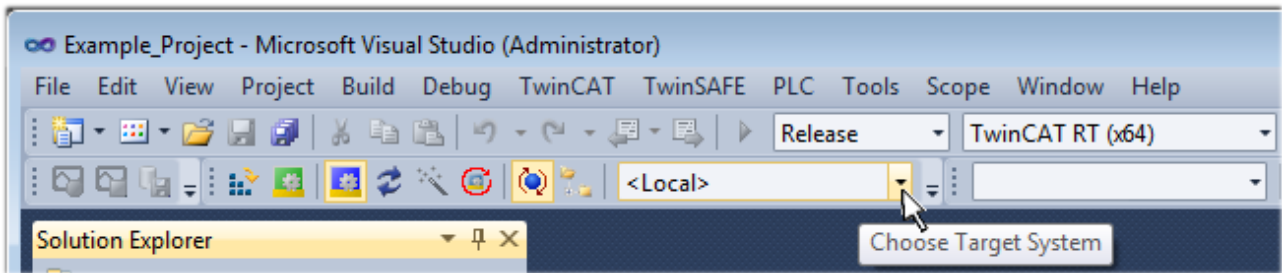

Fig. 91: New TwinCAT 3 project in the project folder explorer

Generally, TwinCAT can be used in local or remote mode. Once the TwinCAT system including the user interface (standard) is installed on the respective PLC (locally), TwinCAT can be used in local mode and the process can be continued with the next step, “Insert Device [▶ 157]”.

If the intention is to address the TwinCAT runtime environment installed on a PLC remotely from another system used as a development environment, the target system must be made known first. Via the symbol in the menu bar:



expand the pull-down menu:

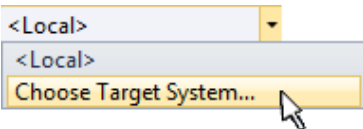

and open the following window:

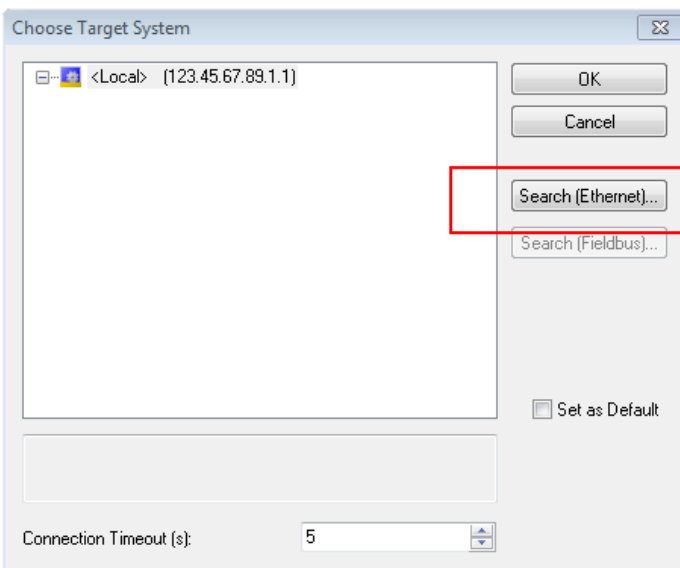

Fig. 92: Selection dialog: Choose the target system



Use “Search (Ethernet)...” to enter the target system. Thus another dialog opens to either:

- enter the known computer name after “Enter Host Name / IP:” (as shown in red)
- perform a “Broadcast Search” (if the exact computer name is not known)
- enter the known computer – IP or AmsNetID

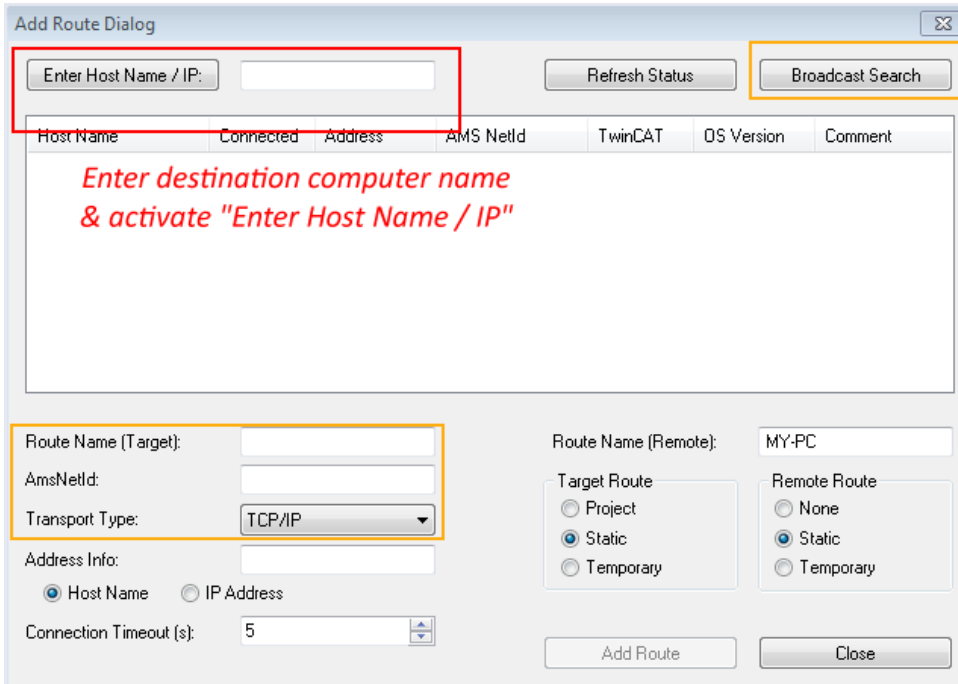
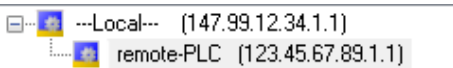

Fig. 93: specify the PLC for access by the TwinCAT System Manager: selection of the target system

Once the target system has been entered, it is available for selection as follows (the correct password may have to be entered beforehand):



After confirmation with “OK” the target system can be accessed via the Visual Studio shell.

### Adding devices

In the project folder explorer on the left of the Visual Studio shell user interface, select “Devices” within the

element “I/O”, then right-click to open a context menu and select “Scan” or start the action via  in the

menu bar. The TwinCAT System Manager may first have to be set to “Config mode” via  or via the menu “TwinCAT” → “Restart TwinCAT (Config Mode)”.

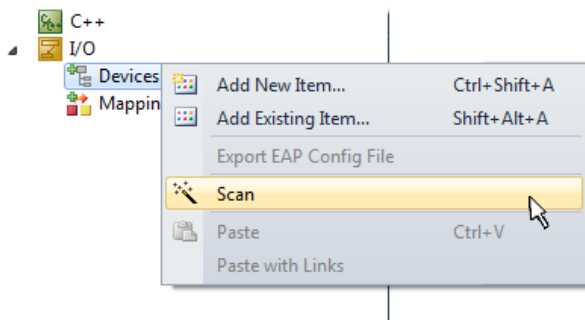

Fig. 94: Select “Scan”

Confirm the warning message, which follows, and select the “EtherCAT” devices in the dialog:

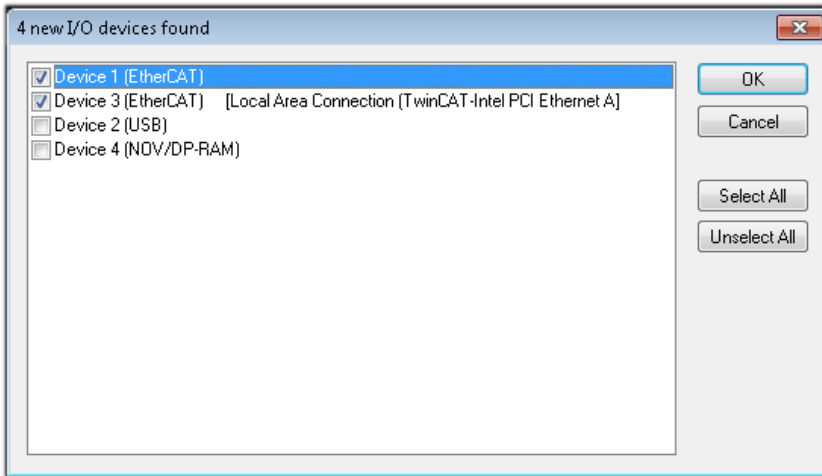

Fig. 95: Automatic detection of I/O devices: selection of the devices to be integrated

Confirm the message “Find new boxes”, in order to determine the terminals connected to the devices. “Free Run” enables manipulation of input and output values in “Config Mode” and should also be acknowledged.

Based on the [example configuration \[▶\\_143\]](#) described at the beginning of this section, the result is as follows:

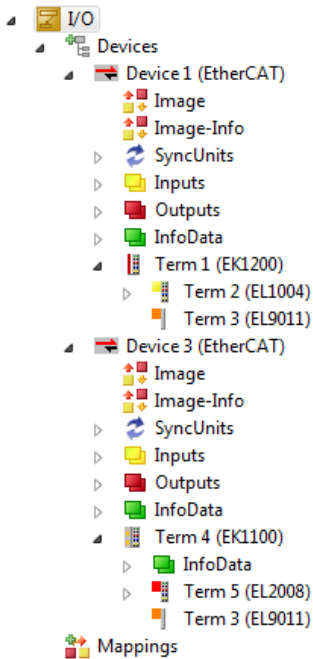

Fig. 96: Mapping of the configuration in VS shell of the TwinCAT 3 environment

The whole process consists of two stages, which can also be performed separately (first determine the devices, then determine the connected elements such as boxes, terminals, etc.). A scan (search function) can also be initiated by selecting “Device ...” from the context menu, which then only reads the elements below which are present in the configuration:

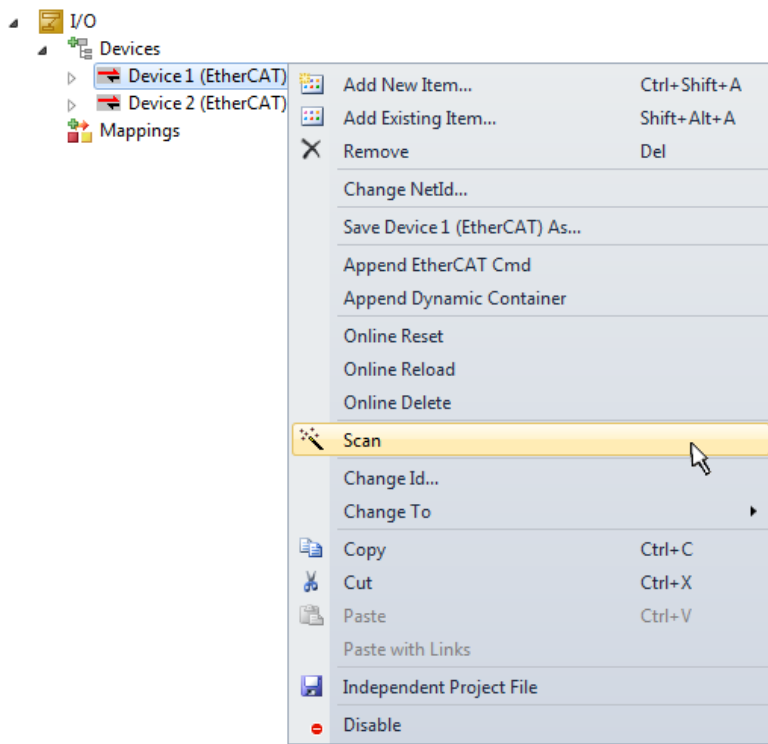

Fig. 97: Reading of individual terminals connected to a device

This functionality is useful if the actual configuration is modified at short notice.

### Programming the PLC

TwinCAT PLC Control is the development environment for generating the controller in different program environments: TwinCAT PLC Control supports all languages described in IEC 61131-3. There are two text-based languages and three graphical languages.

- **Text-based languages**
  - Instruction List (IL)
  - Structured Text (ST)
- **Graphical languages**
  - Function Block Diagram (FBD)
  - Ladder Diagram (LD)
  - The Continuous Function Chart Editor (CFC)
  - Sequential Function Chart (SFC)

The following section refers solely to Structured Text (ST).

In order to create a programming environment, a PLC subproject is added to the example project via the context menu of the "PLC" in the project folder explorer by selecting "Add New Item....":

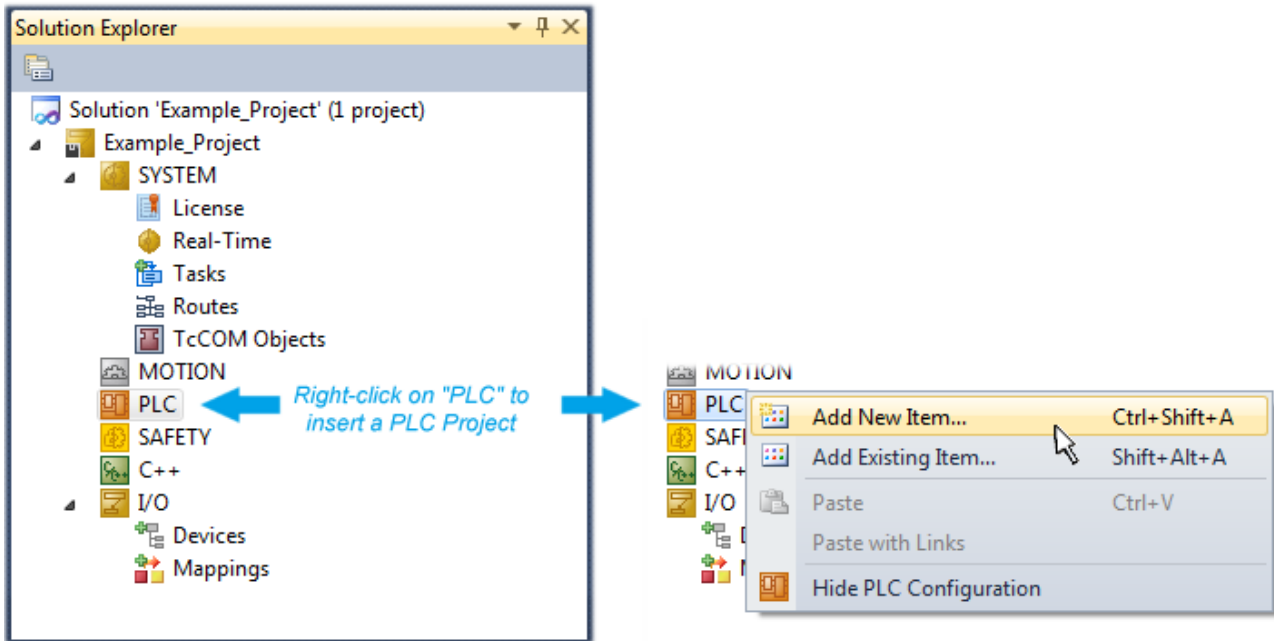

Fig. 98: Adding the programming environment in “PLC”

In the dialog that opens, select “Standard PLC project” and enter “PLC\_example” as project name, for example, and select a corresponding directory:

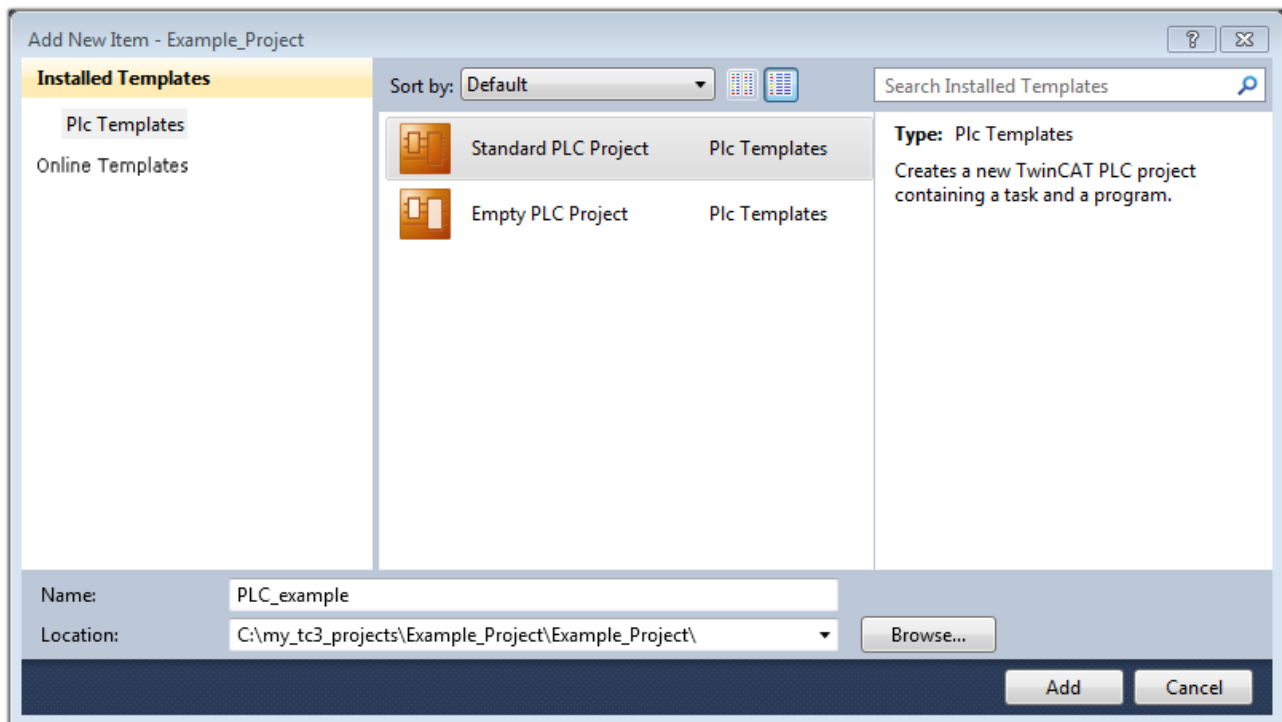

Fig. 99: Specifying the name and directory for the PLC programming environment

The “Main” program, which already exists due to selecting “Standard PLC project”, can be opened by double-clicking on “PLC\_example\_project” in “POUs”. The following user interface is shown for an initial project:

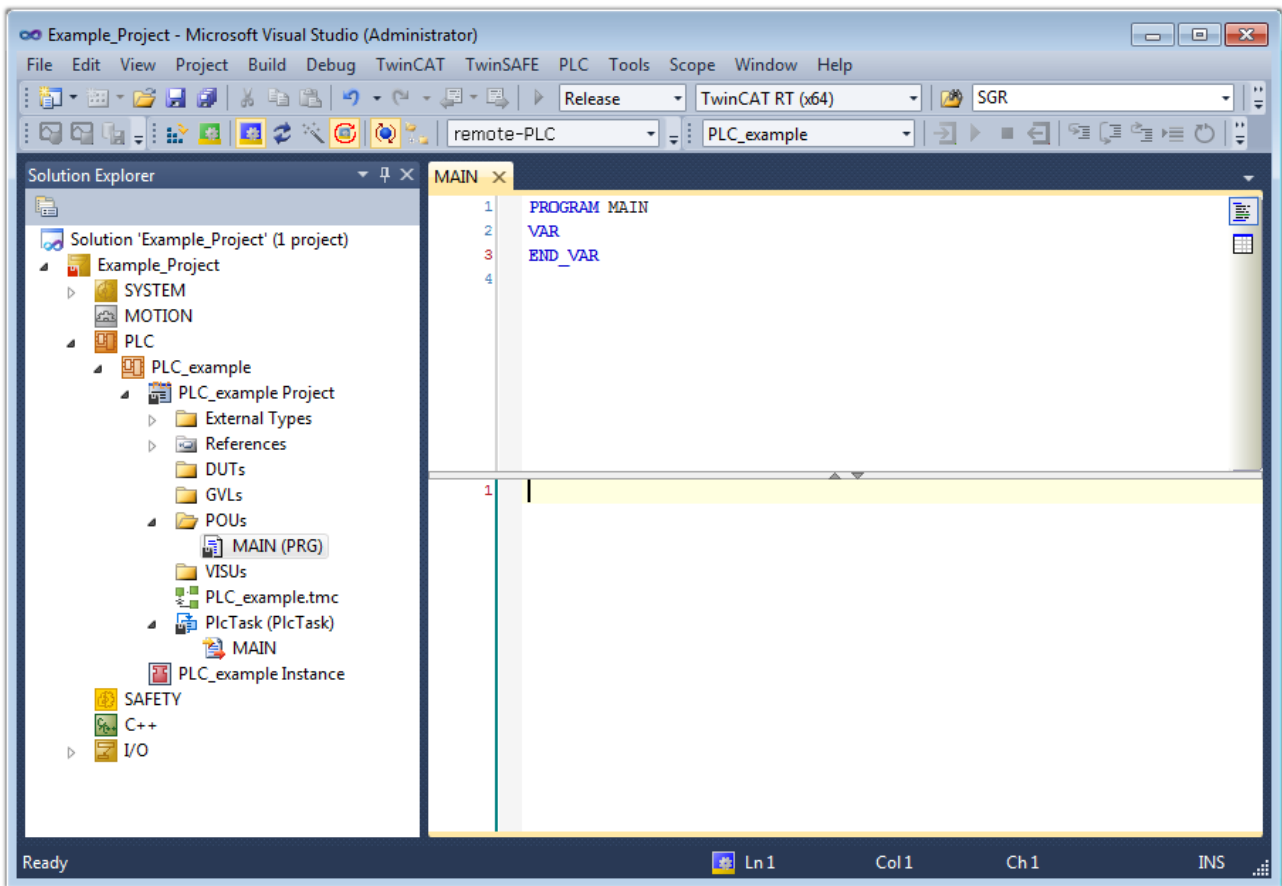

Fig. 100: Initial “Main” program for the standard PLC project

Now example variables and an example program have been created for the next stage of the process:

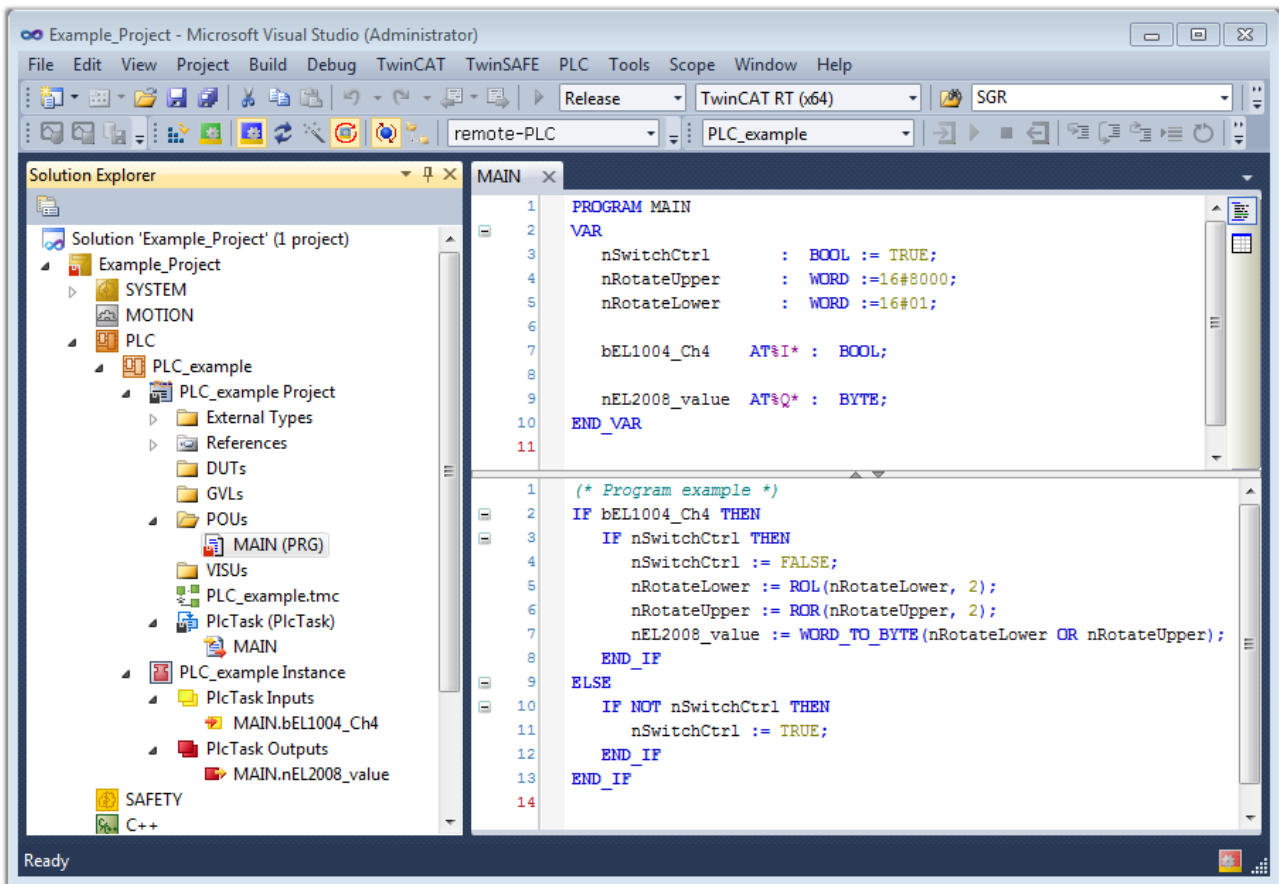

Fig. 101: Example program with variables after a compile process (without variable integration)

The control program is now created as a project folder, followed by the compile process:

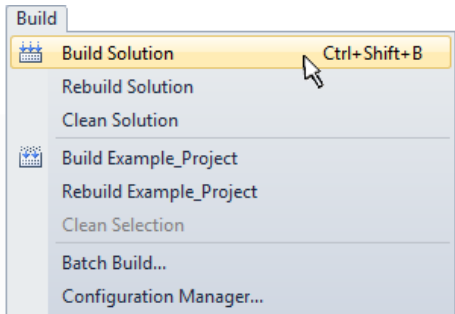
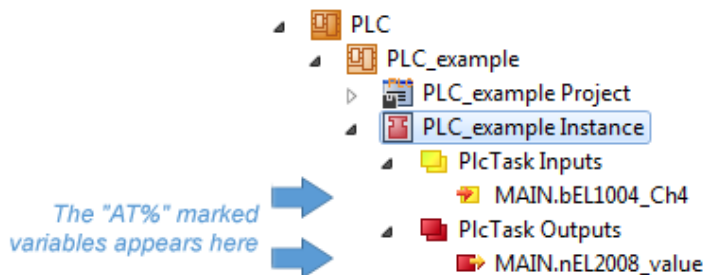

Fig. 102: Start program compilation

The following variables, identified in the ST/PLC program with “AT%”, are then available under “Assignments” in the project folder explorer:



**Assigning variables**

Via the menu of an instance – variables in the “PLC” context, use the “Modify Link...” option to open a window to select a suitable process object (PDO) for linking:

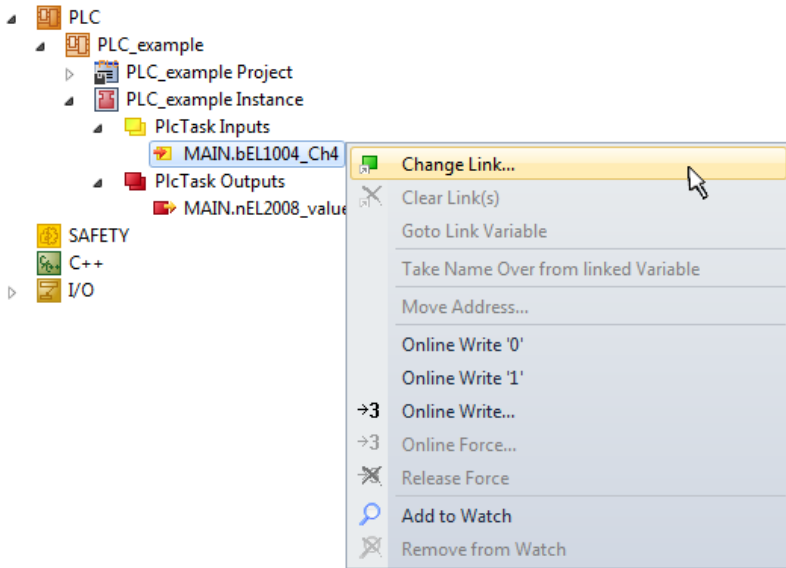

Fig. 103: Creating the links between PLC variables and process objects

In the window that opens, the process object for the “bEL1004\_Ch4” BOOL-type variable can be selected from the PLC configuration tree:

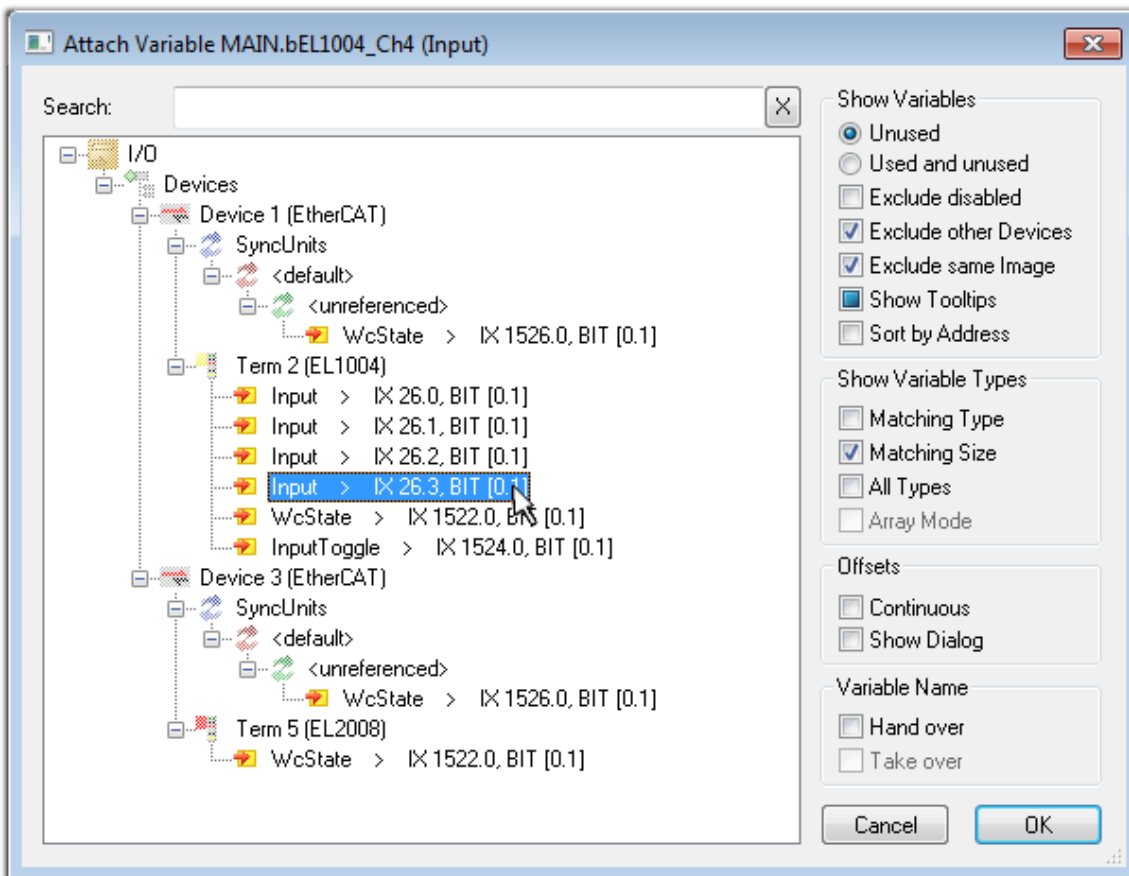

Fig. 104: Selecting BOOL-type PDO

According to the default setting, only certain PDO objects are now available for selection. In this example, the input of channel 4 of the EL1004 terminal is selected for linking. In contrast, the checkbox “All types” must be ticked to create the link for the output variables, in order to allocate a set of eight separate output bits to a byte variable in this case. The following diagram shows the whole process:

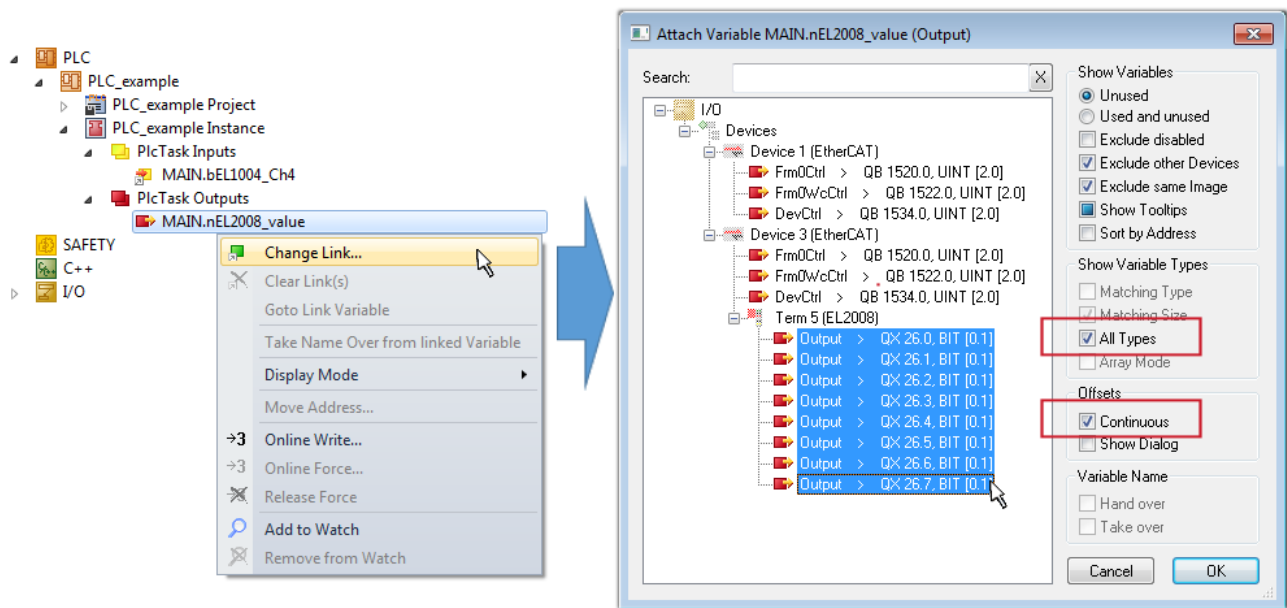



Fig. 105: Selecting several PDOs simultaneously: activate “Continuous” and “All types”

Note that the “Continuous” checkbox was also activated. This is designed to allocate the bits contained in the byte of the “nEL2008\_value” variable sequentially to all eight selected output bits of the EL2008 Terminal. It is thus possible to subsequently address all eight outputs of the terminal in the program with a byte corresponding to bit 0 for channel 1 to bit 7 for channel 8 of the PLC. A special symbol (  ) on the yellow or red object of the variable indicates that a link exists. The links can also be checked by selecting “Goto Link Variable” from the context menu of a variable. The opposite linked object, in this case the PDO, is automatically selected:

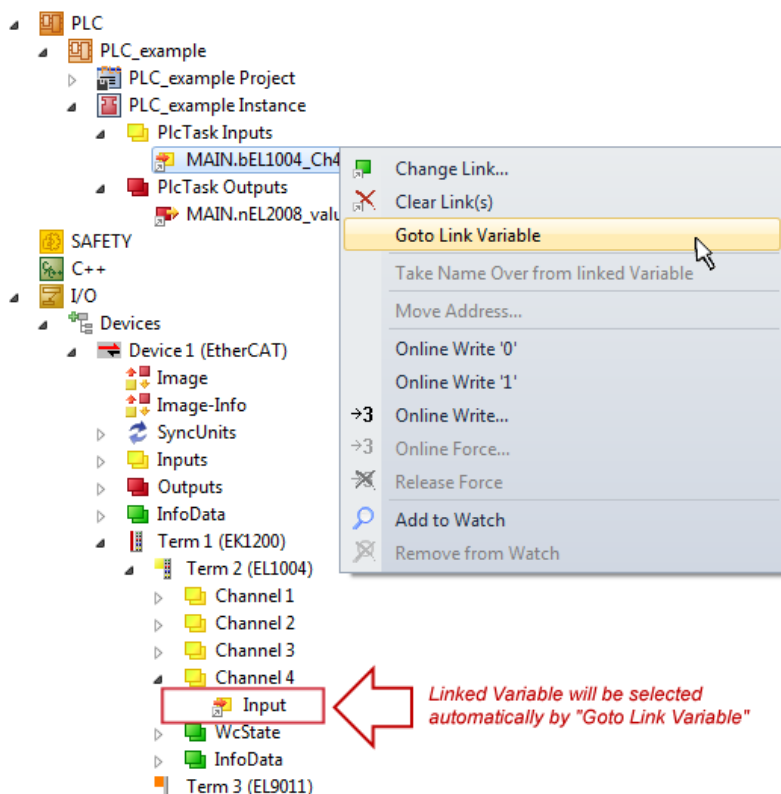

Fig. 106: Application of a “Goto Link Variable”, using “MAIN.bEL1004\_Ch4” as an example

The process of creating links can also be performed in the opposite direction, i.e. starting with individual PDOs to a variable. However, in this example, it would not be possible to select all output bits for the EL2008, since the terminal only makes individual digital outputs available. If a terminal has a byte, word,



integer or similar PDO, it is also possible to allocate this to a set of bit-standardized variables. Here, too, a “Goto Link Variable” can be executed in the other direction, so that the respective PLC instance can then be selected.

**Note on type of variable assignment**

**i** The following type of variable assignment can only be used from TwinCAT version V3.1.4024.4 onwards and is only available for terminals with a microcontroller.

In TwinCAT, a structure can be created from the mapped process data of a terminal. An instance of this structure can then be created in the PLC, so it is possible to access the process data directly from the PLC without having to declare own variables.

The procedure for the EL3001 1-channel analog input terminal -10...+10 V is shown as an example.

1. First, the required process data must be selected in the “Process data” tab in TwinCAT.
2. After that, the PLC data type must be generated in the “PLC” tab via the check box.
3. The data type in the “Data Type” field can then be copied using the “Copy” button.

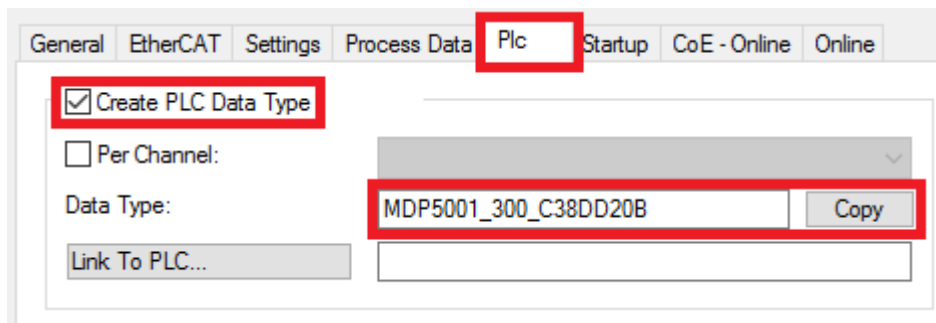

Fig. 107: Creating a PLC data type

4. An instance of the data structure of the copied data type must then be created in the PLC.

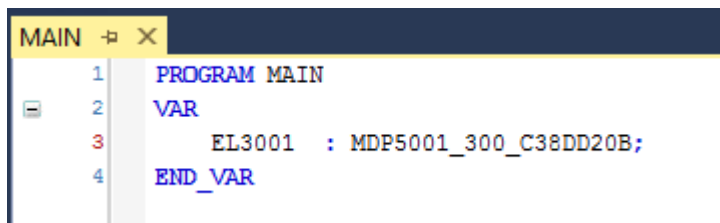

Fig. 108: Instance\_of\_struct

5. Then the project folder must be created. This can be done either via the key combination “CTRL + Shift + B” or via the “Build” tab in TwinCAT.
6. The structure in the “PLC” tab of the terminal must then be linked to the created instance.

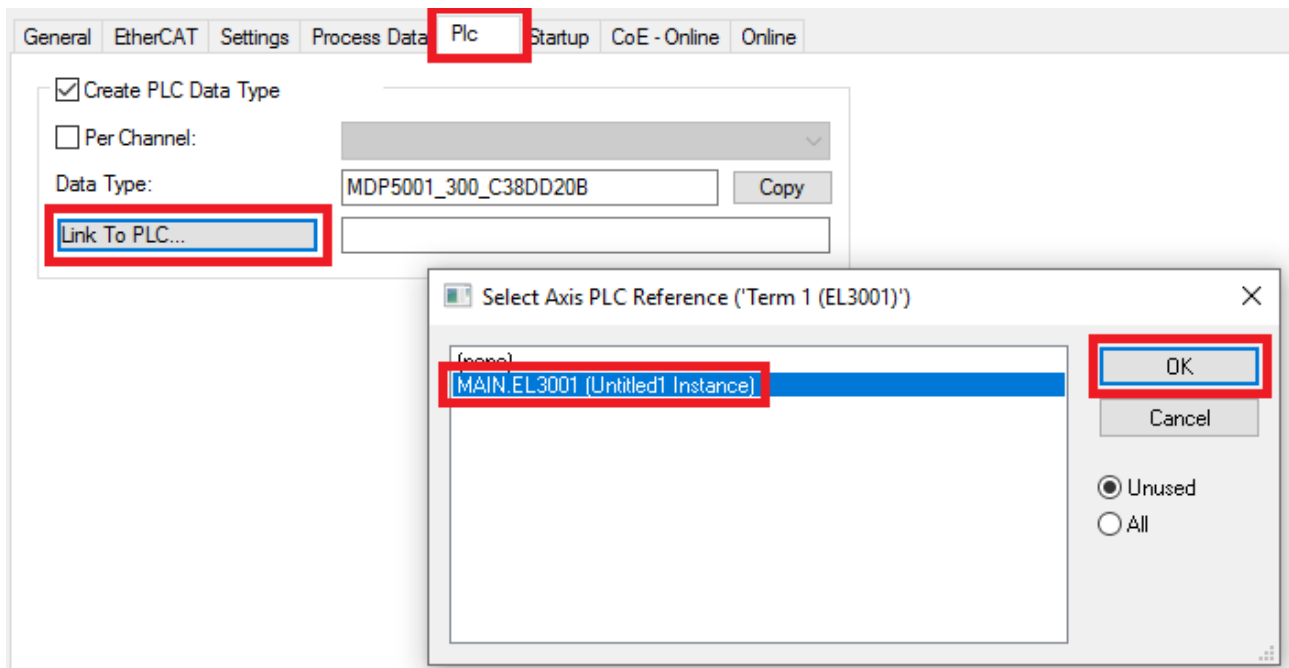

Fig. 109: Linking the structure

7. In the PLC, the process data can then be read or written via the structure in the program code.

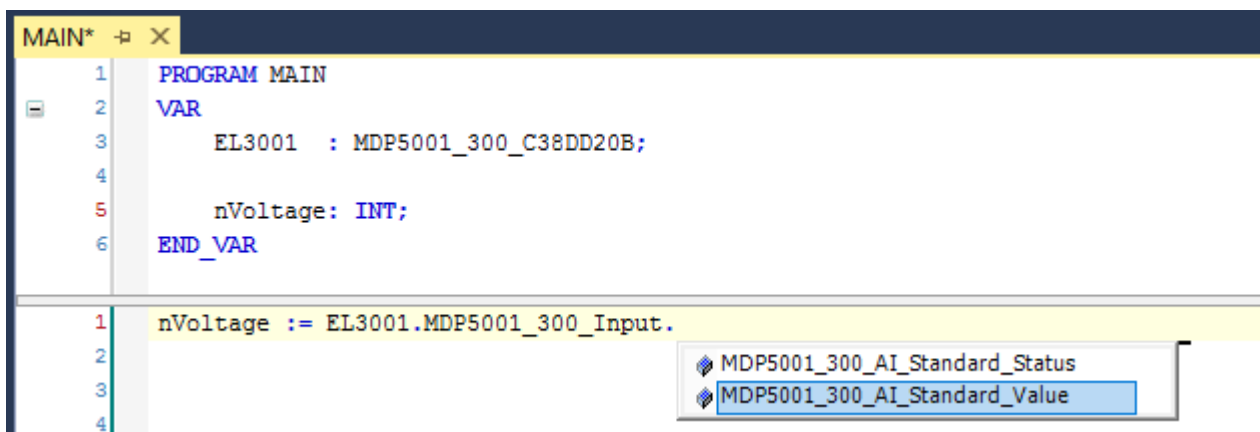

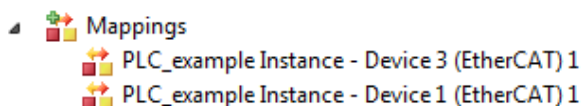

Fig. 110: Reading a variable from the structure of the process data

**Activation of the configuration**

The allocation of PDO to PLC variables has now established the connection from the controller to the inputs

and outputs of the terminals. The configuration can now be activated with  or via the menu under “TwinCAT” in order to transfer the settings of the development environment to the runtime system. Confirm the messages “Old configurations will be overwritten!” and “Restart TwinCAT system in Run mode” with “OK”. The corresponding assignments can be seen in the project folder explorer:



A few seconds later, the corresponding status of the Run mode is displayed in the form of a rotating symbol

 at the bottom right of the VS shell development environment. The PLC system can then be started as described below.

### Starting the controller

Select the menu option “PLC” → “Login” or click on  to link the PLC with the real-time system and load the control program for execution. This results in the message “No program on the controller! Should the new program be loaded?”, which should be acknowledged with “Yes”. The runtime environment is ready for

the program to be started by clicking on symbol , the “F5” key or via “PLC” in the menu, by selecting “Start”. The started programming environment shows the runtime values of individual variables:

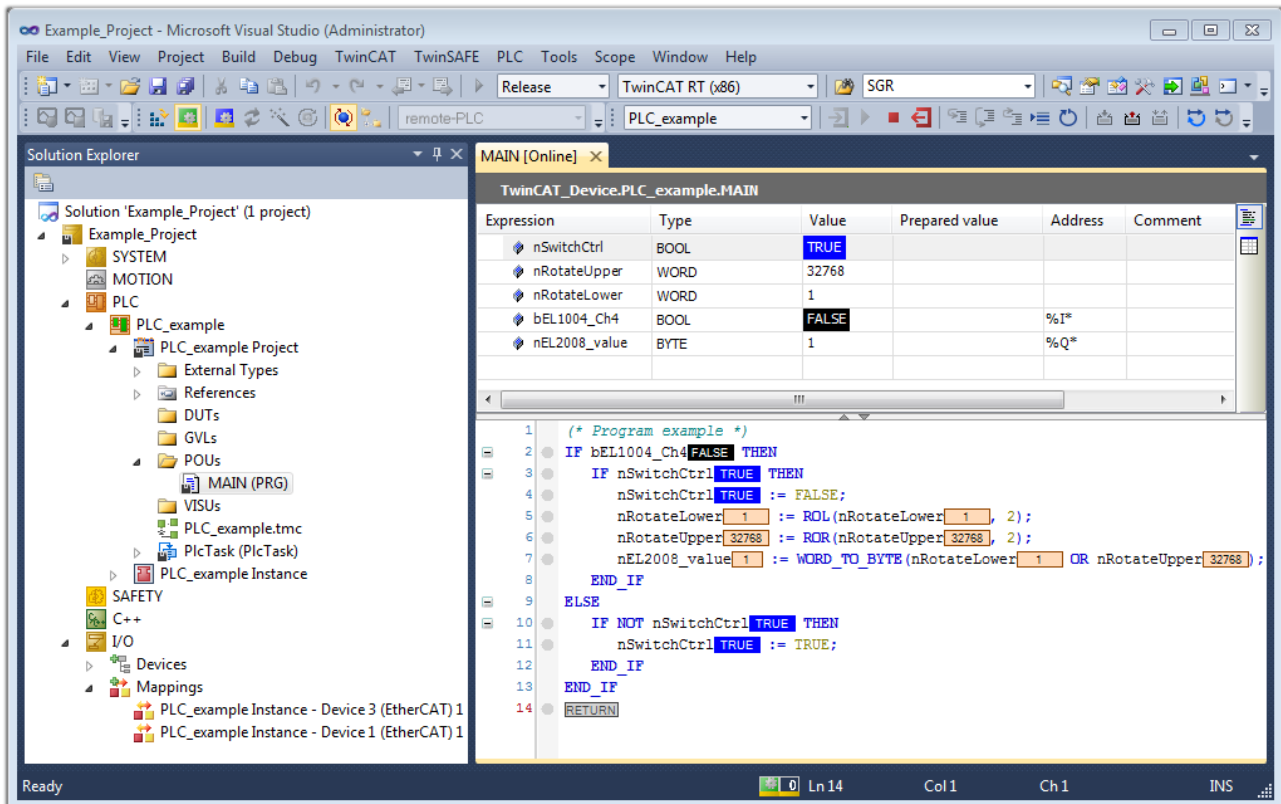



Fig. 111: TwinCAT 3 development environment (VS shell): logged-in, after program startup

The two operator control elements for stopping  and logout  result in the required action (also, “Shift + F5” can be used for stop, or both actions can be selected via the PLC menu).

## 5.3 TwinCAT Development Environment

The Software for automation TwinCAT (The Windows Control and Automation Technology) will be distinguished into:

- TwinCAT 2: System Manager (Configuration) & PLC Control (Programming)
- TwinCAT 3: Enhancement of TwinCAT 2 (Programming and Configuration takes place via a common Development Environment)

### Details:

- **TwinCAT 2:**
  - Connects I/O devices to tasks in a variable-oriented manner
  - Connects tasks to tasks in a variable-oriented manner
  - Supports units at the bit level
  - Supports synchronous or asynchronous relationships
  - Exchange of consistent data areas and process images

- Datalink on NT - Programs by open Microsoft Standards (OLE, OCX, ActiveX, DCOM+, etc.)
- Integration of IEC 61131-3-Software-SPS, Software- NC and Software-CNC within Windows NT/ 2000/XP/Vista, Windows 7, NT/XP Embedded, CE
- Interconnection to all common fieldbusses
- More...

#### Additional features:

- **TwinCAT 3** (eXtended Automation):
  - Visual Studio® integration
  - Choice of the programming language
  - Supports object orientated extension of IEC 61131-3
  - Usage of C/C++ as programming language for real time applications
  - Connection to MATLAB®/Simulink®
  - Open interface for expandability
  - Flexible run-time environment
  - Active support of multi-core- and 64 bit operating system
  - Automatic code generation and project creation with the TwinCAT Automation Interface
  - More...

Within the following sections commissioning of the TwinCAT Development Environment on a PC System for the control and also the basically functions of unique control elements will be explained.

Please see further information to TwinCAT 2 and TwinCAT 3 at <http://infosys.beckhoff.com>.

### 5.3.1 Installation of the TwinCAT real-time driver

In order to assign real-time capability to a standard Ethernet port of an IPC controller, the Beckhoff real-time driver has to be installed on this port under Windows.

This can be done in several ways.

#### A: Via the TwinCAT Adapter dialog

In the System Manager call up the TwinCAT overview of the local network interfaces via Options → Show Real Time Ethernet Compatible Devices.

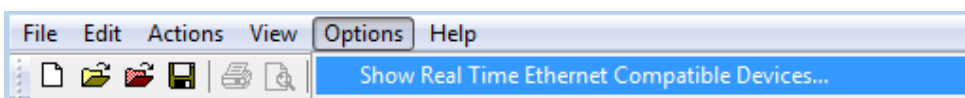

Fig. 112: System Manager “Options” (TwinCAT 2)

This have to be called up by the menu “TwinCAT” within the TwinCAT 3 environment:

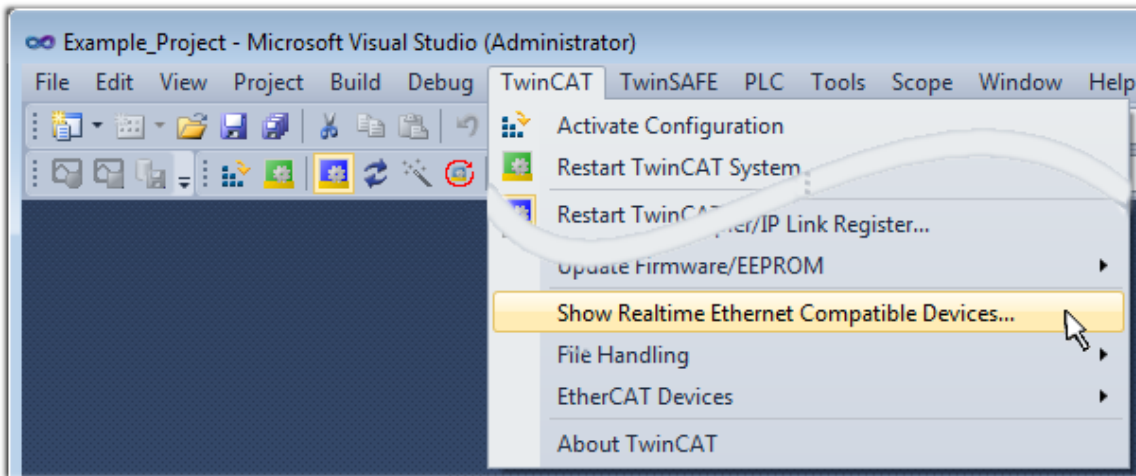

Fig. 113: Call up under VS Shell (TwinCAT 3)

**B: Via TcRtelInstall.exe in the TwinCAT directory**

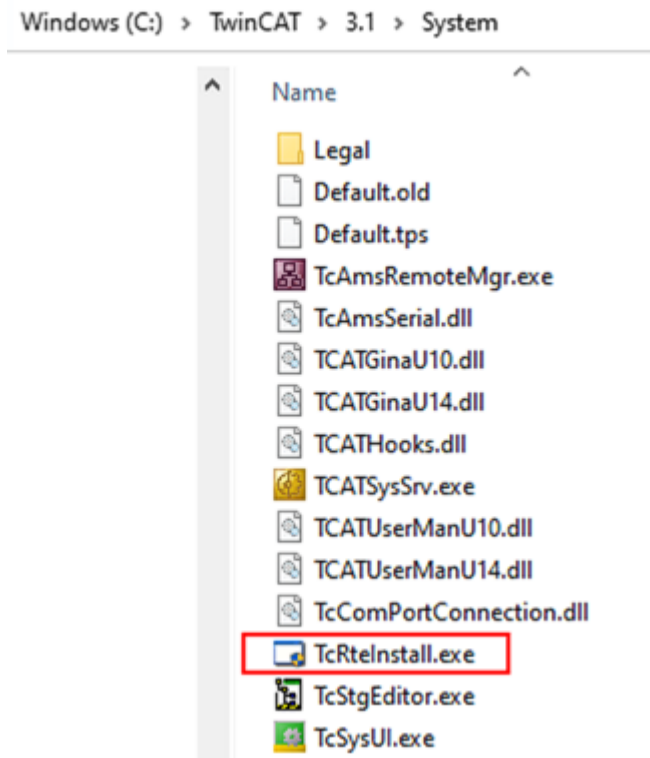

Fig. 114: TcRtelInstall in the TwinCAT directory

In both cases, the following dialog appears:

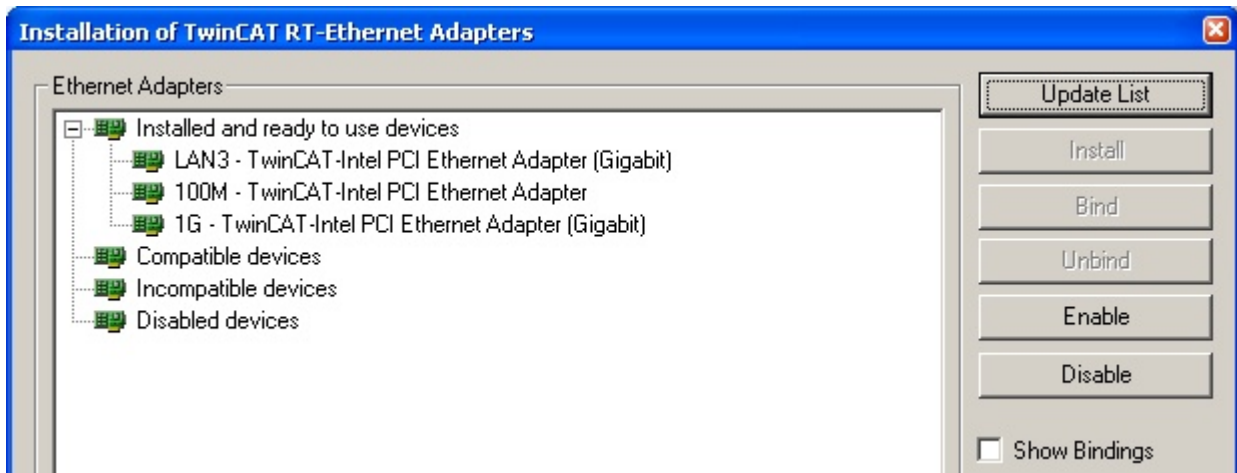

Fig. 115: Overview of network interfaces

Interfaces listed under “Compatible devices” can be assigned a driver via the “Install” button. A driver should only be installed on compatible devices.

A Windows warning regarding the unsigned driver can be ignored.

**Alternatively** an EtherCAT-device can be inserted first of all as described in chapter [Offline configuration creation](#), section “Creating the EtherCAT device” [▶ 179] in order to view the compatible ethernet ports via its EtherCAT properties (tab “Adapter”, button “Compatible Devices...”):



Fig. 116: EtherCAT device properties (TwinCAT 2): click on “Compatible Devices...” of tab “Adapter”

TwinCAT 3: the properties of the EtherCAT device can be opened by double click on “Device .. (EtherCAT)” within the Solution Explorer under “I/O”:



After the installation the driver appears activated in the Windows overview for the network interface (Windows Start → System Properties → Network)

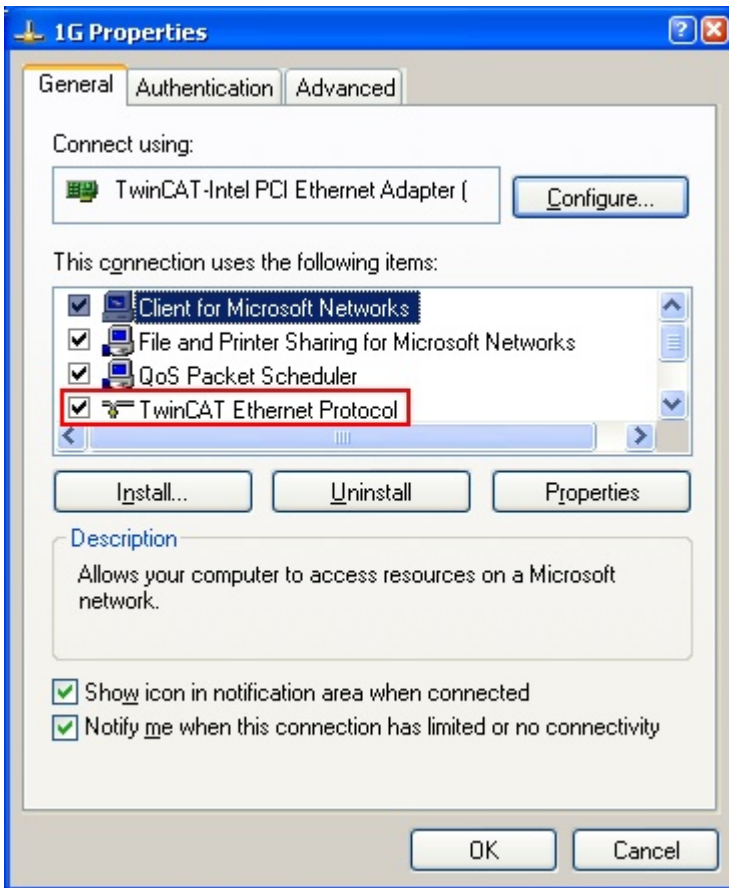

Fig. 117: Windows properties of the network interface

A correct setting of the driver could be:

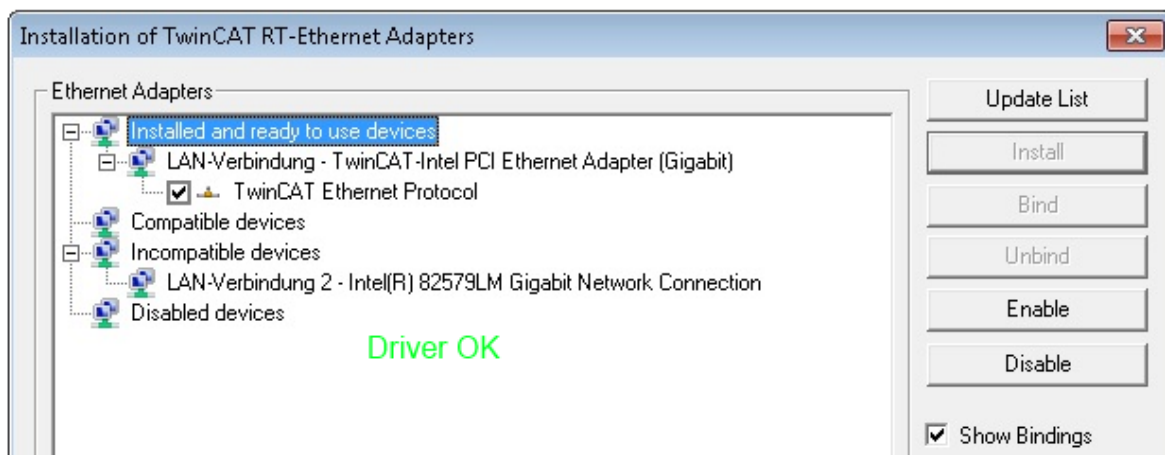

Fig. 118: Exemplary correct driver setting for the Ethernet port

Other possible settings have to be avoided:



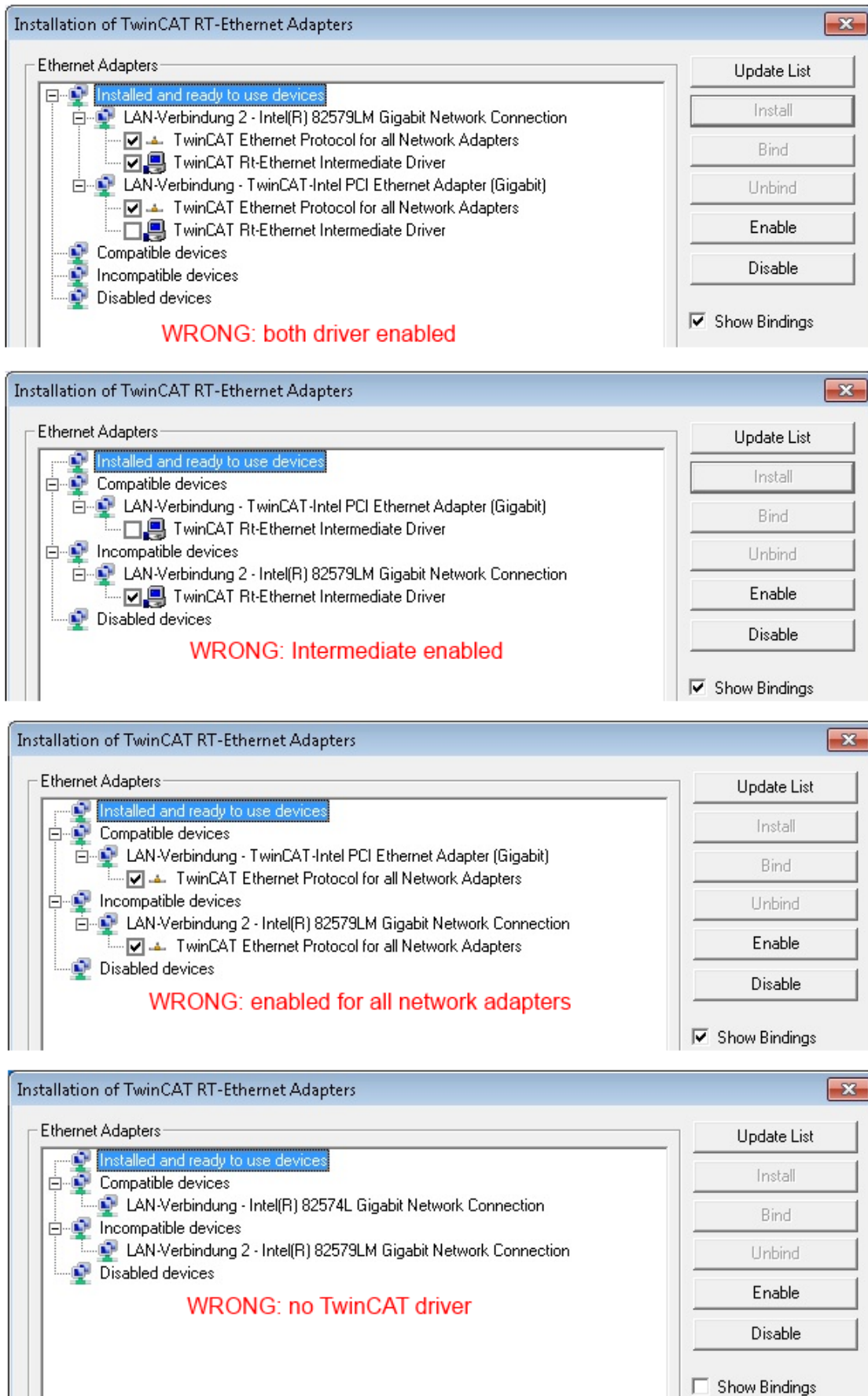

Fig. 119: Incorrect driver settings for the Ethernet port



IP address of the port used

**i** IP address/DHCP

In most cases an Ethernet port that is configured as an EtherCAT device will not transport general IP packets. For this reason and in cases where an EL6601 or similar devices are used it is useful to specify a fixed IP address for this port via the “Internet Protocol TCP/IP” driver setting and to disable DHCP. In this way the delay associated with the DHCP client for the Ethernet port assigning itself a default IP address in the absence of a DHCP server is avoided. A suitable address space is 192.168.x.x, for example.

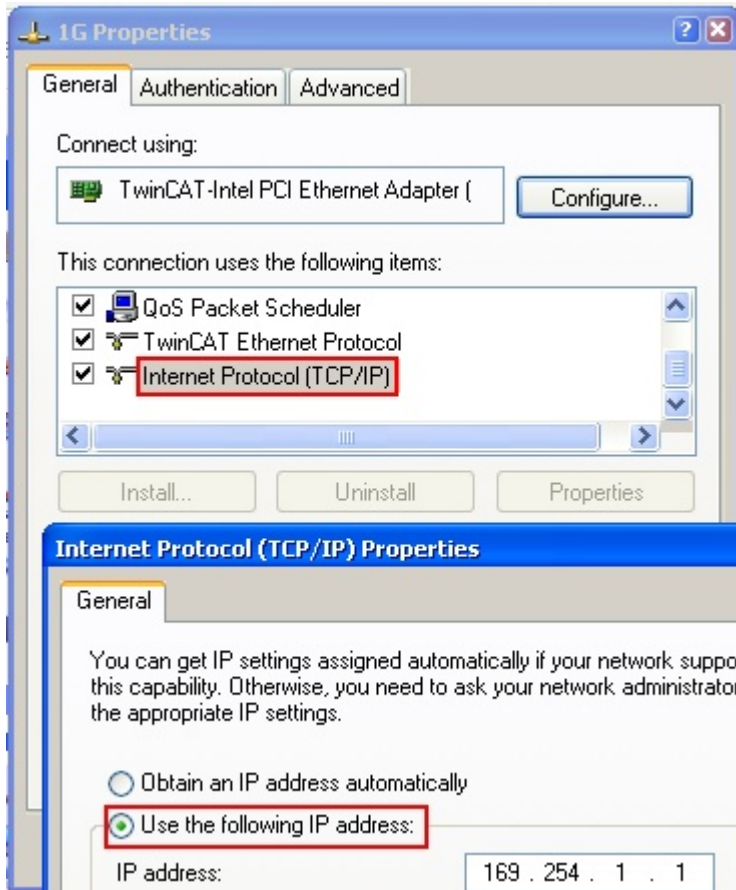

Fig. 120: TCP/IP setting for the Ethernet port

## 5.3.2 Notes regarding ESI device description

### Installation of the latest ESI device description

The TwinCAT EtherCAT master/System Manager needs the device description files for the devices to be used in order to generate the configuration in online or offline mode. The device descriptions are contained in the so-called ESI files (EtherCAT Slave Information) in XML format. These files can be requested from the respective manufacturer and are made available for download. An \*.xml file may contain several device descriptions.

The ESI files for Beckhoff EtherCAT devices are available on the [Beckhoff website](#).

The ESI files should be stored in the TwinCAT installation directory.

Default settings:

- **TwinCAT 2:** C:\TwinCAT\IO\EtherCAT
- **TwinCAT 3:** C:\TwinCAT\3.1\Config\Io\EtherCAT

The files are read (once) when a new System Manager window is opened, if they have changed since the last time the System Manager window was opened.

A TwinCAT installation includes the set of Beckhoff ESI files that was current at the time when the TwinCAT build was created.

For TwinCAT 2.11/TwinCAT 3 and higher, the ESI directory can be updated from the System Manager, if the programming PC is connected to the Internet; by

- **TwinCAT 2:** Option → “Update EtherCAT Device Descriptions”
- **TwinCAT 3:** TwinCAT → EtherCAT Devices → “Update Device Descriptions (via ETG Website)...”

The [TwinCAT ESI Updater \[▶ 178\]](#) is available for this purpose.



### ESI

The \*.xml files are associated with \*.xsd files, which describe the structure of the ESI XML files. To update the ESI device descriptions, both file types should therefore be updated.

### Device differentiation

EtherCAT devices/slaves are distinguished by four properties, which determine the full device identifier. For example, the device identifier EL2521-0025-1018 consists of:

- family key “EL”
- name “2521”
- type “0025”
- and revision “1018”

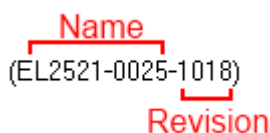

Fig. 121: Identifier structure

The order identifier consisting of name + type (here: EL2521-0010) describes the device function. The revision indicates the technical progress and is managed by Beckhoff. In principle, a device with a higher revision can replace a device with a lower revision, unless specified otherwise, e.g. in the documentation. Each revision has its own ESI description. See [further notes \[▶ 11\]](#).

**Online description**

If the EtherCAT configuration is created online through scanning of real devices (see section Online setup) and no ESI descriptions are available for a slave (specified by name and revision) that was found, the System Manager asks whether the description stored in the device should be used. In any case, the System Manager needs this information for setting up the cyclic and acyclic communication with the slave correctly.

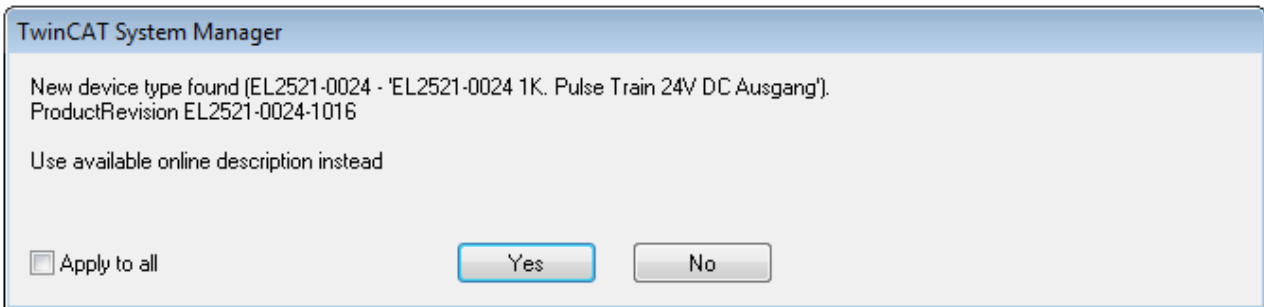

Fig. 122: OnlineDescription information window (TwinCAT 2)

In TwinCAT 3 a similar window appears, which also offers the Web update:

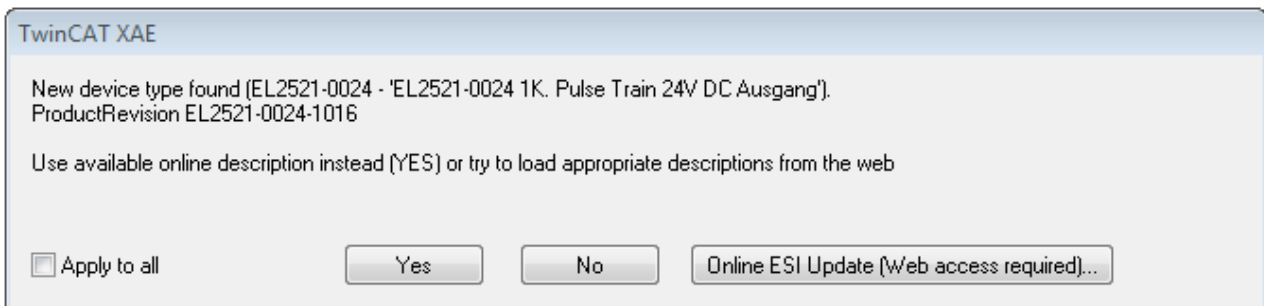

Fig. 123: Information window OnlineDescription (TwinCAT 3)

If possible, the Yes is to be rejected and the required ESI is to be requested from the device manufacturer. After installation of the XML/XSD file the configuration process should be repeated.

**NOTICE**

**Changing the “usual” configuration through a scan**

- ✓ If a scan discovers a device that is not yet known to TwinCAT, distinction has to be made between two cases. Taking the example here of the EL2521-0000 in the revision 1019
  - a) no ESI is present for the EL2521-0000 device at all, either for the revision 1019 or for an older revision. The ESI must then be requested from the manufacturer (in this case Beckhoff).
  - b) an ESI is present for the EL2521-0000 device, but only in an older revision, e.g. 1018 or 1017. In this case an in-house check should first be performed to determine whether the spare parts stock allows the integration of the increased revision into the configuration at all. A new/higher revision usually also brings along new features. If these are not to be used, work can continue without reservations with the previous revision 1018 in the configuration. This is also stated by the Beckhoff compatibility rule.

Refer in particular to the chapter “General notes on the use of Beckhoff EtherCAT IO components” and for manual configuration to the chapter “Offline configuration creation [▶ 179]”.

If the OnlineDescription is used regardless, the System Manager reads a copy of the device description from the EEPROM in the EtherCAT slave. In complex slaves the size of the EEPROM may not be sufficient for the complete ESI, in which case the ESI would be *incomplete* in the configurator. Therefore it’s recommended using an offline ESI file with priority in such a case.

The System Manager creates for online recorded device descriptions a new file “OnlineDescription0000...xml” in its ESI directory, which contains all ESI descriptions that were read online.

OnlineDescriptionCache00000002.xml

Fig. 124: File OnlineDescription.xml created by the System Manager

If a slave desired to be added manually to the configuration at a later stage, online created slaves are indicated by a prepended symbol ">" in the selection list (see Figure *Indication of an online recorded ESI of EL2521 as an example*).

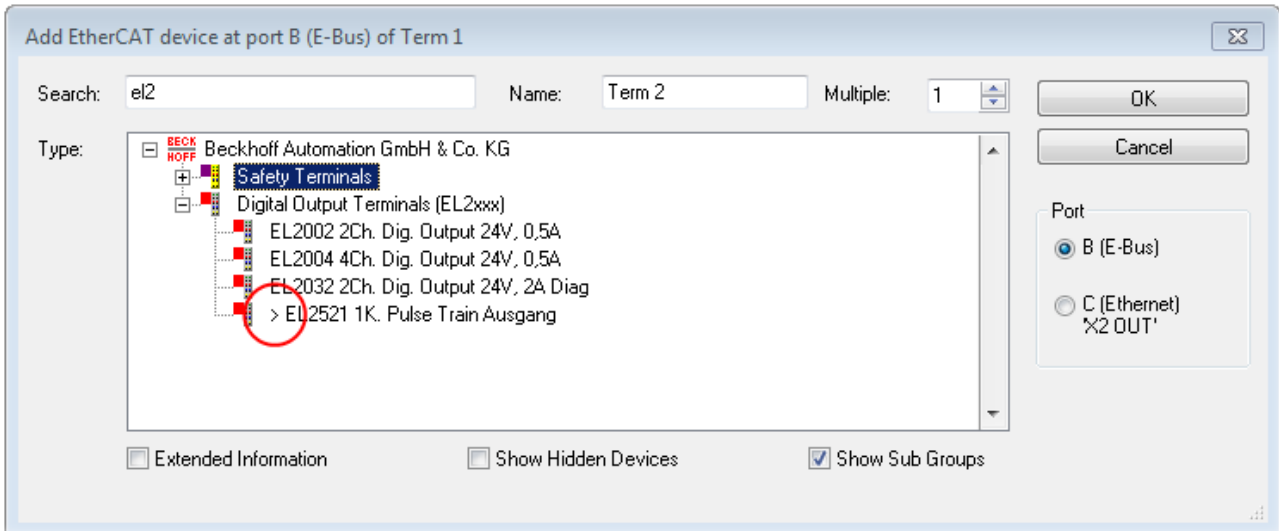

Fig. 125: Indication of an online recorded ESI of EL2521 as an example

If such ESI files are used and the manufacturer's files become available later, the file OnlineDescription.xml should be deleted as follows:

- close all System Manager windows
- restart TwinCAT in Config mode
- delete "OnlineDescription0000...xml"
- restart TwinCAT System Manager

This file should not be visible after this procedure, if necessary press <F5> to update

### **i** OnlineDescription for TwinCAT 3.x

In addition to the file described above "OnlineDescription0000...xml", a so called EtherCAT cache with new discovered devices is created by TwinCAT 3.x, e.g. under Windows 7:

`C:\User\[USERNAME]\AppData\Roaming\Beckhoff\TwinCAT3\Components\Base\EtherCATCache.xml`

(Please note the language settings of the OS!)

You have to delete this file, too.

### Faulty ESI file

If an ESI file is faulty and the System Manager is unable to read it, the System Manager brings up an information window.

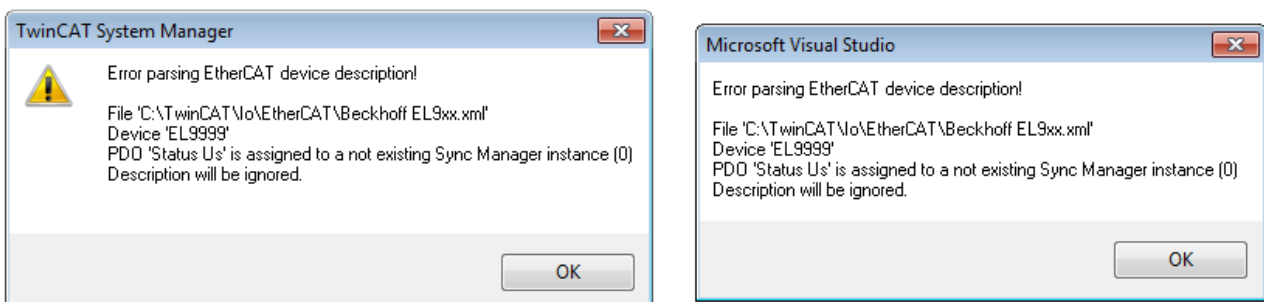

Fig. 126: Information window for faulty ESI file (left: TwinCAT 2; right: TwinCAT 3)

Reasons may include:

- Structure of the \*.xml does not correspond to the associated \*.xsd file → check your schematics
- Contents cannot be translated into a device description → contact the file manufacturer

### 5.3.3 TwinCAT ESI Updater

For TwinCAT 2.11 and higher, the System Manager can search for current Beckhoff ESI files automatically, if an online connection is available:

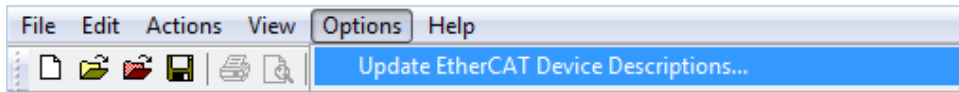

Fig. 127: Using the ESI Updater (>= TwinCAT 2.11)

The call up takes place under:  
“Options” → “Update EtherCAT Device Descriptions”

Selection under TwinCAT 3:

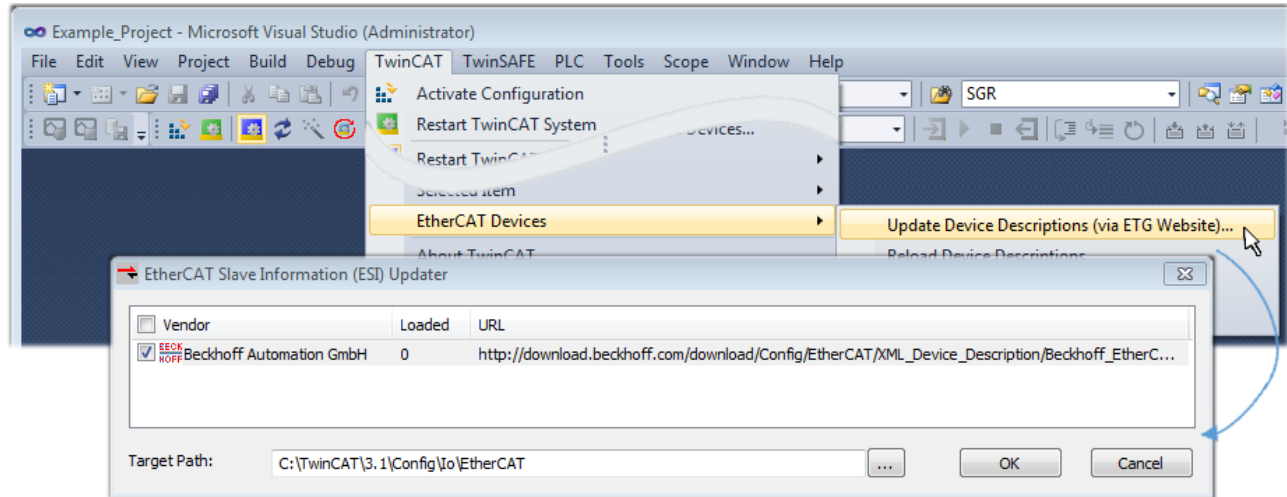

Fig. 128: Using the ESI Updater (TwinCAT 3)

The ESI Updater (TwinCAT 3) is a convenient option for automatic downloading of ESI data provided by EtherCAT manufacturers via the Internet into the TwinCAT directory (ESI = EtherCAT slave information). TwinCAT accesses the central ESI ULR directory list stored at ETG; the entries can then be viewed in the Updater dialog, although they cannot be changed there.

The call up takes place under:  
“TwinCAT” → “EtherCAT Devices” → “Update Device Description (via ETG Website)...”.

### 5.3.4 Distinction between Online and Offline

The distinction between online and offline refers to the presence of the actual I/O environment (drives, terminals, EJ-modules). If the configuration is to be prepared in advance of the system configuration as a programming system, e.g. on a laptop, this is only possible in “Offline configuration” mode. In this case all components have to be entered manually in the configuration, e.g. based on the electrical design.

If the designed control system is already connected to the EtherCAT system and all components are energised and the infrastructure is ready for operation, the TwinCAT configuration can simply be generated through “scanning” from the runtime system. This is referred to as online configuration.

In any case, during each startup the EtherCAT master checks whether the slaves it finds match the configuration. This test can be parameterised in the extended slave settings. Refer to [note “Installation of the latest ESI-XML device description” \[▶ 174\]](#).

#### For preparation of a configuration:

- the real EtherCAT hardware (devices, couplers, drives) must be present and installed
- the devices/modules must be connected via EtherCAT cables or in the terminal/ module strand in the same way as they are intended to be used later
- the devices/modules be connected to the power supply and ready for communication

- TwinCAT must be in CONFIG mode on the target system.

**The online scan process consists of:**

- detecting the EtherCAT device [▶ 184] (Ethernet port at the IPC)
- detecting the connected EtherCAT devices [▶ 185]. This step can be carried out independent of the preceding step
- troubleshooting [▶ 188]

The scan with existing configuration [▶ 189] can also be carried out for comparison.

### 5.3.5 OFFLINE configuration creation

**Creating the EtherCAT device**

Create an EtherCAT device in an empty System Manager window.

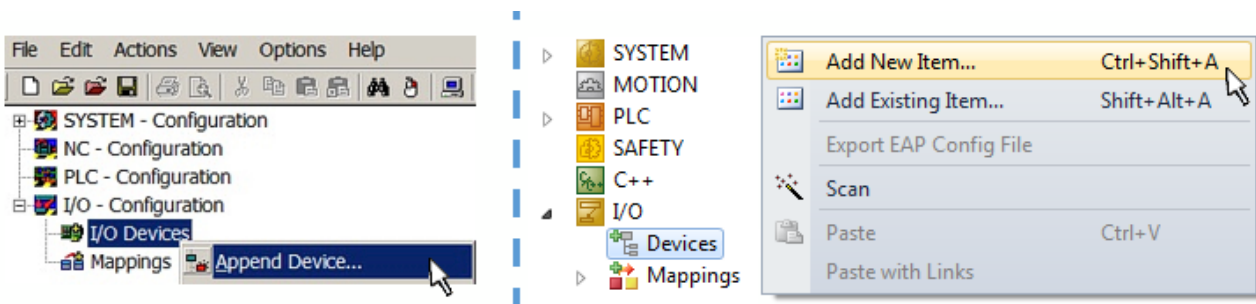

Fig. 129: Append EtherCAT device (left: TwinCAT 2; right: TwinCAT 3)

Select type “EtherCAT” for an EtherCAT I/O application with EtherCAT slaves. For the present publisher/ subscriber service in combination with an EL6601/EL6614 terminal select “EtherCAT Automation Protocol via EL6601”.

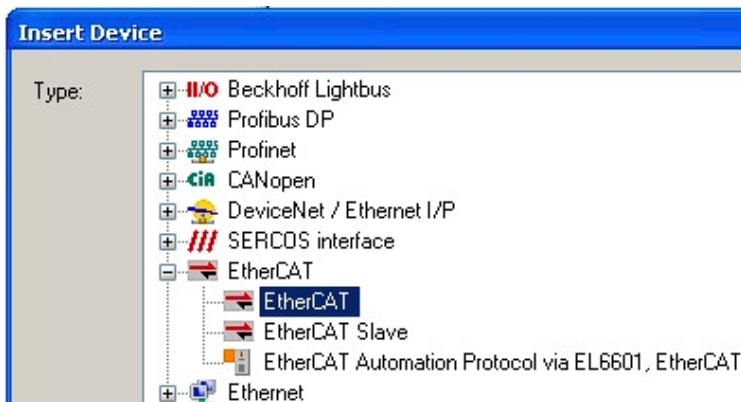

Fig. 130: Selecting the EtherCAT connection (TwinCAT 2.11, TwinCAT 3)

Then assign a real Ethernet port to this virtual device in the runtime system.

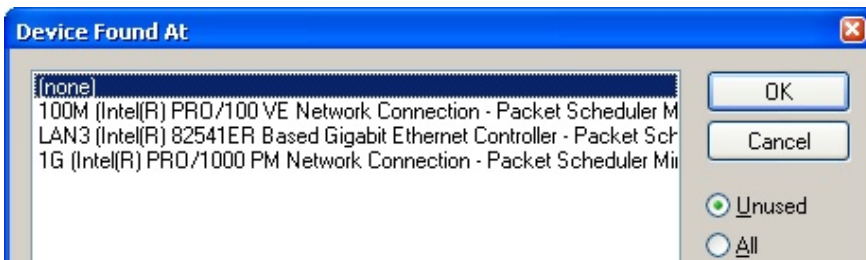

Fig. 131: Selecting the Ethernet port



This query may appear automatically when the EtherCAT device is created, or the assignment can be set/modified later in the properties dialog; see Fig. “EtherCAT device properties (TwinCAT 2)”.

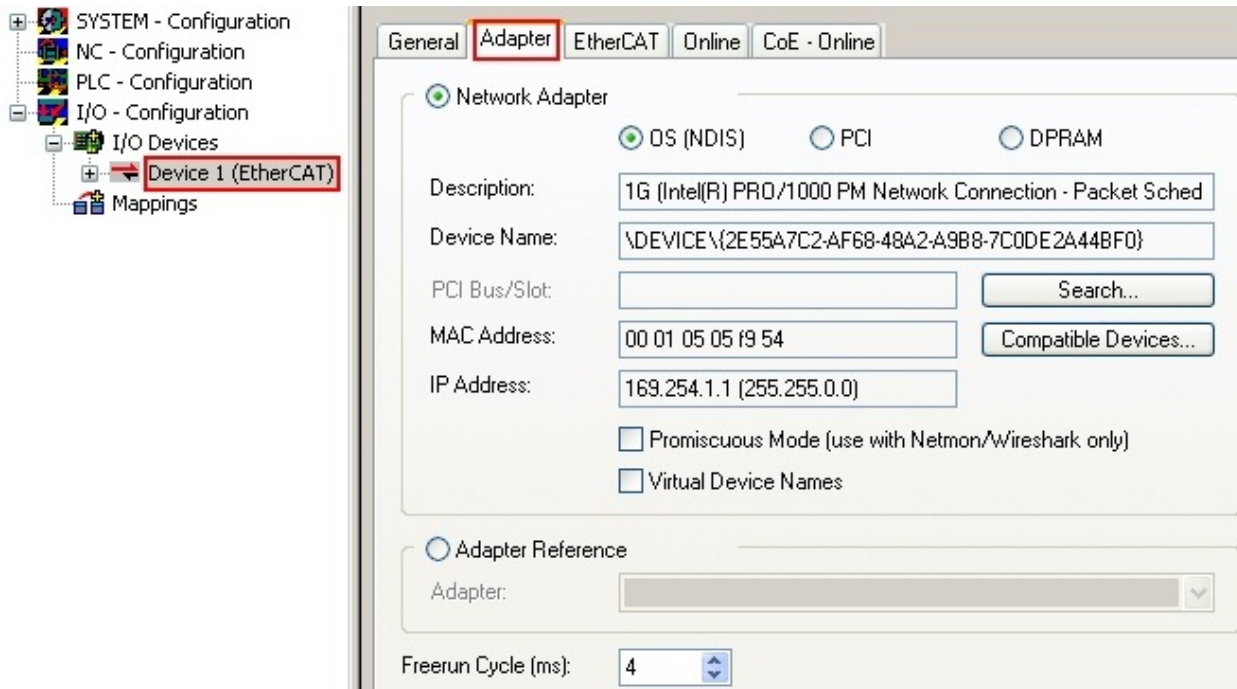
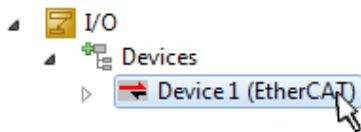

Fig. 132: EtherCAT device properties (TwinCAT 2)

TwinCAT 3: the properties of the EtherCAT device can be opened by double click on “Device .. (EtherCAT)” within the Solution Explorer under “I/O”:



**i** **Selecting the Ethernet port**

Ethernet ports can only be selected for EtherCAT devices for which the TwinCAT real-time driver is installed. This has to be done separately for each port. Please refer to the respective [installation page \[p. 168\]](#).

**Defining EtherCAT slaves**

Further devices can be appended by right-clicking on a device in the configuration tree.

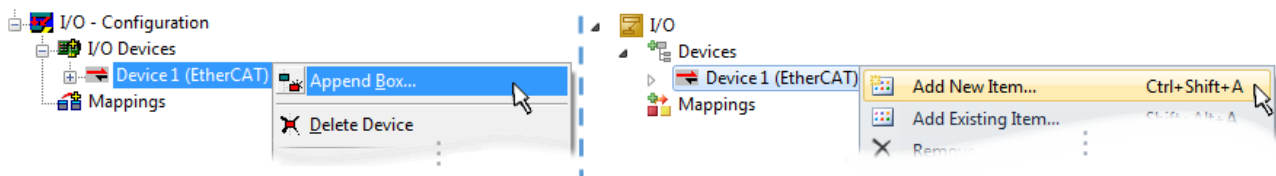

Fig. 133: Appending EtherCAT devices (left: TwinCAT 2; right: TwinCAT 3)

The dialog for selecting a new device opens. Only devices for which ESI files are available are displayed.

Only devices are offered for selection that can be appended to the previously selected device. Therefore, the physical layer available for this port is also displayed (Fig. “Selection dialog for new EtherCAT device”, A). In the case of cable-based Fast-Ethernet physical layer with PHY transfer, then also only cable-based devices are available, as shown in Fig. “Selection dialog for new EtherCAT device”. If the preceding device has several free ports (e.g. EK1122 or EK1100), the required port can be selected on the right-hand side (A).

Overview of physical layer

- “Ethernet”: cable-based 100BASE-TX: couplers, box modules, devices with RJ45/M8/M12 connector



- “E-Bus”: LVDS “terminal bus”, EtherCAT plug-in modules (EJ), EtherCAT terminals (EL/ES), various modular modules

The search field facilitates finding specific devices (since TwinCAT 2.11 or TwinCAT 3).

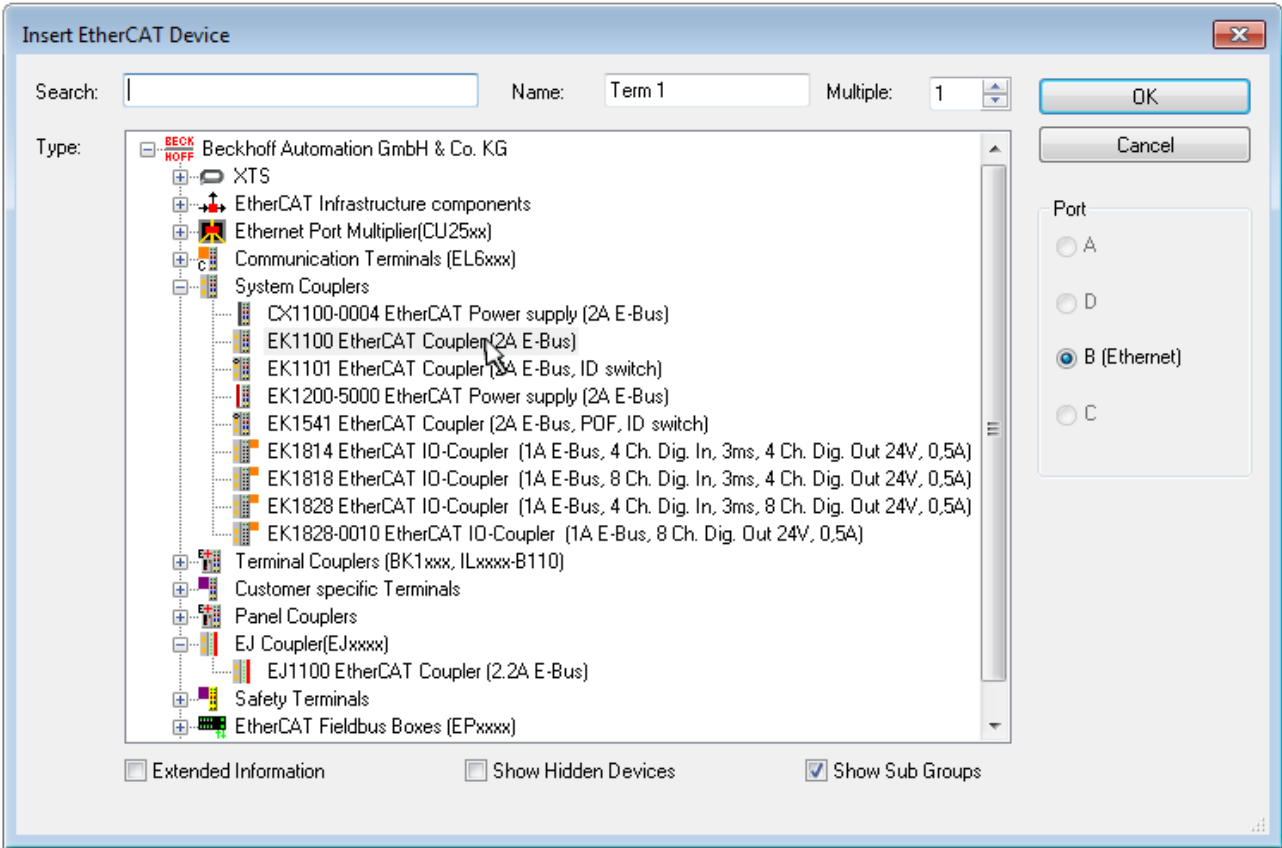

Fig. 134: Selection dialog for new EtherCAT device

By default, only the name/device type is used as selection criterion. For selecting a specific revision of the device, the revision can be displayed as “Extended Information”.

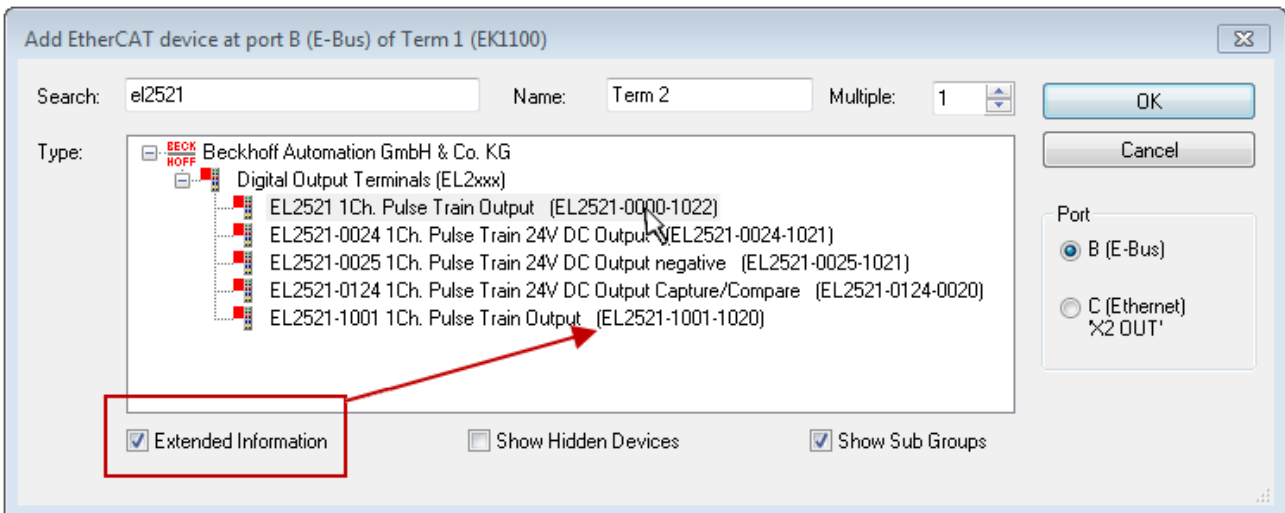

Fig. 135: Display of device revision

In many cases several device revisions were created for historic or functional reasons, e.g. through technological advancement. For simplification purposes (see Fig. “Selection dialog for new EtherCAT device”) only the last (i.e. highest) revision and therefore the latest state of production is displayed in the selection dialog for Beckhoff devices. To show all device revisions available in the system as ESI descriptions tick the “Show Hidden Devices” check box, see Fig. “Display of previous revisions”.

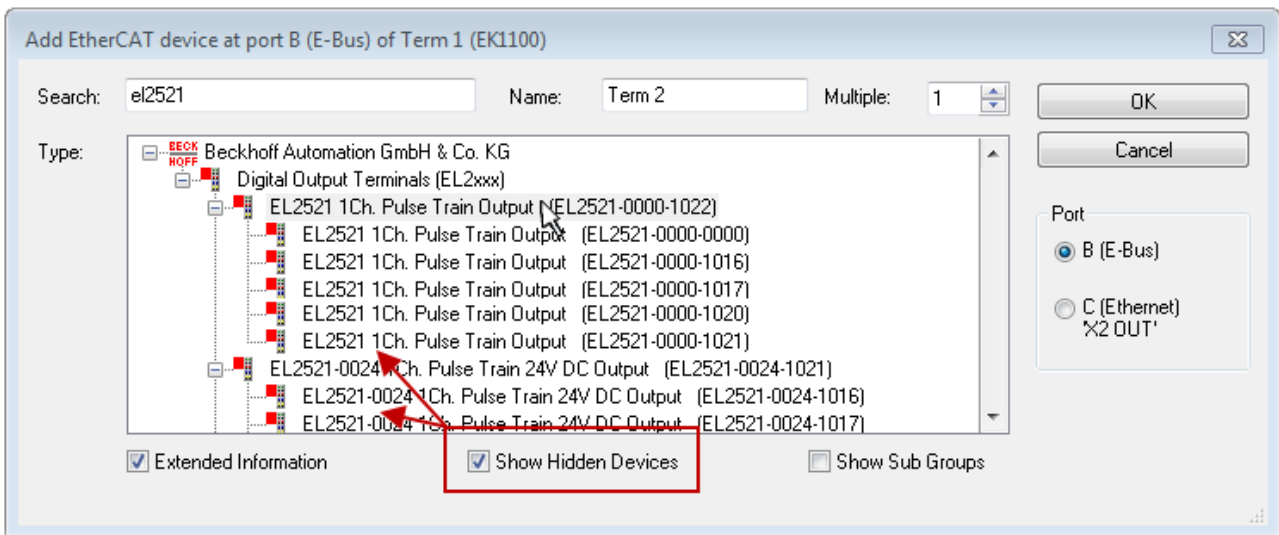

Fig. 136: Display of previous revisions

**i** **Device selection based on revision, compatibility**

The ESI description also defines the process image, the communication type between master and slave/device and the device functions, if applicable. The physical device (firmware, if available) has to support the communication queries/settings of the master. This is backward compatible, i.e. newer devices (higher revision) should be supported if the EtherCAT master addresses them as an older revision. The following compatibility rule of thumb is to be assumed for Beckhoff EtherCAT Terminals/ Boxes/ EJ-modules:

**device revision in the system >= device revision in the configuration**

This also enables subsequent replacement of devices without changing the configuration (different specifications are possible for drives).

**Example**

If an EL2521-0025-**1018** is specified in the configuration, an EL2521-0025-**1018** or higher (**-1019**, **-1020**) can be used in practice.

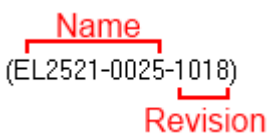

Fig. 137: Name/revision of the terminal

If current ESI descriptions are available in the TwinCAT system, the last revision offered in the selection dialog matches the Beckhoff state of production. It is recommended to use the last device revision when creating a new configuration, if current Beckhoff devices are used in the real application. Older revisions should only be used if older devices from stock are to be used in the application.

In this case the process image of the device is shown in the configuration tree and can be parameterized as follows: linking with the task, CoE/DC settings, plug-in definition, startup settings, ...

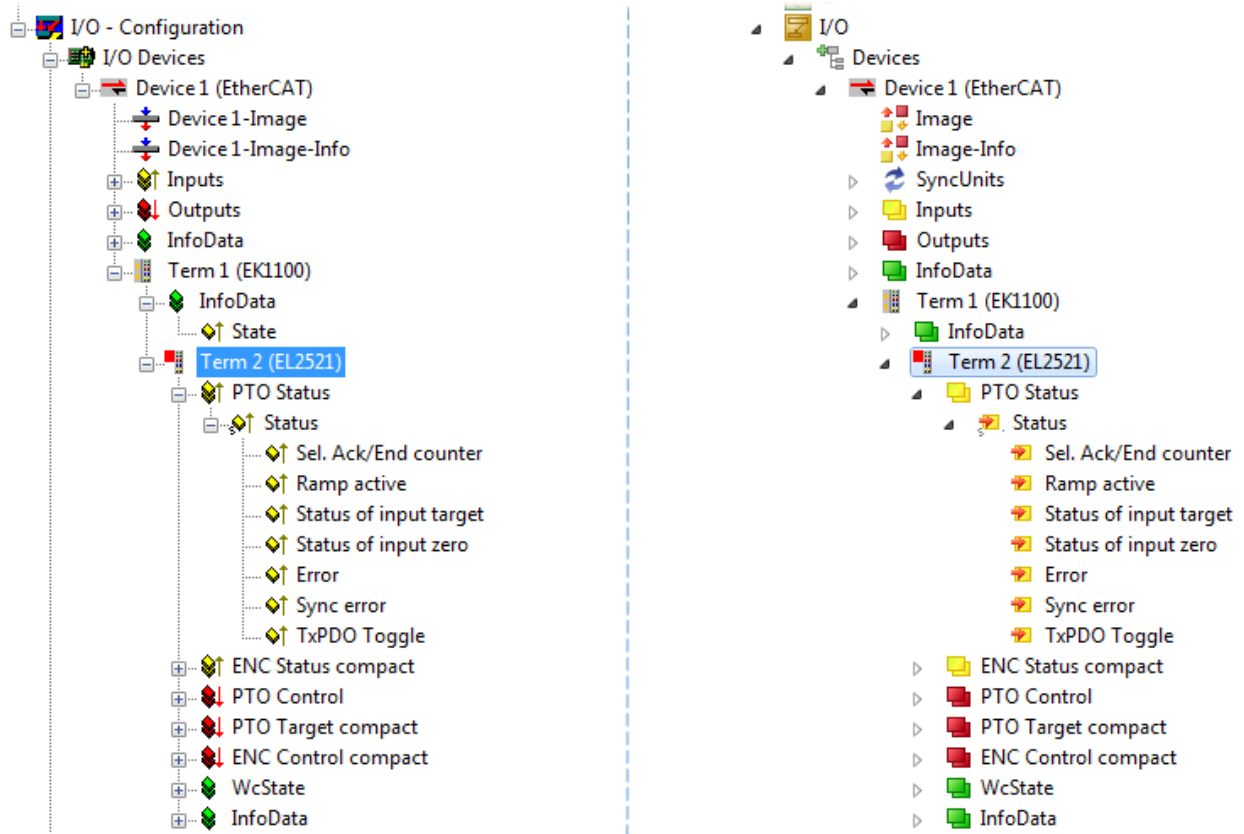



Fig. 138: EtherCAT terminal in the TwinCAT tree (left: TwinCAT 2; right: TwinCAT 3)



### 5.3.6 ONLINE configuration creation

#### Detecting/scanning of the EtherCAT device

The online device search can be used if the TwinCAT system is in CONFIG mode. This can be indicated by a symbol right below in the information bar:



- on TwinCAT 2 by a blue display “Config Mode” within the System Manager window:  .
- on TwinCAT 3 within the user interface of the development environment by a symbol  .

TwinCAT can be set into this mode:

- TwinCAT 2: by selection of  in the Menubar or by “Actions” → “Set/Reset TwinCAT to Config Mode...”
- TwinCAT 3: by selection of  in the Menubar or by “TwinCAT” → “Restart TwinCAT (Config Mode)”

#### ● Online scanning in Config mode

**i** The online search is not available in RUN mode (production operation). Note the differentiation between TwinCAT programming system and TwinCAT target system.

The TwinCAT 2 icon () or TwinCAT 3 icon () within the Windows-Taskbar always shows the TwinCAT mode of the local IPC. Compared to that, the System Manager window of TwinCAT 2 or the user interface of TwinCAT 3 indicates the state of the target system.

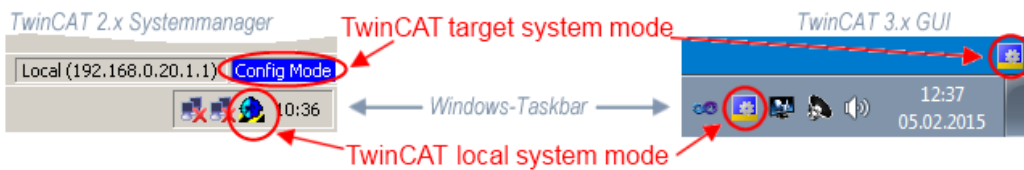

Fig. 139: Differentiation local/target system (left: TwinCAT 2; right: TwinCAT 3)

Right-clicking on “I/O Devices” in the configuration tree opens the search dialog.

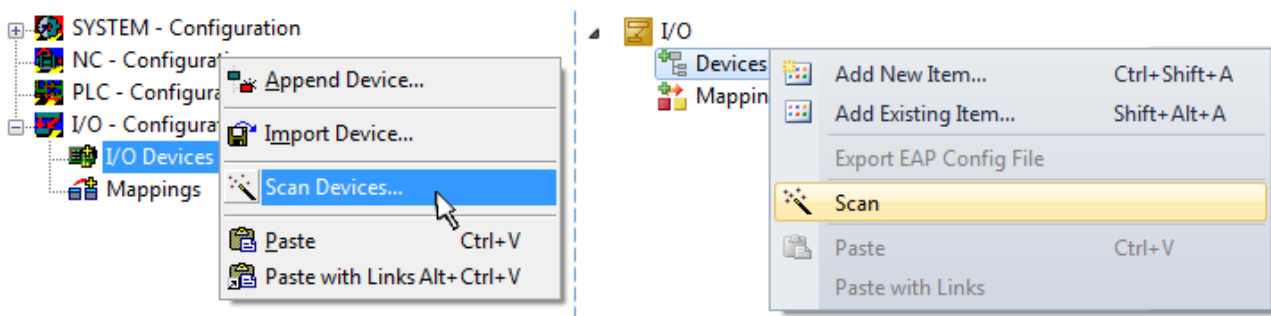

Fig. 140: Scan Devices (left: TwinCAT 2; right: TwinCAT 3)

This scan mode attempts to find not only EtherCAT devices (or Ethernet ports that are usable as such), but also NOVRAM, fieldbus cards, SMB etc. However, not all devices can be found automatically.

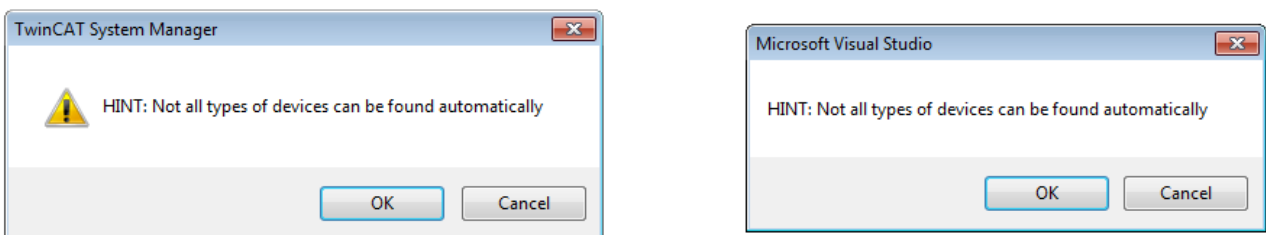

Fig. 141: Note for automatic device scan (left: TwinCAT 2; right: TwinCAT 3)

Ethernet ports with installed TwinCAT real-time driver are shown as “RT Ethernet” devices. An EtherCAT frame is sent to these ports for testing purposes. If the scan agent detects from the response that an EtherCAT slave is connected, the port is immediately shown as an “EtherCAT Device” .

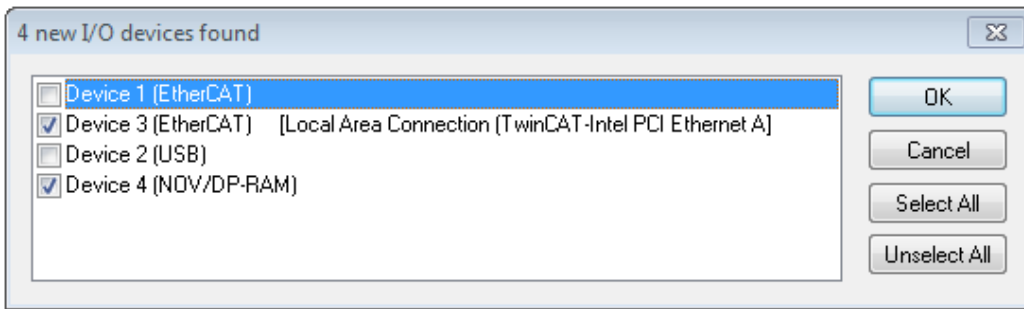

Fig. 142: Detected Ethernet devices

Via respective checkboxes devices can be selected (as illustrated in Fig. “Detected Ethernet devices” e.g. Device 3 and Device 4 were chosen). After confirmation with “OK” a device scan is suggested for all selected devices, see Fig.: “Scan query after automatic creation of an EtherCAT device”.

**● Selecting the Ethernet port**



Ethernet ports can only be selected for EtherCAT devices for which the TwinCAT real-time driver is installed. This has to be done separately for each port. Please refer to the respective [installation page](#) [▶ 168].

**Detecting/Scanning the EtherCAT devices**

**● Online scan functionality**



During a scan the master queries the identity information of the EtherCAT slaves from the slave EEPROM. The name and revision are used for determining the type. The respective devices are located in the stored ESI data and integrated in the configuration tree in the default state defined there.

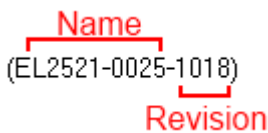

Fig. 143: Example default state

**NOTICE**

**Slave scanning in practice in series machine production**

The scanning function should be used with care. It is a practical and fast tool for creating an initial configuration as a basis for commissioning. In series machine production or reproduction of the plant, however, the function should no longer be used for the creation of the configuration, but if necessary for [comparison](#) [▶ 189] with the defined initial configuration. Background: since Beckhoff occasionally increases the revision version of the delivered products for product maintenance reasons, a configuration can be created by such a scan which (with an identical machine construction) is identical according to the device list; however, the respective device revision may differ from the initial configuration.

**Example:**

Company A builds the prototype of a machine B, which is to be produced in series later on. To do this the prototype is built, a scan of the IO devices is performed in TwinCAT and the initial configuration “B.tsm” is created. The EL2521-0025 EtherCAT terminal with the revision 1018 is located somewhere. It is thus built into the TwinCAT configuration in this way:

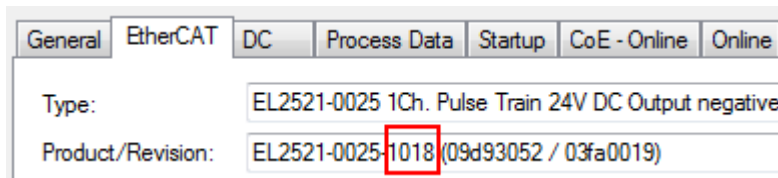

Fig. 144: Installing EtherCAT terminal with revision -1018

Likewise, during the prototype test phase, the functions and properties of this terminal are tested by the programmers/commissioning engineers and used if necessary, i.e. addressed from the PLC “B.pro” or the NC. (the same applies correspondingly to the TwinCAT 3 solution files).

The prototype development is now completed and series production of machine B starts, for which Beckhoff continues to supply the EL2521-0025-0018. If the commissioning engineers of the series machine production department always carry out a scan, a B configuration with the identical contents results again for each machine. Likewise, A might create spare parts stores worldwide for the coming series-produced machines with EL2521-0025-1018 terminals.

After some time Beckhoff extends the EL2521-0025 by a new feature C. Therefore the FW is changed, outwardly recognizable by a higher FW version and a **new revision -1019**. Nevertheless the new device naturally supports functions and interfaces of the predecessor version(s); an adaptation of “B.tsm” or even “B.pro” is therefore unnecessary. The series-produced machines can continue to be built with “B.tsm” and “B.pro”; it makes sense to perform a comparative scan [► 189] against the initial configuration “B.tsm” in order to check the built machine.

However, if the series machine production department now doesn't use “B.tsm”, but instead carries out a scan to create the productive configuration, the revision **-1019** is automatically detected and built into the configuration:

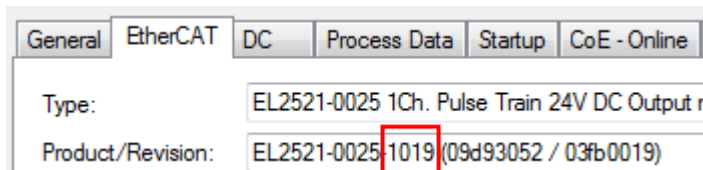

Fig. 145: Detection of EtherCAT terminal with revision -1019

This is usually not noticed by the commissioning engineers. TwinCAT cannot signal anything either, since a new configuration is essentially created. According to the compatibility rule, however, this means that no EL2521-0025-**1018** should be built into this machine as a spare part (even if this nevertheless works in the vast majority of cases).

In addition, it could be the case that, due to the development accompanying production in company A, the new feature C of the EL2521-0025-1019 (for example, an improved analog filter or an additional process data for the diagnosis) is discovered and used without in-house consultation. The previous stock of spare part devices are then no longer to be used for the new configuration “B2.tsm” created in this way. If series machine production is established, the scan should only be performed for informative purposes for comparison with a defined initial configuration. Changes are to be made with care!

If an EtherCAT device was created in the configuration (manually or through a scan), the I/O field can be scanned for devices/slaves.



Fig. 146: Scan query after automatic creation of an EtherCAT device (left: TwinCAT 2; right: TwinCAT 3)

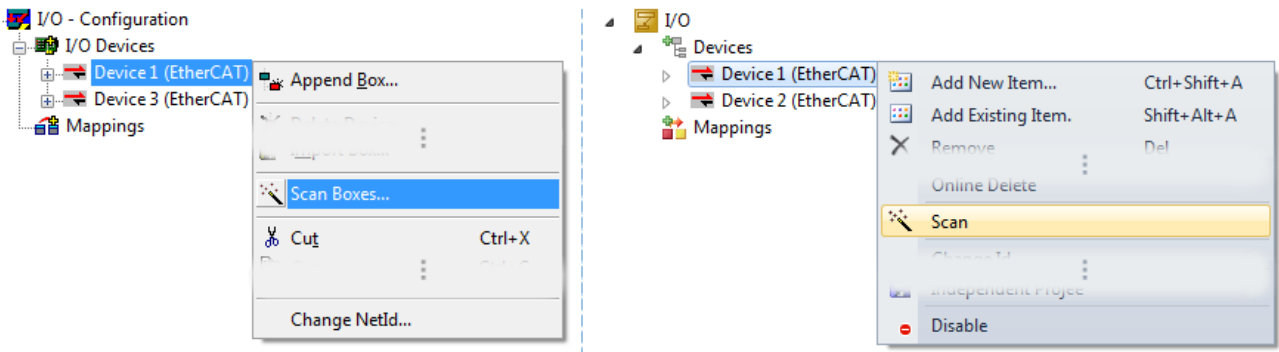

Fig. 147: Manual triggering of a device scan on a specified EtherCAT device (left: TwinCAT 2; right: TwinCAT 3)

In the System Manager (TwinCAT 2) or the User Interface (TwinCAT 3) the scan process can be monitored via the progress bar at the bottom in the status bar.

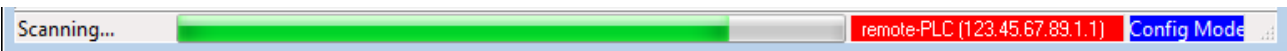

Fig. 148: Scan progress example by TwinCAT 2

The configuration is established and can then be switched to online state (OPERATIONAL).



Fig. 149: Config/FreeRun query (left: TwinCAT 2; right: TwinCAT 3)

In Config/FreeRun mode the System Manager display alternates between blue and red, and the EtherCAT device continues to operate with the idling cycle time of 4 ms (default setting), even without active task (NC, PLC).



Fig. 150: Displaying of “Free Run” and “Config Mode” toggling right below in the status bar



Fig. 151: TwinCAT can also be switched to this state by using a button (left: TwinCAT 2; right: TwinCAT 3)

The EtherCAT system should then be in a functional cyclic state, as shown in Fig. *Online display example*.



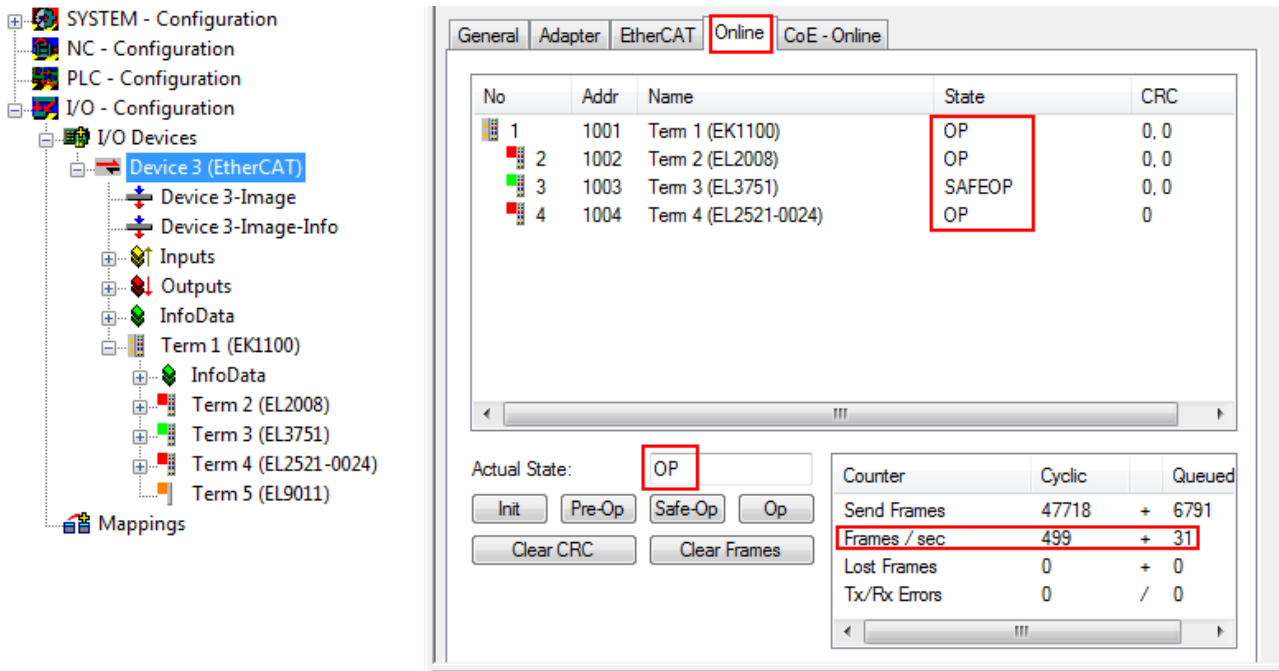

Fig. 152: Online display example

Please note:

- all slaves should be in OP state
- the EtherCAT master should be in “Actual State” OP
- “frames/sec” should match the cycle time taking into account the sent number of frames
- no excessive “LostFrames” or CRC errors should occur

The configuration is now complete. It can be modified as described under [manual procedure \[► 179\]](#).

### Troubleshooting

Various effects may occur during scanning.

- An **unknown device** is detected, i.e. an EtherCAT slave for which no ESI XML description is available. In this case the System Manager offers to read any ESI that may be stored in the device. This case is described in the chapter “Notes regarding ESI device description”.

- **Device are not detected properly**

Possible reasons include:

- faulty data links, resulting in data loss during the scan
- slave has invalid device description

The connections and devices should be checked in a targeted manner, e.g. via the emergency scan.

Then re-run the scan.

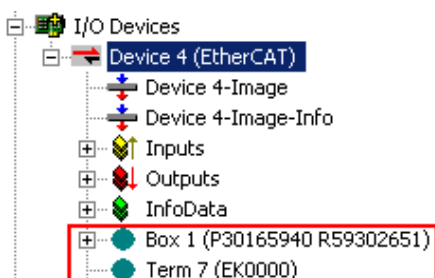

Fig. 153: Faulty identification

In the System Manager such devices may be set up as EK0000 or unknown devices. Operation is not possible or meaningful.



Scan over existing Configuration

**NOTICE**

**Change of the configuration after comparison**

With this scan (TwinCAT 2.11 or 3.1) only the device properties vendor (manufacturer), device name and revision are compared at present! A “ChangeTo” or “Copy” should only be carried out with care, taking into consideration the Beckhoff IO compatibility rule (see above). The device configuration is then replaced by the revision found; this can affect the supported process data and functions.

If a scan is initiated for an existing configuration, the actual I/O environment may match the configuration exactly or it may differ. This enables the configuration to be compared.



Fig. 154: Identical configuration (left: TwinCAT 2; right: TwinCAT 3)

If differences are detected, they are shown in the correction dialog, so that the user can modify the configuration as required.

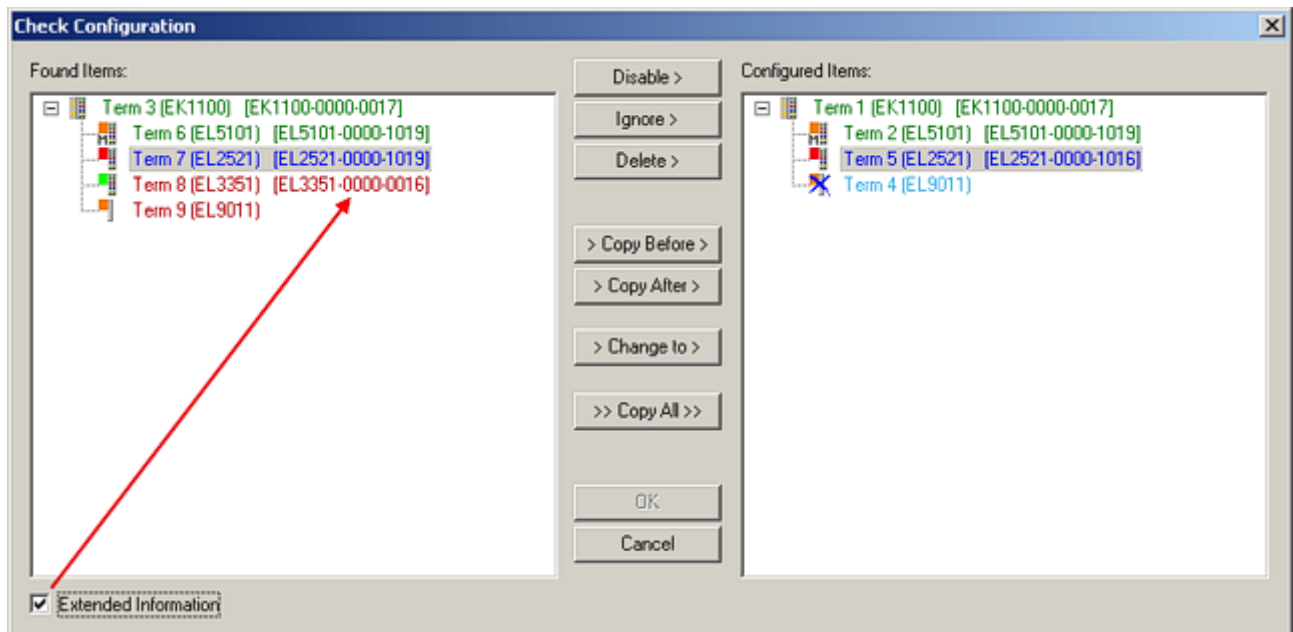

Fig. 155: Correction dialog

It is advisable to tick the “Extended Information” check box to reveal differences in the revision.

Color	Explanation
green	This EtherCAT slave matches the entry on the other side. Both type and revision match.
blue	This EtherCAT slave is present on the other side, but in a different revision. This other revision can have other default values for the process data as well as other/additional functions. If the found revision is higher than the configured revision, the slave may be used provided compatibility issues are taken into account. If the found revision is lower than the configured revision, it is likely that the slave cannot be used. The found device may not support all functions that the master expects based on the higher revision number.
light blue	This EtherCAT slave is ignored (“Ignore” button)

Color	Explanation
red	<ul style="list-style-type: none"> <li>This EtherCAT slave is not present on the other side.</li> <li>It is present, but in a different revision, which also differs in its properties from the one specified. The compatibility principle then also applies here: if the found revision is higher than the configured revision, use is possible provided compatibility issues are taken into account, since the successor devices should support the functions of the predecessor devices. If the found revision is lower than the configured revision, it is likely that the slave cannot be used. The found device may not support all functions that the master expects based on the higher revision number.</li> </ul>

### **i** Device selection based on revision, compatibility

The ESI description also defines the process image, the communication type between master and slave/device and the device functions, if applicable. The physical device (firmware, if available) has to support the communication queries/settings of the master. This is backward compatible, i.e. newer devices (higher revision) should be supported if the EtherCAT master addresses them as an older revision. The following compatibility rule of thumb is to be assumed for Beckhoff EtherCAT Terminals/ Boxes/ EJ-modules:

#### **device revision in the system >= device revision in the configuration**

This also enables subsequent replacement of devices without changing the configuration (different specifications are possible for drives).

### Example

If an EL2521-0025-**1018** is specified in the configuration, an EL2521-0025-**1018** or higher (**-1019**, **-1020**) can be used in practice.

Name  
(EL2521-0025-1018)  
Revision

Fig. 156: Name/revision of the terminal

If current ESI descriptions are available in the TwinCAT system, the last revision offered in the selection dialog matches the Beckhoff state of production. It is recommended to use the last device revision when creating a new configuration, if current Beckhoff devices are used in the real application. Older revisions should only be used if older devices from stock are to be used in the application.

In this case the process image of the device is shown in the configuration tree and can be parameterized as follows: linking with the task, CoE/DC settings, plug-in definition, startup settings, ...

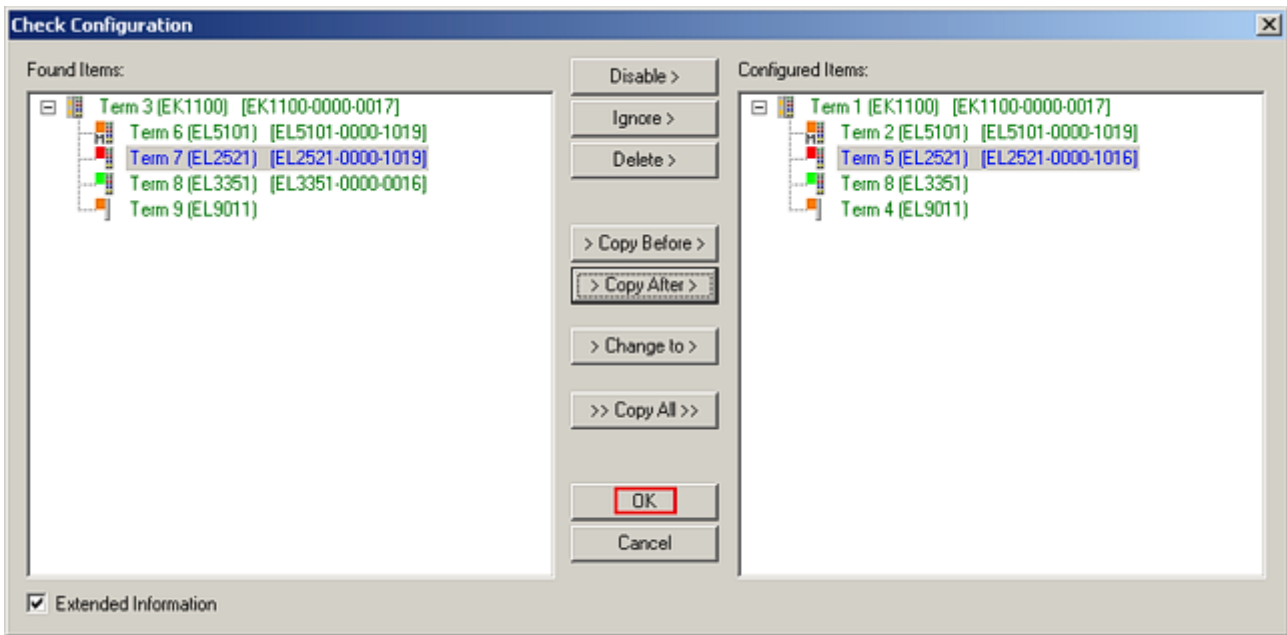

Fig. 157: Correction dialog with modifications

Once all modifications have been saved or accepted, click “OK” to transfer them to the real \*.tsm configuration.

### Change to Compatible Type

TwinCAT offers a function *Change to Compatible Type...* for the exchange of a device whilst retaining the links in the task.

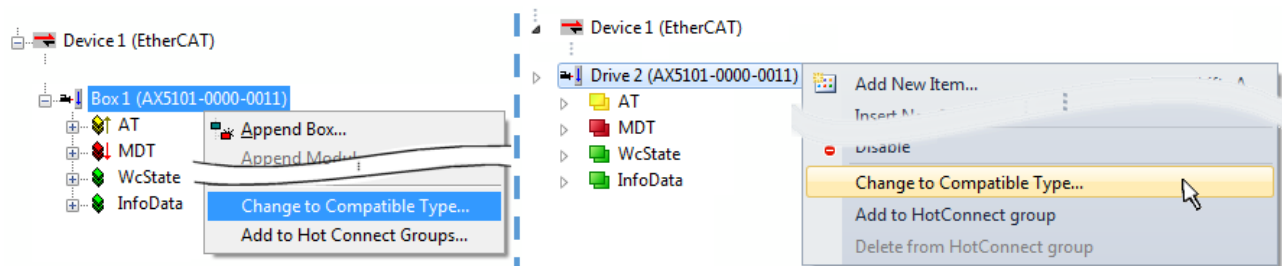

Fig. 158: Dialog “Change to Compatible Type...” (left: TwinCAT 2; right: TwinCAT 3)

The following elements in the ESI of an EtherCAT device are compared by TwinCAT and assumed to be the same in order to decide whether a device is indicated as "compatible":

- Physics (e.g. RJ45, Ebus...)
- FMMU (additional ones are allowed)
- SyncManager (SM, additional ones are allowed)
- EoE (attributes MAC, IP)
- CoE (attributes SdoInfo, PdoAssign, PdoConfig, PdoUpload, CompleteAccess)
- FoE
- PDO (process data: Sequence, SyncUnit SU, SyncManager SM, EntryCount, Entry.Datatype)

This function is preferably to be used on AX5000 devices.

### Change to Alternative Type

The TwinCAT System Manager offers a function for the exchange of a device: Change to Alternative Type

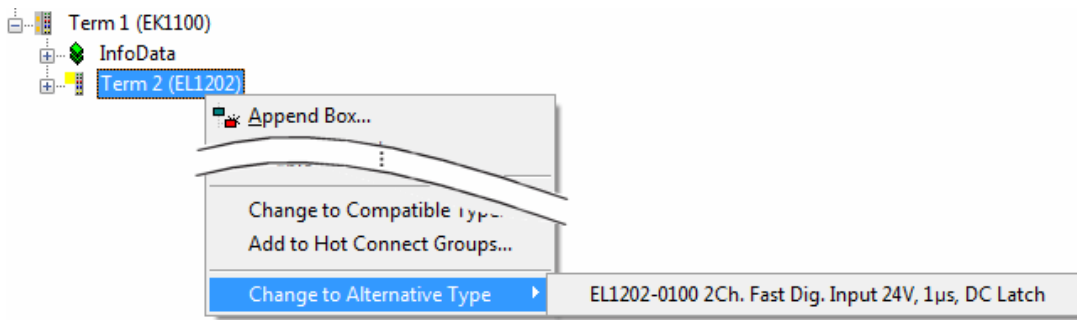

Fig. 159: TwinCAT 2 Dialog Change to Alternative Type

If called, the System Manager searches in the procured device ESI (in this example: EL1202-0000) for details of compatible devices contained there. The configuration is changed and the ESI-EEPROM is overwritten at the same time – therefore this process is possible only in the online state (ConfigMode).

### 5.3.7 EtherCAT subscriber configuration

In the left-hand window of the TwinCAT 2 System Manager or the Solution Explorer of the TwinCAT 3 Development Environment respectively, click on the element of the terminal within the tree you wish to configure (in the example: EL3751 Terminal 3).

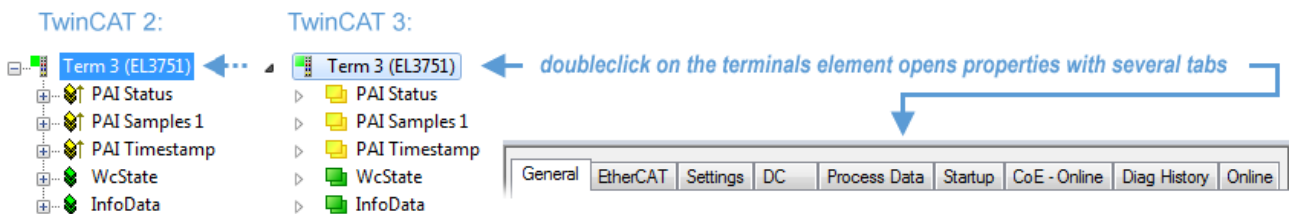

Fig. 160: Branch element as terminal EL3751

In the right-hand window of the TwinCAT System Manager (TwinCAT 2) or the Development Environment (TwinCAT 3), various tabs are now available for configuring the terminal. And yet the dimension of complexity of a subscriber determines which tabs are provided. Thus as illustrated in the example above the terminal EL3751 provides many setup options and also a respective number of tabs are available. On the contrary by the terminal EL1004 for example the tabs “General”, “EtherCAT”, “Process Data” and “Online” are available only. Several terminals, as for instance the EL6695 provide special functions by a tab with its own terminal name, so “EL6695” in this case. A specific tab “Settings” by terminals with a wide range of setup options will be provided also (e.g. EL3751).

#### “General” tab

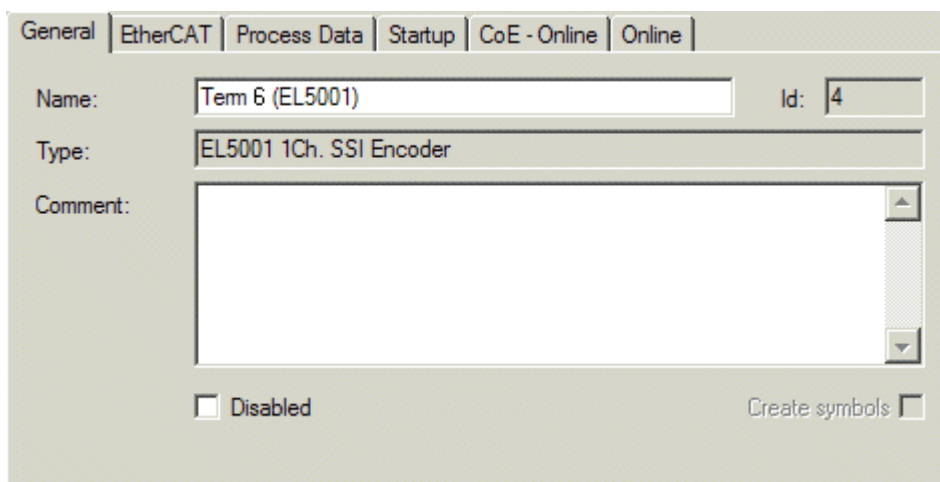

Fig. 161: “General” tab

**Name** Name of the EtherCAT device

<b>Id</b>	Number of the EtherCAT device
<b>Type</b>	EtherCAT device type
<b>Comment</b>	Here you can add a comment (e.g. regarding the system).
<b>Disabled</b>	Here you can deactivate the EtherCAT device.
<b>Create symbols</b>	Access to this EtherCAT slave via ADS is only available if this control box is activated.

**“EtherCAT” tab**

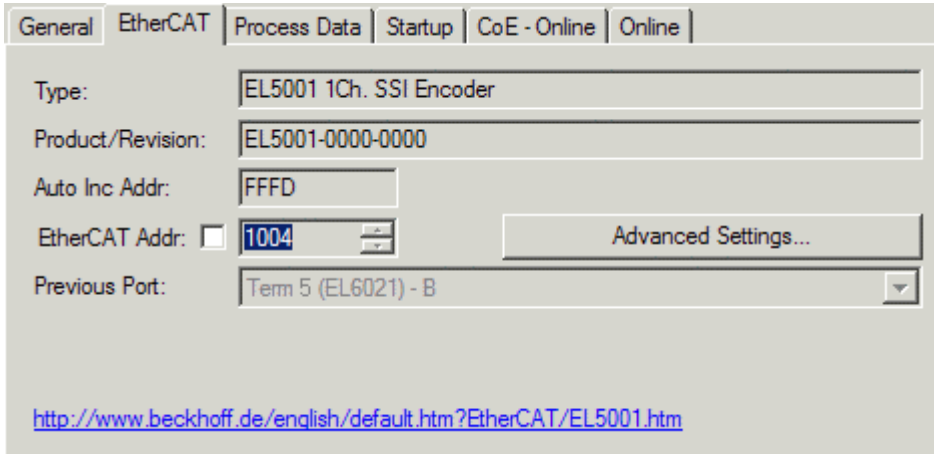

Fig. 162: “EtherCAT” tab

<b>Type</b>	EtherCAT device type
<b>Product/Revision</b>	Product and revision number of the EtherCAT device
<b>Auto Inc Addr.</b>	Auto increment address of the EtherCAT device. The auto increment address can be used for addressing each EtherCAT device in the communication ring through its physical position. Auto increment addressing is used during the start-up phase when the EtherCAT master allocates addresses to the EtherCAT devices. With auto increment addressing the first EtherCAT slave in the ring has the address 0000 <sub>hex</sub> . For each further slave the address is decremented by 1 (FFFF <sub>hex</sub> , FFFE <sub>hex</sub> etc.).
<b>EtherCAT Addr.</b>	Fixed address of an EtherCAT slave. This address is allocated by the EtherCAT master during the start-up phase. Tick the control box to the left of the input field in order to modify the default value.
<b>Previous Port</b>	Name and port of the EtherCAT device to which this device is connected. If it is possible to connect this device with another one without changing the order of the EtherCAT devices in the communication ring, then this combination field is activated and the EtherCAT device to which this device is to be connected can be selected.
<b>Advanced Settings</b>	This button opens the dialogs for advanced settings.

The link at the bottom of the tab points to the product page for this EtherCAT device on the web.

**“Process Data” tab**

Indicates the configuration of the process data. The input and output data of the EtherCAT slave are represented as CANopen process data objects (**Process Data Objects, PDOs**). The user can select a PDO via PDO assignment and modify the content of the individual PDO via this dialog, if the EtherCAT slave supports this function.

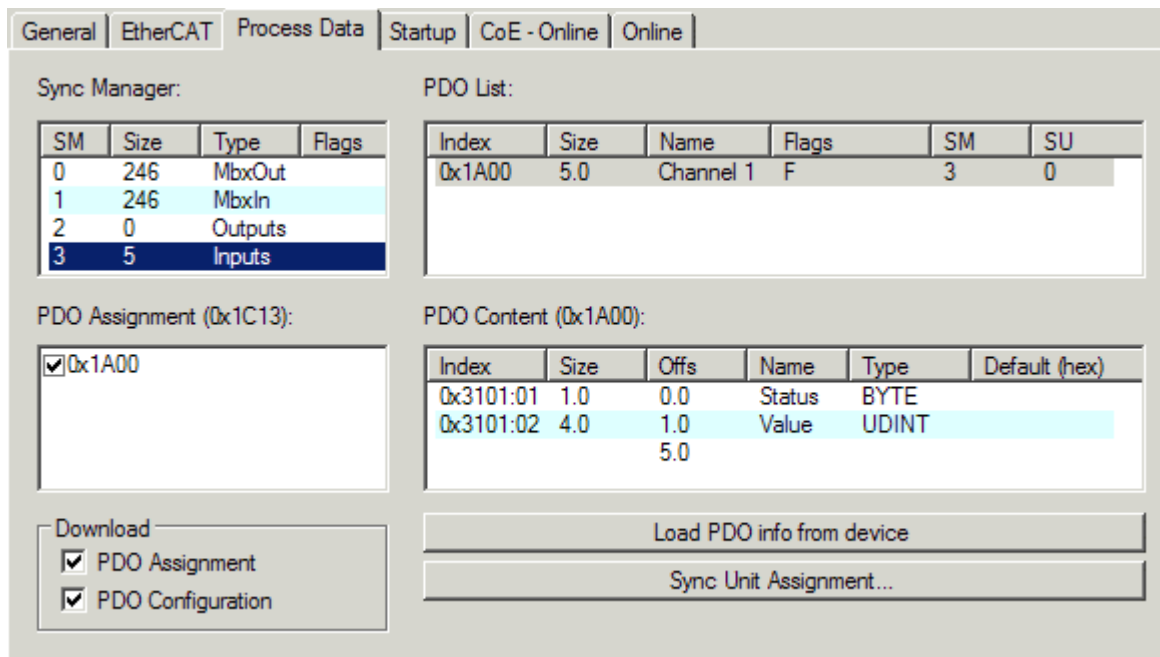

Fig. 163: "Process Data" tab

The process data (PDOs) transferred by an EtherCAT slave during each cycle are user data which the application expects to be updated cyclically or which are sent to the slave. To this end the EtherCAT master (Beckhoff TwinCAT) parameterizes each EtherCAT slave during the start-up phase to define which process data (size in bits/bytes, source location, transmission type) it wants to transfer to or from this slave. Incorrect configuration can prevent successful start-up of the slave.

For Beckhoff EtherCAT EL, ES, EM, EJ and EP slaves the following applies in general:

- The input/output process data supported by the device are defined by the manufacturer in the ESI/XML description. The TwinCAT EtherCAT Master uses the ESI description to configure the slave correctly.
- The process data can be modified in the System Manager. See the device documentation. Examples of modifications include: mask out a channel, displaying additional cyclic information, 16-bit display instead of 8-bit data size, etc.
- In so-called "intelligent" EtherCAT devices the process data information is also stored in the CoE directory. Any changes in the CoE directory that lead to different PDO settings prevent successful startup of the slave. It is not advisable to deviate from the designated process data, because the device firmware (if available) is adapted to these PDO combinations.

If the device documentation allows modification of process data, proceed as follows (see Figure *Configuring the process data*).

- A: select the device to configure
- B: in the "Process Data" tab select Input or Output under SyncManager (C)
- D: the PDOs can be selected or deselected
- H: the new process data are visible as linkable variables in the System Manager  
The new process data are active once the configuration has been activated and TwinCAT has been restarted (or the EtherCAT master has been restarted)
- E: if a slave supports this, Input and Output PDO can be modified simultaneously by selecting a so-called PDO record ("predefined PDO settings").

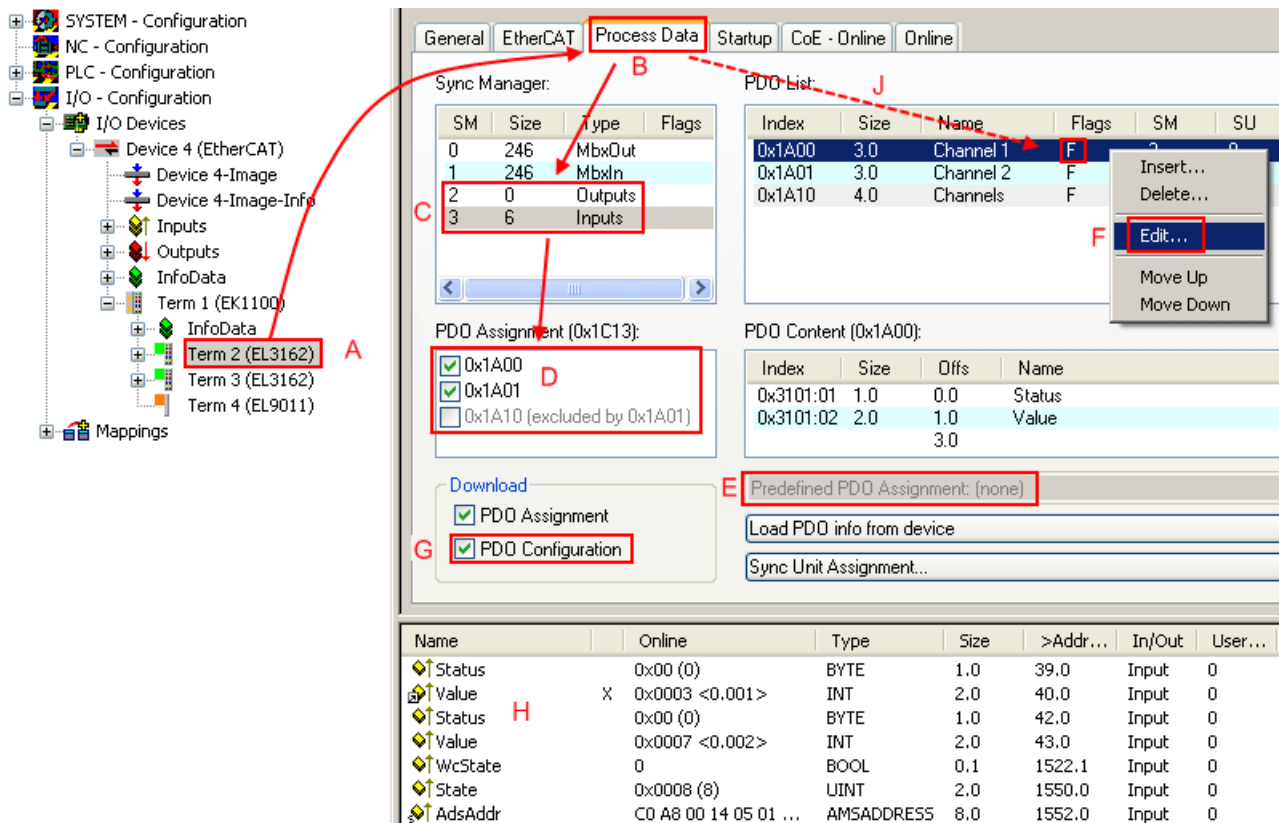

Fig. 164: Configuring the process data

### Manual modification of the process data

According to the ESI description, a PDO can be identified as “fixed” with the flag “F” in the PDO overview (Fig. *Configuring the process data*, J). The configuration of such PDOs cannot be changed, even if TwinCAT offers the associated dialog (“Edit”). In particular, CoE content cannot be displayed as cyclic process data. This generally also applies in cases where a device supports download of the PDO configuration, “G”. In case of incorrect configuration the EtherCAT slave usually refuses to start and change to OP state. The System Manager displays an “invalid SM cfg” logger message: This error message (“invalid SM IN cfg” or “invalid SM OUT cfg”) also indicates the reason for the failed start.

A detailed description [► 200] can be found at the end of this section.

### “Startup” tab

The *Startup* tab is displayed if the EtherCAT slave has a mailbox and supports the *CANopen over EtherCAT* (CoE) or *Servo drive over EtherCAT* protocol. This tab indicates which download requests are sent to the mailbox during startup. It is also possible to add new mailbox requests to the list display. The download requests are sent to the slave in the same order as they are shown in the list.



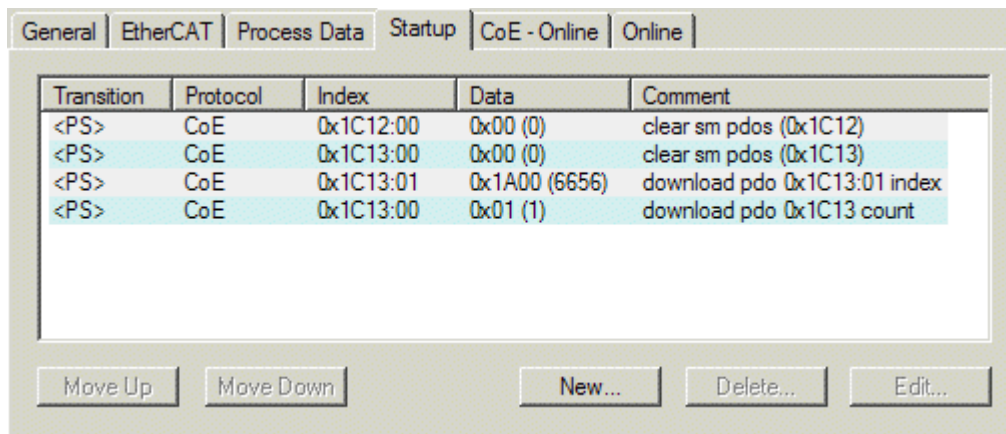

Fig. 165: "Startup" tab

Column	Description
Transition	Transition to which the request is sent. This can either be <ul style="list-style-type: none"> <li>the transition from pre-operational to safe-operational (PS), or</li> <li>the transition from safe-operational to operational (SO).</li> </ul> If the transition is enclosed in "<>" (e.g. <PS>), the mailbox request is fixed and cannot be modified or deleted by the user.
Protocol	Type of mailbox protocol
Index	Index of the object
Data	Date on which this object is to be downloaded.
Comment	Description of the request to be sent to the mailbox

- Move Up** This button moves the selected request up by one position in the list.
- Move Down** This button moves the selected request down by one position in the list.
- New** This button adds a new mailbox download request to be sent during startup.
- Delete** This button deletes the selected entry.
- Edit** This button edits an existing request.

#### "CoE - Online" tab

The additional *CoE - Online* tab is displayed if the EtherCAT slave supports the *CANopen over EtherCAT* (CoE) protocol. This dialog lists the content of the object list of the slave (SDO upload) and enables the user to modify the content of an object from this list. Details for the objects of the individual EtherCAT devices can be found in the device-specific object descriptions.



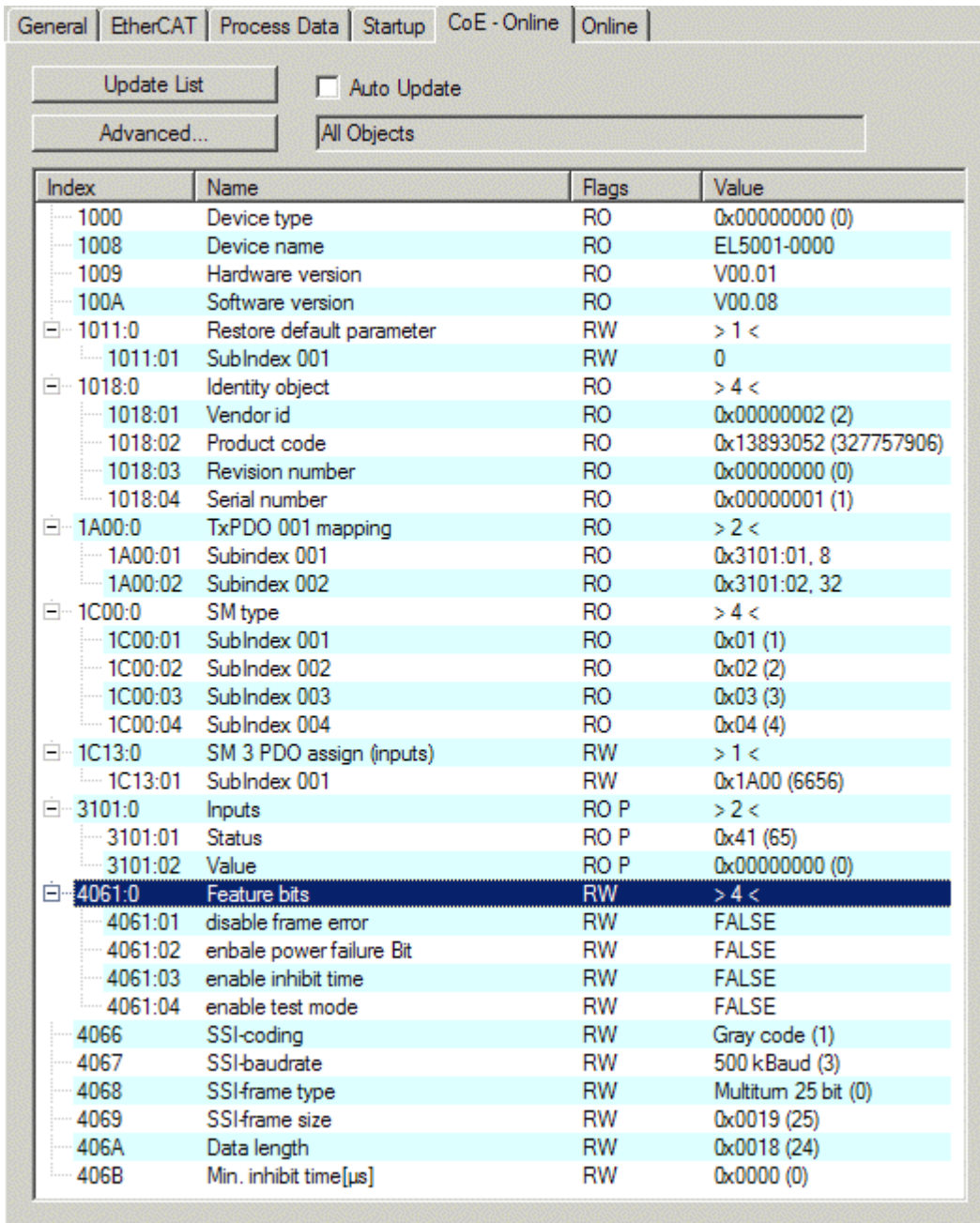

Fig. 166: "CoE - Online" tab

**Object list display**

Column	Description
Index	Index and sub-index of the object
Name	Name of the object
Flags	RW The object can be read, and data can be written to the object (read/write)
	RO The object can be read, but no data can be written to the object (read only)
	P An additional P identifies the object as a process data object.
Value	Value of the object

**Update List** The *Update list* button updates all objects in the displayed list

**Auto Update** If this check box is selected, the content of the objects is updated automatically.

**Advanced** The *Advanced* button opens the *Advanced Settings* dialog. Here you can specify which objects are displayed in the list.

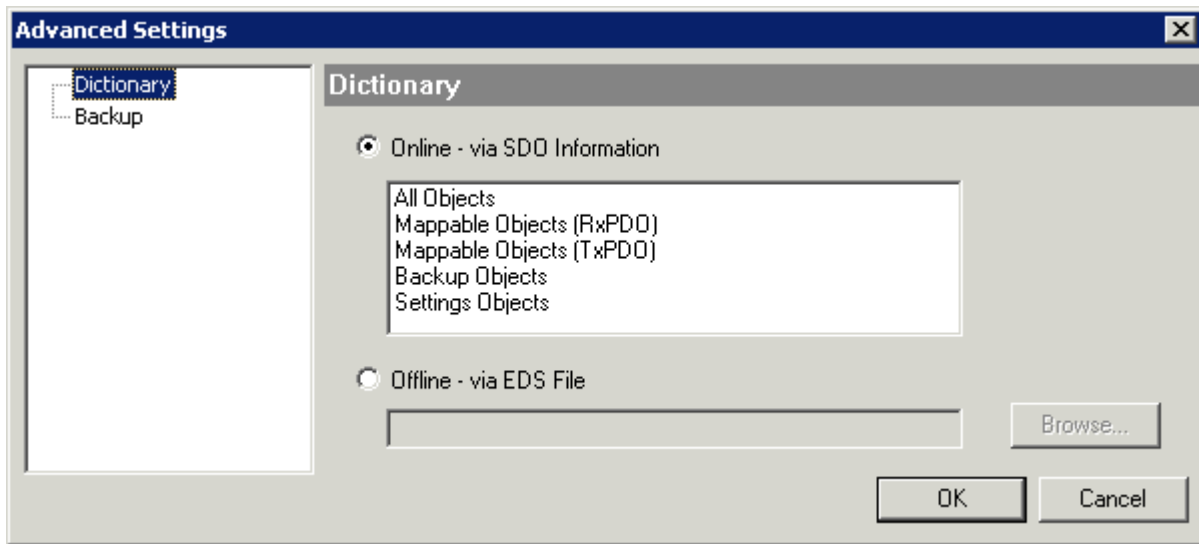

Fig. 167: Dialog “Advanced settings”

**Online - via SDO Information** If this option button is selected, the list of the objects included in the object list of the slave is uploaded from the slave via SDO information. The list below can be used to specify which object types are to be uploaded.

**Offline - via EDS File** If this option button is selected, the list of the objects included in the object list is read from an EDS file provided by the user.

“Online” tab

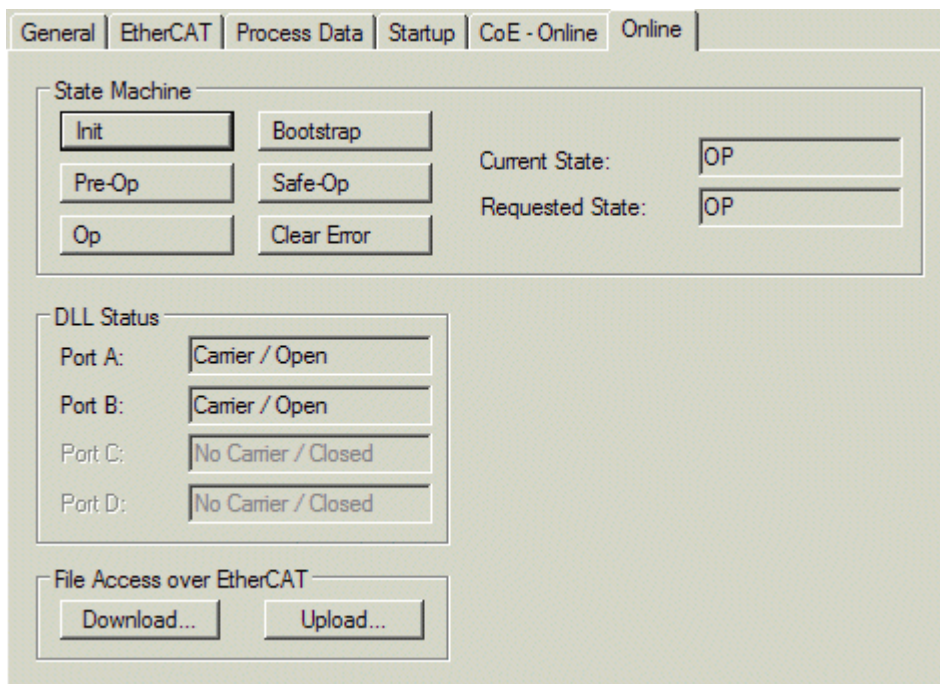

Fig. 168: “Online” tab

**State Machine**

- Init** This button attempts to set the EtherCAT device to the *Init* state.
- Pre-Op** This button attempts to set the EtherCAT device to the *pre-operational* state.
- Op** This button attempts to set the EtherCAT device to the *operational* state.
- Bootstrap** This button attempts to set the EtherCAT device to the *Bootstrap* state.
- Safe-Op** This button attempts to set the EtherCAT device to the *safe-operational* state.

- Clear Error** This button attempts to delete the fault display. If an EtherCAT slave fails during change of state it sets an error flag.  
Example: An EtherCAT slave is in PREOP state (pre-operational). The master now requests the SAFEOP state (safe-operational). If the slave fails during change of state it sets the error flag. The current state is now displayed as ERR PREOP. When the *Clear Error* button is pressed the error flag is cleared, and the current state is displayed as PREOP again.
- Current State** Indicates the current state of the EtherCAT device.
- Requested State** Indicates the state requested for the EtherCAT device.

**DLL Status**

Indicates the DLL status (data link layer status) of the individual ports of the EtherCAT slave. The DLL status can have four different states:

Status	Description
No Carrier / Open	No carrier signal is available at the port, but the port is open.
No Carrier / Closed	No carrier signal is available at the port, and the port is closed.
Carrier / Open	A carrier signal is available at the port, and the port is open.
Carrier / Closed	A carrier signal is available at the port, but the port is closed.

**File Access over EtherCAT**

- Download** With this button a file can be written to the EtherCAT device.
- Upload** With this button a file can be read from the EtherCAT device.

**“DC” tab (Distributed Clocks)**

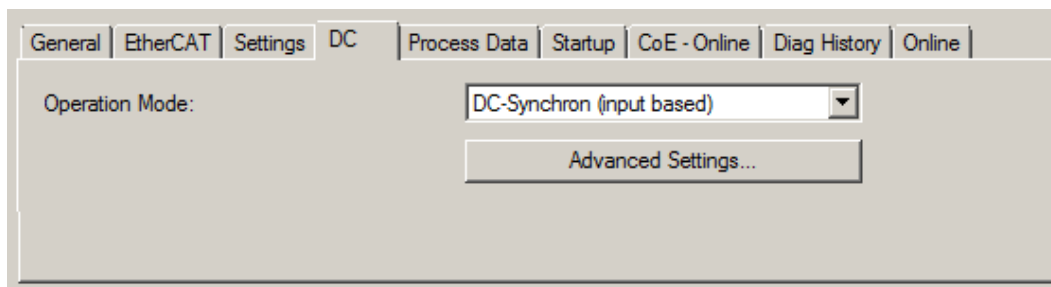

Fig. 169: “DC” tab (Distributed Clocks)

- Operation Mode** Options (optional):
  - FreeRun
  - SM-Synchron
  - DC-Synchron (Input based)
  - DC-Synchron
- Advanced Settings...** Advanced settings for readjustment of the real time determinant TwinCAT-clock

Detailed information to Distributed Clocks is specified on <http://infosys.beckhoff.com>:

**Fieldbus Components** → EtherCAT Terminals → EtherCAT System documentation → EtherCAT basics → Distributed Clocks

### 5.3.7.1 Detailed description of Process Data tab

#### Sync Manager

Lists the configuration of the Sync Manager (SM).

If the EtherCAT device has a mailbox, SM0 is used for the mailbox output (MbxOut) and SM1 for the mailbox input (MbxIn).

SM2 is used for the output process data (outputs) and SM3 (inputs) for the input process data.

If an input is selected, the corresponding PDO assignment is displayed in the *PDO Assignment* list below.

#### PDO Assignment

PDO assignment of the selected Sync Manager. All PDOs defined for this Sync Manager type are listed here:

- If the output Sync Manager (outputs) is selected in the Sync Manager list, all RxPDOs are displayed.
- If the input Sync Manager (inputs) is selected in the Sync Manager list, all TxPDOs are displayed.

The selected entries are the PDOs involved in the process data transfer. In the tree diagram of the System Manager these PDOs are displayed as variables of the EtherCAT device. The name of the variable is identical to the *Name* parameter of the PDO, as displayed in the PDO list. If an entry in the PDO assignment list is deactivated (not selected and greyed out), this indicates that the input is excluded from the PDO assignment. In order to be able to select a greyed out PDO, the currently selected PDO has to be deselected first.

#### ● **Activation of PDO assignment**



✓ If you have changed the PDO assignment, in order to activate the new PDO assignment,

a) the EtherCAT slave has to run through the PS status transition cycle (from pre-operational to safe-operational) once (see [Online tab \[▶ 198\]](#)),

b) and the System Manager has to reload the EtherCAT slaves



( button for TwinCAT 2 or



button for TwinCAT 3)

#### PDO list

List of all PDOs supported by this EtherCAT device. The content of the selected PDOs is displayed in the *PDO Content* list. The PDO configuration can be modified by double-clicking on an entry.

Column	Description	
Index	PDO index.	
Size	Size of the PDO in bytes.	
Name	Name of the PDO. If this PDO is assigned to a Sync Manager, it appears as a variable of the slave with this parameter as the name.	
Flags	F	Fixed content: The content of this PDO is fixed and cannot be changed by the System Manager.
	M	Mandatory PDO. This PDO is mandatory and must therefore be assigned to a Sync Manager! Consequently, this PDO cannot be deleted from the <i>PDO Assignment</i> list
SM	Sync Manager to which this PDO is assigned. If this entry is empty, this PDO does not take part in the process data traffic.	
SU	Sync unit to which this PDO is assigned.	

#### PDO Content

Indicates the content of the PDO. If flag F (fixed content) of the PDO is not set the content can be modified.

## Download

If the device is intelligent and has a mailbox, the configuration of the PDO and the PDO assignments can be downloaded to the device. This is an optional feature that is not supported by all EtherCAT slaves.

## PDO Assignment

If this check box is selected, the PDO assignment that is configured in the PDO Assignment list is downloaded to the device on startup. The required commands to be sent to the device can be viewed in the Startup [► 195] tab.

## PDO Configuration

If this check box is selected, the configuration of the respective PDOs (as shown in the PDO list and the PDO Content display) is downloaded to the EtherCAT slave.

## 5.3.8 Import/Export of EtherCAT devices with SCI and XTI

### SCI and XTI Export/Import – Handling of user-defined modified EtherCAT slaves

#### 5.3.8.1 Basic principles

An EtherCAT slave is basically parameterized through the following elements:

- Cyclic process data (PDO)
- Synchronization (Distributed Clocks, FreeRun, SM-Synchron)
- CoE parameters (acyclic object dictionary)

Note: Not all three elements may be present, depending on the slave.

For a better understanding of the export/import function, let's consider the usual procedure for IO configuration:

- The user/programmer processes the IO configuration in the TwinCAT system environment. This involves all input/output devices such as drives that are connected to the fieldbuses used.  
Note: In the following sections, only EtherCAT configurations in the TwinCAT system environment are considered.
- For example, the user manually adds devices to a configuration or performs a scan on the online system.
- This results in the IO system configuration.
- On insertion, the slave appears in the system configuration in the default configuration provided by the vendor, consisting of default PDO, default synchronization method and CoE StartUp parameter as defined in the ESI (XML device description).
- If necessary, elements of the slave configuration can be changed, e.g. the PDO configuration or the synchronization method, based on the respective device documentation.

It may become necessary to reuse the modified slave in other projects in this way, without having to make equivalent configuration changes to the slave again. To accomplish this, proceed as follows:

- Export the slave configuration from the project,
- Store and transport as a file,
- Import into another EtherCAT project.

TwinCAT offers two methods for this purpose:

- within the TwinCAT environment: Export/Import as **x**ti file or
- outside, i.e. beyond the TwinCAT limits: Export/Import as **s**ci file.

An example is provided below for illustration purposes: an EL3702 terminal with standard setting is switched to 2-fold oversampling (blue) and the optional PDO "StartTimeNextLatch" is added (red):

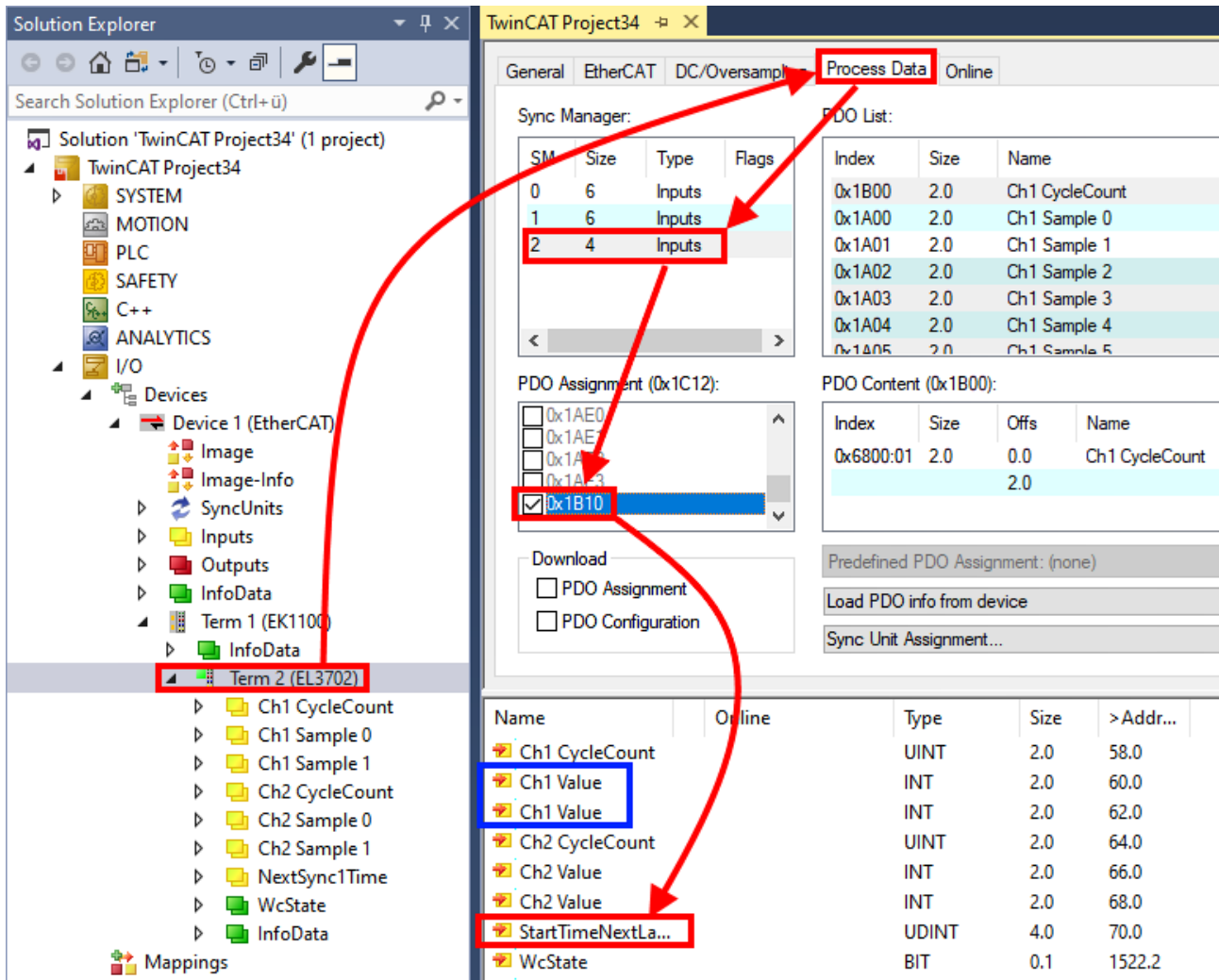

The two methods for exporting and importing the modified terminal referred to above are demonstrated below.

### 5.3.8.2 Procedure within TwinCAT with xti files

Each IO device can be exported/saved individually:

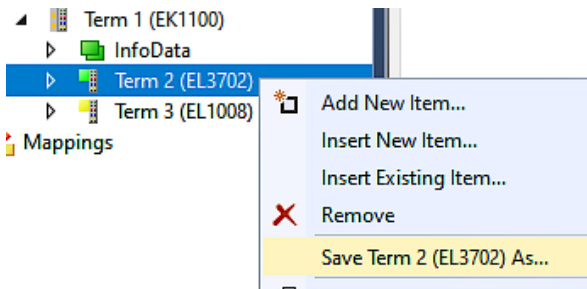

The xti file can be stored:

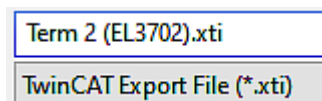

and imported again in another TwinCAT system via "Insert Existing item":



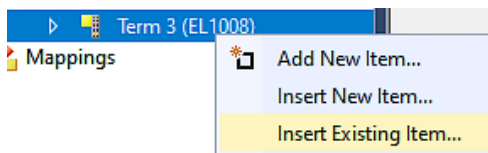

### 5.3.8.3 Procedure within and outside TwinCAT with sci file

Note regarding availability (2021/01)

The SCI method is available from TwinCAT 3.1 build 4024.14.

The Slave Configuration Information (SCI) describes a specific complete configuration for an EtherCAT slave (terminal, box, drive...) based on the setting options of the device description file (ESI, EtherCAT Slave Information). That is, it includes PDO, CoE, synchronization.

#### Export:

- select a single device via the menu (multiple selection is also possible):  
TwinCAT → EtherCAT Devices → Export SCI.

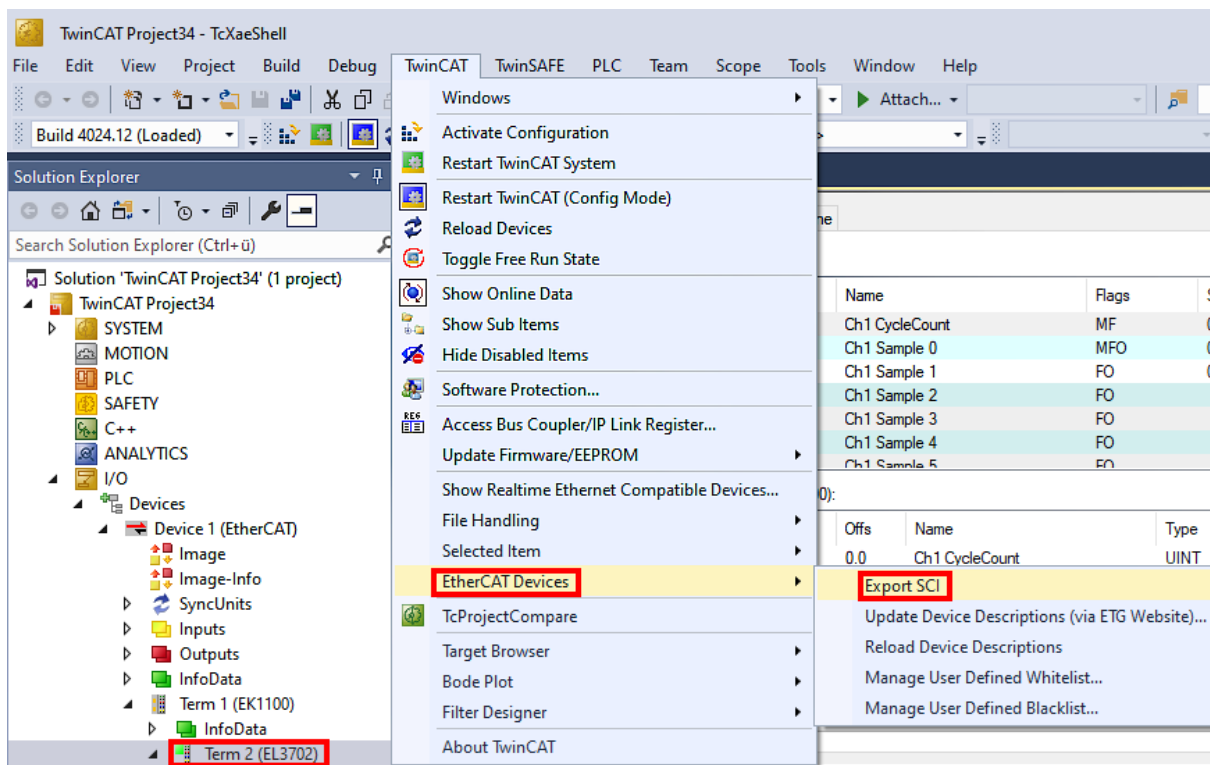

- If TwinCAT is offline (i.e. if there is no connection to an actual running controller) a warning message may appear, because after executing the function the system attempts to reload the EtherCAT segment. However, in this case this is not relevant for the result and can be acknowledged by clicking OK:

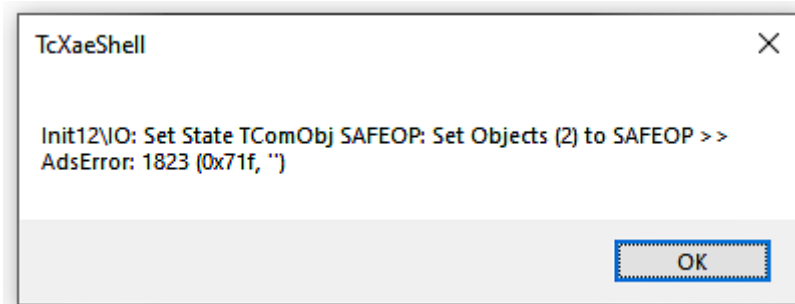

- A description may also be provided:

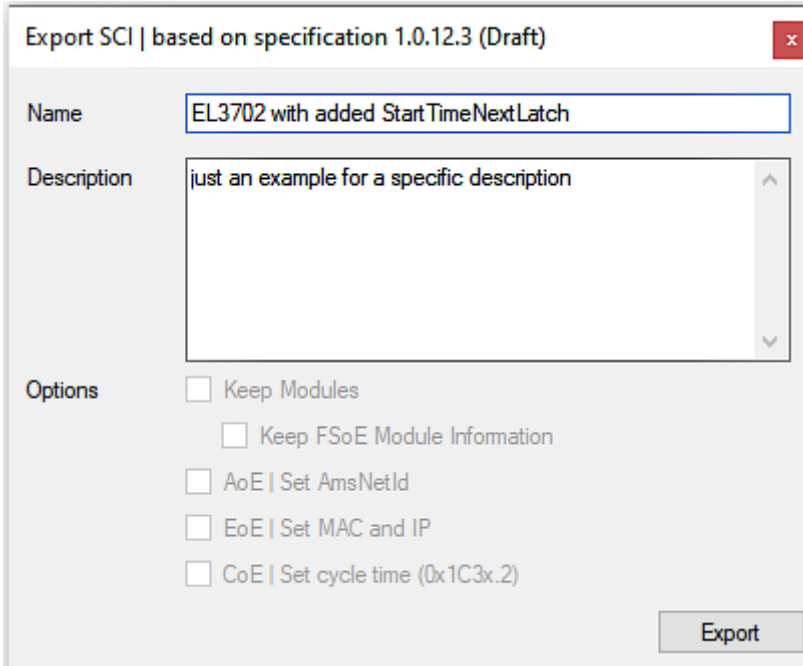

- Explanation of the dialog box:

Name	Name of the SCI, assigned by the user.	
Description	Description of the slave configuration for the use case, assigned by the user.	
Options	Keep modules	If a slave supports modules/slots, the user can decide whether these are to be exported or whether the module and device data are to be combined during export.
	AoE   Set AmsNetId	The configured AmsNetId is exported. Usually this is network-dependent and cannot always be determined in advance.
	EoE   Set MAC and IP	The configured virtual MAC and IP addresses are stored in the SCI. Usually these are network-dependent and cannot always be determined in advance.
	CoE   Set cycle time(0x1C3x.2)	The configured cycle time is exported. Usually this is network-dependent and cannot always be determined in advance.
ESI	Reference to the original ESI file.	
Export	Save SCI file.	

- A list view is available for multiple selections (*Export multiple SCI files*):

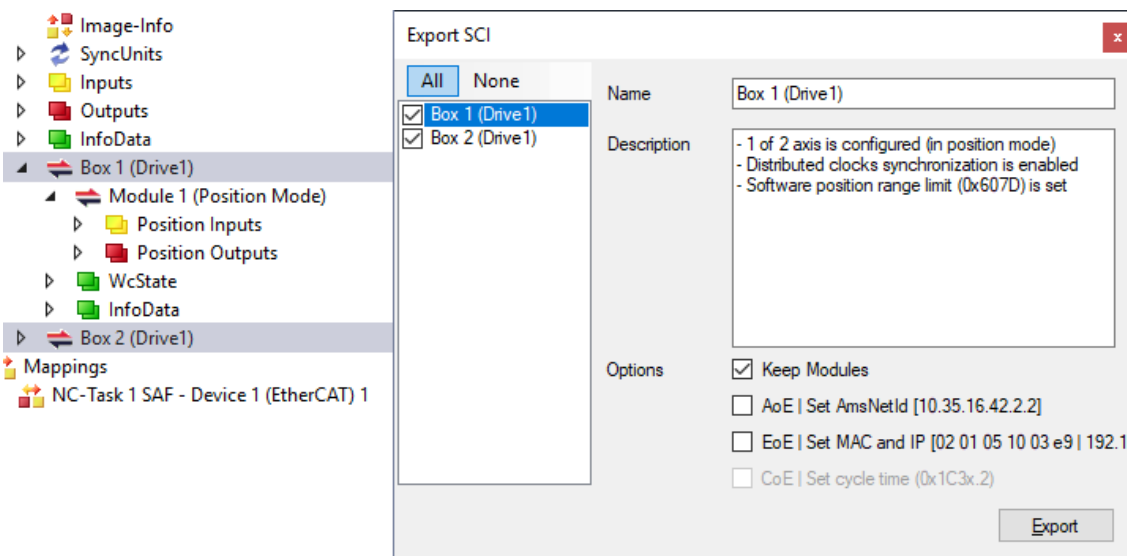

- Selection of the slaves to be exported:
  - All:
    - All slaves are selected for export.



- None:  
All slaves are deselected.
- The sci file can be saved locally:

Dateiname:   
 Dateityp:

- The export takes place:

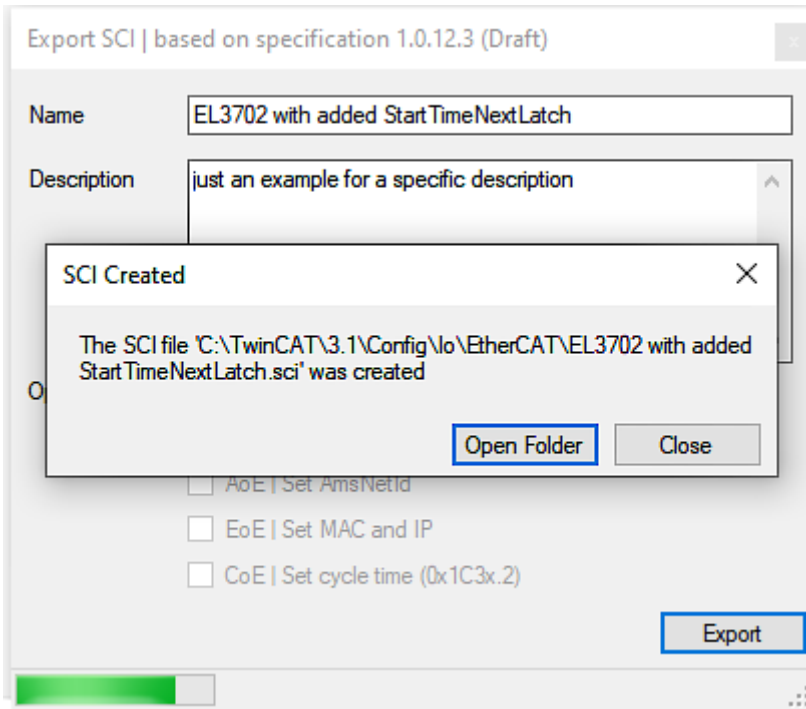

**Import**

- An sci description can be inserted manually into the TwinCAT configuration like any normal Beckhoff device description.
- The sci file must be located in the TwinCAT ESI path, usually under:  
C:\TwinCAT\3.1\Config\Io\EtherCAT

	EL3702 with added StartTimeNextLatch.sci	11.01.2021 13:29	SCI-Datei	6 KB
--	--	------------------	-----------	------

- Open the selection dialog:

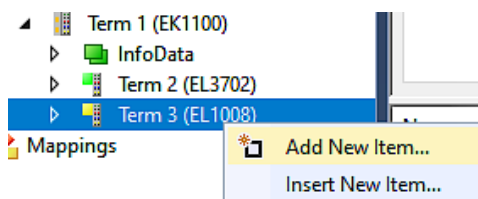

- Display SCI devices and select and insert the desired device:

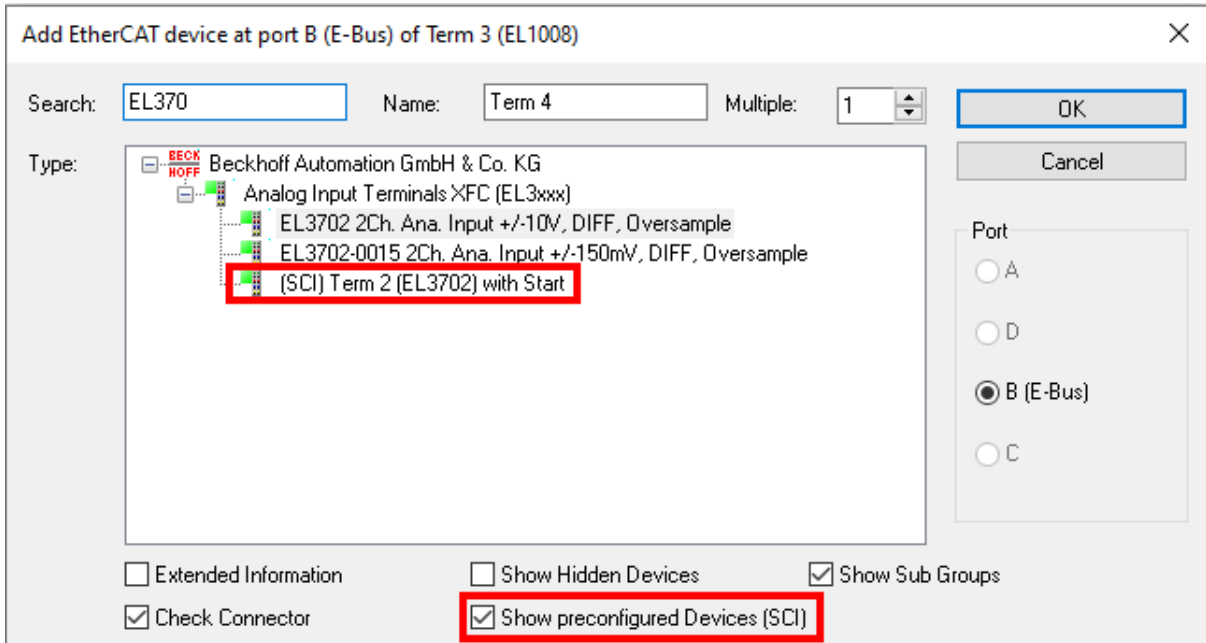

**Additional Notes**

- Settings for the SCI function can be made via the general Options dialog (Tools → Options → TwinCAT → Export SCI):

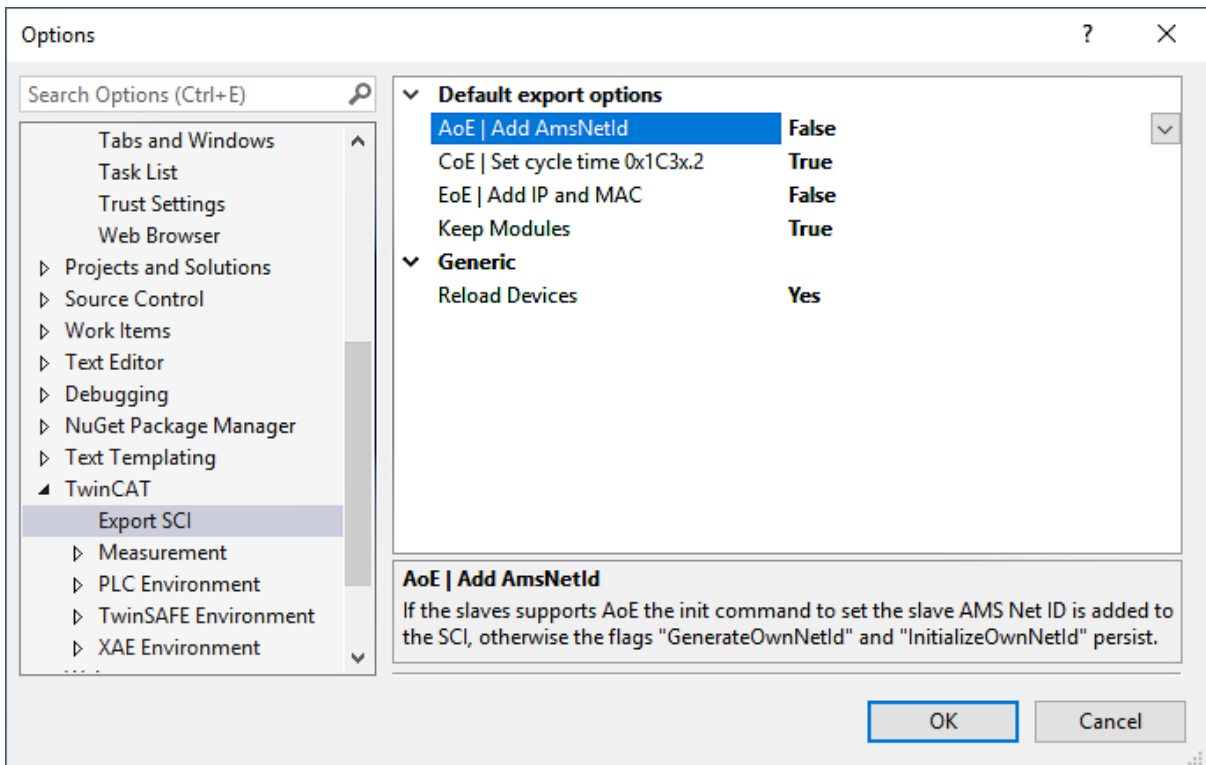

Explanation of the settings:

Default export options	AoE   Set AmsNetId	Default setting whether the configured AmsNetId is exported.
	CoE   Set cycle time(0x1C3x.2)	Default setting whether the configured cycle time is exported.
	EoE   Set MAC and IP	Default setting whether the configured MAC and IP addresses are exported.
	Keep modules	Default setting whether the modules persist.
Generic	Reload Devices	Setting whether the Reload Devices command is executed before the SCI export. This is strongly recommended to ensure a consistent slave configuration.

SCI error messages are displayed in the TwinCAT logger output window if required:

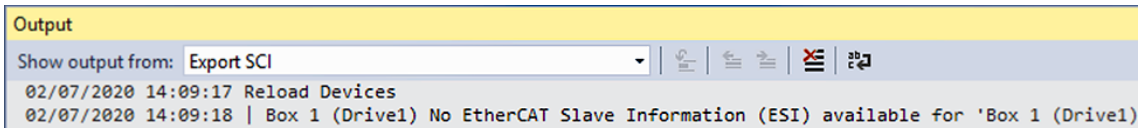

## 5.4 EtherCAT basics

Please refer to the [EtherCAT System Documentation](#) for the EtherCAT fieldbus basics.

## 5.5 EtherCAT cabling – wire-bound

The cable length between two EtherCAT devices must not exceed 100 m. This results from the FastEthernet technology, which, above all for reasons of signal attenuation over the length of the cable, allows a maximum link length of 5 + 90 + 5 m if cables with appropriate properties are used. See also the [Design recommendations for the infrastructure for EtherCAT/Ethernet](#).

### Cables and connectors

For connecting EtherCAT devices only Ethernet connections (cables + plugs) that meet the requirements of at least category 5 (CAT5) according to EN 50173 or ISO/IEC 11801 should be used. EtherCAT uses 4 wires for signal transfer.

EtherCAT uses RJ45 plug connectors, for example. The pin assignment is compatible with the Ethernet standard (ISO/IEC 8802-3).

Pin	Color of conductor	Signal	Description
1	yellow	TD +	Transmission Data +
2	orange	TD -	Transmission Data -
3	white	RD +	Receiver Data +
6	blue	RD -	Receiver Data -

Due to automatic cable detection (auto-crossing) symmetric (1:1) or cross-over cables can be used between EtherCAT devices from Beckhoff.

### **i** Recommended cables

- It is recommended to use the appropriate Beckhoff components e.g.
- cable sets ZK1090-9191-xxxx respectively
- RJ45 connector, field assembly ZS1090-0005
- EtherCAT cable, field assembly ZB9010, ZB9020

Suitable cables for the connection of EtherCAT devices can be found on the [Beckhoff website!](#)

### E-Bus supply

A bus coupler can supply the EL terminals added to it with the E-bus system voltage of 5 V; a coupler is thereby loadable up to 2 A as a rule (see details in respective device documentation). Information on how much current each EL terminal requires from the E-bus supply is available online and in the catalogue. If the added terminals require more current than the coupler can supply, then power feed terminals (e.g. [EL9410](#)) must be inserted at appropriate places in the terminal strand.

The pre-calculated theoretical maximum E-Bus current is displayed in the TwinCAT System Manager. A shortfall is marked by a negative total amount and an exclamation mark; a power feed terminal is to be placed before such a position.

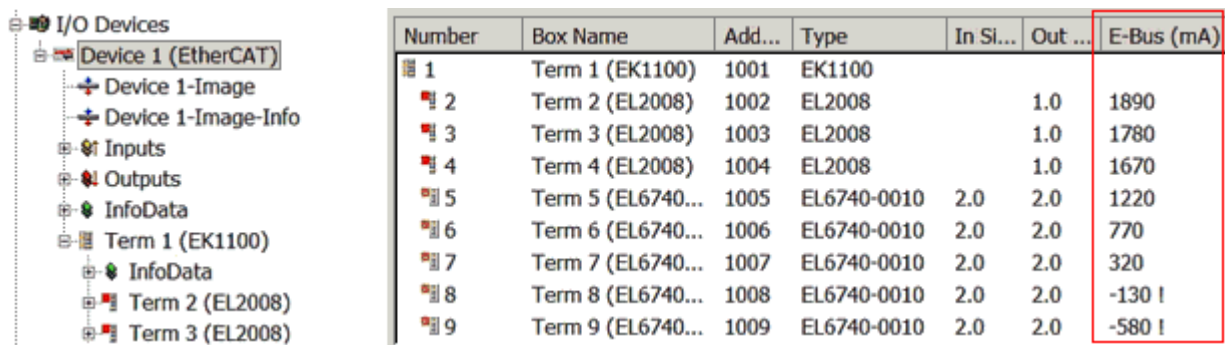

The screenshot shows the 'I/O Devices' tree on the left, with 'Device 1 (EtherCAT)' expanded to show 'Term 1 (EK1100)', 'Term 2 (EL2008)', and 'Term 3 (EL2008)'. The table on the right lists the current calculation for each terminal, with the 'E-Bus (mA)' column highlighted in red.

Number	Box Name	Add...	Type	In Si...	Out ...	E-Bus (mA)
1	Term 1 (EK1100)	1001	EK1100			
2	Term 2 (EL2008)	1002	EL2008		1.0	1890
3	Term 3 (EL2008)	1003	EL2008		1.0	1780
4	Term 4 (EL2008)	1004	EL2008		1.0	1670
5	Term 5 (EL6740...)	1005	EL6740-0010	2.0	2.0	1220
6	Term 6 (EL6740...)	1006	EL6740-0010	2.0	2.0	770
7	Term 7 (EL6740...)	1007	EL6740-0010	2.0	2.0	320
8	Term 8 (EL6740...)	1008	EL6740-0010	2.0	2.0	-130 I
9	Term 9 (EL6740...)	1009	EL6740-0010	2.0	2.0	-580 I

Fig. 170: System manager current calculation

**NOTICE****Malfunction possible!**

The same ground potential must be used for the E-Bus supply of all EtherCAT terminals in a terminal block!

## 5.6 General notes for setting the watchdog

The ELxxxx terminals are equipped with a safety device (watchdog) which, e.g. in the event of interrupted process data traffic, switches the outputs (if present) to a presettable state after a presettable time, depending on the device and setting, e.g. to FALSE (off) or an output value.

The EtherCAT slave controller (ESC) features two watchdogs:

- SM watchdog (default: 100 ms)
- PDI watchdog (default: 100 ms)

Their times are individually parameterized in TwinCAT as follows:

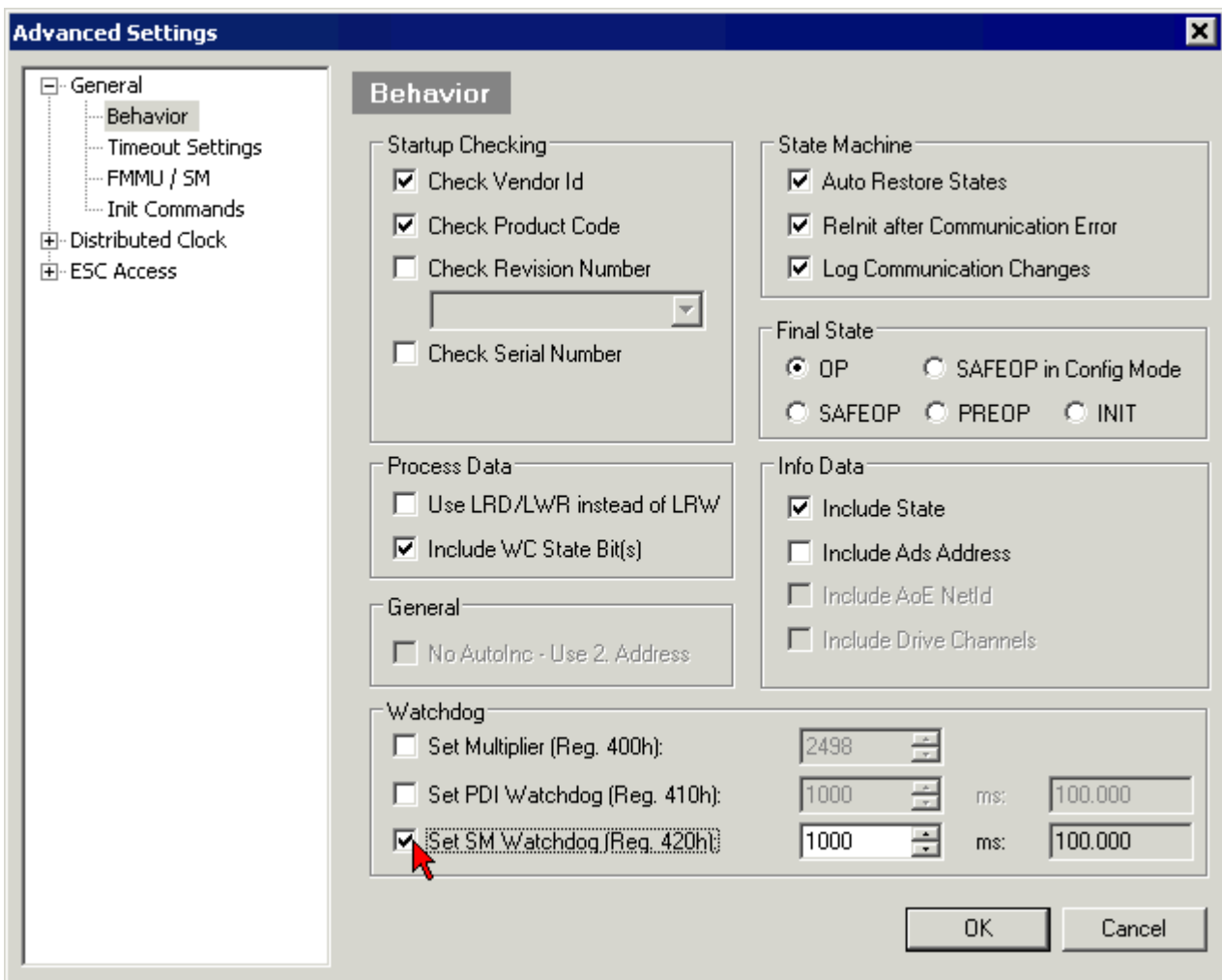

Fig. 171: eEtherCAT tab -> Advanced Settings -> Behavior -> Watchdog

Notes:

- the Multiplier Register 400h (hexadecimal, i.e. x0400) is valid for both watchdogs.
- each watchdog has its own timer setting 410h or 420h, which together with the Multiplier results in a resulting time.
- important: the Multiplier/Timer setting is only loaded into the slave at EtherCAT startup if the checkbox in front of it is activated.
- if it is not checked, nothing is downloaded and the setting located in the ESC remains unchanged.
- the downloaded values can be seen in the ESC registers x0400/0410/0420: ESC Access -> Memory

**SM watchdog (SyncManager Watchdog)**

The SyncManager watchdog is reset with each successful EtherCAT process data communication with the terminal. If, for example, no EtherCAT process data communication with the terminal takes place for longer than the set and activated SM watchdog time due to a line interruption, the watchdog is triggered. The status of the terminal (usually OP) remains unaffected. The watchdog is only reset again by a successful EtherCAT process data access.

The SyncManager watchdog is therefore a monitoring for correct and timely process data communication with the ESC from the EtherCAT side.

The maximum possible watchdog time depends on the device. For example, for "simple" EtherCAT slaves (without firmware) with watchdog execution in the ESC it is usually up to ~170 seconds. For "complex" EtherCAT slaves (with firmware) the SM watchdog function is usually parameterized via Reg. 400/420 but executed by the µC and can be significantly lower. In addition, the execution may then be subject to a certain time uncertainty. Since the TwinCAT dialog may allow inputs up to 65535, a test of the desired watchdog time is recommended.

### PDI watchdog (Process Data Watchdog)

If there is no PDI communication with the EtherCAT slave controller (ESC) for longer than the set and activated PDI watchdog time, this watchdog is triggered.

PDI (Process Data Interface) is the internal interface of the ESC, e.g. to local processors in the EtherCAT slave. With the PDI watchdog this communication can be monitored for failure.

The PDI watchdog is therefore a monitoring for correct and timely process data communication with the ESC, but viewed from the application side.

#### Calculation

Watchdog time =  $[1/25 \text{ MHz} * (\text{Watchdog multiplier} + 2)] * \text{PDI/SM watchdog}$

Example: default setting Multiplier=2498, SM watchdog=1000 -> 100 ms

The value in Multiplier + 2 corresponds to the number of 40ns base ticks representing one watchdog tick.

#### ⚠ CAUTION

##### Undefined state possible!

The function for switching off of the SM watchdog via SM watchdog = 0 is only implemented in terminals from version -0016. In previous versions this operating mode should not be used.

#### ⚠ CAUTION

##### Damage of devices and undefined state possible!

If the SM watchdog is activated and a value of 0 is entered the watchdog switches off completely. This is the deactivation of the watchdog! Set outputs are NOT set in a safe state if the communication is interrupted.

## 5.7 EtherCAT State Machine

The state of the EtherCAT slave is controlled via the EtherCAT State Machine (ESM). Depending upon the state, different functions are accessible or executable in the EtherCAT slave. Specific commands must be sent by the EtherCAT master to the device in each state, particularly during the bootup of the slave.

A distinction is made between the following states:

- Init
- Pre-Operational
- Safe-Operational and
- Operational
- Boot

The regular state of each EtherCAT slave after bootup is the OP state.

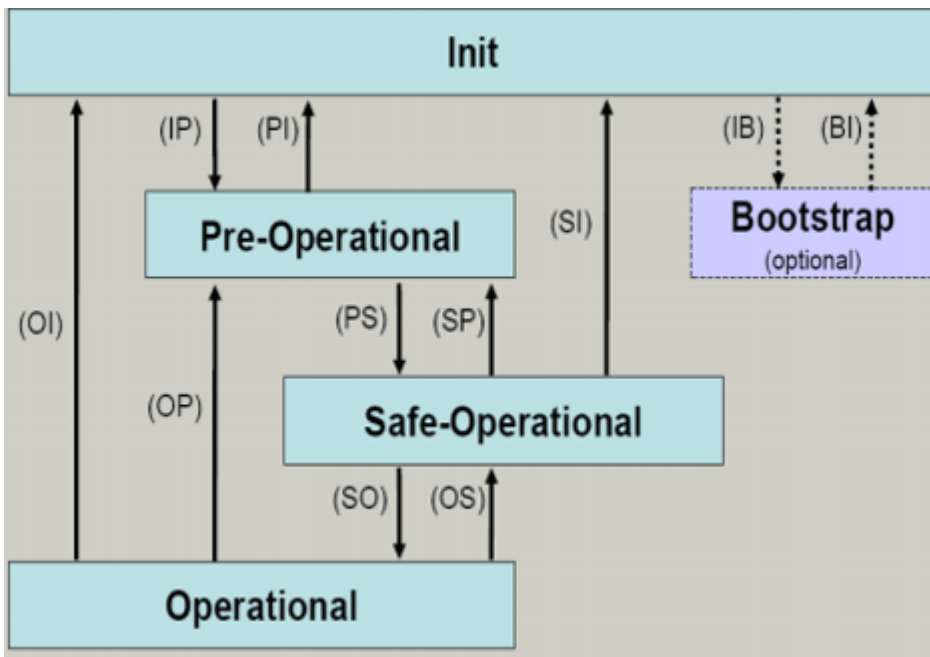

Fig. 172: States of the EtherCAT State Machine

**Init**

After switch-on the EtherCAT slave in the *Init* state. No mailbox or process data communication is possible. The EtherCAT master initializes sync manager channels 0 and 1 for mailbox communication.

**Pre-Operational (Pre-Op)**

During the transition between *Init* and *Pre-Op* the EtherCAT slave checks whether the mailbox was initialized correctly.

In *Pre-Op* state mailbox communication is possible, but not process data communication. The EtherCAT master initializes the sync manager channels for process data (from sync manager channel 2), the FMMU channels and, if the slave supports configurable mapping, PDO mapping or the sync manager PDO assignment. In this state the settings for the process data transfer and perhaps terminal-specific parameters that may differ from the default settings are also transferred.

**Safe-Operational (Safe-Op)**

During transition between *Pre-Op* and *Safe-Op* the EtherCAT slave checks whether the sync manager channels for process data communication and, if required, the distributed clocks settings are correct. Before it acknowledges the change of state, the EtherCAT slave copies current input data into the associated DP-RAM areas of the EtherCAT slave controller (ECSC).

In *Safe-Op* state mailbox and process data communication is possible, although the slave keeps its outputs in a safe state, while the input data are updated cyclically.

**● Outputs in SAFEOP state**

**i** The default set watchdog monitoring sets the outputs of the module in a safe state - depending on the settings in SAFEOP and OP - e.g. in OFF state. If this is prevented by deactivation of the watchdog monitoring in the module, the outputs can be switched or set also in the SAFEOP state.

**Operational (Op)**

Before the EtherCAT master switches the EtherCAT slave from *Safe-Op* to *Op* it must transfer valid output data.

In the *Op* state the slave copies the output data of the masters to its outputs. Process data and mailbox communication is possible.

**Boot**

In the *Boot* state the slave firmware can be updated. The *Boot* state can only be reached via the *Init* state.

In the *Boot* state mailbox communication via the *file access over EtherCAT* (FoE) protocol is possible, but no other mailbox communication and no process data communication.

## 5.8 CoE Interface

### General description

The CoE interface (CAN application protocol over EtherCAT) is used for parameter management of EtherCAT devices. EtherCAT slaves or the EtherCAT master manage fixed (read only) or variable parameters which they require for operation, diagnostics or commissioning.

CoE parameters are arranged in a table hierarchy. In principle, the user has read access via the fieldbus. The EtherCAT master (TwinCAT System Manager) can access the local CoE lists of the slaves via EtherCAT in read or write mode, depending on the attributes.

Different CoE parameter types are possible, including string (text), integer numbers, Boolean values or larger byte fields. They can be used to describe a wide range of features. Examples of such parameters include manufacturer ID, serial number, process data settings, device name, calibration values for analog measurement or passwords.

The order is specified in two levels via hexadecimal numbering: (main)index, followed by subindex. The value ranges are

- Index: 0x0000 ... 0xFFFF (0...65535<sub>dec</sub>)
- SubIndex: 0x00...0xFF (0...255<sub>dec</sub>)

A parameter localized in this way is normally written as 0x8010:07, with preceding "0x" to identify the hexadecimal numerical range and a colon between index and subindex.

The relevant ranges for EtherCAT fieldbus users are:

- 0x1000: This is where fixed identity information for the device is stored, including name, manufacturer, serial number etc., plus information about the current and available process data configurations.
- 0x8000: This is where the operational and functional parameters for all channels are stored, such as filter settings or output frequency.

Other important ranges are:

- 0x4000: here are the channel parameters for some EtherCAT devices. Historically, this was the first parameter area before the 0x8000 area was introduced. EtherCAT devices that were previously equipped with parameters in 0x4000 and changed to 0x8000 support both ranges for compatibility reasons and mirror internally.
- 0x6000: Input PDOs ("input" from the perspective of the EtherCAT master)
- 0x7000: Output PDOs ("output" from the perspective of the EtherCAT master)

---

### **i** Availability

Not every EtherCAT device must have a CoE list. Simple I/O modules without dedicated processor usually have no variable parameters and therefore no CoE list.

---

If a device has a CoE list, it is shown in the TwinCAT System Manager as a separate tab with a listing of the elements:



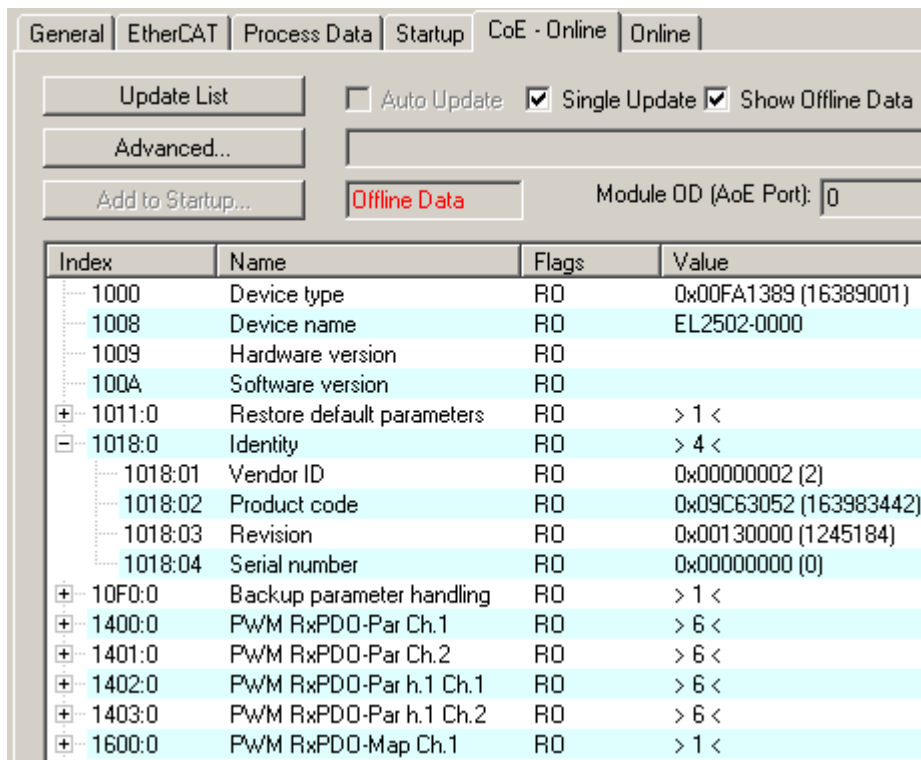

Fig. 173: “CoE Online” tab

The figure above shows the CoE objects available in device “EL2502”, ranging from 0x1000 to 0x1600. The subindices for 0x1018 are expanded.

**NOTICE**

**Changes in the CoE directory (CAN over EtherCAT), program access**

When using/manipulating the CoE parameters observe the general CoE notes in chapter "[CoE interface](#)" of the EtherCAT system documentation:

- Keep a startup list if components have to be replaced,
- Distinction between online/offline dictionary,
- Existence of current XML description (download from the [Beckhoff website](#)),
- "CoE-Reload" for resetting the changes
- Program access during operation via PLC (see [TwinCAT3 | PLC Library: Tc2\\_EtherCAT](#) and [Example program R/W CoE](#))

**Data management and function “NoCoeStorage”**

Some parameters, particularly the setting parameters of the slave, are configurable and writeable. This can be done in write or read mode

- via the System Manager (Fig. “CoE Online” tab) by clicking  
This is useful for commissioning of the system/slaves. Click on the row of the index to be parameterized and enter a value in the “SetValue” dialog.
- from the control system/PLC via ADS, e.g. through blocks from the TcEtherCAT.lib library  
This is recommended for modifications while the system is running or if no System Manager or operating staff are available.

## ● Data management

**i** If slave CoE parameters are modified online, Beckhoff devices store any changes in a fail-safe manner in the EEPROM, i.e. the modified CoE parameters are still available after a restart. The situation may be different with other manufacturers.

An EEPROM is subject to a limited lifetime with respect to write operations. From typically 100,000 write operations onwards it can no longer be guaranteed that new (changed) data are reliably saved or are still readable. This is irrelevant for normal commissioning. However, if CoE parameters are continuously changed via ADS at machine runtime, it is quite possible for the lifetime limit to be reached. Support for the NoCoeStorage function, which suppresses the saving of changed CoE values, depends on the firmware version.

Please refer to the technical data in this documentation as to whether this applies to the respective device.

- If the function is supported: the function is activated by entering the code word 0x12345678 once in CoE 0xF008 and remains active as long as the code word is not changed. After switching the device on it is then inactive. Changed CoE values are not saved in the EEPROM and can thus be changed any number of times.
- Function is not supported: continuous changing of CoE values is not permissible in view of the lifetime limit.

## ● Startup list

**i** Changes in the local CoE list of the terminal are lost if the terminal is replaced. If a terminal is replaced with a new Beckhoff terminal, it will have the default settings. It is therefore advisable to link all changes in the CoE list of an EtherCAT slave with the Startup list of the slave, which is processed whenever the EtherCAT fieldbus is started. In this way a replacement EtherCAT slave can automatically be parameterized with the specifications of the user.

If EtherCAT slaves are used which are unable to store local CoE values permanently, the Startup list must be used.

### Recommended approach for manual modification of CoE parameters

- Make the required change in the System Manager  
The values are stored locally in the EtherCAT slave
- If the value is to be stored permanently, enter it in the Startup list.  
The order of the Startup entries is usually irrelevant.

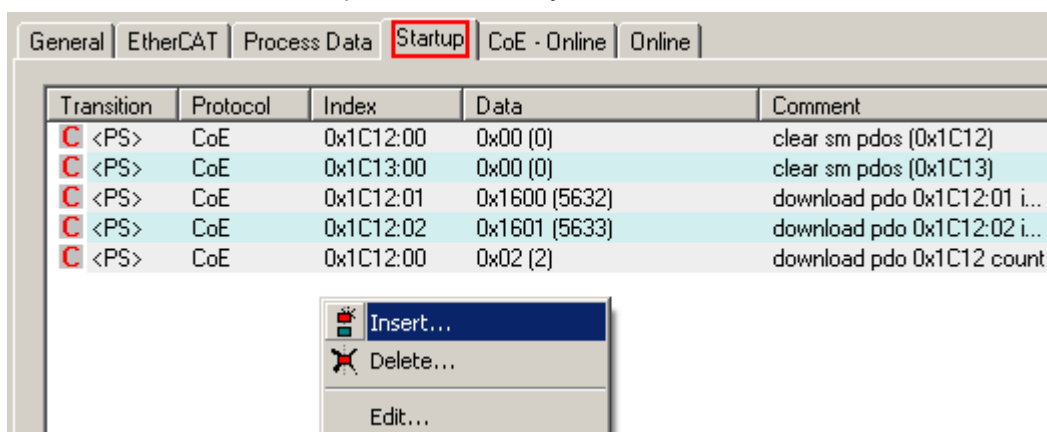

Fig. 174: Startup list in the TwinCAT System Manager

The Startup list may already contain values that were configured by the System Manager based on the ESI specifications. Additional application-specific entries can be created.

### Online/offline list

While working with the TwinCAT System Manager, a distinction has to be made whether the EtherCAT device is “available”, i.e. switched on and linked via EtherCAT and therefore **online**, or whether a configuration is created **offline** without connected slaves.

In both cases a CoE list as shown in Fig. “CoE online tab” is displayed. The connectivity is shown as offline/online.

- If the slave is offline
  - The offline list from the ESI file is displayed. In this case modifications are not meaningful or possible.
  - The configured status is shown under Identity.
  - No firmware or hardware version is displayed, since these are features of the physical device.
  - **Offline** is shown in red.

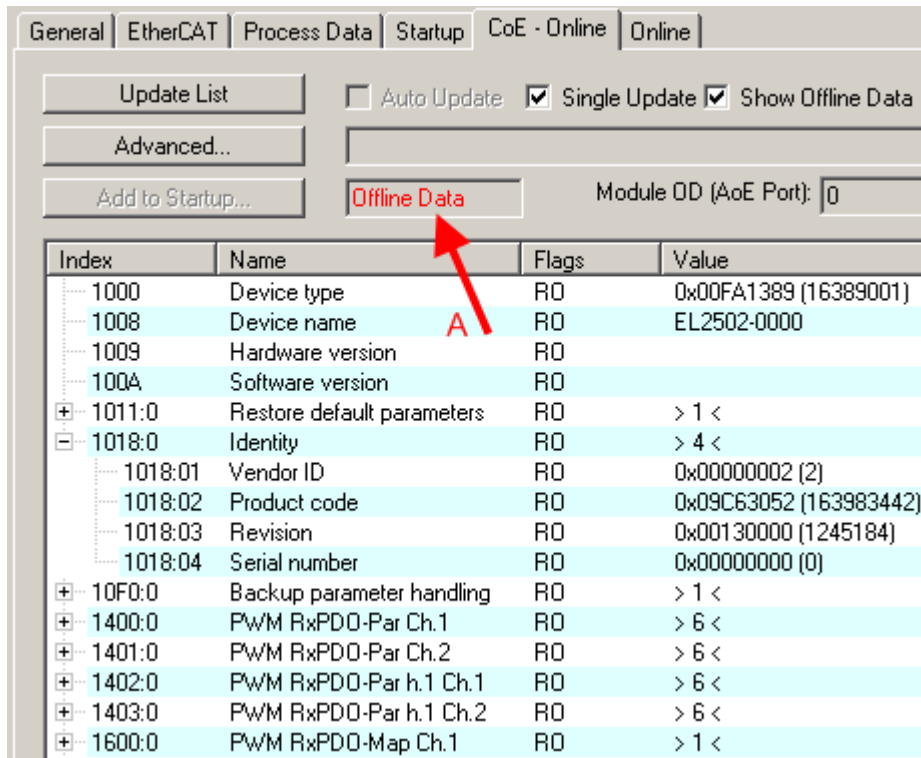

Fig. 175: Offline list

- If the slave is online
  - The actual current slave list is read. This may take several seconds, depending on the size and cycle time.
  - The actual identity is displayed
  - The firmware and hardware version of the equipment according to the electronic information is displayed
  - **Online** is shown in green.

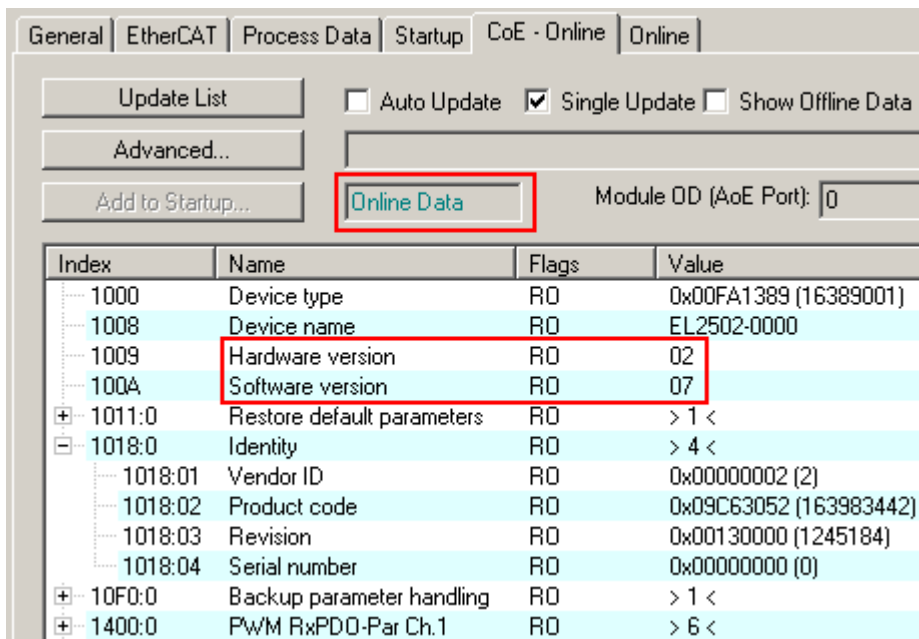

Fig. 176: Online list

### Channel-based order

The CoE list is available in EtherCAT devices that usually feature several functionally equivalent channels. For example, a 4-channel analog 0...10 V input terminal also has four logical channels and therefore four identical sets of parameter data for the channels. In order to avoid having to list each channel in the documentation, the placeholder “n” tends to be used for the individual channel numbers.

In the CoE system 16 indices, each with 255 subindices, are generally sufficient for representing all channel parameters. The channel-based order is therefore arranged in  $16_{\text{dec}}/10_{\text{hex}}$  steps. The parameter range 0x8000 exemplifies this:

- Channel 0: parameter range 0x8000:00 ... 0x800F:255
- Channel 1: parameter range 0x8010:00 ... 0x801F:255
- Channel 2: parameter range 0x8020:00 ... 0x802F:255
- ...

This is generally written as 0x80n0.

Detailed information on the CoE interface can be found in the [EtherCAT system documentation](#) on the Beckhoff website.

## 5.9 Distributed Clock

The distributed clock represents a local clock in the EtherCAT slave controller (ESC) with the following characteristics:

- Unit *1 ns*
- Zero point *1.1.2000 00:00*
- Size *64 bit* (sufficient for the next 584 years; however, some EtherCAT slaves only offer 32-bit support, i.e. the variable overflows after approx. 4.2 seconds)
- The EtherCAT master automatically synchronizes the local clock with the master clock in the EtherCAT bus with a precision of < 100 ns.

For detailed information please refer to the [EtherCAT system description](#).

## 6 Mounting and wiring

### 6.1 Installation positions

#### NOTICE

##### Constraints regarding installation position and operating temperature range

Please refer to the technical data for a terminal to ascertain whether any restrictions regarding the installation position and/or the operating temperature range have been specified. When installing high power dissipation terminals ensure that an adequate spacing is maintained between other components above and below the terminal in order to guarantee adequate ventilation!

##### Optimum installation position (standard)

The optimum installation position requires the mounting rail to be installed horizontally and the connection surfaces of the EL/KL terminals to face forward (see Fig. *Recommended distances for standard installation position*). The terminals are ventilated from below, which enables optimum cooling of the electronics through convection. "From below" is relative to the acceleration of gravity.

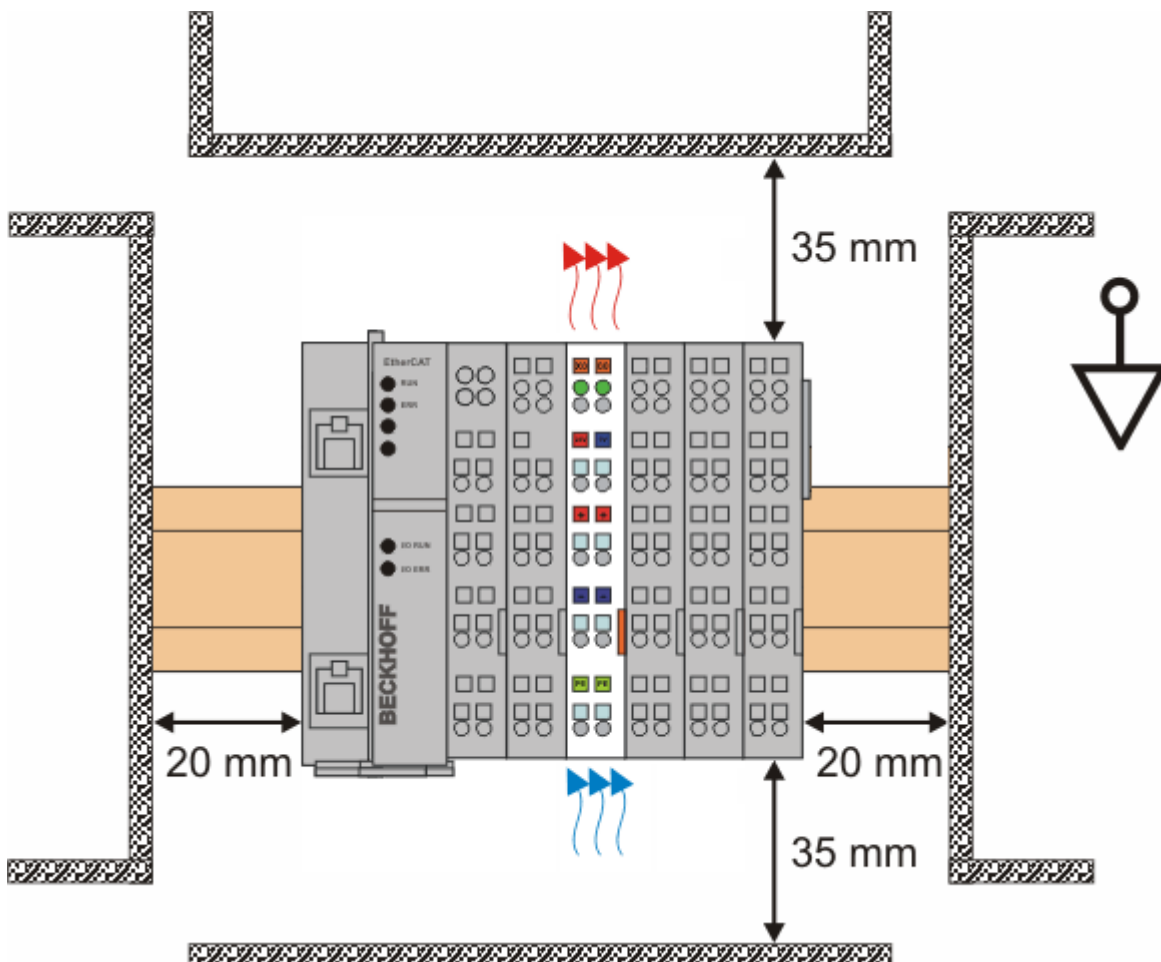

Fig. 177: Recommended distances for standard installation position

Compliance with the distances shown in Fig. *Recommended distances for standard installation position* is recommended.

##### Other installation positions

All other installation positions are characterized by different spatial arrangement of the mounting rail - see Fig. *Other installation positions*.

The minimum distances to ambient specified above also apply to these installation positions.

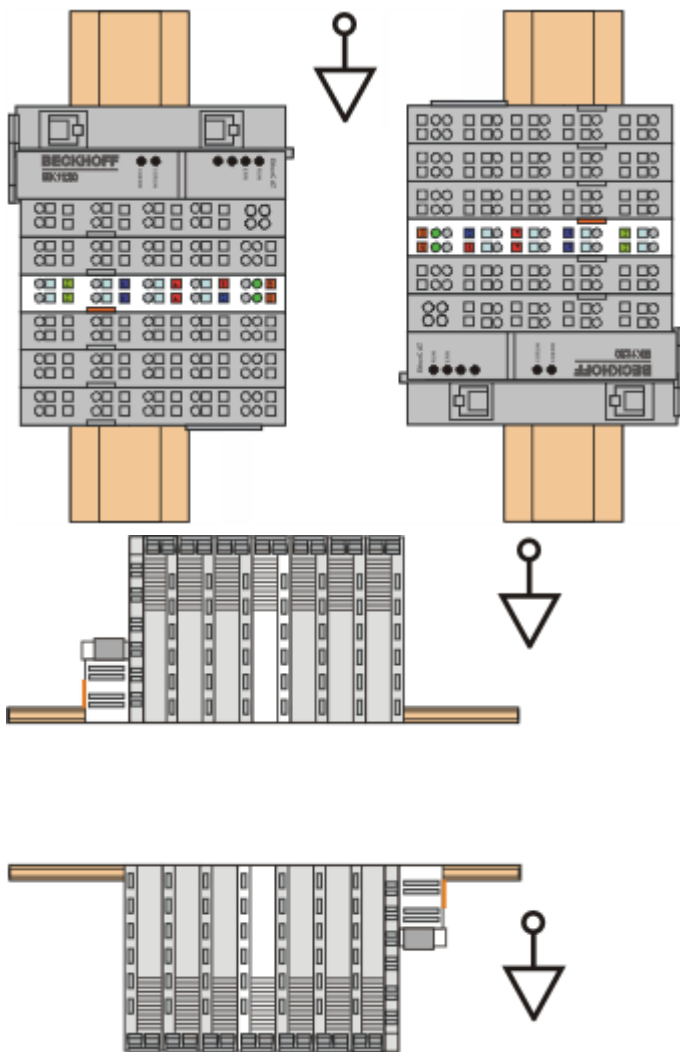

Fig. 178: Other installation positions

## 6.2 Positioning of passive Terminals

**i** **Hint for positioning of passive terminals in the bus terminal block**

EtherCAT Terminals (ELxxxx / ESxxxx), which do not take an active part in data transfer within the bus terminal block are so called passive terminals. The passive terminals have no current consumption out of the E-Bus.

To ensure an optimal data transfer, you must not directly string together more than two passive terminals!

**Examples for positioning of passive terminals (highlighted)**

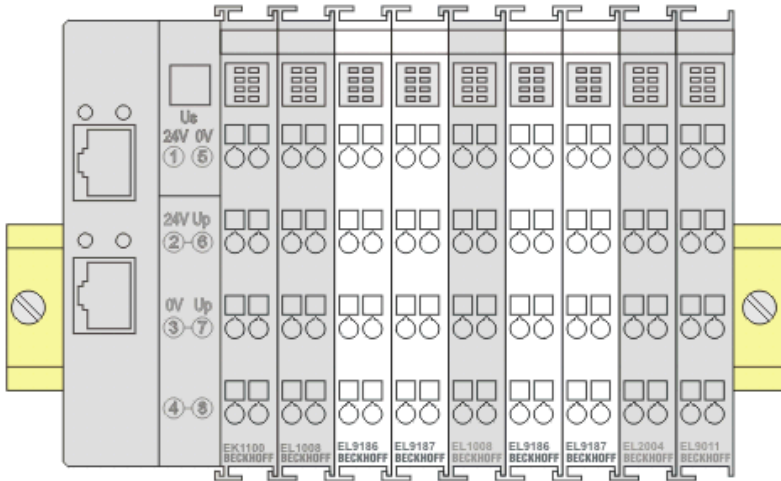

Fig. 179: Correct positioning

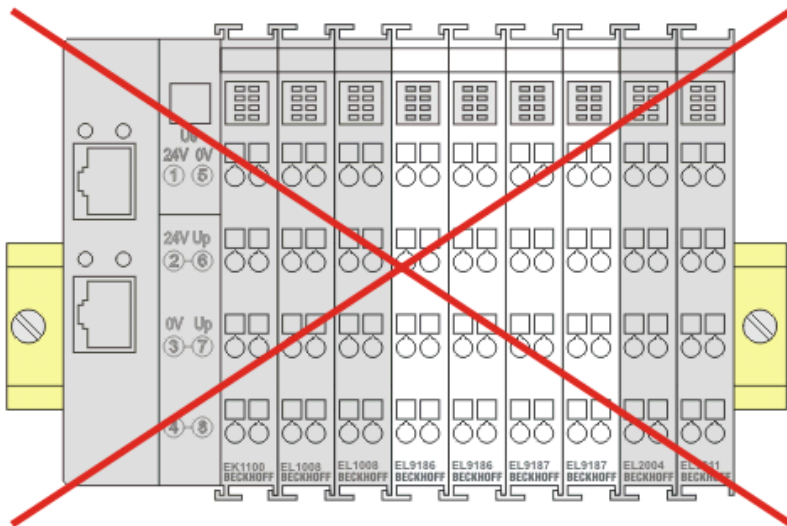

Fig. 180: Incorrect positioning



## 6.3 ATEX - Special conditions (standard temperature range)

### ⚠ WARNING

**Observe the special conditions for the intended use of Beckhoff fieldbus components with standard temperature range in potentially explosive areas (directive 2014/34/EU)!**

- The certified components are to be installed in a suitable housing that guarantees a protection class of at least IP54 in accordance with EN 60079-15! The environmental conditions during use are thereby to be taken into account!
- For dust (only the fieldbus components of certificate no. KEMA 10ATEX0075 X Issue 9): The equipment shall be installed in a suitable enclosure providing a degree of protection of IP54 according to EN 60079-31 for group IIIA or IIIB and IP6X for group IIIC, taking into account the environmental conditions under which the equipment is used!
- If the temperatures during rated operation are higher than 70°C at the feed-in points of cables, lines or pipes, or higher than 80°C at the wire branching points, then cables must be selected whose temperature data correspond to the actual measured temperature values!
- Observe the permissible ambient temperature range of 0 to 55°C for the use of Beckhoff fieldbus components standard temperature range in potentially explosive areas!
- Measures must be taken to protect against the rated operating voltage being exceeded by more than 40% due to short-term interference voltages!
- The individual terminals may only be unplugged or removed from the Bus Terminal system if the supply voltage has been switched off or if a non-explosive atmosphere is ensured!
- The connections of the certified components may only be connected or disconnected if the supply voltage has been switched off or if a non-explosive atmosphere is ensured!
- The fuses of the KL92xx/EL92xx power feed terminals may only be exchanged if the supply voltage has been switched off or if a non-explosive atmosphere is ensured!
- Address selectors and ID switches may only be adjusted if the supply voltage has been switched off or if a non-explosive atmosphere is ensured!

### Standards

The fundamental health and safety requirements are fulfilled by compliance with the following standards:

- EN 60079-0:2012+A11:2013
- EN 60079-15:2010
- EN 60079-31:2013 (only for certificate no. KEMA 10ATEX0075 X Issue 9)

### Marking

The Beckhoff fieldbus components with standard temperature range certified according to the ATEX directive for potentially explosive areas bear one of the following markings:



**II 3G KEMA 10ATEX0075 X Ex nA IIC T4 Gc Ta: 0 ... +55°C**

II 3D KEMA 10ATEX0075 X Ex tc IIIC T135°C Dc Ta: 0 ... +55°C  
(only for fieldbus components of certificate no. KEMA 10ATEX0075 X Issue 9)

or



**II 3G KEMA 10ATEX0075 X Ex nA nC IIC T4 Gc Ta: 0 ... +55°C**

II 3D KEMA 10ATEX0075 X Ex tc IIIC T135°C Dc Ta: 0 ... +55°C  
(only for fieldbus components of certificate no. KEMA 10ATEX0075 X Issue 9)

## 6.4 Notes regarding connectors and wiring

It is in the very nature of EtherCAT I/O modules/terminals/box modules that they have two connection sides: one to the fieldbus for communication with the module, which is obligatory, the other to the signal/sensor/actuator to facilitate proper use of the module. The “outer” connection side usually features contacting options for connecting outgoing wires.

Only few I/O devices do not have a second side. Examples include the EL6070 license key terminal and the EL6090 display terminal.

Notes and suggestions for dealing with the connection options are provided below

- **Manufacturer specifications**/notes for connection options must be followed. Any special tools that may have been provided must be used as intended, so that gas-tightness is ensured through the crimping pressure.
- Any detachable connection system is subject to a specified maximum number of **connection cycles**. Each connection/disconnection operation results in wear through friction, mechanical stretching/relaxation, possibly ingress of contaminants/gases/liquids/condensation, contact discharge, modification of the electrical properties and of the contact point (ohmic contact resistance). In other words, releasing/connecting a contact results in mechanical, chemical and therefore ultimately electrical changes.  
In terms of the application scenario it is therefore important to select suitable connection systems or devices with suitable connection systems:
  - For connections that are more or less permanent, it may make sense to use connectors/contacts with a maximum **number of mating cycles** (as specified by the manufacturer) of 10 to 100 cycles. This may be the case if devices are installed/wired only once, and over the entire lifetime rewiring is only expected to become necessary during maintenance work.
  - For connections that have to be detached on a regular basis, connectors/contacts with a maximum number of mating cycles of 1,000 or higher should be selected. Such connections can typically be found in laboratory environments, where the cabling may be changed several times each day but high-quality contact must nevertheless be ensured over many years.
- When handling and assembling connectors/contacts it is essential to avoid **contact with hand perspiration/liquids**, even for low-tech connections (open stranded wire, cage clamp/push-in). Acidic/alkaline liquids may have a very aggressive effect on the contact surface and quickly lead to structural changes and oxidation layers. These are very disruptive for analog measurements, particularly since they undermine the reproducibility of measurements and can therefore result (if known) in large systematic measurement uncertainty. It may be possible to rectify the problem by thorough follow-up cleaning.
- The actual/expected **load during operation** must be taken into account when selecting connectors.
- Abnormal vibrations can lead to microfriction/corrosion and change the electrical properties, potentially resulting in complete loss of contact.
- Temperature variations affect the mechanical strength of the connection and the spring forces in metallic components.
- Exposure to gas or liquid can damage the connection, particularly if the gas or liquid penetrates to the actual contact region and is unable to escape from there.
- Of high relevance for analog measurements is the **electrical quality** of the connection, both in the short term during commissioning and over the service life under external influences and perhaps repeated mating cycles. This is expressed in the repeatability of the transition. The influence should be checked against the expected accuracy. Of particular relevance is the (frequency dependent) contact resistance. Effects can be:
  - Increasing the contact resistance results in a voltage drop when power is transmitted, potentially leading to critical self-heating.
  - The internal voltage drop can distort corresponding measurements. In order to avoid negative effects, 4/5/6-wire connections should be used in SG/resistance measurements, since non-live contacts are no longer affected by a distorting voltage drop. The popular 3-wire connection for resistance measurement (PT100, PT1000 etc.) does not provide absolute protection, since the singular line cannot be diagnosed. Current/voltage measurements in industrial environments are less sensitive to contact changes.

- A defective contact surface can lead to random resistance values, depending on the contact position and temperature. This makes reproducible measurements difficult.
- The **effort for establishing the connection**, including assembling the cables and connectors, generally increases with increasing transmission quality requirements. This applies to the tools, diligence and time required. Examples:
  - Cage clamp/push-in connections (e.g. Beckhoff EL terminals), which are common in automation applications, can be established or released in a few seconds with or without ferrule. A screwdriver or push pin is sufficient. On the other hand, in many cases the (ohmic) repeatability is insufficient for high-precision measurements in the SG/R range.
  - Some 10 minutes and costs of some 10 euros should be assumed for assembly a lab-standard LEMO/ODU connector (Beckhoff ELM3704-0001), depending on the number of poles. The result is a top-quality connection system with a high number of permissible mating cycles.
  - An intermediate solution can be field-configurable M8/M12 connections. For reasons of tightness, they are more elaborate to assemble (soldering or insulation displacement contact, if necessary), although the maximum number of mating cycles is similar to maintenance connectors.
- A pre-assembled connection should be subjected to electrical/mechanical testing before commissioning: visual inspection, pull-out test, crimp height measurement, resistance measurement etc.

## 6.5 Shielding concept

Together with the shield busbar, the prefabricated cables from Beckhoff Automation offer optimum protection against electromagnetic interference.

It is highly recommended to apply the shield as close as possible to the terminal, in order to minimize operational disturbances.

### Connection of the motor cable to the shield busbar

Fasten the shield busbar supports 1 to the DIN rail 2. The mounting rail 2 must be in contact with the metallic rear wall of the control cabinet over a wide area. Install the shield busbar 3 as shown below.

As an alternative, a shield busbar clamp 3a can be screwed directly to the metallic rear wall of the control cabinet (fig. "shield busbar clamp")

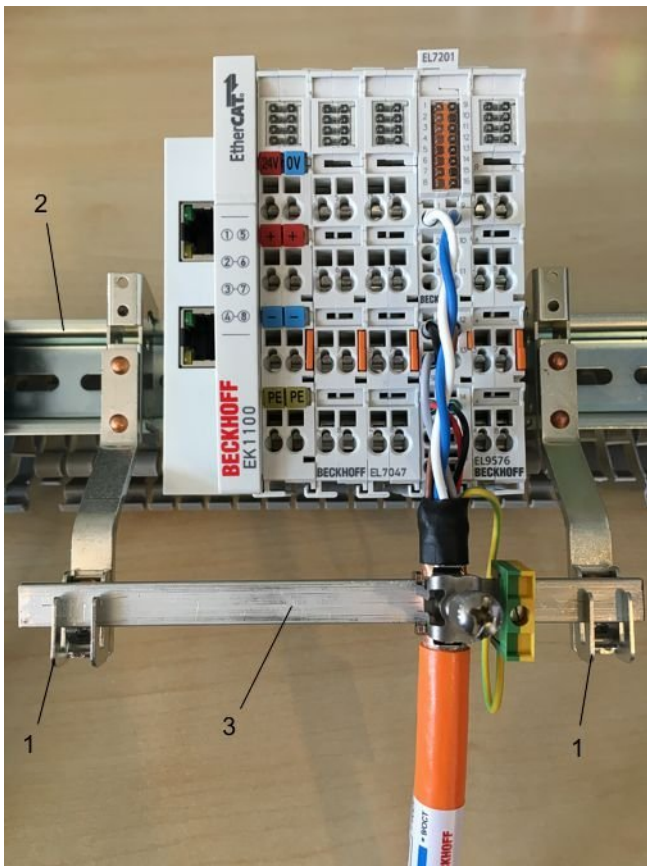

Fig. 181: Shield busbar

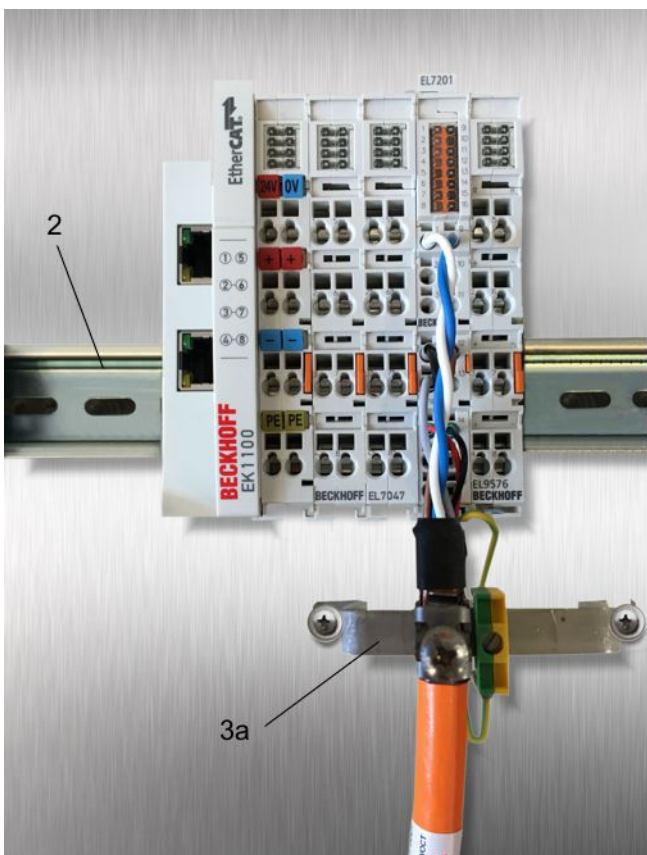

Fig. 182: Shield busbar clamp

Connect the cores 4 of the motor cable 5, then attach the copper-sheathed end 6 of the motor cable 5 with the shield clamp 7 to the shield busbar 3 or shield busbar clamp 3a. Tighten the screw 8 to the stop. Fasten the PE clamp 9 to the shield busbar 3 or shield busbar clamp 3a. Clamp the PE core 10 of the motor cable 5 under the PE clamp 9.

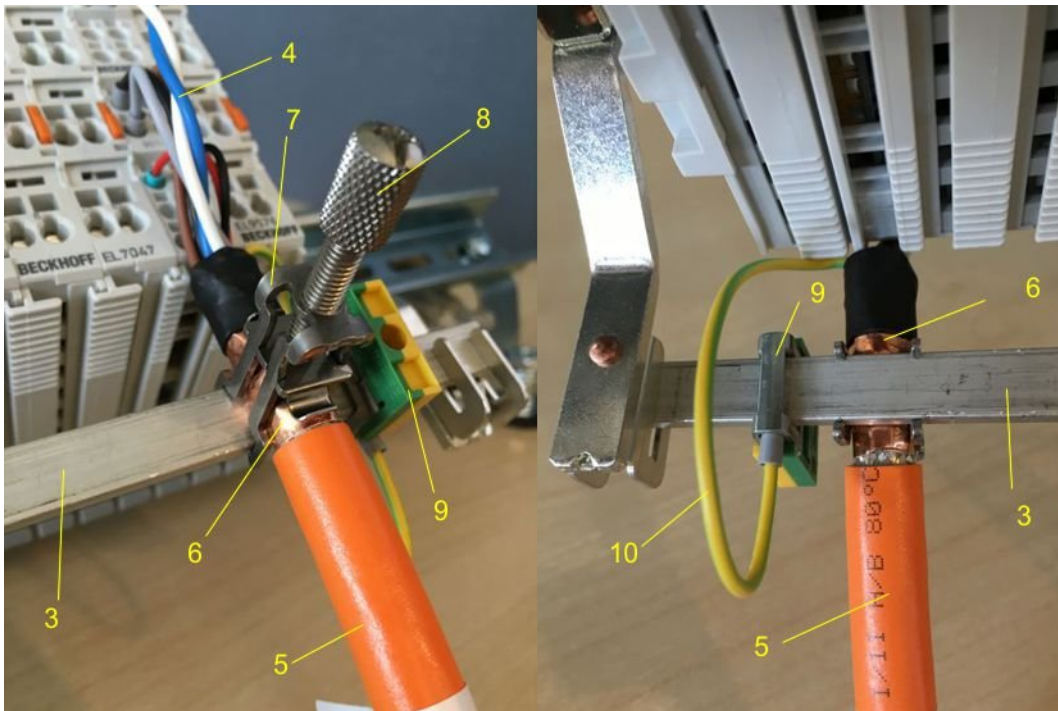

Fig. 183: Shield connection

**Connection of the feedback cable to the motor**

**● Twisting of the feedback cable cores**

**i** The feedback cable cores should be twisted, in order to avoid operational disturbances.

When screwing the feedback plug to the motor, the shield of the feedback cable is connected via the metallic plug fastener.

On the terminal side the shield can also be connected. Connect the cores of the feedback cable and attach the copper-sheathed end of the feedback cable to the shield busbar 3 or shield busbar clamp 3a with the shield clamp 7. The motor cable and the feedback cable can be connected to the shield clamp 7 with the screw 8.

**6.6 Installation on mounting rails**

**⚠ WARNING**

**Risk of electric shock and damage of device!**

Bring the bus terminal system into a safe, powered down state before starting installation, disassembly or wiring of the bus terminals!

The Bus Terminal system and is designed for mounting in a control cabinet or terminal box.



## Assembly

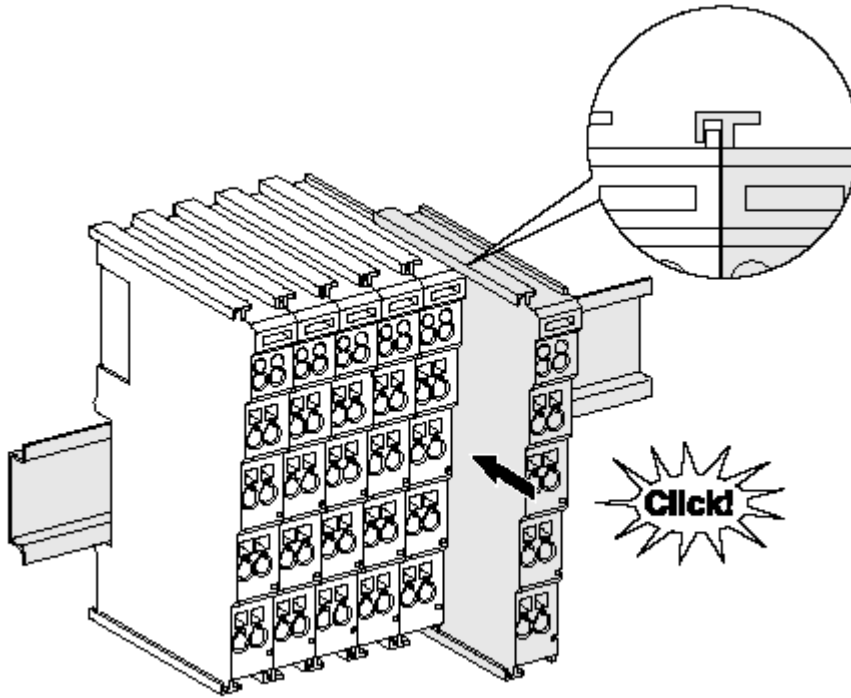

Fig. 184: Attaching on mounting rail

The bus coupler and bus terminals are attached to commercially available 35 mm mounting rails (DIN rails according to EN 60715) by applying slight pressure:

1. First attach the fieldbus coupler to the mounting rail.
2. The bus terminals are now attached on the right-hand side of the fieldbus coupler. Join the components with tongue and groove and push the terminals against the mounting rail, until the lock clicks onto the mounting rail.

If the terminals are clipped onto the mounting rail first and then pushed together without tongue and groove, the connection will not be operational! When correctly assembled, no significant gap should be visible between the housings.

### **i** Fixing of mounting rails

The locking mechanism of the terminals and couplers extends to the profile of the mounting rail. At the installation, the locking mechanism of the components must not come into conflict with the fixing bolts of the mounting rail. To mount the mounting rails with a height of 7.5 mm under the terminals and couplers, you should use flat mounting connections (e.g. countersunk screws or blind rivets).

Disassembly

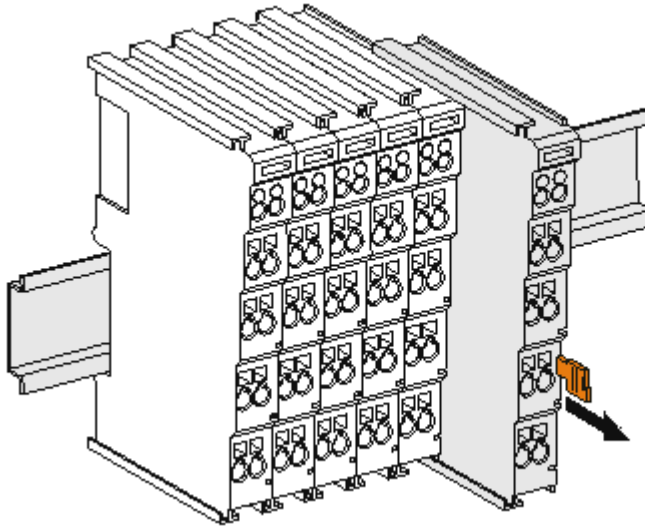

Fig. 185: Disassembling of terminal

Each terminal is secured by a lock on the mounting rail, which must be released for disassembly:

1. Pull the terminal by its orange-colored lugs approximately 1 cm away from the mounting rail. In doing so for this terminal the mounting rail lock is released automatically and you can pull the terminal out of the bus terminal block easily without excessive force.
2. Grasp the released terminal with thumb and index finger simultaneous at the upper and lower grooved housing surfaces and pull the terminal out of the bus terminal block.

**Connections within a bus terminal block**

The electric connections between the Bus Coupler and the Bus Terminals are automatically realized by joining the components:

- The six spring contacts of the K-Bus/E-Bus deal with the transfer of the data and the supply of the Bus Terminal electronics.
- The power contacts deal with the supply for the field electronics and thus represent a supply rail within the bus terminal block. The power contacts are supplied via terminals on the Bus Coupler (up to 24 V) or for higher voltages via power feed terminals.

● **Power Contacts**

**i** During the design of a bus terminal block, the pin assignment of the individual Bus Terminals must be taken account of, since some types (e.g. analog Bus Terminals or digital 4-channel Bus Terminals) do not or not fully loop through the power contacts. Power Feed Terminals (KL91xx, KL92xx or EL91xx, EL92xx) interrupt the power contacts and thus represent the start of a new supply rail.

**PE power contact**

The power contact labeled PE can be used as a protective earth. For safety reasons this contact mates first when plugging together, and can ground short-circuit currents of up to 125 A.

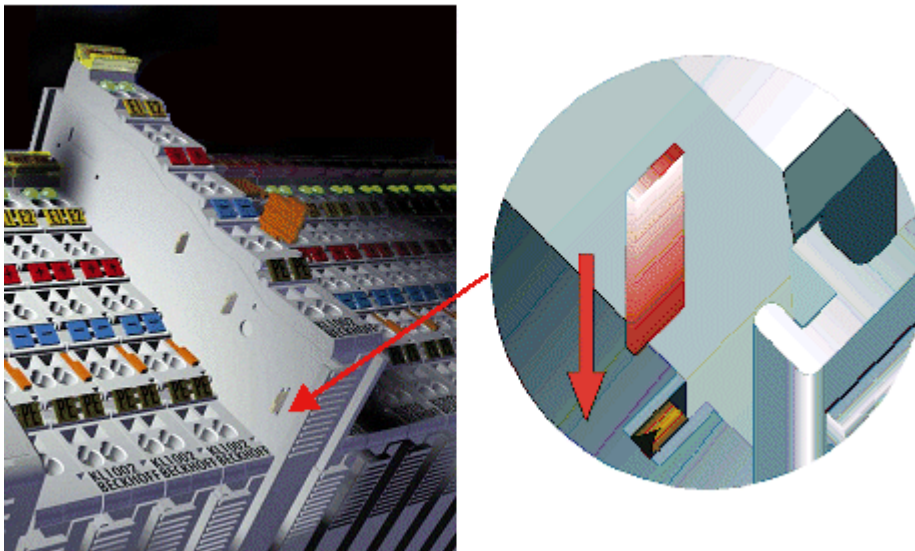

Fig. 186: Power contact on left side

**NOTICE****Possible damage of the device**

Note that, for reasons of electromagnetic compatibility, the PE contacts are capacitatively coupled to the mounting rail. This may lead to incorrect results during insulation testing or to damage on the terminal (e.g. disruptive discharge to the PE line during insulation testing of a consumer with a nominal voltage of 230 V). For insulation testing, disconnect the PE supply line at the Bus Coupler or the Power Feed Terminal! In order to decouple further feed points for testing, these Power Feed Terminals can be released and pulled at least 10 mm from the group of terminals.

**⚠ WARNING****Risk of electric shock!**

The PE power contact must not be used for other potentials!

## 6.7 Connection

### 6.7.1 Connection system

**⚠ WARNING****Risk of electric shock and damage of device!**

Bring the bus terminal system into a safe, powered down state before starting installation, disassembly or wiring of the bus terminals!

**Overview**

The bus terminal system offers different connection options for optimum adaptation to the respective application:

- The terminals of ELxxxx and KLxxxx series with standard wiring include electronics and connection level in a single enclosure.
- The terminals of ESxxxx and KSxxxx series feature a pluggable connection level and enable steady wiring while replacing.
- The High Density Terminals (HD Terminals) include electronics and connection level in a single enclosure and have advanced packaging density.



### Standard wiring (ELxxxx / KLxxxx)

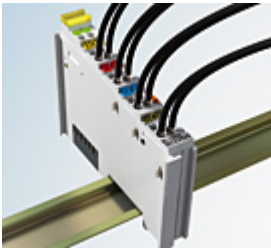

Fig. 187: Standard wiring

The terminals of ELxxxx and KLxxxx series have been tried and tested for years. They feature integrated screwless spring force technology for fast and simple assembly.

### Pluggable wiring (ESxxxx / KSxxxx)



Fig. 188: Pluggable wiring

The terminals of ESxxxx and KSxxxx series feature a pluggable connection level. The assembly and wiring procedure is the same as for the ELxxxx and KLxxxx series. The pluggable connection level enables the complete wiring to be removed as a plug connector from the top of the housing for servicing. The lower section can be removed from the terminal block by pulling the unlocking tab. Insert the new component and plug in the connector with the wiring. This reduces the installation time and eliminates the risk of wires being mixed up.

The familiar dimensions of the terminal only had to be changed slightly. The new connector adds about 3 mm. The maximum height of the terminal remains unchanged.

A tab for strain relief of the cable simplifies assembly in many applications and prevents tangling of individual connection wires when the connector is removed.

Conductor cross sections between 0.08 mm<sup>2</sup> and 2.5 mm<sup>2</sup> can continue to be used with the proven spring force technology.

The overview and nomenclature of the product names for ESxxxx and KSxxxx series has been retained as known from ELxxxx and KLxxxx series.

### High Density Terminals (HD Terminals)



Fig. 189: High Density Terminals

The terminals from these series with 16 terminal points are distinguished by a particularly compact design, as the packaging density is twice as large as that of the standard 12 mm bus terminals. Massive conductors and conductors with a wire end sleeve can be inserted directly into the spring loaded terminal point without tools.

---

**● Wiring HD Terminals**

**i** The High Density Terminals of the ELx8xx and KLx8xx series doesn't support pluggable wiring.

---

**Ultrasonically “bonded” (ultrasonically welded) conductors****● Ultrasonically “bonded” conductors**

**i** It is also possible to connect the Standard and High Density Terminals with ultrasonically “bonded” (ultrasonically welded) conductors. In this case, please note the tables concerning the wire-size width [▶ 231]!

---

## 6.7.2 Wiring

**⚠ WARNING**

**Risk of electric shock and damage of device!**

Bring the bus terminal system into a safe, powered down state before starting installation, disassembly or wiring of the bus terminals!

**Terminals for standard wiring ELxxxx/KLxxxx and for pluggable wiring ESxxxx/KSxxxx**

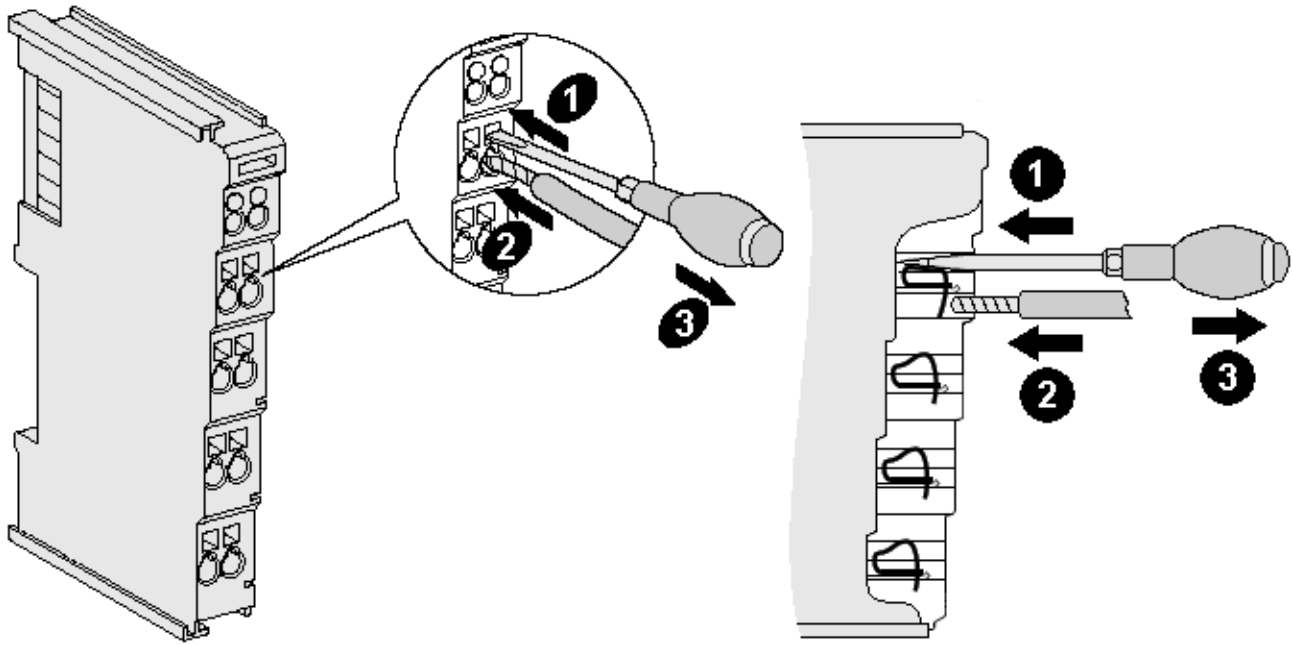

Fig. 190: Connecting a cable on a terminal point

Up to eight terminal points enable the connection of solid or finely stranded cables to the bus terminal. The terminal points are implemented in spring force technology. Connect the cables as follows:

1. Open a terminal point by pushing a screwdriver straight against the stop into the square opening above the terminal point. Do not turn the screwdriver or move it alternately (don't toggle).
2. The wire can now be inserted into the round terminal opening without any force.
3. The terminal point closes automatically when the pressure is released, holding the wire securely and permanently.

See the following table for the suitable wire size width.

Terminal housing	ELxxxx, KLxxxx	ESxxxx, KSxxxx
Wire size width (single core wires)	0.08 ... 2.5 mm <sup>2</sup>	0.08 ... 2.5 mm <sup>2</sup>
Wire size width (fine-wire conductors)	0.08 ... 2.5 mm <sup>2</sup>	0.08 ... 2.5 mm <sup>2</sup>
Wire size width (conductors with a wire end sleeve)	0.14 ... 1.5 mm <sup>2</sup>	0.14 ... 1.5 mm <sup>2</sup>
Wire stripping length	8 ... 9 mm	9 ... 10 mm

### High Density Terminals ([HD Terminals](#) [▶ 229]) with 16 terminal points

The conductors of the HD Terminals are connected without tools for single-wire conductors using the direct plug-in technique, i.e. after stripping the wire is simply plugged into the terminal point. The cables are released, as usual, using the contact release with the aid of a screwdriver. See the following table for the suitable wire size width.

Terminal housing	High Density Housing
Wire size width (single core wires)	0.08 ... 1.5 mm <sup>2</sup>

Wire size width (fine-wire conductors)	0.25 ... 1.5 mm <sup>2</sup>
Wire size width (conductors with a wire end sleeve)	0.14 ... 0.75 mm <sup>2</sup>
Wire size width (ultrasonically "bonded" conductors)	only 1.5 mm <sup>2</sup> (see notice   230 )
Wire stripping length	8 ... 9 mm

### 6.7.3 Shielding



#### Shielding

Encoder, analog sensors and actuators should always be connected with shielded, twisted paired wires.

### 6.8 Note - Power supply

**⚠ WARNING**

#### Power supply from SELV/PELV power supply unit!

SELV/PELV circuits (Safety Extra Low Voltage, Protective Extra Low Voltage) according to IEC 61010-2-201 must be used to supply this device.

Notes:

- SELV/PELV circuits may give rise to further requirements from standards such as IEC 60204-1 et al, for example with regard to cable spacing and insulation.
- A SELV (Safety Extra Low Voltage) supply provides safe electrical isolation and limitation of the voltage without a connection to the protective conductor, a PELV (Protective Extra Low Voltage) supply also requires a safe connection to the protective conductor.

### 6.9 LED indicators - meanings

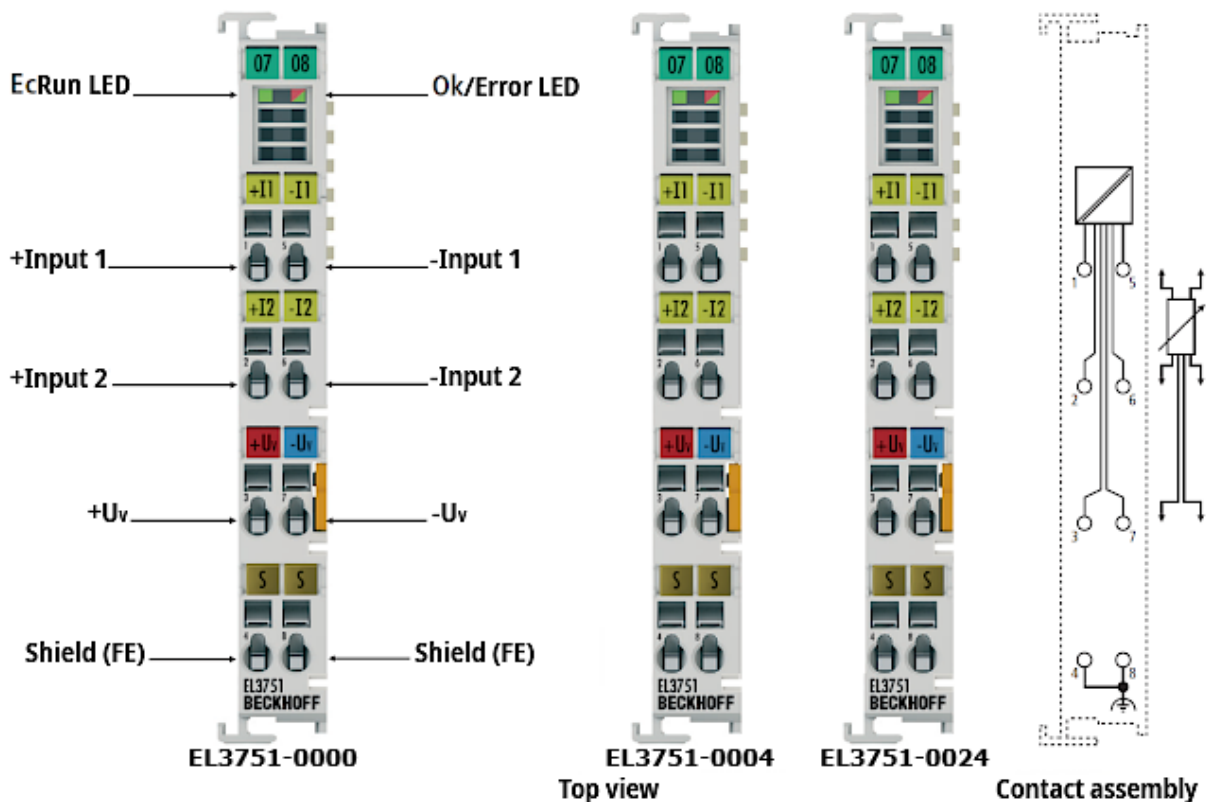

LED	Color	Meaning
EcRun	green	off
State of the EtherCAT State Machine: <b>INIT</b> = initialization of the terminal		

LED	Color	Meaning
		flashing rapidly State of the EtherCAT State Machine: <b>BOOTSTRAP</b> = function for firmware updates of the terminal
		flashing State of the EtherCAT State Machine: <b>PREOP</b> = function for mailbox communication and different standard-settings set
		single flash State of the EtherCAT State Machine: <b>SAFEOP</b> = function for mailbox communication and different standard-settings set Outputs remain in safe state
		on State of the EtherCAT State Machine: <b>OP</b> = normal operating state; mailbox and process data communication is possible

LED	Color	Meaning
Ok/Error	green	No error
	red	<p>Error display, along with error bit in the status, for</p> <ul style="list-style-type: none"> <li>• Measuring range error (not for underrange/overrange!)</li> <li>• Set measuring type is not calibrated (see CoE object 0x800F [► 98])</li> <li>• Processor overload (see CoE object 0xF900 [► 104] "InfoData")</li> <li>• ADC in "saturation"</li> <li>• Analog circuit "in overload", over voltage detected at inputs; see notes in section "Technical data [► 18]" and following section "Connection [► 233]"</li> <li>• Oversampling Error in Synchron Mode</li> </ul>
	off	No operation

## 6.10 Connection

Terminal point		
Name	No.	Description
+Input 1	1	+Input 1
+Input 2	2	+Input 2
+Uv	3	+Supply voltage
Shield	4	Shield (FE)/ SGND
-Input 1	5	-Input 1
-Input 2	6	-Input 2
-Uv (GND <sub>int</sub> )	7	-Supply voltage (internal ground)
Shield	8	Shield (FE)/ SGND

## 6.11 Disposal



Products marked with a crossed-out wheeled bin shall not be discarded with the normal waste stream. The device is considered as waste electrical and electronic equipment. The national regulations for the disposal of waste electrical and electronic equipment must be observed.

## 7 Appendix

### 7.1 Diagnostics - basic principles of diag messages

*DiagMessages* designates a system for the transmission of messages from the EtherCAT Slave to the EtherCAT Master/TwinCAT. The messages are stored by the device in its own CoE under 0x10F3 and can be read by the application or the System Manager. An error message referenced via a code is output for each event stored in the device (warning, error, status change).

#### Definition

The *DiagMessages* system is defined in the ETG (EtherCAT Technology Group) in the guideline ETG.1020, chapter 13 "Diagnosis handling". It is used so that pre-defined or flexible diagnostic messages can be conveyed from the EtherCAT Slave to the Master. In accordance with the ETG, the process can therefore be implemented supplier-independently. Support is optional. The firmware can store up to 250 *DiagMessages* in its own CoE.

Each *DiagMessage* consists of

- Diag Code (4-byte)
- Flags (2-byte; info, warning or error)
- Text ID (2-byte; reference to explanatory text from the ESI/XML)
- Timestamp (8-byte, local slave time or 64-bit Distributed Clock time, if available)
- Dynamic parameters added by the firmware

The *DiagMessages* are explained in text form in the ESI/XML file belonging to the EtherCAT device: on the basis of the Text ID contained in the *DiagMessage*, the corresponding plain text message can be found in the languages contained in the ESI/XML. In the case of Beckhoff products these are usually German and English.

Via the entry *NewMessagesAvailable* the user receives information that new messages are available.

*DiagMessages* can be confirmed in the device: the last/latest unconfirmed message can be confirmed by the user.

In the CoE both the control entries and the history itself can be found in the CoE object 0x10F3:

Index	Name	Flags	Value
1018:0	Identity	RO	> 4 <
10F0:0	Backup parameter handling	RO	> 1 <
10F3:0	Diagnosis History	RO	> 55 <
10F3:01	Maximum Messages	RO	0x32 (50)
10F3:02	Newest Message	RO	0x15 (21)
10F3:03	Newest Acknowledged Message	R/W	0x14 (20)
10F3:04	New Messages Available	RO	FALSE
10F3:05	Flags	R/W	0x0000 (0)
10F3:06	Diagnosis Message 001	RO	00 E0 A4 08 10 00 03 00 60 1F 0D 00 00 00 00 00 06 00 00 00 06 00 00 00 06 00 00 00 06 00 FF 00
10F3:07	Diagnosis Message 002	RO	00 E0 A4 08 10 00 02 00 00 6A 18 00 00 00 00 00 06 00 00 00 06 00 00 00 06 00 00 00 06 00 00 00
10F3:08	Diagnosis Message 003	RO	00 E0 A4 08 10 00 03 00 40 D8 67 02 00 00 00 00 06 00 00 00 06 00 00 00 06 00 03 00 06 00 00 00
10F3:09	Diagnosis Message 004	RO	00 E0 A4 08 12 00 00 81 E0 89 47 03 00 00 00 00 06 00 04 44 06 00 00 00 06 00 00 00

Fig. 191: *DiagMessages* in the CoE

The subindex of the latest *DiagMessage* can be read under 0x10F3:02.

**i Support for commissioning**

The DiagMessages system is to be used above all during the commissioning of the plant. The diagnostic values e.g. in the StatusWord of the device (if available) are helpful for online diagnosis during the subsequent continuous operation.

**TwinCAT System Manager implementation**

From TwinCAT 2.11 DiagMessages, if available, are displayed in the device's own interface. Operation (collection, confirmation) also takes place via this interface.

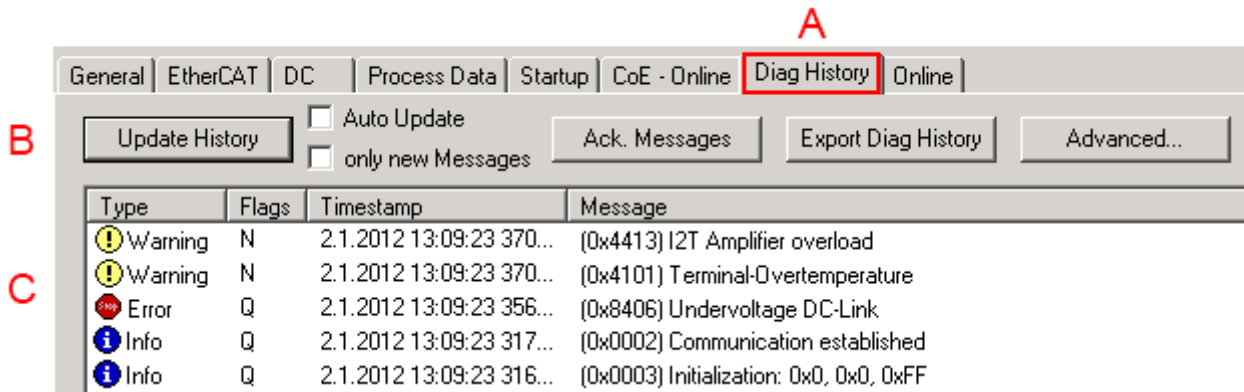

Fig. 192: Implementation of the DiagMessage system in the TwinCAT System Manager

The operating buttons (B) and the history read out (C) can be seen on the Diag History tab (A). The components of the message:

- Info/Warning/Error
- Acknowledge flag (N = unconfirmed, Q = confirmed)
- Time stamp
- Text ID
- Plain text message according to ESI/XML data

The meanings of the buttons are self-explanatory.

**DiagMessages within the ADS Logger/Eventlogger**

From TwinCAT 3.1 build 4022 onwards, DiagMessages sent by the terminal are shown by the TwinCAT ADS Logger. Given that DiagMessages are represented IO- comprehensive at one place, commissioning will be simplified. In addition, the logger output could be stored into a data file – hence DiagMessages are available long-term for analysis.

DiagMessages are actually only available locally in CoE 0x10F3 in the terminal and can be read out manually if required, e.g. via the DiagHistory mentioned above.

In the latest developments, the EtherCAT Terminals are set by default to report the presence of a DiagMessage as emergency via EtherCAT; the event logger can then retrieve the DiagMessage. The function is activated in the terminal via 0x10F3:05, so such terminals have the following entry in the StartUp list by default:

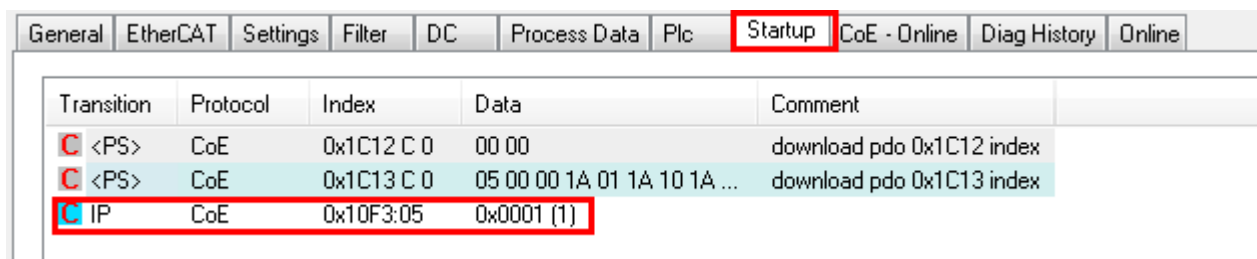

Fig. 193: Startup List



If the function is to be deactivated because, for example, many messages come in or the EventLogger is not used, the StartUp entry can be deleted or set to 0. The value can then be set back to 1 later from the PLC via CoE access if required.

**Reading messages into the PLC**

- In preparation -

**Interpretation**

**Time stamp**

The time stamp is obtained from the local clock of the terminal at the time of the event. The time is usually the distributed clock time (DC) from register x910.

Please note: When EtherCAT is started, the DC time in the reference clock is set to the same time as the local IPC/TwinCAT time. From this moment the DC time may differ from the IPC time, since the IPC time is not adjusted. Significant time differences may develop after several weeks of operation without a EtherCAT restart. As a remedy, external synchronization of the DC time can be used, or a manual correction calculation can be applied, as required: The current DC time can be determined via the EtherCAT master or from register x901 of the DC slave.

**Structure of the Text ID**

The structure of the MessageID is not subject to any standardization and can be supplier-specifically defined. In the case of Beckhoff EtherCAT devices (EL, EP) it usually reads according to **xyzz**:

<b>x</b>	<b>y</b>	<b>zz</b>
0: Systeminfo 2: reserved 1: Info 4: Warning 8: Error	0: System 1: General 2: Communication 3: Encoder 4: Drive 5: Inputs 6: I/O general 7: reserved	Error number

Example: Message 0x4413 --> Drive Warning Number 0x13

**Overview of text IDs**

Specific text IDs are listed in the device documentation.

<b>Text ID</b>	<b>Type</b>	<b>Place</b>	<b>Text Message</b>	<b>Additional comment</b>
0x0001	Information	System	No error	No error
0x0002	Information	System	Communication established	Connection established
0x0003	Information	System	Initialization: 0x%X, 0x%X, 0x%X	General information; parameters depend on event. See device documentation for interpretation.
0x1000	Information	System	Information: 0x%X, 0x%X, 0x%X	General information; parameters depend on event. See device documentation for interpretation.
0x1012	Information	System	EtherCAT state change Init - PreOp	
0x1021	Information	System	EtherCAT state change PreOp - Init	
0x1024	Information	System	EtherCAT state change PreOp - Safe-Op	
0x1042	Information	System	EtherCAT state change SafeOp - PreOp	
0x1048	Information	System	EtherCAT state change SafeOp - Op	
0x1084	Information	System	EtherCAT state change Op - SafeOp	
0x1100	Information	General	Detection of operation mode completed: 0x%X, %d	Detection of the mode of operation ended

Text ID	Type	Place	Text Message	Additional comment
0x1135	Information	General	Cycle time o.k.: %d	Cycle time OK
0x1157	Information	General	Data manually saved (Idx: 0x%X, SubIdx: 0x%X)	Data saved manually
0x1158	Information	General	Data automatically saved (Idx: 0x%X, SubIdx: 0x%X)	Data saved automatically
0x1159	Information	General	Data deleted (Idx: 0x%X, SubIdx: 0x%X)	Data deleted
0x117F	Information	General	Information: 0x%X, 0x%X, 0x%X	Information
0x1201	Information	Communication	Communication re-established	Communication to the field side restored This message appears, for example, if the voltage was removed from the power contacts and re-applied during operation.
0x1300	Information	Encoder	Position set: %d, %d	Position set - StartInputhandler
0x1303	Information	Encoder	Encoder Supply ok	Encoder power supply unit OK
0x1304	Information	Encoder	Encoder initialization successfully, channel: %X	Encoder initialization successfully completed
0x1305	Information	Encoder	Sent command encoder reset, channel: %X	Send encoder reset command
0x1400	Information	Drive	Drive is calibrated: %d, %d	Drive is calibrated
0x1401	Information	Drive	Actual drive state: 0x%X, %d	Current drive status
0x1705	Information		CPU usage returns in normal range (< 85%%)	Processor load is back in the normal range
0x1706	Information		Channel is not in saturation anymore	Channel is no longer in saturation
0x1707	Information		Channel is not in overload anymore	Channel is no longer overloaded
0x170A	Information		No channel range error anymore	A measuring range error is no longer active
0x170C	Information		Calibration data saved	Calibration data were saved
0x170D	Information		Calibration data will be applied and saved after sending the command "0x5AFE"	Calibration data are not applied and saved until the command "0x5AFE" is sent.

Text ID	Type	Place	Text Message	Additional comment
0x2000	Information	System	%s: %s	
0x2001	Information	System	%s: Network link lost	Network connection lost
0x2002	Information	System	%s: Network link detected	Network connection found
0x2003	Information	System	%s: no valid IP Configuration - Dhcp client started	Invalid IP configuration
0x2004	Information	System	%s: valid IP Configuration (IP: %d.%d.%d.%d) assigned by Dhcp server %d.%d.%d.%d	Valid IP configuration, assigned by the DHCP server
0x2005	Information	System	%s: Dhcp client timed out	DHCP client timeout
0x2006	Information	System	%s: Duplicate IP Address detected (%d.%d.%d.%d)	Duplicate IP address found
0x2007	Information	System	%s: UDP handler initialized	UDP handler initialized
0x2008	Information	System	%s: TCP handler initialized	TCP handler initialized
0x2009	Information	System	%s: No more free TCP sockets available	No free TCP sockets available.

Text ID	Type	Place	Text Message	Additional comment
0x4000	Warning		Warning: 0x%X, 0x%X, 0x%X	General warning; parameters depend on event. See device documentation for interpretation.
0x4001	Warning	System	Warning: 0x%X, 0x%X, 0x%X	
0x4002	Warning	System	%s: %s Connection Open (IN:%d OUT:%d API:%dms) from %d. %d.%d.%d successful	
0x4003	Warning	System	%s: %s Connection Close (IN:%d OUT:%d) from %d.%d.%d.%d successful	
0x4004	Warning	System	%s: %s Connection (IN:%d OUT:%d) with %d.%d.%d.%d timed out	

Text ID	Type	Place	Text Message	Additional comment
0x4005	Warning	System	%s: %s Connection Open (IN:%d OUT:%d) from %d.%d.%d.%d denied (Error: %u)	
0x4006	Warning	System	%s: %s Connection Open (IN:%d OUT:%d) from %d.%d.%d.%d denied (Input Data Size expected: %d Byte(s) received: %d Byte(s))	
0x4007	Warning	System	%s: %s Connection Open (IN:%d OUT:%d) from %d.%d.%d.%d denied (Output Data Size expected: %d Byte(s) received: %d Byte(s))	
0x4008	Warning	System	%s: %s Connection Open (IN:%d OUT:%d) from %d.%d.%d.%d denied (RPI:%dms not supported -> API:%dms)	
0x4101	Warning	General	Terminal-Overtemperature	Overtemperature. The internal temperature of the terminal exceeds the parameterized warning threshold.
0x4102	Warning	General	Discrepancy in the PDO-Configuration	The selected PDOs do not match the set operating mode. Sample: Drive operates in velocity mode, but the velocity PDO is but not mapped in the PDOs.
0x417F	Warning	General	Warning: 0x%X, 0x%X, 0x%X	
0x428D	Warning	General	Challenge is not Random	
0x4300	Warning	Encoder	Subincrements deactivated: %d, %d	Sub-increments deactivated (despite activated configuration)
0x4301	Warning	Encoder	Encoder-Warning	General encoder error
0x4302	Warning	Encoder	Maximum frequency of the input signal is nearly reached (channel %d)	
0x4303	Warning	Encoder	Limit counter value was reduced because of the PDO configuration (channel %d)	
0x4304	Warning	Encoder	Reset counter value was reduced because of the PDO configuration (channel %d)	
0x4400	Warning	Drive	Drive is not calibrated: %d, %d	Drive is not calibrated
0x4401	Warning	Drive	Starttype not supported: 0x%X, %d	Start type is not supported
0x4402	Warning	Drive	Command rejected: %d, %d	Command rejected
0x4405	Warning	Drive	Invalid modulo subtype: %d, %d	Modulo sub-type invalid
0x4410	Warning	Drive	Target overrun: %d, %d	Target position exceeded
0x4411	Warning	Drive	DC-Link undervoltage (Warning)	The DC link voltage of the terminal is lower than the parameterized minimum voltage. Activation of the output stage is prevented.
0x4412	Warning	Drive	DC-Link overvoltage (Warning)	The DC link voltage of the terminal is higher than the parameterized maximum voltage. Activation of the output stage is prevented.
0x4413	Warning	Drive	I2T-Model Amplifier overload (Warning)	<ul style="list-style-type: none"> <li>The amplifier is being operated outside the specification.</li> <li>The I2T-model of the amplifier is incorrectly parameterized.</li> </ul>
0x4414	Warning	Drive	I2T-Model Motor overload (Warning)	<ul style="list-style-type: none"> <li>The motor is being operated outside the parameterized rated values.</li> <li>The I2T-model of the motor is incorrectly parameterized.</li> </ul>
0x4415	Warning	Drive	Speed limitation active	The maximum speed is limited by the parameterized objects (e.g. velocity limitation, motor speed limitation). This warning is output if the set velocity is higher than one of the parameterized limits.
0x4416	Warning	Drive	Step lost detected at position: 0x%X%X	Step loss detected
0x4417	Warning	Drive	Motor overtemperature	The internal temperature of the motor exceeds the parameterized warning threshold
0x4418	Warning	Drive	Limit: Current	Limit: current is limited
0x4419	Warning	Drive	Limit: Amplifier I2T-model exceeds 100%	The threshold values for the maximum current were exceeded.

Text ID	Type	Place	Text Message	Additional comment
0x441A	Warning	Drive	Limit: Motor I2T-model exceeds 100%%	Limit: Motor I2T-model exceeds 100%
0x441B	Warning	Drive	Limit: Velocity limitation	The threshold values for the maximum speed were exceeded.
0x441C	Warning	Drive	STO while the axis was enabled	An attempt was made to activate the axis, despite the fact that no voltage is present at the STO input.
0x4600	Warning	General IO	Wrong supply voltage range	Supply voltage not in the correct range
0x4610	Warning	General IO	Wrong output voltage range	Output voltage not in the correct range
0x4705	Warning		Processor usage at %d %%	Processor load at %d %%
0x470A	Warning		EtherCAT Frame missed (change Settings or DC Operation Mode or Sync0 Shift Time)	EtherCAT frame missed (change DC Operation Mode or Sync0 Shift Time under Settings)

Text ID	Type	Place	Text Message	Additional comment
0x8000	Error	System	%s: %s	
0x8001	Error	System	Error: 0x%X, 0x%X, 0x%X	General error; parameters depend on event. See device documentation for interpretation.
0x8002	Error	System	Communication aborted	Communication aborted
0x8003	Error	System	Configuration error: 0x%X, 0x%X, 0x%X	General; parameters depend on event. See device documentation for interpretation.
0x8004	Error	System	%s: Unsuccessful FwdOpen-Response received from %d.%d.%d (%s) (Error: %u)	
0x8005	Error	System	%s: FwdClose-Request sent to %d.%d.%d.%d (%s)	
0x8006	Error	System	%s: Unsuccessful FwdClose-Response received from %d.%d.%d (%s) (Error: %u)	
0x8007	Error	System	%s: Connection with %d.%d.%d.%d (%s) closed	
0x8100	Error	General	Status word set: 0x%X, %d	Error bit set in the status word
0x8101	Error	General	Operation mode incompatible to PDO interface: 0x%X, %d	Mode of operation incompatible with the PDO interface
0x8102	Error	General	Invalid combination of Inputs and Outputs PDOs	Invalid combination of input and output PDOs
0x8103	Error	General	No variable linkage	No variables linked
0x8104	Error	General	Terminal-Overtemperature	The internal temperature of the terminal exceeds the parameterized error threshold. Activation of the terminal is prevented
0x8105	Error	General	PD-Watchdog	Communication between the fieldbus and the output stage is secured by a Watchdog. The axis is stopped automatically if the fieldbus communication is interrupted. <ul style="list-style-type: none"> <li>The EtherCAT connection was interrupted during operation.</li> <li>The Master was switched to Config mode during operation.</li> </ul>
0x8135	Error	General	Cycle time has to be a multiple of 125 $\mu$ s	The IO or NC cycle time divided by 125 $\mu$ s does not produce a whole number.
0x8136	Error	General	Configuration error: invalid sampling rate	Configuration error: Invalid sampling rate
0x8137	Error	General	Electronic type plate: CRC error	Content of the external name plate memory invalid.
0x8140	Error	General	Sync Error	Real-time violation
0x8141	Error	General	Sync%X Interrupt lost	Sync%X Interrupt lost
0x8142	Error	General	Sync Interrupt asynchronous	Sync Interrupt asynchronous
0x8143	Error	General	Jitter too big	Jitter limit violation
0x817F	Error	General	Error: 0x%X, 0x%X, 0x%X	
0x8200	Error	Communication	Write access error: %d, %d	Error while writing
0x8201	Error	Communication	No communication to field-side (Auxiliary voltage missing)	<ul style="list-style-type: none"> <li>There is no voltage applied to the power contacts.</li> <li>A firmware update has failed.</li> </ul>
0x8281	Error	Communication	Ownership failed: %X	
0x8282	Error	Communication	To many Keys founded	
0x8283	Error	Communication	Key Creation failed: %X	

Text ID	Type	Place	Text Message	Additional comment
0x8284	Error	Communication	Key loading failed	
0x8285	Error	Communication	Reading Public Key failed: %X	
0x8286	Error	Communication	Reading Public EK failed: %X	
0x8287	Error	Communication	Reading PCR Value failed: %X	
0x8288	Error	Communication	Reading Certificate EK failed: %X	
0x8289	Error	Communication	Challenge could not be hashed: %X	
0x828A	Error	Communication	Tickstamp Process failed	
0x828B	Error	Communication	PCR Process failed: %X	
0x828C	Error	Communication	Quote Process failed: %X	
0x82FF	Error	Communication	Bootmode not activated	Boot mode not activated
0x8300	Error	Encoder	Set position error: 0x%X, %d	Error while setting the position
0x8301	Error	Encoder	Encoder increments not configured: 0x%X, %d	Encoder increments not configured
0x8302	Error	Encoder	Encoder error	The amplitude of the resolver is too small
0x8303	Error	Encoder	Encoder power missing (channel %d)	
0x8304	Error	Encoder	Encoder communication error, channel: %X	Encoder communication error
0x8305	Error	Encoder	EnDat2.2 is not supported, channel: %X	EnDat2.2 is not supported
0x8306	Error	Encoder	Delay time, tolerance limit exceeded, 0x%X, channel: %X	Runtime measurement, tolerance exceeded
0x8307	Error	Encoder	Delay time, maximum value exceeded, 0x%X, channel: %X	Runtime measurement, maximum value exceeded
0x8308	Error	Encoder	Unsupported ordering designation, 0x%X, channel: %X (only 02 and 22 is supported)	Wrong EnDat order ID
0x8309	Error	Encoder	Encoder CRC error, channel: %X	Encoder CRC error
0x830A	Error	Encoder	Temperature %X could not be read, channel: %X	Temperature cannot be read
0x830C	Error	Encoder	Encoder Single-Cycle-Data Error, channel: %X	CRC error detected. Check the transmission path and the CRC polynomial
0x830D	Error	Encoder	Encoder Watchdog Error, channel: %X	The sensor has not responded within a predefined time period
0x8310	Error	Encoder	Initialisation error	
0x8311	Error	Encoder	Maximum frequency of the input signal is exceeded (channel %d)	
0x8312	Error	Encoder	Encoder plausibility error (channel %d)	
0x8313	Error	Encoder	Configuration error (channel %d)	
0x8314	Error	Encoder	Synchronisation error	
0x8315	Error	Encoder	Error status input (channel %d)	
0x8400	Error	Drive	Incorrect drive configuration: 0x%X, %d	Drive incorrectly configured
0x8401	Error	Drive	Limiting of calibration velocity: %d, %d	Limitation of the calibration velocity
0x8402	Error	Drive	Emergency stop activated: 0x%X, %d	Emergency stop activated
0x8403	Error	Drive	ADC Error	Error during current measurement in the ADC
0x8404	Error	Drive	Overcurrent	Overcurrent in phase U, V or W
0x8405	Error	Drive	Invalid modulo position: %d	Modulo position invalid
0x8406	Error	Drive	DC-Link undervoltage (Error)	The DC link voltage of the terminal is lower than the parameterized minimum voltage. Activation of the output stage is prevented.
0x8407	Error	Drive	DC-Link overvoltage (Error)	The DC link voltage of the terminal is higher than the parameterized maximum voltage. Activation of the output stage is prevented.
0x8408	Error	Drive	I2T-Model Amplifier overload (Error)	<ul style="list-style-type: none"> <li>The amplifier is being operated outside the specification.</li> <li>The I2T-model of the amplifier is incorrectly parameterized.</li> </ul>
0x8409	Error	Drive	I2T-Model motor overload (Error)	<ul style="list-style-type: none"> <li>The motor is being operated outside the parameterized rated values.</li> </ul>

Text ID	Type	Place	Text Message	Additional comment
				<ul style="list-style-type: none"> <li>The I2T-model of the motor is incorrectly parameterized.</li> </ul>
0x840A	Error	Drive	Overall current threshold exceeded	Total current exceeded
0x8415	Error	Drive	Invalid modulo factor: %d	Modulo factor invalid
0x8416	Error	Drive	Motor overtemperature	The internal temperature of the motor exceeds the parameterized error threshold. The motor stops immediately. Activation of the output stage is prevented.
0x8417	Error	Drive	Maximum rotating field velocity exceeded	Rotary field speed exceeds the value specified for dual use (EU 1382/2014).
0x841C	Error	Drive	STO while the axis was enabled	An attempt was made to activate the axis, despite the fact that no voltage is present at the STO input.
0x8550	Error	Inputs	Zero crossing phase %X missing	Zero crossing phase %X missing
0x8551	Error	Inputs	Phase sequence Error	Wrong direction of rotation
0x8552	Error	Inputs	Overcurrent phase %X	Overcurrent phase %X
0x8553	Error	Inputs	Overcurrent neutral wire	Overcurrent neutral wire
0x8581	Error	Inputs	Wire broken Ch %D	Wire broken Ch %d
0x8600	Error	General IO	Wrong supply voltage range	Supply voltage not in the correct range
0x8601	Error	General IO	Supply voltage to low	Supply voltage too low
0x8602	Error	General IO	Supply voltage to high	Supply voltage too high
0x8603	Error	General IO	Over current of supply voltage	Overcurrent of supply voltage
0x8610	Error	General IO	Wrong output voltage range	Output voltage not in the correct range
0x8611	Error	General IO	Output voltage to low	Output voltage too low
0x8612	Error	General IO	Output voltage to high	Output voltage too high
0x8613	Error	General IO	Over current of output voltage	Overcurrent of output voltage
0x8700	Error		Channel/Interface not calibrated	Channel/interface not synchronized
0x8701	Error		Operating time was manipulated	Operating time was manipulated
0x8702	Error		Oversampling setting is not possible	Oversampling setting not possible
0x8703	Error		No slave controller found	No slave controller found
0x8704	Error		Slave controller is not in Bootstrap	Slave controller is not in bootstrap
0x8705	Error		Processor usage to high (>= 100%%)	Processor load too high (>= 100%%)
0x8706	Error		Channel in saturation	Channel in saturation
0x8707	Error		Channel overload	Channel overload
0x8708	Error		Overloadtime was manipulated	Overload time was manipulated
0x8709	Error		Saturationtime was manipulated	Saturation time was manipulated
0x870A	Error		Channel range error	Measuring range error for the channel
0x870B	Error		no ADC clock	No ADC clock available
0xFFFF	Information		Debug: 0x%X, 0x%X, 0x%X	Debug: 0x%X, 0x%X, 0x%X

## 7.2 TcEventLogger and IO

The TwinCAT 3 EventLogger provides an interface for the exchange of messages between TwinCAT components and non-TwinCAT components.

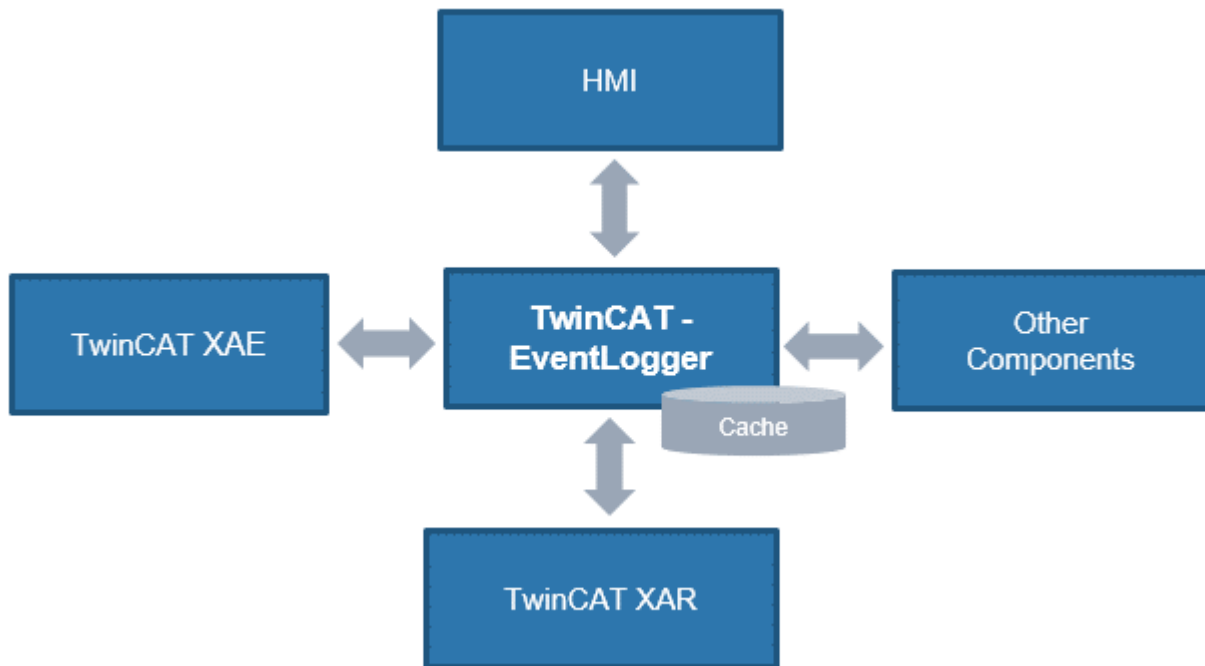

Fig. 194: Schematic representation TCEventLogger

Refer to the explanations in the TwinCAT EventLogger documentation, e.g. in the Beckhoff InfoSys <https://infosys.beckhoff.com/> → TwinCAT 3 → TE1000 XAE → Technologies → EventLogger.

The EventLogger saves to a local database under `..\TwinCAT\3.1\Boot\LoggedEvents.db` and, unlike the VisualStudio Error Window, is designed for continuous recording.

IO devices can also be a source of messages. If so-called DiagMessages are generated in the IO device, they can be collected by TwinCAT over EtherCAT and displayed in the TcEventLogger with the appropriate device setting. This facilitates the central management of events that hinder operation, as a textual diagnosis no longer needs to be programmed out in the application for each individual IO device. The messages/events can be displayed directly in the TwinCAT HMI, for example, and thus facilitate the diagnosis.

Notes:

- This feature is supported from TwinCAT 3.1 build 4022.16.
- TwinCAT may be in the RUN or CONFIG mode
- On the manufacturer side, the IO device regarded must (1) generate local DiagMessages and (2) be fundamentally capable of transmitting them as events over EtherCAT. This is not the case with all EtherCAT IO devices/terminals/box modules from Beckhoff.

The messages managed by the EventLogger can be output in or read from

- the HMI → EventGrid
- C#
- the PLC
- TwinCAT Engineering → Logged Events

The use of the EventLogger with EtherCAT IO with TwinCAT 3.1 build 4022.22 during commissioning is explained below.

- The EventLogger window may need to be displayed in the TwinCAT Engineering



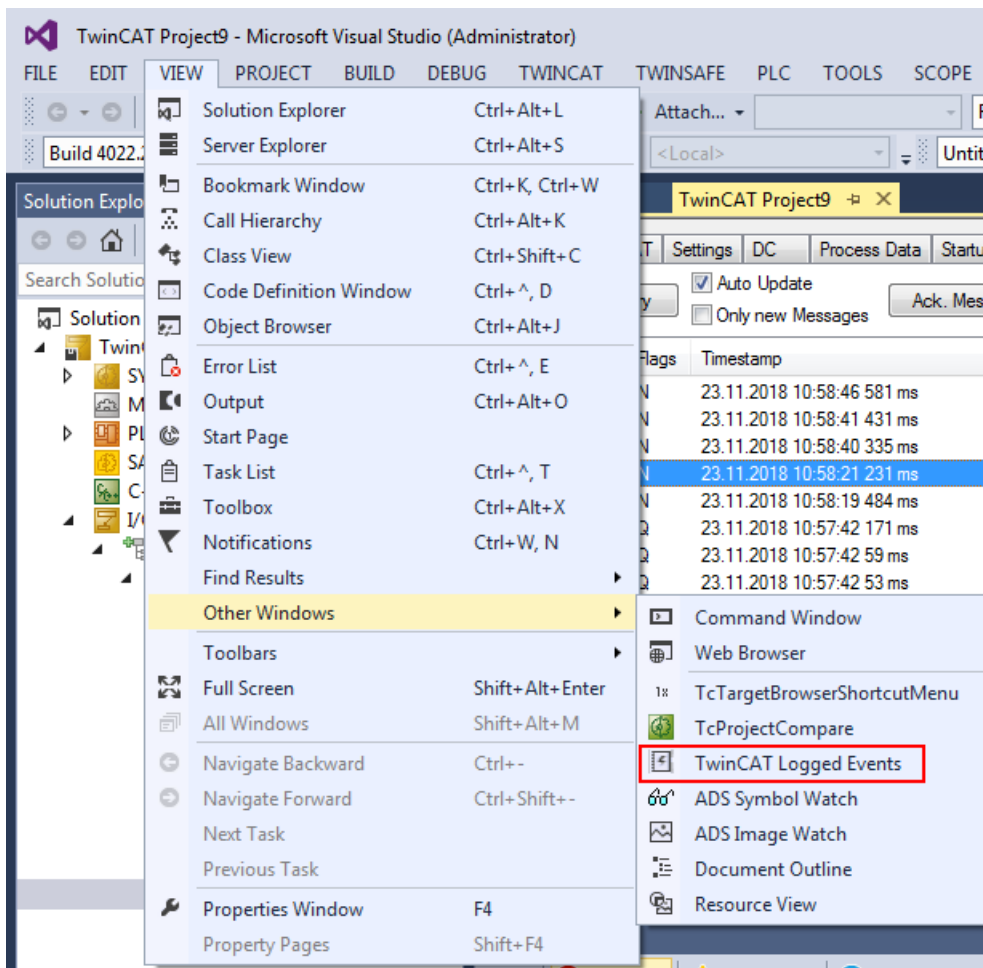

Fig. 195: Display EventLogger window

- Some DiagMessages and the resulting Logged Events are shown below, taking an ELM3602-0002 as an example



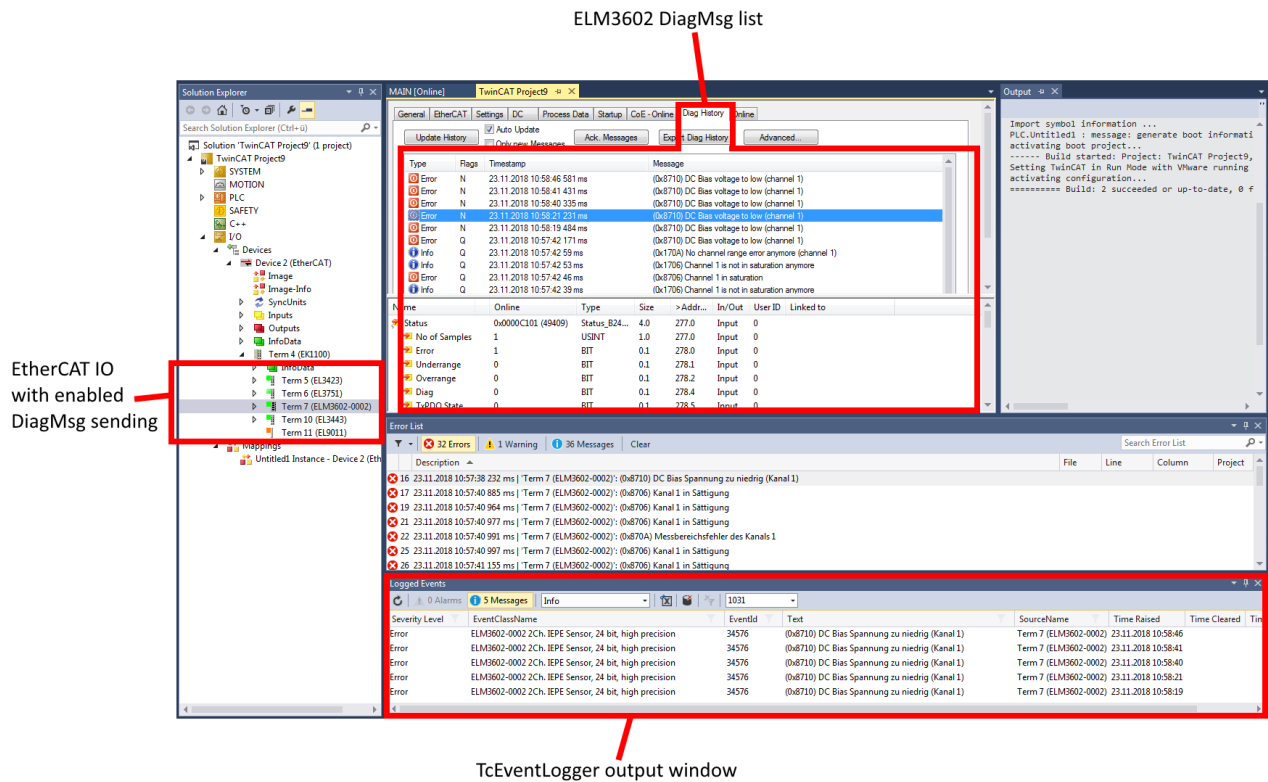

Fig. 196: Display DiagMessages and Logged Events

- Filtering by entries and language is possible in the Logger window.  
 German: 1031  
 English: 1033

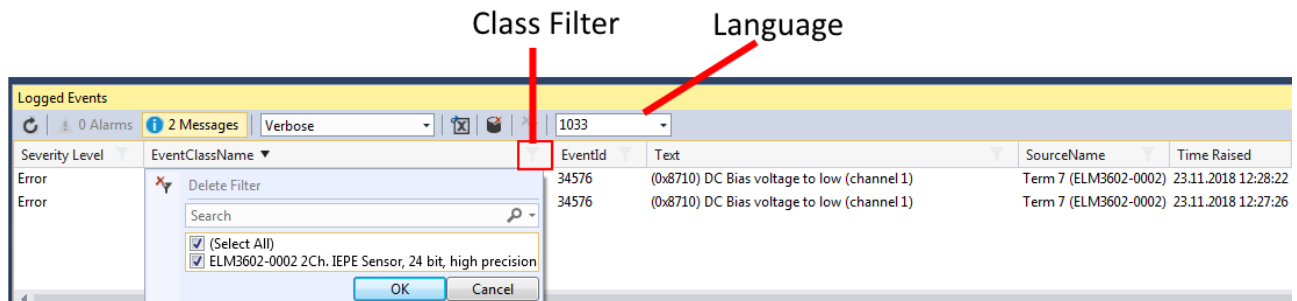

Fig. 197: Setting filter language

- If an EtherCAT slave is enabled by default to transmit DiagMessages as events over EtherCAT, this can be activated/deactivated for each individual slave in the CoE 0x10F3:05. TRUE means that the slave provides events for collection via EtherCAT, while FALSE deactivates the function.

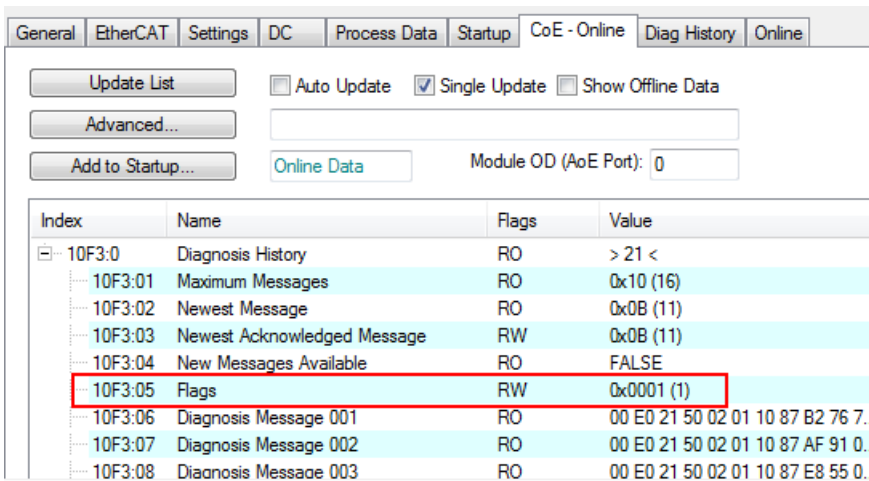

Fig. 198: Activating/deactivating event transmission

- In the respective EtherCAT slave, various "causes" can lead to it transmitting DiagMessages or events. If only some of these are to be generated, you can read in the device documentation whether and how individual causes can be deactivated, e.g. through CoE settings.
- Settings for the TwinCAT EventLogger can be found under Tools/Options

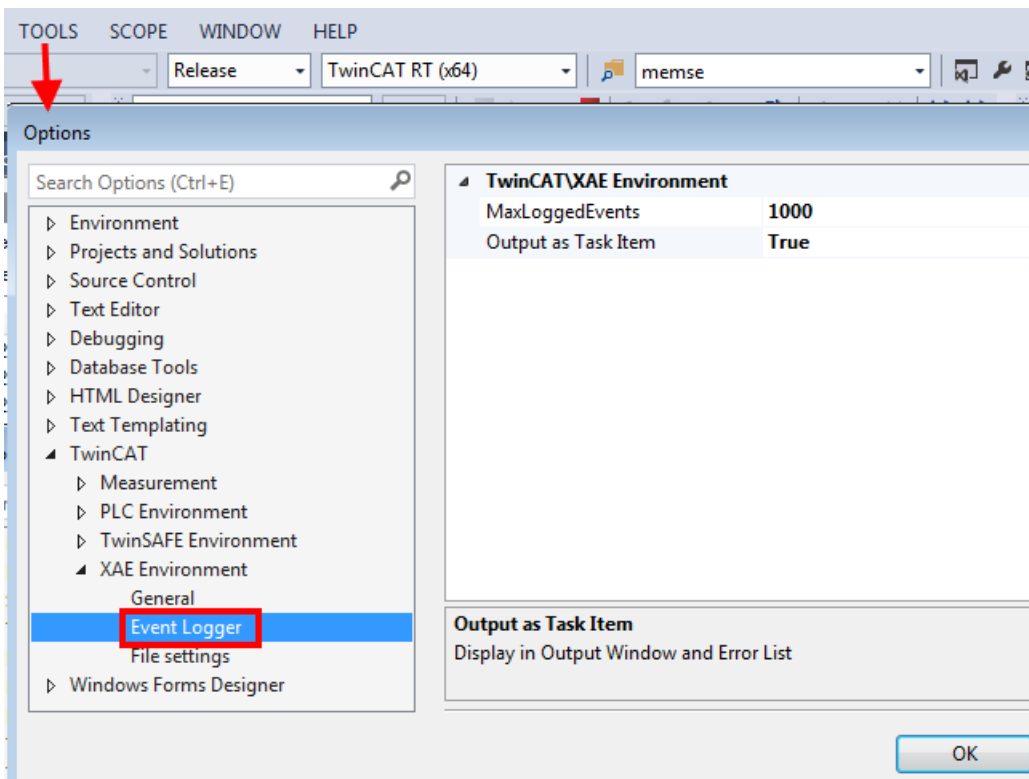



Fig. 199: Settings TwinCAT EventLogger

### 7.3 UL notice

<b>⚠ CAUTION</b>	
	<p><b>Application</b> Beckhoff EtherCAT modules are intended for use with Beckhoff's UL Listed EtherCAT System only.</p>

<b>⚠ CAUTION</b>	
	<p><b>Examination</b></p> <p>For cULus examination, the Beckhoff I/O System has only been investigated for risk of fire and electrical shock (in accordance with UL508 and CSA C22.2 No. 142).</p>

<b>⚠ CAUTION</b>	
	<p><b>For devices with Ethernet connectors</b></p> <p>Not for connection to telecommunication circuits.</p>

**Basic principles**

UL certification according to UL508. Devices with this kind of certification are marked by this sign:



## 7.4 Continuative documentation for ATEX and IECEx

### NOTICE



#### Continuative documentation about explosion protection according to ATEX and IECEx

Pay also attention to the continuative documentation

#### Ex. Protection for Terminal Systems

Notes on the use of the Beckhoff terminal systems in hazardous areas according to ATEX and IECEx,

that is available for [download](#) within the download area of your product on the Beckhoff homepage [www.beckhoff.com](http://www.beckhoff.com)!

## 7.5 EtherCAT AL Status Codes

For detailed information please refer to the [EtherCAT system description](#).

## 7.6 Firmware Update EL/ES/EM/ELM/EPxxxx

This section describes the device update for Beckhoff EtherCAT slaves from the EL/ES, ELM, EM, EK and EP series. A firmware update should only be carried out after consultation with Beckhoff support.

### NOTICE

#### Only use TwinCAT 3 software!

A firmware update of Beckhoff IO devices must only be performed with a TwinCAT 3 installation. It is recommended to build as up-to-date as possible, available for free download on the Beckhoff website <https://www.beckhoff.com/en-us/>.

To update the firmware, TwinCAT can be operated in the so-called FreeRun mode, a paid license is not required.

The device to be updated can usually remain in the installation location, but TwinCAT has to be operated in the FreeRun. Please make sure that EtherCAT communication is trouble-free (no LostFrames etc.).

Other EtherCAT master software, such as the EtherCAT Configurator, should not be used, as they may not support the complexities of updating firmware, EEPROM and other device components.

### Storage locations

An EtherCAT slave stores operating data in up to three locations:

- Depending on functionality and performance EtherCAT slaves have one or several local controllers for processing I/O data. The corresponding program is the so-called **firmware** in \*.efw format.
- In some EtherCAT slaves the EtherCAT communication may also be integrated in these controllers. In this case the controller is usually a so-called **FPGA** chip with \*.rbf firmware.
- In addition, each EtherCAT slave has a memory chip, a so-called **ESI-EEPROM**, for storing its own device description (ESI: EtherCAT Slave Information). On power-up this description is loaded and the EtherCAT communication is set up accordingly. The device description is available from the download area of the Beckhoff website at (<https://www.beckhoff.com>). All ESI files are accessible there as zip files.

Customers can access the data via the EtherCAT fieldbus and its communication mechanisms. Acyclic mailbox communication or register access to the ESC is used for updating or reading of these data.

The TwinCAT System Manager offers mechanisms for programming all three parts with new data, if the slave is set up for this purpose. Generally the slave does not check whether the new data are suitable, i.e. it may no longer be able to operate if the data are unsuitable.

**Simplified update by bundle firmware**

The update using so-called **bundle firmware** is more convenient: in this case the controller firmware and the ESI description are combined in a \*.efw file; during the update both the firmware and the ESI are changed in the terminal. For this to happen it is necessary

- for the firmware to be in a packed format: recognizable by the file name, which also contains the revision number, e.g. ELxxx-xxx\_REV0016\_SW01.efw
- for password=1 to be entered in the download dialog. If password=0 (default setting) only the firmware update is carried out, without an ESI update.
- for the device to support this function. The function usually cannot be retrofitted; it is a component of many new developments from year of manufacture 2016.

Following the update, its success should be verified

- ESI/Revision: e.g. by means of an online scan in TwinCAT ConfigMode/FreeRun – this is a convenient way to determine the revision
- Firmware: e.g. by looking in the online CoE of the device

**NOTICE**

**Risk of damage to the device!**

✓ Note the following when downloading new device files

a) Firmware downloads to an EtherCAT device must not be interrupted

b) Flawless EtherCAT communication must be ensured. CRC errors or LostFrames must be avoided.

c) The power supply must adequately dimensioned. The signal level must meet the specification.

⇒ In the event of malfunctions during the update process the EtherCAT device may become unusable and require re-commissioning by the manufacturer.

**7.6.1 Device description ESI file/XML**

**NOTICE**

**Attention regarding update of the ESI description/EEPROM**

Some slaves have stored calibration and configuration data from the production in the EEPROM. These are irretrievably overwritten during an update.

The ESI device description is stored locally on the slave and loaded on start-up. Each device description has a unique identifier consisting of slave name (9 characters/digits) and a revision number (4 digits). Each slave configured in the System Manager shows its identifier in the EtherCAT tab:

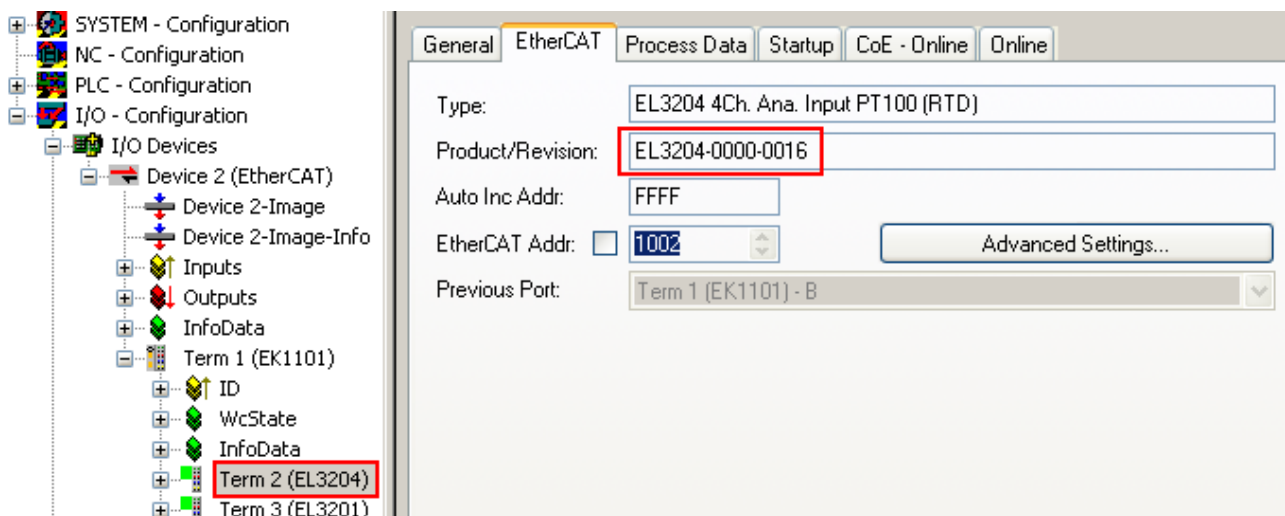

Fig. 200: Device identifier consisting of name EL3204-0000 and revision -0016

The configured identifier must be compatible with the actual device description used as hardware, i.e. the description which the slave has loaded on start-up (in this case EL3204). Normally the configured revision must be the same or lower than that actually present in the terminal network.

For further information on this, please refer to the [EtherCAT system documentation](#).

### **i** Update of XML/ESI description

The device revision is closely linked to the firmware and hardware used. Incompatible combinations lead to malfunctions or even final shutdown of the device. Corresponding updates should only be carried out in consultation with Beckhoff support.

### Display of ESI slave identifier

The simplest way to ascertain compliance of configured and actual device description is to scan the EtherCAT boxes in TwinCAT mode Config/FreeRun:

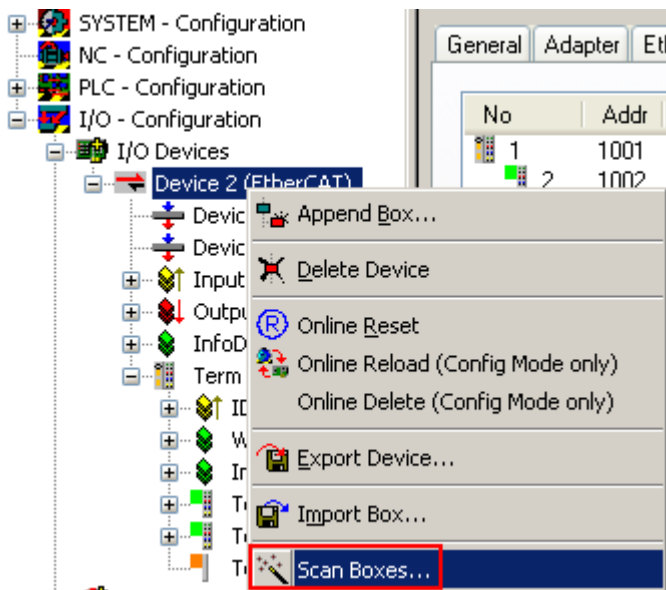

Fig. 201: Scan the subordinate field by right-clicking on the EtherCAT device

If the found field matches the configured field, the display shows



Fig. 202: Configuration is identical

otherwise a change dialog appears for entering the actual data in the configuration.

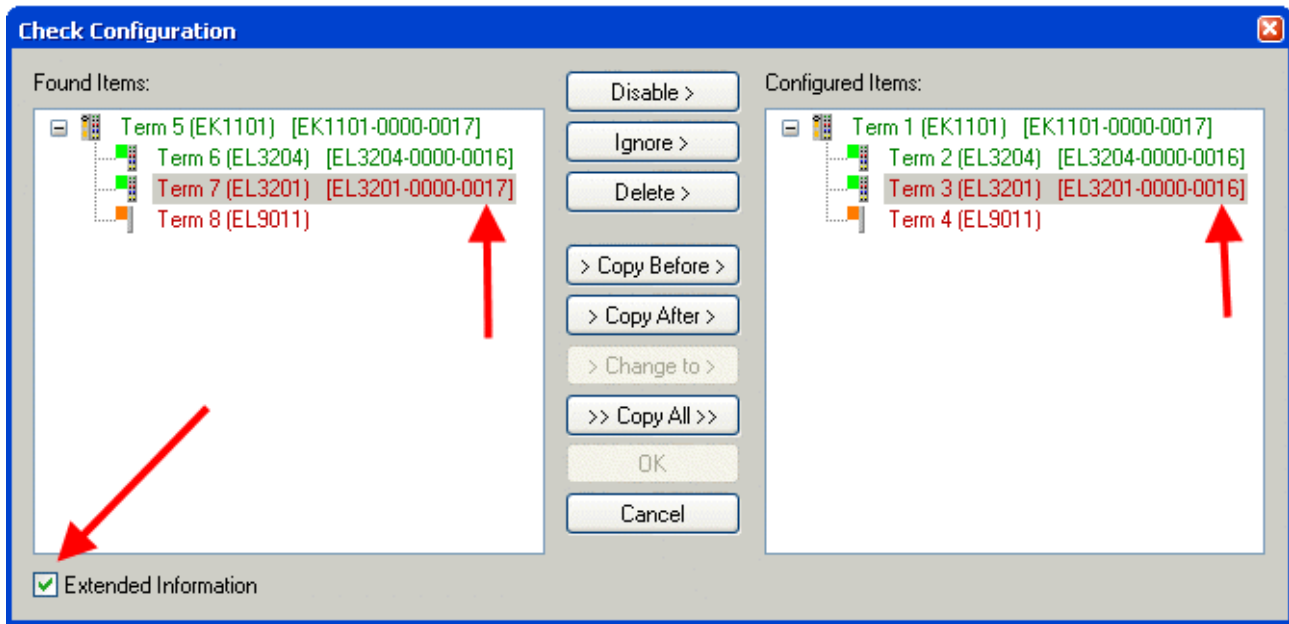

Fig. 203: Change dialog

In this example in Fig. *Change dialog*, an EL3201-0000-0017 was found, while an EL3201-0000-0016 was configured. In this case the configuration can be adapted with the *Copy Before* button. The *Extended Information* checkbox must be set in order to display the revision.

**Changing the ESI slave identifier**

The ESI/EEPROM identifier can be updated as follows under TwinCAT:

- Trouble-free EtherCAT communication must be established with the slave.
- The state of the slave is irrelevant.
- Right-clicking on the slave in the online display opens the *EEPROM Update* dialog, Fig. *EEPROM Update*

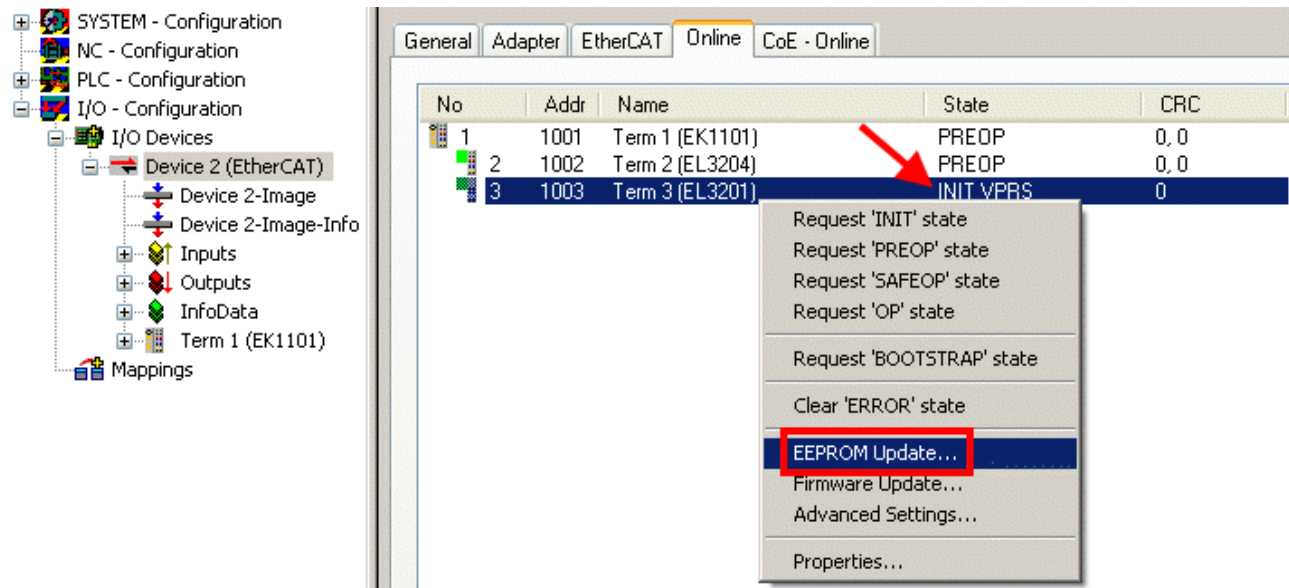

Fig. 204: EEPROM Update

The new ESI description is selected in the following dialog, see Fig. *Selecting the new ESI*. The checkbox *Show Hidden Devices* also displays older, normally hidden versions of a slave.

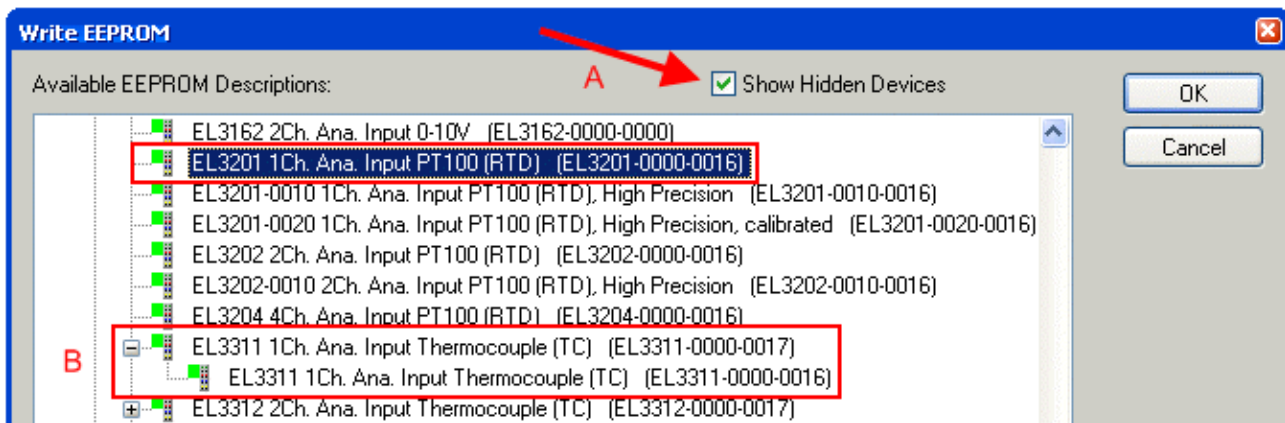

Fig. 205: Selecting the new ESI

A progress bar in the System Manager shows the progress. Data are first written, then verified.

**i** **The change only takes effect after a restart.**

Most EtherCAT devices read a modified ESI description immediately or after startup from the INIT. Some communication settings such as distributed clocks are only read during power-on. The EtherCAT slave therefore has to be switched off briefly in order for the change to take effect.

## 7.6.2 Firmware explanation

### Determining the firmware version

#### Determining the version via the System Manager

The TwinCAT System Manager shows the version of the controller firmware if the master can access the slave online. Click on the E-Bus Terminal whose controller firmware you want to check (in the example terminal 2 (EL3204)) and select the tab *CoE Online* (CAN over EtherCAT).

**i** **CoE Online and Offline CoE**

Two CoE directories are available:

- **online:** This is offered in the EtherCAT slave by the controller, if the EtherCAT slave supports this. This CoE directory can only be displayed if a slave is connected and operational.
- **offline:** The EtherCAT Slave Information ESI/XML may contain the default content of the CoE. This CoE directory can only be displayed if it is included in the ESI (e.g. "Beckhoff EL5xxx.xml").

The Advanced button must be used for switching between the two views.

In Fig. *Display of EL3204 firmware version* the firmware version of the selected EL3204 is shown as 03 in CoE entry 0x100A.



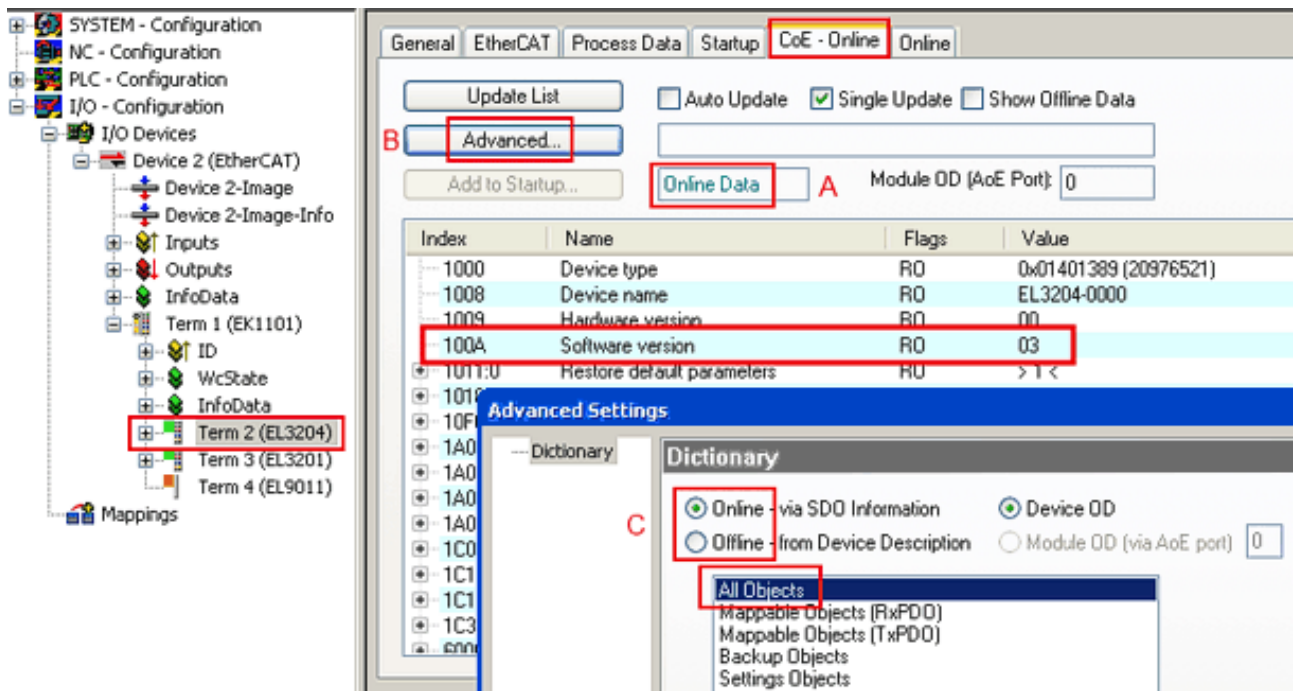

Fig. 206: Display of EL3204 firmware version

In (A) TwinCAT 2.11 shows that the Online CoE directory is currently displayed. If this is not the case, the Online directory can be loaded via the *Online* option in Advanced Settings (B) and double-clicking on *AllObjects*.

### 7.6.3 Updating controller firmware \*.efw

● **CoE directory**

**i** The Online CoE directory is managed by the controller and stored in a dedicated EEPROM, which is generally not changed during a firmware update.

Switch to the *Online* tab to update the controller firmware of a slave, see Fig. *Firmware Update*.

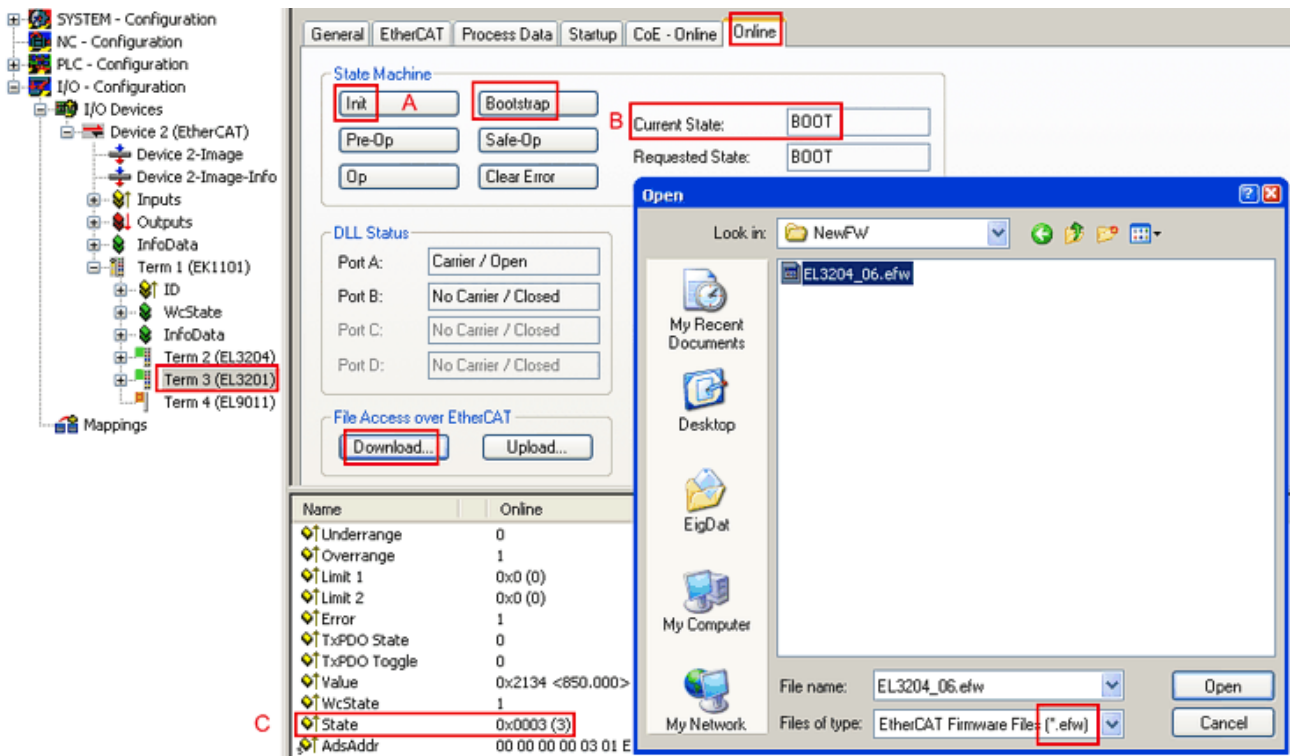
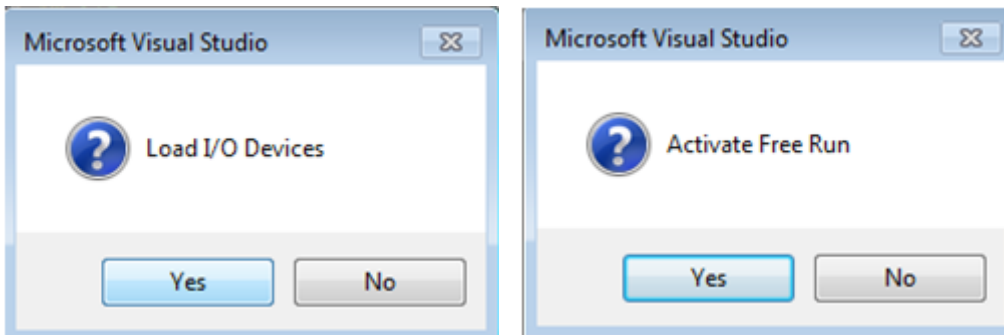

Fig. 207: Firmware Update

Proceed as follows, unless instructed otherwise by Beckhoff support. Valid for TwinCAT 2 and 3 as EtherCAT master.

- Switch TwinCAT system to ConfigMode/FreeRun with cycle time  $\geq 1$  ms (default in ConfigMode is 4 ms). A FW-Update during real time operation is not recommended.



- Switch EtherCAT Master to PreOP

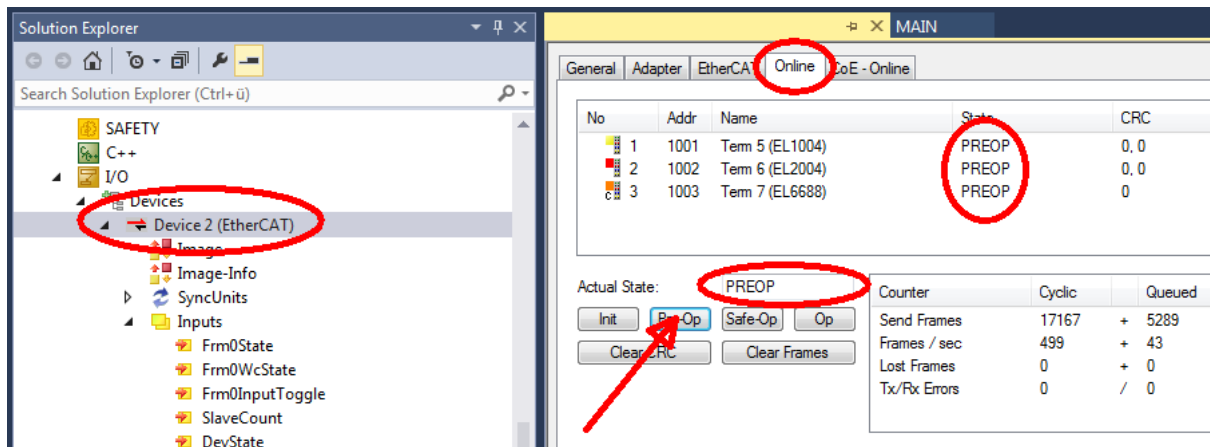

- Switch slave to INIT (A)
- Switch slave to BOOTSTRAP

- Check the current status (B, C)
- Download the new \*efw file (wait until it ends). A password will not be necessary usually.

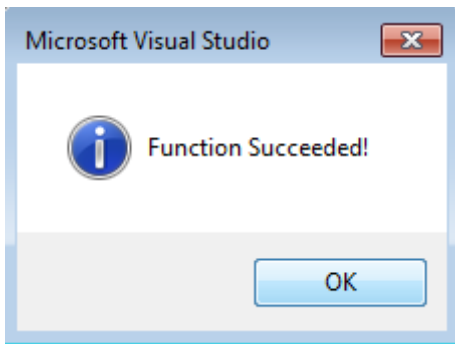

- After the download switch to INIT, then PreOP
- Switch off the slave briefly (don't pull under voltage!)
- Check within CoE 0x100A, if the FW status was correctly overtaken.

#### 7.6.4 FPGA firmware \*.rbf

If an FPGA chip deals with the EtherCAT communication an update may be accomplished via an \*.rbf file.

- Controller firmware for processing I/O signals
- FPGA firmware for EtherCAT communication (only for terminals with FPGA)

The firmware version number included in the terminal serial number contains both firmware components. If one of these firmware components is modified this version number is updated.

##### Determining the version via the System Manager

The TwinCAT System Manager indicates the FPGA firmware version. Click on the Ethernet card of your EtherCAT strand (Device 2 in the example) and select the *Online* tab.

The *Reg:0002* column indicates the firmware version of the individual EtherCAT devices in hexadecimal and decimal representation.

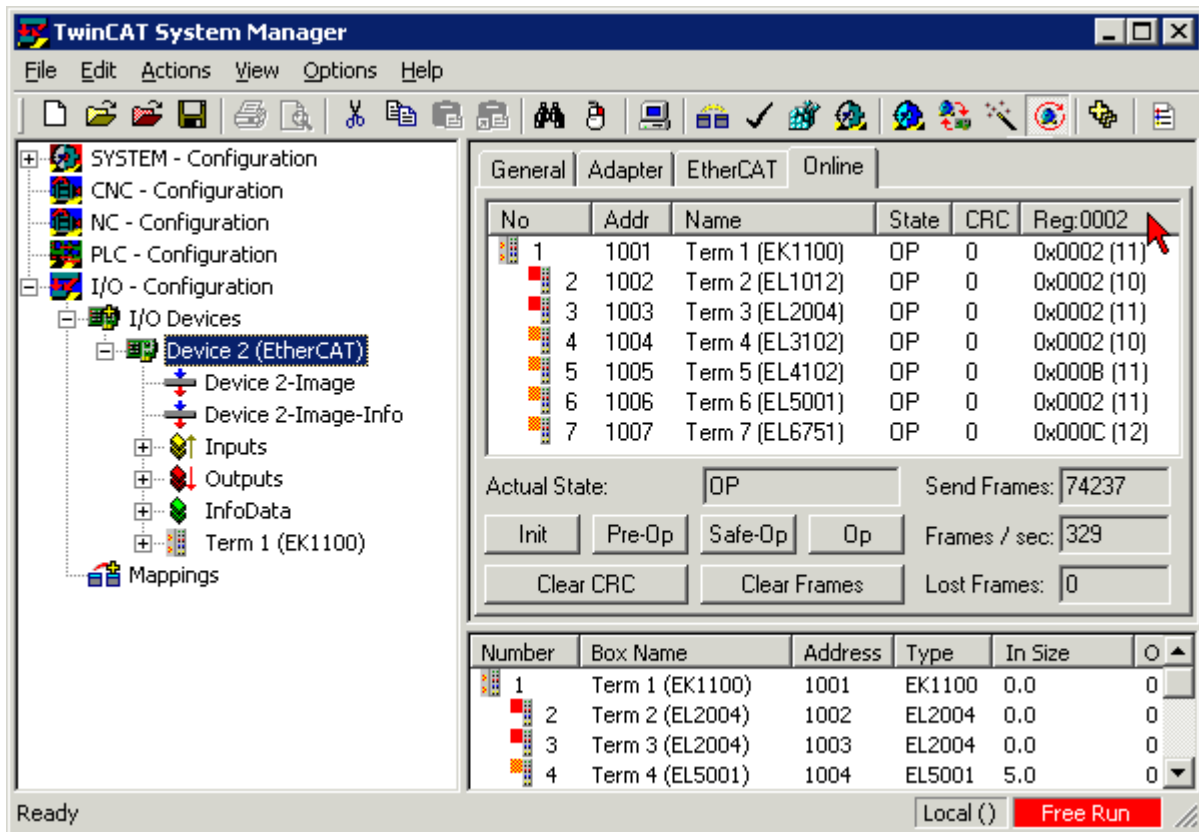

Fig. 208: FPGA firmware version definition

If the column *Reg:0002* is not displayed, right-click the table header and select *Properties* in the context menu.

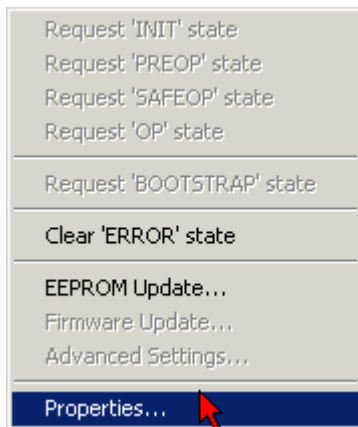

Fig. 209: Context menu *Properties*

The *Advanced Settings* dialog appears where the columns to be displayed can be selected. Under *Diagnosis/Online View* select the *'0002 ETxxxx Build'* check box in order to activate the FPGA firmware version display.

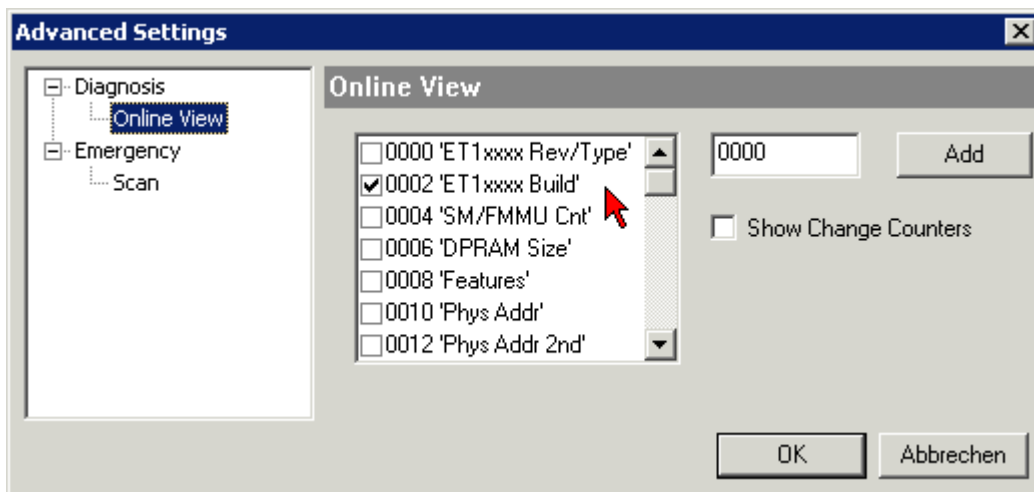

Fig. 210: Dialog *Advanced Settings*

### Update

For updating the FPGA firmware

- of an EtherCAT coupler the coupler must have FPGA firmware version 11 or higher;
- of an E-Bus Terminal the terminal must have FPGA firmware version 10 or higher.

Older firmware versions can only be updated by the manufacturer!

### Updating an EtherCAT device

The following sequence order have to be met if no other specifications are given (e.g. by the Beckhoff support):

- Switch TwinCAT system to ConfigMode/FreeRun with cycle time  $\geq 1$  ms (default in ConfigMode is 4 ms). A FW-Update during real time operation is not recommended.

- In the TwinCAT System Manager select the terminal for which the FPGA firmware is to be updated (in the example: Terminal 5: EL5001) and click the *Advanced Settings* button in the *EtherCAT* tab:

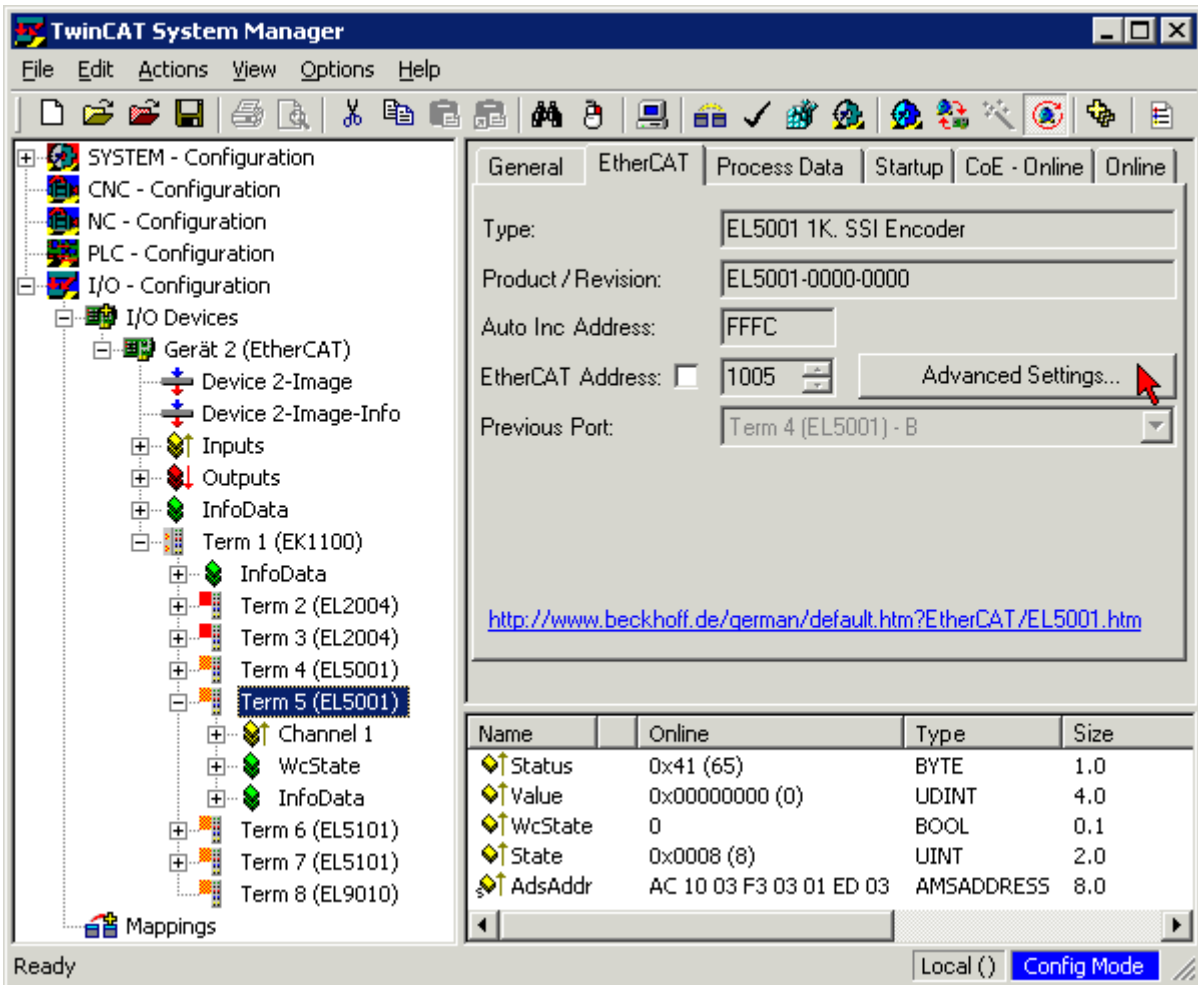

- The *Advanced Settings* dialog appears. Under *ESC Access/E<sup>2</sup>PROM/FPGA* click on *Write FPGA* button:

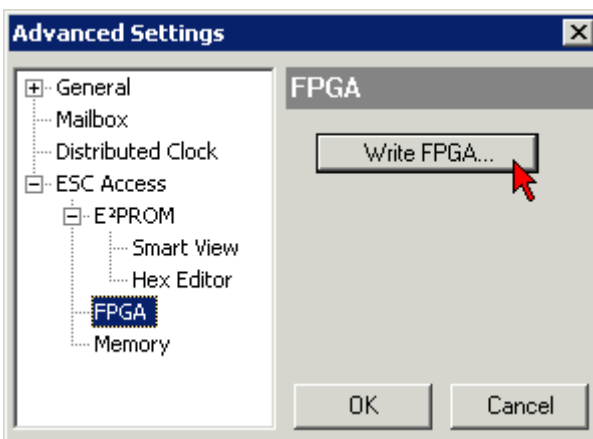

- Select the file (\*.rbf) with the new FPGA firmware, and transfer it to the EtherCAT device:

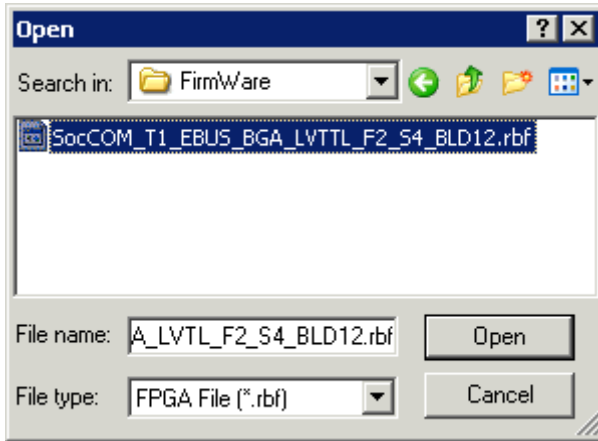

- Wait until download ends
- Switch slave current less for a short time (don't pull under voltage!). In order to activate the new FPGA firmware a restart (switching the power supply off and on again) of the EtherCAT device is required.
- Check the new FPGA status

**NOTICE**

**Risk of damage to the device!**

A download of firmware to an EtherCAT device must not be interrupted in any case! If you interrupt this process by switching off power supply or disconnecting the Ethernet link, the EtherCAT device can only be recommissioned by the manufacturer!

### 7.6.5 Simultaneous updating of several EtherCAT devices

The firmware and ESI descriptions of several devices can be updated simultaneously, provided the devices have the same firmware file/ESI.

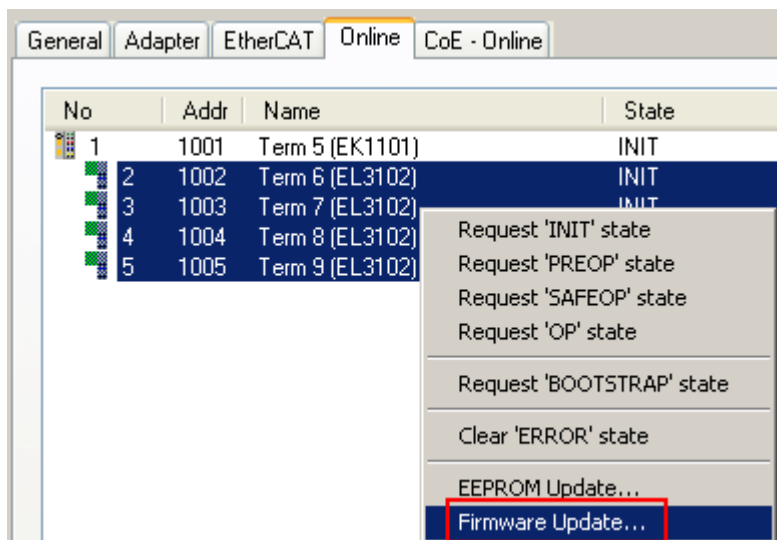

Fig. 211: Multiple selection and firmware update

Select the required slaves and carry out the firmware update in BOOTSTRAP mode as described above.

## 7.7 Firmware compatibility

Beckhoff EtherCAT devices are delivered with the latest available firmware version. Compatibility of firmware and hardware is mandatory; not every combination ensures compatibility. The overview below shows the hardware versions on which a firmware can be operated.

### Note

- It is recommended to use the newest possible firmware for the respective hardware.
- Beckhoff is not under any obligation to provide customers with free firmware updates for delivered products.

### NOTICE

#### Risk of damage to the device!

Pay attention to the instructions for firmware updates on the [separate page \[▶ 248\]](#). If a device is placed in BOOTSTRAP mode for a firmware update, it does not check when downloading whether the new firmware is suitable. This can result in damage to the device! Therefore, always make sure that the firmware is suitable for the hardware version!

EL3751			
Hardware (HW)	Firmware (FW)	Revision no.	Release date
01*	01	0017	2015/06
	02	0017	2015/07
	03	0018	2015/07
	04	0019	2015/08
	05	0019	2015/09
	06	0020	2015/12
	07	0020	2016/03
	08	0021	2016/07
	09	0021	2016/08
	10	0021	2017/04
	11	0022	2018/05
	12	0022	2019/09
	13	0023	2021/03
	14	0023	2021/06

\*) This is the current compatible firmware/hardware version at the time of the preparing this documentation. Check on the Beckhoff web page whether more up-to-date [documentation](#) is available.

## 7.8 Firmware compatibility - passive terminals

The [passive terminals \[▶ 219\]](#) ELxxxx terminal series have no firmware to update.

## 7.9 Restoring the delivery state

To restore the delivery state (factory settings) for backup objects in ELxxxx terminals, the CoE object Restore default parameters, *SubIndex 001* can be selected in the TwinCAT System Manager (Config mode) (see Fig. *Selecting the Restore default parameters PDO*)



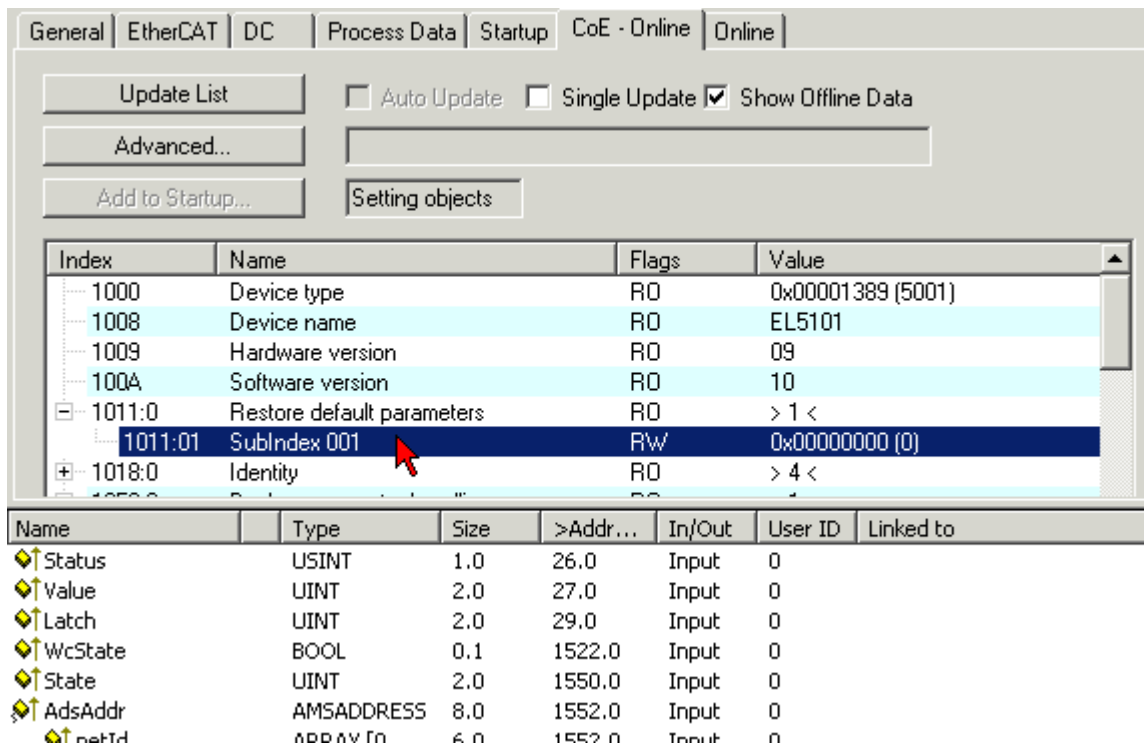

Fig. 212: Selecting the *Restore default parameters* PDO

Double-click on SubIndex 001 to enter the Set Value dialog. Enter the value **1684107116** in field *Dec* or the value **0x64616F6C** in field *Hex* and confirm with *OK* (Fig. *Entering a restore value in the Set Value dialog*). All backup objects are reset to the delivery state.

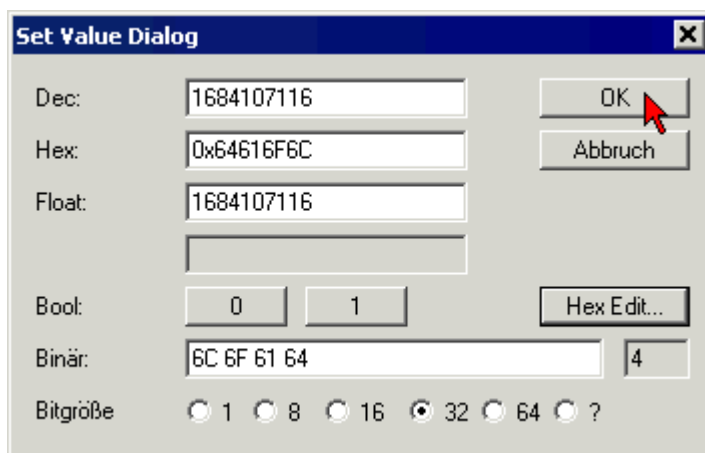

Fig. 213: Entering a restore value in the Set Value dialog

**Alternative restore value**

In some older terminals the backup objects can be switched with an alternative restore value: Decimal value: 1819238756, Hexadecimal value: 0x6C6F6164An incorrect entry for the restore value has no effect.

## 7.10 Notes on analog aspects to EL3751/ ELM3xxx

Beyond the general instructions relating to analog technology, the following instructions apply for the EL3751 and ELM3xxx (as far as applicable):

- The internal GND of of the analog terminal is connected to the connection point –Uv. Hence, when several terminals are wired, it has to be considered, that they must not exceed the permitted CommonMode voltage among each others.

- The "-U<sub>v</sub>"-points must not be connected with each other or with other another potential, although it can be helpful to use it to correct system-specific negative influences.
- Voltage measurement at the high-side shunt  
A high-side shunt is a shunt that is connected to the positive/upper potential, in which case the negative connection is generally used for switching, hence the term "negative switching".

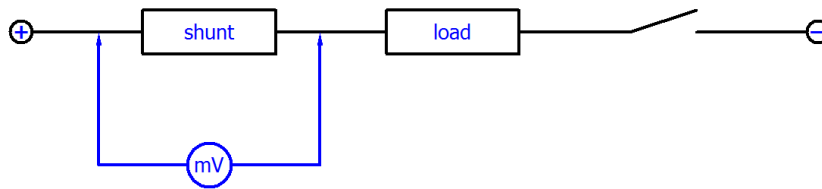

In principle, it is possible to use mV measurement at a shunt for current determination with the differential U inputs of the Beckhoff measurement devices. However, two important limitations must be considered:

- Common mode voltage  $V_{cm}$  between the channels: For multi-channel terminals,  $V_{cm, max}$  (see [technical data \[▶ 18\]](#) in this documentation) between the channels must not be exceeded. With a 24 V supply of the loads, it is therefore not possible to use a high-side shunt at 24 V potential on a channel and a low-side shunt at 0 V potential on another channel, because the resulting internal reference ground  $-U_v$  would assume a mean value such that  $V_{cm}$  is exceeded.  
→ Therefore, only high-side shunts or only low-side shunts should be used at a terminal.
- Dynamic processes through pulsed current: In general, the current is controlled through pulsing/ PWM. Depending on the inductance in the load circuit, this can lead to sudden current changes and therefore voltage changes over the shunt.  $V_{cm}$  at the differential inputs changes accordingly. The channel (this therefore also applies to the single-channel EL3751) is LC-coupled to the internal reference ground  $-U_v$ , and the sudden increase in  $V_{cm}$  results in an increase in  $-U_v$ . During this transient (several ms), measurement errors may occur when exceeding  $V_{cm, max}$ .  
→ PWM current measurement with a high-side shunt in 24 V networks is only possible in the 30 V measuring range.

## 7.11 Continuative documentation for I/O components with analog in and outputs

### NOTICE



#### Continuative documentation for I/O components with analog in and outputs

Pay also attention to the continuative documentation

##### I/O Analog Manual

Notes on I/O components with analog inputs and outputs,

which is available in the Beckhoff [Information-System](#) and for [download](#) on the Beckhoff homepage [www.beckhoff.com](http://www.beckhoff.com) on the respective product pages!

It explains the basics of sensor technology and contains notes on analog measured values.

## 7.12 Support and Service

Beckhoff and their partners around the world offer comprehensive support and service, making available fast and competent assistance with all questions related to Beckhoff products and system solutions.

### Beckhoff's branch offices and representatives

Please contact your Beckhoff branch office or representative for local support and service on Beckhoff products!

The addresses of Beckhoff's branch offices and representatives round the world can be found on her internet pages: [www.beckhoff.com](http://www.beckhoff.com)

You will also find further documentation for Beckhoff components there.

### Support

The Beckhoff Support offers you comprehensive technical assistance, helping you not only with the application of individual Beckhoff products, but also with other, wide-ranging services:

- support
- design, programming and commissioning of complex automation systems
- and extensive training program for Beckhoff system components

Hotline: +49 5246 963 157  
e-mail: [support@beckhoff.com](mailto:support@beckhoff.com)  
web: [www.beckhoff.com/support](http://www.beckhoff.com/support)

### Service

The Beckhoff Service Center supports you in all matters of after-sales service:

- on-site service
- repair service
- spare parts service
- hotline service

Hotline: +49 5246 963 460  
e-mail: [service@beckhoff.com](mailto:service@beckhoff.com)  
web: [www.beckhoff.com/service](http://www.beckhoff.com/service)

### Headquarters Germany

Beckhoff Automation GmbH & Co. KG

Hülshorstweg 20  
33415 Verl  
Germany

Phone: +49 5246 963 0  
e-mail: [info@beckhoff.com](mailto:info@beckhoff.com)  
web: [www.beckhoff.com](http://www.beckhoff.com)

## 7.13 Reshipment and return

This product is individually packed and sealed. Unless otherwise agreed, Beckhoff can only accept returns in unopened original packaging with the seal intact.

## List of illustrations

Fig. 1	EL2872 with revision 0022 and serial number 01200815 .....	12
Fig. 2	BIC as data matrix code (DMC, code scheme ECC200) .....	12
Fig. 3	Example DMC 1P072222SBTNk4p562d71KEL1809 Q1 51S678294 .....	13
Fig. 4	EL3751, EL3751-0004, EL3751-0024; LEDs, connections and assignment .....	17
Fig. 5	Basic range of a process data value .....	20
Fig. 6	Representation $\pm 30$ V measurement range .....	27
Fig. 7	Frequency response $\pm 30$ V measurement range, fsampling = 10 kHz, integrated filter 1/2 deactivated .....	27
Fig. 8	Representation $\pm 10$ V measurement range .....	29
Fig. 9	Frequency response $\pm 10$ V measurement range, fsampling = 10 kHz, integrated filter 1/2 deactivated .....	29
Fig. 10	Representation $\pm 5$ V measurement range .....	31
Fig. 11	Frequency response $\pm 5$ V measurement range, fsampling = 10 kHz, integrated filter 1/2 deactivated .....	31
Fig. 12	Representation $\pm 2.5$ V measurement range .....	33
Fig. 13	Frequency response $\pm 2.5$ V measurement range, fsampling = 10 kHz, integrated filter 1/2 deactivated .....	33
Fig. 14	Representation $\pm 1.25$ V measurement range .....	35
Fig. 15	Frequency response $\pm 1.25$ V measurement range, fsampling = 10 kHz, integrated filter 1/2 deactivated .....	35
Fig. 16	Representation $\pm 640$ mV measurement range .....	37
Fig. 17	Frequency response $\pm 640$ mV measurement range, fsampling = 10 kHz, integrated filter 1/2 deactivated .....	37
Fig. 18	Representation $\pm 320$ mV measurement range .....	39
Fig. 19	Frequency response $\pm 320$ mV measurement range, fsampling = 10 kHz, integrated filter 1/2 deactivated .....	39
Fig. 20	Representation $\pm 160$ mV measurement range .....	41
Fig. 21	Frequency response $\pm 160$ mV measurement range, fsampling = 10 kHz, integrated filter 1/2 deactivated .....	41
Fig. 22	Representation $\pm 80$ mV measurement range .....	43
Fig. 23	Frequency response $\pm 80$ mV measurement range, fsampling = 10 kHz, integrated filter 1/2 deactivated .....	43
Fig. 24	Representation $\pm 40$ mV measurement range .....	45
Fig. 25	Frequency response $\pm 40$ mV measurement range, fsampling = 10 kHz, integrated filter 1/2 deactivated .....	45
Fig. 26	Representation $\pm 20$ mV measurement range .....	47
Fig. 27	Representation $\pm 10$ mV measurement range .....	49
Fig. 28	Representation $\pm 5$ mV measurement range .....	51
Fig. 29	Representation 0...5 V measurement range .....	53
Fig. 30	Frequency response 0...5 V measurement range, fsampling = 10 kHz, integrated filter 1/2 deactivated .....	53
Fig. 31	Representation 0...10 V measurement range .....	55
Fig. 32	Frequency response 0...10 V measurement range, fsampling = 10 kHz, integrated filter 1/2 deactivated .....	55
Fig. 33	Representation current measurement range $\pm 20$ mA .....	57
Fig. 34	Frequency response $\pm 20$ mA measurement range, fsampling = 10 kHz, integrated filter 1/2 deactivated .....	57
Fig. 35	Representation current measurement range 0...20 mA .....	59

Fig. 36	Frequency response 0...20 mA measurement range, fsampling = 10 kHz, integrated filter 1/2 deactivated.....	59
Fig. 37	Representation current measurement range 4...20 mA .....	61
Fig. 38	Frequency response 4...20 mA measurement range, fsampling = 10 kHz, integrated filter 1/2 deactivated.....	62
Fig. 39	Chart: current measuring range 3.6...21 mA (NAMUR).....	64
Fig. 40	Frequency response 20 mA measurement range, fsampling = 10 kHz, integrated filter 1/2 deactivated.....	64
Fig. 41	Representation resistance measurement range 5 kΩ.....	68
Fig. 42	Chart: RTD measuring range .....	69
Fig. 43	Representation potentiometer measurement range.....	73
Fig. 44	Representation measuring range SG 1/1 bridge.....	78
Fig. 45	Representation measuring range SG 1/2 bridge.....	84
Fig. 46	Representation measuring range SG 1/4 bridge 120 Ω.....	88
Fig. 47	Representation measuring range SG 1/4 bridge 350 Ω.....	92
Fig. 48	Opening the *. tzip archive .....	105
Fig. 49	Search of the existing HW configuration for the EtherCAT configuration of the example.....	106
Fig. 50	Process of interlacing the input data .....	119
Fig. 51	Configuration and setup for sample program 6: Doubling of the sample rate with 2 x EL3751 ...	119
Fig. 52	Setting the DC shift time for terminal 2 .....	120
Fig. 53	Oversampling 20 ksps with 2 x EL3751 with input signals (below) and result signal (top) .....	121
Fig. 54	Oversampling 20 ksps with 2 x EL3751 shows input value 1 and input value 2 alternately for a result value .....	122
Fig. 55	Decimation from 20 μs (left) to 22.675.. μs (right) with ELM3602.....	125
Fig. 56	Function block as an example for analysis of diagnostics information of the terminal.....	128
Fig. 57	Creation of PDO variables (TwinCAT version >= V3.1.4024.0).....	129
Fig. 58	Creation of the SmPdoVariables (TwinCAT version >= V3.1.4022.30) .....	130
Fig. 59	Seek the generated data type of SmPdoVariables .....	130
Fig. 60	Visualization of the sample implementation: Calibration signature .....	131
Fig. 61	Selection of the diagnostic information of an EtherCAT Slave .....	134
Fig. 62	Basic EtherCAT Slave Diagnosis in the PLC .....	135
Fig. 63	EL3102, CoE directory .....	137
Fig. 64	Example of commissioning aid for a EL3204 .....	138
Fig. 65	Default behaviour of the System Manager.....	139
Fig. 66	Default target state in the Slave .....	139
Fig. 67	PLC function blocks .....	140
Fig. 68	Illegally exceeding the E-Bus current .....	141
Fig. 69	Warning message for exceeding E-Bus current .....	141
Fig. 70	Relationship between user side (commissioning) and installation .....	142
Fig. 71	Control configuration with Embedded PC, input (EL1004) and output (EL2008).....	143
Fig. 72	Initial TwinCAT 2 user interface .....	144
Fig. 73	Selection of the target system.....	145
Fig. 74	specify the PLC for access by the TwinCAT System Manager: selection of the target system ...	145
Fig. 75	Select "Scan Devices...".....	146
Fig. 76	Automatic detection of I/O devices: selection of the devices to be integrated .....	146
Fig. 77	Mapping of the configuration in the TwinCAT 2 System Manager .....	147
Fig. 78	Reading of individual terminals connected to a device .....	147

Fig. 79	TwinCAT PLC Control after startup.....	148
Fig. 80	Example program with variables after a compile process (without variable integration).....	149
Fig. 81	Appending the TwinCAT PLC Control project.....	149
Fig. 82	PLC project integrated in the PLC configuration of the System Manager.....	150
Fig. 83	Creating the links between PLC variables and process objects .....	150
Fig. 84	Selecting BOOL-type PDO.....	151
Fig. 85	Selecting several PDOs simultaneously: activate “Continuous” and “All types” .....	151
Fig. 86	Application of a “Goto Link Variable”, using “MAIN.bEL1004_Ch4” as an example .....	152
Fig. 87	Choose target system (remote).....	153
Fig. 88	PLC Control logged in, ready for program startup .....	154
Fig. 89	Initial TwinCAT 3 user interface .....	155
Fig. 90	Create new TwinCAT 3 project .....	155
Fig. 91	New TwinCAT 3 project in the project folder explorer.....	156
Fig. 92	Selection dialog: Choose the target system.....	156
Fig. 93	specify the PLC for access by the TwinCAT System Manager: selection of the target system... ..	157
Fig. 94	Select “Scan”.....	157
Fig. 95	Automatic detection of I/O devices: selection of the devices to be integrated .....	158
Fig. 96	Mapping of the configuration in VS shell of the TwinCAT 3 environment .....	158
Fig. 97	Reading of individual terminals connected to a device .....	159
Fig. 98	Adding the programming environment in “PLC” .....	160
Fig. 99	Specifying the name and directory for the PLC programming environment.....	160
Fig. 100	Initial “Main” program for the standard PLC project .....	161
Fig. 101	Example program with variables after a compile process (without variable integration).....	162
Fig. 102	Start program compilation .....	162
Fig. 103	Creating the links between PLC variables and process objects .....	163
Fig. 104	Selecting BOOL-type PDO.....	163
Fig. 105	Selecting several PDOs simultaneously: activate “Continuous” and “All types” .....	164
Fig. 106	Application of a “Goto Link Variable”, using “MAIN.bEL1004_Ch4” as an example .....	164
Fig. 107	Creating a PLC data type.....	165
Fig. 108	Instance_of_struct.....	165
Fig. 109	Linking the structure .....	166
Fig. 110	Reading a variable from the structure of the process data .....	166
Fig. 111	TwinCAT 3 development environment (VS shell): logged-in, after program startup.....	167
Fig. 112	System Manager “Options” (TwinCAT 2).....	168
Fig. 113	Call up under VS Shell (TwinCAT 3).....	169
Fig. 114	TcRteInstall in the TwinCAT directory .....	169
Fig. 115	Overview of network interfaces .....	170
Fig. 116	EtherCAT device properties (TwinCAT 2): click on “Compatible Devices...” of tab “Adapter” .....	170
Fig. 117	Windows properties of the network interface .....	171
Fig. 118	Exemplary correct driver setting for the Ethernet port.....	171
Fig. 119	Incorrect driver settings for the Ethernet port .....	172
Fig. 120	TCP/IP setting for the Ethernet port .....	173
Fig. 121	Identifier structure .....	174
Fig. 122	OnlineDescription information window (TwinCAT 2).....	175
Fig. 123	Information window OnlineDescription (TwinCAT 3).....	175
Fig. 124	File OnlineDescription.xml created by the System Manager .....	176

Fig. 125 Indication of an online recorded ESI of EL2521 as an example ..... 176

Fig. 126 Information window for faulty ESI file (left: TwinCAT 2; right: TwinCAT 3) ..... 176

Fig. 127 Using the ESI Updater ( $\geq$  TwinCAT 2.11) ..... 178

Fig. 128 Using the ESI Updater (TwinCAT 3) ..... 178

Fig. 129 Append EtherCAT device (left: TwinCAT 2; right: TwinCAT 3) ..... 179

Fig. 130 Selecting the EtherCAT connection (TwinCAT 2.11, TwinCAT 3) ..... 179

Fig. 131 Selecting the Ethernet port ..... 179

Fig. 132 EtherCAT device properties (TwinCAT 2) ..... 180

Fig. 133 Appending EtherCAT devices (left: TwinCAT 2; right: TwinCAT 3) ..... 180

Fig. 134 Selection dialog for new EtherCAT device ..... 181

Fig. 135 Display of device revision ..... 181

Fig. 136 Display of previous revisions ..... 182

Fig. 137 Name/revision of the terminal ..... 182

Fig. 138 EtherCAT terminal in the TwinCAT tree (left: TwinCAT 2; right: TwinCAT 3) ..... 183

Fig. 139 Differentiation local/target system (left: TwinCAT 2; right: TwinCAT 3) ..... 184

Fig. 140 Scan Devices (left: TwinCAT 2; right: TwinCAT 3) ..... 184

Fig. 141 Note for automatic device scan (left: TwinCAT 2; right: TwinCAT 3) ..... 184

Fig. 142 Detected Ethernet devices ..... 185

Fig. 143 Example default state ..... 185

Fig. 144 Installing EthetCAT terminal with revision -1018 ..... 186

Fig. 145 Detection of EtherCAT terminal with revision -1019 ..... 186

Fig. 146 Scan query after automatic creation of an EtherCAT device (left: TwinCAT 2; right: TwinCAT 3) ..... 186

Fig. 147 Manual triggering of a device scan on a specified EtherCAT device (left: TwinCAT 2; right: TwinCAT 3) ..... 187

Fig. 148 Scan progressexemplary by TwinCAT 2 ..... 187

Fig. 149 Config/FreeRun query (left: TwinCAT 2; right: TwinCAT 3) ..... 187

Fig. 150 Displaying of “Free Run” and “Config Mode” toggling right below in the status bar ..... 187

Fig. 151 TwinCAT can also be switched to this state by using a button (left: TwinCAT 2; right: TwinCAT 3) ..... 187

Fig. 152 Online display example ..... 188

Fig. 153 Faulty identification ..... 188

Fig. 154 Identical configuration (left: TwinCAT 2; right: TwinCAT 3) ..... 189

Fig. 155 Correction dialog ..... 189

Fig. 156 Name/revision of the terminal ..... 190

Fig. 157 Correction dialog with modifications ..... 191

Fig. 158 Dialog “Change to Compatible Type...” (left: TwinCAT 2; right: TwinCAT 3) ..... 191

Fig. 159 TwinCAT 2 Dialog Change to Alternative Type ..... 192

Fig. 160 Branch element as terminal EL3751 ..... 192

Fig. 161 “General” tab ..... 192

Fig. 162 “EtherCAT” tab ..... 193

Fig. 163 “Process Data” tab ..... 194

Fig. 164 Configuring the process data ..... 195

Fig. 165 “Startup” tab ..... 196

Fig. 166 “CoE - Online” tab ..... 197

Fig. 167 Dialog “Advanced settings” ..... 198

Fig. 168 “Online” tab ..... 198



Fig. 169	“DC” tab (Distributed Clocks)	199
Fig. 170	System manager current calculation	208
Fig. 171	eEtherCAT tab -> Advanced Settings -> Behavior -> Watchdog	209
Fig. 172	States of the EtherCAT State Machine	211
Fig. 173	“CoE Online” tab	213
Fig. 174	Startup list in the TwinCAT System Manager	214
Fig. 175	Offline list	215
Fig. 176	Online list	216
Fig. 177	Recommended distances for standard installation position	218
Fig. 178	Other installation positions	219
Fig. 179	Correct positioning	220
Fig. 180	Incorrect positioning	220
Fig. 181	Shield busbar	224
Fig. 182	Shield busbar clamp	224
Fig. 183	Shield connection	225
Fig. 184	Attaching on mounting rail	226
Fig. 185	Disassembling of terminal	227
Fig. 186	Power contact on left side	228
Fig. 187	Standard wiring	229
Fig. 188	Pluggable wiring	229
Fig. 189	High Density Terminals	229
Fig. 190	Connecting a cable on a terminal point	231
Fig. 191	DiagMessages in the CoE	235
Fig. 192	Implementation of the DiagMessage system in the TwinCAT System Manager	236
Fig. 193	Startup List	236
Fig. 194	Schematic representation TCEventLogger	243
Fig. 195	Display EventLogger window	244
Fig. 196	Display DiagMessages and Logged Events	245
Fig. 197	Setting filter language	245
Fig. 198	Activating/deactivating event transmission	246
Fig. 199	Settings TwinCAT EventLogger	246
Fig. 200	Device identifier consisting of name EL3204-0000 and revision -0016	249
Fig. 201	Scan the subordinate field by right-clicking on the EtherCAT device	250
Fig. 202	Configuration is identical	250
Fig. 203	Change dialog	251
Fig. 204	EEPROM Update	251
Fig. 205	Selecting the new ESI	252
Fig. 206	Display of EL3204 firmware version	253
Fig. 207	Firmware Update	254
Fig. 208	FPGA firmware version definition	256
Fig. 209	Context menu Properties	256
Fig. 210	Dialog Advanced Settings	257
Fig. 211	Multiple selection and firmware update	259
Fig. 212	Selecting the Restore default parameters PDO	261
Fig. 213	Entering a restore value in the Set Value dialog	261





More Information:  
**[www.beckhoff.com/EL3751](http://www.beckhoff.com/EL3751)**

Beckhoff Automation GmbH & Co. KG  
Hülshorstweg 20  
33415 Verl  
Germany  
Phone: +49 5246 9630  
[info@beckhoff.com](mailto:info@beckhoff.com)  
[www.beckhoff.com](http://www.beckhoff.com)

