

Documentation | EN

EL5021, EL5021-0090

SinCos Encoder Interfaces



Table of contents

1 Foreword	5
1.1 Product overview EL5021 - SinCos Encoder Interface	5
1.2 Notes on the documentation	6
1.3 Safety instructions	7
1.4 Guide through documentation	8
1.5 Documentation issue status	9
1.6 Version identification of EtherCAT devices	10
1.6.1 General notes on marking	10
1.6.2 Version identification of EL terminals	10
1.6.3 Beckhoff Identification Code (BIC)	11
1.6.4 Electronic access to the BIC (eBIC)	13
2 EL5021 - Product description	16
2.1 Introduction	16
2.2 Technical data	17
2.3 Start	19
3 EL5021-0090 - Product description	20
3.1 Introduction	20
3.2 Technical data	21
3.3 Start	23
4 Basics communication	24
4.1 EtherCAT basics	24
4.2 EtherCAT cabling – wire-bound	24
4.3 General notes for setting the watchdog	25
4.4 EtherCAT State Machine	27
4.5 CoE Interface	29
4.6 Distributed Clock	34
5 Mounting and wiring	35
5.1 Instructions for ESD protection	35
5.2 Explosion protection	36
5.2.1 ATEX - Special conditions (standard temperature range)	36
5.2.2 IECEx - Special conditions	37
5.2.3 Continuative documentation for ATEX and IECEx	38
5.3 UL notice	39
5.4 Installation on mounting rails	40
5.5 Installation instructions for enhanced mechanical load capacity	43
5.6 Connection	44
5.6.1 Connection system	44
5.6.2 Wiring	46
5.6.3 Shielding	47
5.7 Note - Power supply	47
5.8 Positioning of passive Terminals	48
5.9 Installation positions	49
5.10 EL5021-00x0 - Connection	51

5.11	EL5021-00x0 - Diagnostic LEDs	52
5.12	Disposal	52
6	Commissioning	53
6.1	TwinCAT Quick Start.....	53
6.1.1	TwinCAT 2	56
6.1.2	TwinCAT 3	66
6.2	TwinCAT Development Environment	79
6.2.1	Installation of the TwinCAT real-time driver	80
6.2.2	Notes regarding ESI device description	86
6.2.3	TwinCAT ESI Updater	90
6.2.4	Distinction between Online and Offline	90
6.2.5	OFFLINE configuration creation.....	91
6.2.6	ONLINE configuration creation	96
6.2.7	EtherCAT subscriber configuration	104
6.2.8	Import/Export of EtherCAT devices with SCI and XTI.....	113
6.3	General Commissioning Instructions for an EtherCAT Slave	119
7	EL5021-00x0 - Commissioning	127
7.1	Principle of the sine/cosine measurement	127
7.2	DC (Distributed Clocks).....	128
7.2.1	Operation mode (trigger mode).....	128
7.3	Process data EL5021-00x0	131
7.4	TwinSAFE SC process data EL5021-0090	132
7.5	Settings via the CoE directory	133
7.6	Functional principles	134
7.6.1	EL5021-00x0	134
7.6.2	EL5021-0090.....	142
7.7	EL5021-00x0 - Object description and parameterization	147
7.7.1	Restore object.....	147
7.7.2	Configuration data.....	148
7.7.3	Input data	149
7.7.4	Output data	150
7.7.5	Information / diagnostic data	150
7.7.6	Standard objects	150
7.8	Sample Program	158
8	Appendix	162
8.1	EtherCAT AL Status Codes	162
8.2	Firmware compatibility	162
8.3	Firmware Update EL/ES/EM/ELM/EP/EPP/ERPxxxx	163
8.3.1	Device description ESI file/XML	164
8.3.2	Firmware explanation.....	167
8.3.3	Updating controller firmware *.efw	168
8.3.4	FPGA firmware *.rbf	170
8.3.5	Simultaneous updating of several EtherCAT devices	174
8.4	Restoring the delivery state.....	175
8.5	Support and Service.....	177

1 Foreword

1.1 Product overview EL5021 - SinCos Encoder Interface

[EL5021 \[► 16\]](#)

1-channel SinCos encoder interface Terminal, 1 V_{pp}

[EL5021-0090 \[► 20\]](#)

1-channel SinCos-SinCos encoder interface Terminal, TwinSAFE Single Channel

1.2 Notes on the documentation

Intended audience

This description is only intended for the use of trained specialists in control and automation engineering who are familiar with the applicable national standards.

It is essential that the documentation and the following notes and explanations are followed when installing and commissioning these components.

The qualified personnel is obliged to always use the currently valid documentation.

The responsible staff must ensure that the application or use of the products described satisfy all the requirements for safety, including all the relevant laws, regulations, guidelines and standards.

Disclaimer

The documentation has been prepared with care. The products described are, however, constantly under development.

We reserve the right to revise and change the documentation at any time and without prior announcement.

No claims for the modification of products that have already been supplied may be made on the basis of the data, diagrams and descriptions in this documentation.

Trademarks

Beckhoff®, TwinCAT®, TwinCAT/BSD®, TC/BSD®, EtherCAT®, EtherCAT G®, EtherCAT G10®, EtherCAT P®, Safety over EtherCAT®, TwinSAFE®, XFC®, XTS® and XPlanar® are registered trademarks of and licensed by Beckhoff Automation GmbH. Other designations used in this publication may be trademarks whose use by third parties for their own purposes could violate the rights of the owners.

Patent Pending

The EtherCAT Technology is covered, including but not limited to the following patent applications and patents: EP1590927, EP1789857, EP1456722, EP2137893, DE102015105702 with corresponding applications or registrations in various other countries.



EtherCAT® is registered trademark and patented technology, licensed by Beckhoff Automation GmbH, Germany.

Copyright

© Beckhoff Automation GmbH & Co. KG, Germany.

The reproduction, distribution and utilization of this document as well as the communication of its contents to others without express authorization are prohibited.

Offenders will be held liable for the payment of damages. All rights reserved in the event of the grant of a patent, utility model or design.

1.3 Safety instructions

Safety regulations

Please note the following safety instructions and explanations!
Product-specific safety instructions can be found on following pages or in the areas mounting, wiring, commissioning etc.

Exclusion of liability

All the components are supplied in particular hardware and software configurations appropriate for the application. Modifications to hardware or software configurations other than those described in the documentation are not permitted, and nullify the liability of Beckhoff Automation GmbH & Co. KG.

Personnel qualification

This description is only intended for trained specialists in control, automation and drive engineering who are familiar with the applicable national standards.

Signal words

The signal words used in the documentation are classified below. In order to prevent injury and damage to persons and property, read and follow the safety and warning notices.

Personal injury warnings

⚠ DANGER

Hazard with high risk of death or serious injury.

⚠ WARNING

Hazard with medium risk of death or serious injury.

⚠ CAUTION

There is a low-risk hazard that could result in medium or minor injury.

Warning of damage to property or environment

NOTICE

The environment, equipment, or data may be damaged.

Information on handling the product



This information includes, for example:
recommendations for action, assistance or further information on the product.

1.4 Guide through documentation

NOTICE



Further components of documentation

This documentation describes device-specific content. It is part of the modular documentation concept for Beckhoff I/O components. For the use and safe operation of the device / devices described in this documentation, additional cross-product descriptions are required, which can be found in the following table.

Title	Description
EtherCAT System Documentation (PDF)	<ul style="list-style-type: none"> • System overview • EtherCAT basics • Cable redundancy • Hot Connect • EtherCAT devices configuration
Explosion Protection for Terminal Systems (PDF)	Notes on the use of the Beckhoff terminal systems in hazardous areas according to ATEX and IECEx
Infrastructure for EtherCAT/Ethernet (PDF)	Technical recommendations and notes for design, implementation and testing
Software Declarations I/O (PDF)	Open source software declarations for Beckhoff I/O components

The documentations can be viewed at and downloaded from the Beckhoff website (www.beckhoff.com) via:

- the “Documentation and Download” area of the respective product page,
- the [Download finder](#),
- the [Beckhoff Information System](#).

1.5 Documentation issue status

Version	Comment
3.9	<ul style="list-style-type: none"> • Update Technical data • Update revision status
3.8	<ul style="list-style-type: none"> • Update chapter "Mounting and wiring" • Update chapter "Frequency measurement/velocity measurement" • Update chapter "Filter operation" • Update chapter "Operation mode (Trigger mode)" • Update chapter "TwinSAFE SC process data EL5021-0090) • Structural update
3.7	<ul style="list-style-type: none"> • New title page • Update chapter "Introduction" • Update chapter "Technical data" • Update chapter "EL5021-00x0 - connection" • Chapter "Disposal" inserted • Structural update
3.6	<ul style="list-style-type: none"> • Update chapter "Technical data" • Update chapter "LEDs and connection" • Structural update
3.5	<ul style="list-style-type: none"> • Update chapter "Object directory and parameterization" • Structural update
3.4	<ul style="list-style-type: none"> • Update chapter "Technical data" • Update revision status • Structural update
3.3	<ul style="list-style-type: none"> • Update chapter "TwinSAFE SC" • Structural update
3.2	<ul style="list-style-type: none"> • Update chapter "Technical data" • Chapter "Installation instructions for enhanced mechanical load capacity" added • Update chapter "Sample program"
3.1	<ul style="list-style-type: none"> • Chapter "Filter operation" added • Update revision status
3.0	<ul style="list-style-type: none"> • Addendum EL5021-0090 • Structural update • Corrections and addenda • Update revision status
0.1 - 2.0	<ul style="list-style-type: none"> • Archived

1.6 Version identification of EtherCAT devices

1.6.1 General notes on marking

Designation

A Beckhoff EtherCAT device has a 14-digit designation, made up of

- family key
- type
- version
- revision

Example	Family	Type	Version	Revision
EL3314-0000-0016	EL terminal 12 mm, non-pluggable connection level	3314 4-channel thermocouple terminal	0000 basic type	0016
ES3602-0010-0017	ES terminal 12 mm, pluggable connection level	3602 2-channel voltage measurement	0010 high-precision version	0017
CU2008-0000-0000	CU device	2008 8-port fast ethernet switch	0000 basic type	0000

Notes

- The elements mentioned above result in the **technical designation**. EL3314-0000-0016 is used in the example below.
- EL3314-0000 is the order identifier, in the case of "-0000" usually abbreviated to EL3314. "-0016" is the EtherCAT revision.
- The **order identifier** is made up of
 - family key (EL, EP, CU, ES, KL, CX, etc.)
 - type (3314)
 - version (-0000)
- The **revision** -0016 shows the technical progress, such as the extension of features with regard to the EtherCAT communication, and is managed by Beckhoff.
In principle, a device with a higher revision can replace a device with a lower revision, unless specified otherwise, e.g. in the documentation.
Associated and synonymous with each revision there is usually a description (ESI, EtherCAT Slave Information) in the form of an XML file, which is available for download from the Beckhoff web site.
From 2014/01 the revision is shown on the outside of the IP20 terminals, see Fig. "EL5021 EL terminal, standard IP20 IO device with batch number and revision ID (since 2014/01)".
- The type, version and revision are read as decimal numbers, even if they are technically saved in hexadecimal.

1.6.2 Version identification of EL terminals

The serial number/ data code for Beckhoff IO devices is usually the 8-digit number printed on the device or on a sticker. The serial number indicates the configuration in delivery state and therefore refers to a whole production batch, without distinguishing the individual modules of a batch.

Structure of the serial number: **KK YY FF HH**

KK - week of production (CW, calendar week)
YY - year of production
FF - firmware version
HH - hardware version

Example with serial number 12 06 3A 02:

12 - production week 12
06 - production year 2006
3A - firmware version 3A
02 - hardware version 02



Fig. 1: EL2872 with revision 0022 and serial number 01200815

1.6.3 Beckhoff Identification Code (BIC)

The Beckhoff Identification Code (BIC) is increasingly being applied to Beckhoff products to uniquely identify the product. The BIC is represented as a Data Matrix Code (DMC, code scheme ECC200), the content is based on the ANSI standard MH10.8.2-2016.

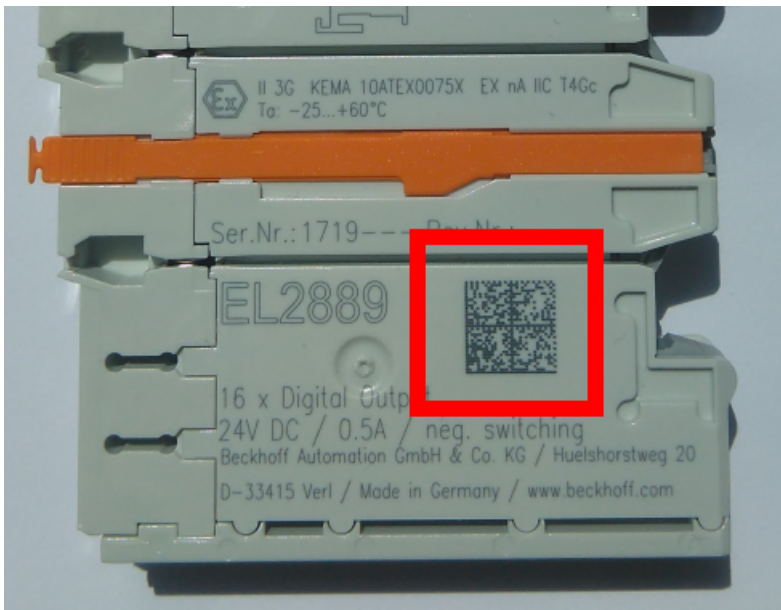

Fig. 2: BIC as data matrix code (DMC, code scheme ECC200)

The BIC will be introduced step by step across all product groups.

Depending on the product, it can be found in the following places:

- on the packaging unit
- directly on the product (if space suffices)
- on the packaging unit and the product

The BIC is machine-readable and contains information that can also be used by the customer for handling and product management.

Each piece of information can be uniquely identified using the so-called data identifier (ANSI MH10.8.2-2016). The data identifier is followed by a character string. Both together have a maximum length according to the table below. If the information is shorter, spaces are added to it.

Following information is possible, positions 1 to 4 are always present, the other according to need of production:

Position	Type of information	Explanation	Data identifier	Number of digits incl. data identifier	Example
1	Beckhoff order number	Beckhoff order number	1P	8	1P 072222
2	Beckhoff Traceability Number (BTN)	Unique serial number, see note below	SBTN	12	SBTN k4p562d7
3	Article description	Beckhoff article description, e.g. EL1008	1K	32	1K EL1809
4	Quantity	Quantity in packaging unit, e.g. 1, 10, etc.	Q	6	Q1
5	Batch number	Optional: Year and week of production	2P	14	2P 401503180016
6	ID/serial number	Optional: Present-day serial number system, e.g. with safety products	51S	12	51S 678294
7	Variant number	Optional: Product variant number on the basis of standard products	30P	32	30P F971, 2*K183
...					

Further types of information and data identifiers are used by Beckhoff and serve internal processes.

Structure of the BIC

Example of composite information from positions 1 to 4 and with the above given example value on position 6. The data identifiers are highlighted in bold font:

1P072222**SBTN**k4p562d7**1K**EL1809 **Q1** **51S**678294

Accordingly as DMC:



Fig. 3: Example DMC **1P**072222**SBTN**k4p562d7**1K**EL1809 **Q1** **51S**678294

BTN

An important component of the BIC is the Beckhoff Traceability Number (BTN, position 2). The BTN is a unique serial number consisting of eight characters that will replace all other serial number systems at Beckhoff in the long term (e.g. batch designations on IO components, previous serial number range for safety products, etc.). The BTN will also be introduced step by step, so it may happen that the BTN is not yet coded in the BIC.

NOTICE

This information has been carefully prepared. However, the procedure described is constantly being further developed. We reserve the right to revise and change procedures and documentation at any time and without prior notice. No claims for changes can be made from the information, illustrations and descriptions in this information.

1.6.4 Electronic access to the BIC (eBIC)

Electronic BIC (eBIC)

The Beckhoff Identification Code (BIC) is applied to the outside of Beckhoff products in a visible place. If possible, it should also be electronically readable.

The interface that the product can be electronically addressed by is crucial for the electronic readout.

K-bus devices (IP20, IP67)

Currently, no electronic storage or readout is planned for these devices.

EtherCAT devices (IP20, IP67)

All Beckhoff EtherCAT devices have an ESI-EEPROM which contains the EtherCAT identity with the revision number. The EtherCAT slave information, also colloquially known as the ESI/XML configuration file for the EtherCAT master, is stored in it. See the corresponding chapter in the EtherCAT system manual ([Link](#)) for the relationships.

Beckhoff also stores the eBIC in the ESI-EEPROM. The eBIC was introduced into Beckhoff IO production (terminals, box modules) in 2020; as of 2023, implementation is largely complete.

The user can electronically access the eBIC (if present) as follows:

- With all EtherCAT devices, the EtherCAT master (TwinCAT) can read the eBIC from the ESI-EEPROM
 - From TwinCAT 3.1 build 4024.11, the eBIC can be displayed in the online view.
 - To do this, check the "Show Beckhoff Identification Code (BIC)" checkbox under EtherCAT → Advanced Settings → Diagnostics:

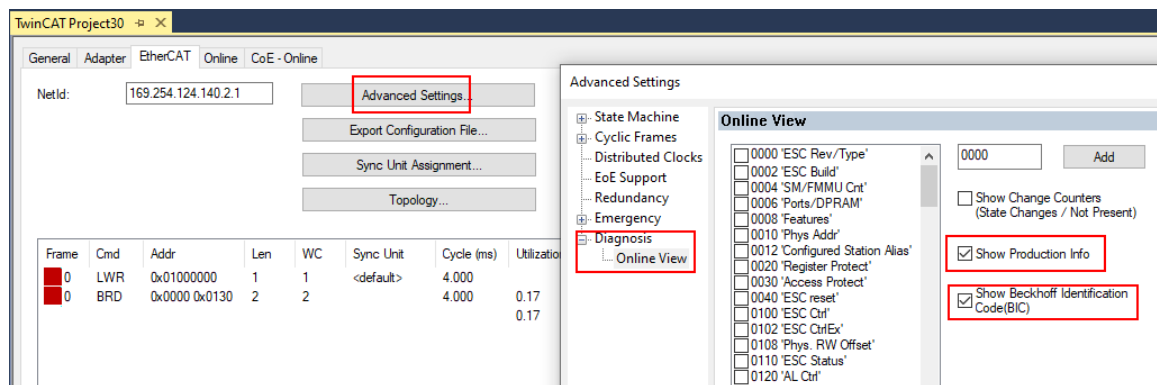

- The BTN and its contents are then displayed:

No	Addr	Name	State	CRC	Fw	Hw	Production Data	ItemNo	BTN	Description	Quantity	BatchNo	SerialNo
1	1001	Term 1 (EK1100)	OP	0.0	0	0	---						
2	1002	Term 2 (EL1018)	OP	0.0	0	0	2020 KW36 Fr	072222	k4p562d7	EL1809	1		678294
3	1003	Term 3 (EL3204)	OP	0.0	7	6	2012 KW24 Sa						
4	1004	Term 4 (EL2004)	OP	0.0	0	0	---	072223	k4p562d7	EL2004	1		678295
5	1005	Term 5 (EL1008)	OP	0.0	0	0	---						
6	1006	Term 6 (EL2008)	OP	0.0	0	12	2014 KW14 Mo						
7	1007	Term 7 (EK1110)	OP	0	1	8	2012 KW25 Mo						

- Note: As shown in the figure, the production data HW version, FW version, and production date, which have been programmed since 2012, can also be displayed with "Show production info".
- Access from the PLC: From TwinCAT 3.1. build 4024.24, the functions *FB_EcReadBIC* and *FB_EcReadBTN* for reading into the PLC are available in the *Tc2_EtherCAT* library from v3.3.19.0.
- EtherCAT devices with a CoE directory may also have the object 0x10E2:01 to display their own eBIC, which can also be easily accessed by the PLC:

- The device must be in PREOP/SAFEOP/OP for access:

Index	Name	Flags	Value
1000	Device type	RO	0x015E1389 (22942601)
1008	Device name	RO	ELM3704-0000
1009	Hardware version	RO	00
100A	Software version	RO	01
100B	Bootloader version	RO	J0.1.27.0
1011:0	Restore default parameters	RO	> 1 <
1018:0	Identity	RO	> 4 <
10E2:0	Manufacturer-specific Identification C...	RO	> 1 <
10E2:01	SubIndex 001	RO	1P158442SBTN0008jckp1KELM3704 Q1 2P482001000016
10F0:0	Backup parameter handling	RO	> 1 <
10F3:0	Diagnosis History	RO	> 21 <
10F8	Actual Time Stamp	RO	0x170bfb277e

- The object 0x10E2 will be preferentially introduced into stock products in the course of necessary firmware revision.
- From TwinCAT 3.1. build 4024.24, the functions *FB_EcCoEReadBIC* and *FB_EcCoEReadBTN* for reading into the PLC are available in the *Tc2_EtherCAT* library from v3.3.19.0
- The following auxiliary functions are available for processing the BIC/BTN data in the PLC in *Tc2_Uilities* as of TwinCAT 3.1 build 4024.24
 - *F_SplitBIC*: The function splits the Beckhoff Identification Code (BIC) *sBICValue* into its components using known identifiers and returns the recognized substrings in the *ST_SplittedBIC* structure as a return value
 - *BIC_TO_BTN*: The function extracts the BTN from the BIC and returns it as a return value
- Note: If there is further electronic processing, the BTN is to be handled as a string(8); the identifier "SBTN" is not part of the BTN.
- Technical background
The new BIC information is written as an additional category in the ESI-EEPROM during device production. The structure of the ESI content is largely dictated by the ETG specifications, therefore the additional vendor-specific content is stored using a category in accordance with the ETG.2010. ID 03 tells all EtherCAT masters that they may not overwrite these data in the event of an update or restore the data after an ESI update.
The structure follows the content of the BIC, see here. The EEPROM therefore requires approx. 50..200 bytes of memory.
- Special cases
 - If multiple hierarchically arranged ESCs are installed in a device, only the top-level ESC carries the eBIC information.
 - If multiple non-hierarchically arranged ESCs are installed in a device, all ESCs carry the eBIC information.
 - If the device consists of several sub-devices which each have their own identity, but only the top-level device is accessible via EtherCAT, the eBIC of the top-level device is located in the CoE object directory 0x10E2:01 and the eBICs of the sub-devices follow in 0x10E2:nn.

PROFIBUS; PROFINET, and DeviceNet devices

Currently, no electronic storage or readout is planned for these devices.

2 EL5021 - Product description

2.1 Introduction

1 Channel SinCos Encoder Interface Terminal

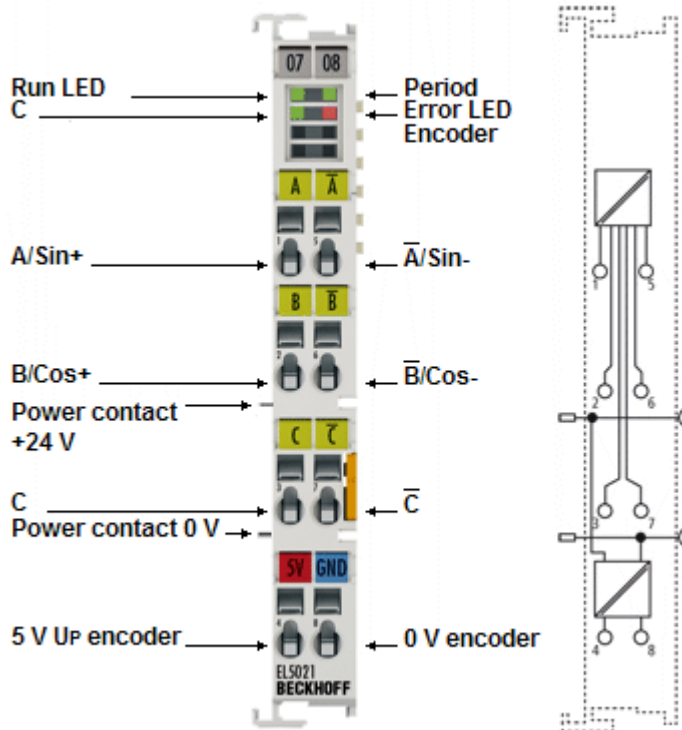

Fig. 4: EL5021

The EL5021 SinCos EtherCAT terminal serves as interface for the direct connection of a measuring sensor, e.g. a measuring probe with sinusoidal voltage output $1 V_{pp}$ to the higher-level fieldbus.

The measuring signal is processed, interpolated and made available as a 32 bit value. The signal period resolution is 13 bit. The reference mark is also stored in a 32 bit value. The current count and the reference mark value can be read. The input frequency for the measuring signal inputs is 250 kHz.

The current counter reading can be zeroed (reset) or stored separately via the C track of the encoder, which is also called reference mark. The 5 V supply to the encoder is provided directly via the terminal connection points. The EL5021 features amplitude and frequency error detection of the input signals.

The EL5021 also provides an internal frequency measurement (from FW07).

It also supports synchronous reading of the encoder value together with other input data in the EtherCAT system via the high-precision EtherCAT distributed clocks (DC). The use of encoder profiles enables simple and fast linking of process data to Motion Control applications.

Also see about this

- 📖 Technical data [▶ 17]
- 📖 Functional principles [▶ 134]
- 📖 EL5021-00x0 - Object description and parameterization [▶ 147]
- 📖 Basics communication [▶ 24]
- 📖 Sample Program [▶ 158]

2.2 Technical data

Encoder	EL5021
Number of channels	1
Encoder connection	A+/Sin+, A-/Sin- B+/Cos+, B-/Cos- C+, C- Level: nominal 1 Vpp (0.6...1.2 Vpp), averaged voltage to GND: 2.5 V Notice Unipolar SinCos signals (i.e. without A-, B- or C-) are recognized as wire break/amplitude error
Position specification	32 bits (period counter + period portion, adjustable)
Period counter	19 ... 24 bits according to setting, default: 22 bits
Period resolution	8 ... 13 bits (256 ... 8192 steps per period), depends on input frequency, auto. reduction of resolution depending on the input frequency, default: 10 bits
Signal frequency	max. 250 kHz @ 10-bit period resolution Sampling of the input signals with 70 MHz

Function and communication	EL5021
min. sampling rate/cycle time	80 µs
Sampling	EtherCAT-synchronously or Distributed Clocks triggered
Distributed Clocks	yes
Functions	<ul style="list-style-type: none"> • C-Reset, • C-Latch, • Display amplitude/frequency error, • Change counting direction, • Frequency measurement, velocity measurement (from FW07 ▶ 162)

Supply and potentials	EL5021
Power supply for the electronics	via the power contacts, approx. 50 mA without external encoder
Current consumption via E-bus	typ. 120 mA
Electrical isolation	500 V (E-bus/field voltage)
Encoder operating voltage/ Encoder supply	5 V (-5% / +10%), max. 0.5 A (short-circuit proof) (generated from the 24 V _{DC} power contacts)

Environmental conditions	EL5021
Permissible ambient temperature range during operation	-25°C... +55°C
Permissible ambient temperature range during storage	-40°C... +85°C
Permissible relative air humidity	95%, no condensation

General data	EL5021
Dimensions (W x H x D)	approx. 15 mm x 100 mm x 70 mm (width aligned: 12 mm)
Weight	approx. 50 g
Installation ▶ 35	on 35 mm mounting rail, conforms to EN 60715

Standards and approvals	EL5021
Enhanced mechanical load capacity	Yes, see also Installation instructions [▶ 43] for terminals with enhanced mechanical load capacity
Vibration / shock resistance	conforms to EN 60068-2-6 / EN 60068-2-27
EMC immunity / emission	conforms to EN 61000-6-2 / EN 61000-6-4
Protection rating	IP20
Installation position	variable
Approvals, markings*	CE, EAC, UKCA cULus [▶ 39] ATEX [▶ 36] , IECEX [▶ 37]

*) Real applicable approvals/markings see type plate on the side (product marking).

Ex markings

Standard	Marking
ATEX	II 3 G Ex nA IIC T4 Gc
IECEX	Ex nA IIC T4 Gc

2.3 Start

For commissioning:

- mount the EL5021-00x0 as described in the chapter [Mounting and wiring \[▶ 35\]](#)
- configure the EL5021-00x0 in TwinCAT as described in the chapters [Commissioning \[▶ 80\]](#) and [EL5021-00x0 - Commissioning \[▶ 127\]](#)

3 EL5021-0090 - Product description

3.1 Introduction

1-channel sin/cos encoder interface terminal, TwinSAFE Single Channel

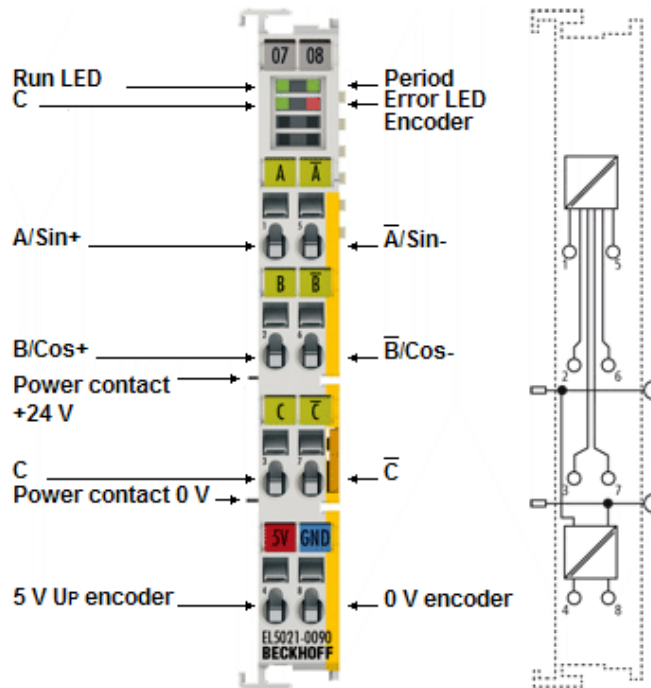

Fig. 5: EL5021-0090

The EL5021-0090 EtherCAT Terminal is used for the direct connection of a measuring probe or encoder with sinusoidal, differential voltage output $1 V_{PP}$. Input frequencies of max. 250 kHz can be evaluated.

The current counter reading can be zeroed (reset) or stored separately via the C track of the encoder, which is also called reference mark. The 5 V supply to the encoder is provided directly via the terminal connection points. The EL5021-0090 features amplitude and frequency error detection of the input signals.

The analog input signal is processed, interpolated and made available as a 32-bit count value. The count value is a combination of the number of whole periods, max. 24 bits, and the value within one sine period, with max. 13 bit resolution.

The EL5021-0090 provides an internal frequency measurement.

It also supports synchronous reading of the encoder value together with other input data in the EtherCAT system via the high-precision EtherCAT distributed clocks (DC).

In addition to the full functionality of the EL5021, the EL5021-0090 supports TwinSAFE SC (Single Channel) technology. This enables the use of standard signals for safety tasks in any networks of fieldbuses.

Also see about this

- 📖 Functional principles [▶ 134]
- 📖 EL5021-00x0 - Object description and parameterization [▶ 147]
- 📖 Basics communication [▶ 24]
- 📖 Sample Program [▶ 158]
- 📖 Technical data [▶ 21]

3.2 Technical data

Encoder	EL5021-0090
Number of channels	1
Encoder connection	A+/Sin+, A-/Sin- B+/Cos+, B-/Cos- C+, C- Level: nominal 1 Vpp (0.6 ... 1.2 Vpp), averaged voltage to GND: 2.5 V Notice Unipolar SinCos signals (i.e. without A-, B- or C-) are recognized as wire break/amplitude error.
Position specification	32 bits (period counter + period portion, adjustable)
Period counter	19 ... 24 bits according to setting, default: 22 bits
Period resolution	8 ... 13 bits (256 ... 8192 steps per period), depends on input frequency, auto. reduction of resolution depending on the input frequency, default: 10 bits
Signal frequency	max. 250 kHz @ 10-bit period resolution Sampling of the input signals with 70 MHz

Function and communication	EL5021-0090
min. sampling rate/cycle time	80 µs
Sampling	EtherCAT-synchronously or Distributed Clocks triggered
Distributed Clocks	yes
Functions	<ul style="list-style-type: none"> • C-Reset, • C-Latch, • Display amplitude/frequency error, • Change counting direction, • Frequency measurement, velocity measurement

Supply and potentials	EL5021-0090
Power supply for the electronics	via the power contacts, approx. 50 mA without external encoder
Current consumption via E-bus	typ. 120 mA
Electrical isolation	500 V (E-bus/field voltage)
Encoder operating voltage/ Encoder supply	5 V (-5% / +10%), max. 0.5 A (short-circuit proof) (generated from the 24 V _{DC} power contacts)

Environmental conditions	EL5021-0090
Permissible ambient temperature range during operation	-25°C ... +55°C
Permissible ambient temperature range during storage	-40°C ... +85°C
Permissible relative air humidity	95%, no condensation

General data	EL5021-0090
MTBF (+55°C)	> 1,205,000 h
Weight	approx. 50 g
Dimensions (W x H x D)	approx. 15 mm x 100 mm x 70 mm (width aligned: 12 mm)
Installation [► 35]	on 35 mm mounting rail, conforms to EN 60715
Installation position	variable

Standards and approvals	EL5021-0090
Enhanced mechanical load capacity	Yes, see also Installation instructions [▶ 43] for enhanced mechanical load capacity
Vibration / shock resistance	conforms to EN 60068-2-6 / EN 60068-2-27
EMC immunity / emission	conforms to EN 61000-6-2 / EN 61000-6-4
Protection rating	IP20
Approvals/markings*	CE, EAC, UKCA cULus [▶ 39] ATEX [▶ 36] , IECEx [▶ 37]

*) Real applicable approvals/markings see type plate on the side (product marking).

Ex markings

Standard	Marking
ATEX	II 3 G Ex nA IIC T4 Gc
IECEx	Ex nA IIC T4 Gc

3.3 Start

For commissioning:

- mount the EL5021-00x0 as described in the chapter [Mounting and wiring \[▶ 35\]](#)
- configure the EL5021-00x0 in TwinCAT as described in the chapters [Commissioning \[▶ 80\]](#) and [EL5021-00x0 - Commissioning \[▶ 127\]](#)
- consider the notes for the EL5021-0090 as described in the chapter [Configuration in TwinSAFE SC \[▶ 142\]](#)

4 Basics communication

4.1 EtherCAT basics

Please refer to the [EtherCAT System Documentation](#) for the EtherCAT fieldbus basics.

4.2 EtherCAT cabling – wire-bound

The cable length between two EtherCAT devices must not exceed 100 m. This results from the FastEthernet technology, which, above all for reasons of signal attenuation over the length of the cable, allows a maximum link length of 5 + 90 + 5 m if cables with appropriate properties are used. See also the [Design recommendations for the infrastructure for EtherCAT/Ethernet](#).

Cables and connectors

For connecting EtherCAT devices only Ethernet connections (cables + plugs) that meet the requirements of at least category 5 (Cat5) according to EN 50173 or ISO/IEC 11801 should be used. EtherCAT uses 4 wires for signal transfer.

EtherCAT uses RJ45 plug connectors, for example. The pin assignment is compatible with the Ethernet standard (ISO/IEC 8802-3).

Pin	Color of conductor	Signal	Description
1	yellow	TD +	Transmission Data +
2	orange	TD -	Transmission Data -
3	white	RD +	Receiver Data +
6	blue	RD -	Receiver Data -

Due to automatic cable detection (auto-crossing) symmetric (1:1) or cross-over cables can be used between EtherCAT devices from Beckhoff.

● Recommended cables

- i** It is recommended to use the appropriate Beckhoff components e.g.
- cable sets ZK1090-9191-xxxx respectively
 - RJ45 connector, field assembly ZS1090-0005
 - EtherCAT cable, field assembly ZB9010, ZB9020

Suitable cables for the connection of EtherCAT devices can be found on the [Beckhoff website!](#)

E-Bus supply

A bus coupler can supply the EL terminals added to it with the E-bus system voltage of 5 V; a coupler is thereby loadable up to 2 A as a rule (see details in respective device documentation). Information on how much current each EL terminal requires from the E-bus supply is available online and in the catalogue. If the added terminals require more current than the coupler can supply, then power feed terminals (e.g. [EL9410](#)) must be inserted at appropriate places in the terminal strand.

The pre-calculated theoretical maximum E-Bus current is displayed in the TwinCAT System Manager. A shortfall is marked by a negative total amount and an exclamation mark; a power feed terminal is to be placed before such a position.

The screenshot shows the 'I/O Devices' tree on the left with 'Device 1 (EtherCAT)' expanded. The table on the right lists 9 terminals with their respective current values in mA. The 'E-Bus (mA)' column is highlighted with a red box.

Number	Box Name	Add...	Type	In Si...	Out ...	E-Bus (mA)
1	Term 1 (EK1100)	1001	EK1100			
2	Term 2 (EL2008)	1002	EL2008		1.0	1890
3	Term 3 (EL2008)	1003	EL2008		1.0	1780
4	Term 4 (EL2008)	1004	EL2008		1.0	1670
5	Term 5 (EL6740-...)	1005	EL6740-0010	2.0	2.0	1220
6	Term 6 (EL6740-...)	1006	EL6740-0010	2.0	2.0	770
7	Term 7 (EL6740-...)	1007	EL6740-0010	2.0	2.0	320
8	Term 8 (EL6740-...)	1008	EL6740-0010	2.0	2.0	-130 I
9	Term 9 (EL6740-...)	1009	EL6740-0010	2.0	2.0	-580 I

Fig. 6: System manager current calculation

NOTICE

Malfunction possible!

The same ground potential must be used for the E-Bus supply of all EtherCAT terminals in a terminal block!

4.3 General notes for setting the watchdog

The EtherCAT terminals are equipped with a safety device (watchdog) which, e. g. in the event of interrupted process data traffic, switches the outputs (if present) to a presettable state after a presettable time, depending on the device and setting, e. g. to FALSE (off) or an output value.

The EtherCAT slave controller (ESC) features two watchdogs:

- SM watchdog (default: 100 ms)
- PDI watchdog (default: 100 ms)

Their times are individually parameterized in TwinCAT as follows:

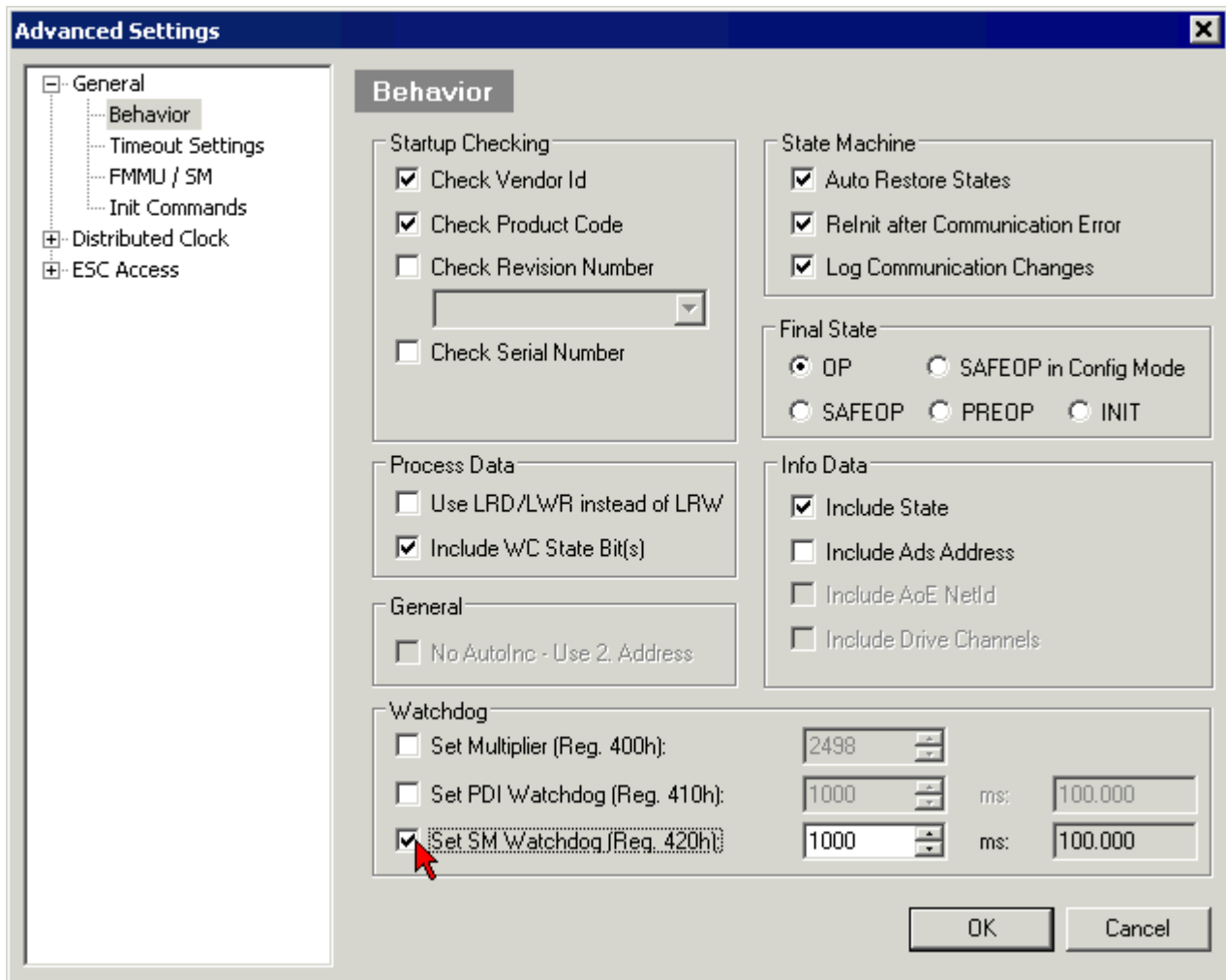

Fig. 7: eEtherCAT tab -> Advanced Settings -> Behavior -> Watchdog

Notes:

- the Multiplier Register 400h (hexadecimal, i. e. x0400) is valid for both watchdogs.
- each watchdog has its own timer setting 410h or 420h, which together with the Multiplier results in a resulting time.
- important: the Multiplier/Timer setting is only loaded into the slave at EtherCAT startup if the checkbox in front of it is activated.
- if it is not checked, nothing is downloaded and the setting located in the ESC remains unchanged.
- the downloaded values can be seen in the ESC registers x0400/0410/0420: ESC Access -> Memory

SM watchdog (SyncManager Watchdog)

The SyncManager watchdog is reset with each successful EtherCAT process data communication with the terminal. If, for example, no EtherCAT process data communication with the terminal takes place for longer than the set and activated SM watchdog time due to a line interruption, the watchdog is triggered. The status of the terminal (usually OP) remains unaffected. The watchdog is only reset again by a successful EtherCAT process data access.

The SyncManager watchdog is therefore a monitoring for correct and timely process data communication with the ESC from the EtherCAT side.

The maximum possible watchdog time depends on the device. For example, for "simple" EtherCAT slaves (without firmware) with watchdog execution in the ESC it is usually up to 170 seconds. For complex EtherCAT slaves (with firmware) the SM watchdog function is usually parameterized via Reg. 400/420 but executed by the μ C and can be significantly lower. In addition, the execution may then be subject to a certain time uncertainty. Since the TwinCAT dialog may allow inputs up to 65535, a test of the desired watchdog time is recommended.

PDI watchdog (Process Data Watchdog)

If there is no PDI communication with the EtherCAT slave controller (ESC) for longer than the set and activated PDI watchdog time, this watchdog is triggered.

PDI (Process Data Interface) is the internal interface of the ESC, e.g. to local processors in the EtherCAT slave. With the PDI watchdog this communication can be monitored for failure.

The PDI watchdog is therefore a monitoring for correct and timely process data communication with the ESC, but viewed from the application side.

Calculation

Watchdog time = $[1/25 \text{ MHz} * (\text{Watchdog multiplier} + 2)] * \text{PDI/SM watchdog}$

Example: default setting Multiplier=2498, SM watchdog=1000 -> 100 ms

The value in Multiplier + 2 corresponds to the number of 40ns base ticks representing one watchdog tick.

CAUTION

Undefined state possible!

The function for switching off the SM watchdog via SM watchdog = 0 is only implemented in terminals from version -0016. In previous versions this operating mode should not be used.

CAUTION

Damage of devices and undefined state possible!

If the SM watchdog is activated and a value of 0 is entered the watchdog switches off completely. This is the deactivation of the watchdog! Set outputs are NOT set in a safe state if the communication is interrupted.

4.4 EtherCAT State Machine

The state of the EtherCAT slave is controlled via the EtherCAT State Machine (ESM). Depending upon the state, different functions are accessible or executable in the EtherCAT slave. Specific commands must be sent by the EtherCAT master to the device in each state, particularly during the bootup of the slave.

A distinction is made between the following states:

- Init
- Pre-Operational
- Safe-Operational and
- Operational
- Boot

The regular state of each EtherCAT slave after bootup is the OP state.

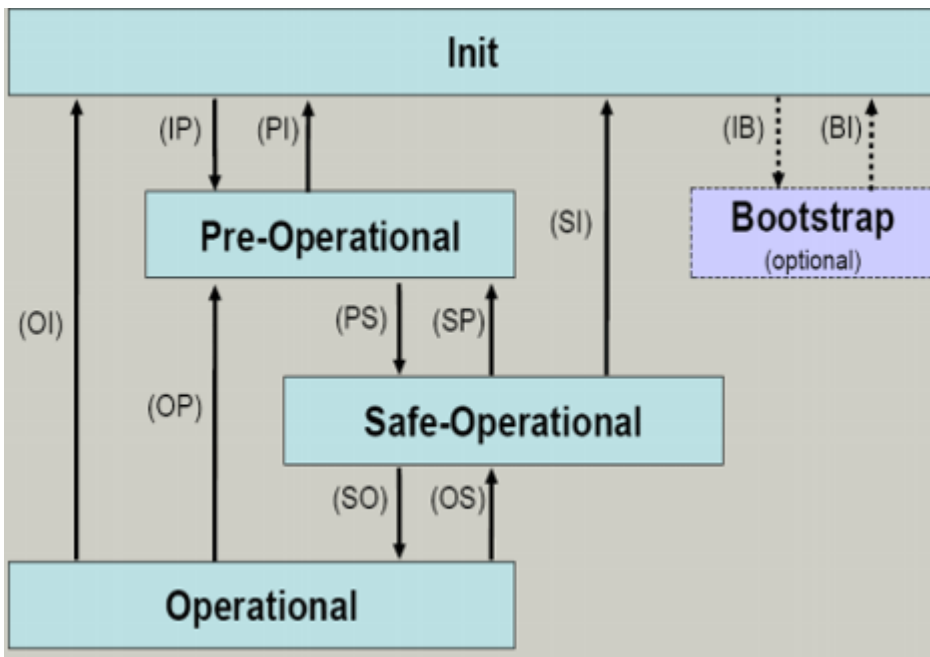

Fig. 8: States of the EtherCAT State Machine

Init

After switch-on the EtherCAT slave in the *Init* state. No mailbox or process data communication is possible. The EtherCAT master initializes sync manager channels 0 and 1 for mailbox communication.

Pre-Operational (Pre-Op)

During the transition between *Init* and *Pre-Op* the EtherCAT slave checks whether the mailbox was initialized correctly.

In *Pre-Op* state mailbox communication is possible, but not process data communication. The EtherCAT master initializes the sync manager channels for process data (from sync manager channel 2), the FMMU channels and, if the slave supports configurable mapping, PDO mapping or the sync manager PDO assignment. In this state the settings for the process data transfer and perhaps terminal-specific parameters that may differ from the default settings are also transferred.

Safe-Operational (Safe-Op)

During transition between *Pre-Op* and *Safe-Op* the EtherCAT slave checks whether the sync manager channels for process data communication and, if required, the distributed clocks settings are correct. Before it acknowledges the change of state, the EtherCAT slave copies current input data into the associated DP-RAM areas of the EtherCAT slave controller (ECSC).

In *Safe-Op* state mailbox and process data communication is possible, although the slave keeps its outputs in a safe state, while the input data are updated cyclically.

● Outputs in SAFEOP state

i The default set watchdog monitoring sets the outputs of the module in a safe state - depending on the settings in SAFEOP and OP - e.g. in OFF state. If this is prevented by deactivation of the watchdog monitoring in the module, the outputs can be switched or set also in the SAFEOP state.

Operational (Op)

Before the EtherCAT master switches the EtherCAT slave from *Safe-Op* to *Op* it must transfer valid output data.

In the *Op* state the slave copies the output data of the masters to its outputs. Process data and mailbox communication is possible.

Boot

In the *Boot* state the slave firmware can be updated. The *Boot* state can only be reached via the *Init* state.

In the *Boot* state mailbox communication via the *file access over EtherCAT* (FoE) protocol is possible, but no other mailbox communication and no process data communication.

4.5 CoE Interface

General description

The CoE interface (CAN application protocol over EtherCAT) is used for parameter management of EtherCAT devices. EtherCAT slaves or the EtherCAT master manage fixed (read only) or variable parameters which they require for operation, diagnostics or commissioning.

CoE parameters are arranged in a table hierarchy. In principle, the user has read access via the fieldbus. The EtherCAT master (TwinCAT System Manager) can access the local CoE lists of the slaves via EtherCAT in read or write mode, depending on the attributes.

Different CoE parameter types are possible, including string (text), integer numbers, Boolean values or larger byte fields. They can be used to describe a wide range of features. Examples of such parameters include manufacturer ID, serial number, process data settings, device name, calibration values for analog measurement or passwords.

The order is specified in two levels via hexadecimal numbering: (main)index, followed by subindex. The value ranges are

- Index: 0x0000 ...0xFFFF (0...65535_{dec})
- SubIndex: 0x00...0xFF (0...255_{dec})

A parameter localized in this way is normally written as 0x8010:07, with preceding "0x" to identify the hexadecimal numerical range and a colon between index and subindex.

The relevant ranges for EtherCAT fieldbus users are:

- 0x1000: This is where fixed identity information for the device is stored, including name, manufacturer, serial number etc., plus information about the current and available process data configurations.
- 0x8000: This is where the operational and functional parameters for all channels are stored, such as filter settings or output frequency.

Other important ranges are:

- 0x4000: here are the channel parameters for some EtherCAT devices. Historically, this was the first parameter area before the 0x8000 area was introduced. EtherCAT devices that were previously equipped with parameters in 0x4000 and changed to 0x8000 support both ranges for compatibility reasons and mirror internally.
- 0x6000: Input PDOs ("input" from the perspective of the EtherCAT master)
- 0x7000: Output PDOs ("output" from the perspective of the EtherCAT master)

i Availability

Not every EtherCAT device must have a CoE list. Simple I/O modules without dedicated processor usually have no variable parameters and therefore no CoE list.

If a device has a CoE list, it is shown in the TwinCAT System Manager as a separate tab with a listing of the elements:

Index	Name	Flags	Value
1000	Device type	RO	0x00FA1389 (16389001)
1008	Device name	RO	EL2502-0000
1009	Hardware version	RO	
100A	Software version	RO	
1011:0	Restore default parameters	RO	> 1 <
1018:0	Identity	RO	> 4 <
1018:01	Vendor ID	RO	0x00000002 (2)
1018:02	Product code	RO	0x09C63052 (163983442)
1018:03	Revision	RO	0x00130000 (1245184)
1018:04	Serial number	RO	0x00000000 (0)
10F0:0	Backup parameter handling	RO	> 1 <
1400:0	PWM RxDPO-Par Ch.1	RO	> 6 <
1401:0	PWM RxDPO-Par Ch.2	RO	> 6 <
1402:0	PWM RxDPO-Par h.1 Ch.1	RO	> 6 <
1403:0	PWM RxDPO-Par h.1 Ch.2	RO	> 6 <
1600:0	PWM RxDPO-Map Ch.1	RO	> 1 <

Fig. 9: "CoE Online" tab

The figure above shows the CoE objects available in device "EL2502", ranging from 0x1000 to 0x1600. The subindices for 0x1018 are expanded.

NOTICE

Changes in the CoE directory (CAN over EtherCAT), program access

When using/manipulating the CoE parameters observe the general CoE notes in chapter "[CoE interface](#)" of the EtherCAT system documentation:

- Keep a startup list if components have to be replaced,
- Distinction between online/offline dictionary,
- Existence of current XML description (download from the [Beckhoff website](#)),
- "CoE-Reload" for resetting the changes
- Program access during operation via PLC (see [TwinCAT3 | PLC Library: Tc2_EtherCAT](#) and [Example program R/W CoE](#))

Data management and function "NoCoeStorage"

Some parameters, particularly the setting parameters of the slave, are configurable and writeable. This can be done in write or read mode

- via the System Manager (Fig. "CoE Online" tab) by clicking
This is useful for commissioning of the system/slaves. Click on the row of the index to be parameterized and enter a value in the "SetValue" dialog.
- from the control system/PLC via ADS, e.g. through blocks from the TcEtherCAT.lib library
This is recommended for modifications while the system is running or if no System Manager or operating staff are available.

Data management

If slave CoE parameters are modified online, Beckhoff devices store any changes in a fail-safe manner in the EEPROM, i.e. the modified CoE parameters are still available after a restart. The situation may be different with other manufacturers.

An EEPROM is subject to a limited lifetime with respect to write operations. From typically 100,000 write operations onwards it can no longer be guaranteed that new (changed) data are reliably saved or are still readable. This is irrelevant for normal commissioning. However, if CoE parameters are continuously changed via ADS at machine runtime, it is quite possible for the lifetime limit to be reached. Support for the NoCoeStorage function, which suppresses the saving of changed CoE values, depends on the firmware version.

Please refer to the technical data in this documentation as to whether this applies to the respective device.

- If the function is supported: the function is activated by entering the code word 0x12345678 once in CoE 0xF008 and remains active as long as the code word is not changed. After switching the device on it is then inactive. Changed CoE values are not saved in the EEPROM and can thus be changed any number of times.
- Function is not supported: continuous changing of CoE values is not permissible in view of the lifetime limit.

Startup list

Changes in the local CoE list of the terminal are lost if the terminal is replaced. If a terminal is replaced with a new Beckhoff terminal, it will have the default settings. It is therefore advisable to link all changes in the CoE list of an EtherCAT slave with the Startup list of the slave, which is processed whenever the EtherCAT fieldbus is started. In this way a replacement EtherCAT slave can automatically be parameterized with the specifications of the user.

If EtherCAT slaves are used which are unable to store local CoE values permanently, the Startup list must be used.

Recommended approach for manual modification of CoE parameters

- Make the required change in the System Manager
The values are stored locally in the EtherCAT slave
- If the value is to be stored permanently, enter it in the Startup list.
The order of the Startup entries is usually irrelevant.

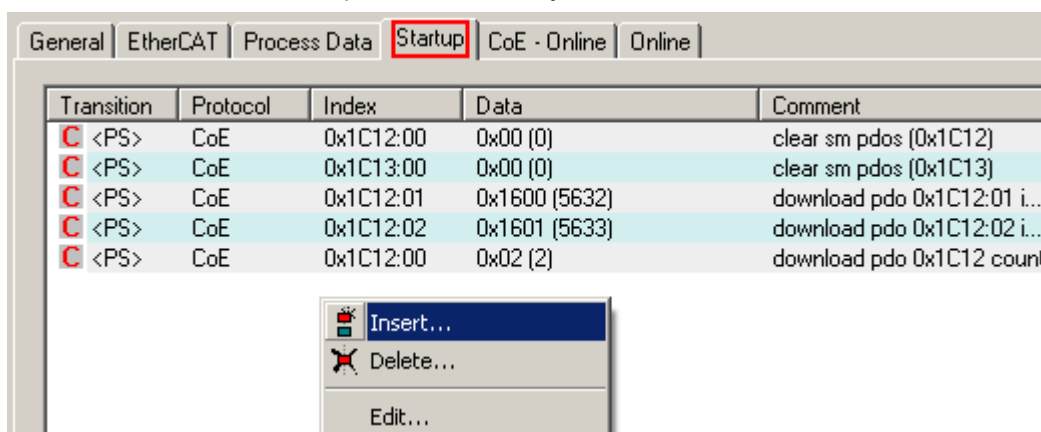

Fig. 10: Startup list in the TwinCAT System Manager

The Startup list may already contain values that were configured by the System Manager based on the ESI specifications. Additional application-specific entries can be created.

Online/offline list

While working with the TwinCAT System Manager, a distinction has to be made whether the EtherCAT device is “available”, i.e. switched on and linked via EtherCAT and therefore **online**, or whether a configuration is created **offline** without connected slaves.

In both cases a CoE list as shown in Fig. “CoE online tab” is displayed. The connectivity is shown as offline/online.

- If the slave is offline
 - The offline list from the ESI file is displayed. In this case modifications are not meaningful or possible.
 - The configured status is shown under Identity.
 - No firmware or hardware version is displayed, since these are features of the physical device.
 - **Offline** is shown in red.

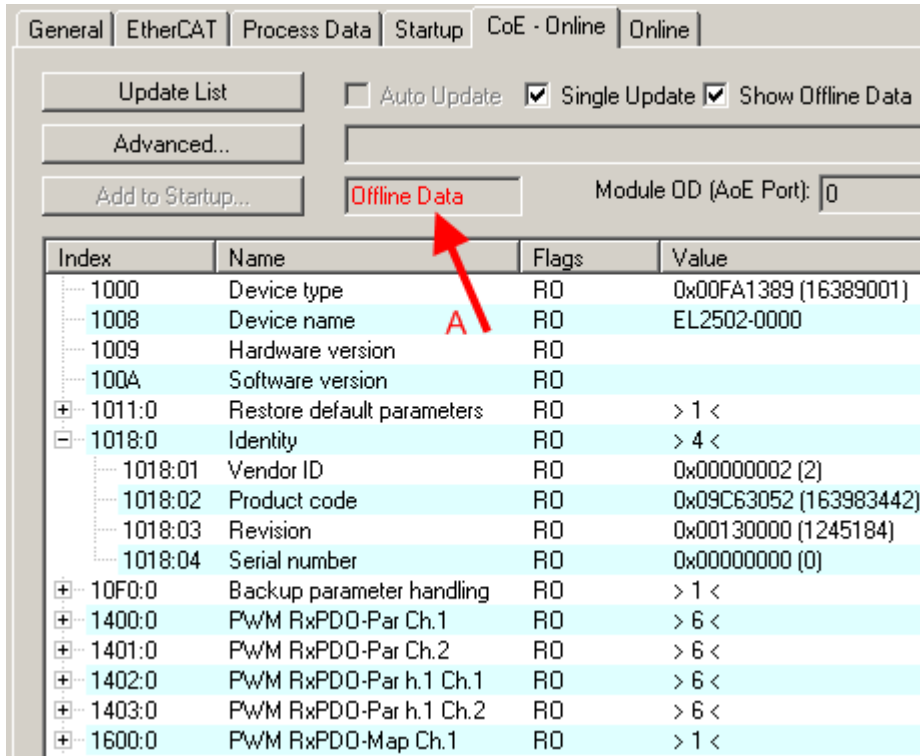

Index	Name	Flags	Value
1000	Device type	RO	0x00FA1389 (16389001)
1008	Device name	RO	EL2502-0000
1009	Hardware version	RO	
100A	Software version	RO	
1011:0	Restore default parameters	RO	> 1 <
1018:0	Identity	RO	> 4 <
1018:01	Vendor ID	RO	0x00000002 (2)
1018:02	Product code	RO	0x09C63052 (163983442)
1018:03	Revision	RO	0x00130000 (1245184)
1018:04	Serial number	RO	0x00000000 (0)
10F0:0	Backup parameter handling	RO	> 1 <
1400:0	PwM RxPDO-Par Ch.1	RO	> 6 <
1401:0	PwM RxPDO-Par Ch.2	RO	> 6 <
1402:0	PwM RxPDO-Par h.1 Ch.1	RO	> 6 <
1403:0	PwM RxPDO-Par h.1 Ch.2	RO	> 6 <
1600:0	PwM RxPDO-Map Ch.1	RO	> 1 <

Fig. 11: Offline list

- If the slave is online
 - The actual current slave list is read. This may take several seconds, depending on the size and cycle time.
 - The actual identity is displayed
 - The firmware and hardware version of the equipment according to the electronic information is displayed
 - **Online** is shown in green.

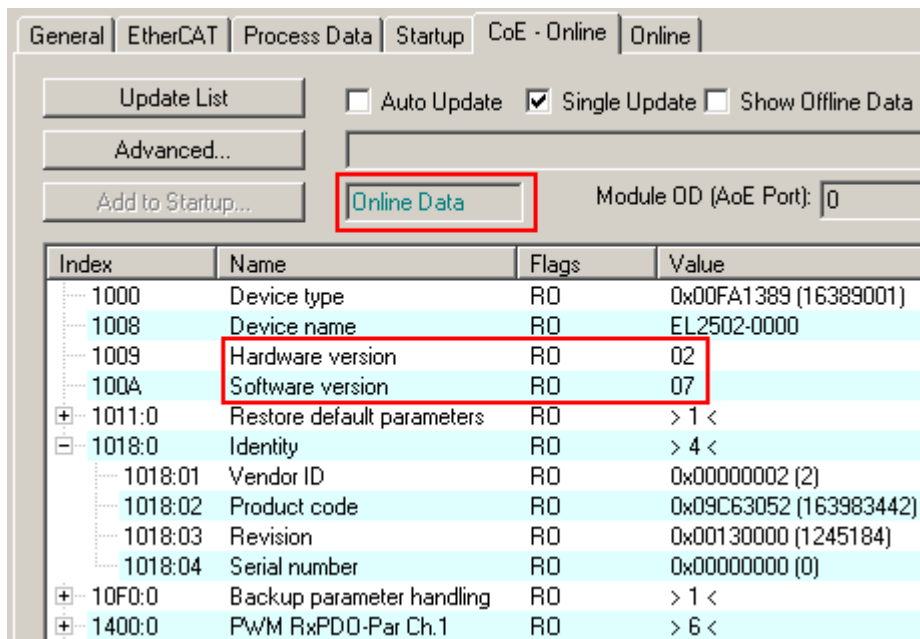

Fig. 12: Online list

Channel-based order

The CoE list is available in EtherCAT devices that usually feature several functionally equivalent channels. For example, a 4-channel analog 0...10 V input terminal also has four logical channels and therefore four identical sets of parameter data for the channels. In order to avoid having to list each channel in the documentation, the placeholder “n” tends to be used for the individual channel numbers.

In the CoE system 16 indices, each with 255 subindices, are generally sufficient for representing all channel parameters. The channel-based order is therefore arranged in $16_{dec}/10_{hex}$ steps. The parameter range 0x8000 exemplifies this:

- Channel 0: parameter range 0x8000:00 ... 0x800F:255
- Channel 1: parameter range 0x8010:00 ... 0x801F:255
- Channel 2: parameter range 0x8020:00 ... 0x802F:255
- ...

This is generally written as 0x80n0.

Detailed information on the CoE interface can be found in the [EtherCAT system documentation](#) on the Beckhoff website.

4.6 Distributed Clock

The distributed clock represents a local clock in the EtherCAT slave controller (ESC) with the following characteristics:

- Unit *1 ns*
- Zero point *1.1.2000 00:00*
- Size *64 bit* (sufficient for the next 584 years; however, some EtherCAT slaves only offer 32-bit support, i.e. the variable overflows after approx. 4.2 seconds)
- The EtherCAT master automatically synchronizes the local clock with the master clock in the EtherCAT bus with a precision of < 100 ns.

For detailed information please refer to the [EtherCAT system description](#).

5 Mounting and wiring

5.1 Instructions for ESD protection

NOTICE

Destruction of the devices by electrostatic discharge possible!

The devices contain components at risk from electrostatic discharge caused by improper handling.

- Please ensure you are electrostatically discharged and avoid touching the contacts of the device directly.
- Avoid contact with highly insulating materials (synthetic fibers, plastic film etc.).
- Surroundings (working place, packaging and personnel) should be grounded probably, when handling with the devices.
- Each assembly must be terminated at the right hand end with an [EL9011](#) or [EL9012](#) bus end cap, to ensure the protection class and ESD protection.

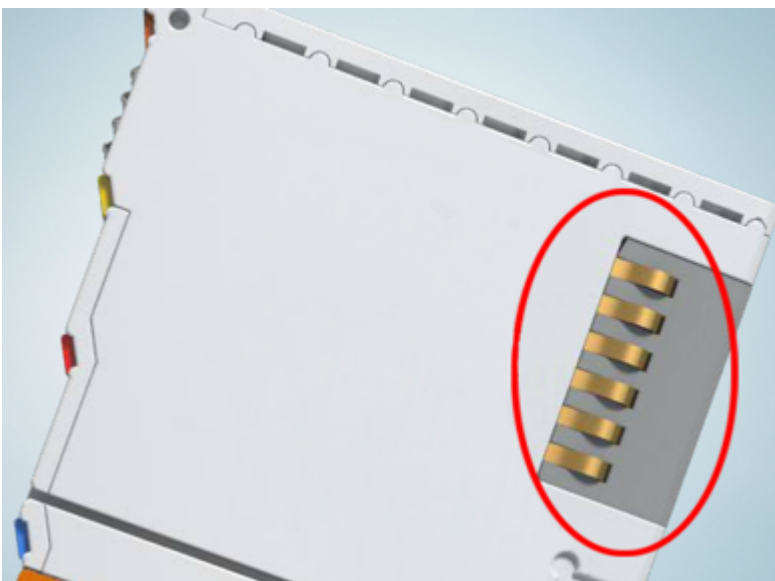

Fig. 13: Spring contacts of the Beckhoff I/O components

5.2 Explosion protection

5.2.1 ATEX - Special conditions (standard temperature range)

⚠ WARNING

Observe the special conditions for the intended use of Beckhoff fieldbus components with standard temperature range in potentially explosive areas (directive 2014/34/EU)!

- The certified components are to be installed in a suitable housing that guarantees a protection class of at least IP54 in accordance with EN 60079-15! The environmental conditions during use are thereby to be taken into account!
- For dust (only the fieldbus components of certificate no. KEMA 10ATEX0075 X Issue 9): The equipment shall be installed in a suitable enclosure providing a degree of protection of IP54 according to EN 60079-31 for group IIIA or IIIB and IP6X for group IIIC, taking into account the environmental conditions under which the equipment is used!
- If the temperatures during rated operation are higher than 70°C at the feed-in points of cables, lines or pipes, or higher than 80°C at the wire branching points, then cables must be selected whose temperature data correspond to the actual measured temperature values!
- Observe the permissible ambient temperature range of 0 to 55°C for the use of Beckhoff fieldbus components standard temperature range in potentially explosive areas!
- Measures must be taken to protect against the rated operating voltage being exceeded by more than 40% due to short-term interference voltages!
- The individual terminals may only be unplugged or removed from the Bus Terminal system if the supply voltage has been switched off or if a non-explosive atmosphere is ensured!
- The connections of the certified components may only be connected or disconnected if the supply voltage has been switched off or if a non-explosive atmosphere is ensured!
- The fuses of the KL92xx/EL92xx power feed terminals may only be exchanged if the supply voltage has been switched off or if a non-explosive atmosphere is ensured!
- Address selectors and ID switches may only be adjusted if the supply voltage has been switched off or if a non-explosive atmosphere is ensured!

Standards

The fundamental health and safety requirements are fulfilled by compliance with the following standards:

- EN 60079-0:2012+A11:2013
- EN 60079-15:2010
- EN 60079-31:2013 (only for certificate no. KEMA 10ATEX0075 X Issue 9)

Marking

The Beckhoff fieldbus components with standard temperature range certified according to the ATEX directive for potentially explosive areas bear one of the following markings:



II 3G KEMA 10ATEX0075 X Ex nA IIC T4 Gc Ta: 0 ... +55°C

II 3D KEMA 10ATEX0075 X Ex tc IIIC T135°C Dc Ta: 0 ... +55°C
(only for fieldbus components of certificate no. KEMA 10ATEX0075 X Issue 9)

or



II 3G KEMA 10ATEX0075 X Ex nA nC IIC T4 Gc Ta: 0 ... +55°C

II 3D KEMA 10ATEX0075 X Ex tc IIIC T135°C Dc Ta: 0 ... +55°C
(only for fieldbus components of certificate no. KEMA 10ATEX0075 X Issue 9)

5.2.2 IECEx - Special conditions

⚠ WARNING

Observe the special conditions for the intended use of Beckhoff fieldbus components in potentially explosive areas!

- For gas: The equipment shall be installed in a suitable enclosure providing a degree of protection of IP54 according to IEC 60079-15, taking into account the environmental conditions under which the equipment is used!
- For dust (only the fieldbus components of certificate no. IECEx DEK 16.0078X Issue 3):
The equipment shall be installed in a suitable enclosure providing a degree of protection of IP54 according to EN 60079-31 for group IIIA or IIIB and IP6X for group IIIC, taking into account the environmental conditions under which the equipment is used!
- The equipment shall only be used in an area of at least pollution degree 2, as defined in IEC 60664-1!
- Provisions shall be made to prevent the rated voltage from being exceeded by transient disturbances of more than 119 V!
- If the temperatures during rated operation are higher than 70°C at the feed-in points of cables, lines or pipes, or higher than 80°C at the wire branching points, then cables must be selected whose temperature data correspond to the actual measured temperature values!
- Observe the permissible ambient temperature range for the use of Beckhoff fieldbus components in potentially explosive areas!
- The individual terminals may only be unplugged or removed from the Bus Terminal system if the supply voltage has been switched off or if a non-explosive atmosphere is ensured!
- The connections of the certified components may only be connected or disconnected if the supply voltage has been switched off or if a non-explosive atmosphere is ensured!
- Address selectors and ID switches may only be adjusted if the supply voltage has been switched off or if a non-explosive atmosphere is ensured!
- The front hatch of certified units may only be opened if the supply voltage has been switched off or a non-explosive atmosphere is ensured!

Standards

The fundamental health and safety requirements are fulfilled by compliance with the following standards:

- EN 60079-0:2011
- EN 60079-15:2010
- EN 60079-31:2013 (only for certificate no. IECEx DEK 16.0078X Issue 3)

Marking

Beckhoff fieldbus components that are certified in accordance with IECEx for use in areas subject to an explosion hazard bear the following markings:

Marking for fieldbus components of certificate no. IECEx DEK 16.0078X Issue 3:	IECEx DEK 16.0078 X Ex nA IIC T4 Gc Ex tc IIIC T135°C Dc
--	---

Marking for fieldbus components of certificates with later issues:	IECEx DEK 16.0078 X Ex nA IIC T4 Gc
--	--

5.2.3 Continulative documentation for ATEX and IECEx

NOTICE



Continulative documentation about explosion protection according to ATEX and IECEx



Pay also attention to the continuative documentation

Ex. Protection for Terminal Systems

Notes on the use of the Beckhoff terminal systems in hazardous areas according to ATEX and IECEx,

that is available for [download](#) within the download area of your product on the Beckhoff homepage www.beckhoff.com!

5.3 UL notice

⚠ CAUTION	
	<p>Application Beckhoff EtherCAT modules are intended for use with Beckhoff's UL Listed EtherCAT System only.</p>
⚠ CAUTION	
	<p>Examination For cULus examination, the Beckhoff I/O System has only been investigated for risk of fire and electrical shock (in accordance with UL508 and CSA C22.2 No. 142).</p>
⚠ CAUTION	
	<p>For devices with Ethernet connectors Not for connection to telecommunication circuits.</p>

Basic principles

UL certification according to UL508. Devices with this kind of certification are marked by this sign:



5.4 Installation on mounting rails

⚠ WARNING

Risk of electric shock and damage of device!

Bring the bus terminal system into a safe, powered down state before starting installation, disassembly or wiring of the bus terminals!

The Bus Terminal system and is designed for mounting in a control cabinet or terminal box.

Assembly

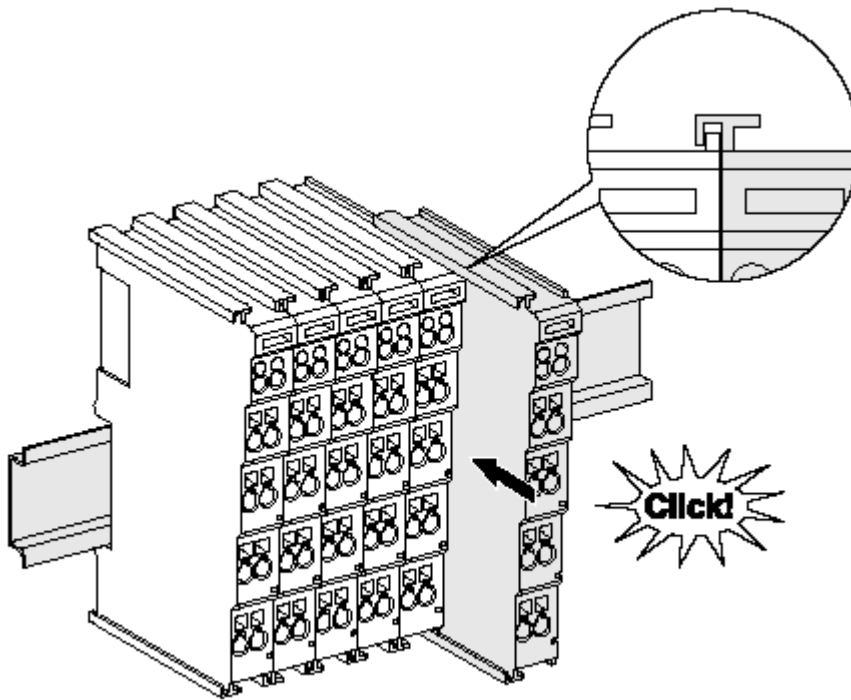

Fig. 14: Attaching on mounting rail

The bus coupler and bus terminals are attached to commercially available 35 mm mounting rails (DIN rails according to EN 60715) by applying slight pressure:

1. First attach the fieldbus coupler to the mounting rail.
2. The bus terminals are now attached on the right-hand side of the fieldbus coupler. Join the components with tongue and groove and push the terminals against the mounting rail, until the lock clicks onto the mounting rail.

If the terminals are clipped onto the mounting rail first and then pushed together without tongue and groove, the connection will not be operational! When correctly assembled, no significant gap should be visible between the housings.

i Fixing of mounting rails

The locking mechanism of the terminals and couplers extends to the profile of the mounting rail. At the installation, the locking mechanism of the components must not come into conflict with the fixing bolts of the mounting rail. To mount the mounting rails with a height of 7.5 mm under the terminals and couplers, you should use flat mounting connections (e.g. countersunk screws or blind rivets).

Disassembly

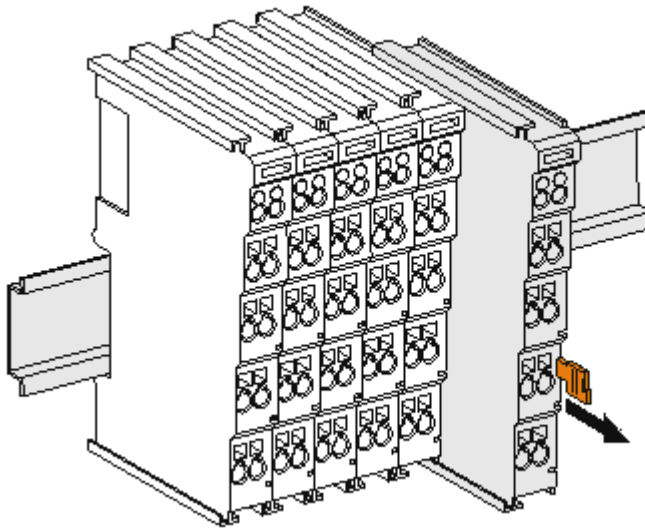

Fig. 15: Disassembling of terminal

Each terminal is secured by a lock on the mounting rail, which must be released for disassembly:

1. Pull the terminal by its orange-colored lugs approximately 1 cm away from the mounting rail. In doing so for this terminal the mounting rail lock is released automatically and you can pull the terminal out of the bus terminal block easily without excessive force.
2. Grasp the released terminal with thumb and index finger simultaneous at the upper and lower grooved housing surfaces and pull the terminal out of the bus terminal block.

Connections within a bus terminal block

The electric connections between the Bus Coupler and the Bus Terminals are automatically realized by joining the components:

- The six spring contacts of the K-Bus/E-Bus deal with the transfer of the data and the supply of the Bus Terminal electronics.
- The power contacts deal with the supply for the field electronics and thus represent a supply rail within the bus terminal block. The power contacts are supplied via terminals on the Bus Coupler (up to 24 V) or for higher voltages via power feed terminals.

● Power Contacts

i During the design of a bus terminal block, the pin assignment of the individual Bus Terminals must be taken account of, since some types (e.g. analog Bus Terminals or digital 4-channel Bus Terminals) do not or not fully loop through the power contacts. Power Feed Terminals (KL91xx, KL92xx or EL91xx, EL92xx) interrupt the power contacts and thus represent the start of a new supply rail.

PE power contact

The power contact labeled PE can be used as a protective earth. For safety reasons this contact mates first when plugging together, and can ground short-circuit currents of up to 125 A.

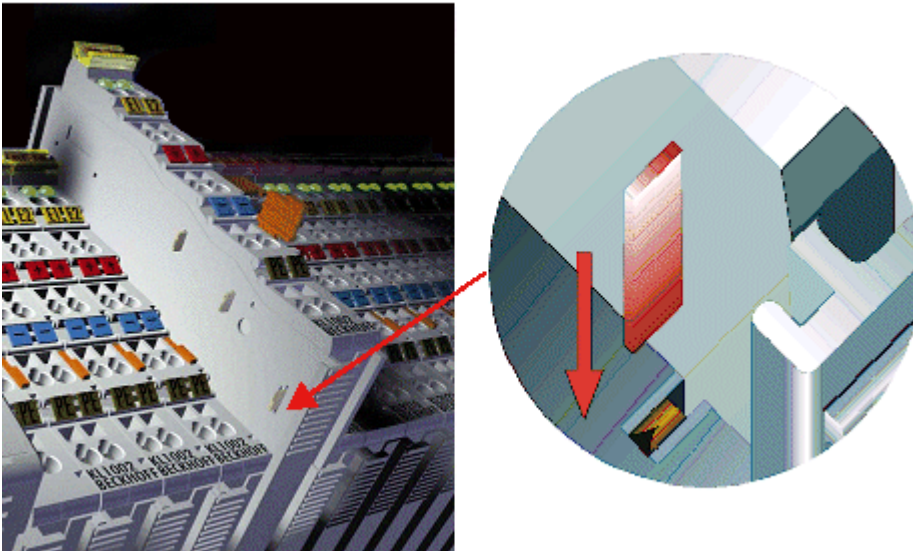

Fig. 16: Power contact on left side

NOTICE**Possible damage of the device**

Note that, for reasons of electromagnetic compatibility, the PE contacts are capacitatively coupled to the mounting rail. This may lead to incorrect results during insulation testing or to damage on the terminal (e.g. disruptive discharge to the PE line during insulation testing of a consumer with a nominal voltage of 230 V). For insulation testing, disconnect the PE supply line at the Bus Coupler or the Power Feed Terminal! In order to decouple further feed points for testing, these Power Feed Terminals can be released and pulled at least 10 mm from the group of terminals.

⚠ WARNING**Risk of electric shock!**

The PE power contact must not be used for other potentials!

5.5 Installation instructions for enhanced mechanical load capacity

⚠ WARNING

Risk of injury through electric shock and damage to the device!

Bring the Bus Terminal system into a safe, de-energized state before starting mounting, disassembly or wiring of the Bus Terminals!

Additional checks

The terminals have undergone the following additional tests:

Verification	Explanation
Vibration	10 frequency runs in 3 axes
	6 Hz < f < 60 Hz displacement 0.35 mm, constant amplitude
	60.1 Hz < f < 500 Hz acceleration 5 g, constant amplitude
Shocks	1000 shocks in each direction, in 3 axes
	25 g, 6 ms

Additional installation instructions

For terminals with enhanced mechanical load capacity, the following additional installation instructions apply:

- The enhanced mechanical load capacity is valid for all permissible installation positions
- Use a mounting rail according to EN 60715 TH35-15
- Fix the terminal segment on both sides of the mounting rail with a mechanical fixture, e.g. an earth terminal or reinforced end clamp
- The maximum total extension of the terminal segment (without coupler) is:
64 terminals (12 mm mounting with) or 32 terminals (24 mm mounting with)
- Avoid deformation, twisting, crushing and bending of the mounting rail during edging and installation of the rail
- The mounting points of the mounting rail must be set at 5 cm intervals
- Use countersunk head screws to fasten the mounting rail
- The free length between the strain relief and the wire connection should be kept as short as possible. A distance of approx. 10 cm should be maintained to the cable duct.

5.6 Connection

5.6.1 Connection system

⚠ WARNING

Risk of electric shock and damage of device!

Bring the bus terminal system into a safe, powered down state before starting installation, disassembly or wiring of the bus terminals!

Overview

The bus terminal system offers different connection options for optimum adaptation to the respective application:

- The terminals of ELxxxx and KLxxxx series with standard wiring include electronics and connection level in a single enclosure.
- The terminals of ESxxxx and KSxxxx series feature a pluggable connection level and enable steady wiring while replacing.
- The High Density Terminals (HD Terminals) include electronics and connection level in a single enclosure and have advanced packaging density.

Standard wiring (ELxxxx / KLxxxx)



Fig. 17: Standard wiring

The terminals of ELxxxx and KLxxxx series have been tried and tested for years. They feature integrated screwless spring force technology for fast and simple assembly.

Pluggable wiring (ESxxxx / KSxxxx)



Fig. 18: Pluggable wiring

The terminals of ESxxxx and KSxxxx series feature a pluggable connection level. The assembly and wiring procedure is the same as for the ELxxxx and KLxxxx series. The pluggable connection level enables the complete wiring to be removed as a plug connector from the top of the housing for servicing. The lower section can be removed from the terminal block by pulling the unlocking tab. Insert the new component and plug in the connector with the wiring. This reduces the installation time and eliminates the risk of wires being mixed up.

The familiar dimensions of the terminal only had to be changed slightly. The new connector adds about 3 mm. The maximum height of the terminal remains unchanged.

A tab for strain relief of the cable simplifies assembly in many applications and prevents tangling of individual connection wires when the connector is removed.

Conductor cross sections between 0.08 mm² and 2.5 mm² can continue to be used with the proven spring force technology.

The overview and nomenclature of the product names for ESxxxx and KSxxxx series has been retained as known from ELxxxx and KLxxxx series.

High Density Terminals (HD Terminals)



Fig. 19: High Density Terminals

The terminals from these series with 16 terminal points are distinguished by a particularly compact design, as the packaging density is twice as large as that of the standard 12 mm bus terminals. Massive conductors and conductors with a wire end sleeve can be inserted directly into the spring loaded terminal point without tools.

● **Wiring HD Terminals**

i The High Density Terminals of the ELx8xx and KLx8xx series doesn't support pluggable wiring.

Ultrasonically “bonded” (ultrasonically welded) conductors

● **Ultrasonically “bonded” conductors**

i It is also possible to connect the Standard and High Density Terminals with ultrasonically “bonded” (ultrasonically welded) conductors. In this case, please note the tables concerning the wire-size width [[▶ 46](#)]!

5.6.2 Wiring

⚠ WARNING

Risk of electric shock and damage of device!

Bring the bus terminal system into a safe, powered down state before starting installation, disassembly or wiring of the bus terminals!

Terminals for standard wiring ELxxxx/KLxxxx and for pluggable wiring ESxxxx/KSxxxx

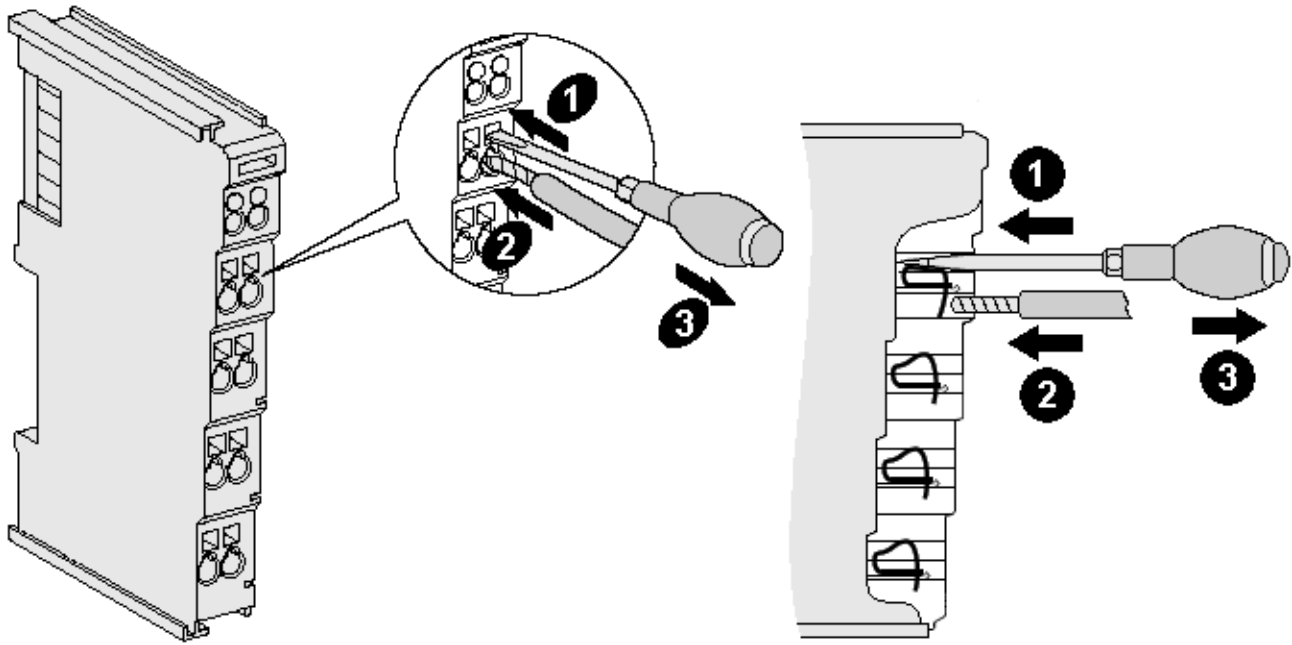

Fig. 20: Connecting a cable on a terminal point

Up to eight terminal points enable the connection of solid or finely stranded cables to the bus terminal. The terminal points are implemented in spring force technology. Connect the cables as follows:

1. Open a terminal point by pushing a screwdriver straight against the stop into the square opening above the terminal point. Do not turn the screwdriver or move it alternately (don't toggle).
2. The wire can now be inserted into the round terminal opening without any force.
3. The terminal point closes automatically when the pressure is released, holding the wire securely and permanently.

See the following table for the suitable wire size width.

Terminal housing	ELxxxx, KLxxxx	ESxxxx, KSxxxx
Wire size width (single core wires)	0.08 ... 2.5 mm ²	0.08 ... 2.5 mm ²
Wire size width (fine-wire conductors)	0.08 ... 2.5 mm ²	0.08 ... 2.5 mm ²
Wire size width (conductors with a wire end sleeve)	0.14 ... 1.5 mm ²	0.14 ... 1.5 mm ²
Wire stripping length	8 ... 9 mm	9 ... 10 mm

High Density Terminals ([HD Terminals](#) [▶ 45]) with 16 terminal points

The conductors of the HD Terminals are connected without tools for single-wire conductors using the direct plug-in technique, i.e. after stripping the wire is simply plugged into the terminal point. The cables are released, as usual, using the contact release with the aid of a screwdriver. See the following table for the suitable wire size width.

Terminal housing	High Density Housing
Wire size width (single core wires)	0.08 ... 1.5 mm ²
Wire size width (fine-wire conductors)	0.25 ... 1.5 mm ²
Wire size width (conductors with a wire end sleeve)	0.14 ... 0.75 mm ²
Wire size width (ultrasonically "bonded" conductors)	only 1.5 mm ² (see notice [▶ 45])
Wire stripping length	8 ... 9 mm

5.6.3 Shielding

● Shielding



Encoder, analog sensors and actuators should always be connected with shielded, twisted paired wires.

5.7 Note - Power supply

⚠ WARNING

Power supply from SELV/PELV power supply unit!

SELV/PELV circuits (Safety Extra Low Voltage, Protective Extra Low Voltage) according to IEC 61010-2-201 must be used to supply this device.

Notes:

- SELV/PELV circuits may give rise to further requirements from standards such as IEC 60204-1 et al, for example with regard to cable spacing and insulation.
- A SELV (Safety Extra Low Voltage) supply provides safe electrical isolation and limitation of the voltage without a connection to the protective conductor, a PELV (Protective Extra Low Voltage) supply also requires a safe connection to the protective conductor.

5.8 Positioning of passive Terminals

i Hint for positioning of passive terminals in the bus terminal block

EtherCAT Terminals (ELxxxx / ESxxxx), which do not take an active part in data transfer within the bus terminal block are so called passive terminals. The passive terminals have no current consumption out of the E-Bus.

To ensure an optimal data transfer, you must not directly string together more than two passive terminals!

Examples for positioning of passive terminals (highlighted)

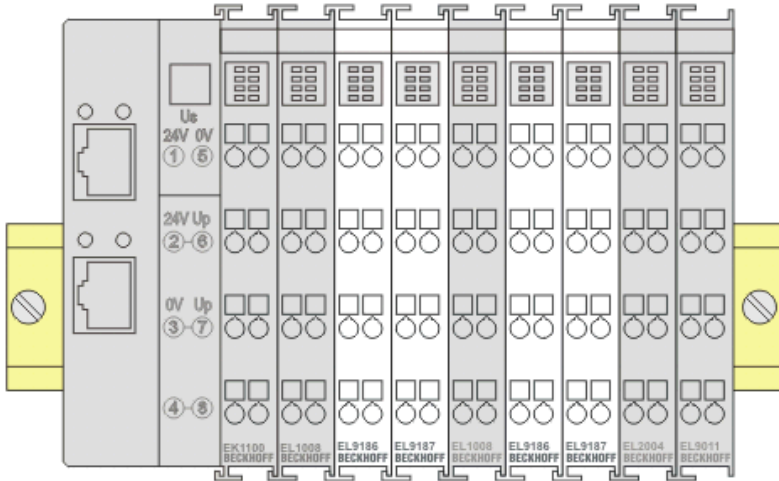

Fig. 21: Correct positioning

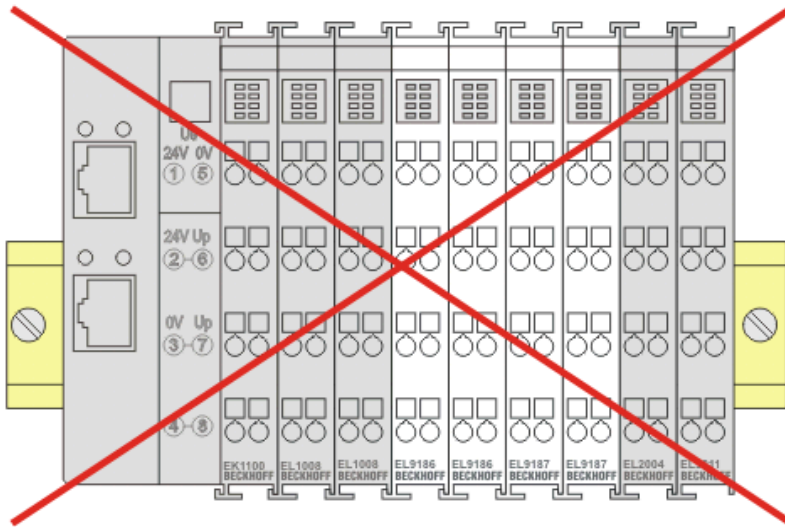

Fig. 22: Incorrect positioning

5.9 Installation positions

NOTICE

Constraints regarding installation position and operating temperature range

Please refer to the technical data for a terminal to ascertain whether any restrictions regarding the installation position and/or the operating temperature range have been specified. When installing high power dissipation terminals ensure that an adequate spacing is maintained between other components above and below the terminal in order to guarantee adequate ventilation!

Optimum installation position (standard)

The optimum installation position requires the mounting rail to be installed horizontally and the connection surfaces of the EL/KL terminals to face forward (see Fig. *Recommended distances for standard installation position*). The terminals are ventilated from below, which enables optimum cooling of the electronics through convection. "From below" is relative to the acceleration of gravity.

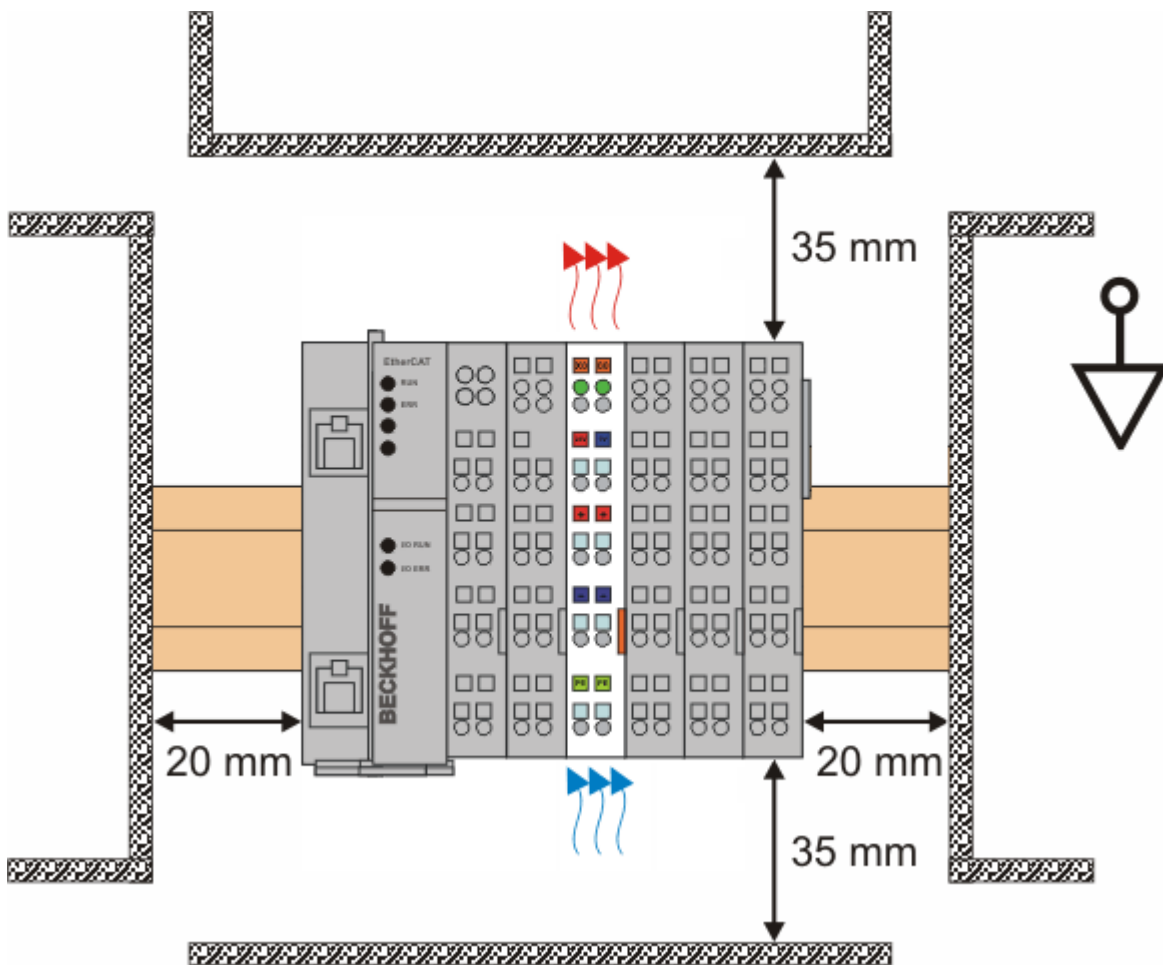

Fig. 23: Recommended distances for standard installation position

Compliance with the distances shown in Fig. *Recommended distances for standard installation position* is recommended.

Other installation positions

All other installation positions are characterized by different spatial arrangement of the mounting rail - see Fig *Other installation positions*.

The minimum distances to ambient specified above also apply to these installation positions.

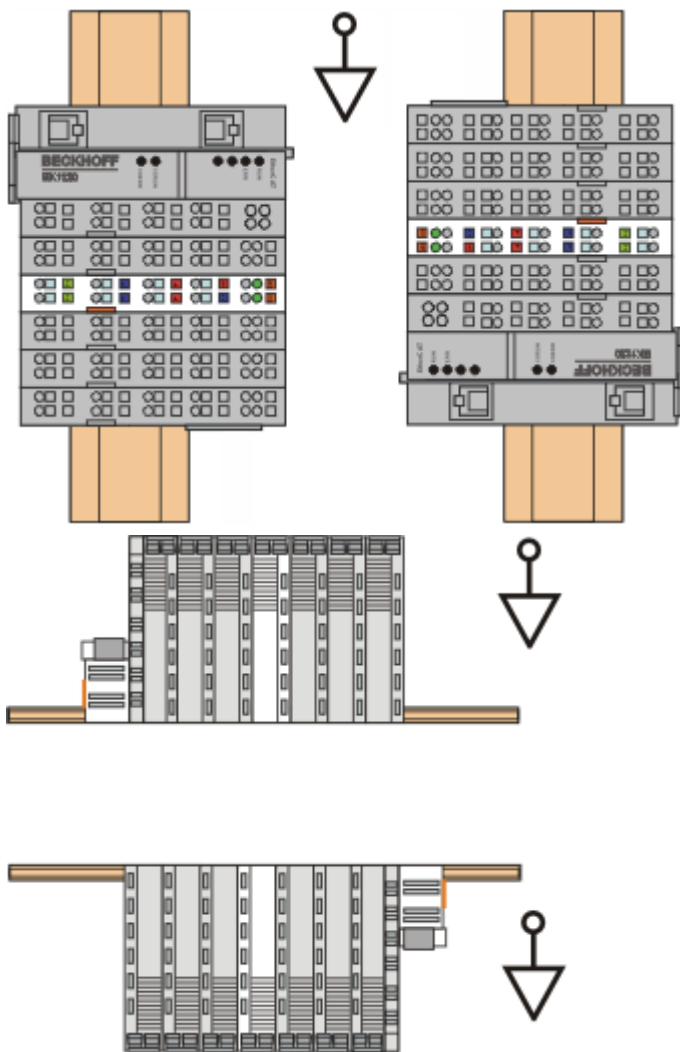

Fig. 24: Other installation positions

5.10 EL5021-00x0 - Connection

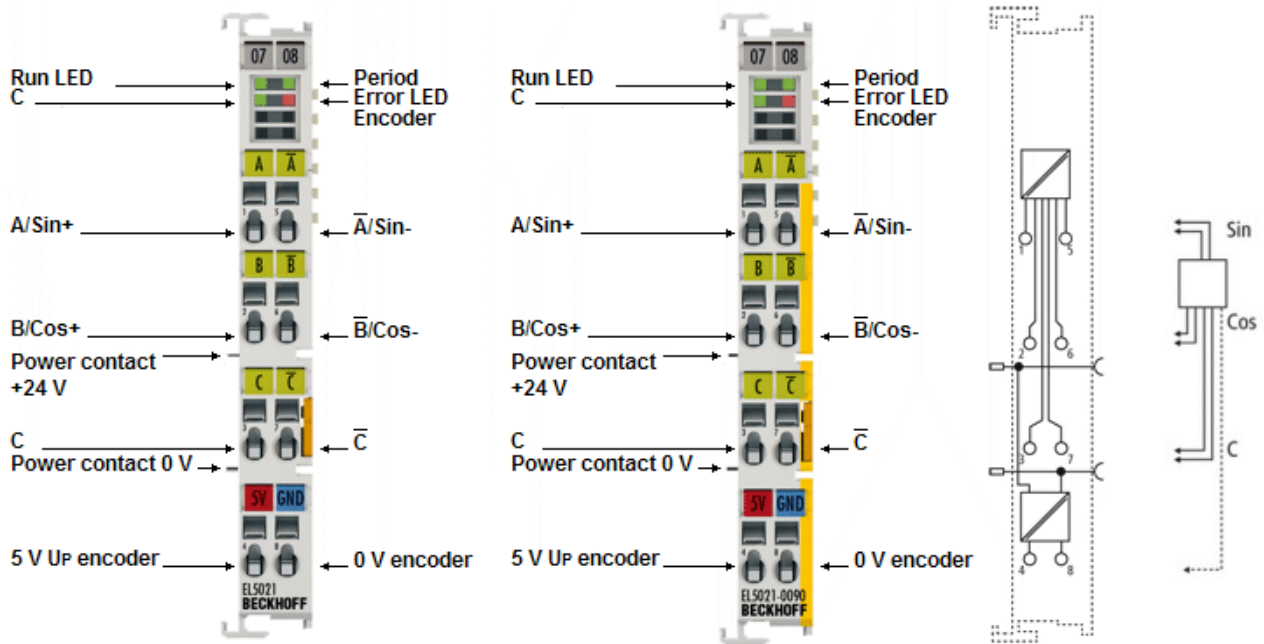

Fig. 25: EL5021, EL5021-0090

NOTICE

Encoder supply via the terminal

The encoder supply voltage can be taken from the terminal points 4 (5 V) and 8 (0 V).

Terminal point		Meaning
Name	No.	
A/Sin+	1	Input encoder, channel A
B/Cos+	2	Input encoder, channel B
C	3	Input encoder, channel C
5 V Up encoder	4	Output 5 V / 500 mA for encoder
A/Sin-	5	Input encoder, channel A
B/Cos-	6	Input encoder, channel B
C	7	Input encoder, channel C
0 V encoder	8	Output for encoder, GND

The differential inputs A/A, B/B and C/C are internally provided with a 120 Ohm termination resistor.

The differential signals are each expected with a 1 Vpp level with a 2.5 V averaged voltage relative to the encoder supply voltage.

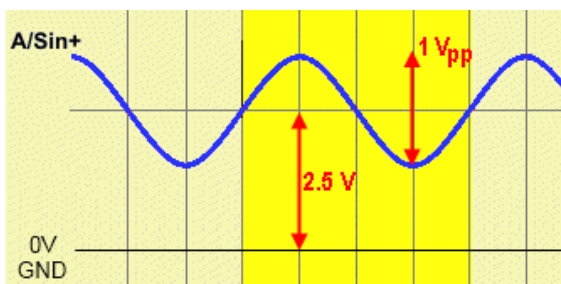

Fig. 26: typ. signal connection values

Shielding

If the sensor has a shielded cable, the shield must be connected to an external earthing point. The EL5021 has no shield connection point.

5.11 EL5021-00x0 - Diagnostic LEDs

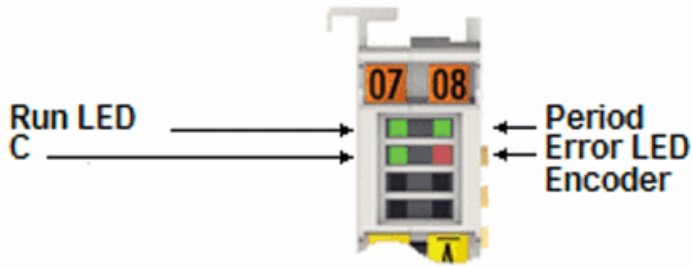

Fig. 27: EL502-00x0 Diagnostic LEDs

LED	Color	Meaning	
Period	green	Change of state of the Period LED on each period counted.	
C	green	Status of input C	
Error	red	Error display, equivalent to PDO error	
RUN	green	This LED indicates the terminal's operating state:	
		off	State of the <u>EtherCAT State Machine</u> : [▶ 110] INIT = initialization of the terminal
		flashing	State of the <u>EtherCAT State Machine</u> : PREOP = function for mailbox communication and different standard-settings set
		single flash	State of the <u>EtherCAT State Machine</u> : SAFEOP = verification of the <u>Sync Manager</u> [▶ 112] channels and the distributed clocks. Outputs remain in safe state
		on	State of the <u>EtherCAT State Machine</u> : OP = normal operating state; mailbox and process data communication is possible
flickering	State of the <u>EtherCAT State Machine</u> : BOOTSTRAP = function for firmware updates [▶ 163] of the terminal		

5.12 Disposal



Products marked with a crossed-out wheeled bin shall not be discarded with the normal waste stream. The device is considered as waste electrical and electronic equipment. The national regulations for the disposal of waste electrical and electronic equipment must be observed.

6 Commissioning

6.1 TwinCAT Quick Start

TwinCAT is a development environment for real-time control including a multi PLC system, NC axis control, programming and operation. The whole system is mapped through this environment and enables access to a programming environment (including compilation) for the controller. Individual digital or analog inputs or outputs can also be read or written directly, in order to verify their functionality, for example.

For further information, please refer to <http://infosys.beckhoff.com>:

- **EtherCAT System Manual:**
Fieldbus Components → EtherCAT Terminals → EtherCAT System Documentation → Setup in the TwinCAT System Manager
- **TwinCAT 2** → TwinCAT System Manager → I/O Configuration
- In particular, for TwinCAT – driver installation:
Fieldbus components → Fieldbus Cards and Switches → FC900x – PCI Cards for Ethernet → Installation

Devices contain the relevant terminals for the actual configuration. All configuration data can be entered directly via editor functions (offline) or via the `scan function (online):

- **“offline”**: The configuration can be customized by adding and positioning individual components. These can be selected from a directory and configured.
 - The procedure for the offline mode can be found under <http://infosys.beckhoff.com>:
TwinCAT 2 → TwinCAT System Manager → IO Configuration → Add an I/O device
- **“online”**: The existing hardware configuration is read
 - See also <http://infosys.beckhoff.com>:
Fieldbus components → Fieldbus Cards and Switches → FC900x – PCI Cards for Ethernet → Installation → Searching for devices

The following relationship is envisaged between the user PC and individual control elements:

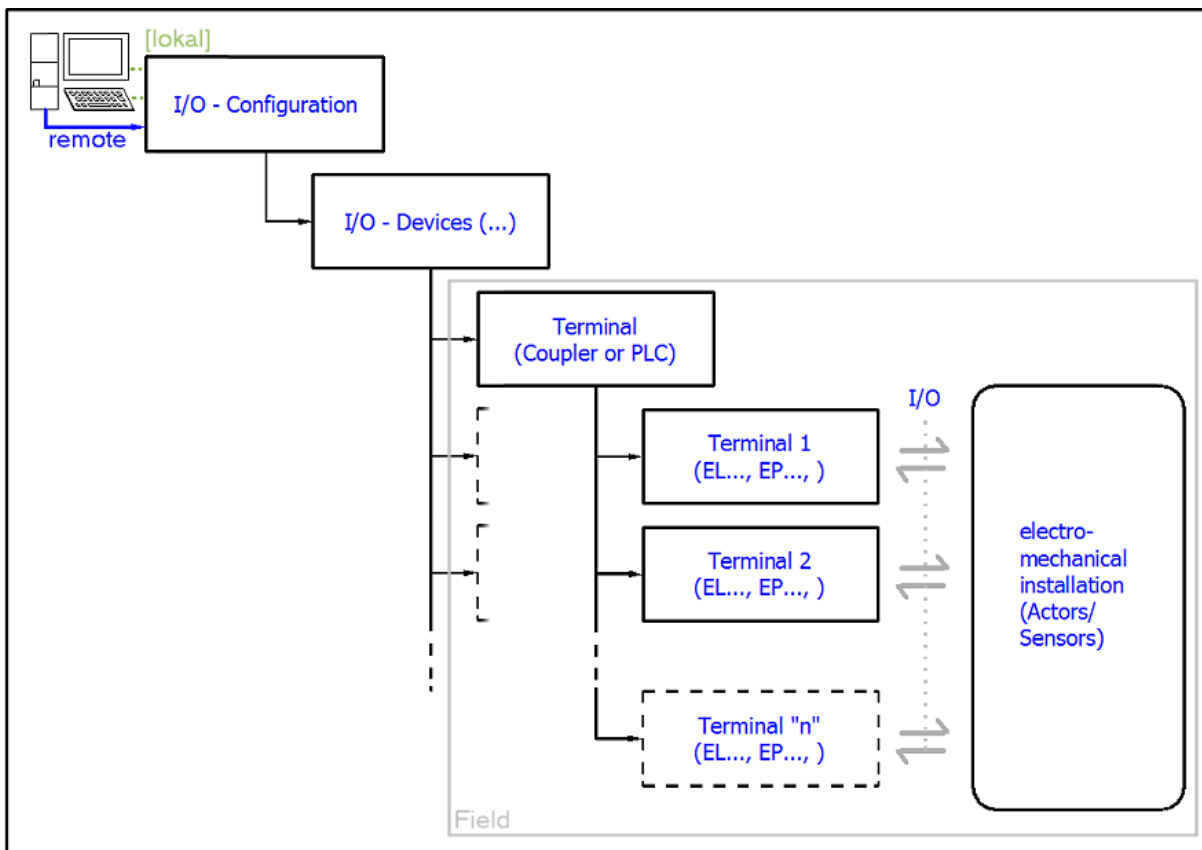

Fig. 28: Relationship between user side (commissioning) and installation

Insertion of certain components (I/O device, terminal, box...) by users functions the same way as in TwinCAT 2 and TwinCAT 3. The descriptions below relate solely to the online procedure.

Example configuration (actual configuration)

Based on the following example configuration, the subsequent subsections describe the procedure for TwinCAT 2 and TwinCAT 3:

- **CX2040** control system (PLC) including **CX2100-0004** power supply unit
- Connected to CX2040 on the right (E-bus):
EL1004 (4-channel digital input terminal 24 V_{DC})
- Linked via the X001 port (RJ-45): **EK1100** EtherCAT Coupler
- Connected to the EK1100 EtherCAT Coupler on the right (E-bus):
EL2008 (8-channel digital output terminal 24 V_{DC}; 0.5 A)
- (Optional via X000: a link to an external PC for the user interface)

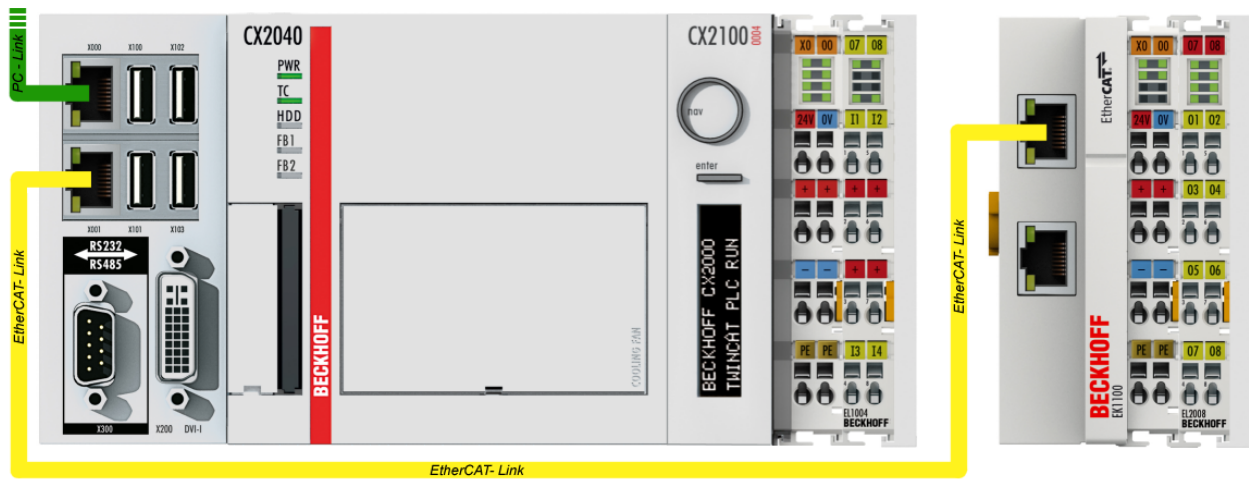

Fig. 29: Control configuration with Embedded PC, input (EL1004) and output (EL2008)

Note that all combinations of a configuration are possible; for example, the EL1004 terminal could also be connected after the coupler, or the EL2008 terminal could additionally be connected to the CX2040 on the right, in which case the EK1100 coupler wouldn't be necessary.

6.1.1 TwinCAT 2

Startup

TwinCAT 2 basically uses two user interfaces: the TwinCAT System Manager for communication with the electromechanical components and TwinCAT PLC Control for the development and compilation of a controller. The starting point is the TwinCAT System Manager.

After successful installation of the TwinCAT system on the PC to be used for development, the TwinCAT 2 System Manager displays the following user interface after startup:

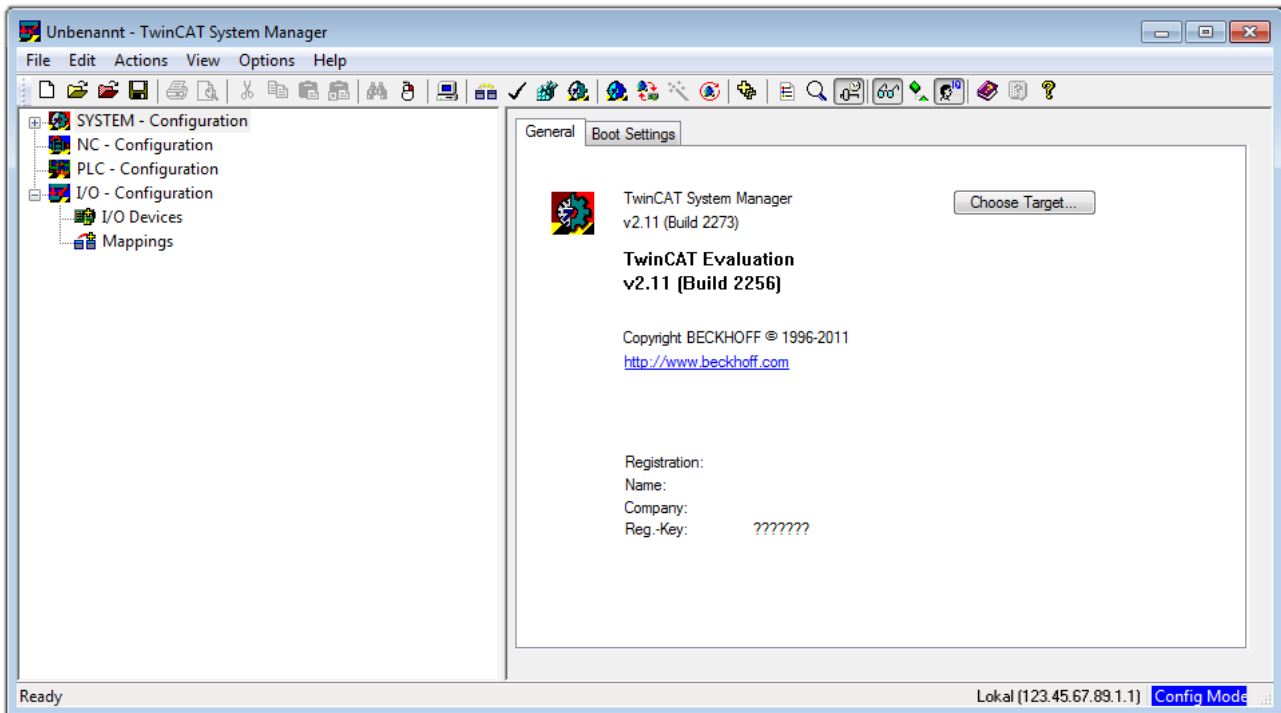



Fig. 30: Initial TwinCAT 2 user interface

Generally, TwinCAT can be used in local or remote mode. Once the TwinCAT system, including the user interface (standard) is installed on the respective PLC, TwinCAT can be used in local mode and thus the next step is “[Insert Device \[▶ 58\]](#)”.

If the intention is to address the TwinCAT runtime environment installed on a PLC remotely from another system used as a development environment, the target system must be made known first. In the menu under

“Actions” → “Choose Target System...”, the following window is opened for this via the symbol “” or the “F8” key:

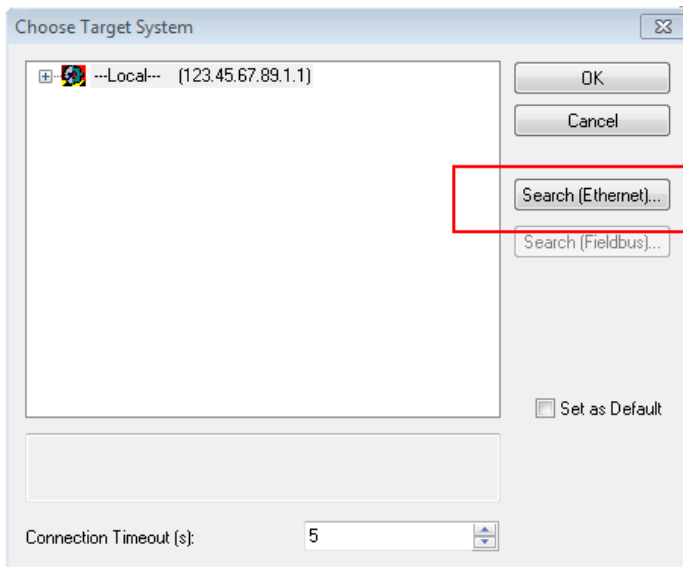

Fig. 31: Selection of the target system

Use “Search (Ethernet)...” to enter the target system. Thus another dialog opens to either:

- enter the known computer name after “Enter Host Name / IP:” (as shown in red)
- perform a “Broadcast Search” (if the exact computer name is not known)
- enter the known computer – IP or AmsNetID

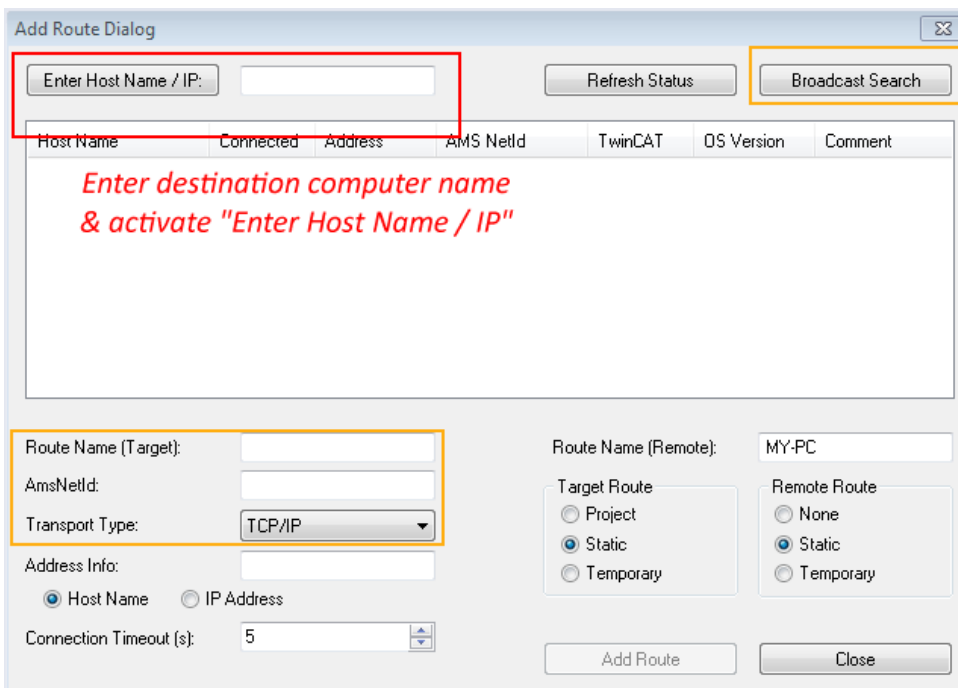
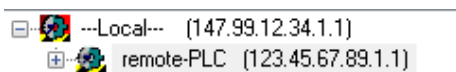

Fig. 32: specify the PLC for access by the TwinCAT System Manager: selection of the target system



Once the target system has been entered, it is available for selection as follows (a correct password may have to be entered before this):



After confirmation with “OK”, the target system can be accessed via the System Manager.

Adding devices

In the configuration tree of the TwinCAT 2 System Manager user interface on the left, select “I/O Devices” and then right-click to open a context menu and select “Scan Devices...”, or start the action in the menu bar

via . The TwinCAT System Manager may first have to be set to “Config Mode” via  or via the menu “Actions” → “Set/Reset TwinCAT to Config Mode...” (Shift + F4).

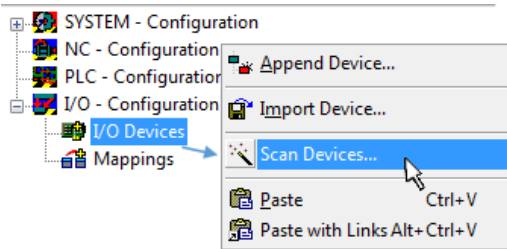

Fig. 33: Select “Scan Devices...”

Confirm the warning message, which follows, and select the “EtherCAT” devices in the dialog:

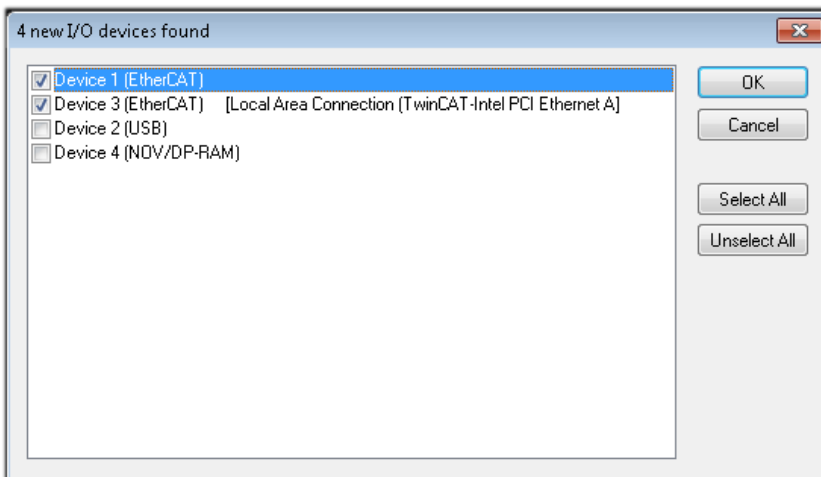

Fig. 34: Automatic detection of I/O devices: selection of the devices to be integrated

Confirm the message “Find new boxes”, in order to determine the terminals connected to the devices. “Free Run” enables manipulation of input and output values in “Config Mode” and should also be acknowledged.

Based on the [example configuration \[▶ 54\]](#) described at the beginning of this section, the result is as follows:

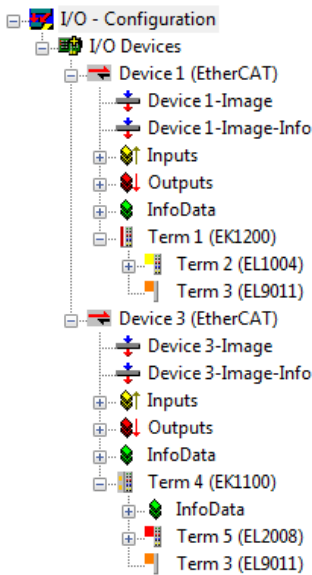

Fig. 35: Mapping of the configuration in the TwinCAT 2 System Manager

The whole process consists of two stages, which can also be performed separately (first determine the devices, then determine the connected elements such as boxes, terminals, etc.). A scan (search function) can also be initiated by selecting “Device ...” from the context menu, which then only reads the elements below which are present in the configuration:

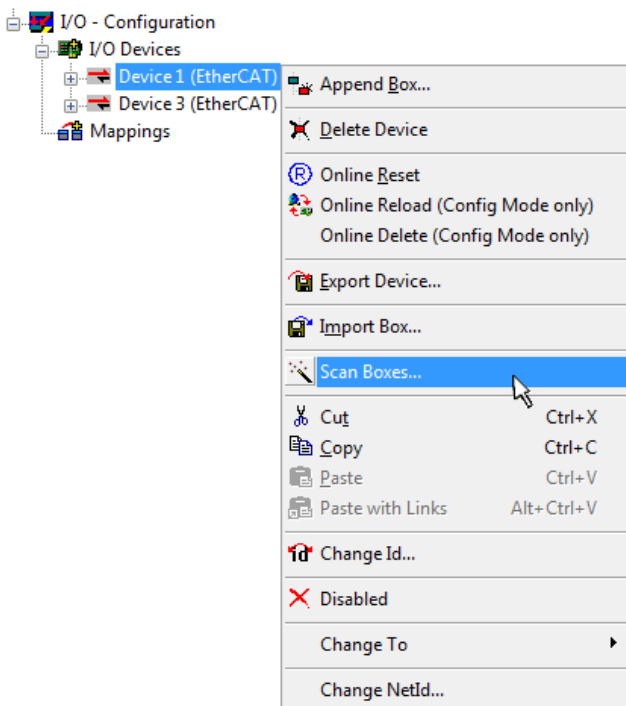

Fig. 36: Reading of individual terminals connected to a device

This functionality is useful if the actual configuration is modified at short notice.

Programming and integrating the PLC

TwinCAT PLC Control is the development environment for generating the controller in different program environments: TwinCAT PLC Control supports all languages described in IEC 61131-3. There are two text-based languages and three graphical languages.

- **Text-based languages**
 - Instruction List (IL)
 - Structured Text (ST)

- **Graphical languages**
 - Function Block Diagram (FBD)
 - Ladder Diagram (LD)
 - The Continuous Function Chart Editor (CFC)
 - Sequential Function Chart (SFC)

The following section refers solely to Structured Text (ST).

After starting TwinCAT PLC Control, the following user interface is shown for an initial project:

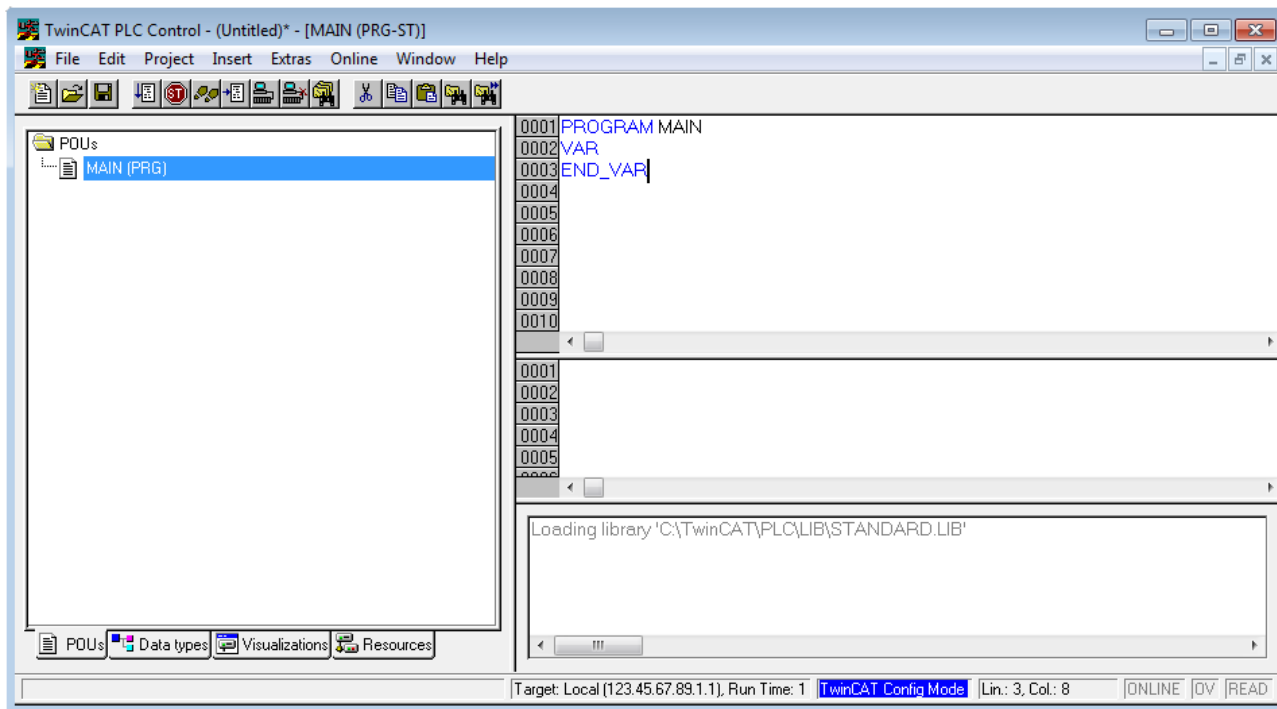

Fig. 37: TwinCAT PLC Control after startup

Example variables and an example program have been created and stored under the name "PLC_example.pro":

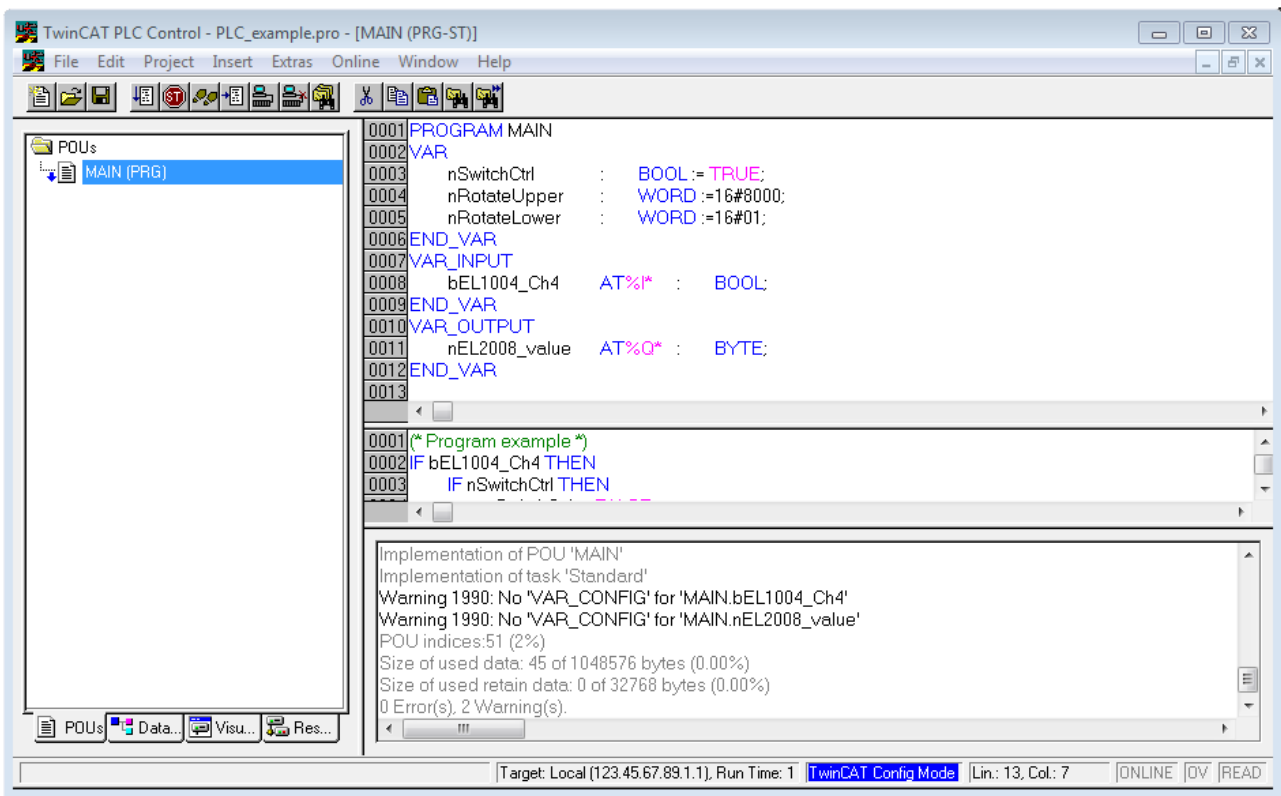

Fig. 38: Example program with variables after a compile process (without variable integration)

Warning 1990 (missing “VAR_CONFIG”) after a compile process indicates that the variables defined as external (with the ID “AT%I*” or “AT%Q*”) have not been assigned. After successful compilation, TwinCAT PLC Control creates a “*.tpy” file in the directory in which the project was stored. This file (“*.tpy”) contains variable assignments and is not known to the System Manager, hence the warning. Once the System Manager has been notified, the warning no longer appears.

First, integrate the TwinCAT PLC Control project in the **System Manager**. This is performed via the context menu of the PLC configuration (right-click) and selecting “Append PLC Project...”:

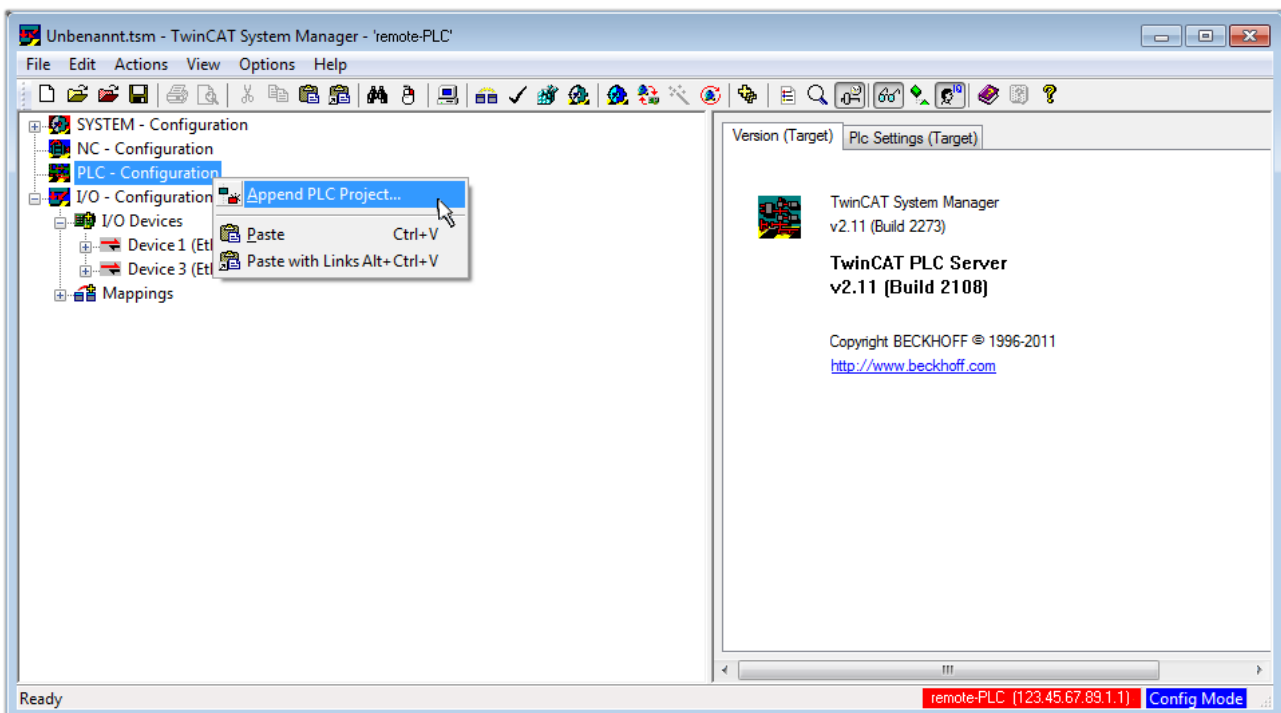

Fig. 39: Appending the TwinCAT PLC Control project

Select the PLC configuration “PLC_example.tpy” in the browser window that opens. The project including the two variables identified with “AT” are then integrated in the configuration tree of the System Manager:

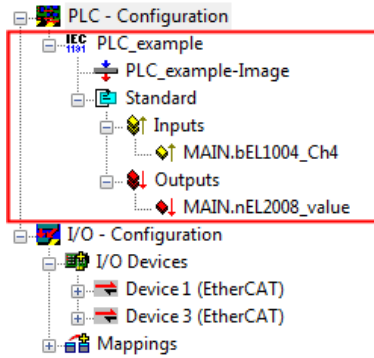

Fig. 40: PLC project integrated in the PLC configuration of the System Manager

The two variables “bEL1004_Ch4” and “nEL2008_value” can now be assigned to certain process objects of the I/O configuration.

Assigning variables

Open a window for selecting a suitable process object (PDO) via the context menu of a variable of the integrated project “PLC_example” and via “Modify Link...” “Standard”:

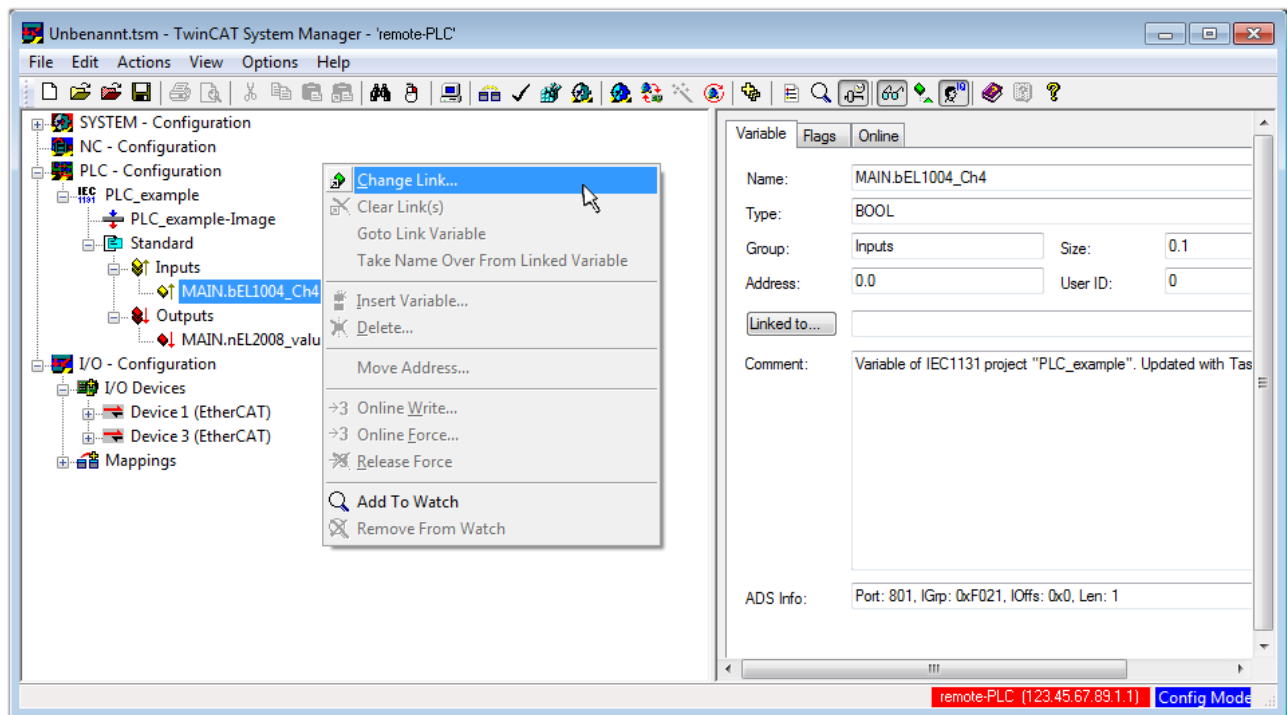

Fig. 41: Creating the links between PLC variables and process objects

In the window that opens, the process object for the “bEL1004_Ch4” BOOL-type variable can be selected from the PLC configuration tree:

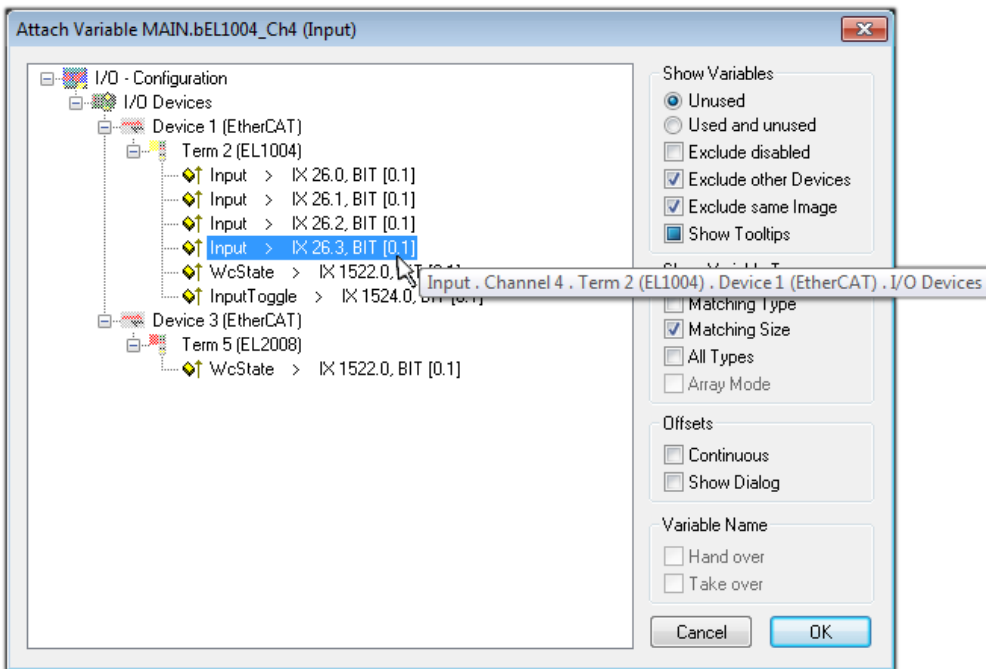

Fig. 42: Selecting BOOL-type PDO

According to the default setting, only certain PDO objects are now available for selection. In this example, the input of channel 4 of the EL1004 terminal is selected for linking. In contrast, the checkbox “All types” must be ticked to create the link for the output variables, in order to allocate a set of eight separate output bits to a byte variable in this case. The following diagram shows the whole process:

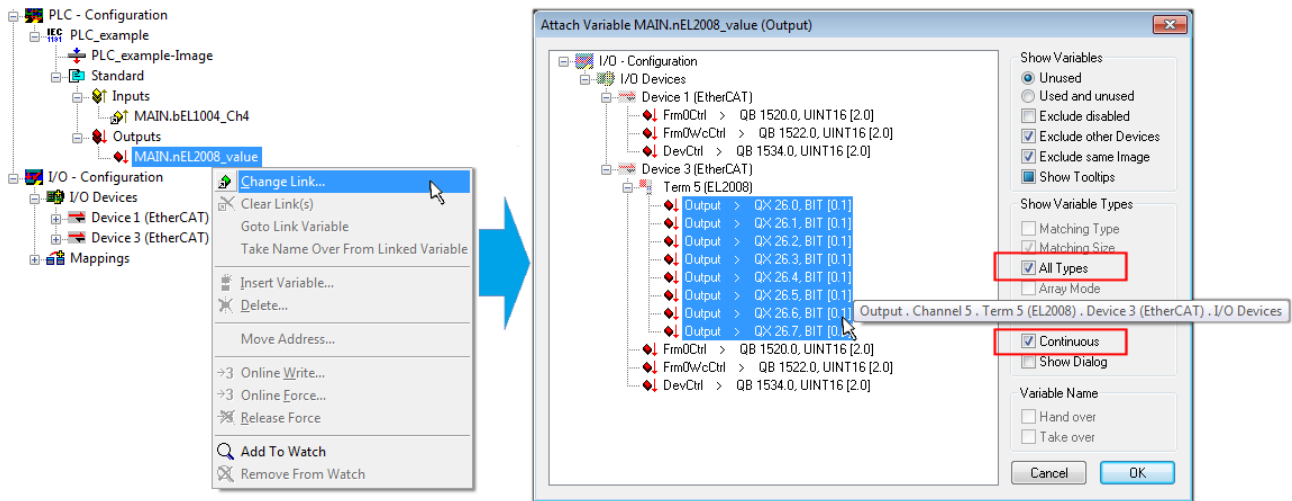



Fig. 43: Selecting several PDOs simultaneously: activate “Continuous” and “All types”

Note that the “Continuous” checkbox was also activated. This is designed to allocate the bits contained in the byte of the “nEL2008_value” variable sequentially to all eight selected output bits of the EL2008 Terminal. It is thus possible to subsequently address all eight outputs of the terminal in the program with a byte corresponding to bit 0 for channel 1 to bit 7 for channel 8 of the PLC. A special symbol () on the yellow or red object of the variable indicates that a link exists. The links can also be checked by selecting “Goto Link Variable” from the context menu of a variable. The opposite linked object, in this case the PDO, is automatically selected:

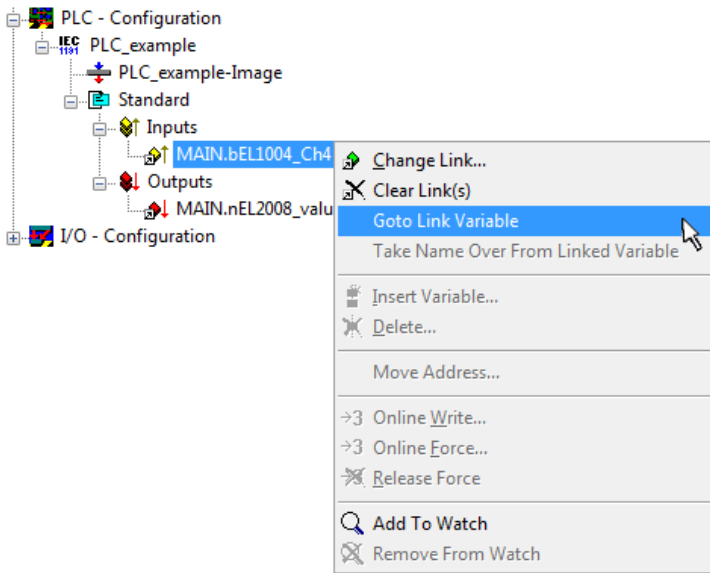

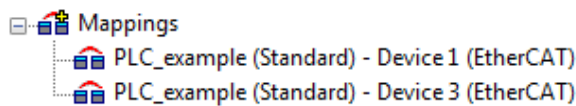

Fig. 44: Application of a “Goto Link Variable”, using “MAIN.bEL1004_Ch4” as an example

The process of assigning variables to the PDO is completed via the menu option “Actions” → “Create assignment”, or via  .

This can be visualized in the configuration:



The process of creating links can also be performed in the opposite direction, i.e. starting with individual PDOs to a variable. However, in this example, it would not be possible to select all output bits for the EL2008, since the terminal only makes individual digital outputs available. If a terminal has a byte, word, integer or similar PDO, it is also possible to allocate this to a set of bit-standardized variables. Here, too, a “Goto Link Variable” can be executed in the other direction, so that the respective PLC instance can then be selected.

Activation of the configuration

The allocation of PDO to PLC variables has now established the connection from the controller to the inputs and outputs of the terminals. The configuration can now be activated. First, the configuration can be verified

via  (or via “Actions” → “Check Configuration”). If no error is present, the configuration can be

activated via  (or via “Actions” → “Activate Configuration...”) to transfer the System Manager settings to the runtime system. Confirm the messages “Old configurations will be overwritten!” and “Restart TwinCAT system in Run mode” with “OK”.

A few seconds later, the real-time status RTime 0% is displayed at the bottom right in the System Manager. The PLC system can then be started as described below.

Starting the controller

Starting from a remote system, the PLC control has to be linked with the embedded PC over the Ethernet via “Online” → “Choose Runtime System...”:

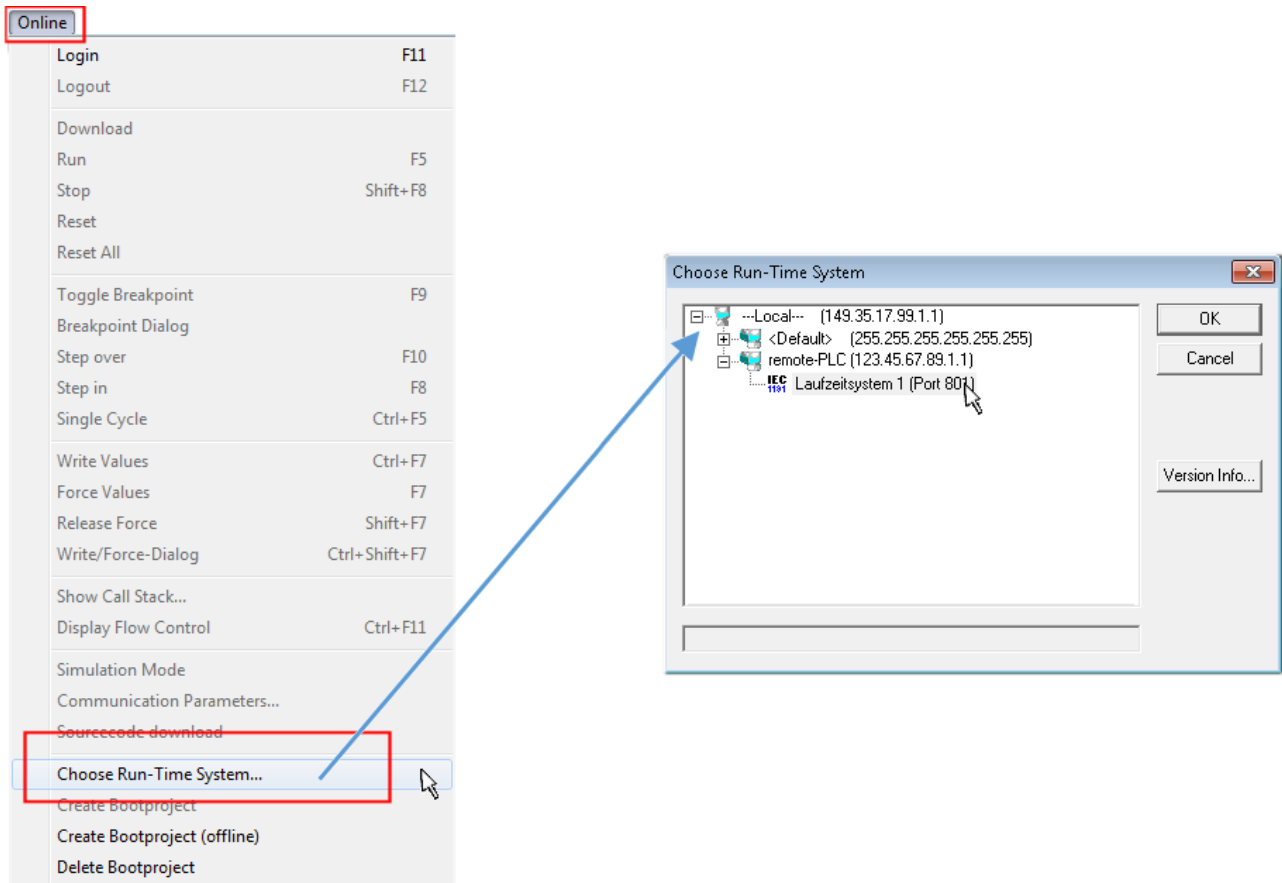

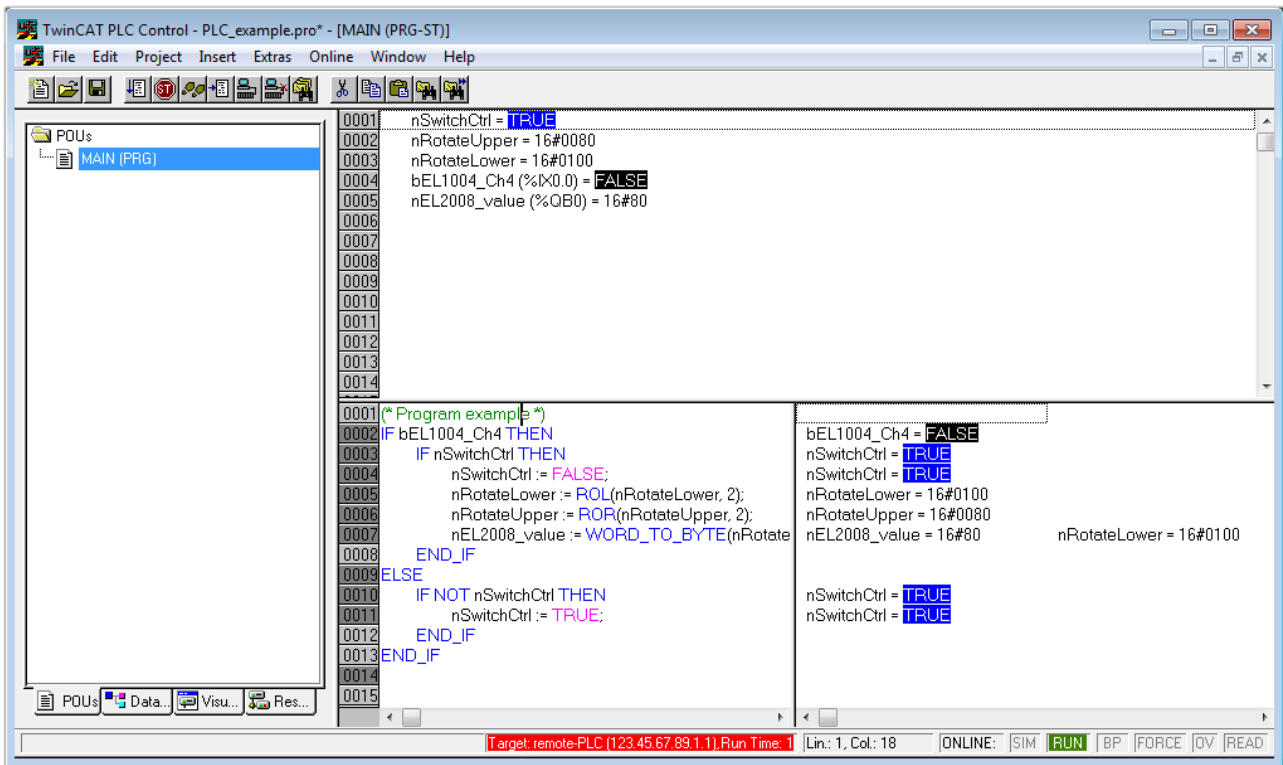

Fig. 45: Choose target system (remote)

In this example, "Runtime system 1 (port 801)" is selected and confirmed. Link the PLC with the real-time

system via the menu option "Online" → "Login", the F11 key or by clicking on the symbol . The control program can then be loaded for execution. This results in the message "No program on the controller! Should the new program be loaded?", which should be confirmed with "Yes". The runtime environment is ready for the program start:



The PLC can now be started via “Online” → “Run”, F5 key or .

6.1.2 TwinCAT 3

Startup

TwinCAT 3 makes the development environment areas available all together, with Microsoft Visual Studio: after startup, the project folder explorer appears on the left in the general window area (see “TwinCAT System Manager” of TwinCAT 2) for communication with the electromechanical components.

After successful installation of the TwinCAT system on the PC to be used for development, TwinCAT 3 (shell) displays the following user interface after startup:



Fig. 47: Initial TwinCAT 3 user interface

First create a new project via  **New TwinCAT Project...** (or under “File”→“New”→“Project...”). In the following dialog, make the corresponding entries as required (as shown in the diagram):

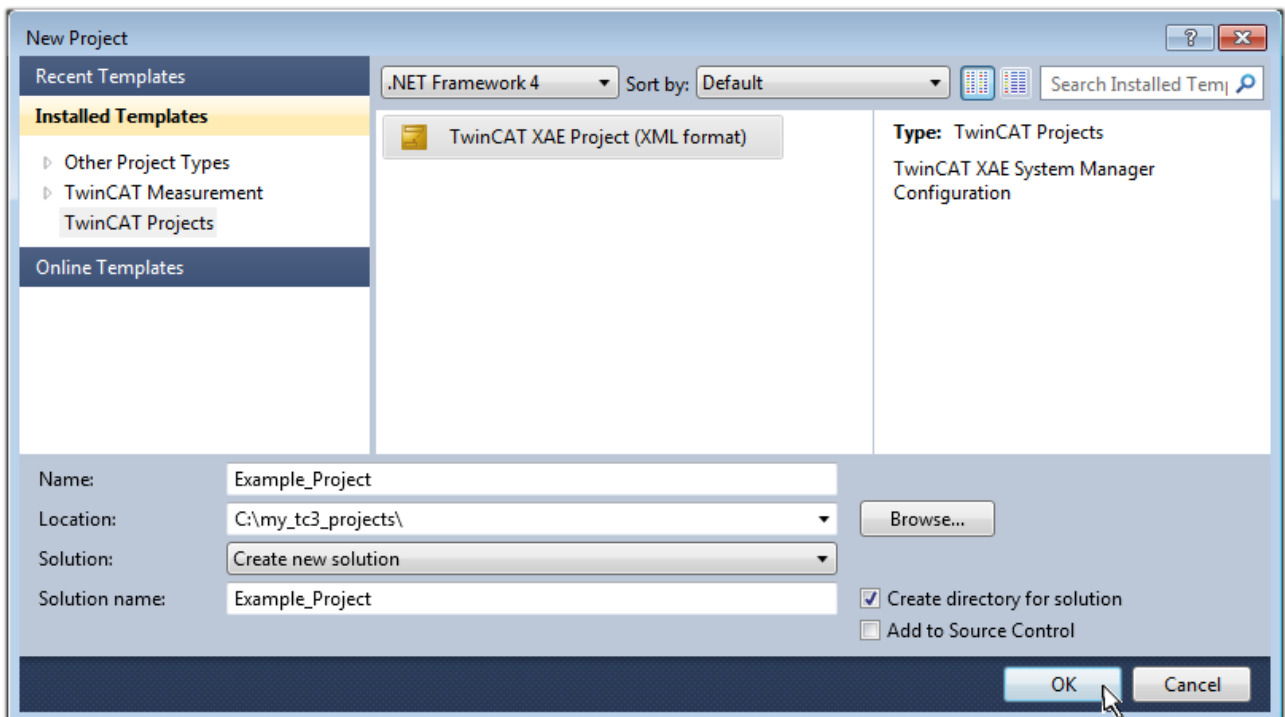

Fig. 48: Create new TwinCAT 3 project

The new project is then available in the project folder explorer:

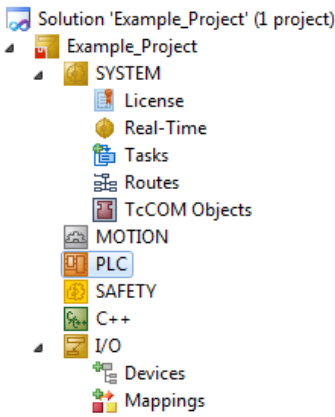
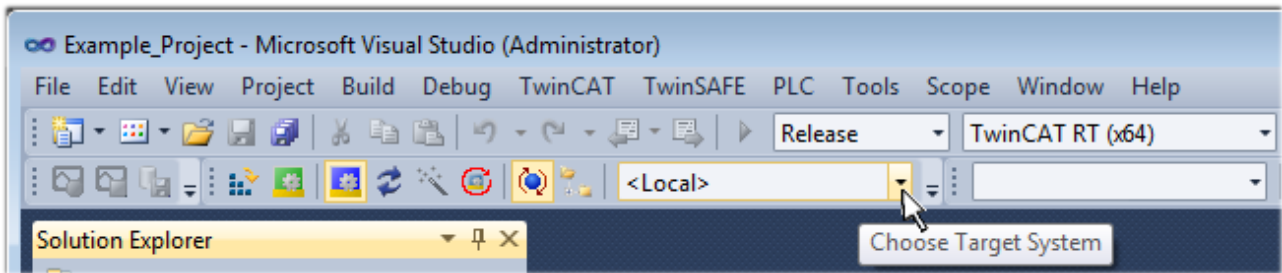

Fig. 49: New TwinCAT 3 project in the project folder explorer

Generally, TwinCAT can be used in local or remote mode. Once the TwinCAT system including the user interface (standard) is installed on the respective PLC (locally), TwinCAT can be used in local mode and the process can be continued with the next step, “Insert Device [▶ 69]”.

If the intention is to address the TwinCAT runtime environment installed on a PLC remotely from another system used as a development environment, the target system must be made known first. Via the symbol in the menu bar:



expand the pull-down menu:

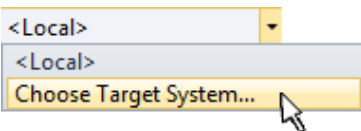

and open the following window:

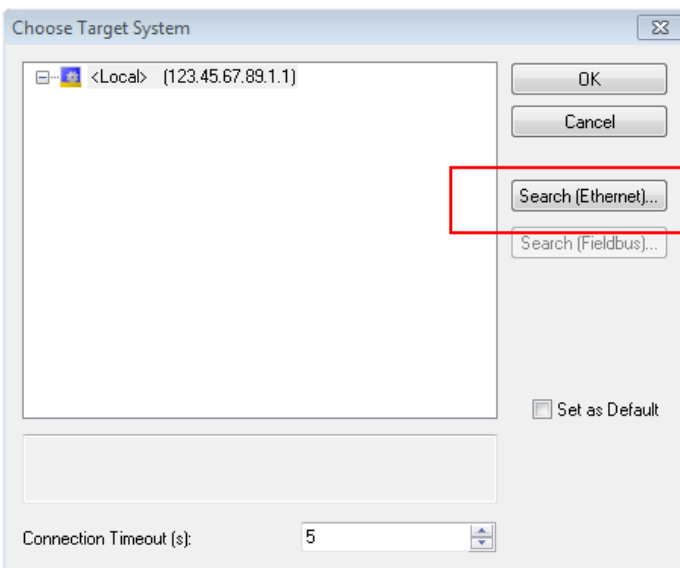

Fig. 50: Selection dialog: Choose the target system

Use “Search (Ethernet)...” to enter the target system. Thus another dialog opens to either:

- enter the known computer name after “Enter Host Name / IP:” (as shown in red)
- perform a “Broadcast Search” (if the exact computer name is not known)
- enter the known computer – IP or AmsNetID

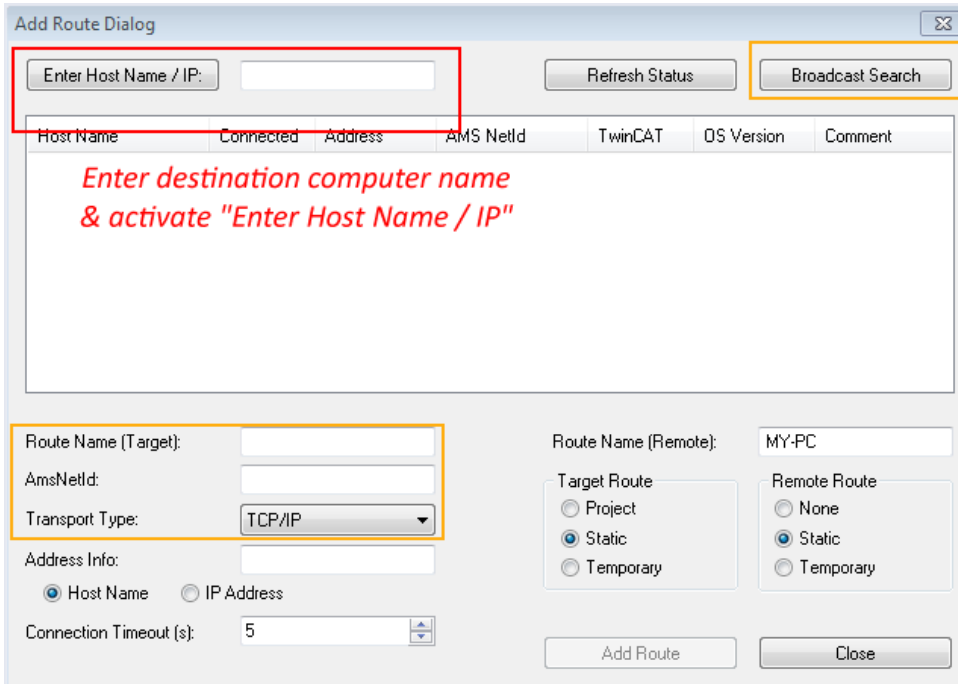
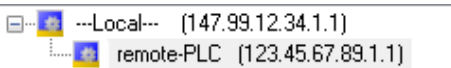

Fig. 51: specify the PLC for access by the TwinCAT System Manager: selection of the target system

Once the target system has been entered, it is available for selection as follows (the correct password may have to be entered beforehand):



After confirmation with “OK” the target system can be accessed via the Visual Studio shell.

Adding devices

In the project folder explorer on the left of the Visual Studio shell user interface, select “Devices” within the

element “I/O”, then right-click to open a context menu and select “Scan” or start the action via  in the

menu bar. The TwinCAT System Manager may first have to be set to “Config mode” via  or via the menu “TwinCAT” → “Restart TwinCAT (Config Mode)”.

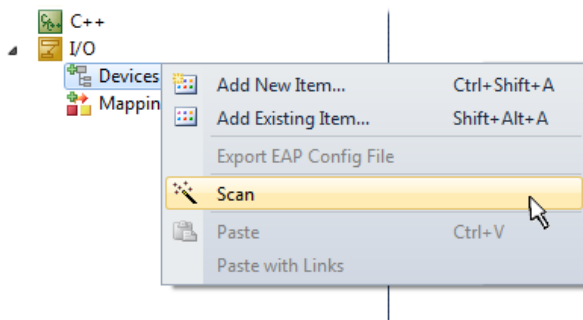

Fig. 52: Select “Scan”

Confirm the warning message, which follows, and select the “EtherCAT” devices in the dialog:

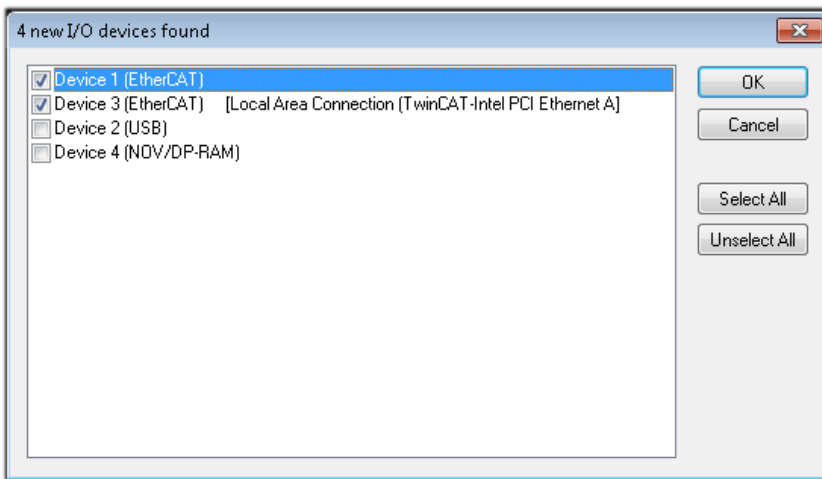

Fig. 53: Automatic detection of I/O devices: selection of the devices to be integrated

Confirm the message “Find new boxes”, in order to determine the terminals connected to the devices. “Free Run” enables manipulation of input and output values in “Config Mode” and should also be acknowledged.

Based on the [example configuration \[▶ 54\]](#) described at the beginning of this section, the result is as follows:

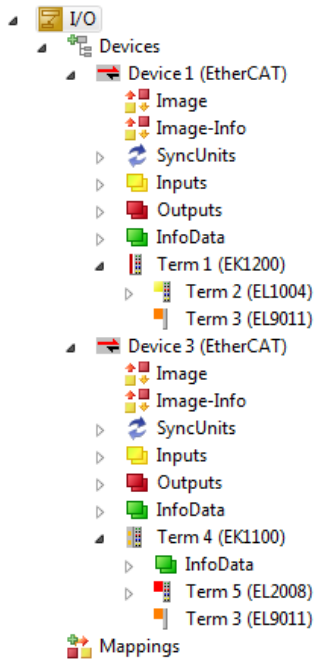

Fig. 54: Mapping of the configuration in VS shell of the TwinCAT 3 environment

The whole process consists of two stages, which can also be performed separately (first determine the devices, then determine the connected elements such as boxes, terminals, etc.). A scan (search function) can also be initiated by selecting “Device ...” from the context menu, which then only reads the elements below which are present in the configuration:

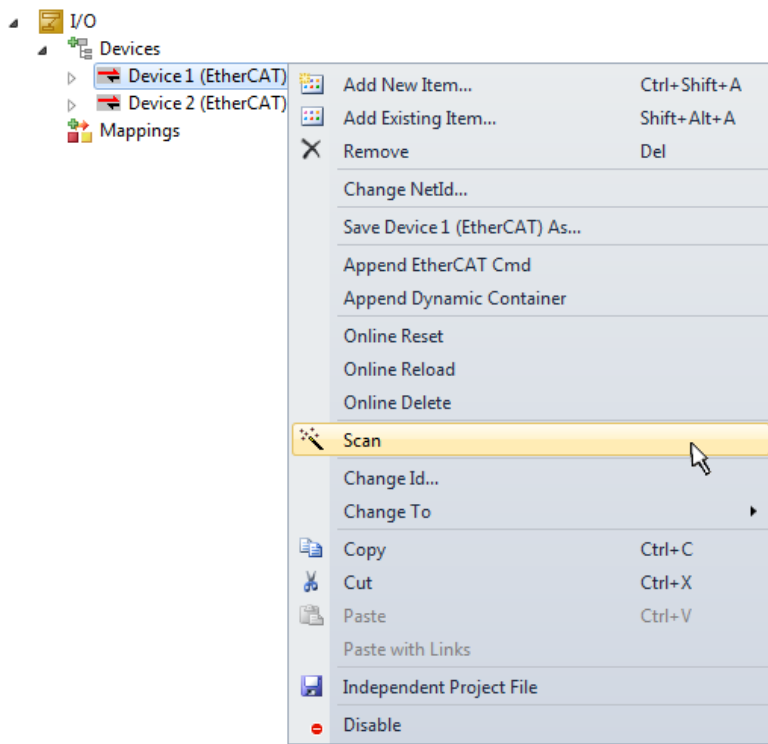

Fig. 55: Reading of individual terminals connected to a device

This functionality is useful if the actual configuration is modified at short notice.

Programming the PLC

TwinCAT PLC Control is the development environment for generating the controller in different program environments: TwinCAT PLC Control supports all languages described in IEC 61131-3. There are two text-based languages and three graphical languages.

- **Text-based languages**
 - Instruction List (IL)
 - Structured Text (ST)
- **Graphical languages**
 - Function Block Diagram (FBD)
 - Ladder Diagram (LD)
 - The Continuous Function Chart Editor (CFC)
 - Sequential Function Chart (SFC)

The following section refers solely to Structured Text (ST).

In order to create a programming environment, a PLC subproject is added to the example project via the context menu of the “PLC” in the project folder explorer by selecting “Add New Item....”:

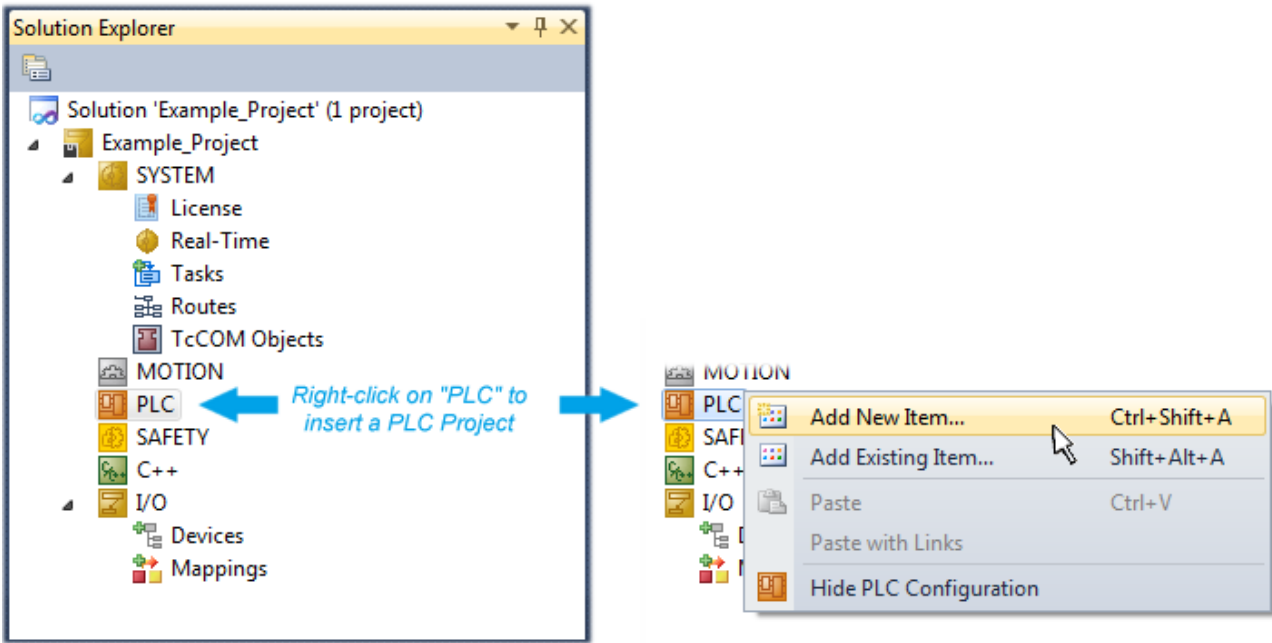

Fig. 56: Adding the programming environment in “PLC”

In the dialog that opens, select “Standard PLC project” and enter “PLC_example” as project name, for example, and select a corresponding directory:

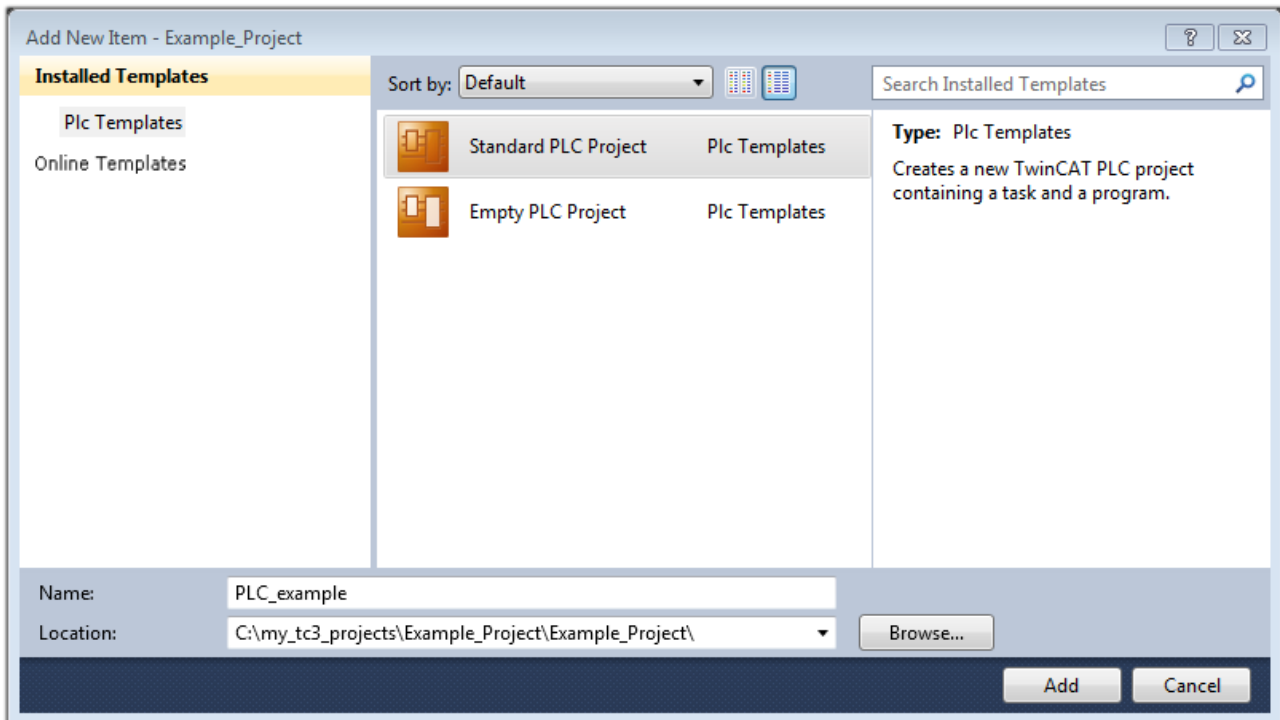

Fig. 57: Specifying the name and directory for the PLC programming environment

The “Main” program, which already exists due to selecting “Standard PLC project”, can be opened by double-clicking on “PLC_example_project” in “POUs”. The following user interface is shown for an initial project:

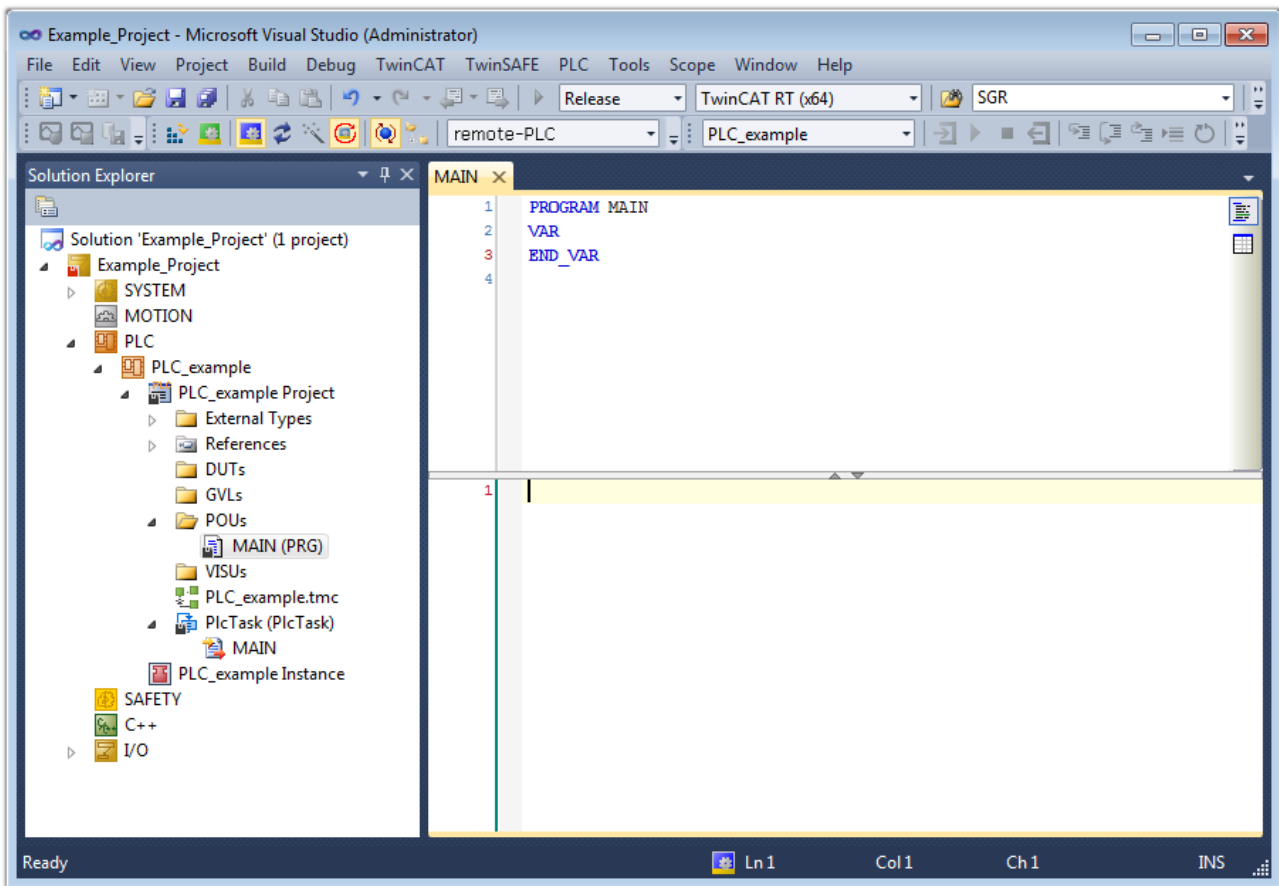

Fig. 58: Initial “Main” program for the standard PLC project

Now example variables and an example program have been created for the next stage of the process:

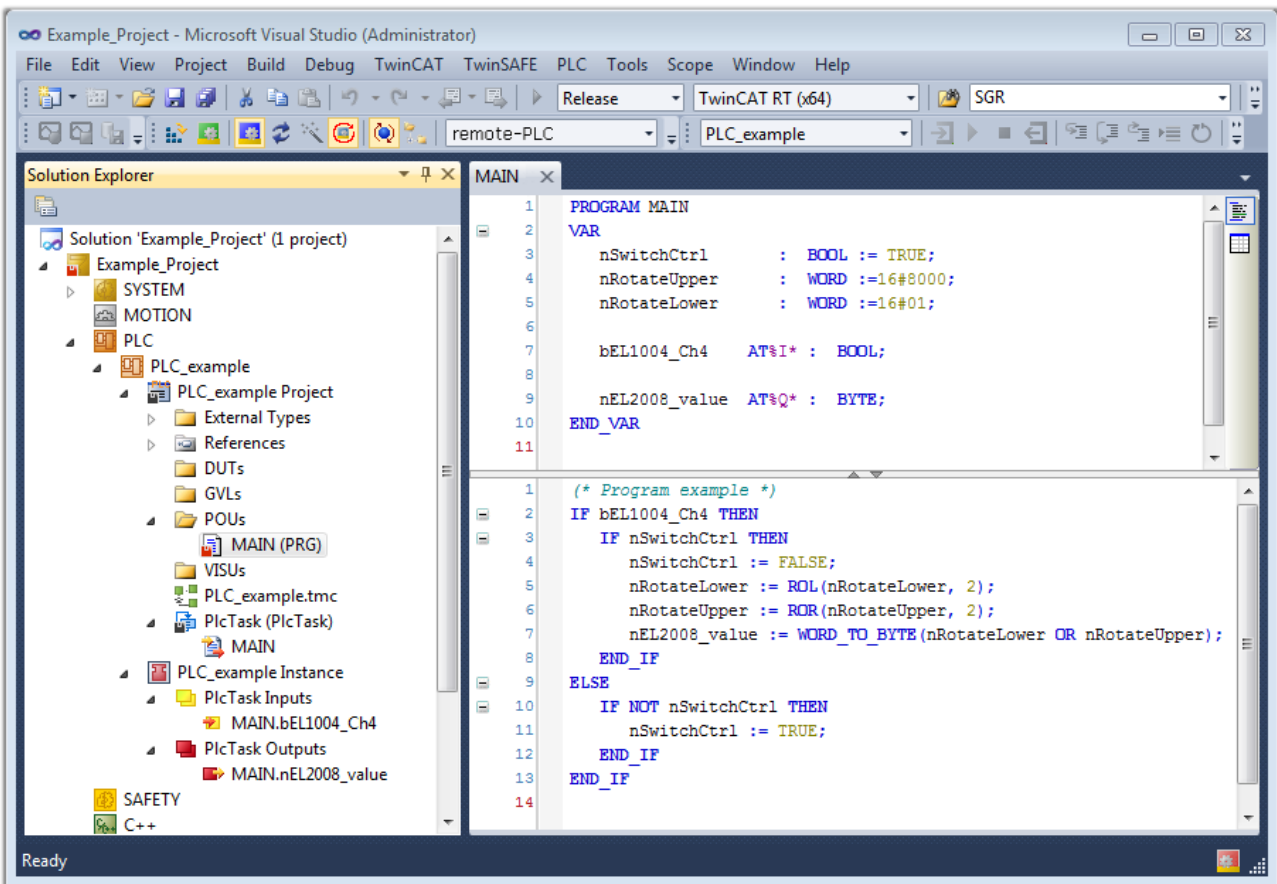

Fig. 59: Example program with variables after a compile process (without variable integration)

The control program is now created as a project folder, followed by the compile process:

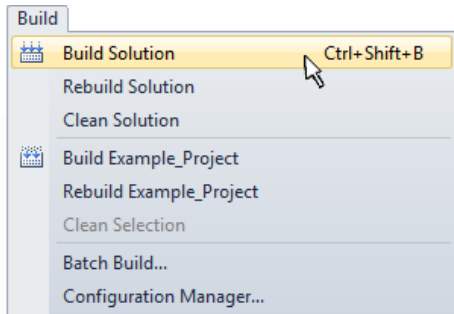
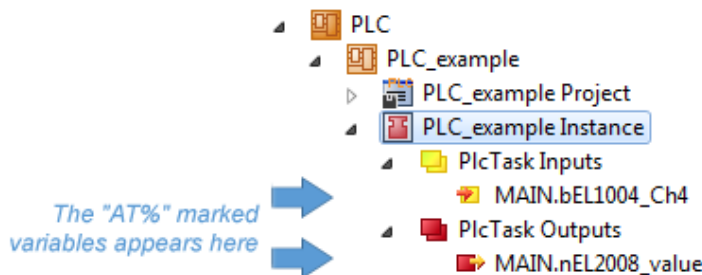

Fig. 60: Start program compilation

The following variables, identified in the ST/PLC program with “AT%”, are then available under “Assignments” in the project folder explorer:



Assigning variables

Via the menu of an instance – variables in the “PLC” context, use the “Modify Link...” option to open a window to select a suitable process object (PDO) for linking:

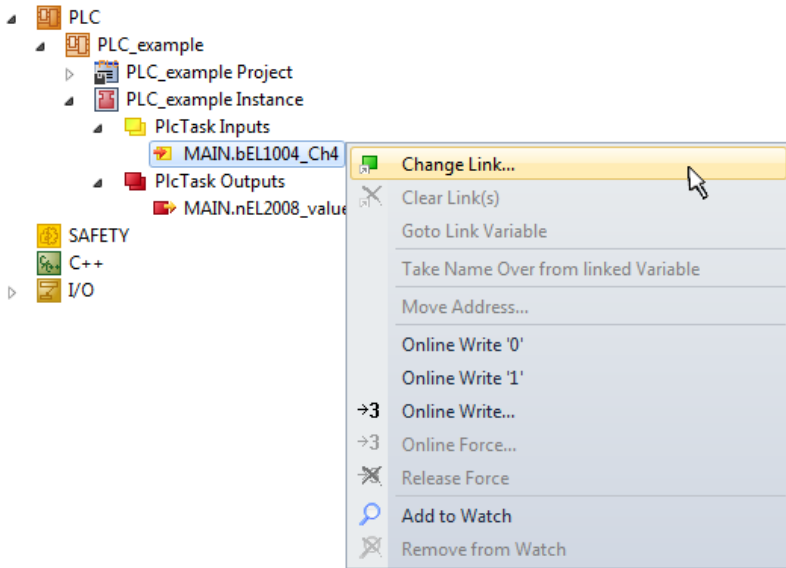

Fig. 61: Creating the links between PLC variables and process objects

In the window that opens, the process object for the “bEL1004_Ch4” BOOL-type variable can be selected from the PLC configuration tree:

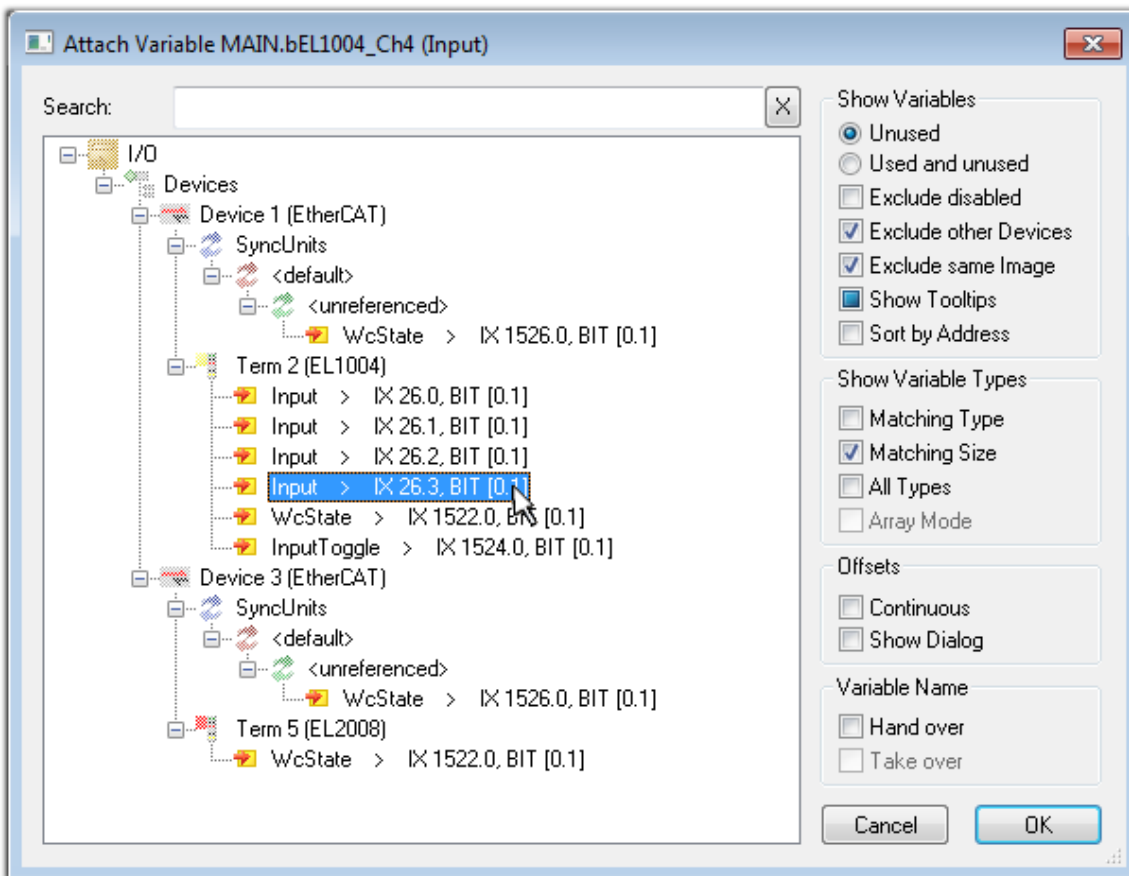

Fig. 62: Selecting BOOL-type PDO

According to the default setting, only certain PDO objects are now available for selection. In this example, the input of channel 4 of the EL1004 terminal is selected for linking. In contrast, the checkbox “All types” must be ticked to create the link for the output variables, in order to allocate a set of eight separate output bits to a byte variable in this case. The following diagram shows the whole process:

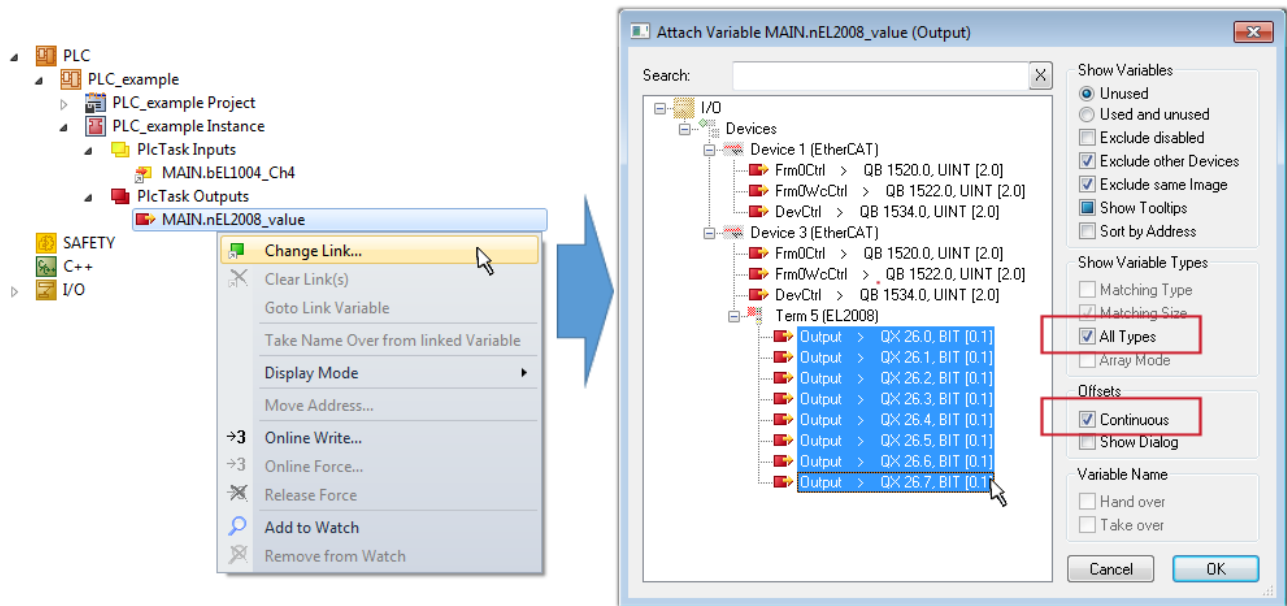



Fig. 63: Selecting several PDOs simultaneously: activate “Continuous” and “All types”

Note that the “Continuous” checkbox was also activated. This is designed to allocate the bits contained in the byte of the “nEL2008_value” variable sequentially to all eight selected output bits of the EL2008 Terminal. It is thus possible to subsequently address all eight outputs of the terminal in the program with a byte corresponding to bit 0 for channel 1 to bit 7 for channel 8 of the PLC. A special symbol () on the yellow or red object of the variable indicates that a link exists. The links can also be checked by selecting “Goto Link Variable” from the context menu of a variable. The opposite linked object, in this case the PDO, is automatically selected:

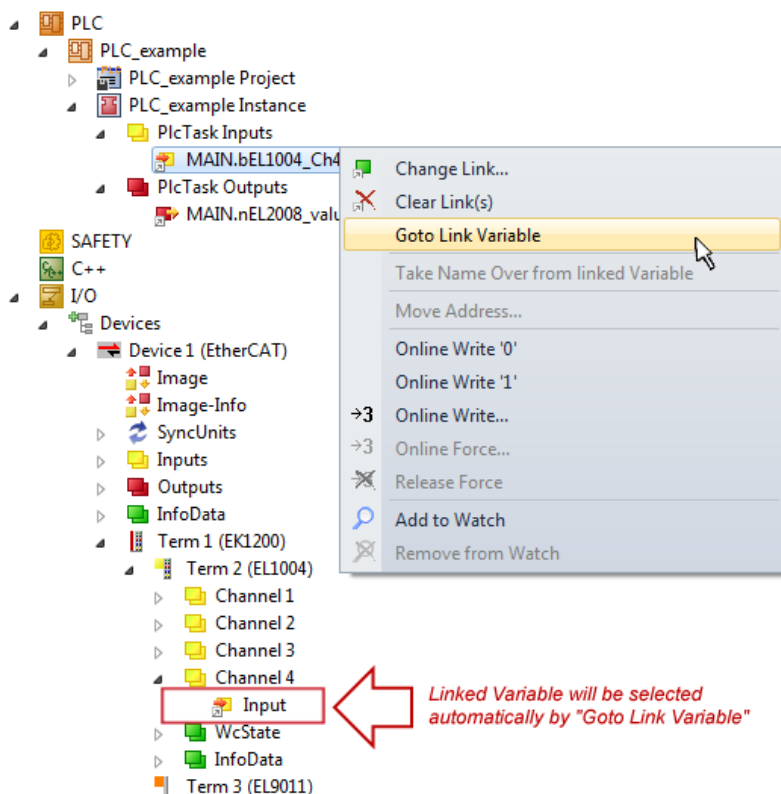

Fig. 64: Application of a “Goto Link Variable”, using “MAIN.bEL1004_Ch4” as an example

The process of creating links can also be performed in the opposite direction, i.e. starting with individual PDOs to a variable. However, in this example, it would not be possible to select all output bits for the EL2008, since the terminal only makes individual digital outputs available. If a terminal has a byte, word,

integer or similar PDO, it is also possible to allocate this to a set of bit-standardized variables. Here, too, a “Goto Link Variable” can be executed in the other direction, so that the respective PLC instance can then be selected.

Note on type of variable assignment

i The following type of variable assignment can only be used from TwinCAT version V3.1.4024.4 onwards and is only available for terminals with a microcontroller.

In TwinCAT, a structure can be created from the mapped process data of a terminal. An instance of this structure can then be created in the PLC, so it is possible to access the process data directly from the PLC without having to declare own variables.

The procedure for the EL3001 1-channel analog input terminal -10...+10 V is shown as an example.

1. First, the required process data must be selected in the “Process data” tab in TwinCAT.
2. After that, the PLC data type must be generated in the “PLC” tab via the check box.
3. The data type in the “Data Type” field can then be copied using the “Copy” button.

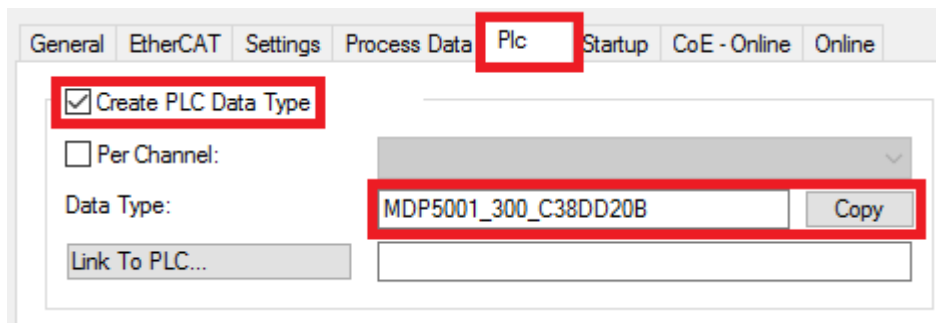

Fig. 65: Creating a PLC data type

4. An instance of the data structure of the copied data type must then be created in the PLC.

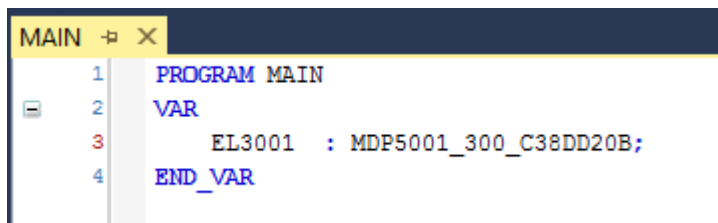

Fig. 66: Instance_of_struct

5. Then the project folder must be created. This can be done either via the key combination “CTRL + Shift + B” or via the “Build” tab in TwinCAT.
6. The structure in the “PLC” tab of the terminal must then be linked to the created instance.

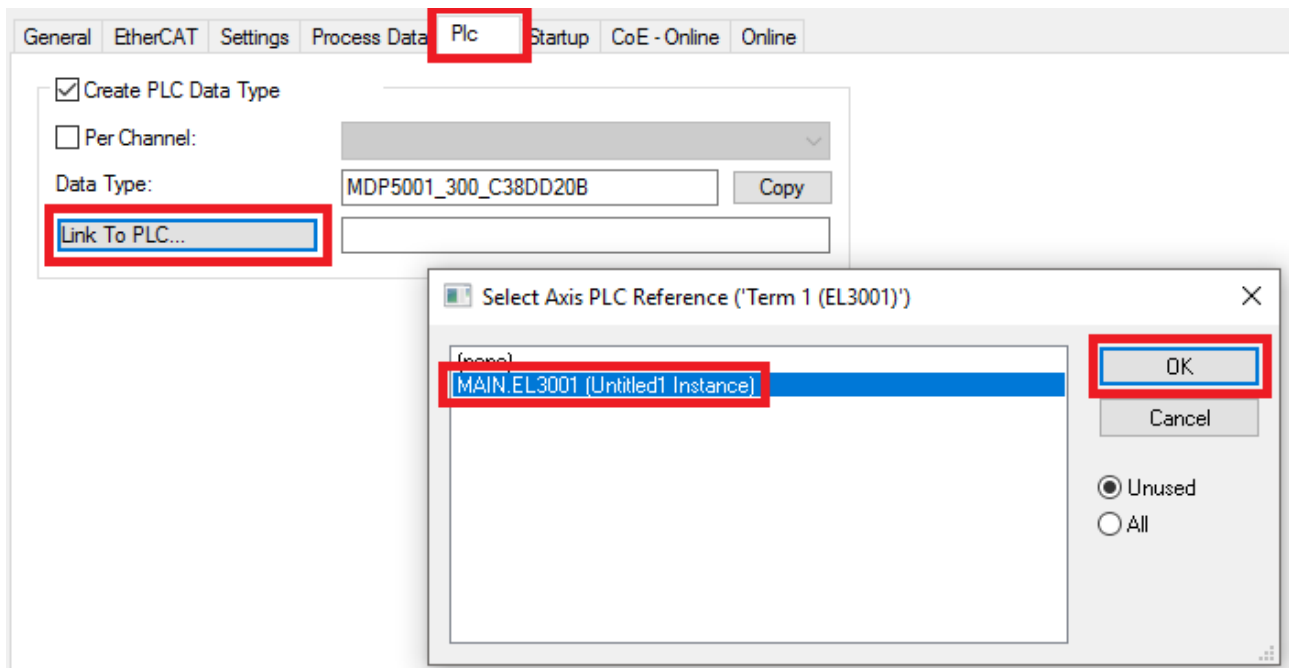

Fig. 67: Linking the structure

7. In the PLC, the process data can then be read or written via the structure in the program code.

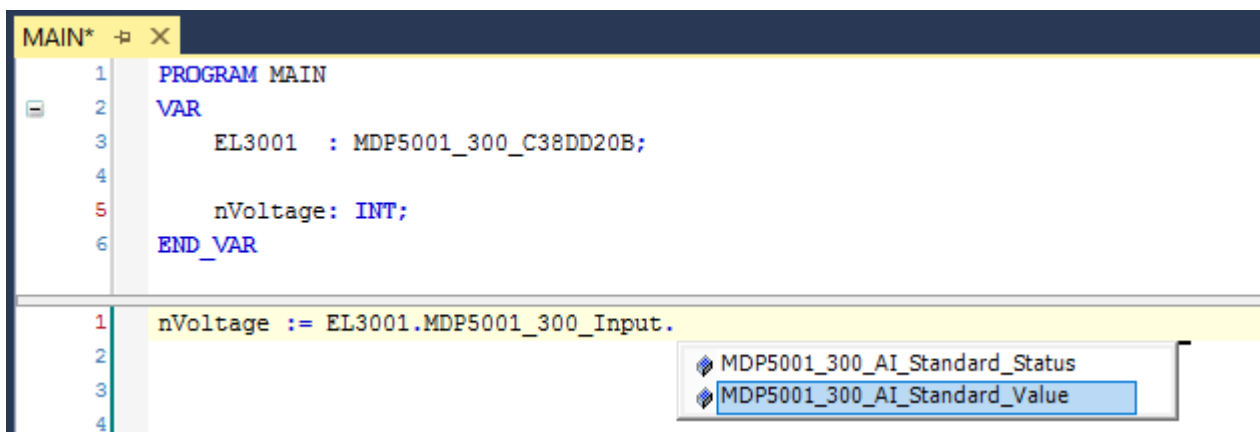

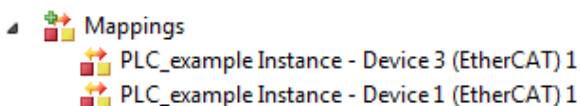

Fig. 68: Reading a variable from the structure of the process data

Activation of the configuration

The allocation of PDO to PLC variables has now established the connection from the controller to the inputs

and outputs of the terminals. The configuration can now be activated with  or via the menu under “TwinCAT” in order to transfer the settings of the development environment to the runtime system. Confirm the messages “Old configurations will be overwritten!” and “Restart TwinCAT system in Run mode” with “OK”. The corresponding assignments can be seen in the project folder explorer:



A few seconds later, the corresponding status of the Run mode is displayed in the form of a rotating symbol

 at the bottom right of the VS shell development environment. The PLC system can then be started as described below.

Starting the controller

Select the menu option “PLC” → “Login” or click on  to link the PLC with the real-time system and load the control program for execution. This results in the message “No program on the controller! Should the new program be loaded?”, which should be acknowledged with “Yes”. The runtime environment is ready for

the program to be started by clicking on symbol , the “F5” key or via “PLC” in the menu, by selecting “Start”. The started programming environment shows the runtime values of individual variables:

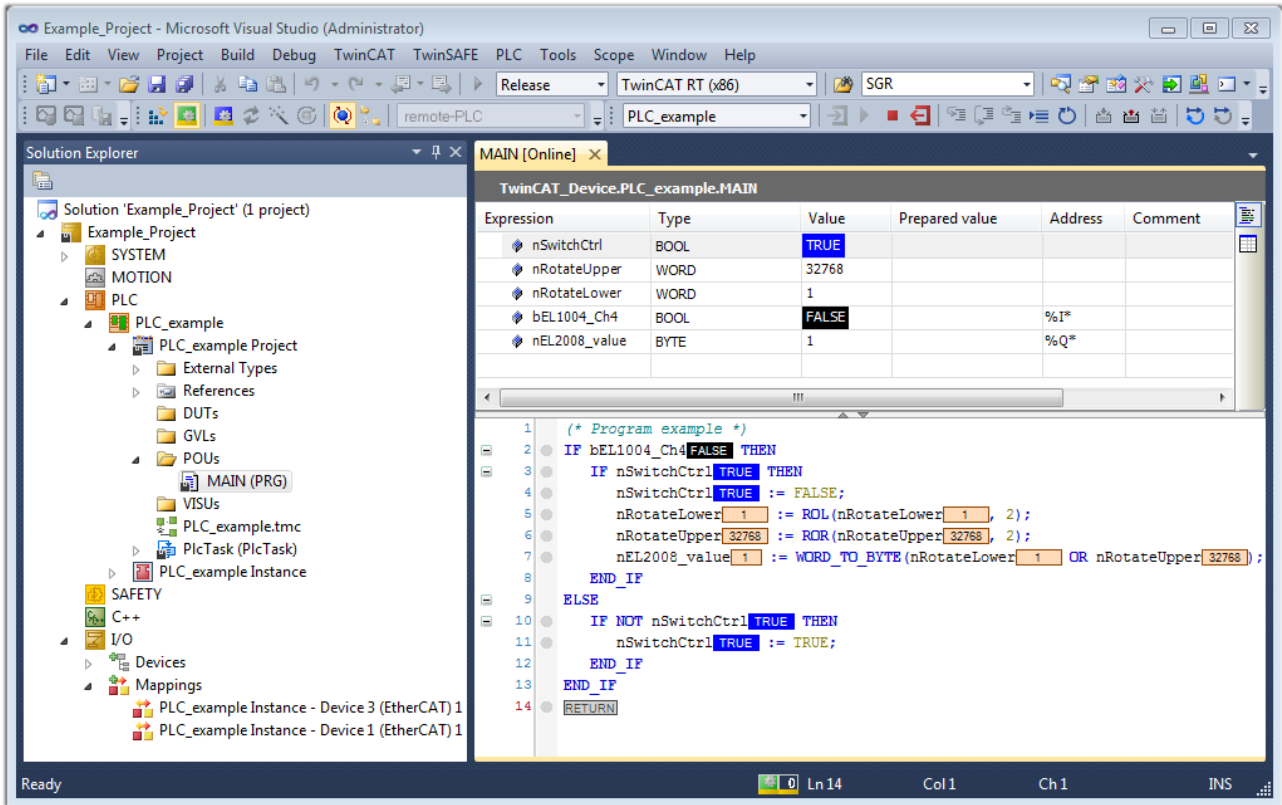



Fig. 69: TwinCAT 3 development environment (VS shell): logged-in, after program startup

The two operator control elements for stopping  and logout  result in the required action (also, “Shift + F5” can be used for stop, or both actions can be selected via the PLC menu).

6.2 TwinCAT Development Environment

The Software for automation TwinCAT (The Windows Control and Automation Technology) will be distinguished into:

- TwinCAT 2: System Manager (Configuration) & PLC Control (Programming)
- TwinCAT 3: Enhancement of TwinCAT 2 (Programming and Configuration takes place via a common Development Environment)

Details:

- **TwinCAT 2:**
 - Connects I/O devices to tasks in a variable-oriented manner
 - Connects tasks to tasks in a variable-oriented manner
 - Supports units at the bit level
 - Supports synchronous or asynchronous relationships
 - Exchange of consistent data areas and process images

- Datalink on NT - Programs by open Microsoft Standards (OLE, OCX, ActiveX, DCOM+, etc.)
- Integration of IEC 61131-3-Software-SPS, Software- NC and Software-CNC within Windows NT/ 2000/XP/Vista, Windows 7, NT/XP Embedded, CE
- Interconnection to all common fieldbusses
- [More...](#)

Additional features:

- **TwinCAT 3** (eXtended Automation):
 - Visual Studio® integration
 - Choice of the programming language
 - Supports object orientated extension of IEC 61131-3
 - Usage of C/C++ as programming language for real time applications
 - Connection to MATLAB®/Simulink®
 - Open interface for expandability
 - Flexible run-time environment
 - Active support of multi-core- and 64 bit operating system
 - Automatic code generation and project creation with the TwinCAT Automation Interface
 - [More...](#)

Within the following sections commissioning of the TwinCAT Development Environment on a PC System for the control and also the basically functions of unique control elements will be explained.

Please see further information to TwinCAT 2 and TwinCAT 3 at <http://infosys.beckhoff.com>.

6.2.1 Installation of the TwinCAT real-time driver

In order to assign real-time capability to a standard Ethernet port of an IPC controller, the Beckhoff real-time driver has to be installed on this port under Windows.

This can be done in several ways.

A: Via the TwinCAT Adapter dialog

In the System Manager call up the TwinCAT overview of the local network interfaces via Options → Show Real Time Ethernet Compatible Devices.

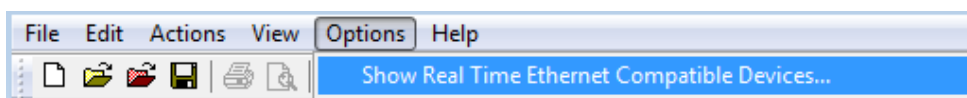

Fig. 70: System Manager "Options" (TwinCAT 2)

This have to be called up by the menu "TwinCAT" within the TwinCAT 3 environment:

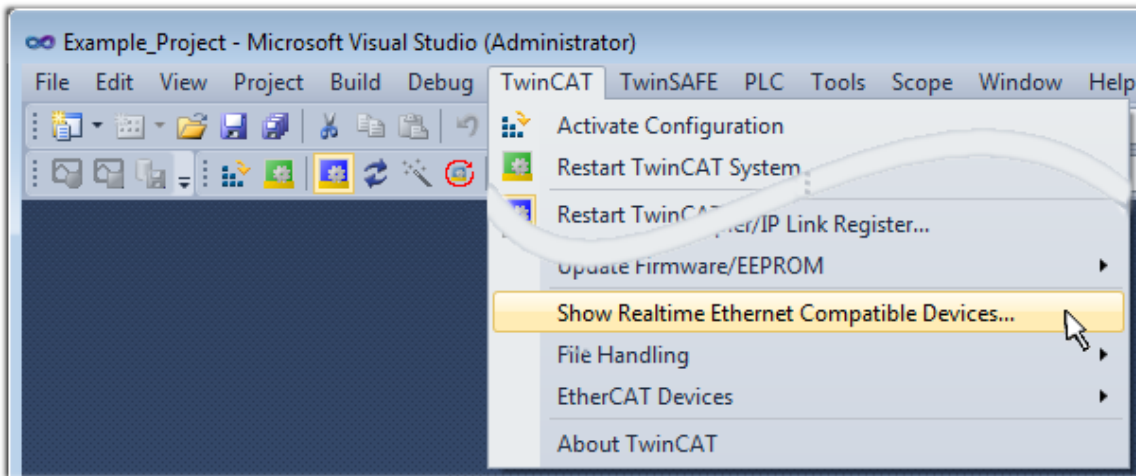

Fig. 71: Call up under VS Shell (TwinCAT 3)

B: Via TcRtelInstall.exe in the TwinCAT directory

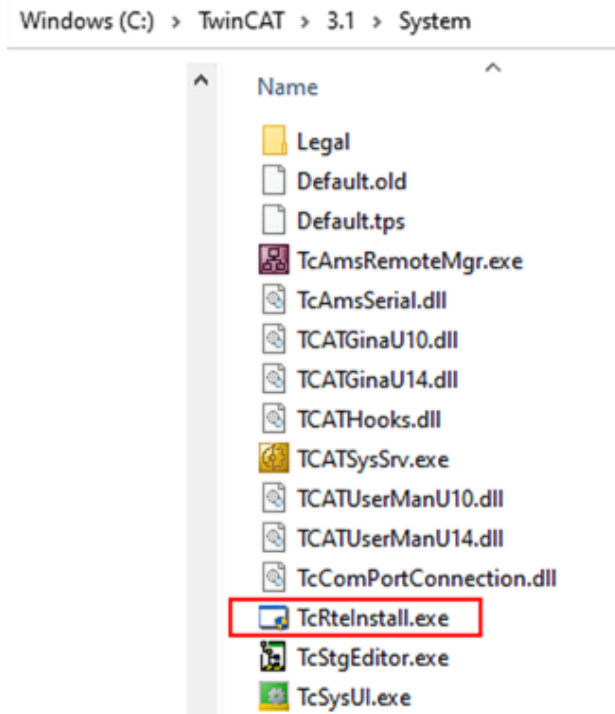

Fig. 72: TcRtelInstall in the TwinCAT directory

In both cases, the following dialog appears:

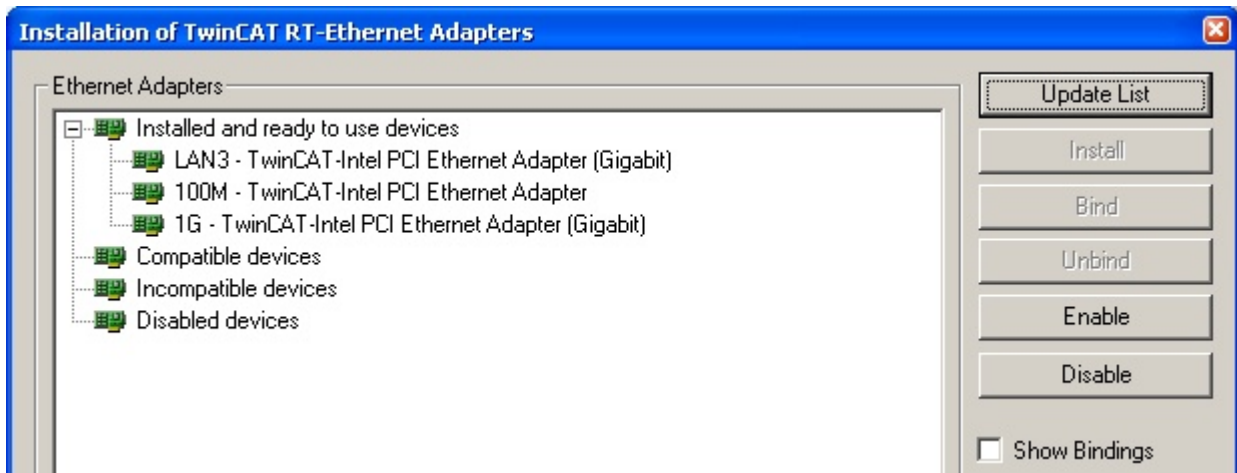

Fig. 73: Overview of network interfaces

Interfaces listed under “Compatible devices” can be assigned a driver via the “Install” button. A driver should only be installed on compatible devices.

A Windows warning regarding the unsigned driver can be ignored.

Alternatively an EtherCAT-device can be inserted first of all as described in chapter [Offline configuration creation](#), section “Creating the EtherCAT device” [► 91] in order to view the compatible ethernet ports via its EtherCAT properties (tab “Adapter”, button “Compatible Devices...”):



Fig. 74: EtherCAT device properties (TwinCAT 2): click on “Compatible Devices...” of tab “Adapter”

TwinCAT 3: the properties of the EtherCAT device can be opened by double click on “Device .. (EtherCAT)” within the Solution Explorer under “I/O”:

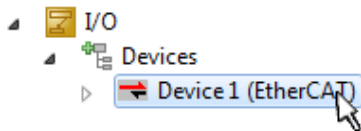

After the installation the driver appears activated in the Windows overview for the network interface (Windows Start → System Properties → Network)

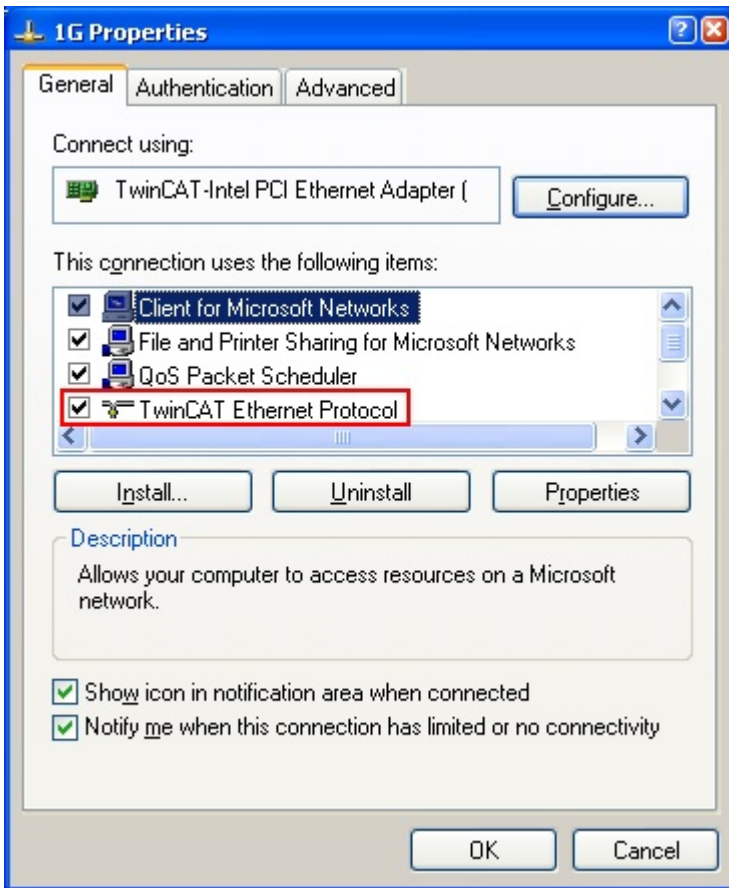

Fig. 75: Windows properties of the network interface

A correct setting of the driver could be:

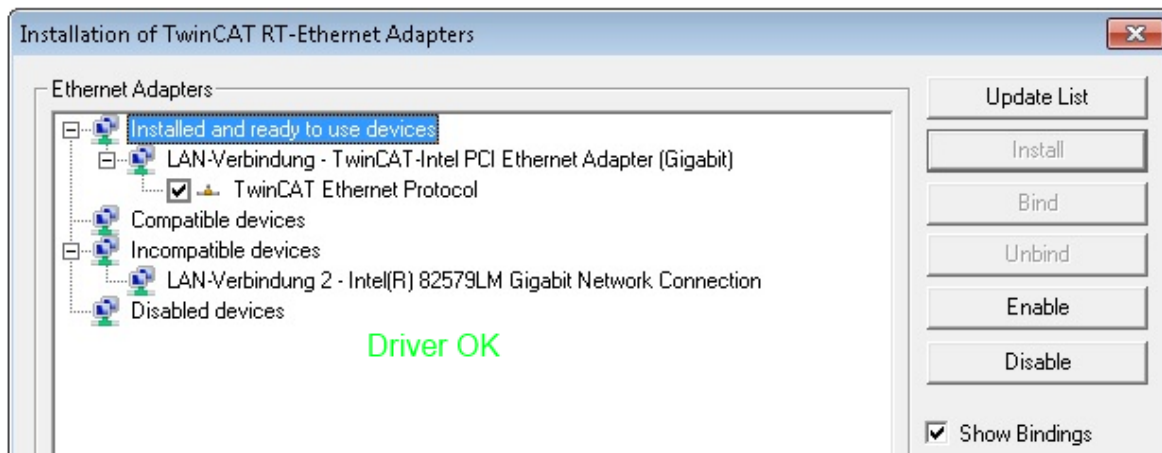

Fig. 76: Exemplary correct driver setting for the Ethernet port

Other possible settings have to be avoided:

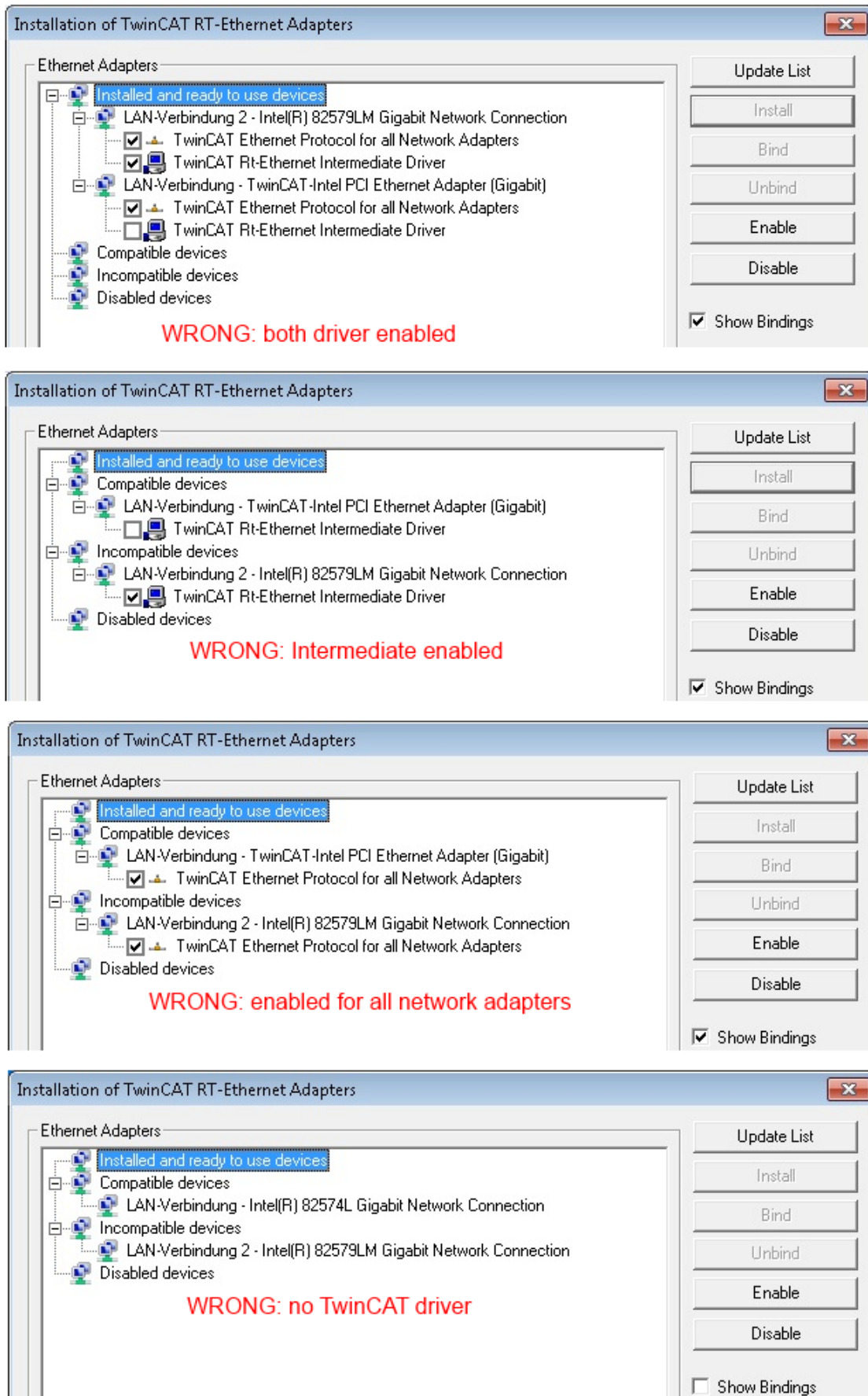

Fig. 77: Incorrect driver settings for the Ethernet port

IP address of the port used

● IP address/DHCP

i In most cases an Ethernet port that is configured as an EtherCAT device will not transport general IP packets. For this reason and in cases where an EL6601 or similar devices are used it is useful to specify a fixed IP address for this port via the “Internet Protocol TCP/IP” driver setting and to disable DHCP. In this way the delay associated with the DHCP client for the Ethernet port assigning itself a default IP address in the absence of a DHCP server is avoided. A suitable address space is 192.168.x.x, for example.

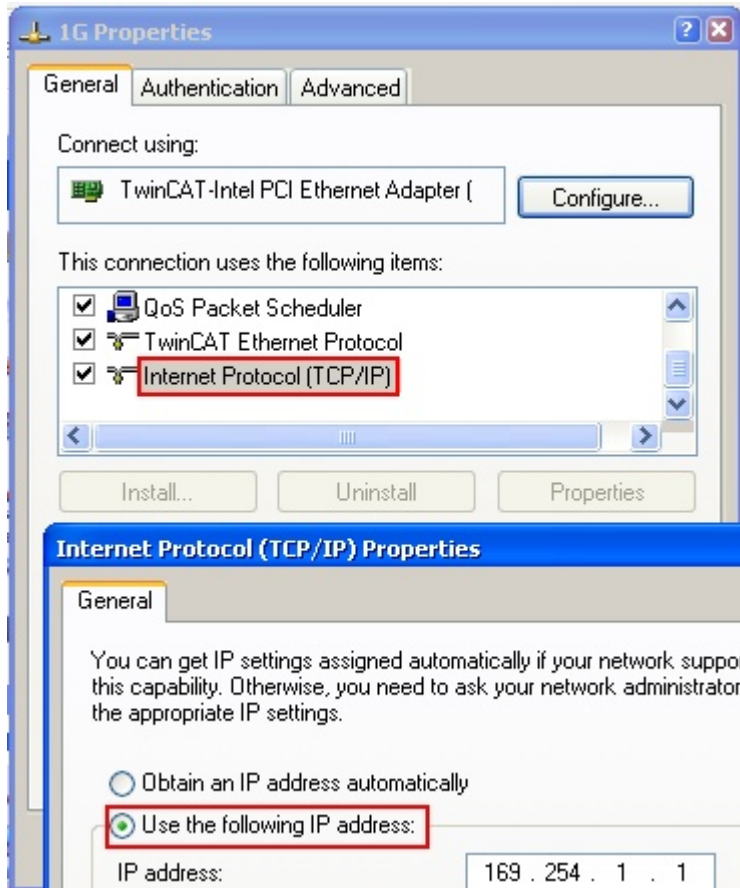

Fig. 78: TCP/IP setting for the Ethernet port

6.2.2 Notes regarding ESI device description

Installation of the latest ESI device description

The TwinCAT EtherCAT master/System Manager needs the device description files for the devices to be used in order to generate the configuration in online or offline mode. The device descriptions are contained in the so-called ESI files (EtherCAT Slave Information) in XML format. These files can be requested from the respective manufacturer and are made available for download. An *.xml file may contain several device descriptions.

The ESI files for Beckhoff EtherCAT devices are available on the [Beckhoff website](#).

The ESI files should be stored in the TwinCAT installation directory.

Default settings:

- **TwinCAT 2:** C:\TwinCAT\IO\EtherCAT
- **TwinCAT 3:** C:\TwinCAT\3.1\Config\Io\EtherCAT

The files are read (once) when a new System Manager window is opened, if they have changed since the last time the System Manager window was opened.

A TwinCAT installation includes the set of Beckhoff ESI files that was current at the time when the TwinCAT build was created.

For TwinCAT 2.11/TwinCAT 3 and higher, the ESI directory can be updated from the System Manager, if the programming PC is connected to the Internet; by

- **TwinCAT 2:** Option → “Update EtherCAT Device Descriptions”
- **TwinCAT 3:** TwinCAT → EtherCAT Devices → “Update Device Descriptions (via ETG Website)...”

The [TwinCAT ESI Updater \[▶ 90\]](#) is available for this purpose.



ESI

The *.xml files are associated with *.xsd files, which describe the structure of the ESI XML files. To update the ESI device descriptions, both file types should therefore be updated.

Device differentiation

EtherCAT devices/slaves are distinguished by four properties, which determine the full device identifier. For example, the device identifier EL2521-0025-1018 consists of:

- family key “EL”
- name “2521”
- type “0025”
- and revision “1018”

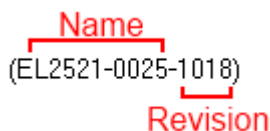

Fig. 79: Identifier structure

The order identifier consisting of name + type (here: EL2521-0025) describes the device function. The revision indicates the technical progress and is managed by Beckhoff. In principle, a device with a higher revision can replace a device with a lower revision, unless specified otherwise, e.g. in the documentation. Each revision has its own ESI description. See [further notes \[▶ 10\]](#).

Online description

If the EtherCAT configuration is created online through scanning of real devices (see section Online setup) and no ESI descriptions are available for a slave (specified by name and revision) that was found, the System Manager asks whether the description stored in the device should be used. In any case, the System Manager needs this information for setting up the cyclic and acyclic communication with the slave correctly.

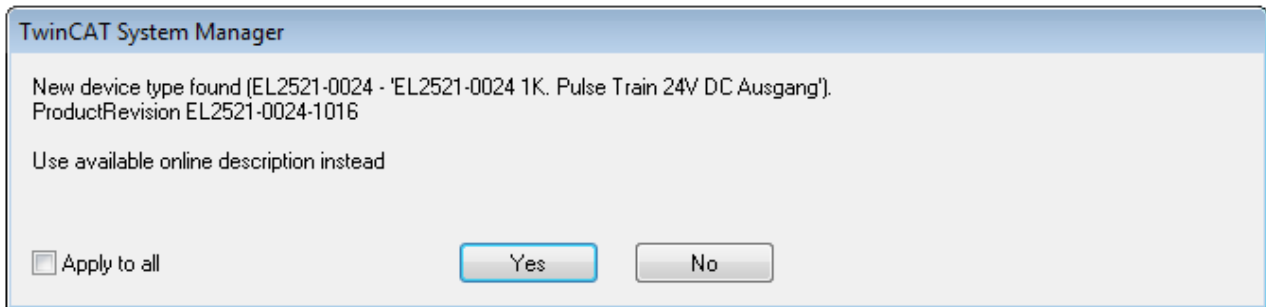

Fig. 80: OnlineDescription information window (TwinCAT 2)

In TwinCAT 3 a similar window appears, which also offers the Web update:

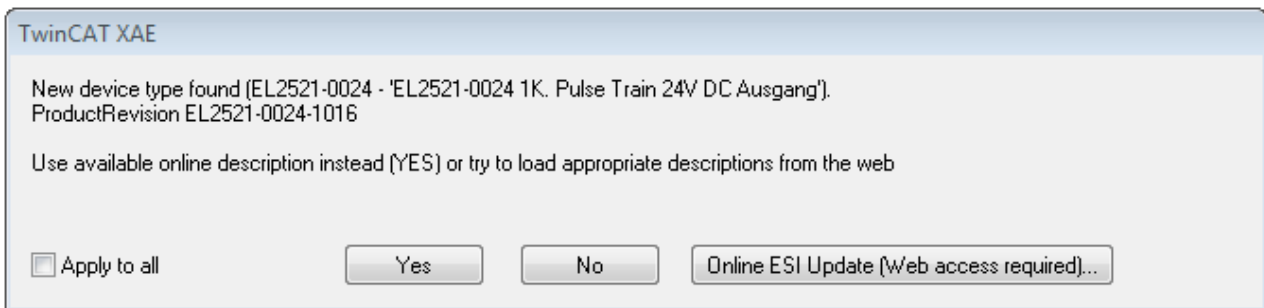

Fig. 81: Information window OnlineDescription (TwinCAT 3)

If possible, the Yes is to be rejected and the required ESI is to be requested from the device manufacturer. After installation of the XML/XSD file the configuration process should be repeated.

NOTICE

Changing the “usual” configuration through a scan

- ✓ If a scan discovers a device that is not yet known to TwinCAT, distinction has to be made between two cases. Taking the example here of the EL2521-0000 in the revision 1019
 - a) no ESI is present for the EL2521-0000 device at all, either for the revision 1019 or for an older revision. The ESI must then be requested from the manufacturer (in this case Beckhoff).
 - b) an ESI is present for the EL2521-0000 device, but only in an older revision, e.g. 1018 or 1017. In this case an in-house check should first be performed to determine whether the spare parts stock allows the integration of the increased revision into the configuration at all. A new/higher revision usually also brings along new features. If these are not to be used, work can continue without reservations with the previous revision 1018 in the configuration. This is also stated by the Beckhoff compatibility rule.

Refer in particular to the chapter “[General notes on the use of Beckhoff EtherCAT IO components](#)” and for manual configuration to the chapter “[Offline configuration creation \[▶ 91\]](#)”.

If the OnlineDescription is used regardless, the System Manager reads a copy of the device description from the EEPROM in the EtherCAT slave. In complex slaves the size of the EEPROM may not be sufficient for the complete ESI, in which case the ESI would be *incomplete* in the configurator. Therefore it’s recommended using an offline ESI file with priority in such a case.

The System Manager creates for online recorded device descriptions a new file “OnlineDescription0000...xml” in its ESI directory, which contains all ESI descriptions that were read online.

OnlineDescriptionCache00000002.xml

Fig. 82: File OnlineDescription.xml created by the System Manager

If a slave desired to be added manually to the configuration at a later stage, online created slaves are indicated by a prepended symbol ">" in the selection list (see Figure *Indication of an online recorded ESI of EL2521 as an example*).

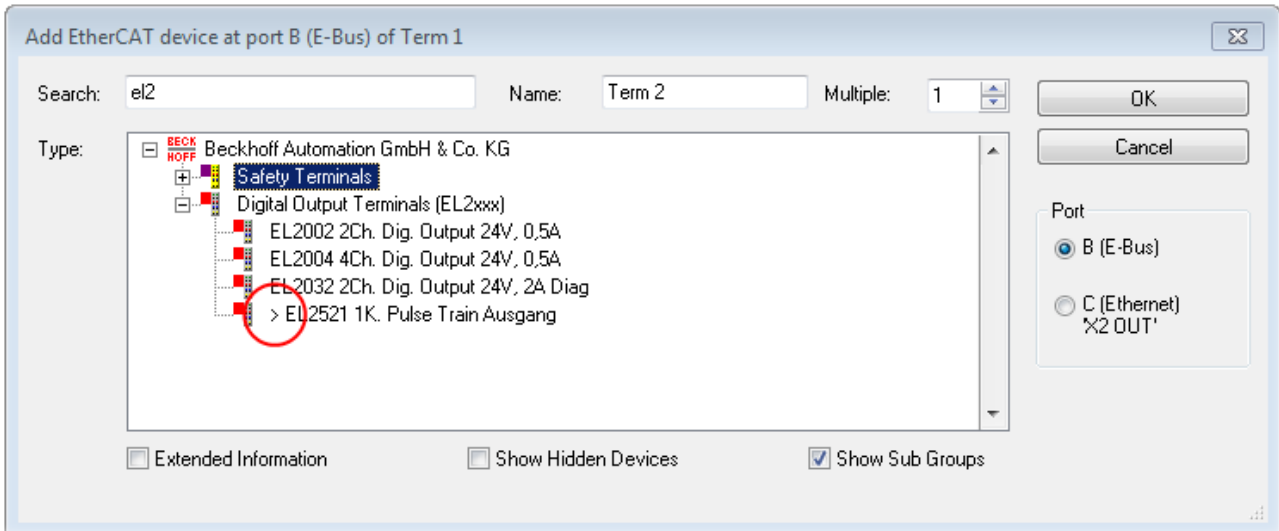

Fig. 83: Indication of an online recorded ESI of EL2521 as an example

If such ESI files are used and the manufacturer's files become available later, the file OnlineDescription.xml should be deleted as follows:

- close all System Manager windows
- restart TwinCAT in Config mode
- delete "OnlineDescription0000...xml"
- restart TwinCAT System Manager

This file should not be visible after this procedure, if necessary press <F5> to update

i OnlineDescription for TwinCAT 3.x

In addition to the file described above "OnlineDescription0000...xml", a so called EtherCAT cache with new discovered devices is created by TwinCAT 3.x, e.g. under Windows 7:

`C:\User\[USERNAME]\AppData\Roaming\Beckhoff\TwinCAT3\Components\Base\EtherCATCache.xml`

(Please note the language settings of the OS!)

You have to delete this file, too.

Faulty ESI file

If an ESI file is faulty and the System Manager is unable to read it, the System Manager brings up an information window.

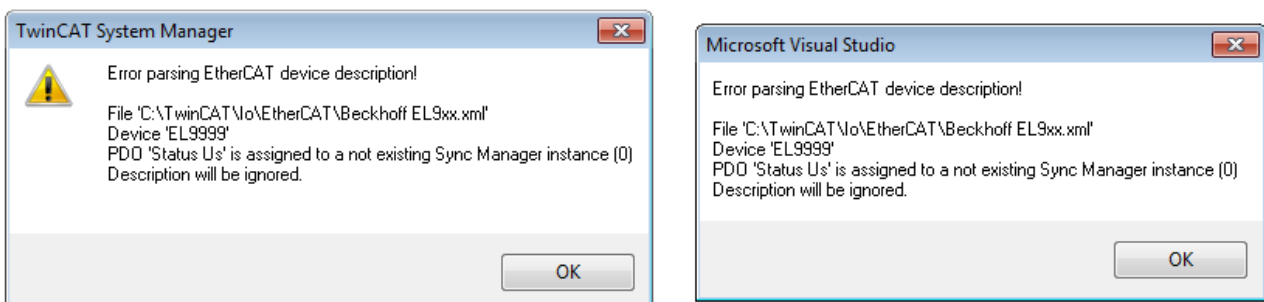

Fig. 84: Information window for faulty ESI file (left: TwinCAT 2; right: TwinCAT 3)

Reasons may include:

- Structure of the *.xml does not correspond to the associated *.xsd file → check your schematics
- Contents cannot be translated into a device description → contact the file manufacturer

6.2.3 TwinCAT ESI Updater

For TwinCAT 2.11 and higher, the System Manager can search for current Beckhoff ESI files automatically, if an online connection is available:

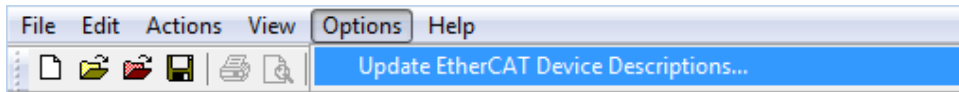

Fig. 85: Using the ESI Updater (>= TwinCAT 2.11)

The call up takes place under:
“Options” → “Update EtherCAT Device Descriptions”

Selection under TwinCAT 3:

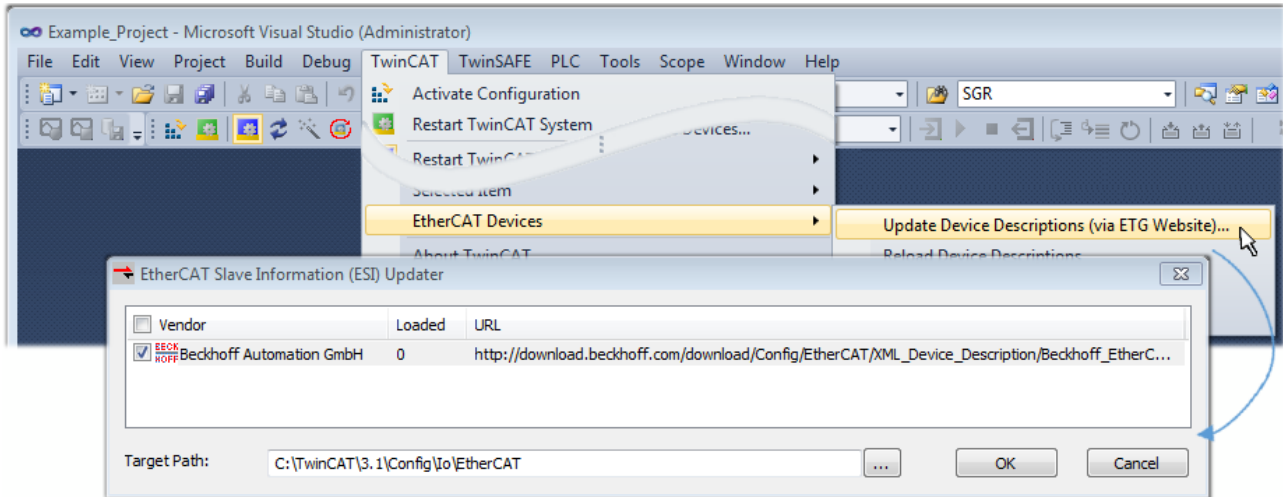

Fig. 86: Using the ESI Updater (TwinCAT 3)

The ESI Updater (TwinCAT 3) is a convenient option for automatic downloading of ESI data provided by EtherCAT manufacturers via the Internet into the TwinCAT directory (ESI = EtherCAT slave information). TwinCAT accesses the central ESI ULR directory list stored at ETG; the entries can then be viewed in the Updater dialog, although they cannot be changed there.

The call up takes place under:
“TwinCAT” → “EtherCAT Devices” → “Update Device Description (via ETG Website)...”.

6.2.4 Distinction between Online and Offline

The distinction between online and offline refers to the presence of the actual I/O environment (drives, terminals, EJ-modules). If the configuration is to be prepared in advance of the system configuration as a programming system, e.g. on a laptop, this is only possible in “Offline configuration” mode. In this case all components have to be entered manually in the configuration, e.g. based on the electrical design.

If the designed control system is already connected to the EtherCAT system and all components are energised and the infrastructure is ready for operation, the TwinCAT configuration can simply be generated through “scanning” from the runtime system. This is referred to as online configuration.

In any case, during each startup the EtherCAT master checks whether the slaves it finds match the configuration. This test can be parameterised in the extended slave settings. Refer to [note “Installation of the latest ESI-XML device description” \[▶ 86\]](#).

For preparation of a configuration:

- the real EtherCAT hardware (devices, couplers, drives) must be present and installed
- the devices/modules must be connected via EtherCAT cables or in the terminal/ module strand in the same way as they are intended to be used later
- the devices/modules be connected to the power supply and ready for communication

- TwinCAT must be in CONFIG mode on the target system.

The online scan process consists of:

- detecting the EtherCAT device [▶ 96] (Ethernet port at the IPC)
- detecting the connected EtherCAT devices [▶ 97]. This step can be carried out independent of the preceding step
- troubleshooting [▶ 100]

The scan with existing configuration [▶ 101] can also be carried out for comparison.

6.2.5 OFFLINE configuration creation

Creating the EtherCAT device

Create an EtherCAT device in an empty System Manager window.

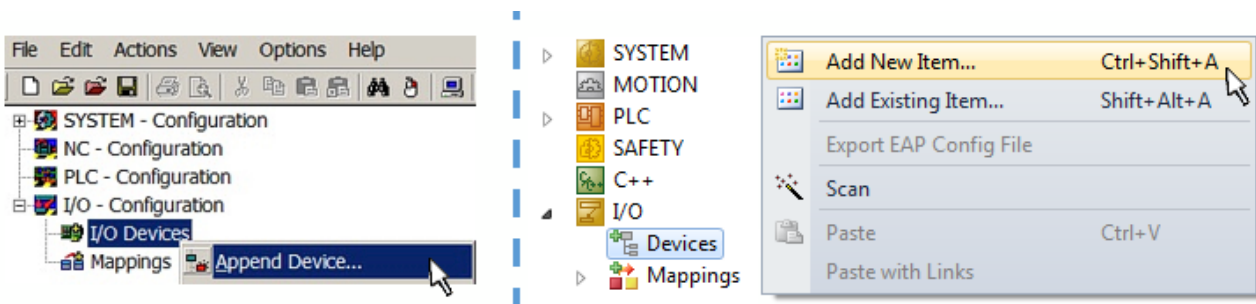

Fig. 87: Append EtherCAT device (left: TwinCAT 2; right: TwinCAT 3)

Select type “EtherCAT” for an EtherCAT I/O application with EtherCAT slaves. For the present publisher/ subscriber service in combination with an EL6601/EL6614 terminal select “EtherCAT Automation Protocol via EL6601”.

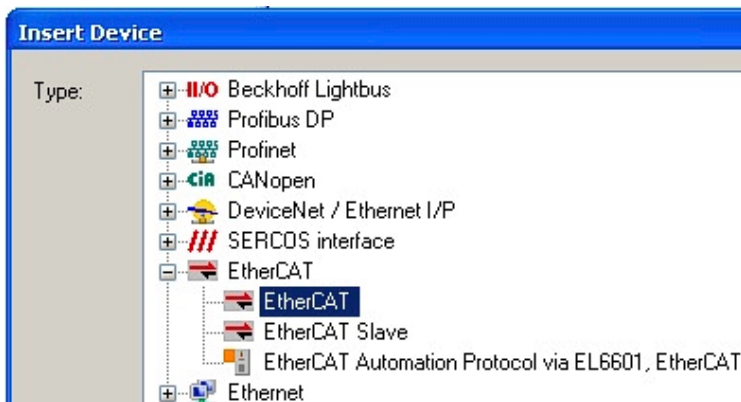

Fig. 88: Selecting the EtherCAT connection (TwinCAT 2.11, TwinCAT 3)

Then assign a real Ethernet port to this virtual device in the runtime system.

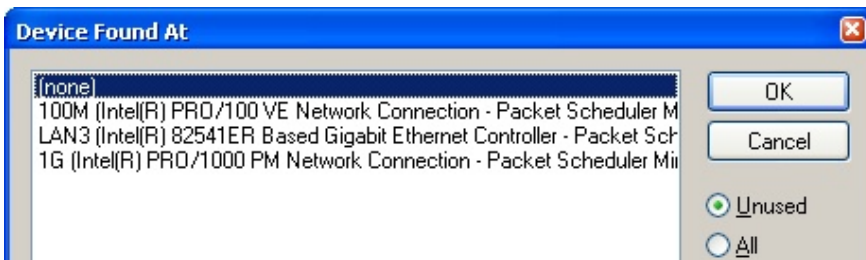

Fig. 89: Selecting the Ethernet port

This query may appear automatically when the EtherCAT device is created, or the assignment can be set/modified later in the properties dialog; see Fig. “EtherCAT device properties (TwinCAT 2)”.

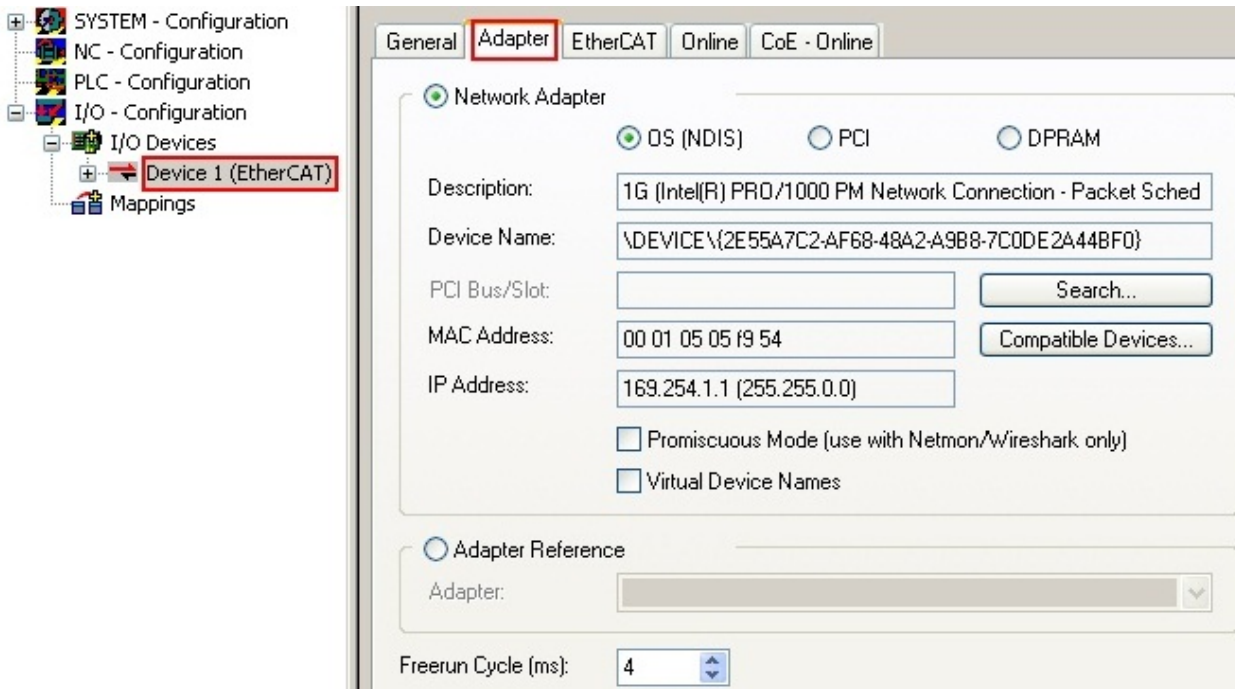
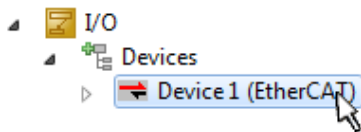

Fig. 90: EtherCAT device properties (TwinCAT 2)

TwinCAT 3: the properties of the EtherCAT device can be opened by double click on “Device .. (EtherCAT)” within the Solution Explorer under “I/O”:



i **Selecting the Ethernet port**

Ethernet ports can only be selected for EtherCAT devices for which the TwinCAT real-time driver is installed. This has to be done separately for each port. Please refer to the respective [installation page \[▶ 80\]](#).

Defining EtherCAT slaves

Further devices can be appended by right-clicking on a device in the configuration tree.

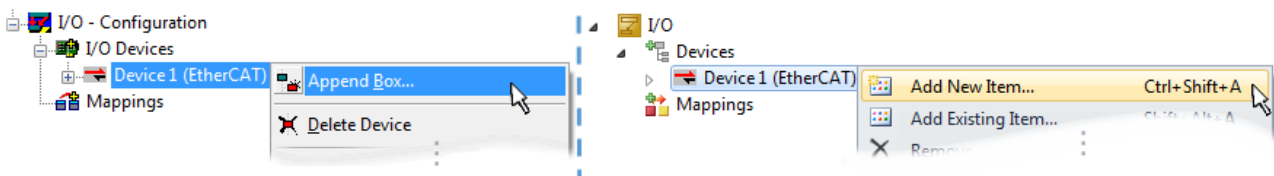

Fig. 91: Appending EtherCAT devices (left: TwinCAT 2; right: TwinCAT 3)

The dialog for selecting a new device opens. Only devices for which ESI files are available are displayed.

Only devices are offered for selection that can be appended to the previously selected device. Therefore, the physical layer available for this port is also displayed (Fig. “Selection dialog for new EtherCAT device”, A). In the case of cable-based Fast-Ethernet physical layer with PHY transfer, then also only cable-based devices are available, as shown in Fig. “Selection dialog for new EtherCAT device”. If the preceding device has several free ports (e.g. EK1122 or EK1100), the required port can be selected on the right-hand side (A).

Overview of physical layer

- “Ethernet”: cable-based 100BASE-TX: couplers, box modules, devices with RJ45/M8/M12 connector

- “E-Bus”: LVDS “terminal bus”, EtherCAT plug-in modules (EJ), EtherCAT terminals (EL/ES), various modular modules

The search field facilitates finding specific devices (since TwinCAT 2.11 or TwinCAT 3).

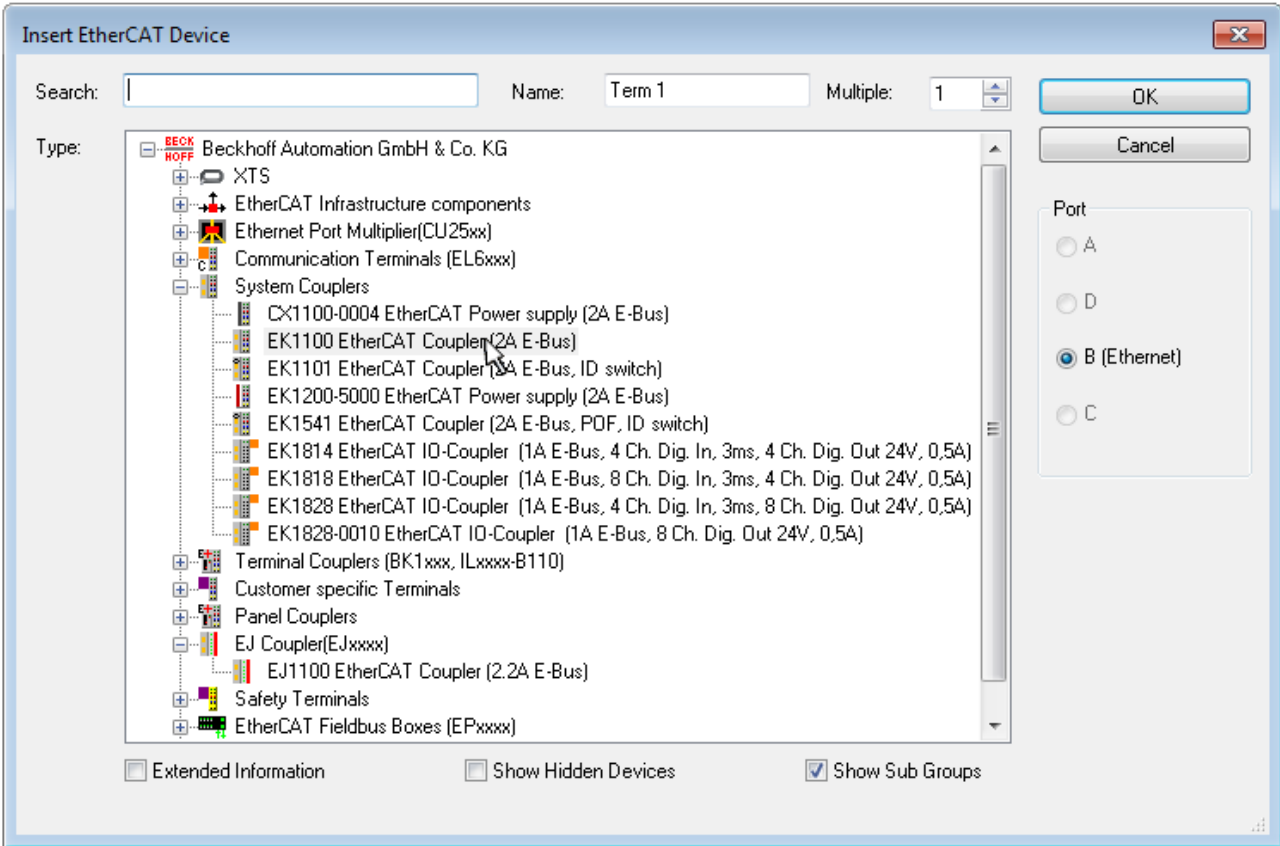

Fig. 92: Selection dialog for new EtherCAT device

By default, only the name/device type is used as selection criterion. For selecting a specific revision of the device, the revision can be displayed as “Extended Information”.

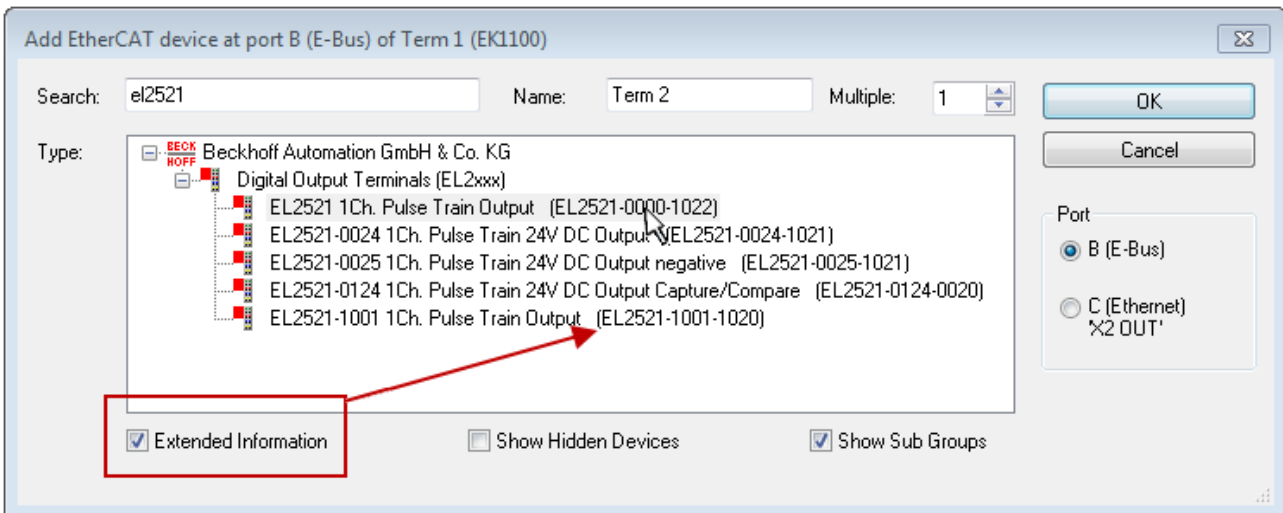

Fig. 93: Display of device revision

In many cases several device revisions were created for historic or functional reasons, e.g. through technological advancement. For simplification purposes (see Fig. “Selection dialog for new EtherCAT device”) only the last (i.e. highest) revision and therefore the latest state of production is displayed in the selection dialog for Beckhoff devices. To show all device revisions available in the system as ESI descriptions tick the “Show Hidden Devices” check box, see Fig. “Display of previous revisions”.

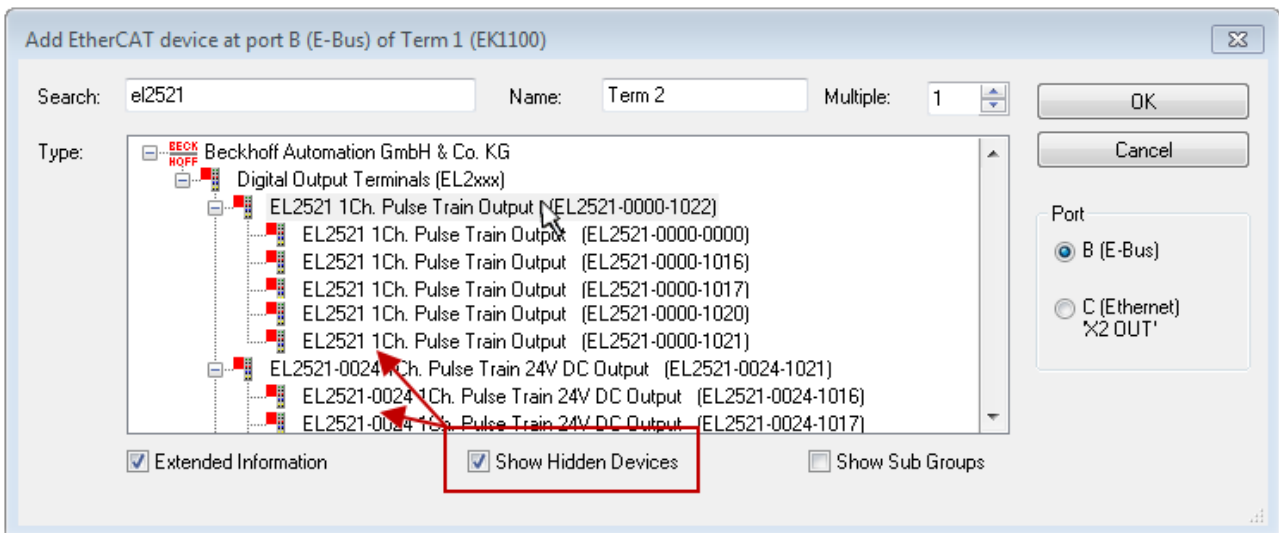

Fig. 94: Display of previous revisions

● Device selection based on revision, compatibility

i The ESI description also defines the process image, the communication type between master and slave/device and the device functions, if applicable. The physical device (firmware, if available) has to support the communication queries/settings of the master. This is backward compatible, i.e. newer devices (higher revision) should be supported if the EtherCAT master addresses them as an older revision. The following compatibility rule of thumb is to be assumed for Beckhoff EtherCAT Terminals/ Boxes/ EJ-modules:

device revision in the system \geq device revision in the configuration

This also enables subsequent replacement of devices without changing the configuration (different specifications are possible for drives).

Example

If an EL2521-0025-**1018** is specified in the configuration, an EL2521-0025-**1018** or higher (**-1019**, **-1020**) can be used in practice.

Name
(EL2521-0025-1018)
Revision

Fig. 95: Name/revision of the terminal

If current ESI descriptions are available in the TwinCAT system, the last revision offered in the selection dialog matches the Beckhoff state of production. It is recommended to use the last device revision when creating a new configuration, if current Beckhoff devices are used in the real application. Older revisions should only be used if older devices from stock are to be used in the application.

In this case the process image of the device is shown in the configuration tree and can be parameterized as follows: linking with the task, CoE/DC settings, plug-in definition, startup settings, ...

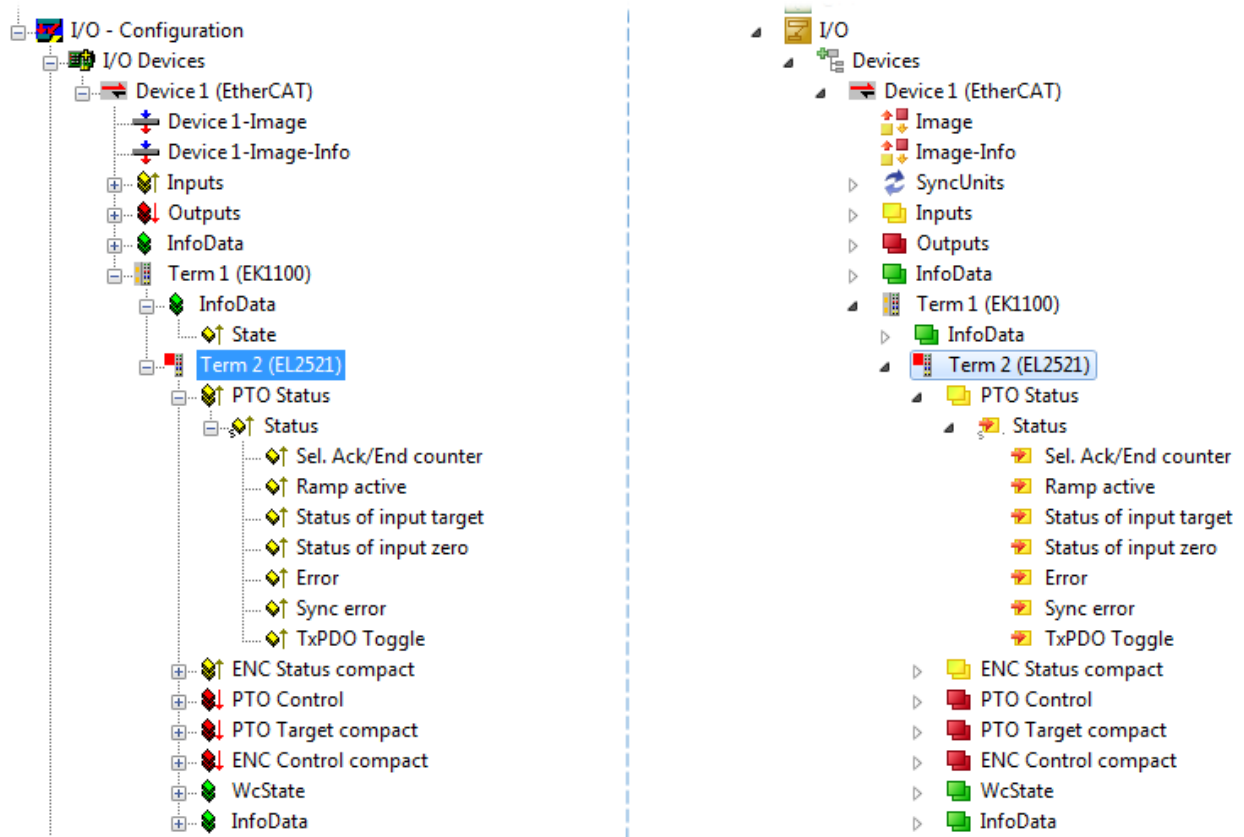



Fig. 96: EtherCAT terminal in the TwinCAT tree (left: TwinCAT 2; right: TwinCAT 3)



6.2.6 ONLINE configuration creation

Detecting/scanning of the EtherCAT device

The online device search can be used if the TwinCAT system is in CONFIG mode. This can be indicated by a symbol right below in the information bar:



- on TwinCAT 2 by a blue display “Config Mode” within the System Manager window:  .
- on TwinCAT 3 within the user interface of the development environment by a symbol  .

TwinCAT can be set into this mode:

- TwinCAT 2: by selection of  in the Menubar or by “Actions” → “Set/Reset TwinCAT to Config Mode...”
- TwinCAT 3: by selection of  in the Menubar or by “TwinCAT” → “Restart TwinCAT (Config Mode)”

● Online scanning in Config mode

i The online search is not available in RUN mode (production operation). Note the differentiation between TwinCAT programming system and TwinCAT target system.

The TwinCAT 2 icon () or TwinCAT 3 icon () within the Windows-Taskbar always shows the TwinCAT mode of the local IPC. Compared to that, the System Manager window of TwinCAT 2 or the user interface of TwinCAT 3 indicates the state of the target system.

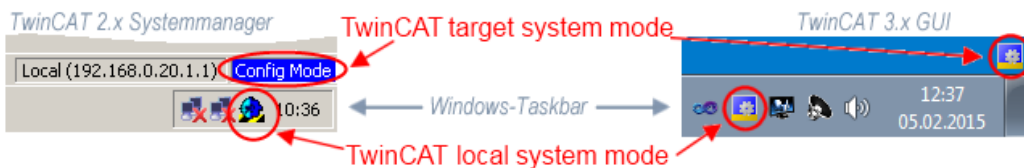

Fig. 97: Differentiation local/target system (left: TwinCAT 2; right: TwinCAT 3)

Right-clicking on “I/O Devices” in the configuration tree opens the search dialog.

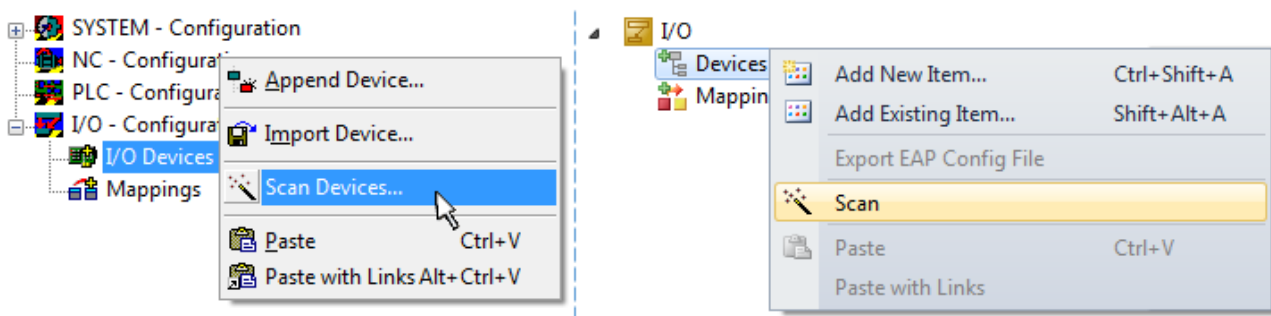

Fig. 98: Scan Devices (left: TwinCAT 2; right: TwinCAT 3)

This scan mode attempts to find not only EtherCAT devices (or Ethernet ports that are usable as such), but also NOVDRAM, fieldbus cards, SMB etc. However, not all devices can be found automatically.

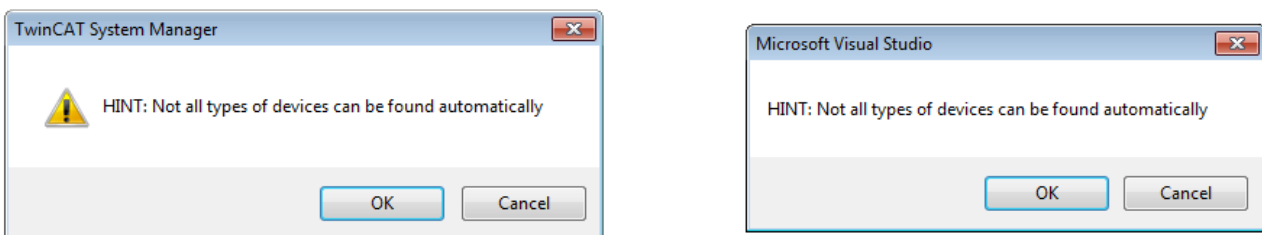

Fig. 99: Note for automatic device scan (left: TwinCAT 2; right: TwinCAT 3)

Ethernet ports with installed TwinCAT real-time driver are shown as “RT Ethernet” devices. An EtherCAT frame is sent to these ports for testing purposes. If the scan agent detects from the response that an EtherCAT slave is connected, the port is immediately shown as an “EtherCAT Device” .

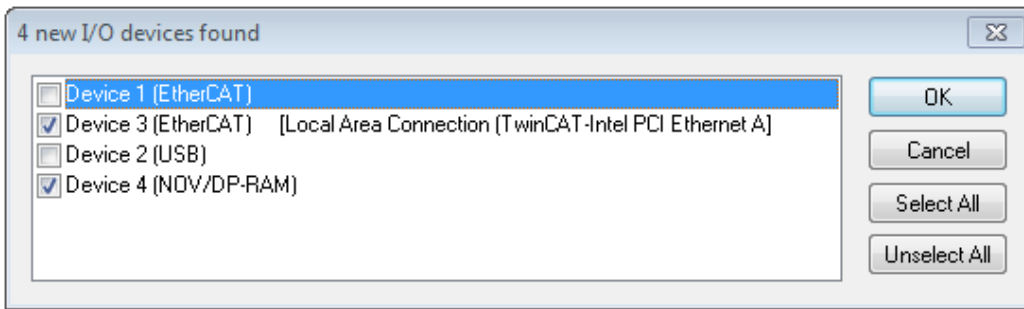

Fig. 100: Detected Ethernet devices

Via respective checkboxes devices can be selected (as illustrated in Fig. “Detected Ethernet devices” e.g. Device 3 and Device 4 were chosen). After confirmation with “OK” a device scan is suggested for all selected devices, see Fig.: “Scan query after automatic creation of an EtherCAT device”.

● Selecting the Ethernet port



Ethernet ports can only be selected for EtherCAT devices for which the TwinCAT real-time driver is installed. This has to be done separately for each port. Please refer to the respective [installation page](#) [▶ 80].

Detecting/Scanning the EtherCAT devices

● Online scan functionality



During a scan the master queries the identity information of the EtherCAT slaves from the slave EEPROM. The name and revision are used for determining the type. The respective devices are located in the stored ESI data and integrated in the configuration tree in the default state defined there.

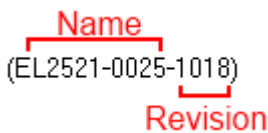

Fig. 101: Example default state

NOTICE

Slave scanning in practice in series machine production

The scanning function should be used with care. It is a practical and fast tool for creating an initial configuration as a basis for commissioning. In series machine production or reproduction of the plant, however, the function should no longer be used for the creation of the configuration, but if necessary for [comparison](#) [▶ 101] with the defined initial configuration. Background: since Beckhoff occasionally increases the revision version of the delivered products for product maintenance reasons, a configuration can be created by such a scan which (with an identical machine construction) is identical according to the device list; however, the respective device revision may differ from the initial configuration.

Example:

Company A builds the prototype of a machine B, which is to be produced in series later on. To do this the prototype is built, a scan of the IO devices is performed in TwinCAT and the initial configuration “B.tsm” is created. The EL2521-0025 EtherCAT terminal with the revision 1018 is located somewhere. It is thus built into the TwinCAT configuration in this way:

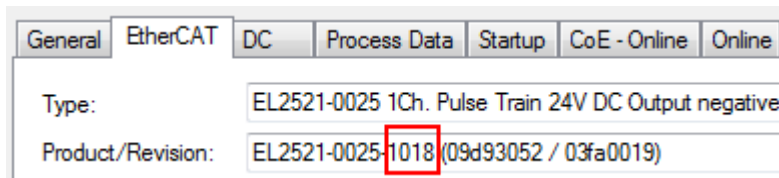

Fig. 102: Installing EtherCAT terminal with revision -1018

Likewise, during the prototype test phase, the functions and properties of this terminal are tested by the programmers/commissioning engineers and used if necessary, i.e. addressed from the PLC “B.pro” or the NC. (the same applies correspondingly to the TwinCAT 3 solution files).

The prototype development is now completed and series production of machine B starts, for which Beckhoff continues to supply the EL2521-0025-0018. If the commissioning engineers of the series machine production department always carry out a scan, a B configuration with the identical contents results again for each machine. Likewise, A might create spare parts stores worldwide for the coming series-produced machines with EL2521-0025-1018 terminals.

After some time Beckhoff extends the EL2521-0025 by a new feature C. Therefore the FW is changed, outwardly recognizable by a higher FW version and a **new revision -1019**. Nevertheless the new device naturally supports functions and interfaces of the predecessor version(s); an adaptation of “B.tsm” or even “B.pro” is therefore unnecessary. The series-produced machines can continue to be built with “B.tsm” and “B.pro”; it makes sense to perform a comparative scan [► 101] against the initial configuration “B.tsm” in order to check the built machine.

However, if the series machine production department now doesn't use “B.tsm”, but instead carries out a scan to create the productive configuration, the revision **-1019** is automatically detected and built into the configuration:

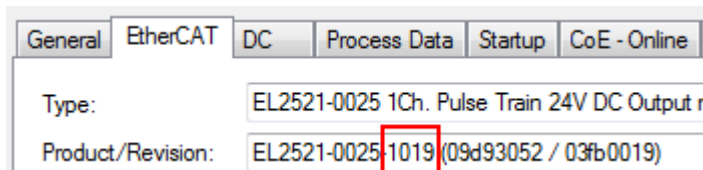

Fig. 103: Detection of EtherCAT terminal with revision -1019

This is usually not noticed by the commissioning engineers. TwinCAT cannot signal anything either, since a new configuration is essentially created. According to the compatibility rule, however, this means that no EL2521-0025-**1018** should be built into this machine as a spare part (even if this nevertheless works in the vast majority of cases).

In addition, it could be the case that, due to the development accompanying production in company A, the new feature C of the EL2521-0025-1019 (for example, an improved analog filter or an additional process data for the diagnosis) is discovered and used without in-house consultation. The previous stock of spare part devices are then no longer to be used for the new configuration “B2.tsm” created in this way. If series machine production is established, the scan should only be performed for informative purposes for comparison with a defined initial configuration. Changes are to be made with care!

If an EtherCAT device was created in the configuration (manually or through a scan), the I/O field can be scanned for devices/slaves.



Fig. 104: Scan query after automatic creation of an EtherCAT device (left: TwinCAT 2; right: TwinCAT 3)

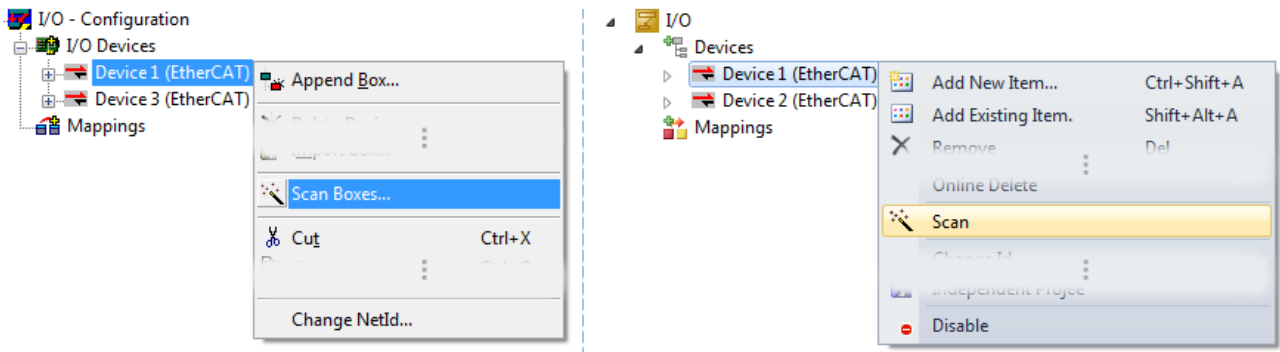

Fig. 105: Manual scanning for devices on a specified EtherCAT device (left: TwinCAT 2; right: TwinCAT 3)

In the System Manager (TwinCAT 2) or the User Interface (TwinCAT 3) the scan process can be monitored via the progress bar at the bottom in the status bar.



Fig. 106: Scan progress exemplary by TwinCAT 2

The configuration is established and can then be switched to online state (OPERATIONAL).

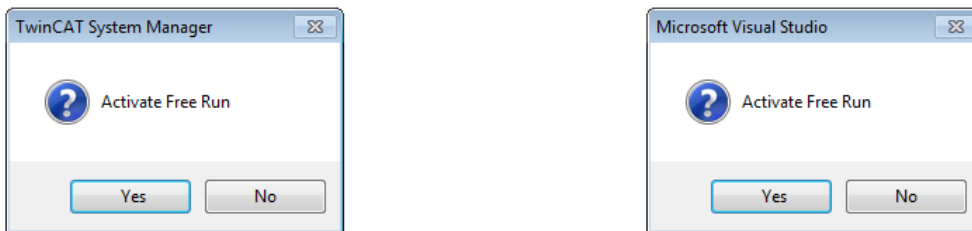

Fig. 107: Config/FreeRun query (left: TwinCAT 2; right: TwinCAT 3)

In Config/FreeRun mode the System Manager display alternates between blue and red, and the EtherCAT device continues to operate with the idling cycle time of 4 ms (default setting), even without active task (NC, PLC).



Fig. 108: Displaying of “Free Run” and “Config Mode” toggling right below in the status bar



Fig. 109: TwinCAT can also be switched to this state by using a button (left: TwinCAT 2; right: TwinCAT 3)

The EtherCAT system should then be in a functional cyclic state, as shown in Fig. *Online display example*.

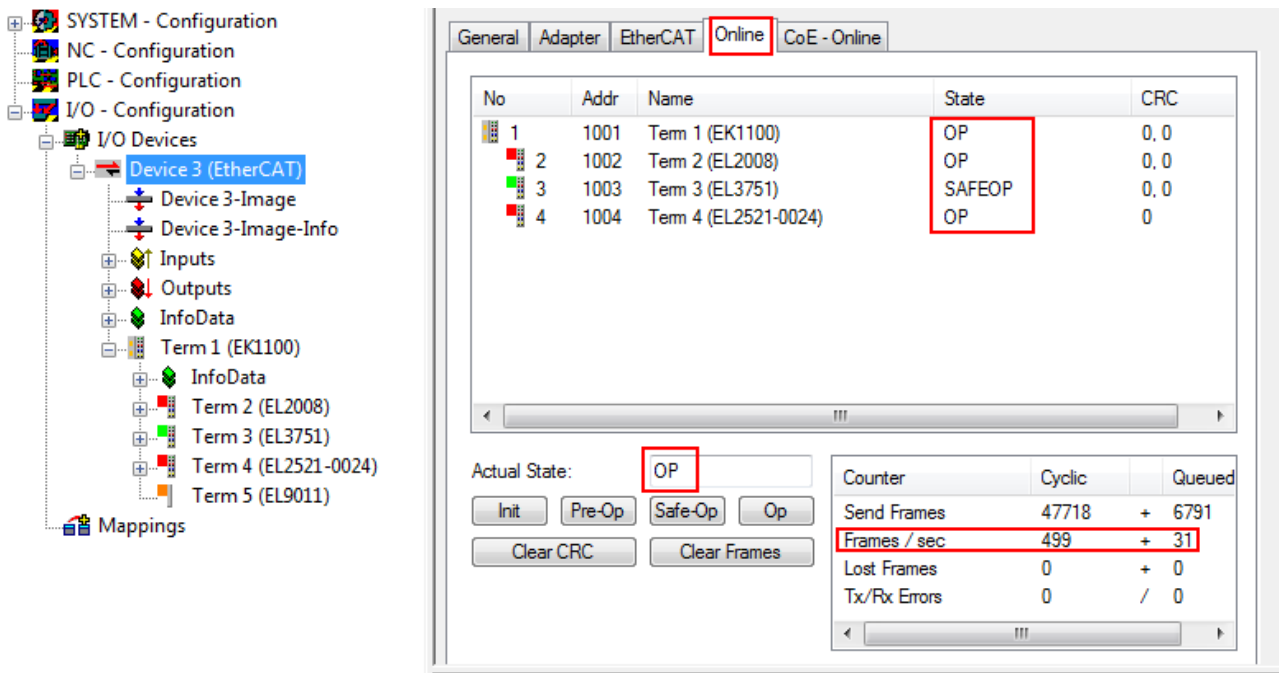

Fig. 110: Online display example

Please note:

- all slaves should be in OP state
- the EtherCAT master should be in “Actual State” OP
- “frames/sec” should match the cycle time taking into account the sent number of frames
- no excessive “LostFrames” or CRC errors should occur

The configuration is now complete. It can be modified as described under [manual procedure \[► 91\]](#).

Troubleshooting

Various effects may occur during scanning.

- An **unknown device** is detected, i.e. an EtherCAT slave for which no ESI XML description is available. In this case the System Manager offers to read any ESI that may be stored in the device. This case is described in the chapter “Notes regarding ESI device description”.
- **Device are not detected properly**
Possible reasons include:
 - faulty data links, resulting in data loss during the scan
 - slave has invalid device description

The connections and devices should be checked in a targeted manner, e.g. via the emergency scan. Then re-run the scan.

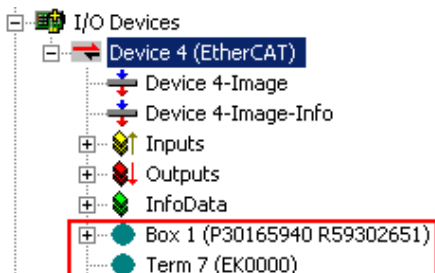

Fig. 111: Faulty identification

In the System Manager such devices may be set up as EK0000 or unknown devices. Operation is not possible or meaningful.

Scan over existing Configuration

NOTICE

Change of the configuration after comparison

With this scan (TwinCAT 2.11 or 3.1) only the device properties vendor (manufacturer), device name and revision are compared at present! A “ChangeTo” or “Copy” should only be carried out with care, taking into consideration the Beckhoff IO compatibility rule (see above). The device configuration is then replaced by the revision found; this can affect the supported process data and functions.

If a scan is initiated for an existing configuration, the actual I/O environment may match the configuration exactly or it may differ. This enables the configuration to be compared.



Fig. 112: Identical configuration (left: TwinCAT 2; right: TwinCAT 3)

If differences are detected, they are shown in the correction dialog, so that the user can modify the configuration as required.

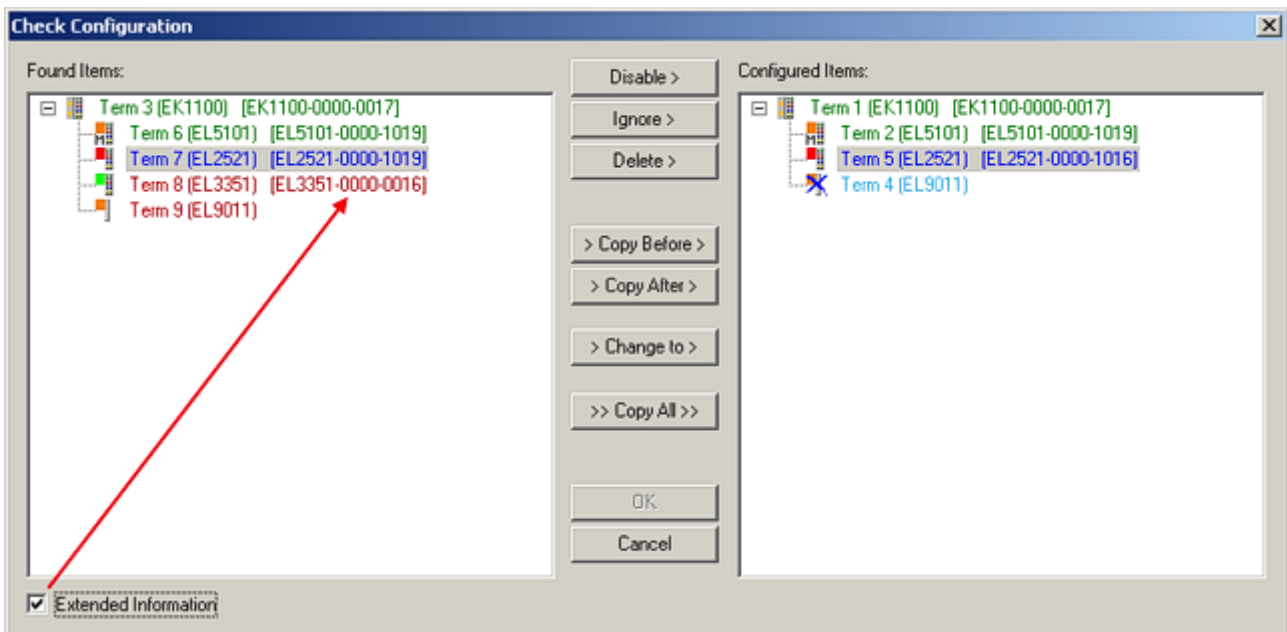

Fig. 113: Correction dialog

It is advisable to tick the “Extended Information” check box to reveal differences in the revision.

Color	Explanation
green	This EtherCAT slave matches the entry on the other side. Both type and revision match.
blue	This EtherCAT slave is present on the other side, but in a different revision. This other revision can have other default values for the process data as well as other/additional functions. If the found revision is higher than the configured revision, the slave may be used provided compatibility issues are taken into account. If the found revision is lower than the configured revision, it is likely that the slave cannot be used. The found device may not support all functions that the master expects based on the higher revision number.
light blue	This EtherCAT slave is ignored ("Ignore" button)
red	<ul style="list-style-type: none"> This EtherCAT slave is not present on the other side. It is present, but in a different revision, which also differs in its properties from the one specified. The compatibility principle then also applies here: if the found revision is higher than the configured revision, use is possible provided compatibility issues are taken into account, since the successor devices should support the functions of the predecessor devices. If the found revision is lower than the configured revision, it is likely that the slave cannot be used. The found device may not support all functions that the master expects based on the higher revision number.

i Device selection based on revision, compatibility

The ESI description also defines the process image, the communication type between master and slave/device and the device functions, if applicable. The physical device (firmware, if available) has to support the communication queries/settings of the master. This is backward compatible, i.e. newer devices (higher revision) should be supported if the EtherCAT master addresses them as an older revision. The following compatibility rule of thumb is to be assumed for Beckhoff EtherCAT Terminals/ Boxes/ EJ-modules:

device revision in the system >= device revision in the configuration

This also enables subsequent replacement of devices without changing the configuration (different specifications are possible for drives).

Example

If an EL2521-0025-**1018** is specified in the configuration, an EL2521-0025-**1018** or higher (**-1019**, **-1020**) can be used in practice.

Name
(EL2521-0025-1018)
Revision

Fig. 114: Name/revision of the terminal

If current ESI descriptions are available in the TwinCAT system, the last revision offered in the selection dialog matches the Beckhoff state of production. It is recommended to use the last device revision when creating a new configuration, if current Beckhoff devices are used in the real application. Older revisions should only be used if older devices from stock are to be used in the application.

In this case the process image of the device is shown in the configuration tree and can be parameterized as follows: linking with the task, CoE/DC settings, plug-in definition, startup settings, ...

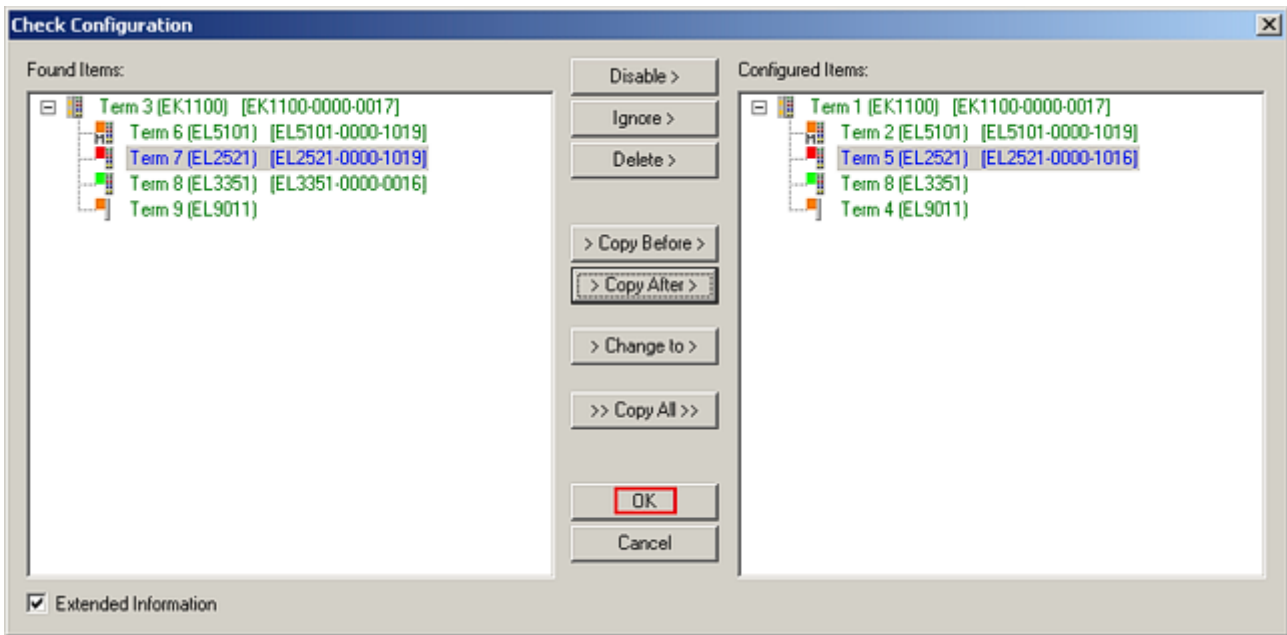

Fig. 115: Correction dialog with modifications

Once all modifications have been saved or accepted, click “OK” to transfer them to the real *.tsm configuration.

Change to Compatible Type

TwinCAT offers a function *Change to Compatible Type...* for the exchange of a device whilst retaining the links in the task.

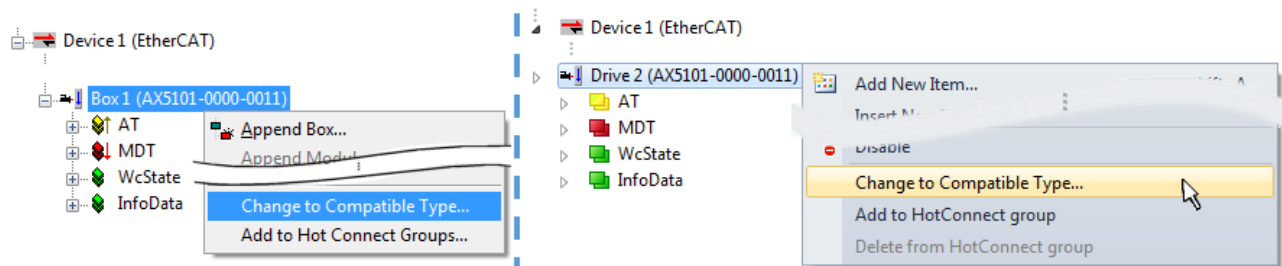

Fig. 116: Dialog “Change to Compatible Type...” (left: TwinCAT 2; right: TwinCAT 3)

The following elements in the ESI of an EtherCAT device are compared by TwinCAT and assumed to be the same in order to decide whether a device is indicated as "compatible":

- Physics (e.g. RJ45, Ebus...)
- FMMU (additional ones are allowed)
- SyncManager (SM, additional ones are allowed)
- EoE (attributes MAC, IP)
- CoE (attributes SdoInfo, PdoAssign, PdoConfig, PdoUpload, CompleteAccess)
- FoE
- PDO (process data: Sequence, SyncUnit SU, SyncManager SM, EntryCount, Entry.Datatype)

This function is preferably to be used on AX5000 devices.

Change to Alternative Type

The TwinCAT System Manager offers a function for the exchange of a device: Change to Alternative Type

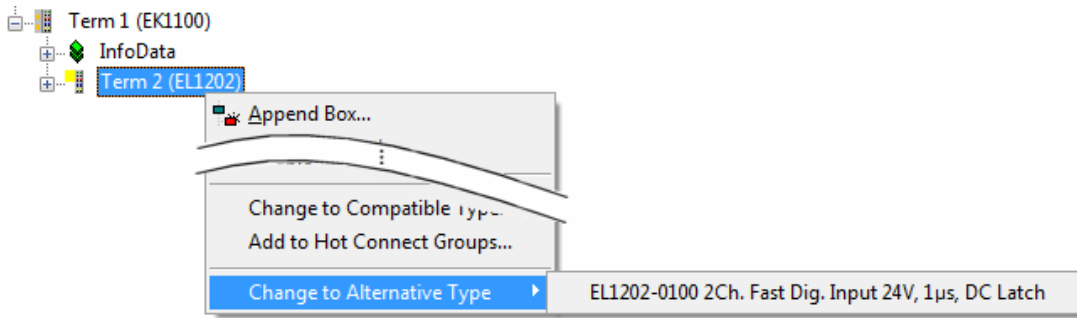

Fig. 117: TwinCAT 2 Dialog Change to Alternative Type

If called, the System Manager searches in the procured device ESI (in this example: EL1202-0000) for details of compatible devices contained there. The configuration is changed and the ESI-EEPROM is overwritten at the same time – therefore this process is possible only in the online state (ConfigMode).

6.2.7 EtherCAT subscriber configuration

In the left-hand window of the TwinCAT 2 System Manager or the Solution Explorer of the TwinCAT 3 Development Environment respectively, click on the element of the terminal within the tree you wish to configure (in the example: EL3751 Terminal 3).

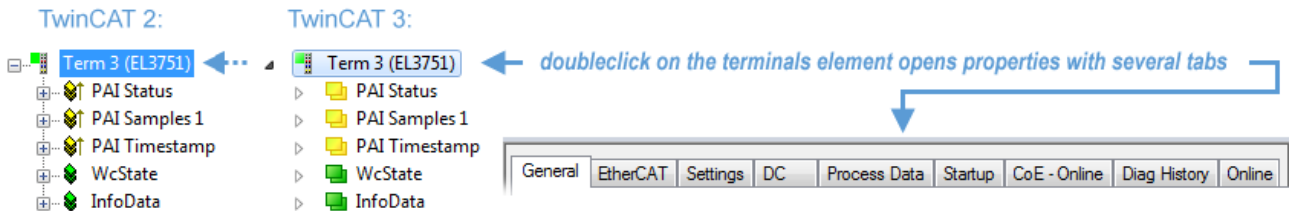

Fig. 118: Branch element as terminal EL3751

In the right-hand window of the TwinCAT System Manager (TwinCAT 2) or the Development Environment (TwinCAT 3), various tabs are now available for configuring the terminal. And yet the dimension of complexity of a subscriber determines which tabs are provided. Thus as illustrated in the example above the terminal EL3751 provides many setup options and also a respective number of tabs are available. On the contrary by the terminal EL1004 for example the tabs “General”, “EtherCAT”, “Process Data” and “Online” are available only. Several terminals, as for instance the EL6695 provide special functions by a tab with its own terminal name, so “EL6695” in this case. A specific tab “Settings” by terminals with a wide range of setup options will be provided also (e.g. EL3751).

“General” tab

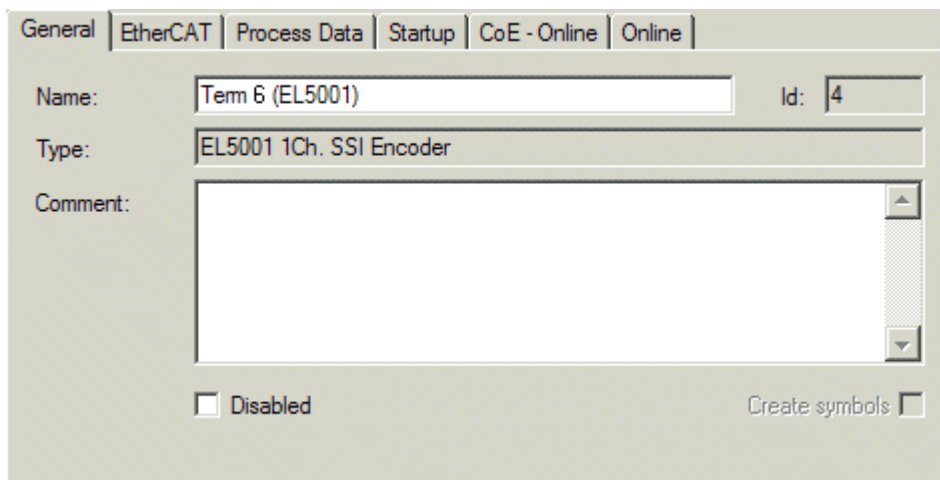

Fig. 119: “General” tab

Name	Name of the EtherCAT device
Id	Number of the EtherCAT device
Type	EtherCAT device type
Comment	Here you can add a comment (e.g. regarding the system).
Disabled	Here you can deactivate the EtherCAT device.
Create symbols	Access to this EtherCAT slave via ADS is only available if this control box is activated.

“EtherCAT” tab

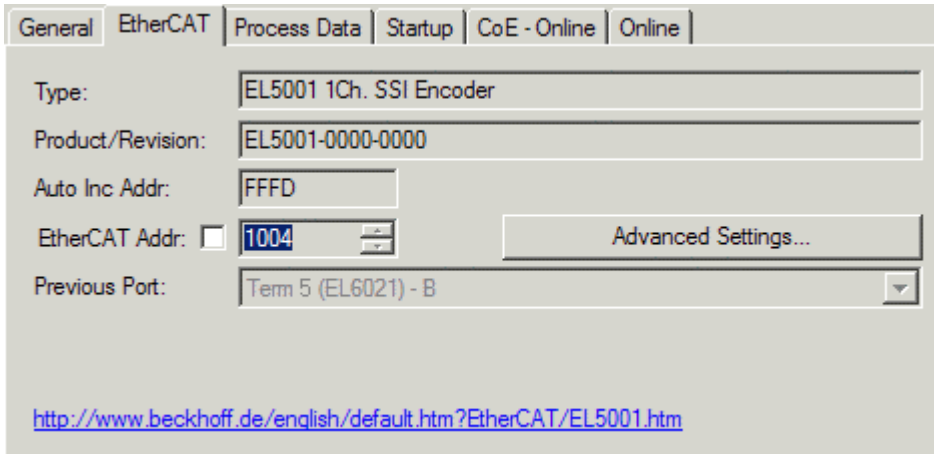

Fig. 120: “EtherCAT” tab

Type	EtherCAT device type
Product/Revision	Product and revision number of the EtherCAT device
Auto Inc Addr.	Auto increment address of the EtherCAT device. The auto increment address can be used for addressing each EtherCAT device in the communication ring through its physical position. Auto increment addressing is used during the start-up phase when the EtherCAT master allocates addresses to the EtherCAT devices. With auto increment addressing the first EtherCAT slave in the ring has the address 0000 _{hex} . For each further slave the address is decremented by 1 (FFFF _{hex} , FFFE _{hex} etc.).
EtherCAT Addr.	Fixed address of an EtherCAT slave. This address is allocated by the EtherCAT master during the start-up phase. Tick the control box to the left of the input field in order to modify the default value.
Previous Port	Name and port of the EtherCAT device to which this device is connected. If it is possible to connect this device with another one without changing the order of the EtherCAT devices in the communication ring, then this combination field is activated and the EtherCAT device to which this device is to be connected can be selected.
Advanced Settings	This button opens the dialogs for advanced settings.

The link at the bottom of the tab points to the product page for this EtherCAT device on the web.

“Process Data” tab

Indicates the configuration of the process data. The input and output data of the EtherCAT slave are represented as CANopen process data objects (**Process Data Objects, PDOs**). The user can select a PDO via PDO assignment and modify the content of the individual PDO via this dialog, if the EtherCAT slave supports this function.

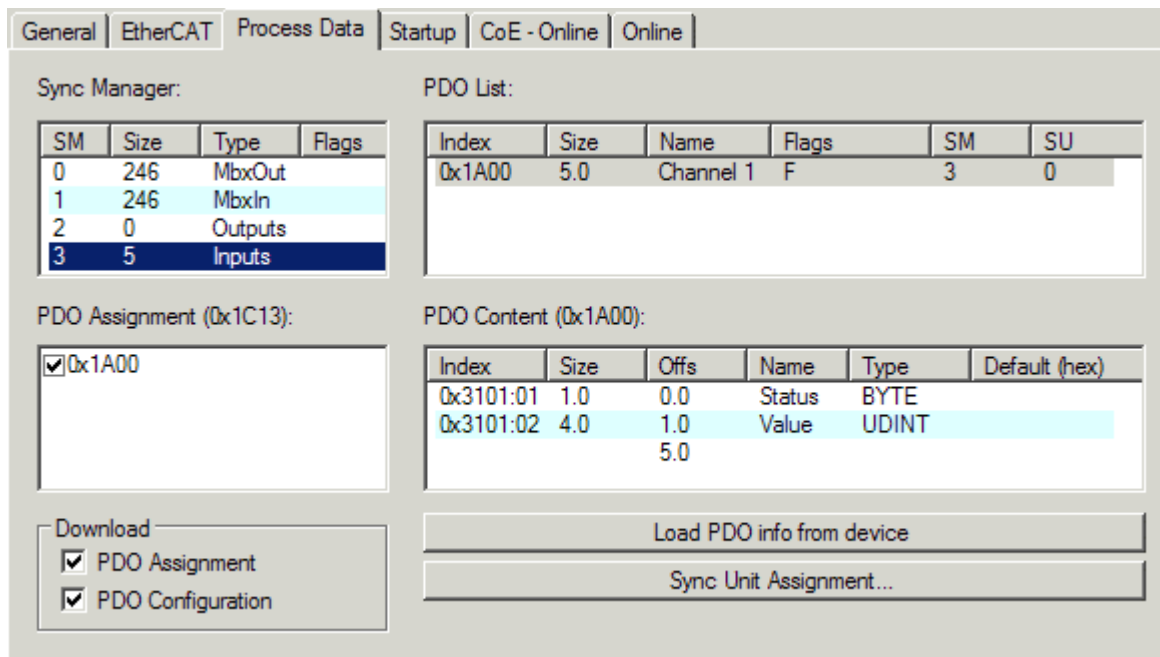

Fig. 121: "Process Data" tab

The process data (PDOs) transferred by an EtherCAT slave during each cycle are user data which the application expects to be updated cyclically or which are sent to the slave. To this end the EtherCAT master (Beckhoff TwinCAT) parameterizes each EtherCAT slave during the start-up phase to define which process data (size in bits/bytes, source location, transmission type) it wants to transfer to or from this slave. Incorrect configuration can prevent successful start-up of the slave.

For Beckhoff EtherCAT EL, ES, EM, EJ and EP slaves the following applies in general:

- The input/output process data supported by the device are defined by the manufacturer in the ESI/XML description. The TwinCAT EtherCAT Master uses the ESI description to configure the slave correctly.
- The process data can be modified in the System Manager. See the device documentation. Examples of modifications include: mask out a channel, displaying additional cyclic information, 16-bit display instead of 8-bit data size, etc.
- In so-called "intelligent" EtherCAT devices the process data information is also stored in the CoE directory. Any changes in the CoE directory that lead to different PDO settings prevent successful startup of the slave. It is not advisable to deviate from the designated process data, because the device firmware (if available) is adapted to these PDO combinations.

If the device documentation allows modification of process data, proceed as follows (see Figure *Configuring the process data*).

- A: select the device to configure
- B: in the "Process Data" tab select Input or Output under SyncManager (C)
- D: the PDOs can be selected or deselected
- H: the new process data are visible as linkable variables in the System Manager
The new process data are active once the configuration has been activated and TwinCAT has been restarted (or the EtherCAT master has been restarted)
- E: if a slave supports this, Input and Output PDO can be modified simultaneously by selecting a so-called PDO record ("predefined PDO settings").

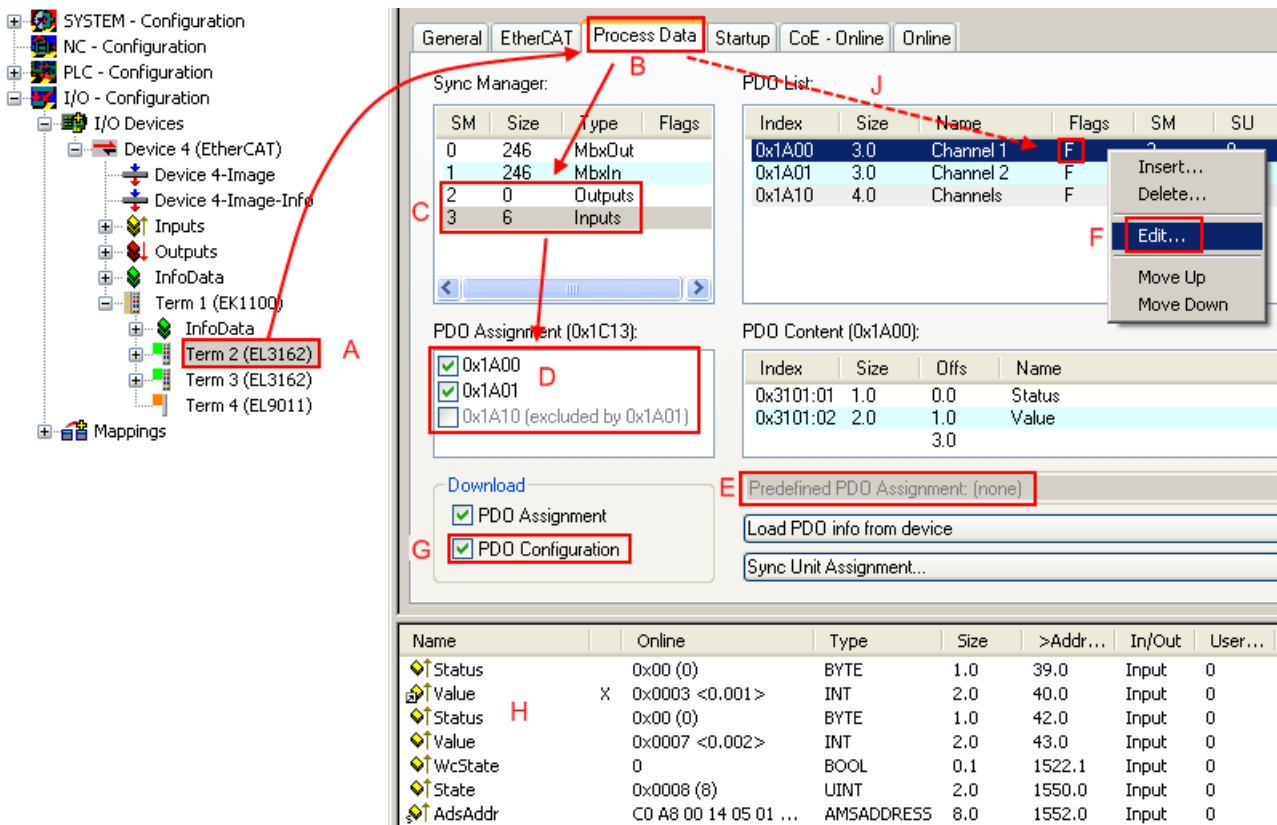

Fig. 122: Configuring the process data

i Manual modification of the process data

According to the ESI description, a PDO can be identified as “fixed” with the flag “F” in the PDO overview (Fig. *Configuring the process data*, J). The configuration of such PDOs cannot be changed, even if TwinCAT offers the associated dialog (“Edit”). In particular, CoE content cannot be displayed as cyclic process data. This generally also applies in cases where a device supports download of the PDO configuration, “G”. In case of incorrect configuration the EtherCAT slave usually refuses to start and change to OP state. The System Manager displays an “invalid SM cfg” logger message: This error message (“invalid SM IN cfg” or “invalid SM OUT cfg”) also indicates the reason for the failed start.

A detailed description [► 112] can be found at the end of this section.

“Startup” tab

The *Startup* tab is displayed if the EtherCAT slave has a mailbox and supports the *CANopen over EtherCAT* (CoE) or *Servo drive over EtherCAT* protocol. This tab indicates which download requests are sent to the mailbox during startup. It is also possible to add new mailbox requests to the list display. The download requests are sent to the slave in the same order as they are shown in the list.

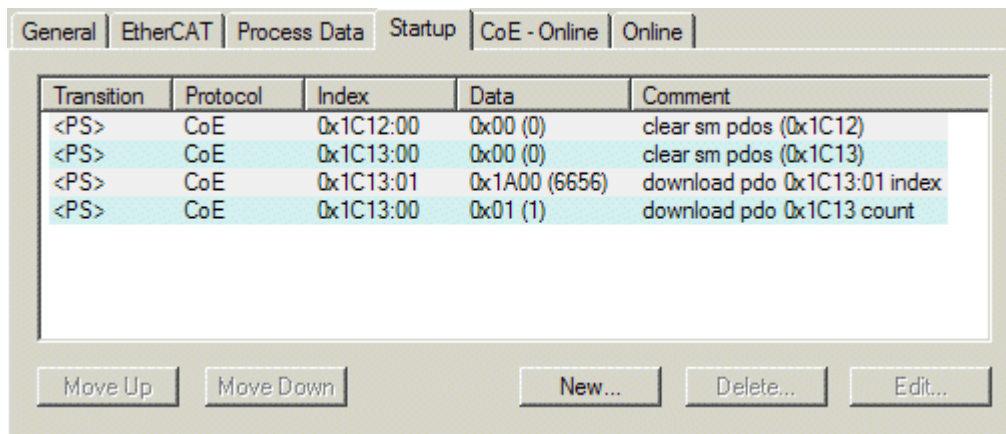

Fig. 123: "Startup" tab

Column	Description
Transition	Transition to which the request is sent. This can either be <ul style="list-style-type: none"> the transition from pre-operational to safe-operational (PS), or the transition from safe-operational to operational (SO). If the transition is enclosed in "<>" (e.g. <PS>), the mailbox request is fixed and cannot be modified or deleted by the user.
Protocol	Type of mailbox protocol
Index	Index of the object
Data	Date on which this object is to be downloaded.
Comment	Description of the request to be sent to the mailbox

- Move Up** This button moves the selected request up by one position in the list.
- Move Down** This button moves the selected request down by one position in the list.
- New** This button adds a new mailbox download request to be sent during startup.
- Delete** This button deletes the selected entry.
- Edit** This button edits an existing request.

"CoE - Online" tab

The additional *CoE - Online* tab is displayed if the EtherCAT slave supports the *CANopen over EtherCAT* (CoE) protocol. This dialog lists the content of the object list of the slave (SDO upload) and enables the user to modify the content of an object from this list. Details for the objects of the individual EtherCAT devices can be found in the device-specific object descriptions.

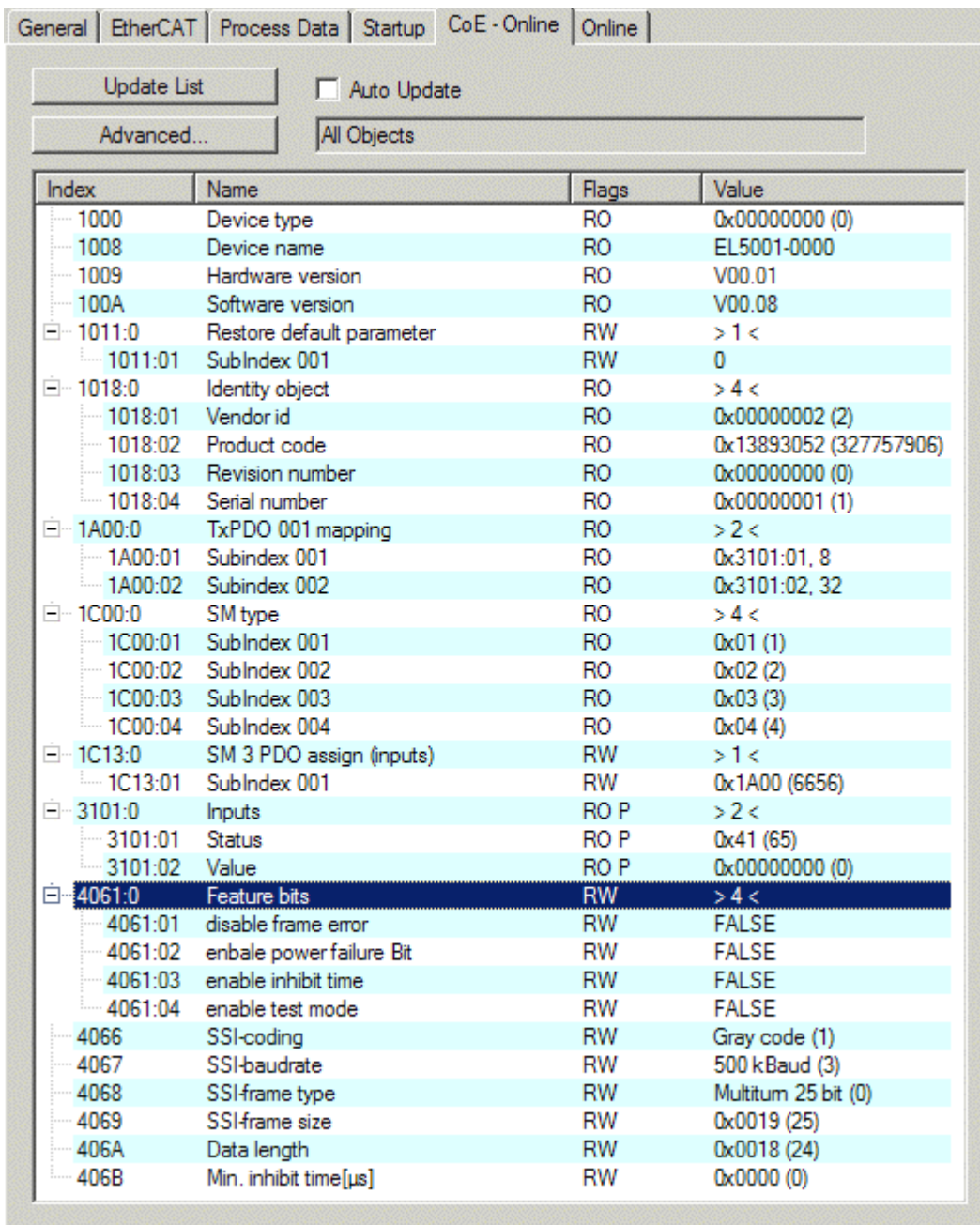

Fig. 124: "CoE - Online" tab

Object list display

Column	Description
Index	Index and sub-index of the object
Name	Name of the object
Flags	RW The object can be read, and data can be written to the object (read/write)
	RO The object can be read, but no data can be written to the object (read only)
	P An additional P identifies the object as a process data object.
Value	Value of the object

Update List The *Update list* button updates all objects in the displayed list

Auto Update If this check box is selected, the content of the objects is updated automatically.

Advanced The *Advanced* button opens the *Advanced Settings* dialog. Here you can specify which objects are displayed in the list.

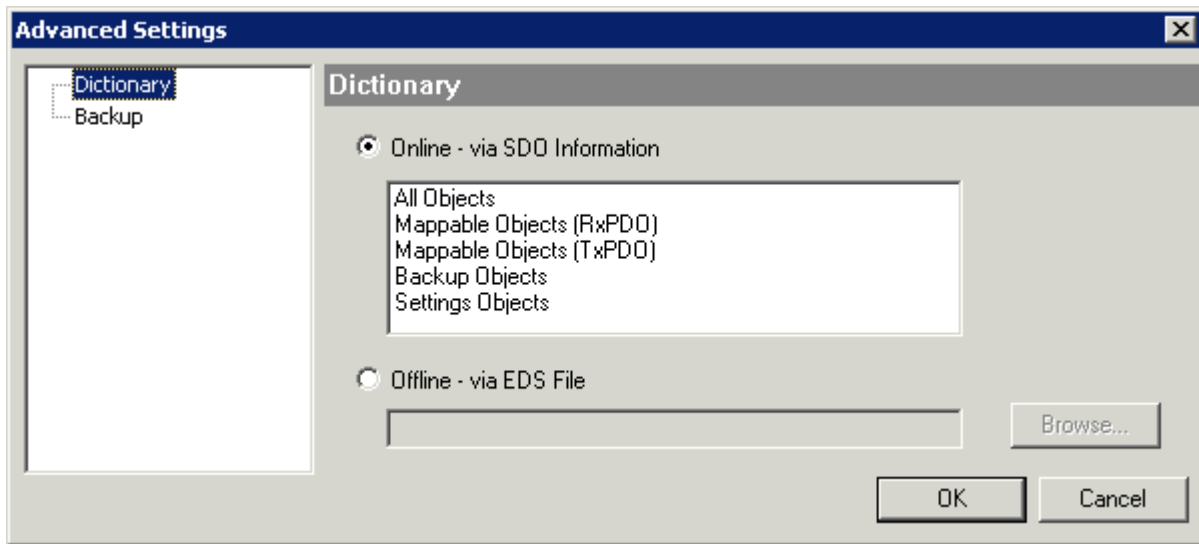

Fig. 125: Dialog “Advanced settings”

Online - via SDO Information If this option button is selected, the list of the objects included in the object list of the slave is uploaded from the slave via SDO information. The list below can be used to specify which object types are to be uploaded.

Offline - via EDS File If this option button is selected, the list of the objects included in the object list is read from an EDS file provided by the user.

“Online” tab

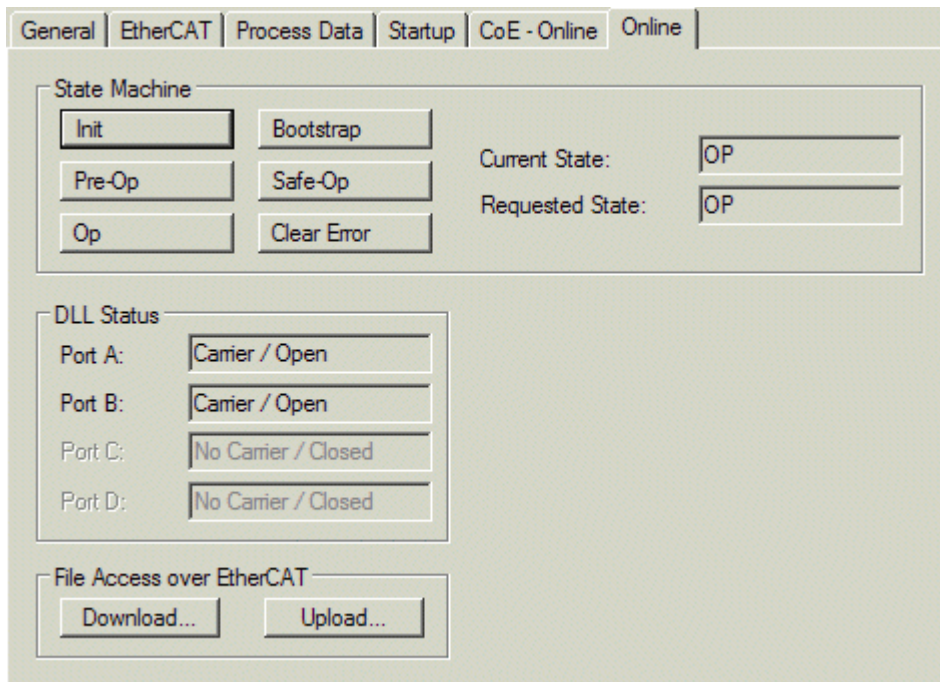

Fig. 126: “Online” tab

State Machine

- Init** This button attempts to set the EtherCAT device to the *Init* state.
- Pre-Op** This button attempts to set the EtherCAT device to the *pre-operational* state.
- Op** This button attempts to set the EtherCAT device to the *operational* state.
- Bootstrap** This button attempts to set the EtherCAT device to the *Bootstrap* state.
- Safe-Op** This button attempts to set the EtherCAT device to the *safe-operational* state.
- Clear Error** This button attempts to delete the fault display. If an EtherCAT slave fails during change of state it sets an error flag.

Example: An EtherCAT slave is in PREOP state (pre-operational). The master now requests the SAFEOP state (safe-operational). If the slave fails during change of state it sets the error flag. The current state is now displayed as ERR PREOP. When the *Clear Error* button is pressed the error flag is cleared, and the current state is displayed as PREOP again.
- Current State** Indicates the current state of the EtherCAT device.
- Requested State** Indicates the state requested for the EtherCAT device.

DLL Status

Indicates the DLL status (data link layer status) of the individual ports of the EtherCAT slave. The DLL status can have four different states:

Status	Description
No Carrier / Open	No carrier signal is available at the port, but the port is open.
No Carrier / Closed	No carrier signal is available at the port, and the port is closed.
Carrier / Open	A carrier signal is available at the port, and the port is open.
Carrier / Closed	A carrier signal is available at the port, but the port is closed.

File Access over EtherCAT

- Download** With this button a file can be written to the EtherCAT device.
- Upload** With this button a file can be read from the EtherCAT device.

“DC” tab (Distributed Clocks)

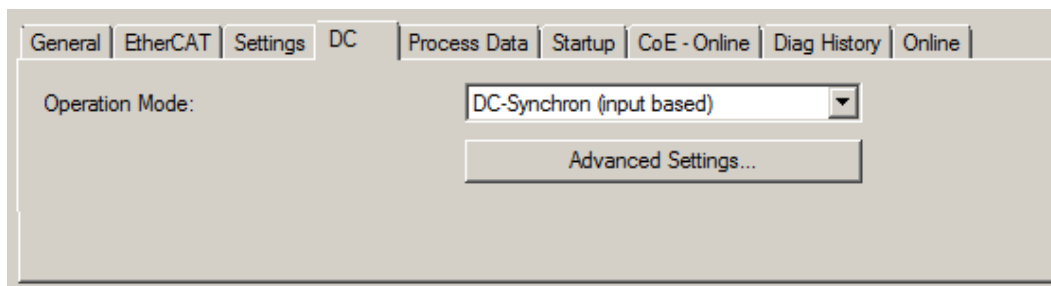

Fig. 127: “DC” tab (Distributed Clocks)

- Operation Mode** Options (optional):
 - FreeRun
 - SM-Synchron
 - DC-Synchron (Input based)
 - DC-Synchron
- Advanced Settings...** Advanced settings for readjustment of the real time determinant TwinCAT-clock

Detailed information to Distributed Clocks is specified on <http://infosys.beckhoff.com>:

Fieldbus Components → EtherCAT Terminals → EtherCAT System documentation → EtherCAT basics → Distributed Clocks

6.2.7.1 Detailed description of Process Data tab

Sync Manager

Lists the configuration of the Sync Manager (SM).

If the EtherCAT device has a mailbox, SM0 is used for the mailbox output (MbxOut) and SM1 for the mailbox input (MbxIn).

SM2 is used for the output process data (outputs) and SM3 (inputs) for the input process data.

If an input is selected, the corresponding PDO assignment is displayed in the *PDO Assignment* list below.

PDO Assignment

PDO assignment of the selected Sync Manager. All PDOs defined for this Sync Manager type are listed here:

- If the output Sync Manager (outputs) is selected in the Sync Manager list, all RxPDOs are displayed.
- If the input Sync Manager (inputs) is selected in the Sync Manager list, all TxPDOs are displayed.

The selected entries are the PDOs involved in the process data transfer. In the tree diagram of the System Manager these PDOs are displayed as variables of the EtherCAT device. The name of the variable is identical to the *Name* parameter of the PDO, as displayed in the PDO list. If an entry in the PDO assignment list is deactivated (not selected and greyed out), this indicates that the input is excluded from the PDO assignment. In order to be able to select a greyed out PDO, the currently selected PDO has to be deselected first.

● **Activation of PDO assignment**



- ✓ If you have changed the PDO assignment, in order to activate the new PDO assignment,
 - a) the EtherCAT slave has to run through the PS status transition cycle (from pre-operational to safe-operational) once (see [Online tab \[▶ 110\]](#)),
 - b) and the System Manager has to reload the EtherCAT slaves



(button for TwinCAT 2 or



button for TwinCAT 3)

PDO list

List of all PDOs supported by this EtherCAT device. The content of the selected PDOs is displayed in the *PDO Content* list. The PDO configuration can be modified by double-clicking on an entry.

Column	Description	
Index	PDO index.	
Size	Size of the PDO in bytes.	
Name	Name of the PDO. If this PDO is assigned to a Sync Manager, it appears as a variable of the slave with this parameter as the name.	
Flags	F	Fixed content: The content of this PDO is fixed and cannot be changed by the System Manager.
	M	Mandatory PDO. This PDO is mandatory and must therefore be assigned to a Sync Manager! Consequently, this PDO cannot be deleted from the <i>PDO Assignment</i> list
SM	Sync Manager to which this PDO is assigned. If this entry is empty, this PDO does not take part in the process data traffic.	
SU	Sync unit to which this PDO is assigned.	

PDO Content

Indicates the content of the PDO. If flag F (fixed content) of the PDO is not set the content can be modified.

Download

If the device is intelligent and has a mailbox, the configuration of the PDO and the PDO assignments can be downloaded to the device. This is an optional feature that is not supported by all EtherCAT slaves.

PDO Assignment

If this check box is selected, the PDO assignment that is configured in the PDO Assignment list is downloaded to the device on startup. The required commands to be sent to the device can be viewed in the Startup [▶ 107] tab.

PDO Configuration

If this check box is selected, the configuration of the respective PDOs (as shown in the PDO list and the PDO Content display) is downloaded to the EtherCAT slave.

6.2.8 Import/Export of EtherCAT devices with SCI and XTI

SCI and XTI Export/Import – Handling of user-defined modified EtherCAT slaves

6.2.8.1 Basic principles

An EtherCAT slave is basically parameterized through the following elements:

- Cyclic process data (PDO)
- Synchronization (Distributed Clocks, FreeRun, SM-Synchron)
- CoE parameters (acyclic object dictionary)

Note: Not all three elements may be present, depending on the slave.

For a better understanding of the export/import function, let's consider the usual procedure for IO configuration:

- The user/programmer processes the IO configuration in the TwinCAT system environment. This involves all input/output devices such as drives that are connected to the fieldbuses used.
Note: In the following sections, only EtherCAT configurations in the TwinCAT system environment are considered.
- For example, the user manually adds devices to a configuration or performs a scan on the online system.
- This results in the IO system configuration.
- On insertion, the slave appears in the system configuration in the default configuration provided by the vendor, consisting of default PDO, default synchronization method and CoE StartUp parameter as defined in the ESI (XML device description).
- If necessary, elements of the slave configuration can be changed, e.g. the PDO configuration or the synchronization method, based on the respective device documentation.

It may become necessary to reuse the modified slave in other projects in this way, without having to make equivalent configuration changes to the slave again. To accomplish this, proceed as follows:

- Export the slave configuration from the project,
- Store and transport as a file,
- Import into another EtherCAT project.

TwinCAT offers two methods for this purpose:

- within the TwinCAT environment: Export/Import as **xti** file or
- outside, i.e. beyond the TwinCAT limits: Export/Import as **sci** file.

An example is provided below for illustration purposes: an EL3702 terminal with standard setting is switched to 2-fold oversampling (blue) and the optional PDO "StartTimeNextLatch" is added (red):

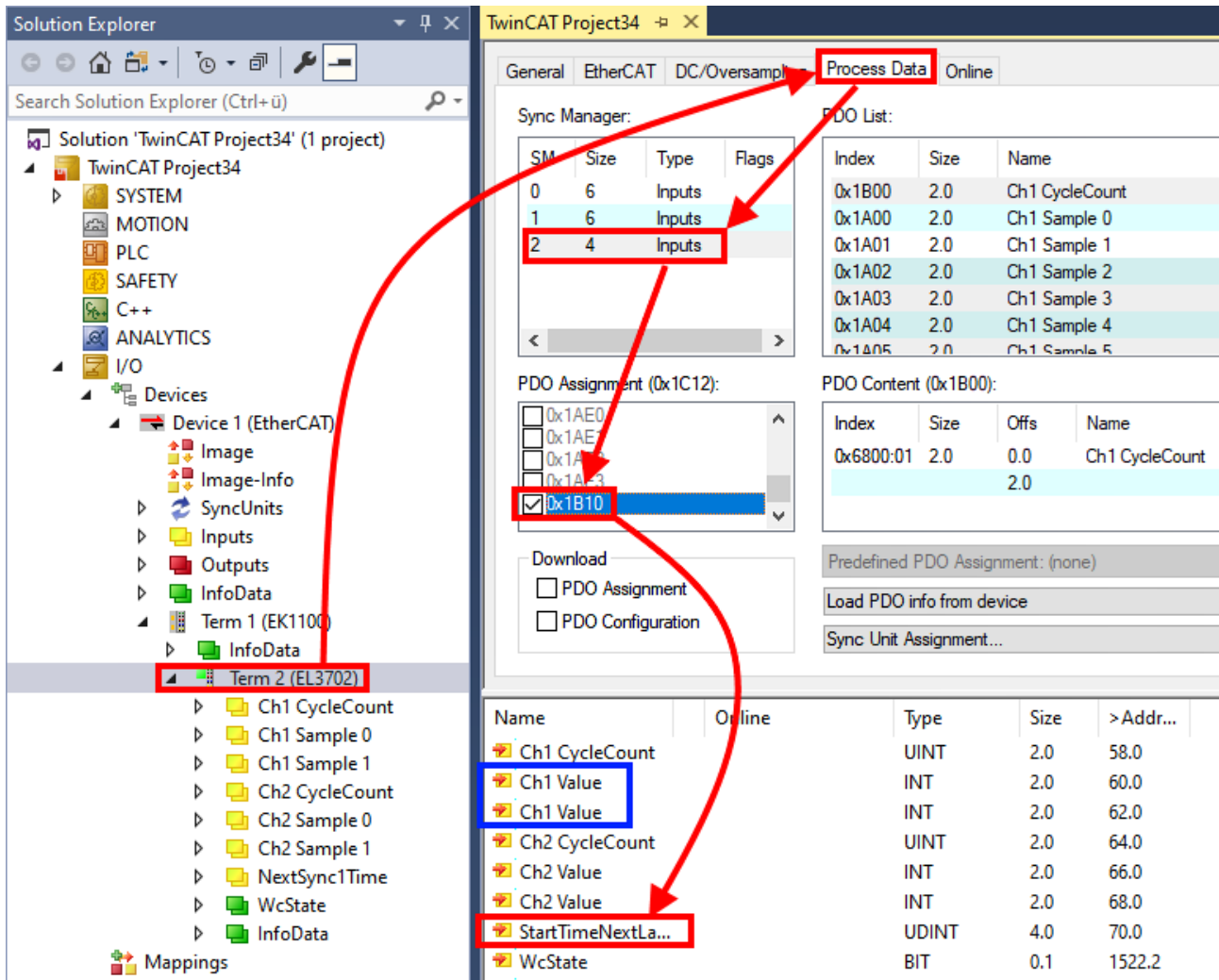

The two methods for exporting and importing the modified terminal referred to above are demonstrated below.

6.2.8.2 Procedure within TwinCAT with xti files

Each IO device can be exported/saved individually:

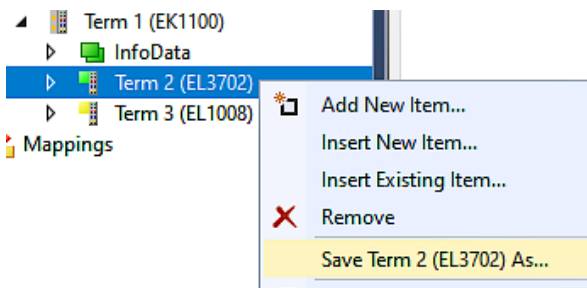

The xti file can be stored:

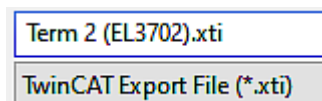

and imported again in another TwinCAT system via "Insert Existing item":

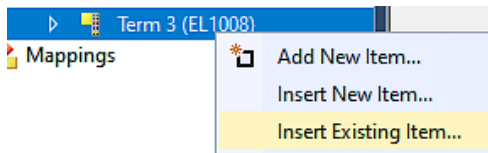

6.2.8.3 Procedure within and outside TwinCAT with sci file

Note regarding availability (2021/01)

The SCI method is available from TwinCAT 3.1 build 4024.14.

The Slave Configuration Information (SCI) describes a specific complete configuration for an EtherCAT slave (terminal, box, drive...) based on the setting options of the device description file (ESI, EtherCAT Slave Information). That is, it includes PDO, CoE, synchronization.

Export:

- select a single device via the menu (multiple selection is also possible):
TwinCAT → EtherCAT Devices → Export SCI.

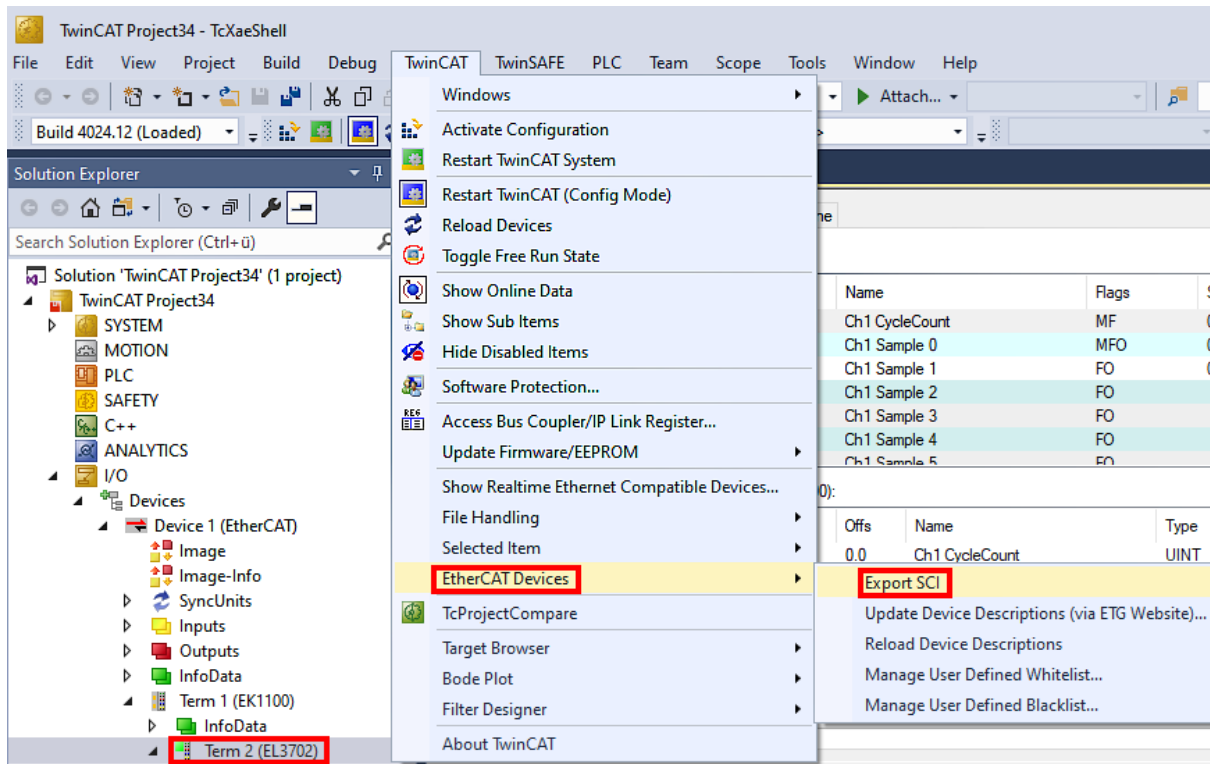

- If TwinCAT is offline (i.e. if there is no connection to an actual running controller) a warning message may appear, because after executing the function the system attempts to reload the EtherCAT segment. However, in this case this is not relevant for the result and can be acknowledged by clicking OK:

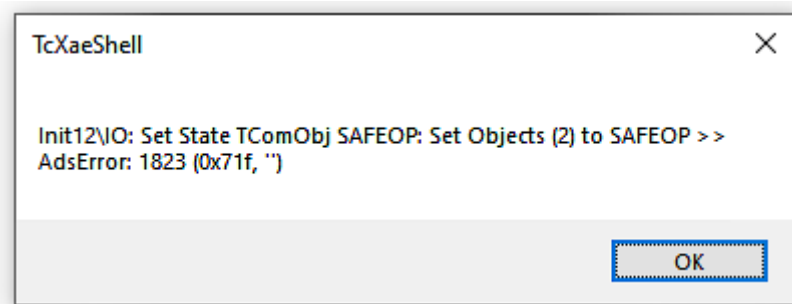

- A description may also be provided:

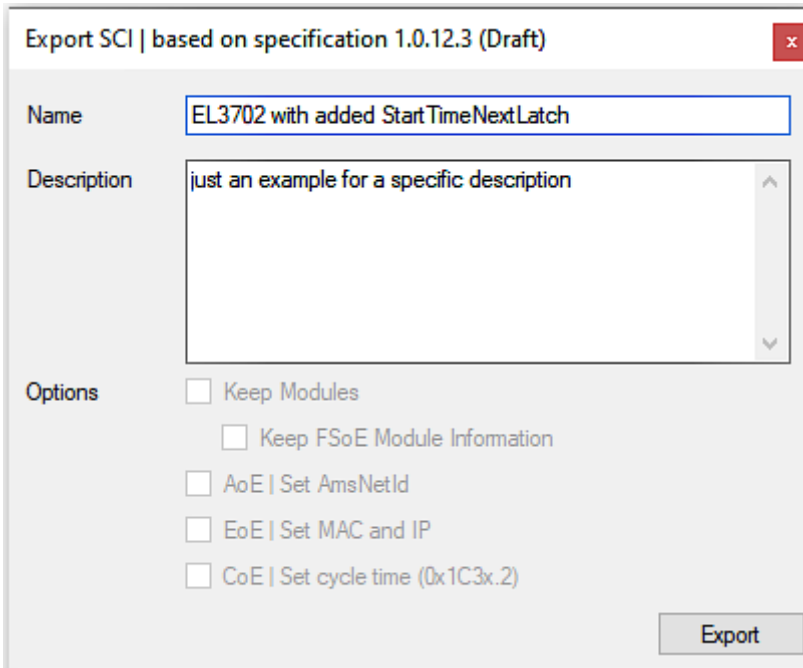

- Explanation of the dialog box:

Name	Name of the SCI, assigned by the user.	
Description	Description of the slave configuration for the use case, assigned by the user.	
Options	Keep modules	If a slave supports modules/slots, the user can decide whether these are to be exported or whether the module and device data are to be combined during export.
	AoE Set AmsNetId	The configured AmsNetId is exported. Usually this is network-dependent and cannot always be determined in advance.
	EoE Set MAC and IP	The configured virtual MAC and IP addresses are stored in the SCI. Usually these are network-dependent and cannot always be determined in advance.
	CoE Set cycle time(0x1C3x.2)	The configured cycle time is exported. Usually this is network-dependent and cannot always be determined in advance.
ESI	Reference to the original ESI file.	
Export	Save SCI file.	

- A list view is available for multiple selections (*Export multiple SCI files*):

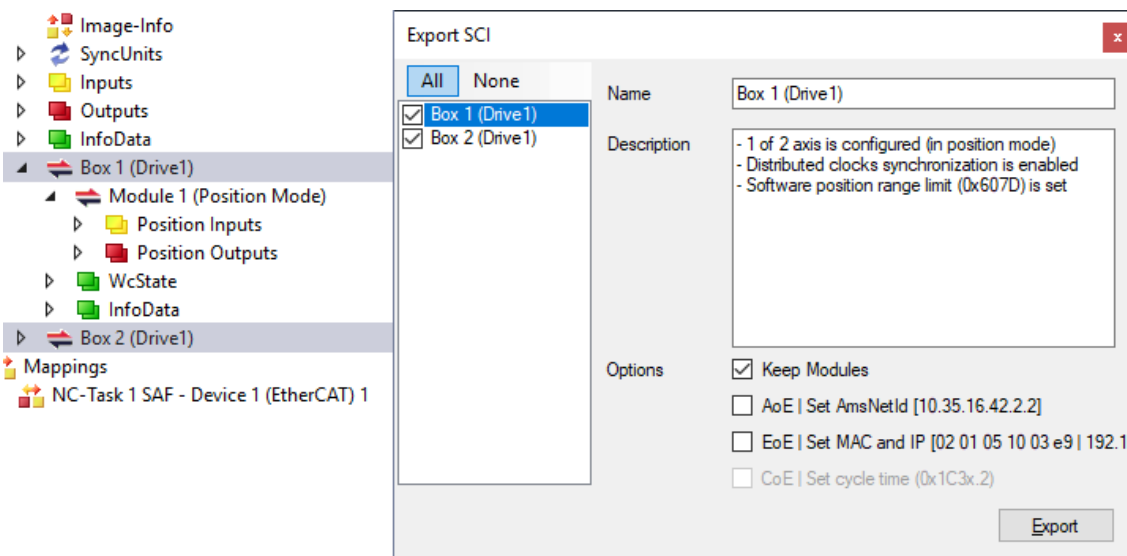

- Selection of the slaves to be exported:
 - All:
 - All slaves are selected for export.

- None:
All slaves are deselected.
- The sci file can be saved locally:

Dateiname:
 Dateityp:

- The export takes place:

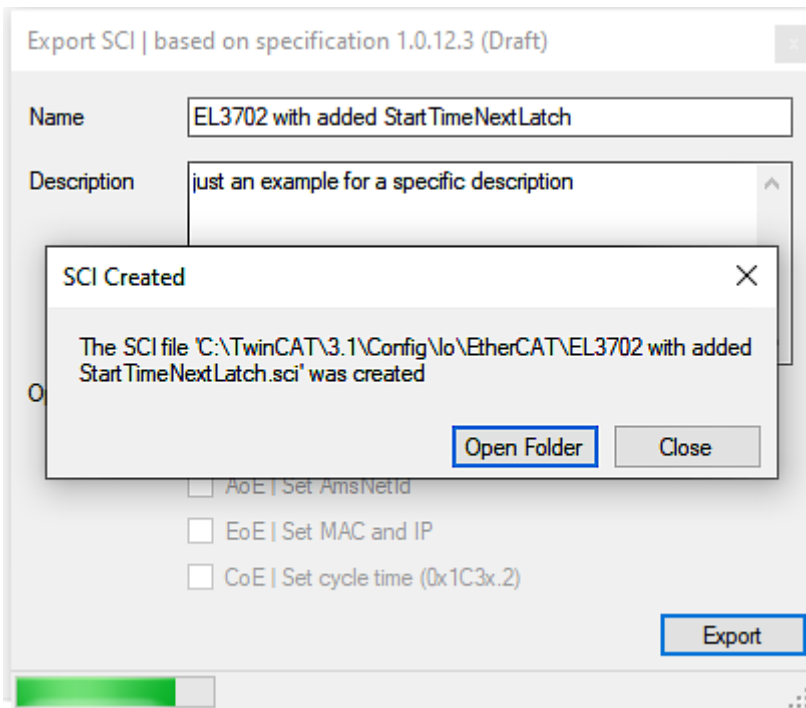

Import

- An sci description can be inserted manually into the TwinCAT configuration like any normal Beckhoff device description.
- The sci file must be located in the TwinCAT ESI path, usually under:
C:\TwinCAT\3.1\Config\Io\EtherCAT

	EL3702 with added StartTimeNextLatch.sci	11.01.2021 13:29	SCI-Datei	6 KB
--	--	------------------	-----------	------

- Open the selection dialog:

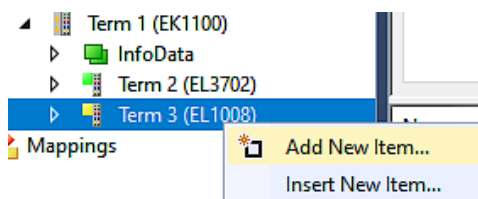

- Display SCI devices and select and insert the desired device:

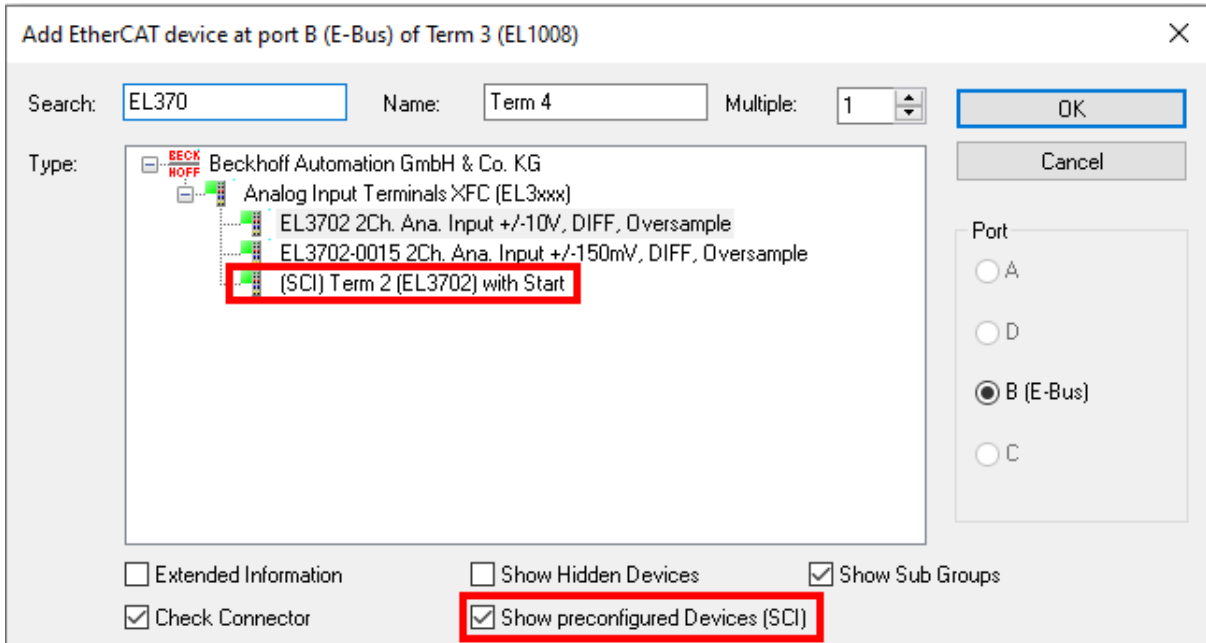

Additional Notes

- Settings for the SCI function can be made via the general Options dialog (Tools → Options → TwinCAT → Export SCI):

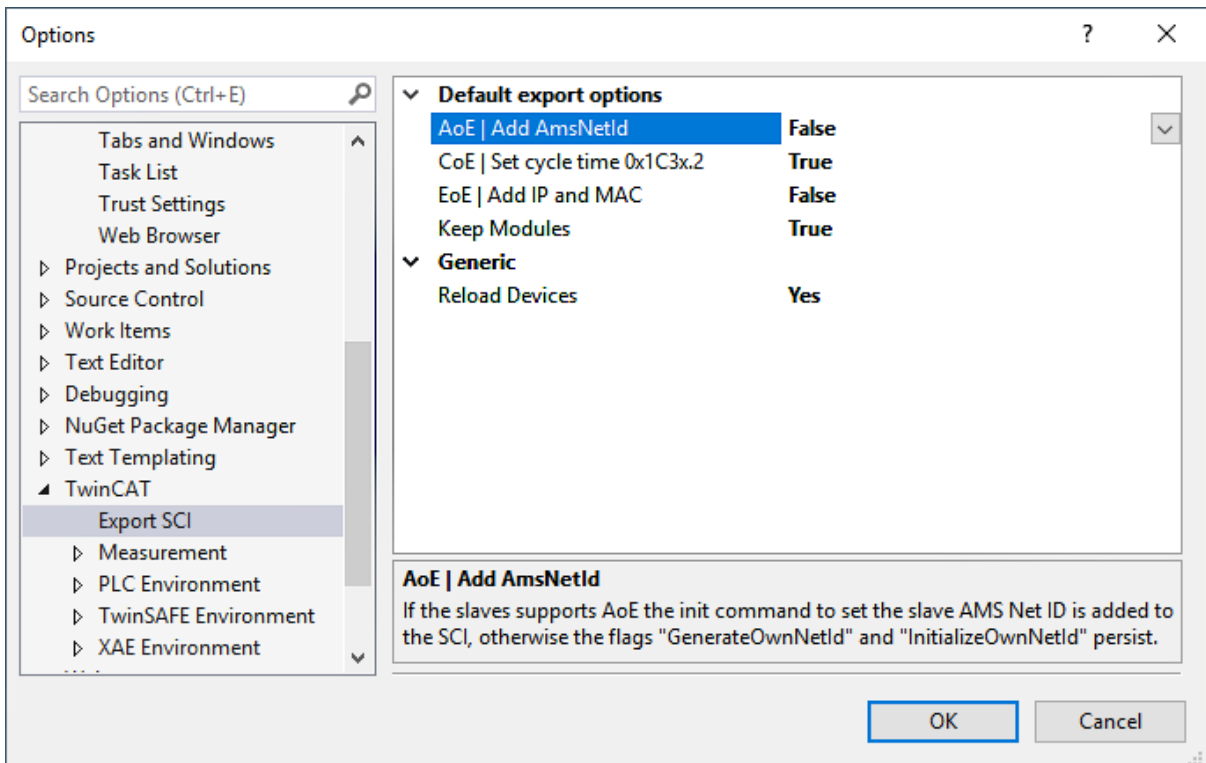

Explanation of the settings:

Default export options	AoE Set AmsNetId	Default setting whether the configured AmsNetId is exported.
	CoE Set cycle time(0x1C3x.2)	Default setting whether the configured cycle time is exported.
	EoE Set MAC and IP	Default setting whether the configured MAC and IP addresses are exported.
	Keep modules	Default setting whether the modules persist.
Generic	Reload Devices	Setting whether the Reload Devices command is executed before the SCI export. This is strongly recommended to ensure a consistent slave configuration.

SCI error messages are displayed in the TwinCAT logger output window if required:

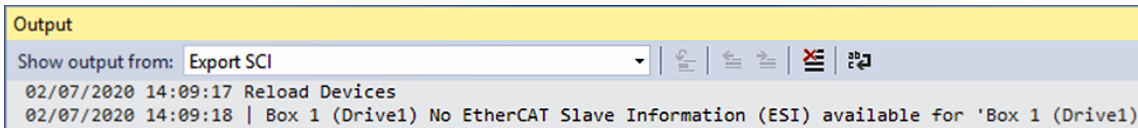

6.3 General Commissioning Instructions for an EtherCAT Slave

This summary briefly deals with a number of aspects of EtherCAT Slave operation under TwinCAT. More detailed information on this may be found in the corresponding sections of, for instance, the [EtherCAT System Documentation](#).

Diagnosis in real time: WorkingCounter, EtherCAT State and Status

Generally speaking an EtherCAT Slave provides a variety of diagnostic information that can be used by the controlling task.

This diagnostic information relates to differing levels of communication. It therefore has a variety of sources, and is also updated at various times.

Any application that relies on I/O data from a fieldbus being correct and up to date must make diagnostic access to the corresponding underlying layers. EtherCAT and the TwinCAT System Manager offer comprehensive diagnostic elements of this kind. Those diagnostic elements that are helpful to the controlling task for diagnosis that is accurate for the current cycle when in operation (not during commissioning) are discussed below.

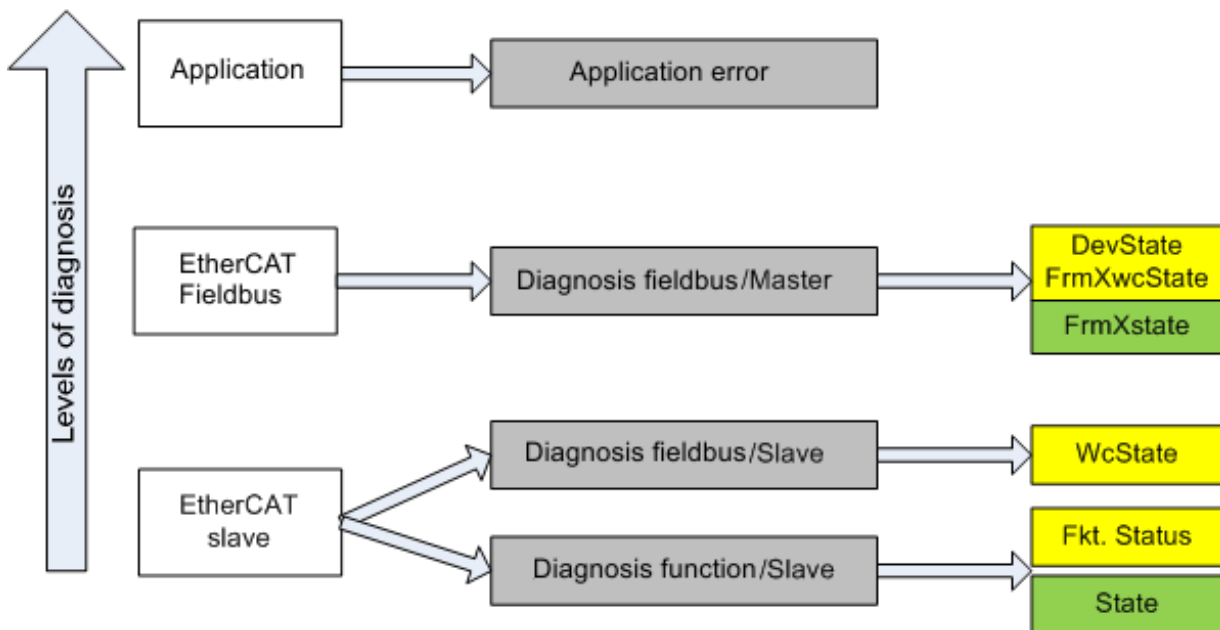

Fig. 128: Selection of the diagnostic information of an EtherCAT Slave

In general, an EtherCAT Slave offers

- communication diagnosis typical for a slave (diagnosis of successful participation in the exchange of process data, and correct operating mode)
This diagnosis is the same for all slaves.

as well as

- function diagnosis typical for a channel (device-dependent)
See the corresponding device documentation

The colors in Fig. *Selection of the diagnostic information of an EtherCAT Slave* also correspond to the variable colors in the System Manager, see Fig. *Basic EtherCAT Slave Diagnosis in the PLC*.

Colour	Meaning
yellow	Input variables from the Slave to the EtherCAT Master, updated in every cycle
red	Output variables from the Slave to the EtherCAT Master, updated in every cycle
green	Information variables for the EtherCAT Master that are updated acyclically. This means that it is possible that in any particular cycle they do not represent the latest possible status. It is therefore useful to read such variables through ADS.

Fig. Basic EtherCAT Slave Diagnosis in the PLC shows an example of an implementation of basic EtherCAT Slave Diagnosis. A Beckhoff EL3102 (2-channel analogue input terminal) is used here, as it offers both the communication diagnosis typical of a slave and the functional diagnosis that is specific to a channel. Structures are created as input variables in the PLC, each corresponding to the process image.

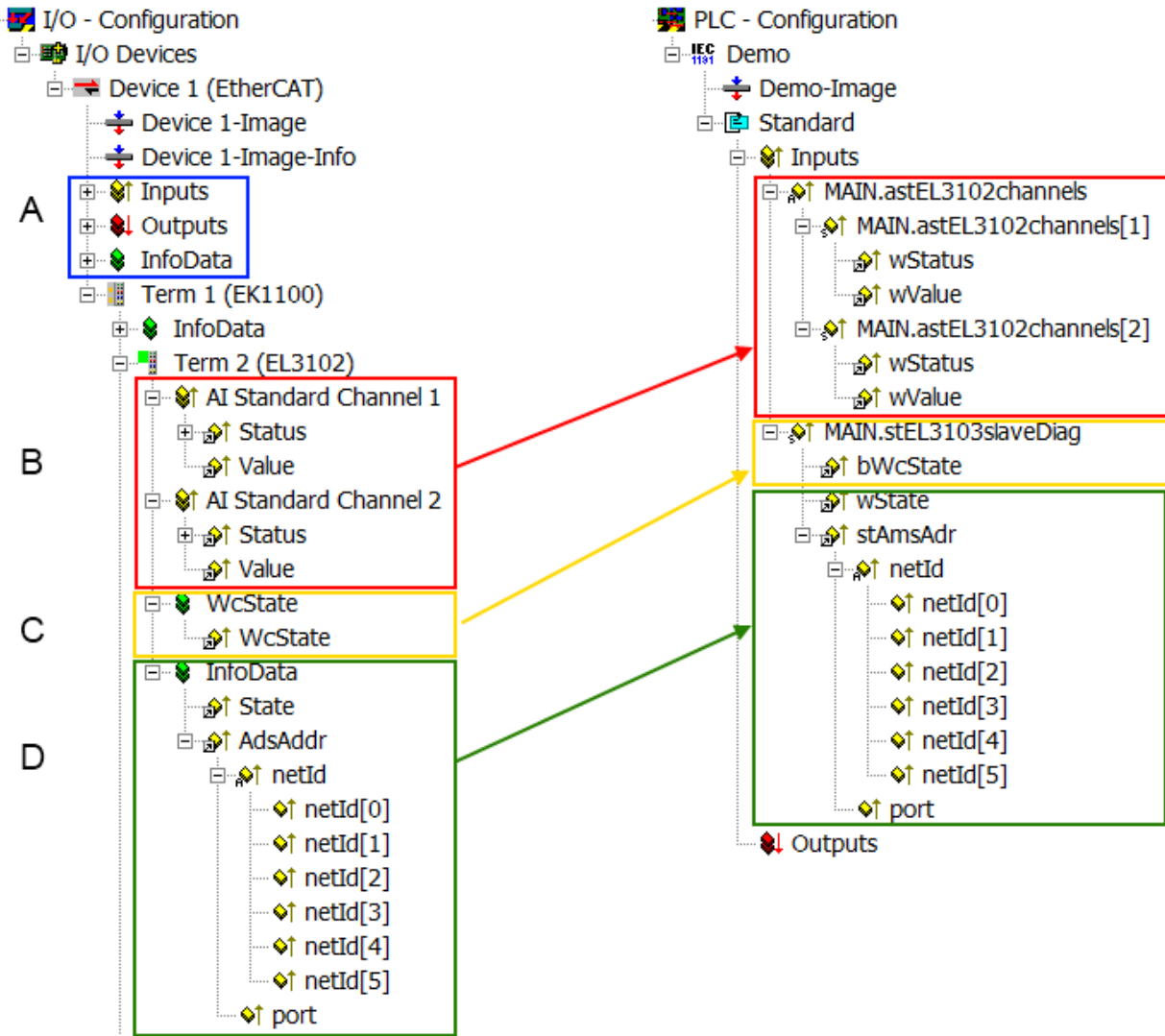

Fig. 129: Basic EtherCAT Slave Diagnosis in the PLC

The following aspects are covered here:

Code	Function	Implementation	Application/evaluation
A	The EtherCAT Master's diagnostic information updated acyclically (yellow) or provided acyclically (green).		At least the DevState is to be evaluated for the most recent cycle in the PLC. The EtherCAT Master's diagnostic information offers many more possibilities than are treated in the EtherCAT System Documentation. A few keywords: <ul style="list-style-type: none"> • CoE in the Master for communication with/through the Slaves • Functions from <i>TcEtherCAT.lib</i> • Perform an OnlineScan
B	In the example chosen (EL3102) the EL3102 comprises two analogue input channels that transmit a single function status for the most recent cycle.	Status <ul style="list-style-type: none"> • the bit significations may be found in the device documentation • other devices may supply more information, or none that is typical of a slave 	In order for the higher-level PLC task (or corresponding control applications) to be able to rely on correct data, the function status must be evaluated there. Such information is therefore provided with the process data for the most recent cycle.
C	For every EtherCAT Slave that has cyclic process data, the Master displays, using what is known as a WorkingCounter, whether the slave is participating successfully and without error in the cyclic exchange of process data. This important, elementary information is therefore provided for the most recent cycle in the System Manager <ol style="list-style-type: none"> 1. at the EtherCAT Slave, and, with identical contents 2. as a collective variable at the EtherCAT Master (see Point A) for linking. 	WcState (Working Counter) 0: valid real-time communication in the last cycle 1: invalid real-time communication This may possibly have effects on the process data of other Slaves that are located in the same SyncUnit	In order for the higher-level PLC task (or corresponding control applications) to be able to rely on correct data, the communication status of the EtherCAT Slave must be evaluated there. Such information is therefore provided with the process data for the most recent cycle.
D	Diagnostic information of the EtherCAT Master which, while it is represented at the slave for linking, is actually determined by the Master for the Slave concerned and represented there. This information cannot be characterized as real-time, because it <ul style="list-style-type: none"> • is only rarely/never changed, except when the system starts up • is itself determined acyclically (e.g. EtherCAT Status) 	State current Status (INIT..OP) of the Slave. The Slave must be in OP (=8) when operating normally. <i>AdsAddr</i> The ADS address is useful for communicating from the PLC/task via ADS with the EtherCAT Slave, e.g. for reading/writing to the CoE. The AMS-NetID of a slave corresponds to the AMS-NetID of the EtherCAT Master; communication with the individual Slave is possible via the <i>port</i> (= EtherCAT address).	Information variables for the EtherCAT Master that are updated acyclically. This means that it is possible that in any particular cycle they do not represent the latest possible status. It is therefore possible to read such variables through ADS.

NOTICE

Diagnostic information

It is strongly recommended that the diagnostic information made available is evaluated so that the application can react accordingly.

CoE Parameter Directory

The CoE parameter directory (CanOpen-over-EtherCAT) is used to manage the set values for the slave concerned. Changes may, in some circumstances, have to be made here when commissioning a relatively complex EtherCAT Slave. It can be accessed through the TwinCAT System Manager, see Fig. *EL3102, CoE directory*:

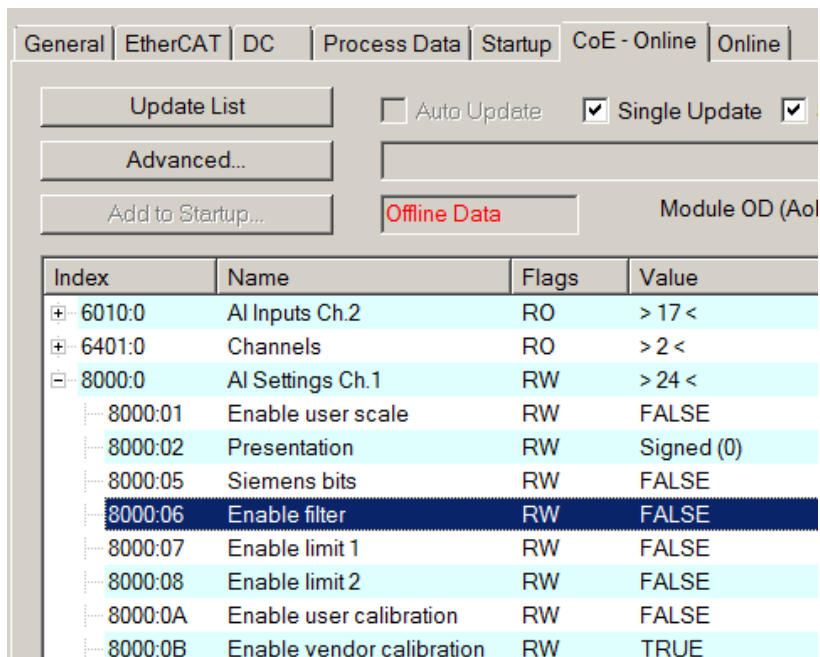

Fig. 130: EL3102, CoE directory

i EtherCAT System Documentation

The comprehensive description in the [EtherCAT System Documentation](#) (EtherCAT Basics --> CoE Interface) must be observed!

A few brief extracts:

- Whether changes in the online directory are saved locally in the slave depends on the device. EL terminals (except the EL66xx) are able to save in this way.
- The user must manage the changes to the StartUp list.

Commissioning aid in the TwinCAT System Manager

Commissioning interfaces are being introduced as part of an ongoing process for EL/EP EtherCAT devices. These are available in TwinCAT System Managers from TwinCAT 2.11R2 and above. They are integrated into the System Manager through appropriately extended ESI configuration files.

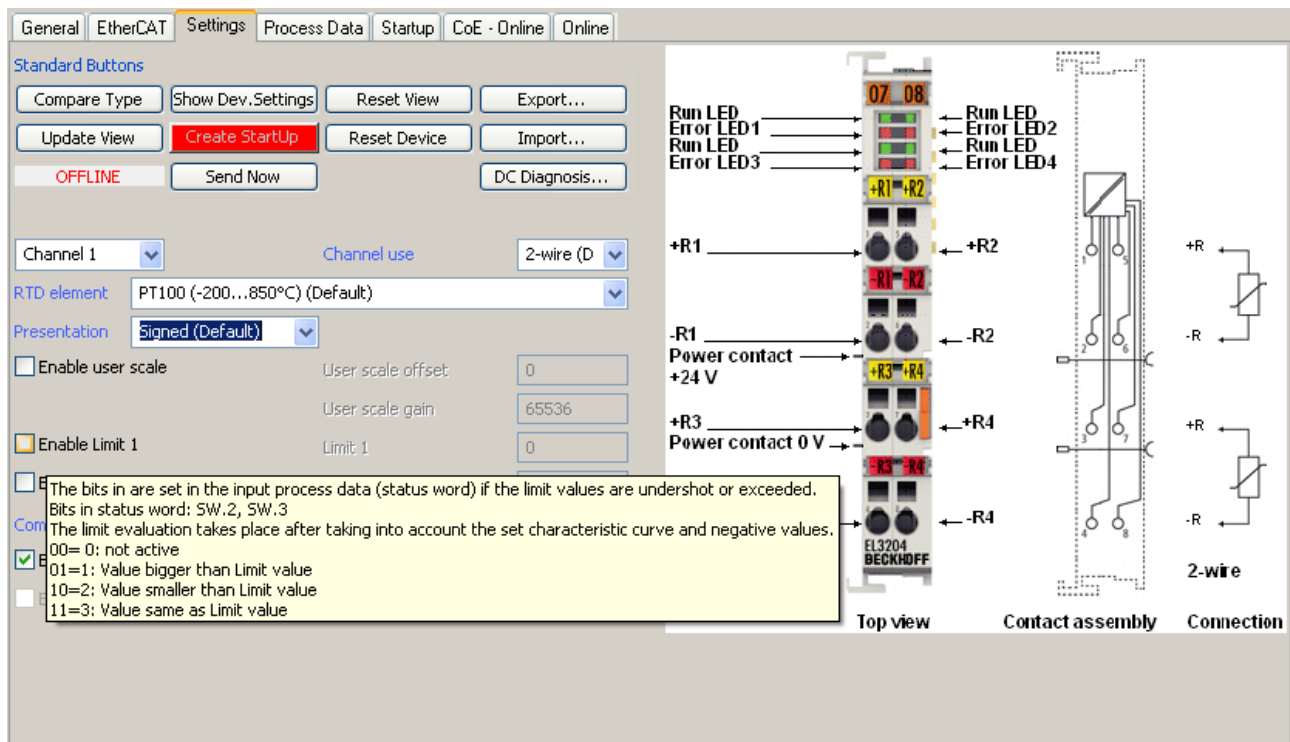

Fig. 131: Example of commissioning aid for a EL3204

This commissioning process simultaneously manages

- CoE Parameter Directory
- DC/FreeRun mode
- the available process data records (PDO)

Although the “Process Data”, “DC”, “Startup” and “CoE-Online” that used to be necessary for this are still displayed, it is recommended that, if the commissioning aid is used, the automatically generated settings are not changed by it.

The commissioning tool does not cover every possible application of an EL/EP device. If the available setting options are not adequate, the user can make the DC, PDO and CoE settings manually, as in the past.

EtherCAT State: automatic default behaviour of the TwinCAT System Manager and manual operation

After the operating power is switched on, an EtherCAT Slave must go through the following statuses

- INIT
- PREOP
- SAFEOP
- OP

to ensure sound operation. The EtherCAT Master directs these statuses in accordance with the initialization routines that are defined for commissioning the device by the ES/XML and user settings (Distributed Clocks (DC), PDO, CoE). See also the section on "Principles of [Communication, EtherCAT State Machine \[▶ 27\]](#)" in this connection. Depending how much configuration has to be done, and on the overall communication, booting can take up to a few seconds.

The EtherCAT Master itself must go through these routines when starting, until it has reached at least the OP target state.

The target state wanted by the user, and which is brought about automatically at start-up by TwinCAT, can be set in the System Manager. As soon as TwinCAT reaches the status RUN, the TwinCAT EtherCAT Master will approach the target states.

Standard setting

The advanced settings of the EtherCAT Master are set as standard:

- EtherCAT Master: OP
- Slaves: OP
This setting applies equally to all Slaves.

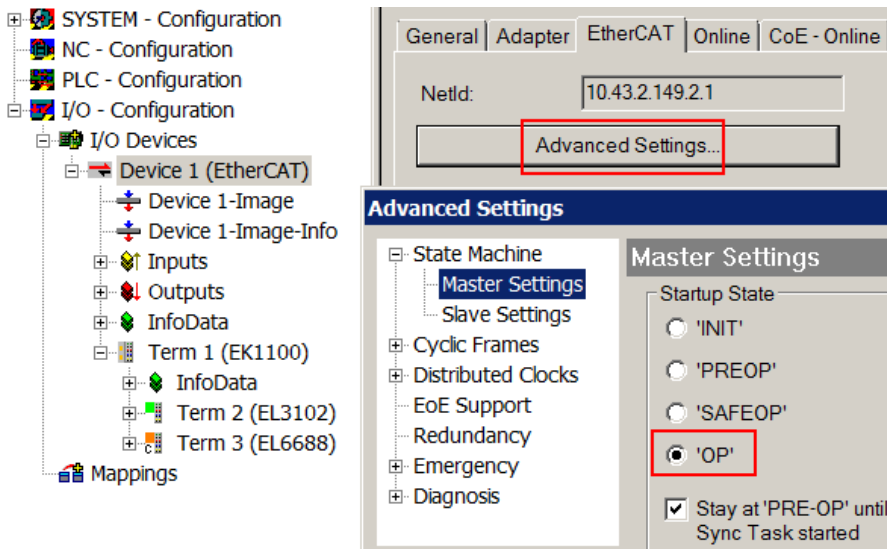

Fig. 132: Default behaviour of the System Manager

In addition, the target state of any particular Slave can be set in the “Advanced Settings” dialogue; the standard setting is again OP.

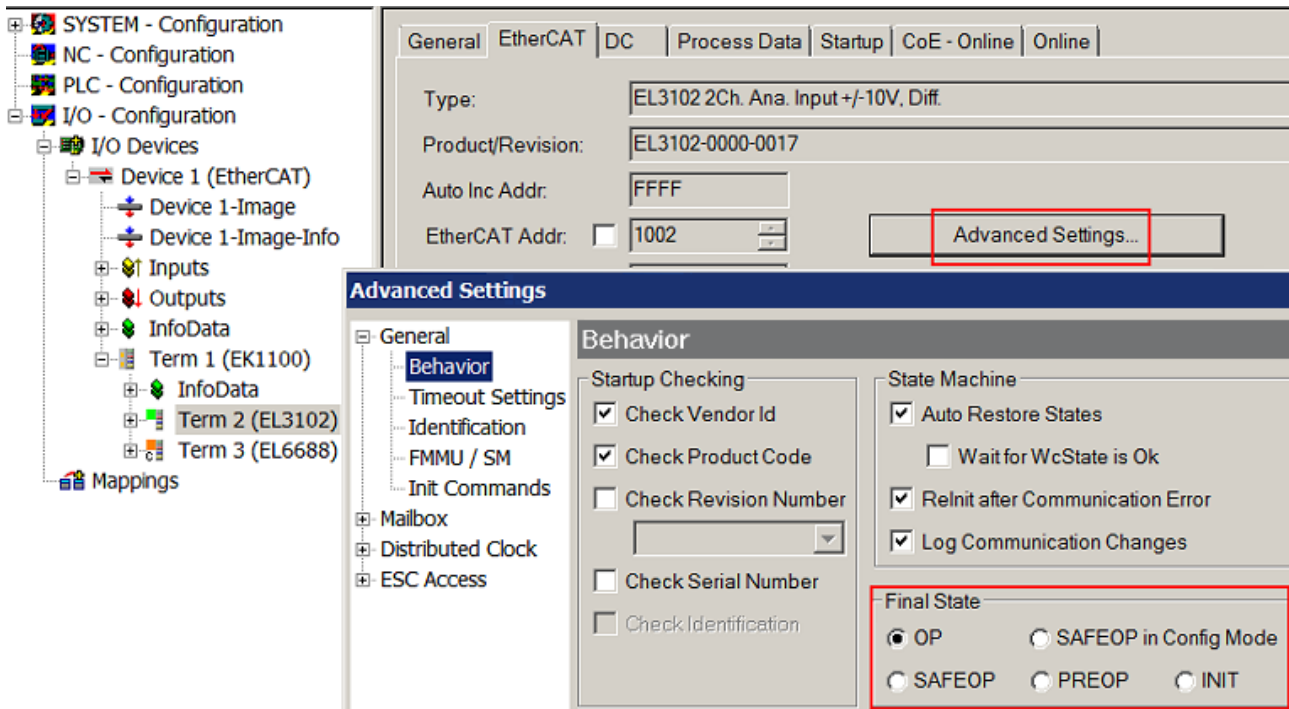

Fig. 133: Default target state in the Slave

Manual Control

There are particular reasons why it may be appropriate to control the states from the application/task/PLC. For instance:

- for diagnostic reasons
- to induce a controlled restart of axes

- because a change in the times involved in starting is desirable

In that case it is appropriate in the PLC application to use the PLC function blocks from the *TcEtherCAT.lib*, which is available as standard, and to work through the states in a controlled manner using, for instance, *FB_EcSetMasterState*.

It is then useful to put the settings in the EtherCAT Master to INIT for master and slave.

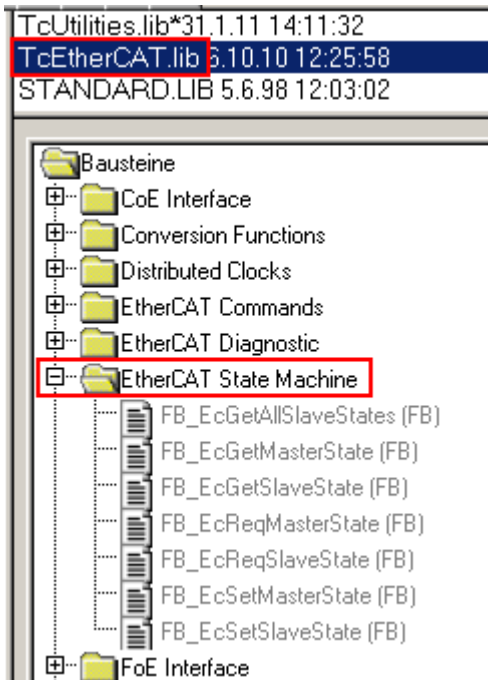

Fig. 134: PLC function blocks

Note regarding E-Bus current

EL/ES terminals are placed on the DIN rail at a coupler on the terminal strand. A Bus Coupler can supply the EL terminals added to it with the E-bus system voltage of 5 V; a coupler is thereby loadable up to 2 A as a rule. Information on how much current each EL terminal requires from the E-bus supply is available online and in the catalogue. If the added terminals require more current than the coupler can supply, then power feed terminals (e.g. EL9410) must be inserted at appropriate places in the terminal strand.

The pre-calculated theoretical maximum E-Bus current is displayed in the TwinCAT System Manager as a column value. A shortfall is marked by a negative total amount and an exclamation mark; a power feed terminal is to be placed before such a position.

General Adapter EtherCAT Online CoE - Online						
NetId:		10.43.2.149.2.1		Advanced Settings...		
Number	Box Name	Address	Type	In Size	Out S...	E-Bus (..
1	Term 1 (EK1100)	1001	EK1100			
2	Term 2 (EL3102)	1002	EL3102	8.0		1830
3	Term 4 (EL2004)	1003	EL2004		0.4	1730
4	Term 5 (EL2004)	1004	EL2004		0.4	1630
5	Term 6 (EL7031)	1005	EL7031	8.0	8.0	1510
6	Term 7 (EL2808)	1006	EL2808		1.0	1400
7	Term 8 (EL3602)	1007	EL3602	12.0		1210
8	Term 9 (EL3602)	1008	EL3602	12.0		1020
9	Term 10 (EL3602)	1009	EL3602	12.0		830
10	Term 11 (EL3602)	1010	EL3602	12.0		640
11	Term 12 (EL3602)	1011	EL3602	12.0		450
12	Term 13 (EL3602)	1012	EL3602	12.0		260
13	Term 14 (EL3602)	1013	EL3602	12.0		70
14	Term 3 (EL6688)	1014	EL6688	22.0		-240 !

Fig. 135: Illegally exceeding the E-Bus current

From TwinCAT 2.11 and above, a warning message “E-Bus Power of Terminal...” is output in the logger window when such a configuration is activated:

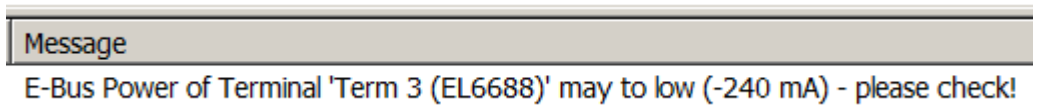

Fig. 136: Warning message for exceeding E-Bus current

NOTICE

Caution! Malfunction possible!

The same ground potential must be used for the E-Bus supply of all EtherCAT terminals in a terminal block!

7 EL5021-00x0 - Commissioning

7.1 Principle of the sine/cosine measurement

A position encoder with sine/cosine interface $1 V_{pp}$ outputs two sine signals phase-shifted by 90° as analog voltages. Both signals are transmitted over two lines differentially as signal and counter signal, the voltage difference between the two lines giving the wanted signal in peak-to-peak volts. A level of $1 V_{pp}$ is usual. A full 360° cycle of the sine signal is designated as a period. Up to 10,000 periods per mechanical revolution are typical for rotary encoders.

If the rotary/linear encoder is moved, an occasionally high frequency alternating voltage is generated, which is subject to the known dynamic limits such as maximum input frequency and amplitude attenuation/level in the subsequent circuitry.

In extending the signal of a digital incremental encoder, which can only evaluate these full steps/cycles, the downstream circuitry can interpolate the two phase-shifted sine signals and thus determine the position n-thousand times more precisely, even within a cycle. For the EL5021 this period resolution by interpolation is 8 to 13 bits, depending upon the setting, and is equivalent to a 256 to 8192-fold micro-resolution of the interval.

● Micro-increments



The EL5101 Encoder Terminal uses a time-based micro-increment method for the same purpose, in order to also resolve digital encoder steps into up to 256 micro-increments.

In addition a further Reset/C signal from the encoder can be connected in order to mark a special position, e.g. the zero position. This signal can be used by the EL5021 for resetting or latching.

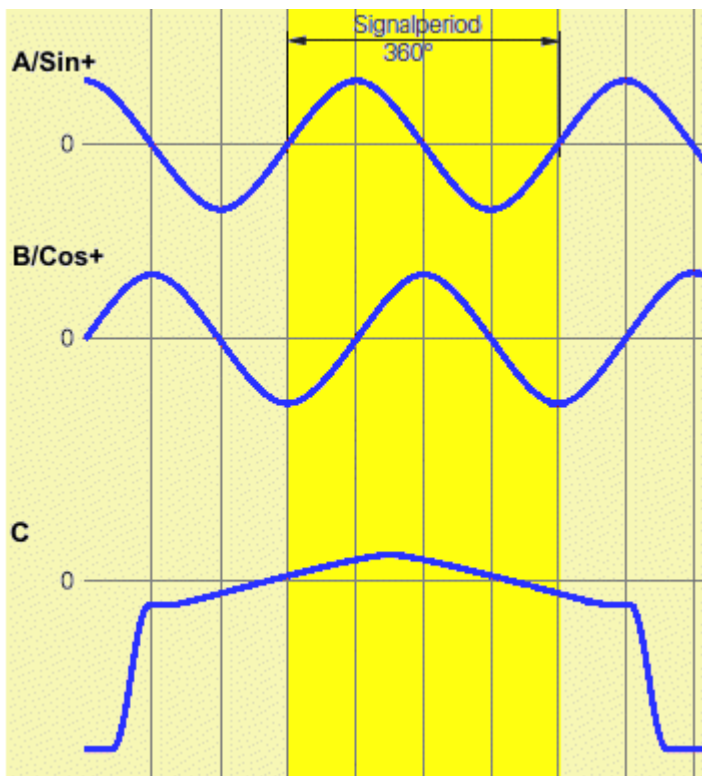

Fig. 137: Signal outputs of the position encoder

7.2 DC (Distributed Clocks)

In the "DC" tab, the trigger mode can be set via the Operation Mode selection list.

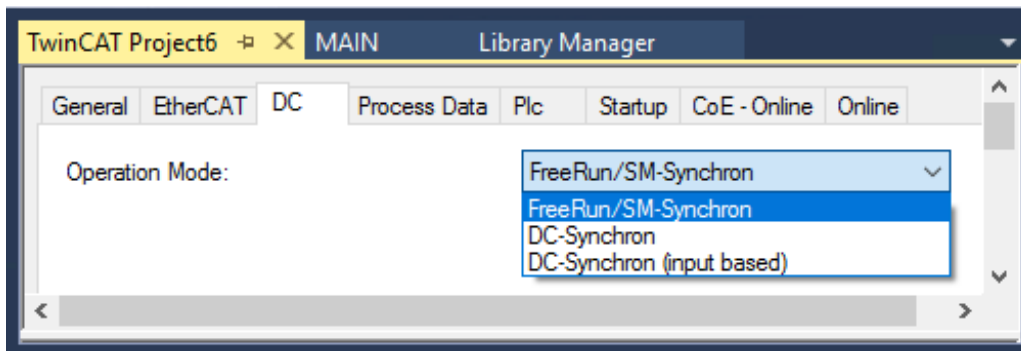

Fig. 138: "DC" tab, selection list "Operation Mode" (trigger mode)

- **FreeRun:** (frame-triggered)
Cyclic operation is started via the SyncManagers during EtherCAT frame processing.
- **DC-Synchron:**
Cyclic operation in the terminal is started by the local distributed clock at exact intervals. The start time is chosen such that it coincides with other output slaves in the EtherCAT system.
This mode is not suitable for the EL5021 as a terminal of the DC group of the input terminals, see [Note \[▶ 128\]](#).
- **DC Synchron (input based):**
As DC Synchron mode, with the cyclic start time chosen such that it coincides with other input slaves in the EtherCAT system.

A detailed description of the function can be found in the chapter "[Operation mode \(Trigger mode\) \[▶ 128\]](#)"

7.2.1 Operation mode (trigger mode)

Trigger via the communication cycle, frame-triggered:

- **"FreeRun/SM-synchron"**
As soon as an EtherCAT communication addresses the EL5021, it starts a new position determination. The EtherCAT communication is usually started by the PLC/NC task.

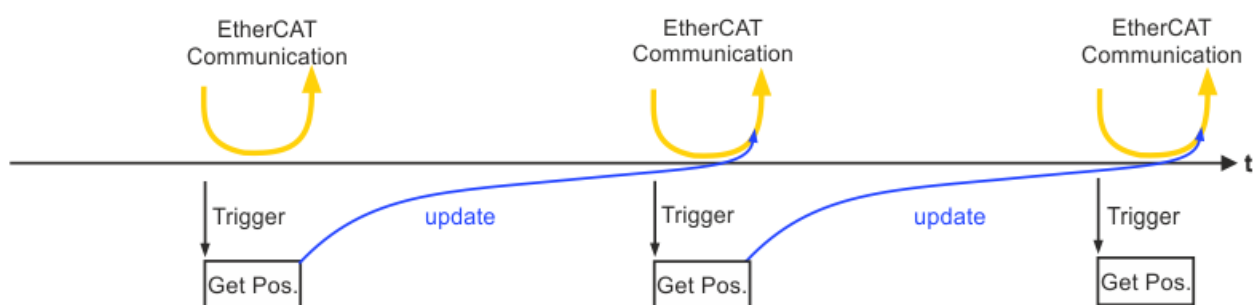
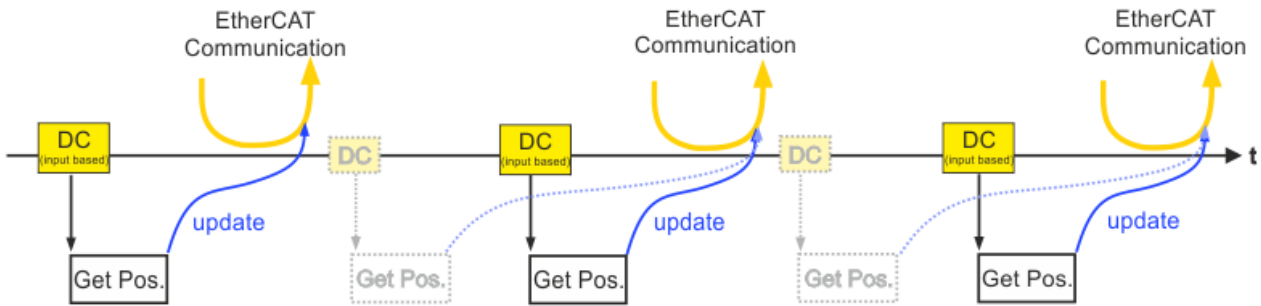

Fig. 139: frame-triggered EtherCAT communication

Trigger via the terminal's own distributed clock

1. **"DC-synchron (input based)"**
The DC unit of the terminal triggers the position determination shortly before the next collecting EtherCAT telegram, so that the most up-to-date possible value is available for collection.
2. **"DC-synchron"**
In the setting "DC-synchron" the EL5021 is operated in the DC group of output terminals, as a result of which it does not determine its position shortly before the EtherCAT communication, but shortly after the communication. The data are thus significantly older.



DC synchron (input based) triggered EtherCAT communication

The precise DC time of the position determination is not output by the EL5021 as process data, but instead can be displayed for all terminals via the advanced terminal settings (see fig. *Advanced Settings in the TwinCAT System Manager*) or via the EtherCAT Master --> Advanced Settings --> MasterSetting --> IncludeDcTimeOffsets. These values are calculated once during the creation/activation of the configuration and do not change any further during runtime.

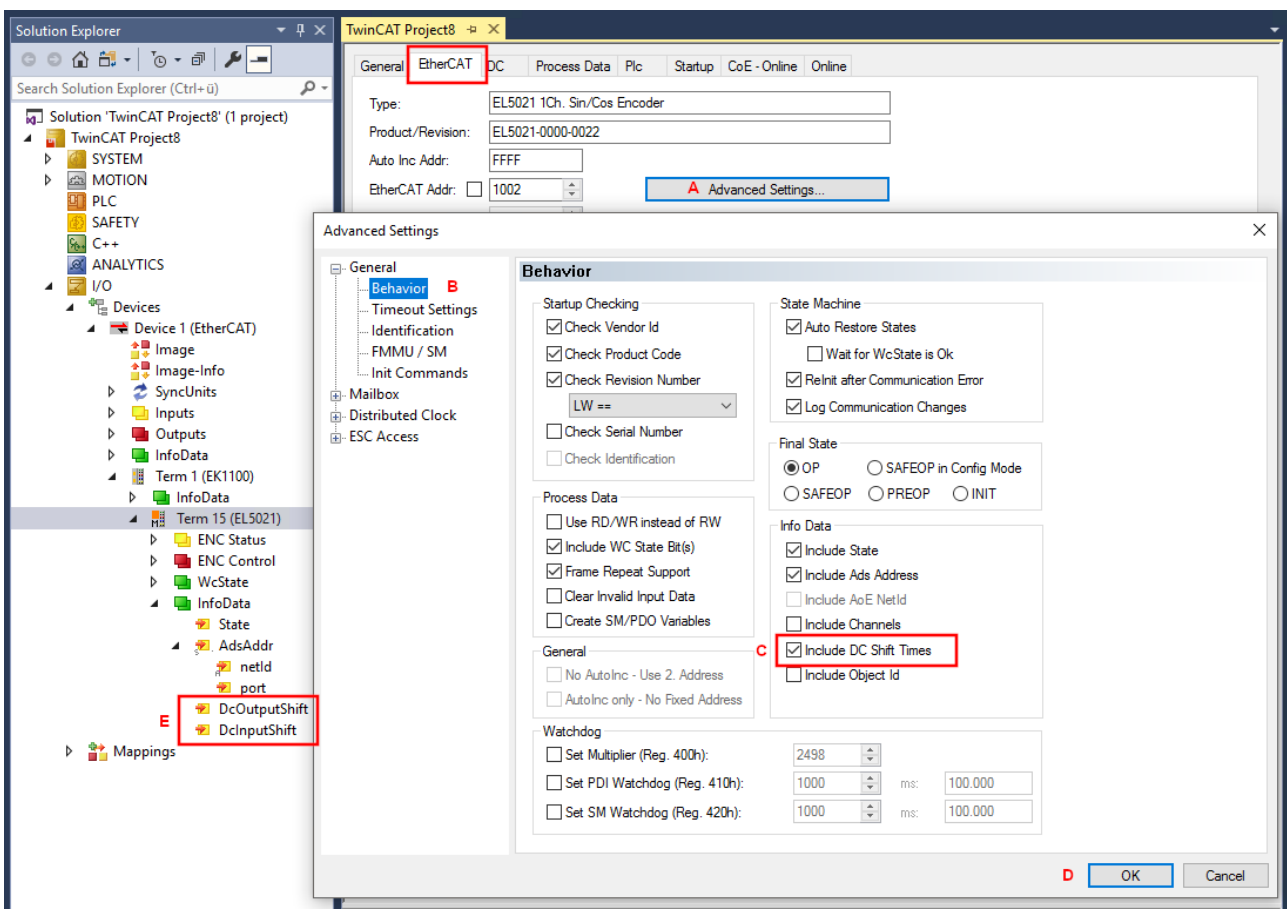

Fig. 140: Advanced Settings in the TwinCAT System Manager

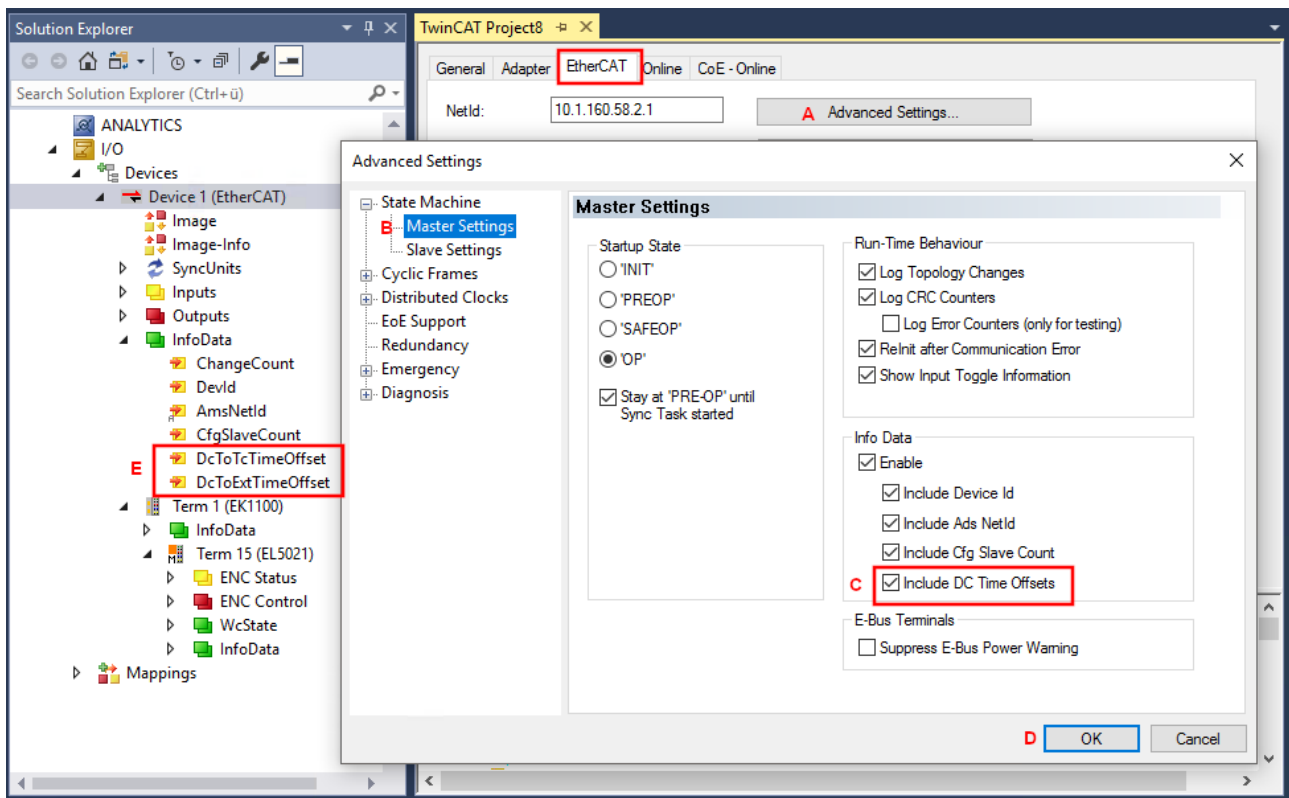

Fig. 141: Advanced settings of the EtherCAT master in the TwinCAT System Manager

The determination of the current position is subject to a constant delay of several μs . This delay is already taken into account in TwinCAT when calculating the InputShiftTime, so that the actual determination time and the calculated time coincide.

The minimum possible sampling rate of the EL5021 is $80 \mu\text{s}$ and therefore also the minimum possible EtherCAT cycle time.

7.3 Process data EL5021-00x0

Via the "Process Data" tab, the contents of the available process data objects (PDO) can be displayed in the "PDO Content" (C) field. Changes to the process data can be made via the "PDO Assignment" field.

- No changes can be made for the EL5021-00x0 Terminals via the Sync Manager SM2 "Outputs".
- Via the Sync Manager SM3 "Inputs" (A) two additional "PDO Assignments" (B) can be added for the frequency:
 - 0x1A01 "ENC Frequency (int32)"
 - 0x1A02 "ENC Frequency (uint32)"

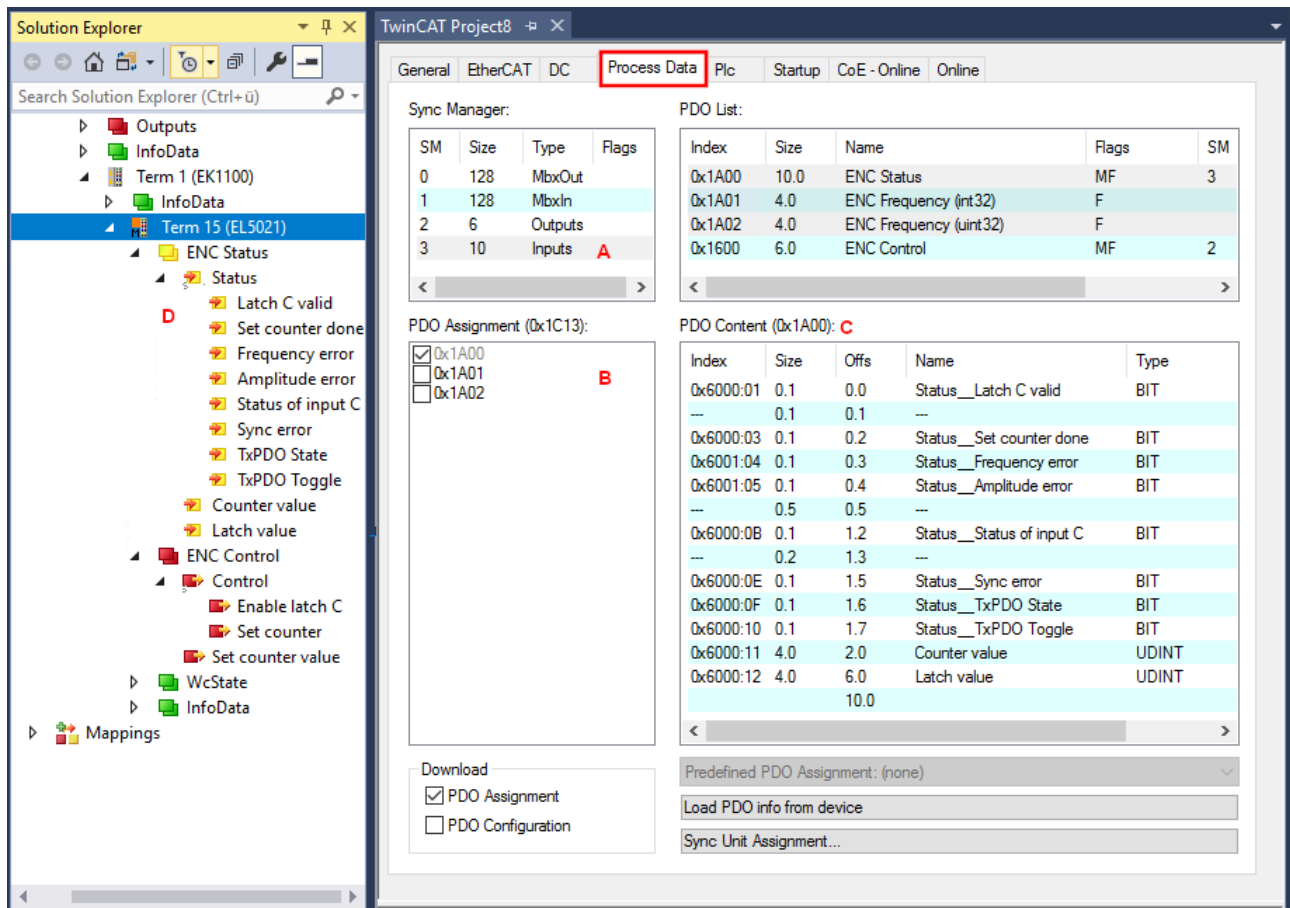

Fig. 142: EL5021 - Process data (default)

- In order to configure the process data, select the desired Sync Manager (only SM3 can be edited here) in the upper left-hand "Sync Manager" (A) field.
- The process data assigned to this Sync Manager can then be switched on or off in the "PDO Assignment" (B) field below.
- Restarting the EtherCAT system, or reloading the configuration in Config mode (F4), causes the EtherCAT communication to restart, and the process data is transferred from the terminal.

All selected process data are displayed in the tree structure (D).

The process data are generated from CoE objects 0x6000 (Inputs) and 0x7000 (Outputs) and are described in chapter "Object description and parameterization [▶ 147]".

7.4 TwinSAFE SC process data EL5021-0090

The EL5021-0090 transmits the following process data to the TwinSAFE logic:

Index (hex)	Name	Type	Size
6000:11	Counter value (default)	UDINT	4.0
6000:13	Frequency value	UDINT	4.0
6000:1A	Frequency value (int16)	INT	2.0
6000:1B	Frequency value (int32) (default)	DINT	4.0
6000:1C	Frequency value (uint16)	UINT	2.0

The counter value (0x6000:11) and the 32-bit frequency value (0x6000:1B) are transferred as default values. Via the "Process Image" tab the other data types of the frequency value can be selected or completely deselected in the Safety Editor.

The EL5021-0090 offers one slot and two modules with different ModuleIdents. Depending on the selection, different process data objects (PDOs) are available. However, the process data can be configured in the SAFETY editor.

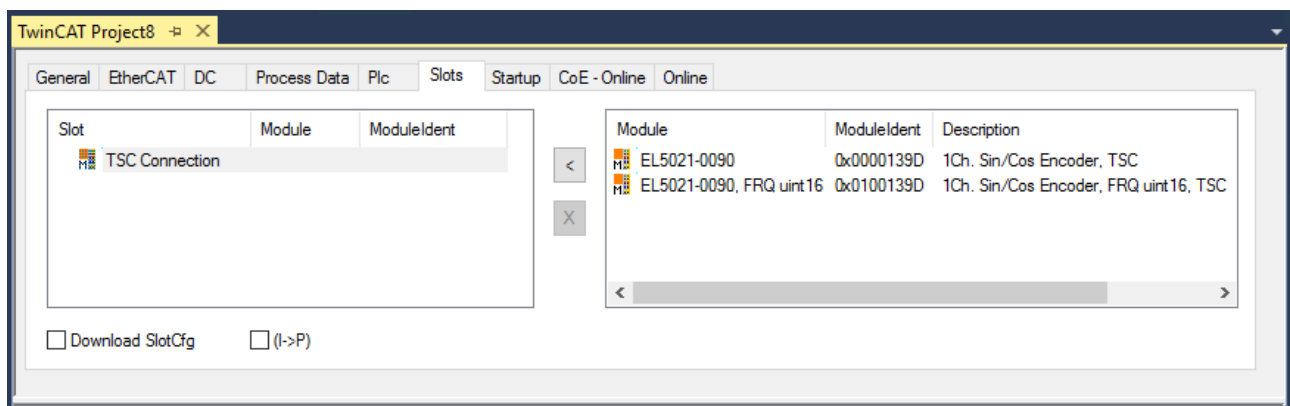



Fig. 143: EL5021-0090 - Slot module assignment in the Slots tab

7.5 Settings via the CoE directory

[Latch, reset, reverse direction of rotation, TxPDO state, TxPDO toggle](#) [▶ 134]

NOTICE



Parameterization via the CoE list (CAN over EtherCAT)

The EtherCAT device is parameterized via the CoE - Online tab (with a double click on the respective object) or via the Process Data tab (assignment of PDOs). A detailed description can be found in the EtherCAT System-Documentation in chapter “[EtherCAT subscriber configuration](#)”

Please note the general CoE notes in the EtherCAT System Documentation in chapter “[CoE-interface](#)” when using/manipulating the CoE parameters:

- Keep a startup list if components have to be replaced
- Differentiation between online/offline dictionary,
- existence of current XML description
- use "CoE reload" for resetting changes

All settings for the EL5021 are made via the CoE directory.

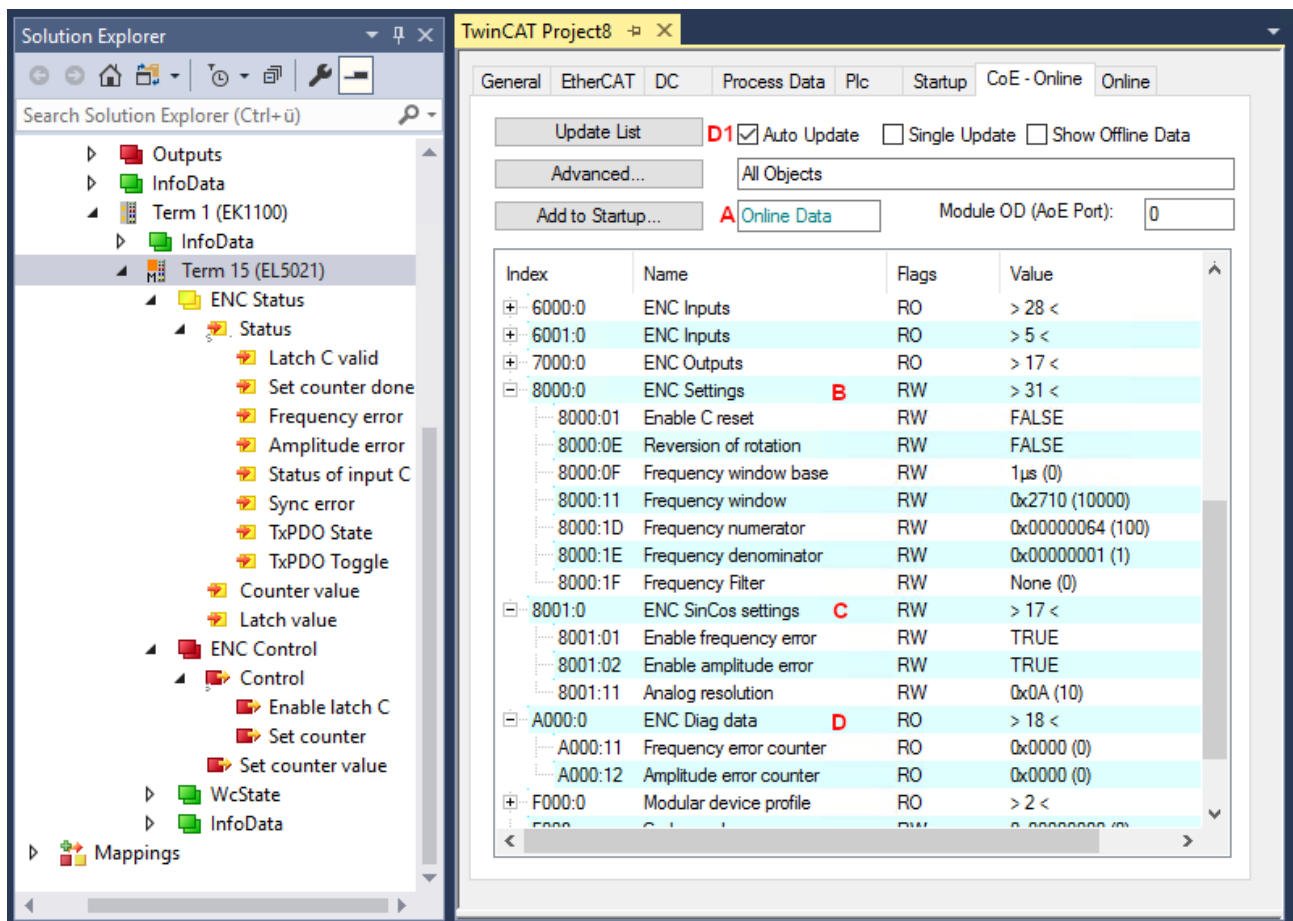

Fig. 144: CoE directory using the EL5021 as an example

If the terminal is online, i.e. connected to the TwinCAT EtherCAT master and in error-free RUN state (WorkingCounter = 0), the online data can be accessed (A).

In the entries Index [0x8000](#) [▶ 148] (B) and Index [0x8001](#) [▶ 148] (C) the entries can be changed online, please also observe the notes on the StartUp list.

Frequency and amplitude errors are counted in the EL5021 and can be read at index [0xA000](#) [▶ 150] - the display is updated continuously in TwinCAT if (D1) has been enabled.

Latch and/or Reset can be activated on the C-signal in the CoE. It is not recommended to activate both functions at the same time.

Latch C input ("C")**Enable and store ("latch") the counter value**

1. Enable the latch C input via the process data "Enable latch C" (Index [0x7000:01 \[▶ 150\]](#)) = TRUE
 - ⇒ At the first external latch pulse (positive edge at input "C") after set bit (TRUE) in index [0x7000:01 \[▶ 150\]](#) the count value is stored in "Latch value" (index [0x6000:12 \[▶ 149\]](#)).
The following pulses at the other inputs have no influence on the latch value in index [0x6000:12 \[▶ 149\]](#) if the bit is set.

●
i **"Latch C valid" bit**

A new counter value at the latch input can only be written once the value of the "Latch C valid" bit (index [0x6000:01 \[▶ 149\]](#)) is FALSE.

Reset

Counter reset (Index [0x8000:01 \[▶ 148\]](#)): The bit in index [0x8000:01 \[▶ 148\]](#) must be set for the counter reset via input C.

Reversal of direction of rotation

The option to reverse the direction of rotation is enabled by setting the bit in index [0x8000:0E \[▶ 148\]](#).

TxPDO State

Index [0x6000:0F \[▶ 149\]](#), TRUE if frequency, amplitude or general error

TxPDO Toggle

Index [0x6000:10 \[▶ 149\]](#), toggles with each new value.

7.6 Functional principles

7.6.1 EL5021-00x0

The following description refers to the EL5021 and EL5021-0090 terminals, both terminals are combined with the designation EL5021.

●
i **Intended use of the EL5021**

The EL5021 is designed for frequencies that remain constant or do not change abruptly. A bouncing signal, such as can occur with a touch probe, causes frequency jumps ("glitches"). The maximum frequencies that occur and the high rate of frequency change can be outside the operating range of the EL5021. Since these distorted signals are no longer recognized by the terminal, they cannot be evaluated and interpreted as a possible error.

7.6.1.1 Position determination

A rotary encoder typically outputs 100..10,000 sine/cosine periods per revolution. The EL5021 can continuously measure, interpolate and convert these two differential analog signals into a position value consisting of

- the number of periods --> period counter
- and the current position within the period --> period portion 0..360°

According to the customer's request, the maximum period portion can be determined with a resolution of 8..13 bits, equivalent to 256.. 8192 steps per 360° sine period. This is set in the CoE, index [0x8001:11 \[▶ 148\]](#) "Analog resolution". This is the theoretical maximum resolution desired by the user, which is also achieved at a standstill or during slow movement.

The actual current resolution depends, however, on the current input frequency of the sine/cosine signal.

1. The resolution automatically decreases as the frequency increases; the bits are frozen starting from the least significant bit (LSB). If the maximum period resolution is set to 12 bits, 6-bit period resolution will still be achieved at the maximum input frequency of typically 80 KHz.
2. If the frequency slows down significantly, the resolution actually achieved increases again.
 - ⇒ There is no online message about the currently applied frozen bits. See also the [sample program \[►_158\]](#).

The conversion to real mechanical revolutions depends on the number of periods per revolution of the encoder employed and is calculated in the PLC or NC.

Preset period resolution [bits]	f _{max} [kHz]	Typical frequency (±15%) at which the automatic reduction of the preset period resolution begins	Min. period resolution at f _{max}
8	250	9000 Hz	
9		4500 Hz	
10 (default)		2500 Hz	
11	170	1500 Hz	
12	80	750 Hz	6 bits
13	40	650 Hz	

If f_{max} is exceeded, a frequency error is displayed (index 0x6001:04 [►_149] "Frequency error"), amplitude errors (level too low, input below limit) are displayed in index 0x6001:05 [►_149] "Amplitude error".

The position is indicated in 32 bits as a composite process data. Depending on the desired max. resolution, these 32 bits are composed, starting from the right (LSB), of:

- Analog part: 8 ... 13 bits according to setting in index 0x8001:11 [►_148] "Analog resolution"
- 24 ... 19 bits for the number of periods, extent given by the number of bits available.

Hence, a sequential 32-bit position value is available that can be linked directly to the NC, for example. The conversion factor in bits/mm must then be set in the NC, taking into account

- the no. of sine periods per mechanical revolution, e.g. 5000
- the selected interpolation resolution, e.g. 10 bits

● Resetting of the counter value on change of period resolution

I When changing the period resolution in CoE (index 0x8001:11 [►_148] "Analog resolution") and "Enable C reset" (index 0x8000:01 [►_148]) the current counter value is reset.

● Display "Period resolution 8-bit"

I In the setting "Period resolution 8-bit", the display of the 32-bit process data corresponds to the EL5101 Encoder terminal with activated micro-increments.

7.6.1.2 Diagnostics

The output of the frequency error as process data "Frequency error" occurs when the max. frequency limit f_{\max} valid for the respective resolution range is exceeded, see chapter [Position determination](#) [► 134].

The output of the amplitude error as process data "Amplitude error" occurs if the sin/cos signal has too low voltage. This can be used in a suitable position for cable breakage detection.

These errors are counted in the CoE object [0xA000](#) [► 150] "ENC Diag Data" and can be read out via SDO access from the PLC as well.

7.6.1.3 Special functions: reset, latch, set position

Latch and/or Reset can be activated on the C-signal in the CoE. It is not recommended to activate both functions at the same time.

Reset

The internal counter is reset immediately to 0 when the C-signal reaches the EL5021.

Latch

When the C-signal reaches the EL5021, a new position determination is started and the last determined position is “latched” (stored); see fig. *“Latching” of a position*, Signal C_A. The latch determination is handled with priority if the latch signal falls in terms of time within the range of the triggered position determination; the regular position determination is then executed immediately afterwards, see signal C_B.

This delay has no meaning in the synchronous operating mode; in DC mode sufficient time reserves are available so that *GetPos* can nevertheless be executed in time for the next EtherCAT cycle, ensuring that current data can be delivered.

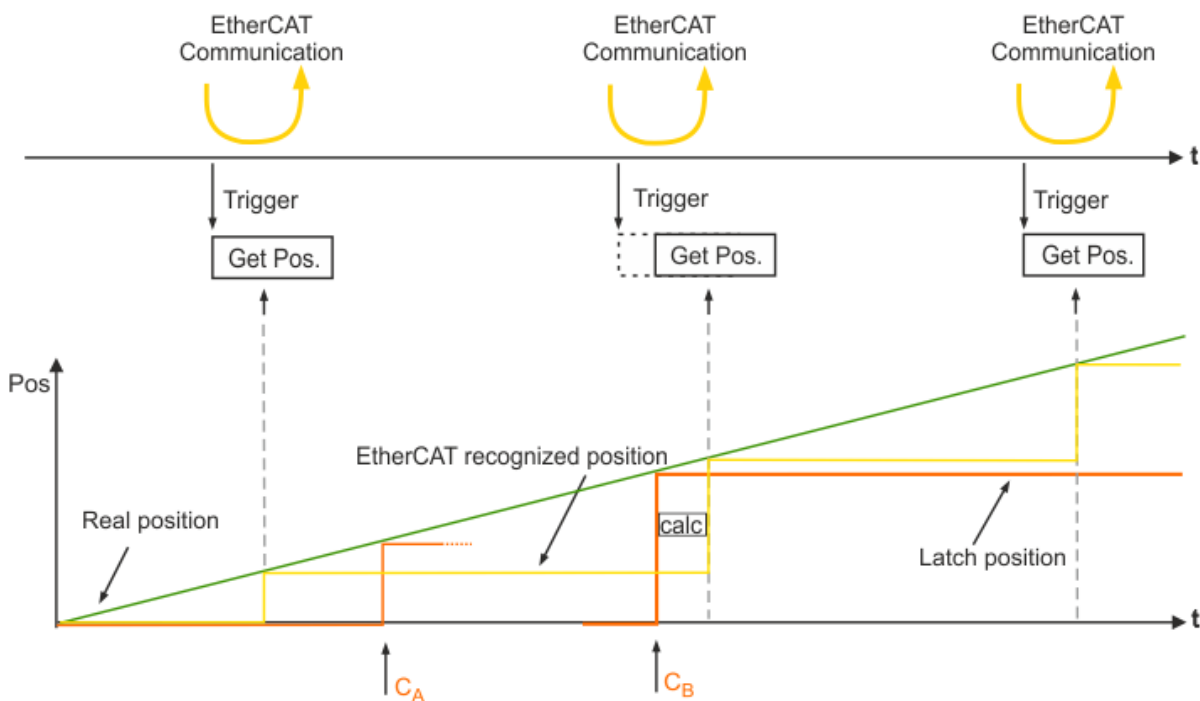

Fig. 145: “Latching” of a position

Set position (set counter)

The position value specified in [0x7000:11 \[► 150\]](#) (counter value) is reset via the index [0x7000:03 \[► 150\]](#).

● Set position

i The use of the “Set position” function is recommended only when the axis is at a standstill.

7.6.1.4 Frequency measurement/velocity measurement

The following objects are used to set the parameters in the EL5021 (from FW07 [▶ 162]) and EL5021-0090 for the calculation of the frequency or velocity. The calculated frequency or velocity is output as a process data in index 0x6000:13 as a 32-bit value or index 0x6000:1A as a 16-bit value.

8000:0	ENC Settings	RW	> 31 <
8000:01	Enable C reset	RW	FALSE
8000:0E	Reversion of rotation	RW	FALSE
8000:0F	Frequency window base	RW	1µs (0)
8000:11	Frequency window	RW	0x2710 (10000)
8000:1D	Frequency numerator	RW	0x00000064 (100)
8000:1E	Frequency denominator	RW	0x00000001 (1)
8000:1F	Frequency Filter	RW	None (0)

Fig. 146: CoE objects, ENC settings

Index (hex)	Name	Meaning	Default
8000:0F	Frequency window base	Sets the unit for the time window of the frequency measurement. Two time units (1 µs, 1 ms) are available	0x00 (1 µs)
8000:11	Frequency window	This is the time used for determining the frequency. The number of periods and the analog part (the period resolution) in the time window is measured and then divided by the time window size. Default value 10 ms [resolution: 1 µs], i.e. a new value is calculated every 10 ms. The determined frequency is output as process data <ul style="list-style-type: none"> in index 0x6000:13 "Frequency value" as 32-bit value or in index 0x6000:1A "Frequency value (int16)" as 16-bit value. The scaling of the output value is determined by <ul style="list-style-type: none"> Index 0x8000:1D "Frequency numerator" and Index 0x8000:1E "Frequency denominator". The frequency calculation is carried out locally without distributed clocks function.	0x2710 (10000 _{dec})
8000:1D	Frequency numerator	Frequency numerator, used for scaling the frequency, cf. frequency scaling [▶ 139] .	0x00000064 (100 _{dec})
8000:1E	Frequency denominator	Frequency denominator value, used for scaling of frequency and velocity calculation, see Frequency scaling [▶ 139] and Example for velocity calculation [▶ 139] .	0x00000001 (1 _{dec})
8000:1F	Frequency Filter	IIR filter	

Frequency scaling

The frequency can be scaled via the two indices 0x8000:1D "Frequency numerator" and 0x8000:1E "Frequency denominator". The entered values yield a fraction. This number must be used as divisor to obtain the unit in hertz, for example:

0x8000:1D "Frequency numerator" = 100

0x8000:1E "Frequency denominator" = 1

- Fraction: 100
- Output of frequency 100: 0.01 Hz

Since a position encoder with sin/cos interface is an analog output signal, in contrast to digital incremental encoders, not only the whole periods are taken into account for the frequency measurement, but also the analog part of the periods. The period determination is set in CoE, index 0x8001:11 "Analog resolution".

The "Counter Value" (0x6000:11) consists of the period counter and the period portion.

Example: Encoder output: 2048 pulses, 0x8001:11 "Analog resolution": 10 bits

- Process data "Counter Value": 32 bits, number of periods 22 bits, analog part 10 bits,
- A full mechanical revolution corresponds to $360^\circ = 2048 \cdot 1024$ pulses = 2097152 increments (2048 periods)

Example for velocity calculation

The velocity calculation is based on the frequency measurement, which is determined as follows:

$f = (S_2 - S_1) / t_f$	
f	frequency to be measured. Via index 0x8000:1D "Frequency numerator" the scaling of the frequency can be determined.
S ₁	Counter value at position 1
S ₂	Counter value at position 2
t _f	Timeframe for frequency determination, this can be set via index 0x8000:0F "Frequency window base" and index 0x8000:11 "Frequency window".

The velocity has the following relationship with the frequency:

$v = f/a$	
v	velocity to be calculated
f	measured frequency
a	Conversion factor [pulses/unit] for the velocity. This is entered in index 0x8000:1D "Frequency numerator" and 0x8000:1E "Frequency denominator"

The conversion factor a can be determined as follows:

Example for velocity calculation in m/s:

12 mm travel path corresponds to a full mechanical revolution and therefore a "Counter Value" of 2097152 increments (2048 periods).

- $a = 2048 \text{ periods} / 12 \text{ mm} = 170.666667 \text{ periods/mm} = 170666.667 \text{ periods/m}$

The output of the measured value essentially depends on the unit in which the frequency is determined and on the unit in which the conversion factor is specified.

Index (hex)	Name	Example for set value	Comment
8000:1D	Frequency numerator	100	Output of the value in 0.01 Hz
8000:1E	Frequency denominator	170666667	Conversion factor a in pulses/mm

In this case the velocity is output in index 0x6000:13 "Frequency value" as 32-bit value or 0x6000:1A "Frequency value (int16)" as 16-bit value in the following unit:

$$\text{Comparison of units: } v = \frac{f}{a} = \frac{0,01\text{Hz}}{\text{impulses/mm}} = \frac{0,01 \times 1/s}{\text{impulses} \times \frac{1000}{m}} = 0,00001 \frac{m}{s}$$

Fig. 147: Formula for velocity calculation: 0.00001 m/s

This means the value must be multiplied by 0.00001 to get the unit in m/s. To get a high resolution of the output value, the values in 0x8000:1D "Frequency numerator" and 0x8000:1E "Frequency denominator" should be specified in the same order of magnitude if possible.

Example for velocity calculation in revolutions/min:

After a full revolution the "Counter Value" is 2048 periods.

- A = 2048 periods / 1 revolution = 2048 periods / revolution

The output of the measured value essentially depends on the unit in which the frequency is determined and on the unit in which the conversion factor is specified.

Index (hex)	Name	Example for set value	Comment
8000:1D	Frequency numerator	6000	Output of the value in 0.01 rpm
8000:1E	Frequency denominator	2048	Conversion factor in periods/revolution

In this case the velocity is output in index 0x6000:13 "Frequency value" as 32-bit value or 0x6000:1A "Frequency value (int16)" as 16-bit value in the following unit:

$$\begin{aligned} \text{Comparison of units: } v &= \frac{f}{a} = \frac{0,01\text{Hz}}{\text{impulses/revolution}} = \frac{0,01 \times 1/s}{\text{impulses/revolution}} \\ &= 0,01 \frac{\text{revolutions}}{s} = 0,6 \frac{\text{revolutions}}{\text{min}} \end{aligned}$$

Fig. 148: Formula velocity calculation: revolutions/s, revolutions/min

This means the value must be multiplied by 0.01 to get the unit in revolutions/s, or multiplication by 0.6 for revolutions/min.

To get a high resolution of the output value, the values in 0x8000:1D "Frequency numerator" and 0x8000:1E "Frequency denominator" should be specified in the same order of magnitude if possible.

7.6.1.5 Filter operation

Frequency filter (index 0x8000:1F [▶ 148])

The EL5021 (from FW07 [▶ 162]) and EL5021-0090 terminals incorporate a digital filter which can adopt the characteristics of a *Finite Impulse Response* filter (an *FIR filter*), or an *Infinite Impulse Response* filter (an *IIR filter*). The filter is deactivated by default.

IIR filter

The filter with IIR characteristics is a discrete time, linear, time invariant filter that can be set to eight levels (level 1 = weak recursive filter, up to level 8 = strong recursive filter).

The IIR can be understood as a sliding average value calculation after a low-pass filter.

Here, the IIR filters work cycle-synchronously and are thus updated depending on the cycle time.



IIR filter

Difference equation: $Y_n = X_n * a_0 + Y_{n-1} * b_1$
 with $a_0 + b_1 = 1$
 $a_0 =$ (see table)
 $b_1 = 1 - a_0$

Frequency Filter 0x8000:1F	Value	PDO update time	Filter property	Comment	Rise time 10-90% [samples] (typ.)
0	None	-	-	Filter disabled	-
1	IIR 1	Cycle-synchronous (up to min. 100 µs)	Low-pass filter	$a_0 = 1/2^1 = 0.5$	3
2	IIR 2			$a_0 = 1/2^2 = 0.25$	8
3	IIR 3			$a_0 = 1/2^3 = 0.125$	17
4	IIR 4			$a_0 = 1/2^4 = 0.0625$	34
5	IIR 5			$a_0 = 1/2^5 = 0.03125$	69
6	IIR 6			$a_0 = 1/2^6 = 0.015625$	140
7	IIR 7			$a_0 = 1/2^7 = 0.0078125$	280
8	IIR 8			$a_0 = 1/2^8 = 0.00390625$	562

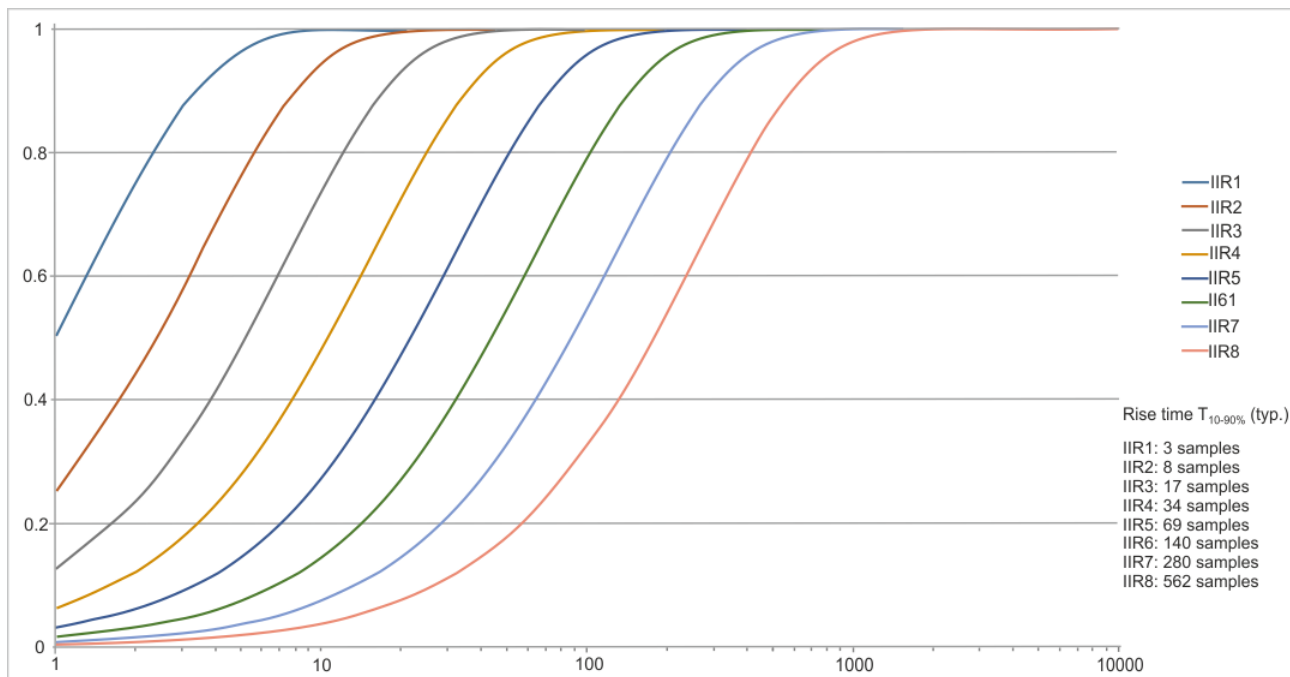

Fig. 149: Rise time $T_{10-90\%}$ (typ.)

7.6.2 EL5021-0090

The EL5021-0090 supports the full functionality of the EL5021 (please refer to chapter “[EL5021-00x0 \[► 134\]](#) operating principle”).

In addition, the EL5021-0090 supports the TwinSAFE SC technology and frequency or velocity measurement.

7.6.2.1 TwinSAFE SC

7.6.2.1.1 TwinSAFE SC - operating principle

The TwinSAFE SC (Single Channel) technology enables the use of standard signals for safety tasks in any networks of fieldbuses. To do this, EtherCAT Terminals from the areas of analog input, angle/displacement measurement or communication (4...20 mA, incremental encoder, IO-Link, etc.) are extended by the TwinSAFE SC function. The typical signal characteristics and standard functionalities of the I/O components are retained. TwinSAFE SC I/Os have a yellow strip at the front of the housing to distinguish them from standard I/Os.

The TwinSAFE SC technology enables communication via a TwinSAFE protocol. These connections can be distinguished from the usual safe communication via Safety over EtherCAT.

The data of the TwinSAFE SC components are transferred via a TwinSAFE protocol to the TwinSAFE logic, where they can be used in the context of safety-relevant applications. Detailed examples for the correct application of the TwinSAFE SC components and the respective normative classification, which were confirmed/calculated by TÜV SÜD, can be found in the [TwinSAFE application manual](#).

7.6.2.1.2 TwinSAFE SC - configuration

The TwinSAFE SC technology enables communication with standard EtherCAT terminals via the Safety over EtherCAT protocol. These connections use another checksum, in order to be able to distinguish between TwinSAFE SC and TwinSAFE. Eight fixed CRCs can be selected, or a free CRC can be entered by the user.

By default the TwinSAFE SC communication channel of the respective TwinSAFE SC component is not enabled. In order to be able to use the data transfer, the corresponding TwinSAFE SC module must first be added under the Slots tab. Only then is it possible to link to a corresponding alias device.

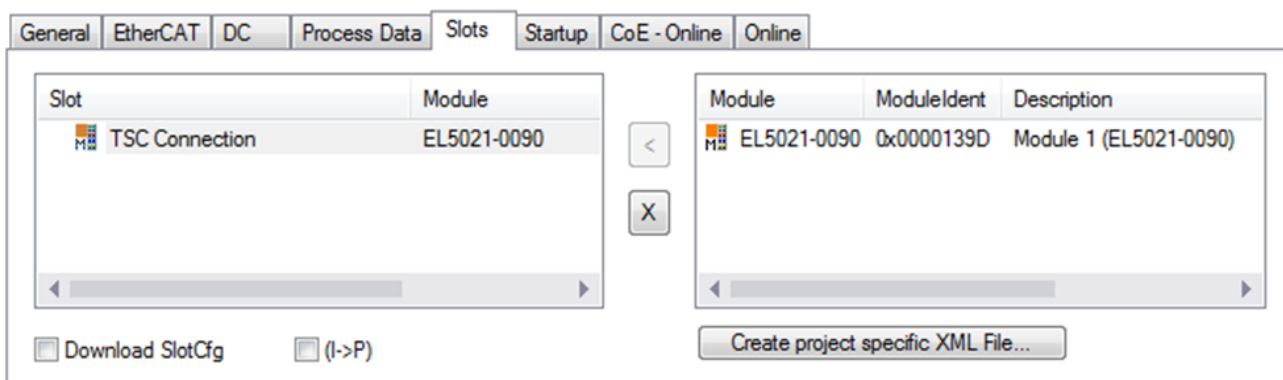

Fig. 150: Adding the TwinSAFE SC process data under the component, e.g. EL5021-0090

Additional process data with the ID TSC Inputs, TSC Outputs are generated (TSC - TwinSAFE Single Channel).

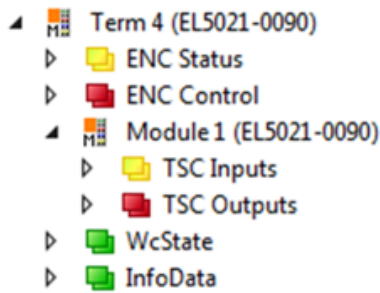

Fig. 151: TwinSAFE SC component process data, example EL5021-0090

A TwinSAFE SC connection is added by adding an alias devices in the safety project and selecting TSC (*TwinSAFE Single Channel*)

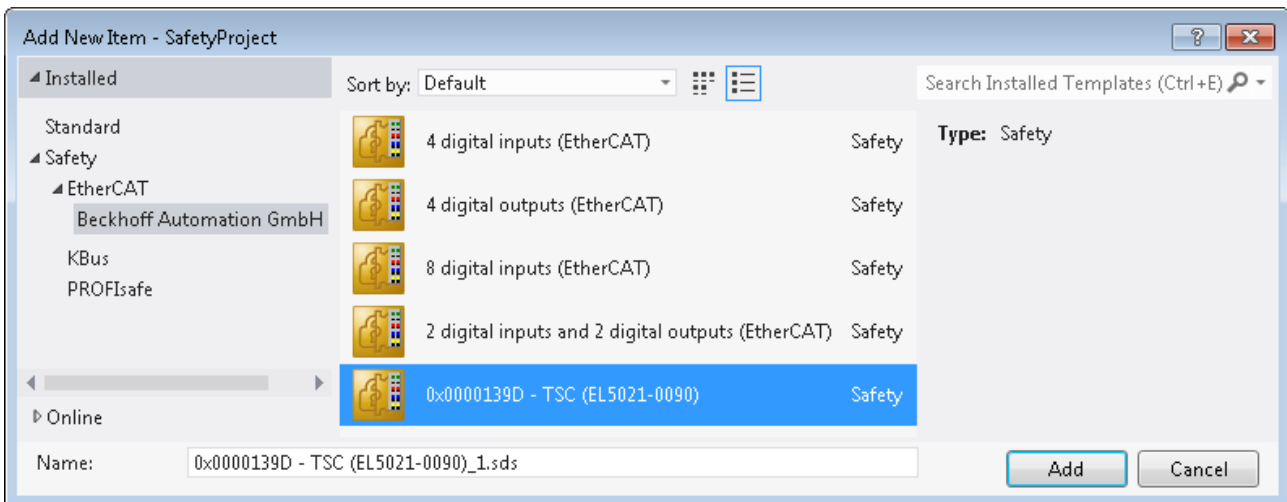



Fig. 152: Adding a TwinSAFE SC connection

After opening the alias device by double-clicking, select the Link button  next to *Physical Device*, in order to create the link to a TwinSAFE SC terminal. Only suitable TwinSAFE SC terminals are offered in the selection dialog.

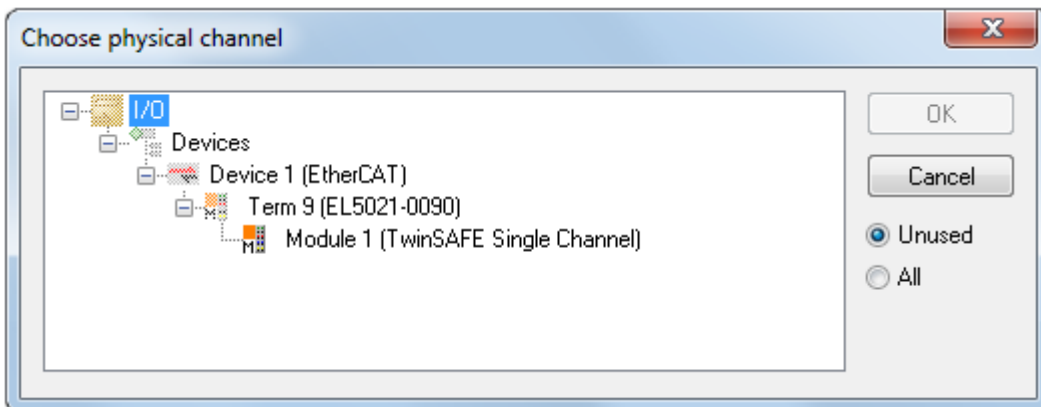

Fig. 153: Creating a link to TwinSAFE SC terminal

The CRC to be used can be selected or a free CRC can be entered under the Connection tab of the alias device.

Entry Mode	Used CRCs
TwinSAFE SC CRC 1 master	0x17B0F
TwinSAFE SC CRC 2 master	0x1571F
TwinSAFE SC CRC 3 master	0x11F95
TwinSAFE SC CRC 4 master	0x153F1
TwinSAFE SC CRC 5 master	0x1F1D5
TwinSAFE SC CRC 6 master	0x1663B
TwinSAFE SC CRC 7 master	0x1B8CD
TwinSAFE SC CRC 8 master	0x1E1BD

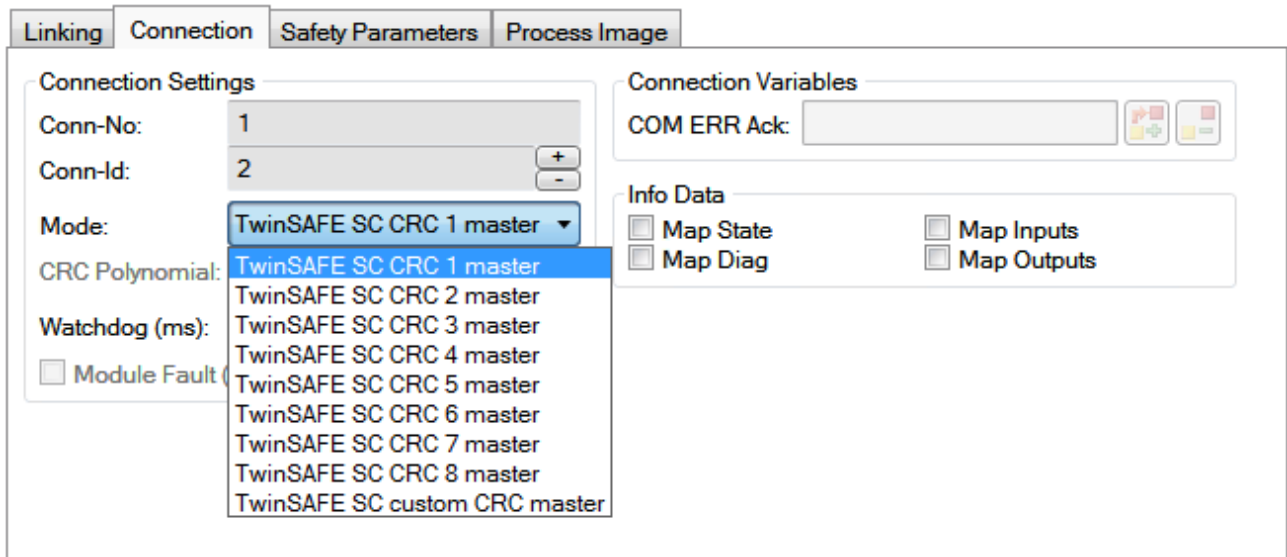

Fig. 154: Selecting a free CRC

These settings must match the settings in the CoE objects of the TwinSAFE SC component. The TwinSAFE SC component initially makes all available process data available. The *Safety Parameters* tab typically contains no parameters. The process data size and the process data themselves can be selected under the *Process Image* tab.

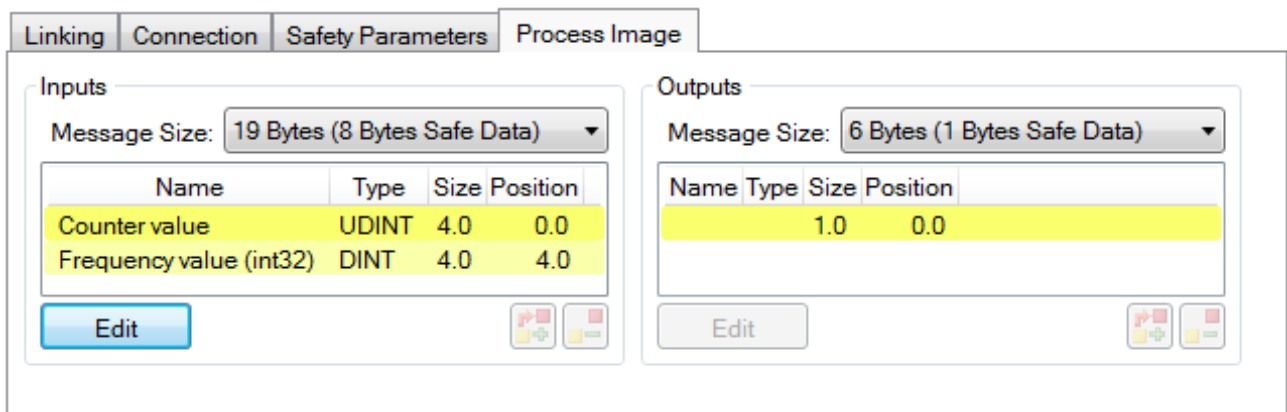

Fig. 155: Selecting the process data size and the process data

The process data (defined in the ESI file) can be adjusted to user requirements by selecting the *Edit* button in the dialog *Configure I/O element(s)*.

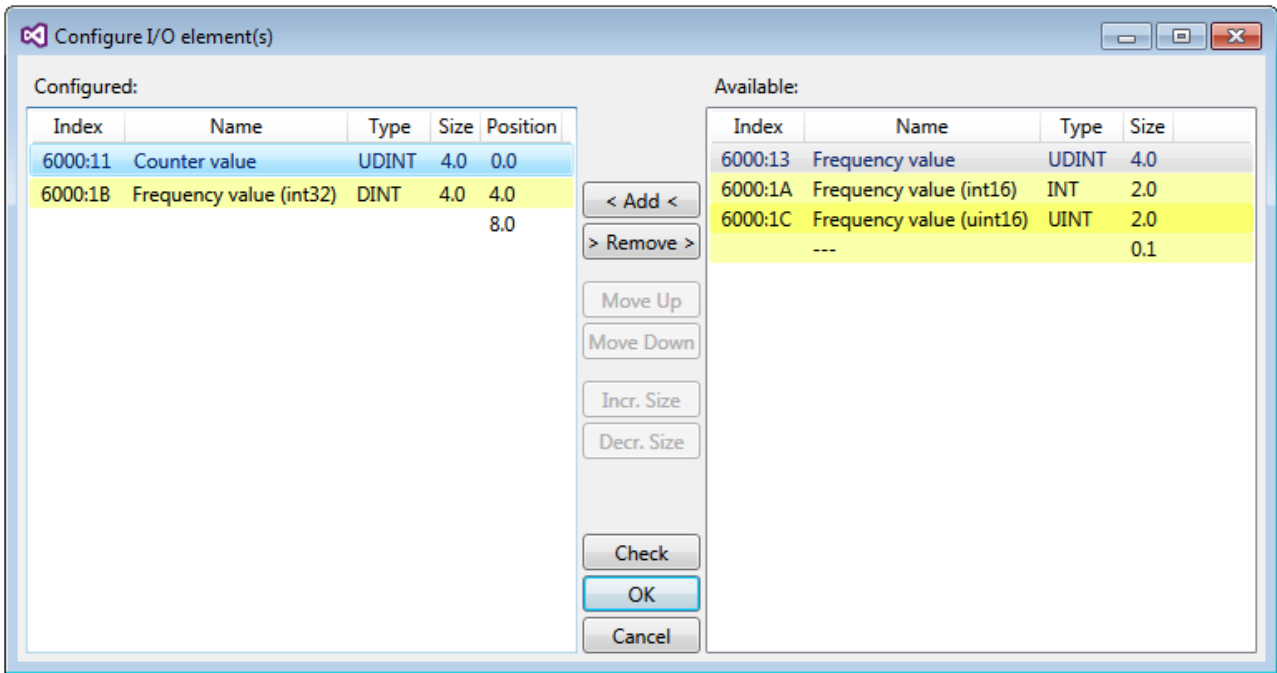

Fig. 156: Selection of the process data

The safety address together with the CRC must be entered on the TwinSAFE SC slave side. This is done via the CoE objects under *TSC settings* of the corresponding TwinSAFE SC component (here, for example, EL5021-0090, 0x8010: 01 and 0x8010: 02). The address set here must also be set in the *alias device* as *FSoE* address under the *Linking* tab.

Under the object 0x80n0:02 Connection Mode the CRC to be used is selected or a free CRC is entered. A total of 8 CRCs are available. A free CRC must start with 0x00ff in the high word.

8010:0	TSC Settings	RW	> 2 <
8010:01	Address	RW	0x0000 (0)
8010:02	Connection Mode	RW	TwinSAFE SC CRC1 master (97039)

Fig. 157: CoE objects 0x8010:01 and 0x8010:02

Object TSC Settings

Depending on the terminal, the index designation of the configuration object *TSC Settings* can vary. Example:

- EL3214-0090 and EL3314-0090, TSC Settings, Index 8040
- EL5021-0090, TSC Settings, Index 8010
- EL6224-0090, TSC Settings, Index 800F

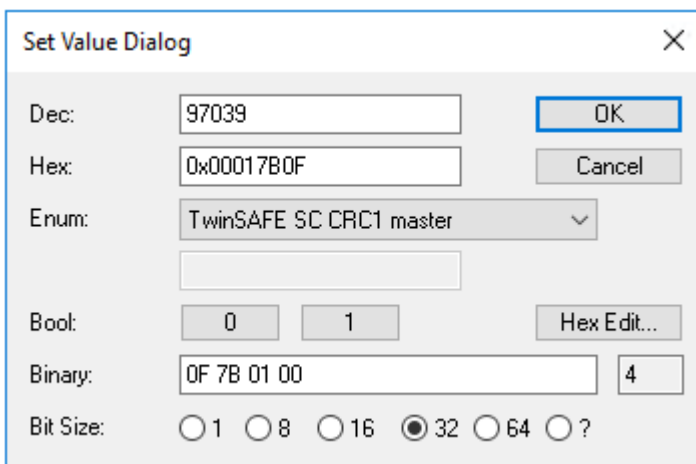

Fig. 158: Entering the safety address and the CRC

**TwinSAFE SC connections**

If several TwinSAFE SC connections are used within a configuration, a different CRC must be selected for each TwinSAFE SC connection.

7.7 EL5021-00x0 - Object description and parameterization

EtherCAT XML Device Description

The display matches that of the CoE objects from the EtherCAT XML Device Description. We recommend downloading the latest XML file from the download area of the Beckhoff website and installing it according to installation instructions.

NOTICE



Parameterization via the CoE list (CAN over EtherCAT)

The EtherCAT device is parameterized via the CoE - Online tab (with a double click on the respective object) or via the Process Data tab (assignment of PDOs). A detailed description can be found in the EtherCAT System-Documentation in chapter “EtherCAT subscriber configuration”

Please note the general CoE notes in the EtherCAT System Documentation in chapter “CoE-interface” when using/manipulating the CoE parameters:

- Keep a startup list if components have to be replaced
- Differentiation between online/offline dictionary,
- existence of current XML description
- use "CoE reload" for resetting changes

Introduction

The CoE overview contains objects for different intended applications:

- Objects required for parameterization during commissioning:
 - [Restore object \[► 147\]](#)
 - [Configuration data \[► 148\]](#)
- Profile-specific objects (0x6000-0xFFFF):
 - [Input data \[► 149\]](#)
 - [Output data \[► 150\]](#)
 - [Information and diagnostic data \[► 150\]](#)

Profile-specific objects have the same meaning for all EtherCAT slaves that support the profile 5001.

- Standard objects (0x1000-0x1FFF) that display internal settings and may not be changeable. The standard objects have the same meaning for all EtherCAT slaves.

The following section first describes the objects required for normal operation, followed by a complete overview of missing objects.

7.7.1 Restore object

Index 1011 Restore default parameters

Index (hex)	Name	Meaning	Data type	Flags	Default
1011:0	Restore default parameters [► 175]	Restore default parameters	UINT8	RO	0x01 (1 _{dec})
1011:01	SubIndex 001	If this object is set to “ 0x64616F6C ” in the set value dialog, all backup objects are reset to their delivery state.	UINT32	RW	0x00000000 (0 _{dec})

7.7.2 Configuration data

Index 8000 ENC Settings

Index (hex)	Name	Meaning	Data type	Flags	Default
8000:0	ENC Settings	Maximum subindex	UINT8	RO	0x1F (31 _{dec})
8000:01	Enable C reset	The counter is reset via the C input.	BOOLEAN	RW	0x00 (0 _{dec})
8000:0E	Reversion of rotation	Activates reversion of rotation	BOOLEAN	RW	0x00 (0 _{dec})
8000:0F	Frequency window base	Basic unit of the "frequency window" (index 0x8000:11) 0: μ s 1: ms	BIT1	RW	0x00 (0 _{dec})
8000:11	Frequency window	This is the time used for determining the frequency. The number of periods and the analog part (the period resolution) in the timeframe is measured and then divided by the timeframe size. Default value 10 ms [resolution: 1 μ s], i.e. a new value is calculated every 10 ms. The determined frequency is output as process data in index 0x6000:13 [▶ 149] as 32-bit value, or in index 0x6000:1A [▶ 149] as 16-bit value. The scaling of the output value is determined by objects 0x8000:0D and 0x8000:1E.	UINT16	RW	0x2710 (10000 _{dec})
8000:1D	Frequency numerator	Frequency counter value, frequency scaling	UINT32	RW	0x00000064 (100 _{dec})
8000:1E	Frequency denominator	frequency counter value, used for scaling the frequency and the velocity calculation (increments / unit).	UINT32	RW	0x00000001 (1 _{dec})
8000:1F	Frequency Filter [▶ 141]	IIR filter permitted values: 0: None 1: IIR1 2: IIR 2 3: IIR 3 4: IIR 4 5: IIR 5 6: IIR 6 7: IIR 7 8: IIR 8	UINT16	RW	0x0000 (0 _{dec})

Index 8001 ENC SinCos settings

Index (hex)	Name	Meaning	Data type	Flags	Default
8001:0	ENC SinCos settings	Maximum subindex	UINT8	RO	0x11 (17 _{dec})
8001:01	Enable frequency error	Activates the "frequency error" counter	BOOLEAN	RW	0x01 (1 _{dec})
8001:02	Enable amplitude error	Activates the "amplitude error" counter	BOOLEAN	RW	0x01 (1 _{dec})
8001:11	Analog resolution	Period resolution in bits (default: 10 bits)	UINT8	RW	0x0A (10 _{dec})

Index 8010 TSC Settings (EL5021-0090 only)

Index (hex)	Name	Meaning	Data type	Flags	Default
8010:0	TSC Settings	Maximum subindex	UINT8	RO	0x02 (2 _{dec})
8010:01	Address	TwinSAFE SC address	UINT16	RW	0x0000 (0 _{dec})
8010:02	Connection Mode	Selection of TwinSAFE SC CRC	UINT32	RO	0x00000000 (0 _{dec})

7.7.3 Input data

Index 6000 ENC Inputs

Index (hex)	Name	Meaning	Data type	Flags	Default
6000:0	ENC Inputs	Maximum subindex	UINT8	RO	0x1A (26 _{dec})
6000:01	Latch C valid	The counter value was latched with the "C" input. The data with index 0x6000:12 [▶ 149] match the latched value when the bit is set. To reactivate the latch input, index 0x7000:01 [▶ 150] must be cancelled and then reset.	BOOLEAN	RO	0x00 (0 _{dec})
6000:03	Set counter done	The counter was set.	BOOLEAN	RO	0x00 (0 _{dec})
6000:0B	Status of input C	Status of input C	BOOLEAN	RO	0x00 (0 _{dec})
6000:0E	Sync error	The Sync error bit is only required for DC mode. It indicates whether a synchronization error has occurred during the previous cycle.	BOOLEAN	RO	0x00 (0 _{dec})
6000:0F	TxPDO State	The TxPDO state is TRUE in the case of frequency, amplitude or general errors	BOOLEAN	RO	0x00 (0 _{dec})
6000:10	TxPDO Toggle	The TxPDO toggle is toggled by the slave when the data of the associated TxPDO is updated	BOOLEAN	RO	0x00 (0 _{dec})
6000:11	Counter value	Counter value	UINT32	RO	0x00000000 (0 _{dec})
6000:12	Latch value	Latch value	UINT32	RO	0x00000000 (0 _{dec})
6000:13	Frequency value	Frequency (32-bit value)	INT32	RO	0x00000000 (0 _{dec})
6000:1A	Frequency value (int16)	Frequency (16-bit value)	INT16	RO	0x0000 (0 _{dec})
6000:1B	Frequency value (int16)	Frequency (32-bit value)	INT16	RO	0x00000000 (0 _{dec})
6000:1C	Frequency value (int16)	Frequency (16-bit value)	INT16	RO	0x0000 (0 _{dec})

Index 6001 ENC Inputs

Index (hex)	Name	Meaning	Data type	Flags	Default
6001:0	ENC Inputs	Maximum subindex	UINT8	RO	0x05 (5 _{dec})
6001:04	Frequency error	TRUE: Frequency error, permissible frequency f_{max} exceeded (if the preset period resolution is 10 bits, then $f_{max} = 250$ kHz)	BOOLEAN	RO	0x00 (0 _{dec})
6001:05	Amplitude error	TRUE: Amplitude error, input voltage below limit	BOOLEAN	RO	0x00 (0 _{dec})

Index 6010 TSC Slave Frame Elements (EL5021-0090 only)

Index (hex)	Name	Meaning	Data type	Flags	Default
6010:0	TSC Slave Frame Elements	Maximum subindex	UINT8	RO	0x0A (10 _{dec})
6010:01	TSC__Slave Cmd	reserved	UINT8	RO	0x00 (0 _{dec})
6010:02	TSC__Slave ConnID	reserved	UINT16	RO	0x0000 (0 _{dec})
6010:03	TSC__Slave CRC_0	reserved	UINT16	RO	0x0000 (0 _{dec})
6010:04	TSC__Slave CRC_1	reserved	UINT16	RO	0x0000 (0 _{dec})
6010:05	TSC__Slave CRC_2	reserved	UINT16	RO	0x0000 (0 _{dec})
6010:06	TSC__Slave CRC_3	reserved	UINT16	RO	0x0000 (0 _{dec})
6010:07	TSC__Slave CRC_4	reserved	UINT16	RO	0x0000 (0 _{dec})
6010:08	TSC__Slave CRC_5	reserved	UINT16	RO	0x0000 (0 _{dec})
6010:09	TSC__Slave CRC_6	reserved	UINT16	RO	0x0000 (0 _{dec})
6010:010	TSC__Slave CRC_7	reserved	UINT16	RO	0x0000 (0 _{dec})

7.7.4 Output data

Index 7000 ENC Outputs

Index (hex)	Name	Meaning	Data type	Flags	Default
7000:0	ENC Outputs	Maximum subindex	UINT8	RO	0x11 (17 _{dec})
7000:01	Enable latch C	Activate latching via input "C".	BOOLEAN	RO	0x00 (0 _{dec})
7000:03	Set counter	Set counter	BOOLEAN	RO	0x00 (0 _{dec})
7000:11	Set counter value	This is the counter value to be set via "Set counter" (index 0x7000:03 [▶ 150]).	UINT32	RO	0x00000000 (0 _{dec})

Index 7010 TSC Master Frame Elements (EL5021-0090 only)

Index (hex)	Name	Meaning	Data type	Flags	Default
7010:0	TSC Master Frame Elements	Maximum subindex	UINT8	RO	0x03 (3 _{dec})
7010:01	TSC__Master Cmd	reserved	UINT8	RO	0x00 (0 _{dec})
7010:02	TSC__Master ConnID	reserved	UINT16	RO	0x0000 (0 _{dec})
7010:03	TSC__Master CRC_0	reserved	UINT16	RO	0x0000 (0 _{dec})

7.7.5 Information / diagnostic data

Index A000 ENC Diag data

Index (hex)	Name	Meaning	Data type	Flags	Default
A000:0	ENC Diag data	Maximum subindex	UINT8	RO	0x12 (18 _{dec})
A000:11	Frequency error counter	Number of "frequency" errors	UINT16	RO	0x0000 (0 _{dec})
A000:12	Amplitude error counter	Number of "amplitude" errors	UINT16	RO	0x0000 (0 _{dec})

7.7.6 Standard objects

Index 1000 Device type

Index (hex)	Name	Meaning	Data type	Flags	Default
1000:0	Device type	Device type of the EtherCAT slave: The Lo-Word contains the CoE profile used (5001). The Hi-Word contains the module profile according to the modular device profile.	UINT32	RO	EL5021: 0x01FF1389 EL5021-0090: 0x00001389

Index 1008 Device name

Index (hex)	Name	Meaning	Data type	Flags	Default
1008:0	Device name	Device name of the EtherCAT slave	STRING	RO	EL5021 EL5021-0090

Index 1009 Hardware version

Index (hex)	Name	Meaning	Data type	Flags	Default
1009:0	Hardware version	Hardware version of the EtherCAT slave	STRING	RO	

Index 100A Software version

Index (hex)	Name	Meaning	Data type	Flags	Default
100A:0	Software version	Firmware version of the EtherCAT slave	STRING	RO	-

Index 1018 Identity

Index (hex)	Name	Meaning	Data type	Flags	Default
1018:0	Identity	Information for identifying the slave	UINT8	RO	0x04 (4 _{dec})
1018:01	Vendor ID	Vendor ID of the EtherCAT slave	UINT32	RO	0x00000002 (2 _{dec})
1018:02	Product code	Product code of the EtherCAT slave	UINT32	RO	0x139D3052 (329068626 _{dec})
1018:03	Revision	Revision number of the EtherCAT slave; the low word (bit 0-15) indicates the special terminal number, the high word (bit 16-31) refers to the device description	UINT32	RO	0x00000000 (0 _{dec})
1018:04	Serial number	Serial number of the EtherCAT slave; the low byte (bit 0-7) of the low word contains the year of production, the high byte (bit 8-15) of the low word contains the week of production, the high word (bit 16-31) is 0	UINT32	RO	0x00000000 (0 _{dec})

Index 10F0 Backup parameter handling

Index (hex)	Name	Meaning	Data type	Flags	Default
10F0:0	Backup parameter handling	Information for standardized loading and saving of backup entries	UINT8	RO	0x01 (1 _{dec})
10F0:01	Checksum	Checksum across all backup entries of the EtherCAT slave	UINT32	RO	0x00000000 (0 _{dec})

Index 1600 ENC RxPDO-Map Control

Index (hex)	Name	Meaning	Data type	Flags	Default
1600:0	ENC RxPDO-Map Control	PDO Mapping RxPDO 1	UINT8	RO	0x05 (5 _{dec})
1600:01	SubIndex 001	1. PDO Mapping entry (object 0x7000 (ENC Outputs), entry 0x01 (Enable latch C))	UINT32	RO	0x7000:01, 1
1600:02	SubIndex 002	2. PDO Mapping entry (1 bits align)	UINT32	RO	0x0000:00, 1
1600:03	SubIndex 003	3. PDO Mapping entry (object 0x7000 (ENC Outputs), entry 0x03 (Set counter))	UINT32	RO	0x7000:03, 1
1600:04	SubIndex 004	4. PDO Mapping entry (13 bits align)	UINT32	RO	0x0000:00, 13
1600:05	SubIndex 005	5. PDO Mapping entry (object 0x7000 (ENC Outputs), entry 0x11 (Set counter value))	UINT32	RO	0x7000:11, 32

Index 1610 TSC RxPDO-Map Master Message (EL5021-0090 only)

Index (hex)	Name	Meaning	Data type	Flags	Default
1610:0	TSC RxPDO-Map Master Message	PDO Mapping RxPDO 17	UINT8	RO	0x04 (4 _{dec})
1610:01	SubIndex 001	1. PDO Mapping entry (object 0x7010 (TSC Master Frame Elements), entry 0x01 (TSC__Master Cmd))	UINT32	RO	0x7010:01, 8
1610:02	SubIndex 002	2. PDO Mapping entry (8 bits align)	UINT32	RO	0x0000:00, 8
1610:03	SubIndex 003	3. PDO Mapping entry (object 0x7010 (TSC Master Frame Elements), entry 0x03 (TSC__Master CRC_0))	UINT32	RO	0x7010:03, 16
1610:04	SubIndex 004	4. PDO Mapping entry (object 0x7010 (TSC Master Frame Elements), entry 0x02 (TSC__Master ConnID))	UINT32	RO	0x7010:02, 16

Index 1A00 ENC TxPDO-Map Status

Index (hex)	Name	Meaning	Data type	Flags	Default
1A00:0	ENC TxPDO-Map Status	PDO Mapping TxPDO 1	UINT8	RO	0x0D (13 _{dec})
1A00:01	SubIndex 001	1. PDO Mapping entry (object 0x6000 (ENC Inputs), entry 0x01 (Latch C valid))	UINT32	RO	0x6000:01, 1
1A00:02	SubIndex 002	2. PDO Mapping entry (1 bits align)	UINT32	RO	0x0000:00, 1
1A00:03	SubIndex 003	3. PDO Mapping entry (object 0x6000 (ENC Inputs), entry 0x03 (Set counter done))	UINT32	RO	0x6000:03, 1
1A00:04	SubIndex 004	4. PDO Mapping entry (object 0x6001 (ENC Inputs), entry 0x04 (Frequency error))	UINT32	RO	0x6001:04, 1
1A00:05	SubIndex 005	5. PDO Mapping entry (object 0x6001 (ENC Inputs), entry 0x05 (Amplitude error))	UINT32	RO	0x6001:05, 1
1A00:06	SubIndex 006	6. PDO Mapping entry (5 bits align)	UINT32	RO	0x0000:00, 5
1A00:07	SubIndex 007	7. PDO Mapping entry (object 0x6000 (ENC Inputs), entry 0x0B (Status of input C))	UINT32	RO	0x6000:0B, 1
1A00:08	SubIndex 008	8. PDO Mapping entry (2 bits align)	UINT32	RO	0x0000:00, 2
1A00:09	SubIndex 009	9. PDO Mapping entry (object 0x6000 (ENC Inputs), entry 0x0E (Sync error))	UINT32	RO	0x6000:0E, 1
1A00:0A	SubIndex 010	10. PDO Mapping entry (object 0x6000 (ENC Inputs), entry 0x0F (TxPDO State))	UINT32	RO	0x6000:0F, 1
1A00:0B	SubIndex 011	11. PDO Mapping entry (object 0x6000 (ENC Inputs), entry 0x10 (TxPDO Toggle))	UINT32	RO	0x6000:10, 1
1A00:0C	SubIndex 012	12. PDO Mapping entry (object 0x6000 (ENC Inputs), entry 0x11 (Counter value))	UINT32	RO	0x6000:11, 32
1A00:0D	SubIndex 013	13. PDO Mapping entry (object 0x6000 (ENC Inputs), entry 0x12 (Latch value))	UINT32	RO	0x6000:12, 32

Index 1A01 ENC TxPDO-Map Frequency (int32)

Index (hex)	Name	Meaning	Data type	Flags	Default
1A01:0	ENC TxPDO-Map Frequency (int32)	PDO Mapping TxPDO 2	UINT8	RO	0x01 (1 _{dec})
1A01:01	SubIndex 001	1. PDO Mapping entry (object 0x6000 (ENC Inputs), entry 0x1B (Frequency value (int32)))	UINT32	RO	0x6000:1B, 32

Index 1A02 ENC TxPDO-Map Frequency (uint32)

Index (hex)	Name	Meaning	Data type	Flags	Default
1A02:0	ENC TxPDO-Map Frequency (uint32)	PDO Mapping TxPDO 3	UINT8	RO	0x01 (1 _{dec})
1A02:01	SubIndex 001	1. PDO Mapping entry (object 0x6000 (ENC Inputs), entry 0x13 (Frequency value (uint32)))	UINT32	RO	0x6000:13, 32

Index 1A10 TSC TxPDO-Map Slave Message (EL5021-0090 only)

Index (hex)	Name	Meaning	Data type	Flags	Default
1A10:0	TSC TxPDO-Map Slave Message	PDO Mapping TxPDO 17	UINT8	RW	0x12 (18 _{dec})
1A10:01	SubIndex 001	1. PDO Mapping entry (object 0x6010 (TSC Slave Frame Elements), entry 0x01 (TSC__Slave Cmd))	UINT32	RW	0x6010:01, 8
1A10:02	SubIndex 002	2. PDO Mapping entry (object 0x6000 (ENC Inputs), entry 0x11 (Counter value))	UINT32	RW	0x6000:11, 16
1A10:03	SubIndex 003	3. PDO Mapping entry (object 0x6010 (TSC Slave Frame Elements), entry 0x03 (TSC__Slave CRC_0))	UINT32	RW	0x6010:03, 16
1A10:04	SubIndex 004	4. PDO Mapping entry (16 bits align)	UINT32	RW	0x0000:00, 16
1A10:05	SubIndex 005	5. PDO Mapping entry (object 0x6010 (TSC Slave Frame Elements), entry 0x04 (TSC__Slave CRC_1))	UINT32	RW	0x6010:04, 16
1A10:06	SubIndex 006	6. PDO Mapping entry (object 0x6000 (ENC Inputs), entry 0x13 (Frequency value))	UINT32	RW	0x6000:13, 16
1A10:07	SubIndex 007	7. PDO Mapping entry (object 0x6010 (TSC Slave Frame Elements), entry 0x05 (TSC__Slave CRC_2))	UINT32	RW	0x6010:05, 16
1A10:08	SubIndex 008	8. PDO Mapping entry (16 bits align)	UINT32	RW	0x0000:00, 16
1A10:09	SubIndex 009	9. PDO Mapping entry (object 0x6010 (TSC Slave Frame Elements), entry 0x06 (TSC__Slave CRC_3))	UINT32	RW	0x6010:06, 16
1A10:0A	SubIndex 010	10. PDO Mapping entry (object 0x6000 (ENC Inputs), entry 0x1A (Frequency Value (int16)))	UINT32	RW	0x6000:1A, 16
1A10:0B	SubIndex 011	11. PDO Mapping entry (object 0x6010 (TSC Slave Frame Elements), entry 0x07 (TSC__Slave CRC_4))	UINT32	RW	0x6010:07, 16
1A10:0C	SubIndex 012	12. PDO Mapping entry (object 0x6000 (ENC Inputs), entry 0x1B (Frequency Value (int32)))	UINT32	RW	0x6000:1B, 16
1A10:0D	SubIndex 013	13. PDO Mapping entry (object 0x6010 (TSC Slave Frame Elements), entry 0x08 (TSC__Slave CRC_5))	UINT32	RW	0x6010:08, 16
1A10:0E	SubIndex 014	14. PDO Mapping entry (16 bits align)	UINT32	RW	0x0000:00, 16
1A10:0F	SubIndex 015	15. PDO Mapping entry (object 0x6010 (TSC Slave Frame Elements), entry 0x08 (TSC__Slave CRC_6))	UINT32	RW	0x6010:09, 16
1A10:10	SubIndex 016	16. PDO Mapping entry (object 0x6000 (ENC Inputs), entry 0x1C (Frequency Value (uint16)))	UINT32	RW	0x6000:1C, 16
1A10:11	SubIndex 017	17. PDO Mapping entry (object 0x6010 (TSC Slave Frame Elements), entry 0x0A (TSC__Slave CRC_7))	UINT32	RW	0x6010:0A, 16
1A10:12	SubIndex 018	18. PDO Mapping entry (object 0x6010 (TSC Slave Frame Elements), entry 0x02 (TSC__Slave ConnID))	UINT32	RW	0x6010:02, 16

Index 1C00 Sync manager type

Index (hex)	Name	Meaning	Data type	Flags	Default
1C00:0	Sync manager type	Using the sync managers	UINT8	RO	0x04 (4 _{dec})
1C00:01	SubIndex 001	Sync-Manager Type Channel 1: Mailbox Write	UINT8	RO	0x01 (1 _{dec})
1C00:02	SubIndex 002	Sync-Manager Type Channel 2: Mailbox Read	UINT8	RO	0x02 (2 _{dec})
1C00:03	SubIndex 003	Sync-Manager Type Channel 3: Process Data Write (Outputs)	UINT8	RO	0x03 (3 _{dec})
1C00:04	SubIndex 004	Sync-Manager Type Channel 4: Process Data Read (Inputs)	UINT8	RO	0x04 (4 _{dec})

Index 1C12 RxPDO assign

Index (hex)	Name	Meaning	Data type	Flags	Default
1C12:0	RxPDO assign	PDO Assign Outputs	UINT8	RW	0x02 (2 _{dec})
1C12:01	Subindex 001	1. allocated RxPDO (contains the index of the associated RxPDO mapping object)	UINT16	RW	0x1600 (5632 _{dec})
1C12:02**)	Subindex 002	2. allocated RxPDO (contains the index of the associated RxPDO mapping object)	UINT16	RW	0x1610 (5648 _{dec})

**) only for EL5021-0090

Index 1C13 TxPDO assign

Index (hex)	Name	Meaning	Data type	Flags	Default
1C13:0	TxPDO assign	PDO Assign Inputs	UINT8	RW	0x02 (2 _{dec})
1C13:01	Subindex 001	1. allocated TxPDO (contains the index of the associated TxPDO mapping object)	UINT16	RW	0x1A00 (6656 _{dec})
1C13:02**)	Subindex 002	2. allocated TxPDO (contains the index of the associated TxPDO mapping object)	UINT16	RW	0x1A10 (6672 _{dec})
1C13:03	Subindex 003	3. allocated TxPDO (contains the index of the associated TxPDO mapping object)	UINT16	RW	0x0000 (0 _{dec})
1C13:04**)	Subindex 004	4. allocated TxPDO (contains the index of the associated TxPDO mapping object)	UINT16	RW	0x0000 (0 _{dec})

**) only for EL5021-0090

Index 1C32 SM output parameter

Index (hex)	Name	Meaning	Data type	Flags	Default
1C32:0	SM output parameter	Synchronization parameters for the outputs	UINT8	RO	0x20 (32 _{dec})
1C32:01	Sync mode	Current synchronization mode: <ul style="list-style-type: none"> • 0: Free Run • 1: Synchron with SM 2 Event • 2: DC-Mode - Synchron with SYNC0 Event • 3: DC-Mode - Synchron with SYNC1 Event 	UINT16	RW	0x0001 (1 _{dec})
1C32:02	Cycle time	Cycle time (in ns): <ul style="list-style-type: none"> • Free Run: Cycle time of the local timer • Synchronous with SM 2 event: Master cycle time • DC mode: SYNC0/SYNC1 Cycle Time 	UINT32	RW	0x000F4240 (1000000 _{dec})
1C32:03	Shift time	Time between SYNC0 event and output of the outputs (in ns, DC mode only)	UINT32	RO	0x00003CF0 (15600 _{dec})
1C32:04	Sync modes supported	Supported synchronization modes: <ul style="list-style-type: none"> • Bit 0 = 1: free run is supported • Bit 1 = 1: Synchronous with SM 2 event is supported • Bit 2-3 = 01: DC mode is supported • Bit 4-5 = 10: Output shift with SYNC1 event (only DC mode) • Bit 14 = 1: dynamic times (measurement through writing of 0x1C32:08 [▶ 155]) 	UINT16	RO	0x440B (17419 _{dec})
1C32:05	Minimum cycle time	Minimum cycle time (in ns)	UINT32	RO	0x0000F3C0 (62400 _{dec})
1C32:06	Calc and copy time	Minimum time between SYNC0 and SYNC1 event (in ns, DC mode only)	UINT32	RO	0x00000000 (0 _{dec})
1C32:07	Minimum delay time	Minimum time between SYNC1 event and output of the outputs (in ns, only DC mode)	UINT32	RO	0x00003CF0 (15600 _{dec})
1C32:08	Command	<ul style="list-style-type: none"> • 0: Measurement of the local cycle time is stopped • 1: Measurement of the local cycle time is started <p>The entries 0x1C32:03 [▶ 155], 0x1C32:05 [▶ 155], 0x1C32:06 [▶ 155], 0x1C32:09 [▶ 155], 0x1C33:03 [▶ 156], 0x1C33:06 [▶ 155], 0x1C33:09 [▶ 156] are updated with the maximum measured values. For a subsequent measurement the measured values are reset</p>	UINT16	RW	0x0000 (0 _{dec})
1C32:09	Maximum delay time	Time between SYNC1 event and output of the outputs (in ns, DC mode only)	UINT32	RO	0x00003CF0 (15600 _{dec})
1C32:0B	SM event missed counter	Number of missed SM events in OPERATIONAL (DC mode only)	UINT16	RO	0x0000 (0 _{dec})
1C32:0C	Cycle exceeded counter	Number of occasions the cycle time was exceeded in OPERATIONAL (cycle was not completed in time or the next cycle began too early)	UINT16	RO	0x0000 (0 _{dec})
1C32:0D	Shift too short counter	Number of occasions that the interval between SYNC0 and SYNC1 event was too short (DC mode only)	UINT16	RO	0x0000 (0 _{dec})
1C32:14	Frame repeat time		UINT32	RW	0x00000000 (0 _{dec})
1C32:20	Sync error	The synchronization was not correct in the last cycle (outputs were output too late; DC mode only)	BOOLEAN	RO	0x00 (0 _{dec})

Index 1C33 SM input parameter

Index (hex)	Name	Meaning	Data type	Flags	Default
1C33:0	SM input parameter	Synchronization parameters for the inputs	UINT8	RO	0x20 (32 _{dec})
1C33:01	Sync mode	Current synchronization mode: <ul style="list-style-type: none"> • 0: Free Run • 1: Synchronous with SM 3 Event (no outputs available) • 2: DC - Synchron with SYNC0 Event • 3: DC - Synchron with SYNC1 Event • 34: Synchronous with SM 2 Event (outputs available) 	UINT16	RW	0x0022 (34 _{dec})
1C33:02	Cycle time	as 0x1C32:02 [▶ 155]	UINT32	RW	0x000F4240 (1000000 _{dec})
1C33:03	Shift time	Time between SYNC0 event and reading of the inputs (in ns, only DC mode)	UINT32	RO	0x000015E0 (5600 _{dec})
1C33:04	Sync modes supported	Supported synchronization modes: <ul style="list-style-type: none"> • Bit 0: free run is supported • Bit 1: Synchronous with SM 2 Event is supported (outputs available) • Bit 1: Synchronous with SM 3 Event is supported (no outputs available) • Bit 2-3 = 01: DC mode is supported • Bit 4-5 = 01: Input shift through local event (outputs available) • Bit 4-5 = 10: Input shift with SYNC1 event (no outputs available) • Bit 14 = 1: dynamic times (measurement through writing of 0x1C32:08 [▶ 155] or 0x1C33:08 [▶ 156]) 	UINT16	RO	0x440B (17419 _{dec})
1C33:05	Minimum cycle time	as 0x1C32:05 [▶ 155]	UINT32	RO	0x0000F3C0 (62400 _{dec})
1C33:06	Calc and copy time	Time between reading of the inputs and availability of the inputs for the master (in ns, only DC mode)	UINT32	RO	0x00000000 (0 _{dec})
1C33:07	Minimum delay time		UINT32	RO	0x000015E0 (5600 _{dec})
1C33:08	Command	as 0x1C32:08 [▶ 155]	UINT16	RW	0x0000 (0 _{dec})
1C33:09	Maximum delay time	Time between SYNC1 event and reading of the inputs (in ns, only DC mode)	UINT32	RO	0x000015E0 (5600 _{dec})
1C33:0B	SM event missed counter	as 0x1C32:11 [▶ 155]	UINT16	RO	0x0000 (0 _{dec})
1C33:0C	Cycle exceeded counter	as 0x1C32:12 [▶ 155]	UINT16	RO	0x0000 (0 _{dec})
1C33:0D	Shift too short counter	as 0x1C32:13 [▶ 155]	UINT16	RO	0x0000 (0 _{dec})
1C33:14	Frame repeat time		UINT32	RW	0x00000000 (0 _{dec})
1C33:20	Sync error	as 0x1C32:32 [▶ 155]	BOOLEAN	RO	0x00 (0 _{dec})

Index F000 Modular device profile

Index (hex)	Name	Meaning	Data type	Flags	Default
F000:0	Modular device profile	General information for the modular device profile	UINT8	RO	0x02 (2 _{dec})
F000:01	Module index distance	Index distance of the objects of the individual channels	UINT16	RO	0x0010 (16 _{dec})
F000:02	Maximum number of modules	Number of channels	UINT16	RO	EL5021: 0x0001 (1 _{dec}) EL5021-0090: 0x0002 (2 _{dec})

Index F008 Code word

Index (hex)	Name	Meaning	Data type	Flags	Default
F008:0	Code word	reserved	UINT32	RW	0x00000000 (0 _{dec})

Index F010 Module list

Index (hex)	Name	Meaning	Data type	Flags	Default
F010:0	Module list	Maximum subindex	UINT8	RW	0x02 (2 _{dec})
F010:01	SubIndex 001	reserved	UINT32	RW	0x000001FF (511 _{dec})
F010:02**)	SubIndex 002	reserved	UINT32	RW	0x000003B6 (950 _{dec})

**) only for EL5021-0090

Index F082 MDP Profile Compatibility

Index (hex)	Name	Meaning	Data type	Flags	Default
F082:0	MDP profile compatibility	Maximum subindex	UINT8	RO	0x01 (1 _{dec})
F082:01	Compatible input cycle counter	reserved	BOOLEAN	RW	0x00 (0 _{dec})

7.8 Sample Program

i Using the sample programs

This document contains sample applications of our products for certain areas of application. The application notes provided here are based on typical features of our products and only serve as examples. The notes contained in this document explicitly do not refer to specific applications. The customer is therefore responsible for assessing and deciding whether the product is suitable for a particular application. We accept no responsibility for the completeness and correctness of the source code contained in this document. We reserve the right to modify the content of this document at any time and accept no responsibility for errors and missing information.

 Download <https://infosys.beckhoff.com/content/1033/el5021/Resources/1920574091/.zip>

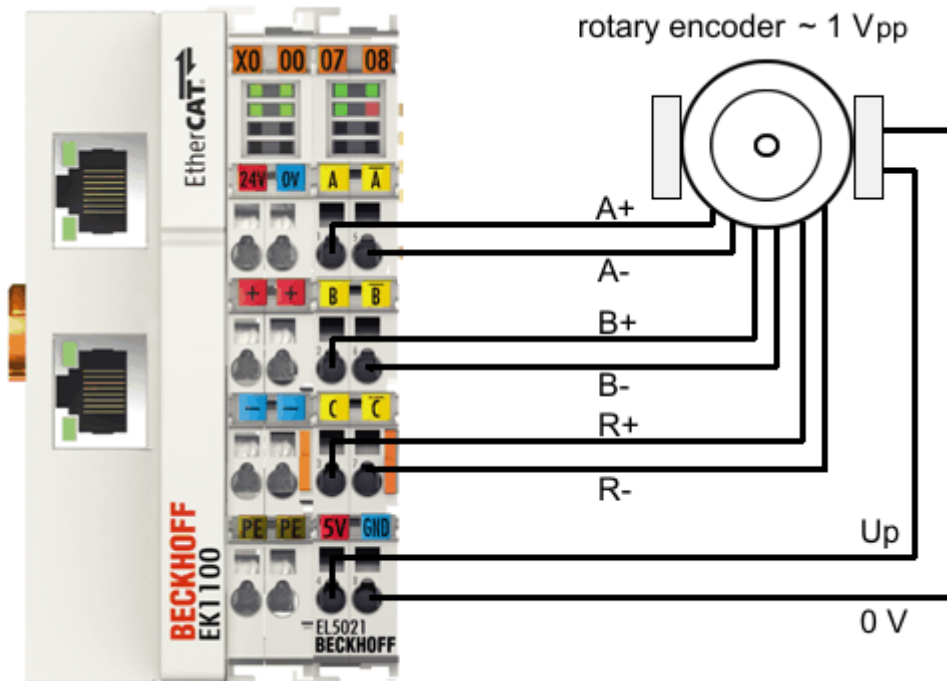

Fig. 159: Connection for sample program

Starting the sample program

The application examples have been tested with a test configuration and are described accordingly. Certain deviations when setting up actual applications are possible.

The following hardware and software were used for the test configuration:

- TwinCAT Master PC with Windows XP Professional SP 3 operating system and TwinCAT version 2.11
- Beckhoff EK1100 EtherCAT coupler, EL5021-0000-0017 and EL9011 terminals.
- Rotary encoder $\sim 1 V_{pp}$

The sample program contains

- display of the process data, operation of the outputs
- calculation of the mechanical position, taking into account the bit shifting
- continuous read-out of the CoE directory and setting in case of change

Procedure for starting the program

- After clicking the Download button, save the zip file locally on your hard disk, and unzip the *.TSM (configuration) and the *.PRO (PLC program) files into a temporary working folder.

- The *.pro file can be opened by double click or by the TwinCAT PLC Control application with menu selection “File/ Open”. The *.tsm file is provided for the TwinCAT System Manager (to review or overtake configurations).
- Connect the hardware in accordance with fig. [Connection for sample program \[▶_158\]](#) and connect the Ethernet adapter of your PC to the EtherCAT coupler (further information on this can be found in the corresponding coupler manuals)
- Select the local Ethernet adapter (with real-time driver, if applicable) under System configuration, I/O configuration, I/O devices, Device (EtherCAT); then on the “Adapter” tab choose “Search...”, select the appropriate adapter and confirm (see Fig. *Searching the Ethernet adapter + Selection and confirmation of the Ethernet adapter*).

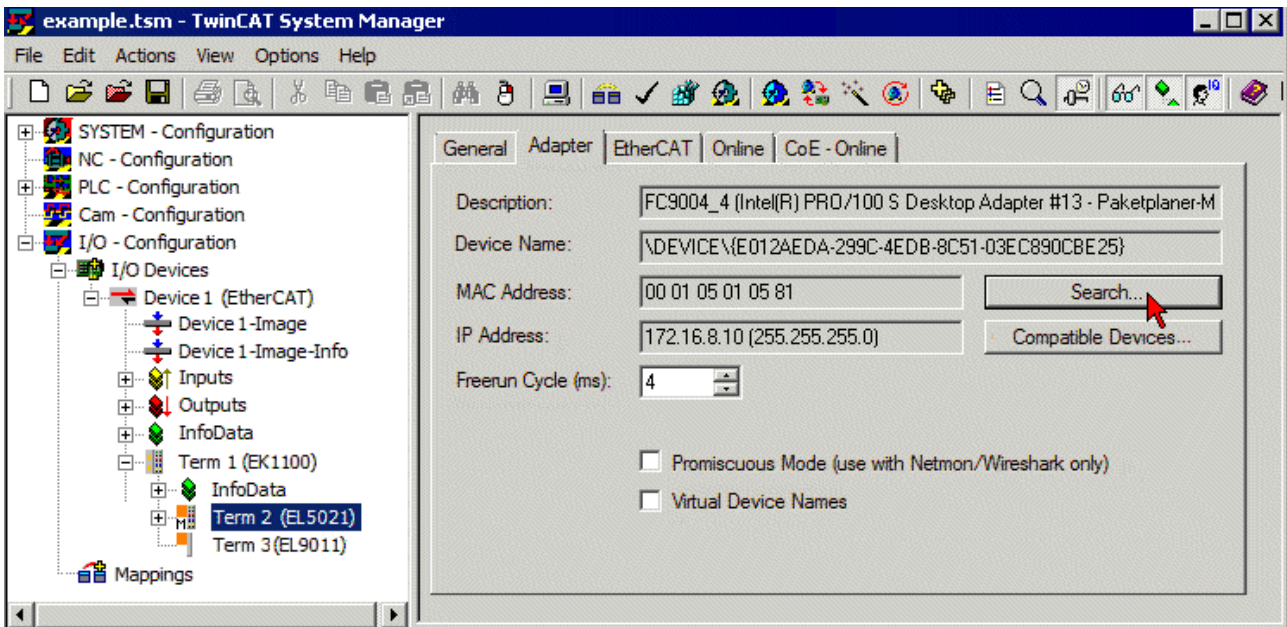

Fig. 160: Searching the Ethernet adapter



Fig. 161: Selection and confirmation of the Ethernet adapter

- Activate and confirm the configuration (Fig. *Activation of the configuration + Confirming the activation of the configuration*)



Fig. 162: Activation of the configuration

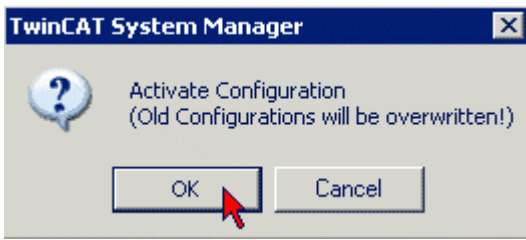

Fig. 163: Confirming the activation of the configuration

- Confirm new variable mapping, restart in RUN mode (Fig. *Generate variable mapping + Restarting TwinCAT in RUN mode*)

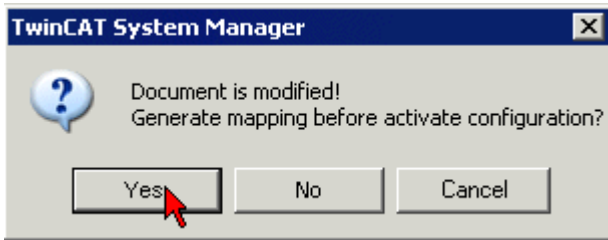

Fig. 164: Generating variable mapping

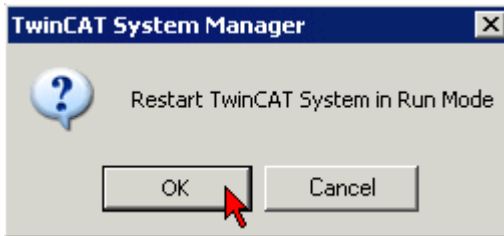

Fig. 165: Restarting TwinCAT in RUN mode

- In TwinCAT PLC, under the “Project” menu, select “Rebuild all” to compile the project (Fig. *Compile project*)

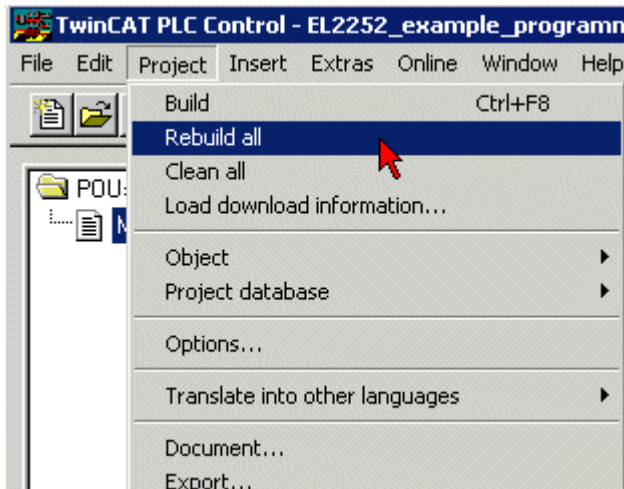

Fig. 166: Compile project

- In TwinCAT PLC: log in with the “F11” button, confirm loading the program (Fig. *Confirming program start*), run the program with the “F5” button

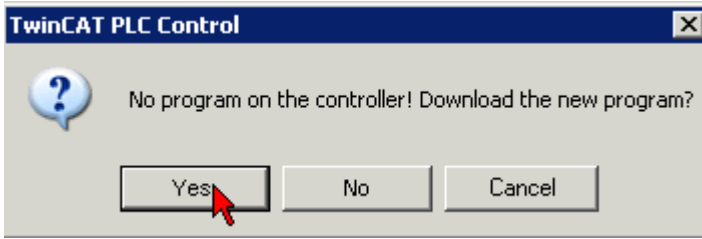

Fig. 167: Confirming program start

EL5021 Demo

Current Inputs

Status: C reset enabled	Status: Sync Error
Status: Set Counter Done	Status: TxPDO State
Status: Frequency Error	Status: TxPDO Toggle
Status: Amplitude Error	
Status: Status of C	Cnt C: 27

Current Outputs

Control: Enable Latch C
Control: Set Counter

EtherCAT Diagnosis

WcState: FALSE
WcState: 8

Counter Calculations (Position from EL5021)

Counter: 4293084161	CounterMax: 4294967271	CounterMin: 0	CounterDiff: 2264
UP Cnt Up: 55718			
DOWN Cnt Down: 63570			
Latch: 0			

Current Position - calculated

Current Position	Status: ok
Mech. Round: 2047	Sensor Periods per mech. Rnd: 2048
Period Cnt: 209	C Reset enabled
Period Pos.: [10 bit: 0..1024] 512	

Mech Pos.
360°

Period Pos.
360°

CoE from Slave

	Name	Idx	Typ	Value	Access	Read Updates	Cnt Write
1	CoE Reset	x1011:01	INT 32bit	0	ok	203	0
2	Enable C reset	x8000:01	BOOL 8bit	0	ok	203	4
3	Reversion of rotation	x8000:0E	BOOL 8bit	1	ok	203	2
4	Enable Frequency Error	x8001:01	BOOL 8bit	0	ok	203	2
5	Enable Amplitude Error	x8001:02	BOOL 8bit	1	ok	202	0
6	Analog Resolution	x8001:11	BYTE 8bit	10	ok	202	0
7	Frequency Error Counter	xA000:11	WORD 16bit	27220	ok	202	0
8	Amplitude Error Counter	xA000:12	WORD 16bit	112	ok	202	0

CoE Reset to x1011:01: 16#64616f6c = 1684107116

Fig. 168: PLC visualization screenshot

8 Appendix

8.1 EtherCAT AL Status Codes

For detailed information please refer to the [EtherCAT system description](#).

8.2 Firmware compatibility

Beckhoff EtherCAT devices are delivered with the latest available firmware version. Compatibility of firmware and hardware is mandatory; not every combination ensures compatibility. The overview below shows the hardware versions on which a firmware can be operated.

Note

- It is recommended to use the newest possible firmware for the respective hardware
- Beckhoff is not under any obligation to provide customers with free firmware updates for delivered products.

NOTICE

Risk of damage to the device!

Pay attention to the instructions for firmware updates on the [separate page \[▶ 163\]](#).

If a device is placed in BOOTSTRAP mode for a firmware update, it does not check when downloading whether the new firmware is suitable.

This can result in damage to the device! Therefore, always make sure that the firmware is suitable for the hardware version!

EL5021			
Hardware (HW)	Firmware (FW)	Revision no.	Release date
00 - 09*	01	EL5021-0000-0016	2010/07
		EL5021-0000-0017	2010/09
	02		2010/09
	03		2011/03
	04		2012/07
		EL5021-0000-0018	2012/08
		EL5021-0000-0019	2014/11
	05	EL5021-0000-0020	2015/03
		EL5021-0000-0021	2016/05
07*	EL5021-0000-0022	2019/12	

EL5021-0090			
Hardware (HW)	Firmware (FW)	Revision no.	Release date
07 - 09*	06	EL5021-0090-0018	2017/05
		EL5021-0090-0019	2016/05
	07*		2019/12

*) This is the current compatible firmware/hardware version at the time of the preparing this documentation. Check on the Beckhoff web page whether more up-to-date [documentation](#) is available.

8.3 Firmware Update EL/ES/EM/ELM/EP/EPP/ERPxxxx

This section describes the device update for Beckhoff EtherCAT slaves from the EL/ES, ELM, EM, EK, EP, EPP and ERP series. A firmware update should only be carried out after consultation with Beckhoff support.

NOTICE

Only use TwinCAT 3 software!

A firmware update of Beckhoff IO devices must only be performed with a TwinCAT 3 installation. It is recommended to build as up-to-date as possible, available for free download on the [Beckhoff website](#).

To update the firmware, TwinCAT can be operated in the so-called FreeRun mode, a paid license is not required.

The device to be updated can usually remain in the installation location, but TwinCAT has to be operated in the FreeRun. Please make sure that EtherCAT communication is trouble-free (no LostFrames etc.).

Other EtherCAT master software, such as the EtherCAT Configurator, should not be used, as they may not support the complexities of updating firmware, EEPROM and other device components.

Storage locations

An EtherCAT slave stores operating data in up to three locations:

- Each EtherCAT slave has a device description, consisting of identity (name, product code), timing specifications, communication settings, etc.
This device description (ESI; EtherCAT Slave Information) can be downloaded from the Beckhoff website in the download area as a [zip file](#) and used in EtherCAT masters for offline configuration, e.g. in TwinCAT.
Above all, each EtherCAT slave carries its device description (ESI) electronically readable in a local memory chip, the so-called **ESI EEPROM**. When the slave is switched on, this description is loaded locally in the slave and informs it of its communication configuration; on the other hand, the EtherCAT master can identify the slave in this way and, among other things, set up the EtherCAT communication accordingly.

NOTICE

Application-specific writing of the ESI-EEPROM

The ESI is developed by the device manufacturer according to ETG standard and released for the corresponding product.

- Meaning for the ESI file: Modification on the application side (i.e. by the user) is not permitted.
- Meaning for the ESI EEPROM: Even if a writeability is technically given, the ESI parts in the EEPROM and possibly still existing free memory areas must not be changed beyond the normal update process. Especially for cyclic memory processes (operating hours counter etc.), dedicated memory products such as EL6080 or IPC's own NOVDRAM must be used.

- Depending on functionality and performance EtherCAT slaves have one or several local controllers for processing I/O data. The corresponding program is the so-called **firmware** in *.efw format.
- In some EtherCAT slaves the EtherCAT communication may also be integrated in these controllers. In this case the controller is usually a so-called **FPGA** chip with *.rbf firmware.

Customers can access the data via the EtherCAT fieldbus and its communication mechanisms. Acyclic mailbox communication or register access to the ESC is used for updating or reading of these data.

The TwinCAT System Manager offers mechanisms for programming all three parts with new data, if the slave is set up for this purpose. Generally the slave does not check whether the new data are suitable, i.e. it may no longer be able to operate if the data are unsuitable.

Simplified update by bundle firmware

The update using so-called **bundle firmware** is more convenient: in this case the controller firmware and the ESI description are combined in a *.efw file; during the update both the firmware and the ESI are changed in the terminal. For this to happen it is necessary

- for the firmware to be in a packed format: recognizable by the file name, which also contains the revision number, e.g. ELxxxx-xxxx_REV0016_SW01.efw

- for password=1 to be entered in the download dialog. If password=0 (default setting) only the firmware update is carried out, without an ESI update.
- for the device to support this function. The function usually cannot be retrofitted; it is a component of many new developments from year of manufacture 2016.

Following the update, its success should be verified

- ESI/Revision: e.g. by means of an online scan in TwinCAT ConfigMode/FreeRun – this is a convenient way to determine the revision
- Firmware: e.g. by looking in the online CoE of the device

NOTICE

Risk of damage to the device!

✓ Note the following when downloading new device files

a) Firmware downloads to an EtherCAT device must not be interrupted

b) Flawless EtherCAT communication must be ensured. CRC errors or LostFrames must be avoided.

c) The power supply must adequately dimensioned. The signal level must meet the specification.

⇒ In the event of malfunctions during the update process the EtherCAT device may become unusable and require re-commissioning by the manufacturer.

8.3.1 Device description ESI file/XML

NOTICE

Attention regarding update of the ESI description/EEPROM

Some slaves have stored calibration and configuration data from the production in the EEPROM. These are irretrievably overwritten during an update.

The ESI device description is stored locally on the slave and loaded on start-up. Each device description has a unique identifier consisting of slave name (9 characters/digits) and a revision number (4 digits). Each slave configured in the System Manager shows its identifier in the EtherCAT tab:

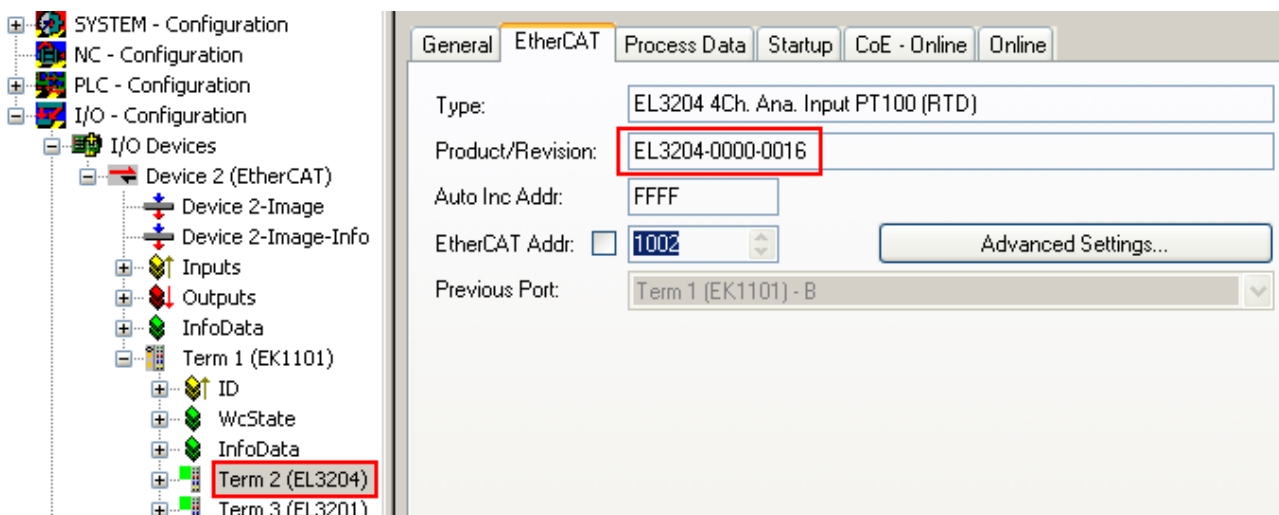

Fig. 169: Device identifier consisting of name EL3204-0000 and revision -0016

The configured identifier must be compatible with the actual device description used as hardware, i.e. the description which the slave has loaded on start-up (in this case EL3204). Normally the configured revision must be the same or lower than that actually present in the terminal network.

For further information on this, please refer to the [EtherCAT system documentation](#).

i Update of XML/ESI description

The device revision is closely linked to the firmware and hardware used. Incompatible combinations lead to malfunctions or even final shutdown of the device. Corresponding updates should only be carried out in consultation with Beckhoff support.

Display of ESI slave identifier

The simplest way to ascertain compliance of configured and actual device description is to scan the EtherCAT boxes in TwinCAT mode Config/FreeRun:

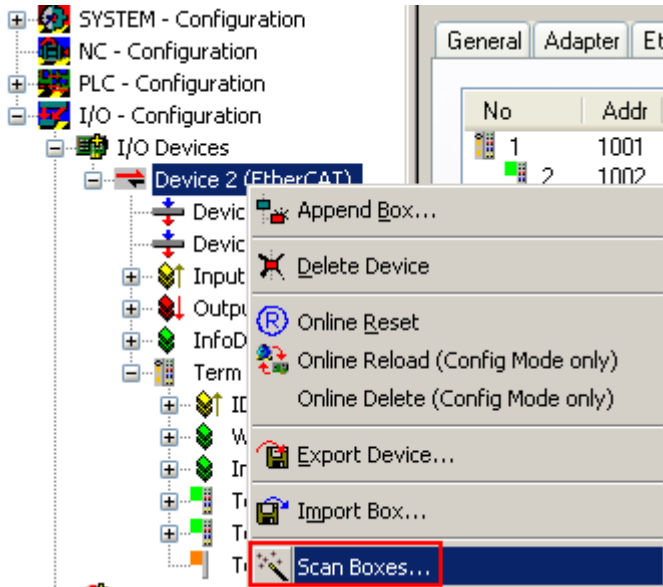

Fig. 170: Scan the subordinate field by right-clicking on the EtherCAT device

If the found field matches the configured field, the display shows



Fig. 171: Configuration is identical

otherwise a change dialog appears for entering the actual data in the configuration.

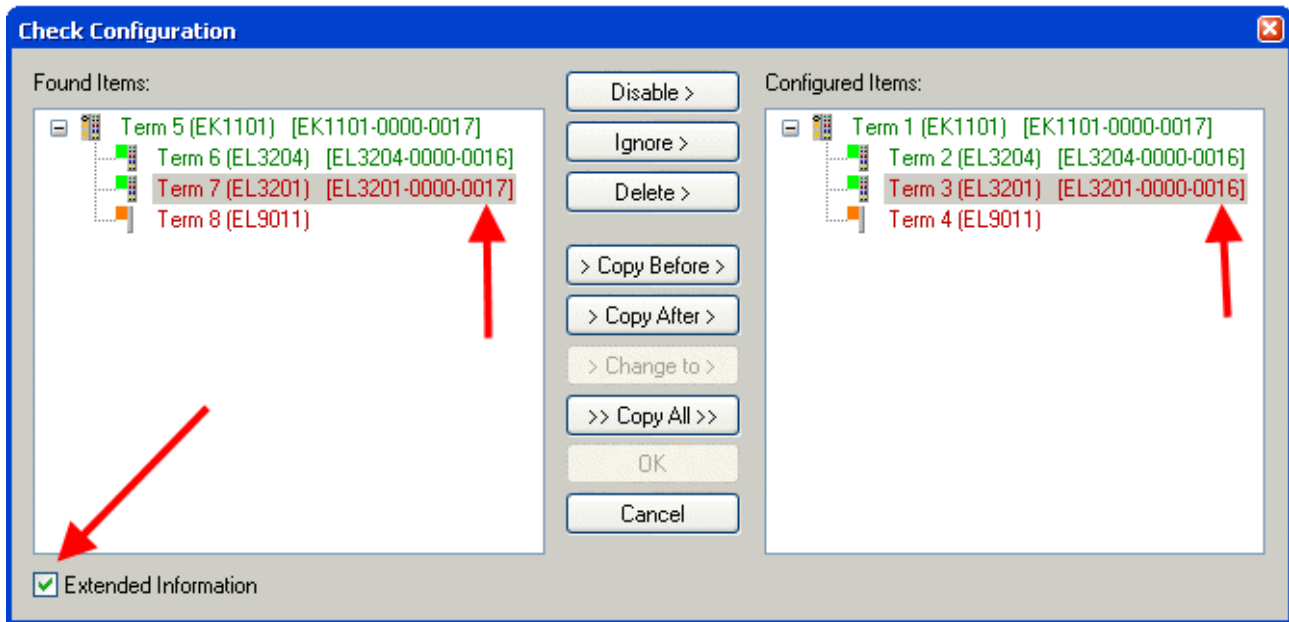

Fig. 172: Change dialog

In this example in Fig. *Change dialog*, an EL3201-0000-0017 was found, while an EL3201-0000-0016 was configured. In this case the configuration can be adapted with the *Copy Before* button. The *Extended Information* checkbox must be set in order to display the revision.

Changing the ESI slave identifier

The ESI/EEPROM identifier can be updated as follows under TwinCAT:

- Trouble-free EtherCAT communication must be established with the slave.
- The state of the slave is irrelevant.
- Right-clicking on the slave in the online display opens the *EEPROM Update* dialog, Fig. *EEPROM Update*

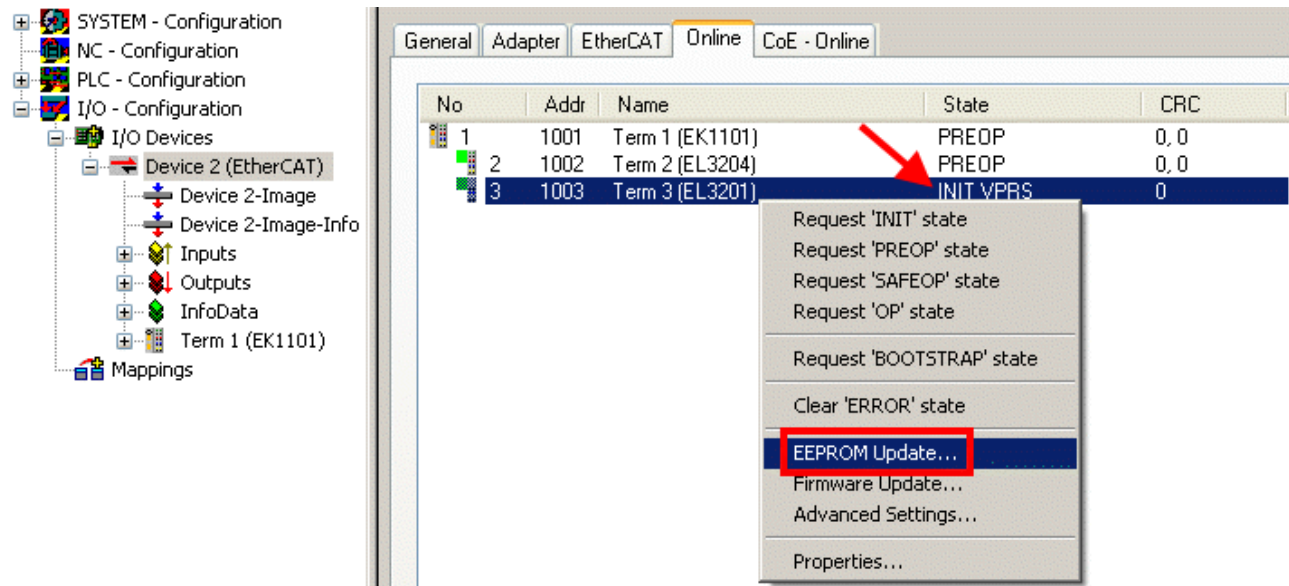

Fig. 173: EEPROM Update

The new ESI description is selected in the following dialog, see Fig. *Selecting the new ESI*. The checkbox *Show Hidden Devices* also displays older, normally hidden versions of a slave.

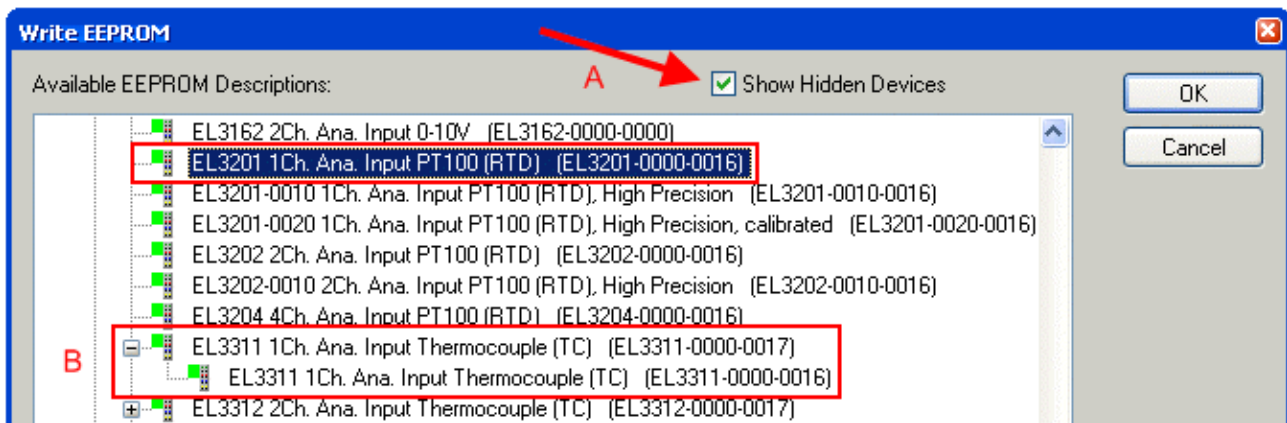

Fig. 174: Selecting the new ESI

A progress bar in the System Manager shows the progress. Data are first written, then verified.

i **The change only takes effect after a restart.**

Most EtherCAT devices read a modified ESI description immediately or after startup from the INIT. Some communication settings such as distributed clocks are only read during power-on. The EtherCAT slave therefore has to be switched off briefly in order for the change to take effect.

8.3.2 Firmware explanation

Determining the firmware version

Determining the version via the System Manager

The TwinCAT System Manager shows the version of the controller firmware if the master can access the slave online. Click on the E-Bus Terminal whose controller firmware you want to check (in the example terminal 2 (EL3204)) and select the tab *CoE Online* (CAN over EtherCAT).

i **CoE Online and Offline CoE**

Two CoE directories are available:

- **online:** This is offered in the EtherCAT slave by the controller, if the EtherCAT slave supports this. This CoE directory can only be displayed if a slave is connected and operational.
- **offline:** The EtherCAT Slave Information ESI/XML may contain the default content of the CoE. This CoE directory can only be displayed if it is included in the ESI (e.g. "Beckhoff EL5xxx.xml").

The Advanced button must be used for switching between the two views.

In Fig. *Display of EL3204 firmware version* the firmware version of the selected EL3204 is shown as 03 in CoE entry 0x100A.

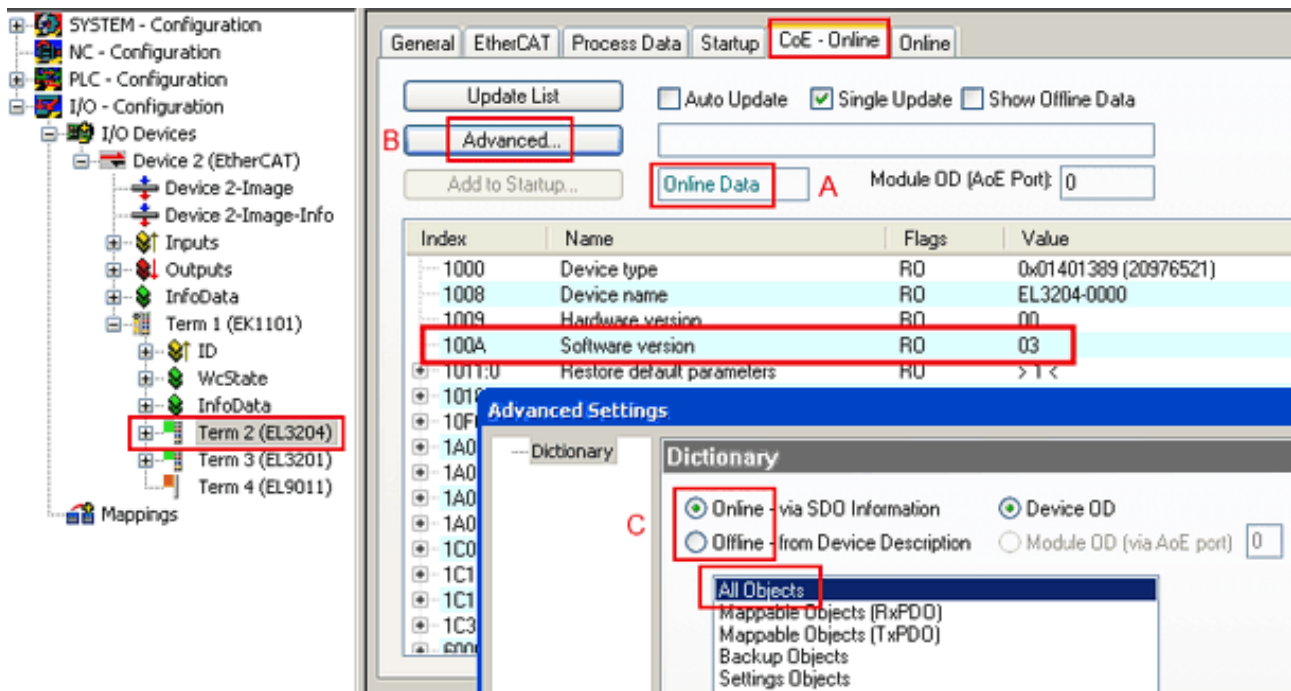

Fig. 175: Display of EL3204 firmware version

In (A) TwinCAT 2.11 shows that the Online CoE directory is currently displayed. If this is not the case, the Online directory can be loaded via the *Online* option in Advanced Settings (B) and double-clicking on *All Objects*.

8.3.3 Updating controller firmware *.efw

● CoE directory

i The Online CoE directory is managed by the controller and stored in a dedicated EEPROM, which is generally not changed during a firmware update.

Switch to the *Online* tab to update the controller firmware of a slave, see Fig. *Firmware Update*.

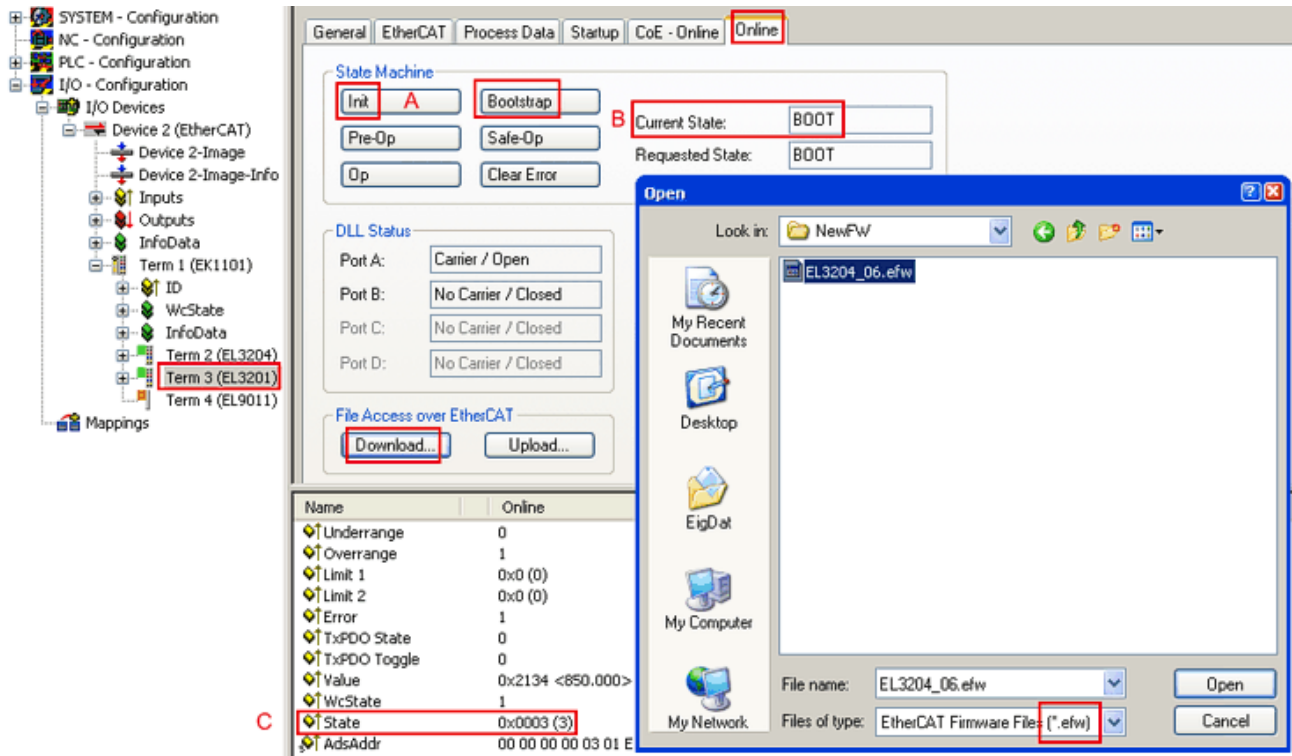
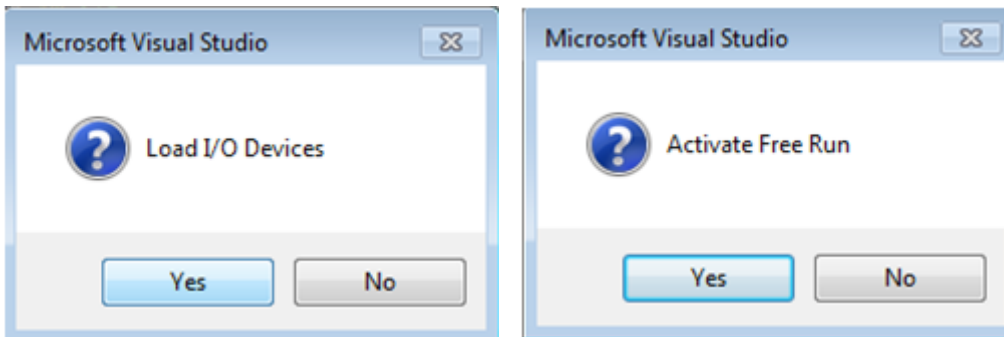

Fig. 176: Firmware Update

Proceed as follows, unless instructed otherwise by Beckhoff support. Valid for TwinCAT 2 and 3 as EtherCAT master.

- Switch TwinCAT system to ConfigMode/FreeRun with cycle time ≥ 1 ms (default in ConfigMode is 4 ms). A FW-Update during real time operation is not recommended.



- Switch EtherCAT Master to PreOP

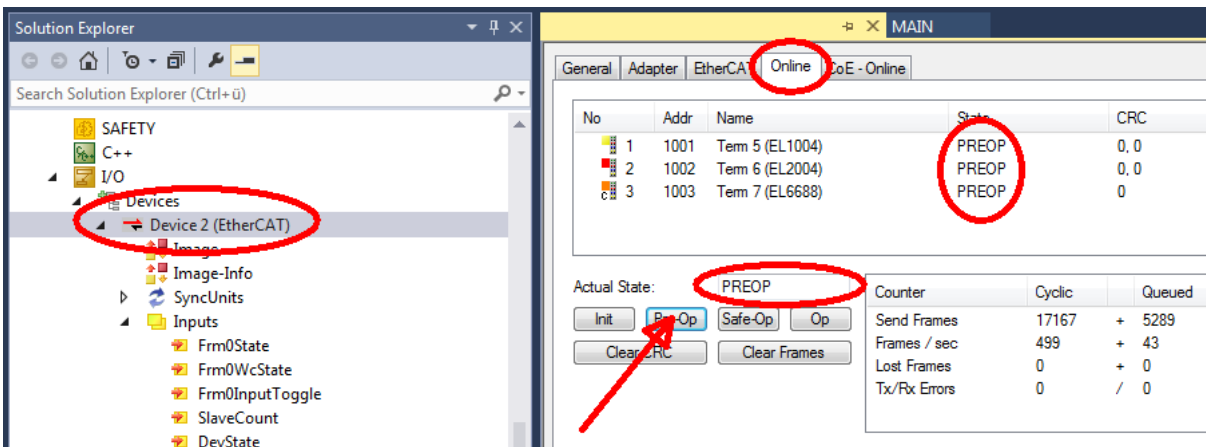

- Switch slave to INIT (A)
- Switch slave to BOOTSTRAP

- Check the current status (B, C)
- Download the new *efw file (wait until it ends). A password will not be necessary usually.

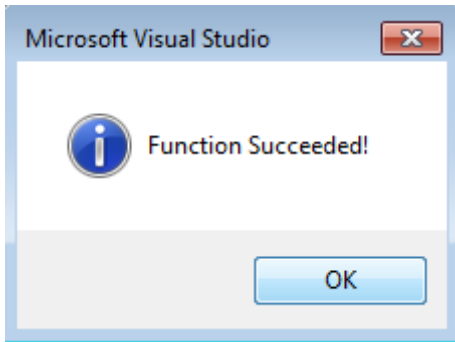

- After the download switch to INIT, then PreOP
- Switch off the slave briefly (don't pull under voltage!)
- Check within CoE 0x100A, if the FW status was correctly overtaken.

8.3.4 FPGA firmware *.rbf

If an FPGA chip deals with the EtherCAT communication an update may be accomplished via an *.rbf file.

- Controller firmware for processing I/O signals
- FPGA firmware for EtherCAT communication (only for terminals with FPGA)

The firmware version number included in the terminal serial number contains both firmware components. If one of these firmware components is modified this version number is updated.

Determining the version via the System Manager

The TwinCAT System Manager indicates the FPGA firmware version. Click on the Ethernet card of your EtherCAT strand (Device 2 in the example) and select the *Online* tab.

The *Reg:0002* column indicates the firmware version of the individual EtherCAT devices in hexadecimal and decimal representation.

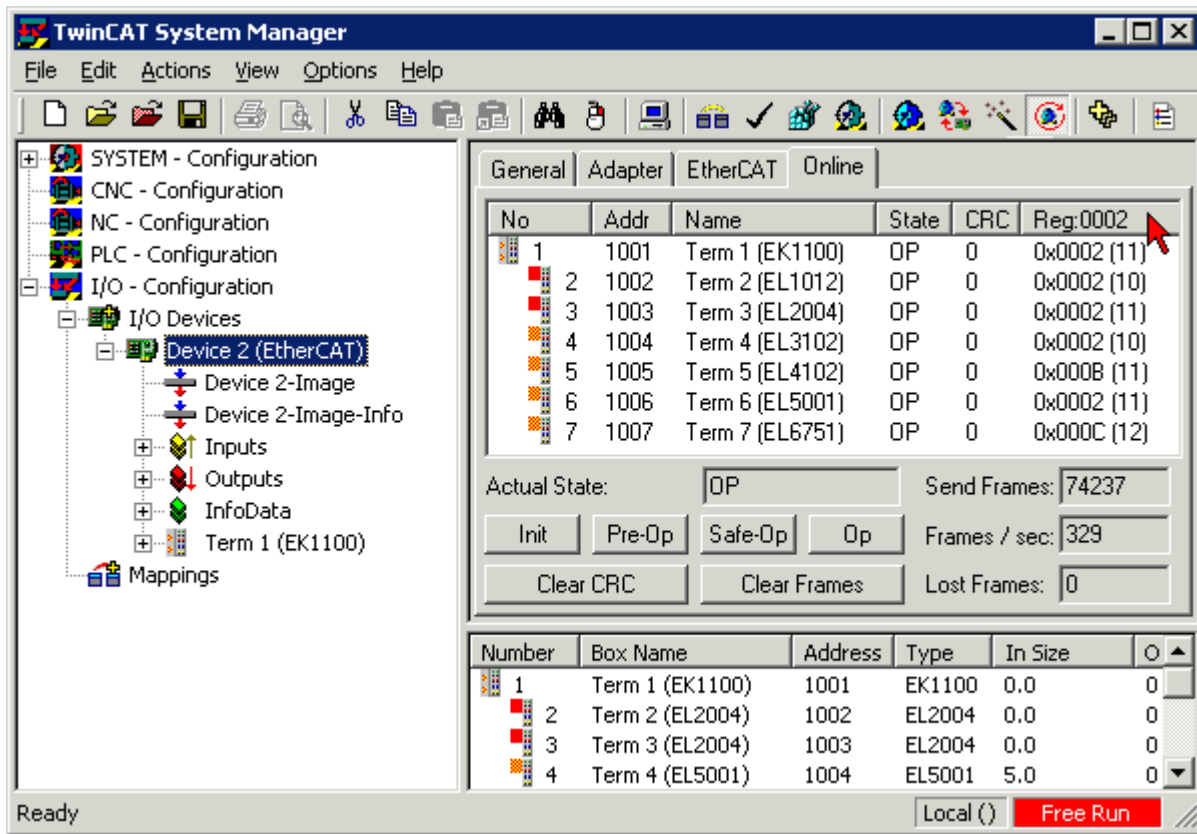

Fig. 177: FPGA firmware version definition

If the column *Reg:0002* is not displayed, right-click the table header and select *Properties* in the context menu.

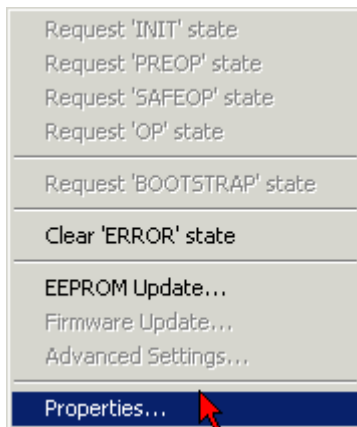

Fig. 178: Context menu *Properties*

The *Advanced Settings* dialog appears where the columns to be displayed can be selected. Under *Diagnosis/Online View* select the *'0002 ETxxxx Build'* check box in order to activate the FPGA firmware version display.

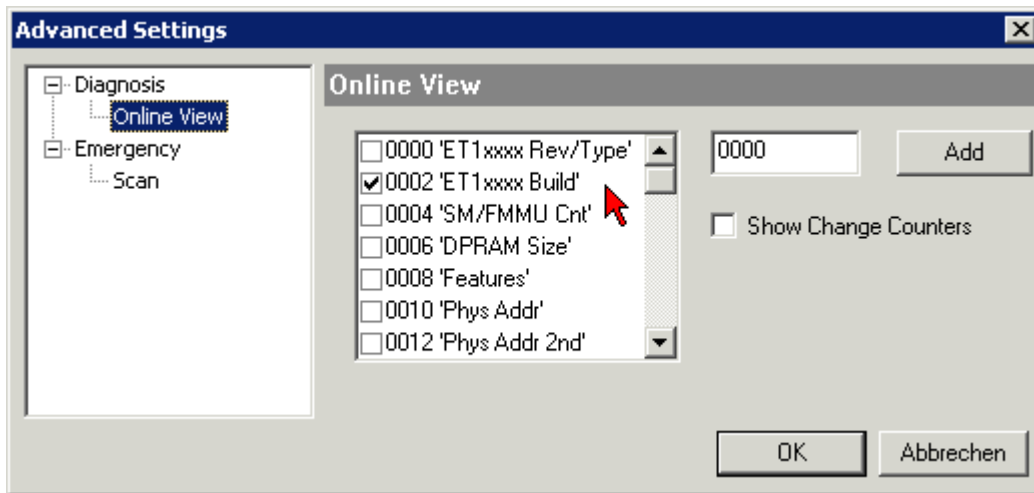

Fig. 179: Dialog *Advanced Settings*

Update

For updating the FPGA firmware

- of an EtherCAT coupler the coupler must have FPGA firmware version 11 or higher;
- of an E-Bus Terminal the terminal must have FPGA firmware version 10 or higher.

Older firmware versions can only be updated by the manufacturer!

Updating an EtherCAT device

The following sequence order have to be met if no other specifications are given (e.g. by the Beckhoff support):

- Switch TwinCAT system to ConfigMode/FreeRun with cycle time ≥ 1 ms (default in ConfigMode is 4 ms). A FW-Update during real time operation is not recommended.

- In the TwinCAT System Manager select the terminal for which the FPGA firmware is to be updated (in the example: Terminal 5: EL5001) and click the *Advanced Settings* button in the *EtherCAT* tab:

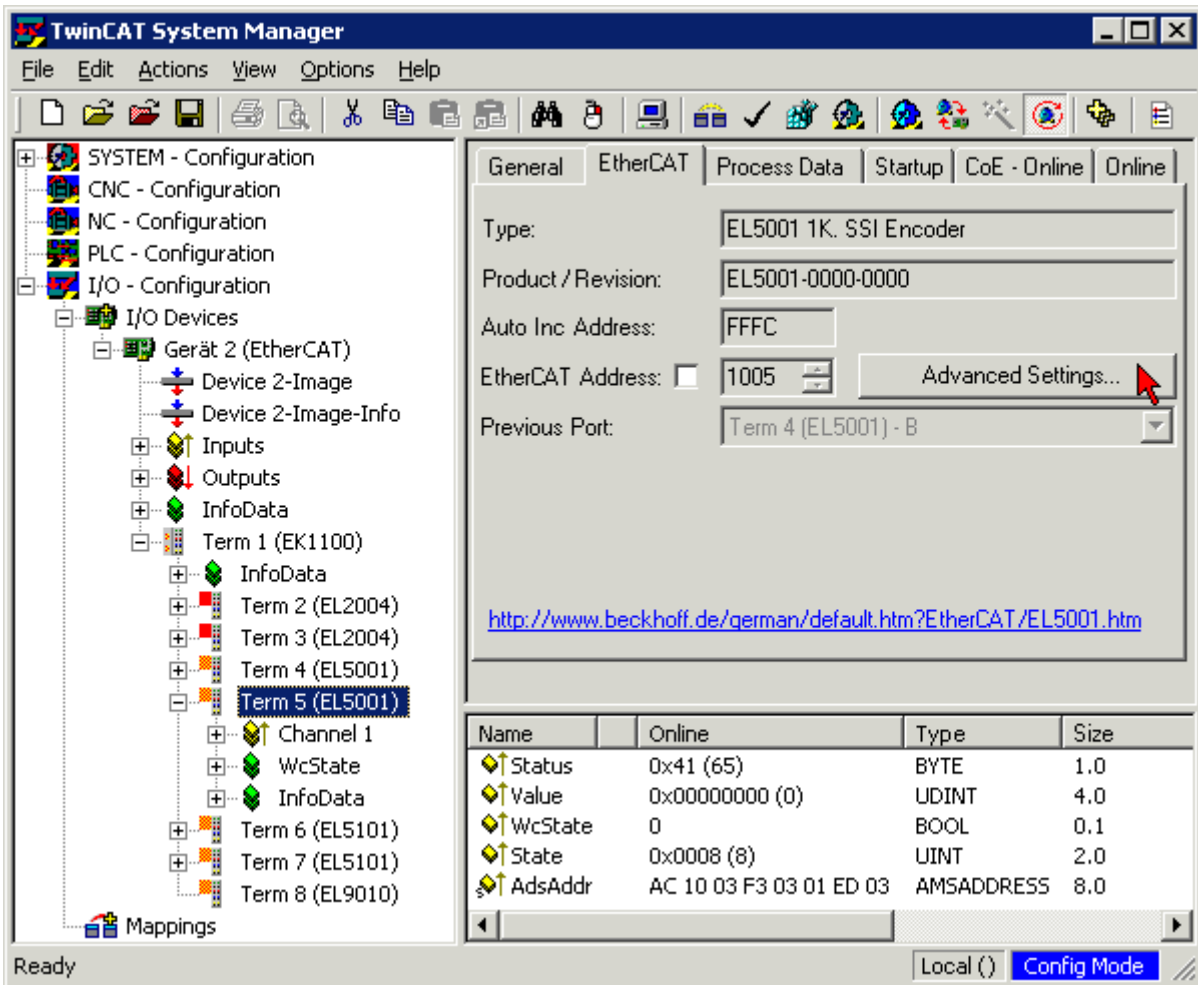

- The *Advanced Settings* dialog appears. Under *ESC Access/E²PROM/FPGA* click on *Write FPGA* button:

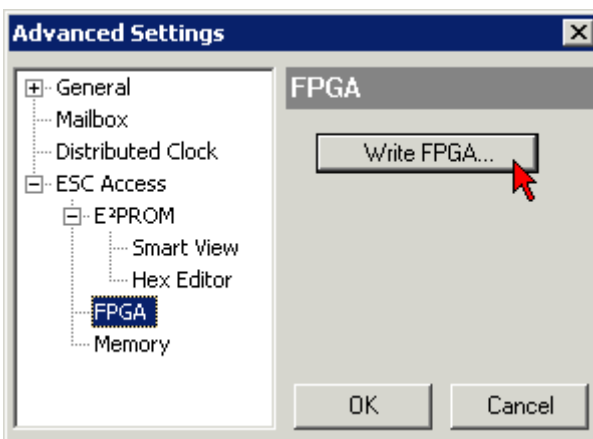

- Select the file (*.rbf) with the new FPGA firmware, and transfer it to the EtherCAT device:

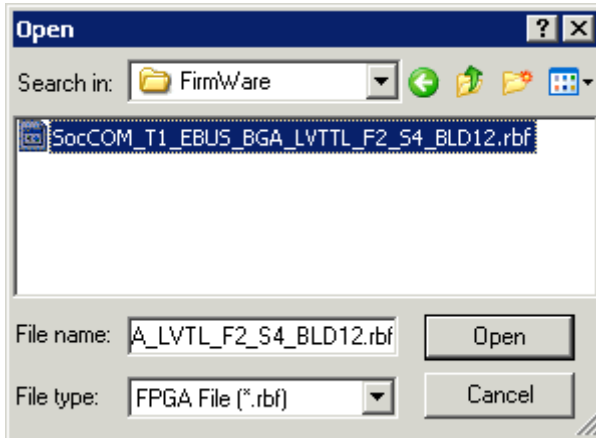

- Wait until download ends
- Switch slave current less for a short time (don't pull under voltage!). In order to activate the new FPGA firmware a restart (switching the power supply off and on again) of the EtherCAT device is required.
- Check the new FPGA status

NOTICE

Risk of damage to the device!

A download of firmware to an EtherCAT device must not be interrupted in any case! If you interrupt this process by switching off power supply or disconnecting the Ethernet link, the EtherCAT device can only be recommissioned by the manufacturer!

8.3.5 Simultaneous updating of several EtherCAT devices

The firmware and ESI descriptions of several devices can be updated simultaneously, provided the devices have the same firmware file/ESI.

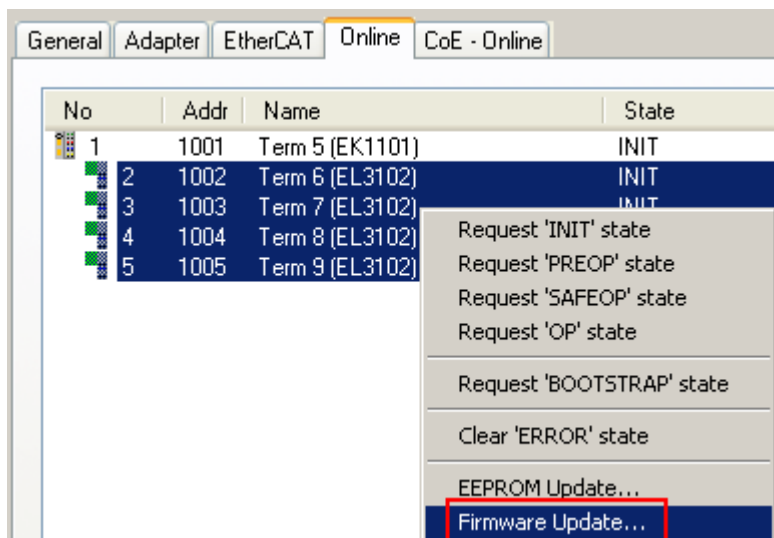

Fig. 180: Multiple selection and firmware update

Select the required slaves and carry out the firmware update in BOOTSTRAP mode as described above.

8.4 Restoring the delivery state

To restore the delivery state (factory settings) of CoE objects for EtherCAT devices (“slaves”), the CoE object *Restore default parameters*, SubIndex 001 can be used via EtherCAT master (e.g. TwinCAT) (see Fig. *Selecting the Restore default parameters PDO*).

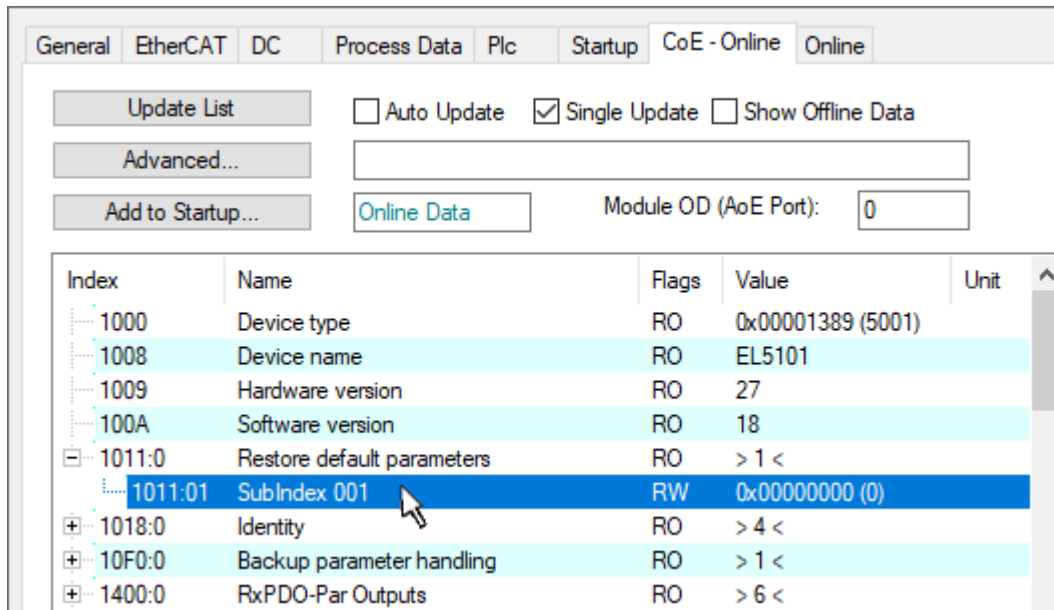

Fig. 181: Selecting the *Restore default parameters* PDO

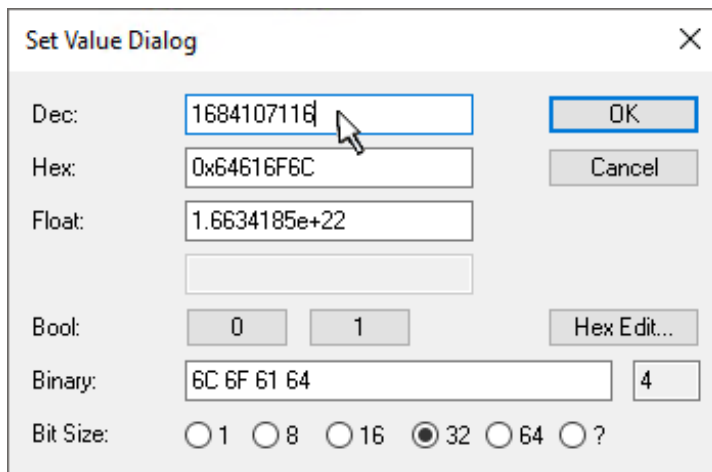

Fig. 182: Entering a restore value in the Set Value dialog

Double-click on *SubIndex 001* to enter the Set Value dialog. Enter the reset value **1684107116** in field *Dec* or the value **0x64616F6C** in field *Hex* (ASCII: “load”) and confirm with *OK* (Fig. *Entering a restore value in the Set Value dialog*).

- All changeable entries in the slave are reset to the default values.
- The values can only be successfully restored if the reset is directly applied to the online CoE, i.e. to the slave. No values can be changed in the offline CoE.
- TwinCAT must be in the RUN or CONFIG/Freerun state for this; that means EtherCAT data exchange takes place. Ensure error-free EtherCAT transmission.
- No separate confirmation takes place due to the reset. A changeable object can be manipulated beforehand for the purposes of checking.
- This reset procedure can also be adopted as the first entry in the startup list of the slave, e.g. in the state transition PREOP->SAFEOP or, as in Fig. *CoE reset as a startup entry*, in SAFEOP->OP.

All backup objects are reset to the delivery state.

i **Alternative restore value**

In some older terminals (FW creation approx. before 2007) the backup objects can be switched with an alternative restore value: Decimal value: 1819238756, Hexadecimal value: 0x6C6F6164.

An incorrect entry for the restore value has no effect.

8.5 Support and Service

Beckhoff and their partners around the world offer comprehensive support and service, making available fast and competent assistance with all questions related to Beckhoff products and system solutions.

Beckhoff's branch offices and representatives

Please contact your Beckhoff branch office or representative for local support and service on Beckhoff products!

The addresses of Beckhoff's branch offices and representatives round the world can be found on her internet pages: www.beckhoff.com

You will also find further documentation for Beckhoff components there.

Support

The Beckhoff Support offers you comprehensive technical assistance, helping you not only with the application of individual Beckhoff products, but also with other, wide-ranging services:

- support
- design, programming and commissioning of complex automation systems
- and extensive training program for Beckhoff system components

Hotline: +49 5246 963 157
e-mail: support@beckhoff.com
web: www.beckhoff.com/support

Service

The Beckhoff Service Center supports you in all matters of after-sales service:

- on-site service
- repair service
- spare parts service
- hotline service

Hotline: +49 5246 963 460
e-mail: service@beckhoff.com
web: www.beckhoff.com/service

Headquarters Germany

Beckhoff Automation GmbH & Co. KG

Hülshorstweg 20
33415 Verl
Germany

Phone: +49 5246 963 0
e-mail: info@beckhoff.com
web: www.beckhoff.com

More Information:
www.beckhoff.com/EL5021/

Beckhoff Automation GmbH & Co. KG
Hülshorstweg 20
33415 Verl
Germany
Phone: +49 5246 9630
info@beckhoff.com
www.beckhoff.com

