

Documentation | EN

EL5101-00xx

Incremental Encoder Interface



Table of contents

1 Overview Incremental Encoder Interface	7
2 Foreword	8
2.1 Notes on the documentation	8
2.2 Guide through documentation	9
2.3 Safety instructions	10
2.4 Documentation issue status	11
2.5 Version identification of EtherCAT devices	12
2.5.1 General notes on marking.....	12
2.5.2 Version identification of EL terminals.....	13
2.5.3 Beckhoff Identification Code (BIC).....	14
2.5.4 Electronic access to the BIC (eBIC).....	16
3 EL5101 - Product description	18
3.1 Introduction	18
3.2 Technical data.....	20
4 EL5101-0010 - Product description	22
4.1 Introduction	22
4.2 Technical data.....	23
5 EL5101-0011 - Product description	25
5.1 Introduction	25
5.2 Technical data.....	26
6 EL5101-0090 - Product description	28
6.1 Introduction	28
6.2 Technical data.....	30
7 Overview EL5101-00xx series	32
8 Incremental encoder basics	33
9 Technical properties	34
9.1 EL5101 - Extended operating mode (from FW14/HW09)	35
9.2 Note on monitoring the process data	35
9.3 EtherCAT cycle time	35
9.4 Inputs	36
9.5 Signal types.....	38
10 Start	39
11 Basics communication	40
11.1 EtherCAT basics	40
11.2 EtherCAT cabling – wire-bound	40
11.3 General notes for setting the watchdog	42
11.4 EtherCAT State Machine	44
11.5 CoE Interface	45
11.6 DC settings.....	49
12 Mounting and wiring	54
12.1 Instructions for ESD protection	54

12.2	Installation on mounting rails.....	55
12.3	Usage in potentially explosive areas (ATEX).....	58
12.3.1	ATEX - Special conditions (extended temperature range).....	58
12.3.2	IECEX - Special conditions.....	59
12.3.3	Continuative documentation for ATEX and IECEX.....	60
12.4	UL notice.....	61
12.5	Installation instructions for enhanced mechanical load capacity.....	62
12.6	Connection.....	62
12.6.1	Connection system.....	62
12.6.2	Wiring.....	65
12.6.3	Shielding.....	66
12.7	Note - Power supply.....	66
12.8	Installation positions.....	67
12.9	Positioning of passive Terminals.....	69
12.10	EL5101-00x0 - LEDs and Connection.....	70
12.11	EL5101-0011 - LEDs and Connection.....	72
12.12	Disposal.....	73
13	Commissioning.....	74
13.1	TwinCAT Quick Start.....	74
13.1.1	TwinCAT 2.....	77
13.1.2	TwinCAT 3.....	87
13.2	TwinCAT Development Environment.....	100
13.2.1	Installation of the TwinCAT real-time driver.....	101
13.2.2	Notes regarding ESI device description.....	107
13.2.3	TwinCAT ESI Updater.....	111
13.2.4	Distinction between Online and Offline.....	111
13.2.5	OFFLINE configuration creation.....	112
13.2.6	ONLINE configuration creation.....	117
13.2.7	EtherCAT subscriber configuration.....	125
13.2.8	NC configuration.....	134
13.3	General Commissioning Instructions for an EtherCAT Slave.....	137
14	EL5101 - Commissioning.....	145
14.1	Normal operation mode.....	145
14.1.1	Operation modes.....	145
14.1.2	Process data.....	146
14.1.3	Features CoE.....	152
14.1.4	Object description and parameterization - normal operation mode.....	154
14.1.5	Control and status byte.....	160
14.1.6	Single-ended connection for TTL encoder.....	161
14.2	Enhanced operation mode.....	162
14.2.1	Operation modes.....	162
14.2.2	Process data.....	163
14.2.3	Features CoE.....	171
14.2.4	Object description and parameterization - enhanced operation mode.....	176
14.2.5	Single-ended connection for TTL encoder.....	190

15 EL5101-0010 - Commissioning	191
15.1 Enhanced operation mode	191
15.1.1 Operation modes.....	191
15.1.2 Process data	192
15.1.3 Features CoE	198
15.1.4 Object description and parameterization - enhanced operation mode.....	201
16 EL5101-0011 - Commissioning	213
16.1 Principles of the oversampling function.....	213
16.2 Process data and configuration.....	216
16.3 Object description and parameterization - enhanced operation mode.....	220
16.3.1 Restore object.....	220
16.3.2 Configuration data.....	220
16.3.3 Input data	221
16.3.4 Output data	221
16.3.5 Information / diagnostic data (channel specific).....	221
16.3.6 Standard objects	221
17 EL5101-0090 - Commissioning	233
17.1 TwinSAFE SC	233
17.1.1 TwinSAFE SC - operating principle.....	233
17.1.2 TwinSAFE SC - configuration	233
17.1.3 TwinSAFE SC process data EL5101-0090	237
17.2 Process data and operation modes	237
17.3 Object description and parameterization - normal operation mode	238
17.3.1 Restore object.....	238
17.3.2 Configuration data.....	239
17.3.3 Input data	239
17.3.4 Output data	240
17.3.5 Standard objects	240
17.4 Object description and parameterization - enhanced operation mode.....	243
17.4.1 Restore object.....	243
17.4.2 Configuration data.....	244
17.4.3 Input data	246
17.4.4 Output data	247
17.4.5 Information / diagnostic data (channel specific).....	247
17.4.6 Standard objects	247
17.5 Objects TwinSAFE Single Channel (EL5101-0090).....	257
18 Appendix.....	260
18.1 EtherCAT AL Status Codes	260
18.2 Firmware compatibility	260
18.3 Firmware Update EL/ES/EM/ELM/EP/EPP/ERPxxxx	261
18.3.1 Device description ESI file/XML.....	262
18.3.2 Firmware explanation.....	265
18.3.3 Updating controller firmware *.efw	266
18.3.4 FPGA firmware *.rbf.....	268
18.3.5 Simultaneous updating of several EtherCAT devices.....	272

18.4 Restoring the delivery state.....	273
18.5 Support and Service.....	275

1 Overview Incremental Encoder Interface

- [EL5101 \[▶ 18\]](#) Incremental Encoder Interface
- [EL5101-0010 \[▶ 22\]](#) Incremental Encoder Interface, 20 Mio. increments/s
- [EL5101-0011 \[▶ 25\]](#) Incremental Encoder Interface, with oversampling
- [EL5101-0090 \[▶ 28\]](#) Incremental Encoder Interface, TwinSAFE Single Channel

2 Foreword

2.1 Notes on the documentation

Intended audience

This description is only intended for the use of trained specialists in control and automation engineering who are familiar with the applicable national standards.

It is essential that the documentation and the following notes and explanations are followed when installing and commissioning these components.

The qualified personnel is obliged to always use the currently valid documentation.

The responsible staff must ensure that the application or use of the products described satisfy all the requirements for safety, including all the relevant laws, regulations, guidelines and standards.

Disclaimer

The documentation has been prepared with care. The products described are, however, constantly under development.

We reserve the right to revise and change the documentation at any time and without prior announcement.

No claims for the modification of products that have already been supplied may be made on the basis of the data, diagrams and descriptions in this documentation.

Trademarks

Beckhoff®, TwinCAT®, TwinCAT/BSD®, TC/BSD®, EtherCAT®, EtherCAT G®, EtherCAT G10®, EtherCAT P®, Safety over EtherCAT®, TwinSAFE®, XFC®, XTS® and XPlanar® are registered trademarks of and licensed by Beckhoff Automation GmbH. Other designations used in this publication may be trademarks whose use by third parties for their own purposes could violate the rights of the owners.

Patent Pending

The EtherCAT Technology is covered, including but not limited to the following patent applications and patents: EP1590927, EP1789857, EP1456722, EP2137893, DE102015105702 with corresponding applications or registrations in various other countries.



EtherCAT® is registered trademark and patented technology, licensed by Beckhoff Automation GmbH, Germany.

Copyright

© Beckhoff Automation GmbH & Co. KG, Germany.

The reproduction, distribution and utilization of this document as well as the communication of its contents to others without express authorization are prohibited.

Offenders will be held liable for the payment of damages. All rights reserved in the event of the grant of a patent, utility model or design.

2.2 Guide through documentation

NOTICE



Further components of documentation

This documentation describes device-specific content. It is part of the modular documentation concept for Beckhoff I/O components. For the use and safe operation of the device / devices described in this documentation, additional cross-product descriptions are required, which can be found in the following table.

Title	Description
EtherCAT System Documentation (PDF)	<ul style="list-style-type: none"> • System overview • EtherCAT basics • Cable redundancy • Hot Connect • EtherCAT devices configuration
Explosion Protection for Terminal Systems (PDF)	Notes on the use of the Beckhoff terminal systems in hazardous areas according to ATEX and IECEx
Infrastructure for EtherCAT/Ethernet (PDF)	Technical recommendations and notes for design, implementation and testing
Software Declarations I/O (PDF)	Open source software declarations for Beckhoff I/O components

The documentations can be viewed at and downloaded from the Beckhoff website (www.beckhoff.com) via:

- the “Documentation and Download” area of the respective product page,
- the [Download finder](#),
- the [Beckhoff Information System](#).

2.3 Safety instructions

Safety regulations

Please note the following safety instructions and explanations!
Product-specific safety instructions can be found on following pages or in the areas mounting, wiring, commissioning etc.

Exclusion of liability

All the components are supplied in particular hardware and software configurations appropriate for the application. Modifications to hardware or software configurations other than those described in the documentation are not permitted, and nullify the liability of Beckhoff Automation GmbH & Co. KG.

Personnel qualification

This description is only intended for trained specialists in control, automation and drive engineering who are familiar with the applicable national standards.

Signal words

The signal words used in the documentation are classified below. In order to prevent injury and damage to persons and property, read and follow the safety and warning notices.

Personal injury warnings

⚠ DANGER

Hazard with high risk of death or serious injury.

⚠ WARNING

Hazard with medium risk of death or serious injury.

⚠ CAUTION

There is a low-risk hazard that could result in medium or minor injury.

Warning of damage to property or environment

NOTICE

The environment, equipment, or data may be damaged.

Information on handling the product



This information includes, for example:
recommendations for action, assistance or further information on the product.

2.4 Documentation issue status

From version 4.0	Comment
5.0	<ul style="list-style-type: none"> • Update chapter "Technical data" • Update revision status • Update structure
4.9	<ul style="list-style-type: none"> • Correction in chapter "Signal types" • Update revision status
4.8	<ul style="list-style-type: none"> • New Front page • Update chapter "Product description" • Update chapter "Technical properties" • Update chapter "Mounting and wiring" • Update chapter "Object description and parameterization" • Update structure • Update revision status
4.7	<ul style="list-style-type: none"> • Update chapter "Commissioning" • Update chapter "LEDs and connection" • Update structure • Update revision status
4.6	<ul style="list-style-type: none"> • Update chapter "Technical data" • Update chapter "LEDs and connection" • Update structure • Update revision status
4.5	<ul style="list-style-type: none"> • Update chapter "TwinSAFE SC" • Update structure • Corrections • Update revision status
4.4	<ul style="list-style-type: none"> • Update chapter "Technical data" • Update structure • Update revision status
4.3	<ul style="list-style-type: none"> • Addenda EL5101-0090 • Update structure • Update revision status
4.2	<ul style="list-style-type: none"> • Update chapter "Technology" • Update structure • Update revision status
4.1	<ul style="list-style-type: none"> • Addenda EL5101-0011 • Update structure • Update revision status
4.0	<ul style="list-style-type: none"> • Migration in ST4 • Update structure • Update revision status
0.1 - 3.7	<ul style="list-style-type: none"> • Archived

2.5 Version identification of EtherCAT devices

2.5.1 General notes on marking

Designation

A Beckhoff EtherCAT device has a 14-digit designation, made up of

- family key
- type
- version
- revision

Example	Family	Type	Version	Revision
EL3314-0000-0016	EL terminal 12 mm, non-pluggable connection level	3314 4-channel thermocouple terminal	0000 basic type	0016
ES3602-0010-0017	ES terminal 12 mm, pluggable connection level	3602 2-channel voltage measurement	0010 high-precision version	0017
CU2008-0000-0000	CU device	2008 8-port fast ethernet switch	0000 basic type	0000

Notes

- The elements mentioned above result in the **technical designation**. EL3314-0000-0016 is used in the example below.
- EL3314-0000 is the order identifier, in the case of "-0000" usually abbreviated to EL3314. "-0016" is the EtherCAT revision.
- The **order identifier** is made up of
 - family key (EL, EP, CU, ES, KL, CX, etc.)
 - type (3314)
 - version (-0000)
- The **revision** -0016 shows the technical progress, such as the extension of features with regard to the EtherCAT communication, and is managed by Beckhoff.
In principle, a device with a higher revision can replace a device with a lower revision, unless specified otherwise, e.g. in the documentation.
Associated and synonymous with each revision there is usually a description (ESI, EtherCAT Slave Information) in the form of an XML file, which is available for download from the Beckhoff web site.
From 2014/01 the revision is shown on the outside of the IP20 terminals, see Fig. "EL5021 EL terminal, standard IP20 IO device with batch number and revision ID (since 2014/01)".
- The type, version and revision are read as decimal numbers, even if they are technically saved in hexadecimal.

2.5.2 Version identification of EL terminals

The serial number/ data code for Beckhoff IO devices is usually the 8-digit number printed on the device or on a sticker. The serial number indicates the configuration in delivery state and therefore refers to a whole production batch, without distinguishing the individual modules of a batch.

Structure of the serial number: **KK YY FF HH**

KK - week of production (CW, calendar week)

YY - year of production

FF - firmware version

HH - hardware version

Example with serial number 12 06 3A 02:

12 - production week 12

06 - production year 2006

3A - firmware version 3A

02 - hardware version 02



Fig. 1: EL2872 with revision 0022 and serial number 01200815

2.5.3 Beckhoff Identification Code (BIC)

The Beckhoff Identification Code (BIC) is increasingly being applied to Beckhoff products to uniquely identify the product. The BIC is represented as a Data Matrix Code (DMC, code scheme ECC200), the content is based on the ANSI standard MH10.8.2-2016.

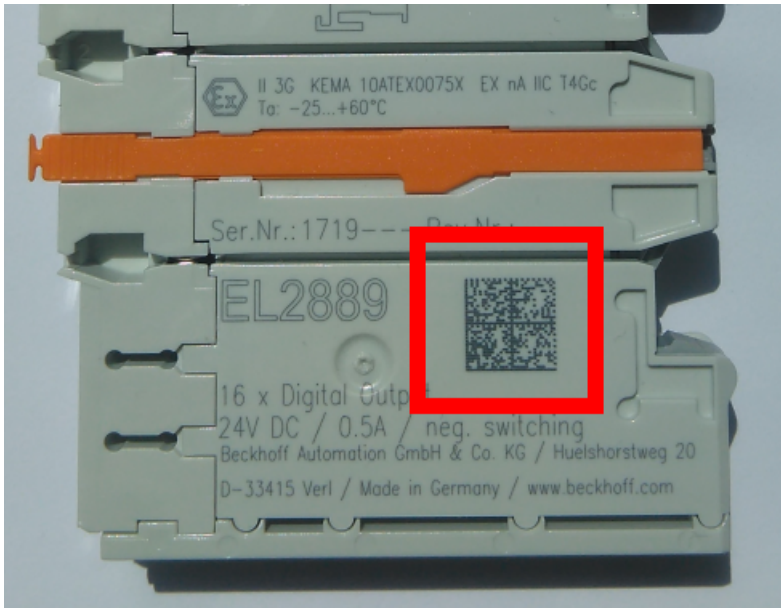

Fig. 2: BIC as data matrix code (DMC, code scheme ECC200)

The BIC will be introduced step by step across all product groups.

Depending on the product, it can be found in the following places:

- on the packaging unit
- directly on the product (if space suffices)
- on the packaging unit and the product

The BIC is machine-readable and contains information that can also be used by the customer for handling and product management.

Each piece of information can be uniquely identified using the so-called data identifier (ANSI MH10.8.2-2016). The data identifier is followed by a character string. Both together have a maximum length according to the table below. If the information is shorter, spaces are added to it.

Following information is possible, positions 1 to 4 are always present, the other according to need of production:

Position	Type of information	Explanation	Data identifier	Number of digits incl. data identifier	Example
1	Beckhoff order number	Beckhoff order number	1P	8	1P 072222
2	Beckhoff Traceability Number (BTN)	Unique serial number, see note below	SBTN	12	SBTN k4p562d7
3	Article description	Beckhoff article description, e.g. EL1008	1K	32	1K EL1809
4	Quantity	Quantity in packaging unit, e.g. 1, 10, etc.	Q	6	Q 1
5	Batch number	Optional: Year and week of production	2P	14	2P 401503180016
6	ID/serial number	Optional: Present-day serial number system, e.g. with safety products	51S	12	51S 678294
7	Variant number	Optional: Product variant number on the basis of standard products	30P	32	30P F971, 2*K183
...					

Further types of information and data identifiers are used by Beckhoff and serve internal processes.

Structure of the BIC

Example of composite information from positions 1 to 4 and with the above given example value on position 6. The data identifiers are highlighted in bold font:

1P072222**SBTN**k4p562d7**1K**EL1809 **Q**1 **51S**678294

Accordingly as DMC:



Fig. 3: Example DMC **1P**072222**SBTN**k4p562d7**1K**EL1809 **Q**1 **51S**678294

BTN

An important component of the BIC is the Beckhoff Traceability Number (BTN, position 2). The BTN is a unique serial number consisting of eight characters that will replace all other serial number systems at Beckhoff in the long term (e.g. batch designations on IO components, previous serial number range for safety products, etc.). The BTN will also be introduced step by step, so it may happen that the BTN is not yet coded in the BIC.

NOTICE

This information has been carefully prepared. However, the procedure described is constantly being further developed. We reserve the right to revise and change procedures and documentation at any time and without prior notice. No claims for changes can be made from the information, illustrations and descriptions in this information.

2.5.4 Electronic access to the BIC (eBIC)

Electronic BIC (eBIC)

The Beckhoff Identification Code (BIC) is applied to the outside of Beckhoff products in a visible place. If possible, it should also be electronically readable.

The interface that the product can be electronically addressed by is crucial for the electronic readout.

K-bus devices (IP20, IP67)

Currently, no electronic storage or readout is planned for these devices.

EtherCAT devices (IP20, IP67)

All Beckhoff EtherCAT devices have an ESI-EEPROM which contains the EtherCAT identity with the revision number. The EtherCAT slave information, also colloquially known as the ESI/XML configuration file for the EtherCAT master, is stored in it. See the corresponding chapter in the EtherCAT system manual ([Link](#)) for the relationships.

Beckhoff also stores the eBIC in the ESI-EEPROM. The eBIC was introduced into Beckhoff IO production (terminals, box modules) in 2020; as of 2023, implementation is largely complete.

The user can electronically access the eBIC (if present) as follows:

- With all EtherCAT devices, the EtherCAT master (TwinCAT) can read the eBIC from the ESI-EEPROM
 - From TwinCAT 3.1 build 4024.11, the eBIC can be displayed in the online view.
 - To do this, check the "Show Beckhoff Identification Code (BIC)" checkbox under EtherCAT → Advanced Settings → Diagnostics:

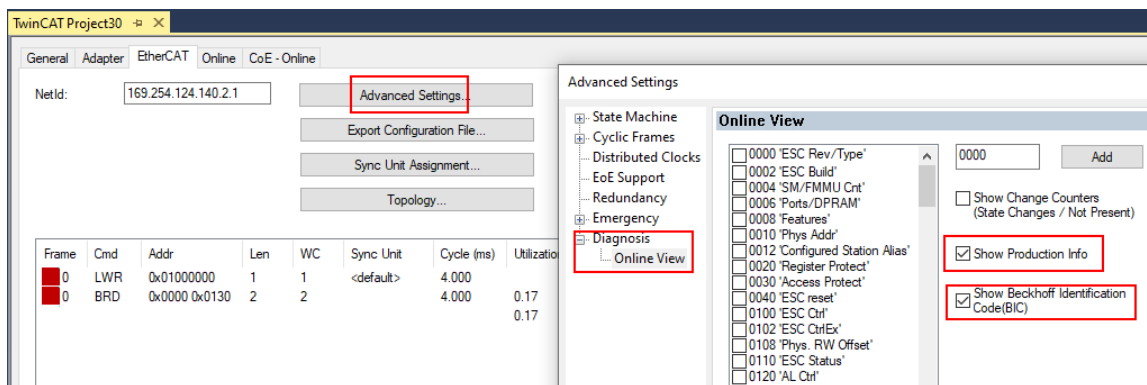

- The BTN and its contents are then displayed:

No	Addr	Name	State	CRC	Fw	Hw	Production Data	ItemNo	BTN	Description	Quantity	BatchNo	SerialNo
1	1001	Term 1 (EK1100)	OP	0.0	0	0	---						
2	1002	Term 2 (EL1018)	OP	0.0	0	0	2020 KW36 Fr	072222	k4p562d7	EL1809	1		678294
3	1003	Term 3 (EL3204)	OP	0.0	7	6	2012 KW24 Sa						
4	1004	Term 4 (EL2004)	OP	0.0	0	0	---	072223	k4p562d7	EL2004	1		678295
5	1005	Term 5 (EL1008)	OP	0.0	0	0	---						
6	1006	Term 6 (EL2008)	OP	0.0	0	12	2014 KW14 Mo						
7	1007	Term 7 (EK1110)	OP	0	1	8	2012 KW25 Mo						

- Note: As shown in the figure, the production data HW version, FW version, and production date, which have been programmed since 2012, can also be displayed with "Show production info".
- Access from the PLC: From TwinCAT 3.1. build 4024.24, the functions *FB_EcReadBIC* and *FB_EcReadBTN* for reading into the PLC are available in the *Tc2_EtherCAT* library from v3.3.19.0.
- EtherCAT devices with a CoE directory may also have the object 0x10E2:01 to display their own eBIC, which can also be easily accessed by the PLC:

- The device must be in PREOP/SAFEOP/OP for access:

Index	Name	Flags	Value
1000	Device type	RO	0x015E1389 (22942601)
1008	Device name	RO	ELM3704-0000
1009	Hardware version	RO	00
100A	Software version	RO	01
100B	Bootloader version	RO	J0.1.27.0
1011:0	Restore default parameters	RO	> 1 <
1018:0	Identity	RO	> 4 <
10E2:0	Manufacturer-specific Identification C...	RO	> 1 <
10E2:01	SubIndex 001	RO	1P158442SBTN0008jckp1KELM3704 Q1 2P482001000016
10F0:0	Backup parameter handling	RO	> 1 <
10F3:0	Diagnosis History	RO	> 21 <
10F8	Actual Time Stamp	RO	0x170bfb277e

- The object 0x10E2 will be preferentially introduced into stock products in the course of necessary firmware revision.
- From TwinCAT 3.1. build 4024.24, the functions *FB_EcCoEReadBIC* and *FB_EcCoEReadBTN* for reading into the PLC are available in the *Tc2_EtherCAT* library from v3.3.19.0
- The following auxiliary functions are available for processing the BIC/BTN data in the PLC in *Tc2_Uilities* as of TwinCAT 3.1 build 4024.24
 - *F_SplitBIC*: The function splits the Beckhoff Identification Code (BIC) *sBICValue* into its components using known identifiers and returns the recognized substrings in the *ST_SplittedBIC* structure as a return value
 - *BIC_TO_BTN*: The function extracts the BTN from the BIC and returns it as a return value
- Note: If there is further electronic processing, the BTN is to be handled as a string(8); the identifier "SBTN" is not part of the BTN.
- Technical background
 The new BIC information is written as an additional category in the ESI-EEPROM during device production. The structure of the ESI content is largely dictated by the ETG specifications, therefore the additional vendor-specific content is stored using a category in accordance with the ETG.2010. ID 03 tells all EtherCAT masters that they may not overwrite these data in the event of an update or restore the data after an ESI update.
 The structure follows the content of the BIC, see here. The EEPROM therefore requires approx. 50..200 bytes of memory.
- Special cases
 - If multiple hierarchically arranged ESCs are installed in a device, only the top-level ESC carries the eBIC information.
 - If multiple non-hierarchically arranged ESCs are installed in a device, all ESCs carry the eBIC information.
 - If the device consists of several sub-devices which each have their own identity, but only the top-level device is accessible via EtherCAT, the eBIC of the top-level device is located in the CoE object directory 0x10E2:01 and the eBICs of the sub-devices follow in 0x10E2:nn.

PROFIBUS; PROFINET, and DeviceNet devices

Currently, no electronic storage or readout is planned for these devices.

3 EL5101 - Product description

3.1 Introduction

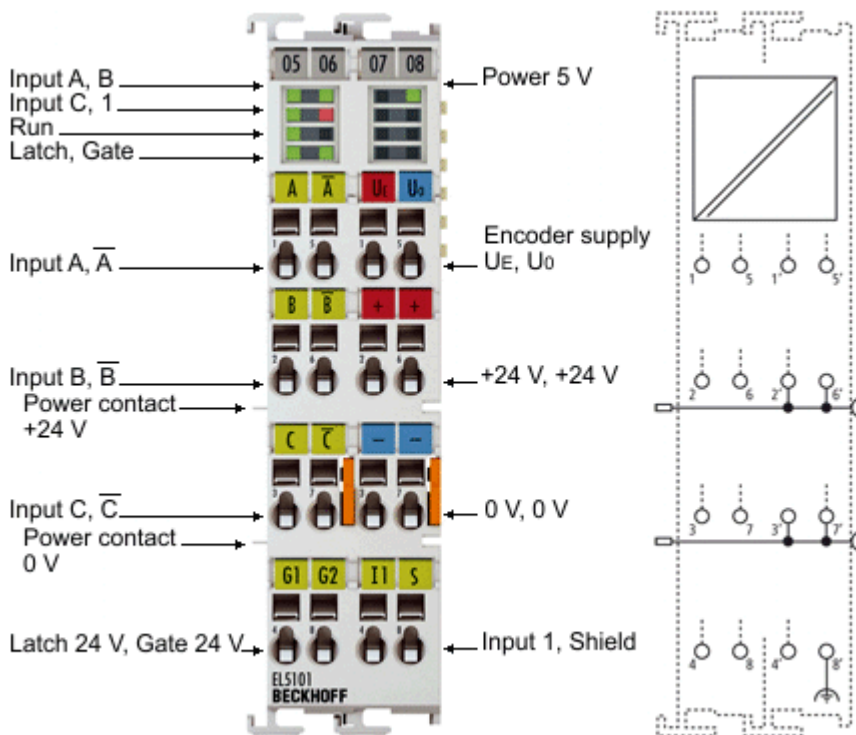

Fig. 4: EL5101

Incremental encoder interface, RS422, TTL, 1 MHz

The EL5101 EtherCAT Terminal is an interface for direct connection of incremental encoders with differential inputs (RS422) or TTL single ended signals. Input frequencies up to 1 MHz can be evaluated. The measurement of period and frequency with a resolution of 100 ns is possible. The EL5101 can also be used as bidirectional counter on channel A; channel B specifies the count direction.

Two additional 24 V digital inputs are available for storing, blocking and setting the counter status. The gate input allows the locking of the counter, alternatively with a high or low level. The latch input is similarly configurable and evaluates high or low levels.

Incremental encoders with alarm output can be connected at the negative switching status input of the interface. The 5 V and 24 V supply of the encoder can be provided directly via the terminal connection points.

In normal operating mode a 16-bit counter and a 16-bit latch for the zero pulse can be read, set or enabled.

The enhanced operating mode is available through the further development of the EL5101 (from [firmware 14 / hardware 09](#) [▶ 260]). It can be parameterized in the TwinCAT System Manager, depending on the hardware used. Older EL5101 devices do not support this enhanced operating mode (see Table below)!

Operating modes EL5101	from FW/HW	ESI	Functional description
normal operating mode	03/05	from EL5101-0000-0000	All basic functions as described above
enhanced operating mode	14/09	from EL5101-0000-1018	Changes to the normal operating mode <ul style="list-style-type: none"> • Distributed clock support • Micro-increments • Open circuit detection • Connection of Single-Ended signals possible

In enhanced operating mode a switchable 16/32-bit counter and a 32-bit latch for the zero pulse can be read, set or enabled.

The EL5101 supports distributed clocks in the enhanced operating mode, i.e. the input data can be recorded synchronously with other data that are also linked to Distributed Clock slaves. The accuracy across the system is < 100 ns.

The documentation is divided in the chapter "[EL5101 - Commissioning \[▶ 145\]](#)" into the handling of the two operating modes. During commissioning it must be decided which operating mode is to be used.

Quick links

- [Basics communication \[▶ 40\]](#)
- [Creation of the TwinCAT configuration \[▶ 117\]](#)
- [EL5101 – process data, modes, object description \[▶ 145\]](#)
- [LEDs and connection \[▶ 70\]](#)

3.2 Technical data

Encoder	EL5101
Technology	Incremental encoder interface, differential (RS422), single-ended (TTL), counter, pulse generator
Additional inputs	Gate, latch (24 V _{DC} , both max. 1 MHz permitted), Signal voltage: "0": -3 V ... +5 V (EN 61131-2, type 3) "1": 11 V ... 30 V (EN 61131-2, type 3) Status input (max. 5 V _{DC} , potential-free, switching to negative potential)
Encoder connection	A, -A, B, -B, C, -C (RS422 differential inputs) also single-ended connection (5 V ±20%) possible from (hardware 09 > 260)
Encoder operating voltage	5 V _{DC} (-5% to +10%) (generated from the 24 V _{DC} power contacts)
Sensor output current	0.5 A
Counter	16 bit, 16/32 bit switchable (from firmware 14 / hardware 09 > 260)
Zero pulse latch	16 bit, 16/32 bit switchable (from firmware 14 / hardware 09 > 260)
Limit frequency	1 MHz (equals 4 million increments with 4-fold evaluation)
Quadrature decoder	4-fold evaluation

Function and communication	EL5101
Distributed Clocks	in enhanced operating mode (from firmware 14 / hardware 09 > 260)
Cycle time	min. 100 µs
Broken wire detection to sensor	in enhanced operating mode (from firmware 14 / hardware 09 > 260)
Bit width in process image	up to 6 bytes outputs, 22 bytes inputs, depends on parameterization
Configuration	via TwinCAT System Manager > 125
Special features	<ul style="list-style-type: none"> • Wire breakage detection, • latch and gate function, • period duration and frequency measurement, • microincrements, • timestamping of edges, • filters

Supply and potentials	EL5101
Current consumption from the E-bus	typ. 130 mA
Current consumption from the power contacts	0.1 A (excluding sensor load current)
Electrical isolation	500 V (E-bus/field voltage)

Environmental conditions	EL5101
Permissible ambient temperature range during operation	-25°C ... +60°C (extended temperature range)
Permissible ambient temperature range during storage	-40°C ... +85°C
Permissible relative humidity	95%, no condensation

General data	EL5101
Weight	approx. 100 g
Dimensions (W x H x D)	approx. 27 mm x 100 mm x 70 mm (width aligned: 24 mm)
Mounting [▶ 55]	on 35 mm mounting rail conforms to EN 60715
Installation position	variable

Standards and approvals	EL5101
Enhanced mechanical load capacity	yes, see also Installation instructions [▶ 62] for terminals with increased mechanical load capacity
Vibration/shock resistance	according to EN 60068-2-6/EN 60068-2-27
EMC immunity/emission	conforms to EN 61000-6-2 / EN 61000-6-4
Protection class	IP20
Approvals/markings	CE, EAC, UKCA, cULus [▶ 61] ATEX [▶ 58] , IECEX [▶ 59]

*) Real applicable approvals/markings see type plate on the side (product marking).

Ex markings

Standard	Marking
ATEX	II 3 G Ex nA IIC T4 Gc
IECEX	Ex nA IIC T4 Gc

4 EL5101-0010 - Product description

4.1 Introduction

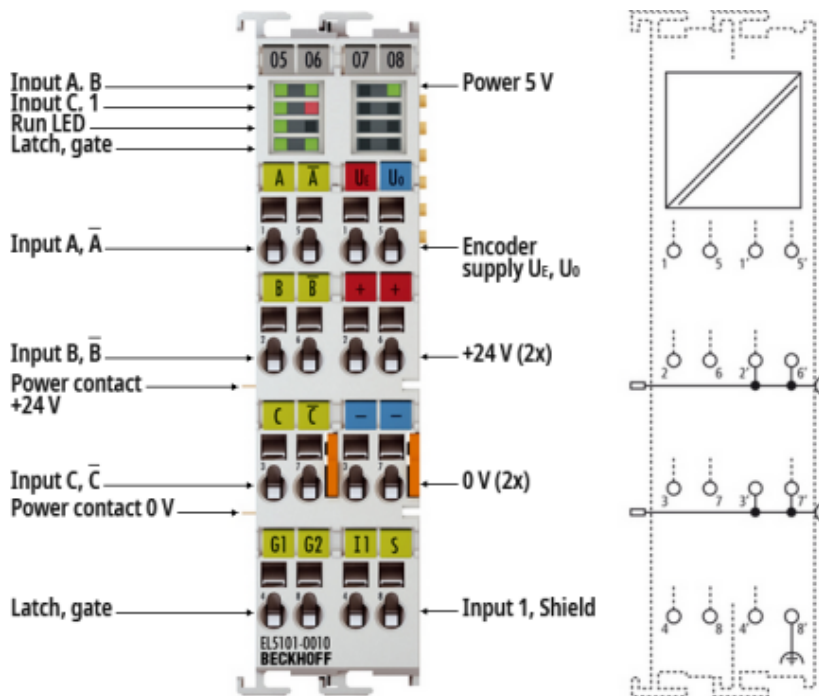

Fig. 5: EL5101-0010

Incremental encoder interface, RS422, 5 MHz

The EL5101-0010 EtherCAT Terminal is an interface for direct connection of incremental encoders with differential inputs (RS422). With a maximum input frequency of up to 5 MHz it is particularly suitable for dynamic applications.

The EL5101-0010 with a resolution of 20 mio. increments/s at 5 MHz and 4-fold evaluation is only applicable for the enhanced operating mode. The microincrement mode is not available for the EL5101-0010.

A switchable 16/32-bit counter with a quadrature decoder and a 32-bit latch for the zero pulse can be read, set or enabled. The measurement of period and frequency with a resolution of 100 ns is possible.

Two additional 24 V digital inputs are available for storing, blocking and setting the counter status. The gate input allows the locking of the counter, alternatively with a high or low level. The latch input is similarly configurable and evaluates high or low levels.

Incremental encoders with alarm output can be connected at the negative switching status input of the interface. The 5 V and 24 V supply of the encoder can be provided directly via the terminal connection points.

The EL5101-0010 supports distributed clocks in the enhanced operating mode, i.e. the input data can be recorded synchronously with other data that are also linked to Distributed Clock slaves. The accuracy across the system is < 100 ns.

A timestamp for the last-registered incremental edge is also available. The use of encoder profiles enables simple and fast linking of the process data for Motion Control applications.

Quick links

- [Basics communication \[► 40\]](#)
- [EL5101-0010 - process data, modes, object description \[► 191\]](#)
- [Creation of the TwinCAT configuration \[► 117\]](#)
- [LEDs and connection \[► 70\]](#)

4.2 Technical data

Encoder	EL5101-0010
Technology	Incremental encoder interface, differential (RS422)
Additional inputs	gate, latch (24 V _{DC} , both max. 1 MHz permitted), Signal voltage: "0": -3 V ... +5 V (EN 61131-2, type 3) "1": 11 V ... 30 V (EN 61131-2, type 3) status input (max. 5 V _{DC} , potential-free, switching to negative potential)
Encoder connection	A, -A, B, -B, C, -C (RS422 differential inputs)
Encoder operating voltage	5 V _{DC} (-5% to +10%) (generated from the 24 V _{DC} power contacts)
Sensor output current	0.5 A
Counter	16 bit, 16/32 bit switchable
Zero pulse latch	16 bit, 16/32 bit switchable
Limit frequency	5 MHz (equals 20 million increments with 4-fold evaluation)
Quadrature decoder	4-fold evaluation

Function and communication	EL5101-0010
Distributed Clocks	yes
Cycle time	min. 100 µs
Broken wire detection to sensor	yes
Bit width in process image	up to 6 bytes outputs, 22 bytes inputs, depends on parameterization
Configuration	via TwinCAT System Manager [▶ 125]
Special features	<ul style="list-style-type: none"> • wire breakage detection, • latch and gate function, • period duration and frequency measurement, • timestamping of edges, • filters, • no single-ended operation

Supply and potentials	EL5101-0010
Current consumption from the E-bus	typ. 130 mA
Current consumption from the power contacts	0.1 A (excluding sensor load current)
Electrical isolation	500 V (E-bus/field voltage)

Environmental conditions	EL5101-0010
Permissible ambient temperature range during operation	-25°C ... +60°C (extended temperature range)
Permissible ambient temperature range during storage	-40°C ... +85°C
Permissible relative humidity	95%, no condensation

General data	EL5101-0010
Weight	approx. 100 g
Dimensions (W x H x D)	approx. 27 mm x 100 mm x 70 mm (width aligned: 24 mm)
Mounting [▶ 55]	on 35 mm mounting rail conforms to EN 60715
Installation position	variable

Standards and approvals	EL5101-0010
Enhanced mechanical load capacity	yes, see also Installation instructions [▶ 62] for terminals with increased mechanical load capacity
Vibration/shock resistance	according to EN 60068-2-6/EN 60068-2-27
EMC immunity/emission	conforms to EN 61000-6-2 / EN 61000-6-4
Protection class	IP20
Approvals/markings*	CE, EAC, UKCA, cULus [▶ 61] ATEX [▶ 58], IECEx [▶ 59]

*) Real applicable approvals/markings see type plate on the side (product marking).

Ex markings

Standard	Marking
ATEX	II 3 G Ex nA IIC T4 Gc
IECEx	Ex nA IIC T4 Gc

5 EL5101-0011 - Product description

5.1 Introduction

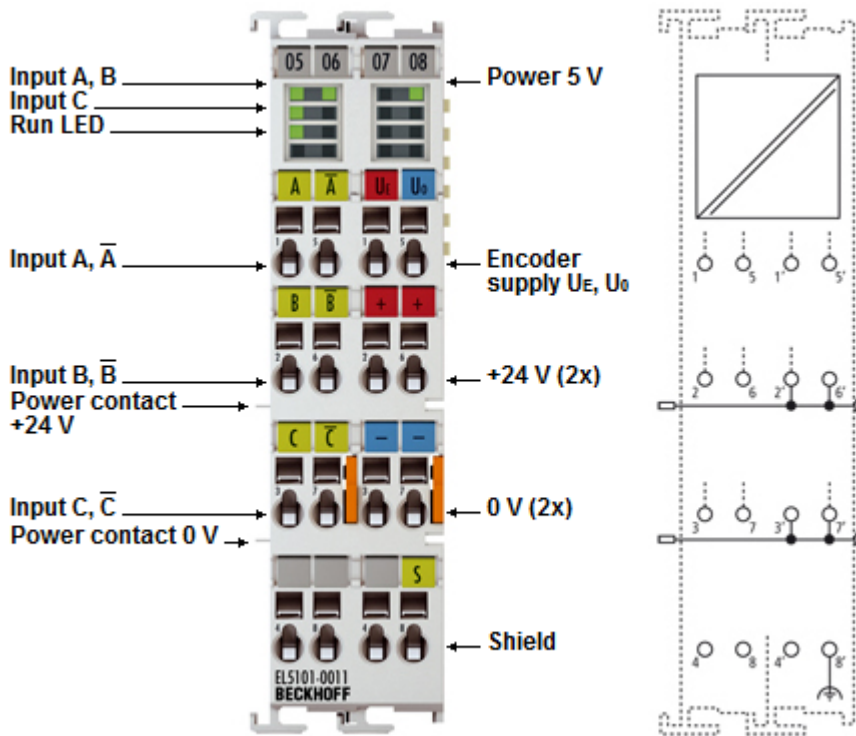

Fig. 6: EL5101-0011

Incremental encoder interface, RS422, 5 MHz, Oversampling

The EL5101-0011 EtherCAT Terminal is an interface for the direct connection of incremental encoders with differential inputs (RS422). A 32-bit counter with quadrature decoder can be read and set.

The EL5101-0011 supports the oversampling principle. Using this method the resolution of the position value can be increased to n times the bus cycle time. The current counter value is thereby read at several configurable and equidistant times between two fieldbus communication cycles with an adjustable whole number multiple (oversampling factor: n) of the bus cycle time. The transfer of a packet of n position values of 32 bits each to the higher-level controller takes place in the next fieldbus communication cycle. The minimum sampling time here is $10 \mu\text{s}$ (maximum sampling frequency 100 kSps). Areas of application of the EL5101-0011 lie in particular in the area of high-resolution position detection.

The EL5101-0011 supports distributed clocks, i.e. the input data can be synchronously acquired with other data that, similarly distributed, are connected to distributed slave clocks. The system accuracy is around $< 100 \text{ ns}$.

Quick links

- [Basics communication \[► 40\]](#)
- [Creation of the TwinCAT configuration \[► 117\]](#)
- [EL5101-0011 - process data, modes, object description \[► 213\]](#)
- [LEDs and connection \[► 72\]](#)

5.2 Technical data

Encoder	EL5101-0011
Technology	Incremental encoder interface, differential (RS422)
Additional inputs	-
Encoder connection	A, \neg A, B, \neg B, C, \neg C (RS422 differential inputs)
Encoder operating voltage	5 V _{DC} (-5% to +10%) (generated from the 24 V _{DC} power contacts)
Sensor output current	0.5 A
Counter	32 bit
Zero pulse latch	-
Limit frequency	5 MHz (equals 20 million increments with 4-fold evaluation)
Quadrature decoder	4-fold evaluation

Function and communication	EL5101-0011
Distributed Clocks	yes
Oversampling factor	n = 1 ... 100, adjustable
Cycle time	min. 500 μ s
Conversion time	10 μ s / 100 kSps
Broken wire detection to sensor	yes
Bit width in process image	up to 6 bytes outputs, 22 bytes inputs, depends on parameterization
Configuration	via TwinCAT System Manager [▶ 125]
Special features	<ul style="list-style-type: none"> oversampling, wire breakage detection, set counter

Supply and potentials	EL5101-0011
Current consumption from the E-bus	typ. 130 mA
Current consumption from the power contacts	0.1 A (excluding sensor load current)
Electrical isolation	500 V (E-bus/field voltage)

Environmental conditions	EL5101-0011
Permissible ambient temperature range during operation	-25°C ... +60°C (extended temperature range)
Permissible ambient temperature range during storage	-40°C ... +85°C
Permissible relative humidity	95%, no condensation

General data	EL5101-0011
Weight	approx. 100 g
Dimensions (W x H x D)	approx. 27 mm x 100 mm x 70 mm (width aligned: 24 mm)
Mounting [▶ 55]	on 35 mm mounting rail conforms to EN 60715
Installation position	variable

Standards and approvals	EL5101-0011
Enhanced mechanical load capacity	yes, see also Installation instructions [▶ 62] for terminals with increased mechanical load capacity
Vibration/shock resistance	according to EN 60068-2-6/EN 60068-2-27
EMC immunity/emission	conforms to EN 61000-6-2 / EN 61000-6-4
Protection class	IP20
Approvals/markings*	CE, EAC, UKCA, cULus [▶ 61] ATEX [▶ 58] , IECEX [▶ 59]

*) Real applicable approvals/markings see type plate on the side (product marking).

Ex markings

Standard	Marking
ATEX	II 3 G Ex nA IIC T4 Gc
IECEX	Ex nA IIC T4 Gc

6 EL5101-0090 - Product description

6.1 Introduction

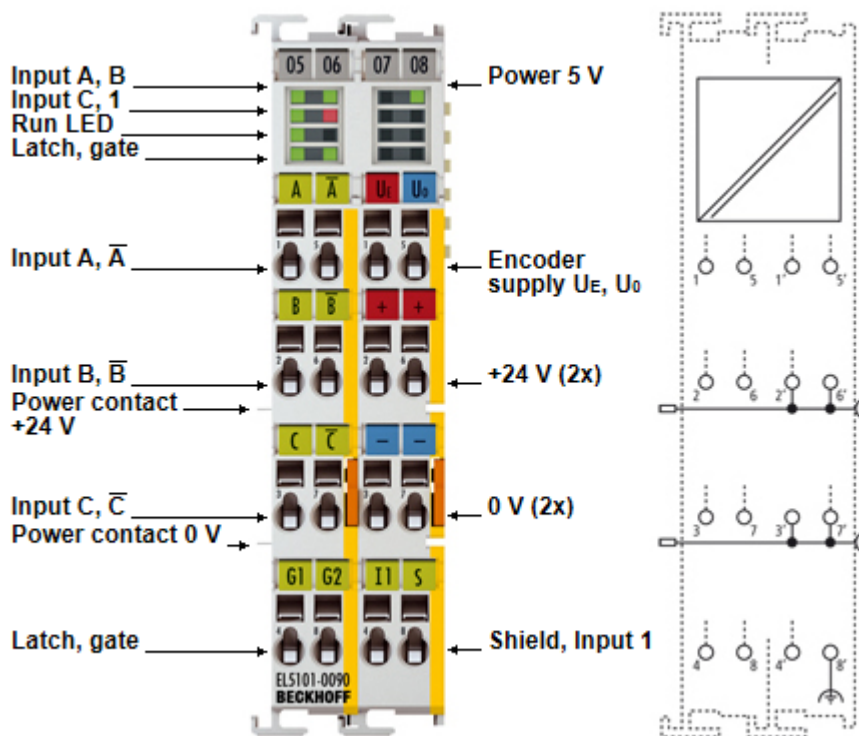

Fig. 7: EL5101-0090

Incremental encoder interface, RS422, TTL, 1 MHz, TwinSAFE SC

The EL5101-0090 EtherCAT Terminal is an interface for direct connection of incremental encoders with differential inputs (RS422) or TTL single ended signals. Input frequencies up to 1 MHz can be evaluated. The measurement of period and frequency with a resolution of 100 ns is possible. The EL5101-0090 can also be used as bidirectional counter on channel A; channel B specifies the count direction.

Two additional 24 V digital inputs are available for storing, blocking and setting the counter status. The gate input allows the locking of the counter, alternatively with a high or low level. The latch input is similarly configurable and evaluates high or low levels.

Incremental encoders with alarm output can be connected at the negative switching status input of the interface. The 5 V and 24 V supply of the encoder can be provided directly via the terminal connection points.

In normal operating mode a 16-bit counter and a 16-bit latch for the zero pulse can be read, set or enabled. In enhanced operating mode a switchable 16/32-bit counter and a 32-bit latch for the zero pulse can be read, set or enabled.

Different functions are available in the two operating modes (see Table below)!

Operating modes EL5101-0090	Functional description
normal operating mode	All basic functions as described above
enhanced operating mode	Changes to the normal operating mode <ul style="list-style-type: none"> • Distributed clock support • Micro-increments • Open circuit detection • Connection of Single-Ended signals possible

The EL5101-0090 supports distributed clocks in the enhanced operating mode, i.e. the input data can be recorded synchronously with other data that are also linked to Distributed Clock slaves. The accuracy across the system is < 100 ns.

The operating modes are described separately in chapter "[EL5101 - Commissioning \[▶ 145\]](#)". During commissioning it must be decided which operating mode is to be used.

In addition to the full functionality of the EL5101, the EL5101-0090 supports TwinSAFE SC (Single Channel) technology. This enables the use of standard signals for safety tasks in any networks of fieldbuses.

Quick links

- [Basics communication \[▶ 40\]](#)
- [Creation of the TwinCAT configuration \[▶ 117\]](#)
- [EL5101 - process data, modes, object description \[▶ 145\]](#)
- [TwinSAFE SC \[▶ 233\]](#)
- [EL5101-0090 - TwinSAFE SC process data \[▶ 257\]](#)
- [LEDs and connection \[▶ 70\]](#)

6.2 Technical data

Encoder	EL5101-0090
Technology	Incremental encoder interface, differential (RS422), single-ended (TTL), counter, pulse generator
Additional inputs	Gate, latch (24 V _{DC} , both max. 1 MHz permitted), Signal voltage: "0": -3 V ... +5 V (EN 61131-2, type 3) "1": 11 V ... 30 V (EN 61131-2, type 3) Status input (max. 5 V _{DC} , potential-free, switching to negative potential)
Encoder connection	A, -A, B, -B, C, -C (RS422 differential inputs) also single-ended connection (5 V ±20%) possible
Encoder operating voltage	5 V _{DC} (-5% to +10%) (generated from the 24 V _{DC} power contacts)
Sensor output current	0.5 A
Counter	16 bit, 16/32 bit switchable
Zero pulse latch	16 bit, 16/32 bit switchable
Limit frequency	1 MHz (equals 4 million increments with 4-fold evaluation)
Quadrature decoder	4-fold evaluation

Function and communication	EL5101-0090
Distributed Clocks	yes
Cycle time	min. 100 µs
Broken wire detection to sensor	yes
Bit width in process image	up to 6 bytes outputs, 22 bytes inputs, depends on parameterization
Configuration	via TwinCAT System Manager [▶ 125]
Special features	<ul style="list-style-type: none"> • TwinSAFE SC, • wire breakage detection, • latch and gate function, • period duration and frequency measurement, • microincrements, • time-stamping of edges, • filters

Supply and potentials	EL5101-0090
Current consumption from the E-bus	typ. 130 mA
Current consumption from the power contacts	0.1 A (excluding sensor load current)
Electrical isolation	500 V (E-bus/field voltage)

Environmental conditions	EL5101-0090
Permissible ambient temperature range during operation	-25°C ... +60°C (extended temperature range)
Permissible ambient temperature range during storage	-40°C ... +85°C
Permissible relative humidity	95%, no condensation

General data	EL5101-0090
MTBF (+55°C)	> 790,000 h
Weight	approx. 100 g
Dimensions (W x H x D)	approx. 27 mm x 100 mm x 70 mm (width aligned: 24 mm)
Mounting [▶ 55]	on 35 mm mounting rail conforms to EN 60715
Installation position	variable

Standards and approvals	EL5101-0090
Enhanced mechanical load capacity	yes, see also Installation instructions [▶ 62] for terminals with increased mechanical load capacity
Vibration/shock resistance	according to EN 60068-2-6/EN 60068-2-27
EMC immunity/emission	conforms to EN 61000-6-2 / EN 61000-6-4
Protection class	IP20
Approvals/markings*	CE, EAC, UKCA, cULus [▶ 61] ATEX [▶ 58], IECEx [▶ 59]

*) Real applicable approvals/markings see type plate on the side (product marking).

Ex markings

Standard	Marking
ATEX	II 3 G Ex nA IIC T4 Gc
IECEx	Ex nA IIC T4 Gc

7 Overview EL5101-00xx series

Technical data	EL5101	EL5101-0090	EL5101-0010	EL5101-0011
Sensor connection	A, \neg A, B, \neg B, C, \neg C (RS422 differential inputs) also single-ended connection (5 V \pm 20%) possible (EL5101 from hardware 09 260)		A, \neg A, B, \neg B, C, \neg C (RS422 differential inputs)	
Additional inputs	gate, latch (24 V _{DC} , both max. 1 MHz permitted), status input (max. 5 V _{DC} , potential-free, switching to negative potential)			-
Encoder operating voltage / Encoder supply	5 V _{DC} (-5% to +10%) (generated from the 24 V _{DC} power contacts)			
Sensor output current	0.5 A			
Counter	16 bit, 16/32 bit switchable (EL5101 from firmware 14 / hardware 09 260)			32 bit
Zero pulse latch	16 bit, 16/32 bit switchable (EL5101 from firmware 14 / hardware 09 260)			-
Limit frequency	1 MHz (equals 4 million increments with 4-fold evaluation)		5 MHz (equals 20 million increments with 4-fold evaluation)	
Quadrature decoder	4-fold evaluation			
Distributed Clocks	in enhanced operating mode (from firmware 14 / hardware 09 260)	yes		
Broken wire detection to sensor	in enhanced operating mode (from firmware 14 / hardware 09 260)	yes		
Cycle time	min. 100 μ s			min. 500 μ s
Conversion time	-			10 μ s / 100 kSps
Oversampling factor	-			n = 1..100, adjustable
MTBF (+55°C)	-	> 790,000 h	-	

Functions	EL5101	EL5101-0090	EL5101-0010	EL5101-0011
Gate- and Latch function	yes	yes	yes	no
Micro-increments	in enhanced operating mode (from firmware 14 / hardware 09 260)	yes	no	no
Timestamp of edges	in enhanced operating mode (from firmware 14 / hardware 09 260)	yes	yes	no
Period and Frequency measurement	yes	yes	yes	no
Up/down counter	yes	yes	no	no
Filter	yes	yes	yes	no
Oversampling	no	no	no	yes
TwinSAFE Single Channel	no	yes	no	no

8 Incremental encoder basics

Incremental encoders divide a 360° rotation of the encoder axis into individual steps (increments) and mark a full revolution by means of a special mark (zero pulse). An RS422 encoder transmits the signal symmetrically as a differential line pair. TTL encoders use single signal lines (single-ended).

The terminal evaluates the 90° phase-shifted square wave signals of an incremental encoder on tracks A and B. The zero pulse is captured on track C. With a differential connection, the inverted signals (\bar{A} , \bar{B} , \bar{C}) are also recorded.

These signals are converted by means of the quadrature decoder and counter into a position value with optional quadruple evaluation. The digital inputs enable latch, reset and set functionalities and thus exact and speed-independent referencing and storage of the counter value.

Encoder type		Incremental signals
RS422 encoder	with zero pulse	A, \bar{A} , B, \bar{B} , C, \bar{C}
RS422 encoder	without zero pulse	A, \bar{A} , B, \bar{B}
RS422 counter or pulse generator	with zero pulse	A, \bar{A} , C, \bar{C} ; Counting direction specification via track B (B, \bar{B})
RS422 counter or pulse generator	without zero pulse	A, \bar{A} ; Counting direction specification via track B (B, \bar{B})
TTL encoder	with zero pulse	A, B, C
TTL encoder	without zero pulse	A, B
TTL counter or pulse generator	with zero pulse	A, C; Counting direction specification via B
TTL counter or pulse generator	without zero pulse	A, Counting direction specification via B

The phase position between the signals on track A and track B determines the counting direction.
 Forward (cw): Signal on track A leads track B by 90°
 Reverse (ccw): Signal on track A lags track B by 90°.

With quadruple evaluation the rising and falling edges on track A and track B are counted.

Cyclical output

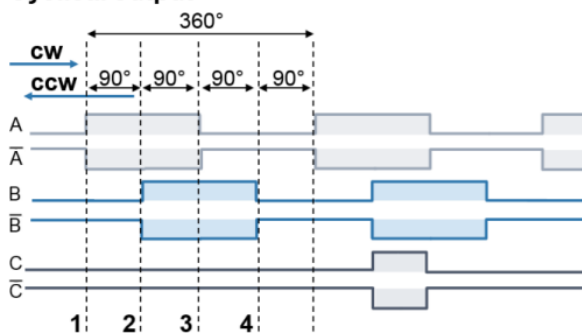

Fig. 8: Incremental signals

Absolute value encoders provide an absolute position value directly after switch-on, which is unambiguous over the entire travel path. With incremental encoders, homing must be performed after switch-on in order to be able to determine an unambiguous position. Referencing can be carried out, for example, with the aid of referencing cams or using the zero pulse of the encoder.

NOTICE

Differential and single-ended connection

The RS422 signal transmits a differential voltage, which makes the signal less sensitive to interference compared to a single-ended signal.

- If the encoder signal is to be transmitted over longer distances or at higher frequencies, an encoder with RS422 signals is recommended.
- Shielded and twisted pair cables should be used.

9 Technical properties

The EL5101-00xx incremental encoder interface terminals enable connection of incremental encoders with A/B/C track to the Bus Coupler and the PLC. The terminal is supplied as a 4-fold quadrature decoder with complementary analysis of the sensor signals A, B, C. Differential signals based on RS422 (for EL5101 and EL5101-0090 also TTL) are provided as encoder connection.

In addition to the encoder inputs A, B and C, an additional latch input (24 V) and a gate input (24 V) for locking the counter during operation is available (not for EL5101-0011).

If the incremental encoder has an alarm output it can be connected to the INPUT 1 status input of the EL5101-00x0

EL5101

In normal operating mode a 16-bit counter and a 16-bit latch for the zero pulse can be read, set or enabled. In enhanced operating mode a switchable 16/32-bit counter and a 32-bit latch for the zero pulse can be read, set or enabled.

Only from FW14/HW09 onwards the EL5101 terminal supports the enhanced operating mode in addition to the normal operation mode. The differences are explained in chapter "[EL5101 - Enhanced operation mode from FW14/HW09 \[► 35\]](#)".

For the EL5101 single-ended 5 V signals are possible based on pull-up resistors from [hardware 09 \[► 260\]](#).

The EL5101 can optionally be operated as a bidirectional counter terminal on channel A.

EL5101-0090

In addition to the full functionality of the EL5101, the EL5101-0090 supports TwinSAFE SC (Single Channel) technology.

EL5101-0010

The EL5101-0010 with a resolution of 20 mio. increments/s at 5 MHz and 4-fold evaluation is only applicable for the enhanced operating mode. The inputs can only process differential signals according to RS422.

The microincrement mode is not available for the EL5101-0010.

EL5101-0011

The EL5101-0011 with a resolution of 20 mio. increments/s at 5 MHz and 4-fold evaluation is only applicable for the enhanced operating mode. The inputs can only process differential signals according to RS422.

The microincrement mode is not available for the EL5101-0011.

The EL5101-0011 supports the oversampling principle.

The terminal does not have additional latch and gate inputs.

9.1 EL5101 - Extended operating mode (from FW14/HW09)

Through the further development of the EL5101 an enhanced operating mode is available (from [firmware 14 / hardware 09 \[▶ 260\]](#)), which can be parameterized in the TwinCAT System Manager, depending on the hardware used.

Older EL5101 devices do not support this extended operating mode (see following Table)!

Operating modes EL5101			
Version	From FW/HW	ESI	Functional description
normal operating mode EL5101	03/05	from EL5101-0000-0000	All basic functions as described above
enhanced operating mode EL5101	14/09	from EL5101-0000-1018	Changes to the normal operating mode <ul style="list-style-type: none"> • Distributed clock support • Micro-increments • Broken wire detection • Connection of single ended signals possible

● Compatibility in the case of service



- An EL5101 designed for and used in enhanced operating mode cannot be replaced with an EL5101 with older hardware version (< 09)!
- EL5101-0010 and EL5101-0011 only support the enhanced operating mode and are not exchange-compatible with an EL5101 (hardware version < 09)!

Irrespective of the hardware/firmware version, after integration into a system an EL5101 reports in normal operating mode.

During commissioning the user has to decide with what functionality, i.e. in what operating mode, the EL5101 is to be used. This depends on the required functions and, of course, the hardware version. Hardware older than [firmware 14/hardware 09 \[▶ 260\]](#), for example, will not support enhanced operating mode functions.

Combination of functions from different operating modes is not possible.

Specific settings are described in chapter [“EL5101 - Commissioning \[▶ 145\]”](#).

9.2 Note on monitoring the process data

● Process data monitoring



- **WcState:** if ≠ 0, this EtherCAT device does not take part in the process data traffic
- **State:** if ≠ 8, the EtherCAT device is not in OP (operational) status
- **TxPDO state, SyncError:** if ≠ 0, then no valid process data are available, e.g. caused by broken wire
- **TxPDO Toggle:** if this bit is toggling, a new set of process data is available

9.3 EtherCAT cycle time

- For the EL5101-00x0 a minimum EtherCAT cycle time of >100 µs is recommended.
- For the EL5101-0011 a minimum EtherCAT cycle time of >500 µs is recommended.

If a faster cycle time is used, the toggling process record *TxPDO Toggle* should be used to monitor when new process data are supplied by the EL5101-00xx.

9.4 Inputs

EL5101-00xx input impedance

The signal source must be able to operate the input impedance of the EL5101-00xx (typically 220 Ω, subject to modification) with adequate voltage levels according to RS422.

NOTICE

Fast digital inputs – interference from interfering devices

Please note that the input wiring has very little filtering. It has been optimized for fast signal transmission from the input to the evaluation unit. In other words, rapid level changes/pulses in the μs range and/or high-frequency interference signals from devices (e.g. proportional valves, stepper motor or DC motor output stages) arrive at the evaluation unit almost unfiltered/unattenuated. These interferences can be incorrectly detected as a signal.

- To suppress interference, an additional input filter can be parameterized.
- Furthermore, EMC-compliant cabling and the use of separate power supply units for the terminal and the devices causing interference are recommended.

Gate and latch input (EL5101-00x0)

For gate and latch inputs (24 V) a max. input frequency of 1 MHz is permitted (Subject to modification).

Both inputs are type 3 inputs according to EN 61131-2, with a minimum pulse duration of $t_{ON} > 1\mu s$.

Digital input type 3, according to EN 61131-2	Voltage [V]	Input current [mA]
Signal voltage "0 - LOW"	-3 V ... +5 V typ.	0 mA ... 2.6 mA typ.
Signal voltage "1 - HIGH"	11 V ... 30 V typ.	typ. 3 mA

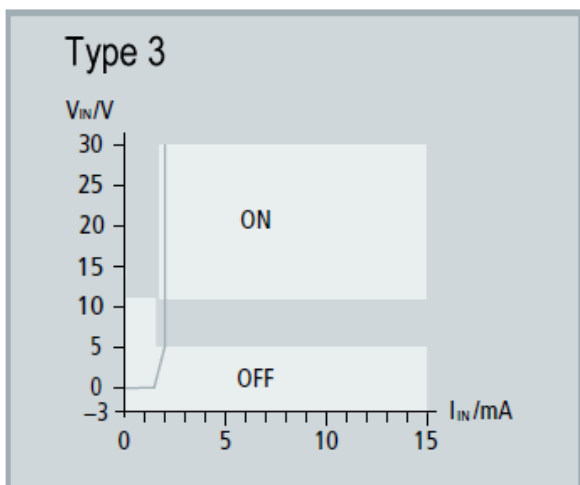

Fig. 9: Characteristic 24 V_{DC} Input type 3

Status input (EL5101-00x0)

The terminal provides a Status Input. The alarm output or status output of an encoder can be connected to this input.

The input is 5 V compatible.

Digital input, 5 V TTL input characteristic	Voltage [V]	Input current [mA]
Signal voltage "0 - LOW"	0 V ... + 0.8 V	typ. < 1 mA
Signal voltage "1 - HIGH"	+2 V ... +5 V	typ. 0 mA

NOTICE**Wiring of the Status Input**

In the terminal the Status Input is internally connected to 5 V via a pull-up resistor.

The alarm output or status output of the encoder is usually designed with negative logic. This means that contacting against GND leads to an error bit and the LED display.

External power supply is not recommended. If an external supply is used, the maximum permitted voltage is 5 V against GND.

9.5 Signal types

Signal type RS422 (diff. input)

In differential mode the EL5101-00xx expects the signal levels after RS422. The data are transferred without ground reference as voltage difference between two cables (signal A and inverted signal /A). The terminal analyses differences greater than 200 mV as valid signals. The differential signal must be in the common mode range (<+13.2 V and >-10 V, with respect to GND) (cf. diagram). Signal levels outside this range can lead to destruction.

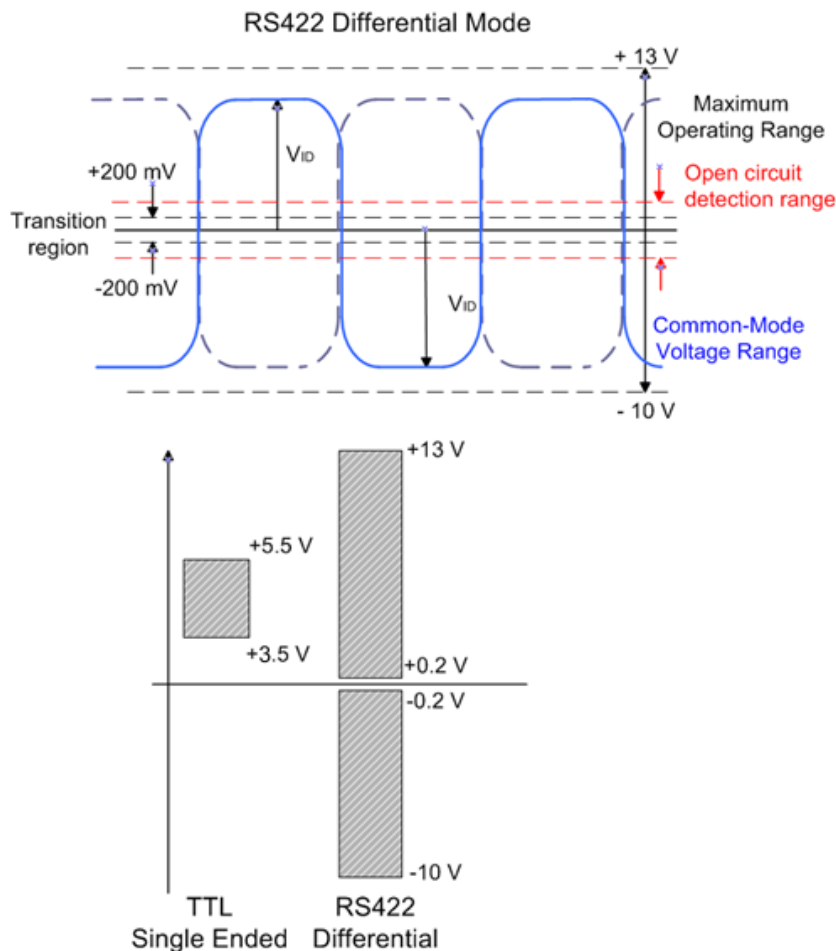

Fig. 10: Level interface

In differential mode only the voltage difference is evaluated, so that common-mode interference on the transmission link does not lead to corruption of the wanted signal, since any interference affects both cables simultaneously.

Signal type TTL (single ended)

If the EL5101 is only operated in single-ended mode, a nominal level voltage between 3.5 V and 5.5 V is expected.

The EL5101-0010 and EL5101-0011 do not support single-ended mode.

Open circuit detection

Open circuit detection (Index 0x80n0:0B, 0x80n0:0C, 0x80n0:0D) is activated:

- for EL5101-0010 and EL5101-0011, in the range $-0.475 \text{ V} > V_{id} > +0.475 \text{ V}$ (typically),
- for EL5101 and EL5101-0090, in the range $-1.5 \text{ V} > V_{id} > +1.5 \text{ V}$ (typically)

(subject to change).

10 Start

For commissioning:

- mount the EL5101 as described in the chapter [Mounting and wiring \[▶ 54\]](#)
- configure the EL5101 in TwinCAT as described in the chapter [Commissioning \[▶ 74\]](#).

11 Basics communication

11.1 EtherCAT basics

Please refer to the [EtherCAT System Documentation](#) for the EtherCAT fieldbus basics.

11.2 EtherCAT cabling – wire-bound

The cable length between two EtherCAT devices must not exceed 100 m. This results from the FastEthernet technology, which, above all for reasons of signal attenuation over the length of the cable, allows a maximum link length of 5 + 90 + 5 m if cables with appropriate properties are used. See also the [Design recommendations for the infrastructure for EtherCAT/Ethernet](#).

Cables and connectors

For connecting EtherCAT devices only Ethernet connections (cables + plugs) that meet the requirements of at least category 5 (Cat5) according to EN 50173 or ISO/IEC 11801 should be used. EtherCAT uses 4 wires for signal transfer.

EtherCAT uses RJ45 plug connectors, for example. The pin assignment is compatible with the Ethernet standard (ISO/IEC 8802-3).

Pin	Color of conductor	Signal	Description
1	yellow	TD +	Transmission Data +
2	orange	TD -	Transmission Data -
3	white	RD +	Receiver Data +
6	blue	RD -	Receiver Data -

Due to automatic cable detection (auto-crossing) symmetric (1:1) or cross-over cables can be used between EtherCAT devices from Beckhoff.

● Recommended cables



- It is recommended to use the appropriate Beckhoff components e.g.
- cable sets ZK1090-9191-xxxx respectively
 - RJ45 connector, field assembly ZS1090-0005
 - EtherCAT cable, field assembly ZB9010, ZB9020

Suitable cables for the connection of EtherCAT devices can be found on the [Beckhoff website!](#)

E-Bus supply

A bus coupler can supply the EL terminals added to it with the E-bus system voltage of 5 V; a coupler is thereby loadable up to 2 A as a rule (see details in respective device documentation). Information on how much current each EL terminal requires from the E-bus supply is available online and in the catalogue. If the added terminals require more current than the coupler can supply, then power feed terminals (e.g. [EL9410](#)) must be inserted at appropriate places in the terminal strand.

The pre-calculated theoretical maximum E-Bus current is displayed in the TwinCAT System Manager. A shortfall is marked by a negative total amount and an exclamation mark; a power feed terminal is to be placed before such a position.

The screenshot shows the 'I/O Devices' tree on the left and a table of current calculations on the right. The table has columns for Number, Box Name, Address, Type, In Si..., Out ..., and E-Bus (mA). The E-Bus (mA) column is highlighted with a red box. The data in the table is as follows:

Number	Box Name	Add...	Type	In Si...	Out ...	E-Bus (mA)
1	Term 1 (EK1100)	1001	EK1100			
2	Term 2 (EL2008)	1002	EL2008		1.0	1890
3	Term 3 (EL2008)	1003	EL2008		1.0	1780
4	Term 4 (EL2008)	1004	EL2008		1.0	1670
5	Term 5 (EL6740-...)	1005	EL6740-0010	2.0	2.0	1220
6	Term 6 (EL6740-...)	1006	EL6740-0010	2.0	2.0	770
7	Term 7 (EL6740-...)	1007	EL6740-0010	2.0	2.0	320
8	Term 8 (EL6740-...)	1008	EL6740-0010	2.0	2.0	-130 I
9	Term 9 (EL6740-...)	1009	EL6740-0010	2.0	2.0	-580 I

Fig. 11: System manager current calculation

NOTICE

Malfunction possible!
 The same ground potential must be used for the E-Bus supply of all EtherCAT terminals in a terminal block!

11.3 General notes for setting the watchdog

The EtherCAT terminals are equipped with a safety device (watchdog) which, e. g. in the event of interrupted process data traffic, switches the outputs (if present) to a presettable state after a presettable time, depending on the device and setting, e. g. to FALSE (off) or an output value.

The EtherCAT slave controller (ESC) features two watchdogs:

- SM watchdog (default: 100 ms)
- PDI watchdog (default: 100 ms)

Their times are individually parameterized in TwinCAT as follows:

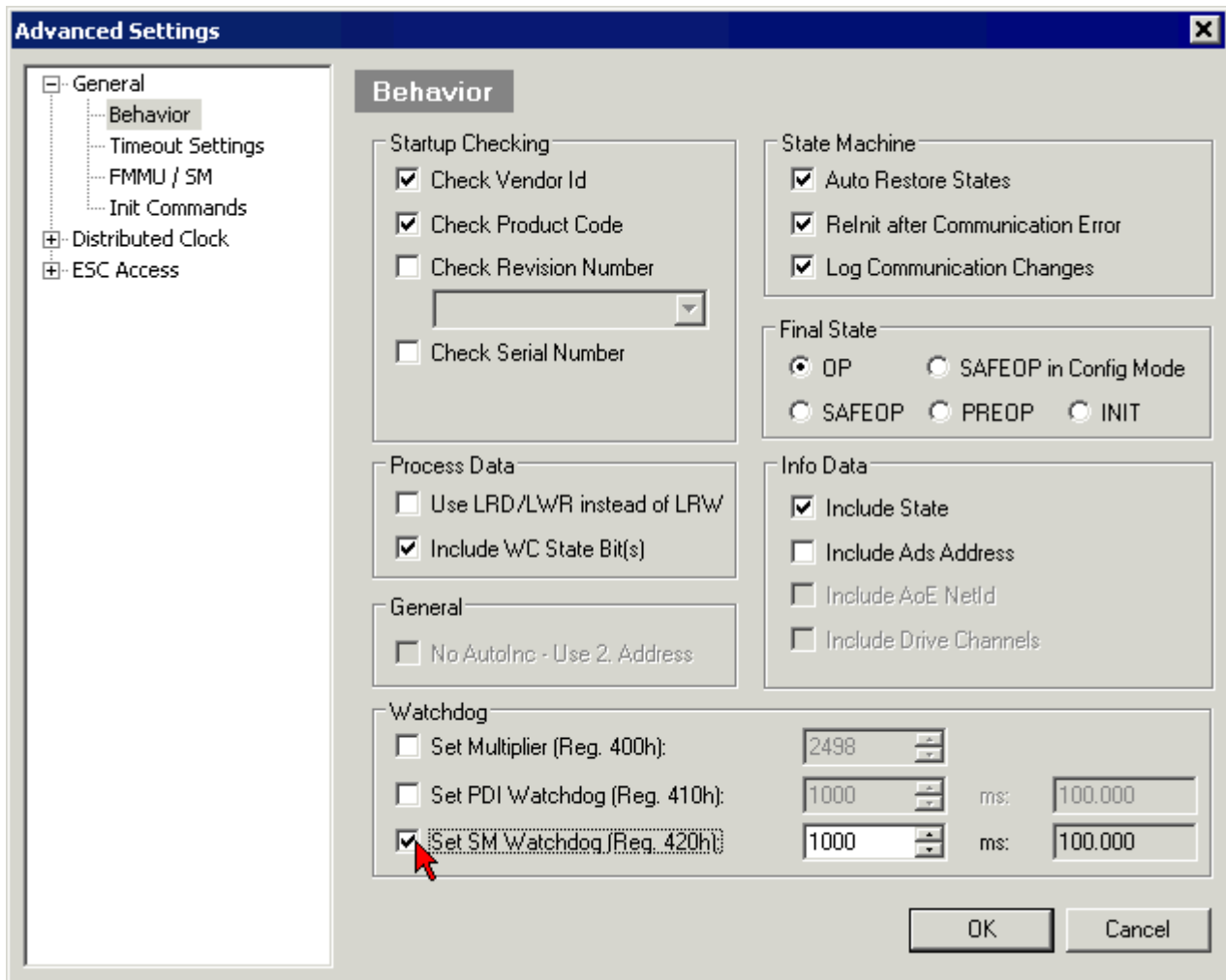

Fig. 12: eEtherCAT tab -> Advanced Settings -> Behavior -> Watchdog

Notes:

- the Multiplier Register 400h (hexadecimal, i. e. x0400) is valid for both watchdogs.
- each watchdog has its own timer setting 410h or 420h, which together with the Multiplier results in a resulting time.
- important: the Multiplier/Timer setting is only loaded into the slave at EtherCAT startup if the checkbox in front of it is activated.
- if it is not checked, nothing is downloaded and the setting located in the ESC remains unchanged.
- the downloaded values can be seen in the ESC registers x0400/0410/0420: ESC Access -> Memory

SM watchdog (SyncManager Watchdog)

The SyncManager watchdog is reset with each successful EtherCAT process data communication with the terminal. If, for example, no EtherCAT process data communication with the terminal takes place for longer than the set and activated SM watchdog time due to a line interruption, the watchdog is triggered. The status of the terminal (usually OP) remains unaffected. The watchdog is only reset again by a successful EtherCAT process data access.

The SyncManager watchdog is therefore a monitoring for correct and timely process data communication with the ESC from the EtherCAT side.

The maximum possible watchdog time depends on the device. For example, for "simple" EtherCAT slaves (without firmware) with watchdog execution in the ESC it is usually up to 170 seconds. For complex EtherCAT slaves (with firmware) the SM watchdog function is usually parameterized via Reg. 400/420 but executed by the µC and can be significantly lower. In addition, the execution may then be subject to a certain time uncertainty. Since the TwinCAT dialog may allow inputs up to 65535, a test of the desired watchdog time is recommended.

PDI watchdog (Process Data Watchdog)

If there is no PDI communication with the EtherCAT slave controller (ESC) for longer than the set and activated PDI watchdog time, this watchdog is triggered.

PDI (Process Data Interface) is the internal interface of the ESC, e.g. to local processors in the EtherCAT slave. With the PDI watchdog this communication can be monitored for failure.

The PDI watchdog is therefore a monitoring for correct and timely process data communication with the ESC, but viewed from the application side.

Calculation

Watchdog time = $[1/25 \text{ MHz} * (\text{Watchdog multiplier} + 2)] * \text{PDI/SM watchdog}$

Example: default setting Multiplier=2498, SM watchdog=1000 -> 100 ms

The value in Multiplier + 2 corresponds to the number of 40ns base ticks representing one watchdog tick.

⚠ CAUTION
Undefined state possible!
The function for switching off the SM watchdog via SM watchdog = 0 is only implemented in terminals from version -0016. In previous versions this operating mode should not be used.

⚠ CAUTION
Damage of devices and undefined state possible!
If the SM watchdog is activated and a value of 0 is entered the watchdog switches off completely. This is the deactivation of the watchdog! Set outputs are NOT set in a safe state if the communication is interrupted.

11.4 EtherCAT State Machine

The state of the EtherCAT slave is controlled via the EtherCAT State Machine (ESM). Depending upon the state, different functions are accessible or executable in the EtherCAT slave. Specific commands must be sent by the EtherCAT master to the device in each state, particularly during the bootup of the slave.

A distinction is made between the following states:

- Init
- Pre-Operational
- Safe-Operational and
- Operational
- Boot

The regular state of each EtherCAT slave after bootup is the OP state.

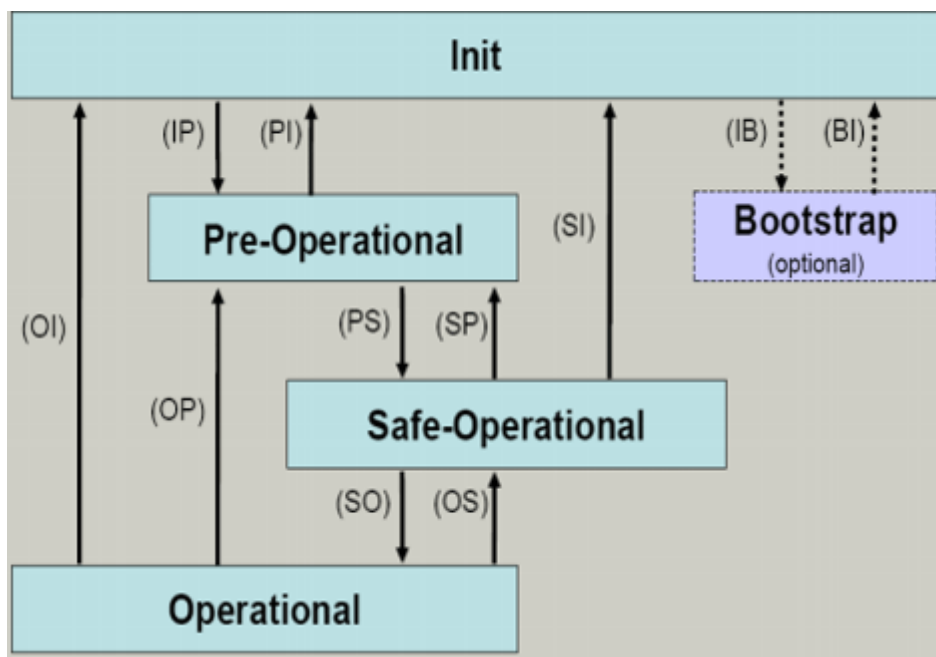

Fig. 13: States of the EtherCAT State Machine

Init

After switch-on the EtherCAT slave in the *Init* state. No mailbox or process data communication is possible. The EtherCAT master initializes sync manager channels 0 and 1 for mailbox communication.

Pre-Operational (Pre-Op)

During the transition between *Init* and *Pre-Op* the EtherCAT slave checks whether the mailbox was initialized correctly.

In *Pre-Op* state mailbox communication is possible, but not process data communication. The EtherCAT master initializes the sync manager channels for process data (from sync manager channel 2), the FMMU channels and, if the slave supports configurable mapping, PDO mapping or the sync manager PDO assignment. In this state the settings for the process data transfer and perhaps terminal-specific parameters that may differ from the default settings are also transferred.

Safe-Operational (Safe-Op)

During transition between *Pre-Op* and *Safe-Op* the EtherCAT slave checks whether the sync manager channels for process data communication and, if required, the distributed clocks settings are correct. Before it acknowledges the change of state, the EtherCAT slave copies current input data into the associated DP-RAM areas of the EtherCAT slave controller (ECSC).

In *Safe-Op* state mailbox and process data communication is possible, although the slave keeps its outputs in a safe state, while the input data are updated cyclically.

● Outputs in SAFEOP state

I The default set watchdog monitoring sets the outputs of the module in a safe state - depending on the settings in SAFEOP and OP - e.g. in OFF state. If this is prevented by deactivation of the watchdog monitoring in the module, the outputs can be switched or set also in the SAFEOP state.

Operational (Op)

Before the EtherCAT master switches the EtherCAT slave from *Safe-Op* to *Op* it must transfer valid output data.

In the *Op* state the slave copies the output data of the masters to its outputs. Process data and mailbox communication is possible.

Boot

In the *Boot* state the slave firmware can be updated. The *Boot* state can only be reached via the *Init* state.

In the *Boot* state mailbox communication via the *file access over EtherCAT* (FoE) protocol is possible, but no other mailbox communication and no process data communication.

11.5 CoE Interface

General description

The CoE interface (CAN application protocol over EtherCAT) is used for parameter management of EtherCAT devices. EtherCAT slaves or the EtherCAT master manage fixed (read only) or variable parameters which they require for operation, diagnostics or commissioning.

CoE parameters are arranged in a table hierarchy. In principle, the user has read access via the fieldbus. The EtherCAT master (TwinCAT System Manager) can access the local CoE lists of the slaves via EtherCAT in read or write mode, depending on the attributes.

Different CoE parameter types are possible, including string (text), integer numbers, Boolean values or larger byte fields. They can be used to describe a wide range of features. Examples of such parameters include manufacturer ID, serial number, process data settings, device name, calibration values for analog measurement or passwords.

The order is specified in two levels via hexadecimal numbering: (main)index, followed by subindex. The value ranges are

- Index: 0x0000 ...0xFFFF (0...65535_{dec})
- SubIndex: 0x00...0xFF (0...255_{dec})

A parameter localized in this way is normally written as 0x8010:07, with preceding "0x" to identify the hexadecimal numerical range and a colon between index and subindex.

The relevant ranges for EtherCAT fieldbus users are:

- 0x1000: This is where fixed identity information for the device is stored, including name, manufacturer, serial number etc., plus information about the current and available process data configurations.
- 0x8000: This is where the operational and functional parameters for all channels are stored, such as filter settings or output frequency.

Other important ranges are:

- 0x4000: here are the channel parameters for some EtherCAT devices. Historically, this was the first parameter area before the 0x8000 area was introduced. EtherCAT devices that were previously equipped with parameters in 0x4000 and changed to 0x8000 support both ranges for compatibility reasons and mirror internally.
- 0x6000: Input PDOs ("input" from the perspective of the EtherCAT master)

- 0x7000: Output PDOs (“output” from the perspective of the EtherCAT master)

i Availability

Not every EtherCAT device must have a CoE list. Simple I/O modules without dedicated processor usually have no variable parameters and therefore no CoE list.

If a device has a CoE list, it is shown in the TwinCAT System Manager as a separate tab with a listing of the elements:

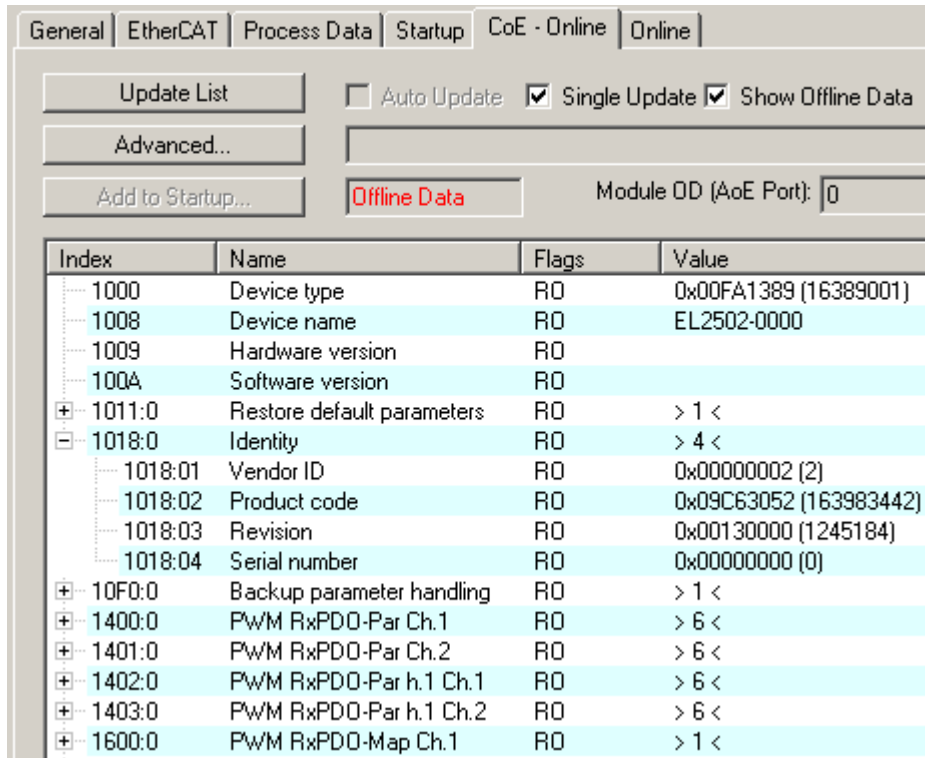

Fig. 14: “CoE Online” tab

The figure above shows the CoE objects available in device “EL2502”, ranging from 0x1000 to 0x1600. The subindices for 0x1018 are expanded.

NOTICE

Changes in the CoE directory (CAN over EtherCAT), program access

When using/manipulating the CoE parameters observe the general CoE notes in chapter “CoE interface” of the EtherCAT system documentation:

- Keep a startup list if components have to be replaced,
- Distinction between online/offline dictionary,
- Existence of current XML description (download from the [Beckhoff website](#)),
- “CoE-Reload” for resetting the changes
- Program access during operation via PLC (see [TwinCAT3 | PLC Library: Tc2 EtherCAT](#) and [Example program R/W CoE](#))

Data management and function “NoCoeStorage”

Some parameters, particularly the setting parameters of the slave, are configurable and writeable. This can be done in write or read mode

- via the System Manager (Fig. “CoE Online” tab) by clicking
This is useful for commissioning of the system/slaves. Click on the row of the index to be parameterized and enter a value in the “SetValue” dialog.

- from the control system/PLC via ADS, e.g. through blocks from the TcEtherCAT.lib library
This is recommended for modifications while the system is running or if no System Manager or operating staff are available.

i Data management

If slave CoE parameters are modified online, Beckhoff devices store any changes in a fail-safe manner in the EEPROM, i.e. the modified CoE parameters are still available after a restart. The situation may be different with other manufacturers.

An EEPROM is subject to a limited lifetime with respect to write operations. From typically 100,000 write operations onwards it can no longer be guaranteed that new (changed) data are reliably saved or are still readable. This is irrelevant for normal commissioning. However, if CoE parameters are continuously changed via ADS at machine runtime, it is quite possible for the lifetime limit to be reached. Support for the NoCoeStorage function, which suppresses the saving of changed CoE values, depends on the firmware version.

Please refer to the technical data in this documentation as to whether this applies to the respective device.

- If the function is supported: the function is activated by entering the code word 0x12345678 once in CoE 0xF008 and remains active as long as the code word is not changed. After switching the device on it is then inactive. Changed CoE values are not saved in the EEPROM and can thus be changed any number of times.
- Function is not supported: continuous changing of CoE values is not permissible in view of the lifetime limit.

i Startup list

Changes in the local CoE list of the terminal are lost if the terminal is replaced. If a terminal is replaced with a new Beckhoff terminal, it will have the default settings. It is therefore advisable to link all changes in the CoE list of an EtherCAT slave with the Startup list of the slave, which is processed whenever the EtherCAT fieldbus is started. In this way a replacement EtherCAT slave can automatically be parameterized with the specifications of the user.

If EtherCAT slaves are used which are unable to store local CoE values permanently, the Startup list must be used.

Recommended approach for manual modification of CoE parameters

- Make the required change in the System Manager
The values are stored locally in the EtherCAT slave
- If the value is to be stored permanently, enter it in the Startup list.
The order of the Startup entries is usually irrelevant.

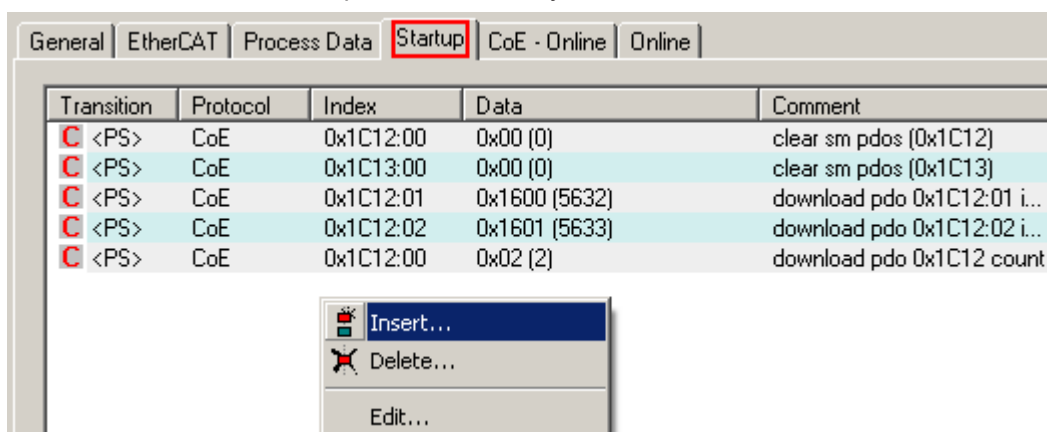

Fig. 15: Startup list in the TwinCAT System Manager

The Startup list may already contain values that were configured by the System Manager based on the ESI specifications. Additional application-specific entries can be created.

Online/offline list

While working with the TwinCAT System Manager, a distinction has to be made whether the EtherCAT device is “available”, i.e. switched on and linked via EtherCAT and therefore **online**, or whether a configuration is created **offline** without connected slaves.

In both cases a CoE list as shown in Fig. “CoE online tab” is displayed. The connectivity is shown as offline/online.

- If the slave is offline
 - The offline list from the ESI file is displayed. In this case modifications are not meaningful or possible.
 - The configured status is shown under Identity.
 - No firmware or hardware version is displayed, since these are features of the physical device.
 - **Offline** is shown in red.

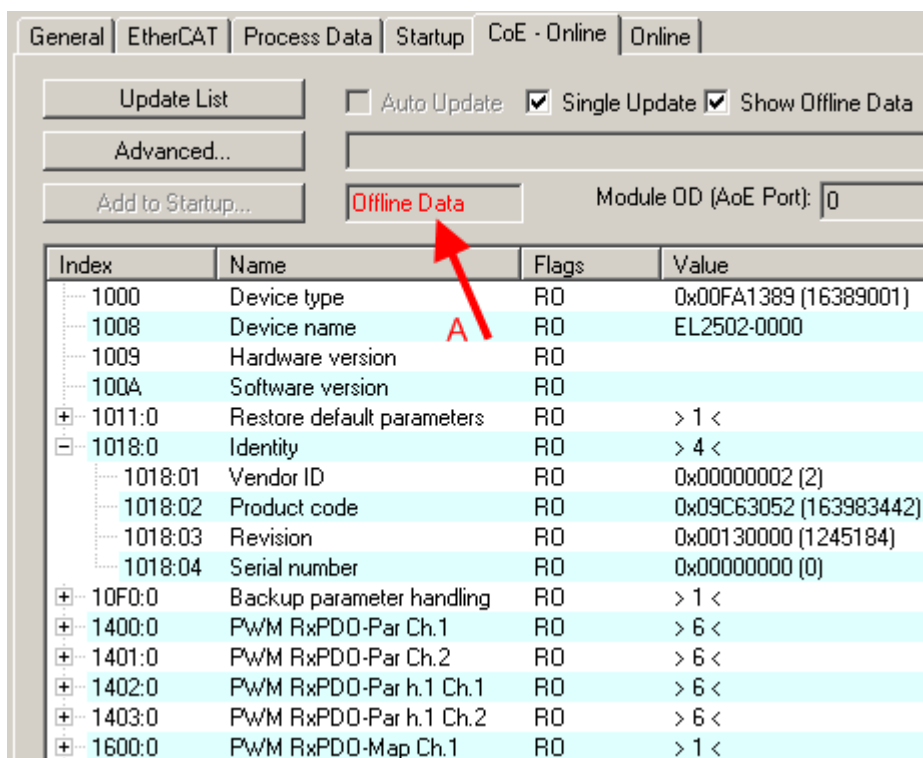

Index	Name	Flags	Value
1000	Device type	RO	0x00FA1389 (16389001)
1008	Device name	RO	EL2502-0000
1009	Hardware version	RO	
100A	Software version	RO	
1011:0	Restore default parameters	RO	> 1 <
1018:0	Identity	RO	> 4 <
1018:01	Vendor ID	RO	0x00000002 (2)
1018:02	Product code	RO	0x09C63052 (163983442)
1018:03	Revision	RO	0x00130000 (1245184)
1018:04	Serial number	RO	0x00000000 (0)
10F0:0	Backup parameter handling	RO	> 1 <
1400:0	PWM RxPDO-Par Ch.1	RO	> 6 <
1401:0	PWM RxPDO-Par Ch.2	RO	> 6 <
1402:0	PWM RxPDO-Par h.1 Ch.1	RO	> 6 <
1403:0	PWM RxPDO-Par h.1 Ch.2	RO	> 6 <
1600:0	PWM RxPDO-Map Ch.1	RO	> 1 <

Fig. 16: Offline list

- If the slave is online
 - The actual current slave list is read. This may take several seconds, depending on the size and cycle time.
 - The actual identity is displayed
 - The firmware and hardware version of the equipment according to the electronic information is displayed
 - **Online** is shown in green.

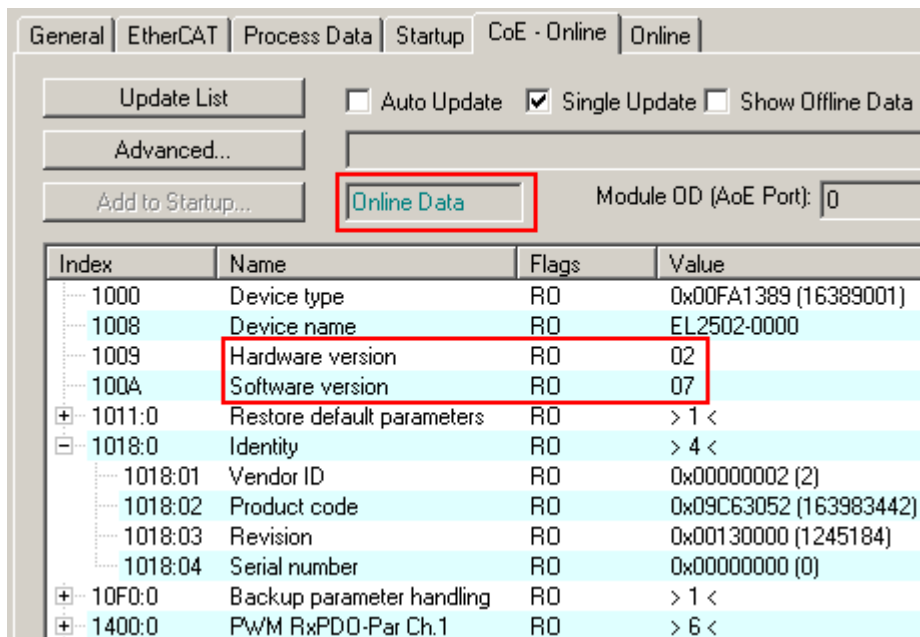

Fig. 17: Online list

Channel-based order

The CoE list is available in EtherCAT devices that usually feature several functionally equivalent channels. For example, a 4-channel analog 0...10 V input terminal also has four logical channels and therefore four identical sets of parameter data for the channels. In order to avoid having to list each channel in the documentation, the placeholder “n” tends to be used for the individual channel numbers.

In the CoE system 16 indices, each with 255 subindices, are generally sufficient for representing all channel parameters. The channel-based order is therefore arranged in $16_{dec}/10_{hex}$ steps. The parameter range 0x8000 exemplifies this:

- Channel 0: parameter range 0x8000:00 ... 0x800F:255
- Channel 1: parameter range 0x8010:00 ... 0x801F:255
- Channel 2: parameter range 0x8020:00 ... 0x802F:255
- ...

This is generally written as 0x80n0.

Detailed information on the CoE interface can be found in the [EtherCAT system documentation](#) on the Beckhoff website.

11.6 DC settings

Distributed Clocks (DC)

i EtherCAT and Distributed Clocks

A basic introduction into EtherCAT and distributed clocks is available for download from the Beckhoff website: the [“Distributed clocks system description”](#).

The incremental encoder terminals support the distributed clocks function (EL5101: from Hardware 09 / Firmware 14; EL5151 from Hardware 01 / Firmware 05). In order for the EL51xx to be able to make the current counter value available in the designated process data in time before the arrival of the querying EtherCAT datagram, a suitable signal must be generated cyclically within the terminal. This signal can be triggered in the EL51xx through two events: the SyncManager (SM) and the distributed clock (DC). Under operation mode selection the following options are available (see Fig. 1)

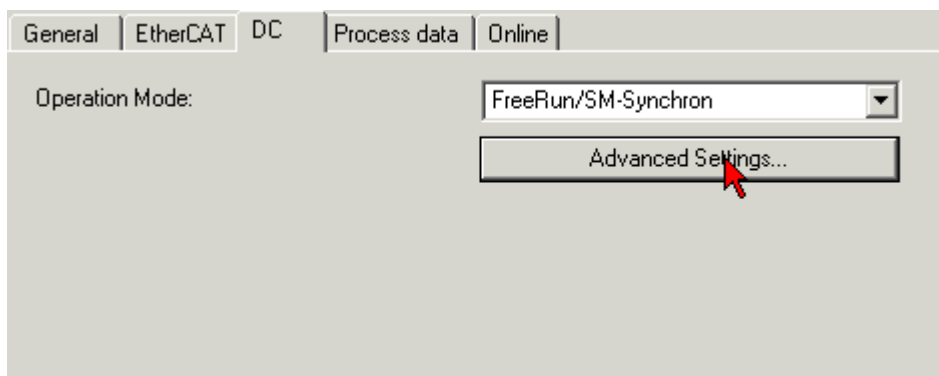

Fig. 18: “DC” tab (Distributed Clocks)

- **FreeRun/SM-Synchron**

The SynManager event occurs when an EtherCAT frame successfully exchanges process data with the EL51xx. Frame-triggered, the current counter value is thus cyclically determined, but with the low temporal jitter of the Ethernet frame. In this mode an Ethernet frame triggers the process data provision for the *next* retrieving frame. This generally only occurs after 1x cycle time.

- **DC Synchronous**

In DC mode, a counter reading is triggered by the integrated DC unit with a constant cycle, usually in synchrony with the bus cycle, although with a constant shift (phase, shift time, offset). Sampling is significantly more uniform (synchronization accuracy: 100 ns), which means a higher-level control algorithm can be supplied with higher-quality position data, for example. In the EL51xx the trigger is the SYNC0 signal, which is set like an output component in “DC-synchron” mode. See [Distributed Clocks system description](#).

The DC modes enable the start time of the process data provision to be offset by an offset value (shift value). This offset value can only be set on EtherCAT startup and can then no longer be changed during the uptime. Based on the general distributed clocks SYNC function model, the terminal-specific SYNC signal can either occur *before* or *after* the expect frame pass-through time: For input terminals the SYNC signal is generated *before* the frame, in order to make current input data available for forwarding. For output terminals the SYNC signal is set to a time *after* the frame has passed through, so that the just supplied data are output immediately. Since only one of the two modes is possible, the user can set the optimum mode for his application.

“DC Synchronous” corresponds to the output module configuration. The local SYNC event is triggered shortly after the EtherCAT frame has passed.

- **DC-Synchron (input based)**

In the “DC-Synchronous (input based)” mode this EL51xx is assigned to the group of input modules and the shift time (see Fig. *Advanced Distributed Clock (DC) settings, EL51xx terminal*) is calculated accordingly.

When “DC-Synchronous” operating mode is activated, TwinCAT selects settings that ensure reliable operation of the EL51xx and the acquisition of current position data. This means that determination of the current counter value is started by the SYNC0 signal at highly constant intervals and in the operating mode “DC-Synchronous (input based)” in good time – i.e. with an adequate safety buffer – before the retrieving EtherCAT datagram.

i Duration of the process data provision in the EL51x1

The EL5101 (from Hardware 09 / Firmware 14) or the EL5151 (from Hardware 01/ Firmware 05) requires approx. 80 µs after the SYNC event to determine the position data and provide them for retrieval. This value depends on the configuration and parameterization. The actual current duration can be read using the internal DC functions, see CoE setting in 1C32:08 and the result in 1C32:05.

If necessary, the SYNC0 signal can be shifted along the time axis to the right/later or left/earlier in associated dialogs by specifying a “User defined Shift Time”, see Fig. *Advanced Distributed Clock (DC) settings, EL51xx terminal*.

- A right-shift (positive shift value) will delay the counter value query, which means the position value becomes more current from the PLC perspective. However, this increases the risk that the position determination may not be finished in time before the arrival of EtherCAT frame, so that no current position value is available in this cycle.

- A left-shift (negative shift value) means the counter value will be queried earlier, resulting in older position values, with an associated increase in the safety buffer before the arrival of the EtherCAT datagram. This setting may be useful in systems with high real-time jitter, if no Industrial PCs from Beckhoff are used for control purposes, for example.

NOTICE

Attention! Risk of device damage!

The mentioned notes and information should be used advisedly. The EtherCAT master automatically allocates SYNC0 and SYNC1 settings that support reliable and timely process data acquisition. User intervention at this point may lead to undesired behavior. If these settings are changed in the System Manager, no plausibility checks are carried out on the software side. Correct function of the terminal with all conceivable setting options cannot be guaranteed.

Default setting

The cyclic read of the inputs is triggered by the SYNC0 pulse (interrupt) from the DC in the EL51xx. The EtherCAT master sets the Sync Unit Cycle time value to the PLC cycle time and therefore the EtherCAT cycle time as standard. See Fig. *Advanced Distributed Clock (DC) settings, EL51xx terminal: 4000µs = 4 ms*, as TwinCAT is in configuration mode.

EL51xx DC settings

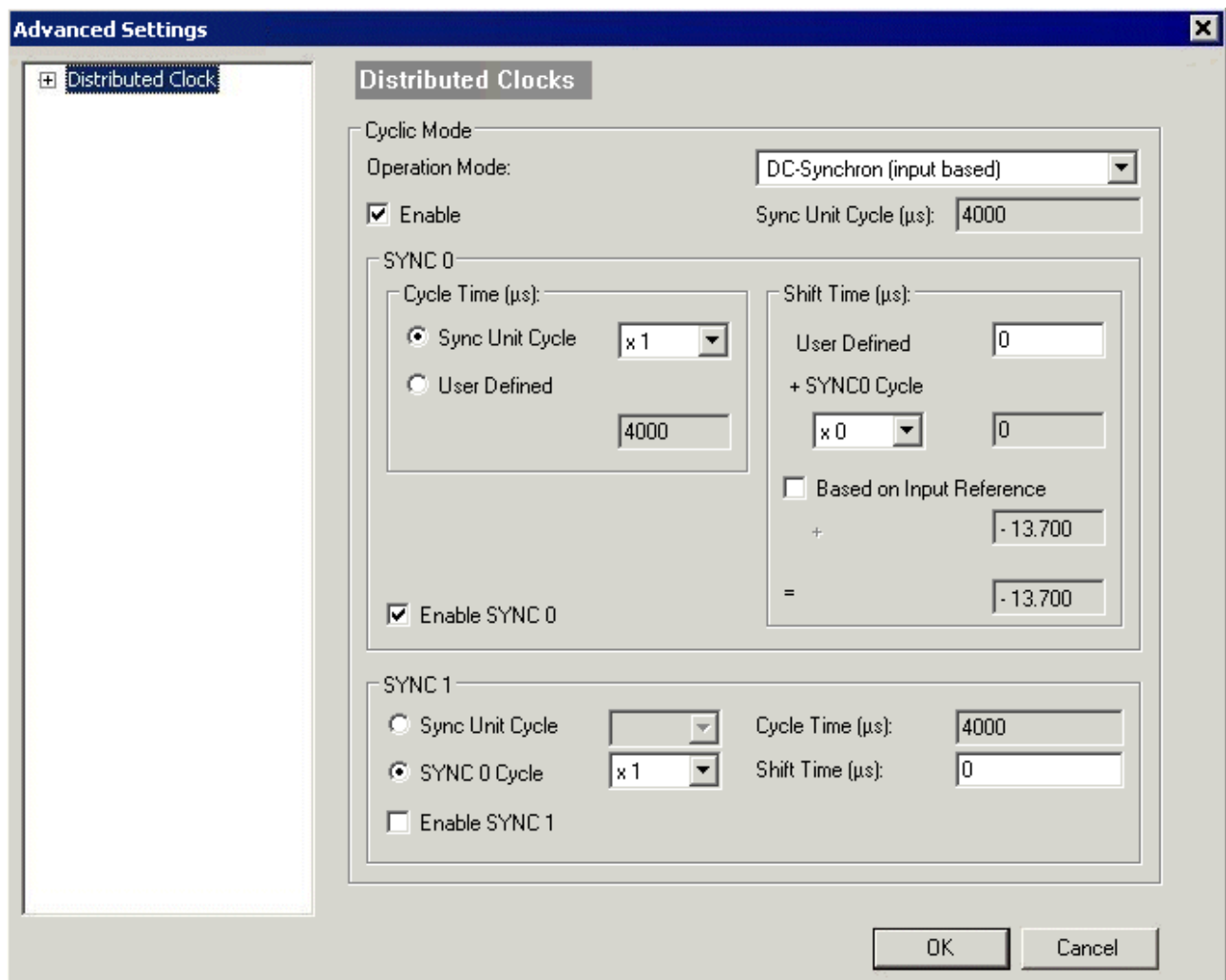

Fig. 19: Advanced Distributed Clock (DC) settings, EL51xx terminal

- **SYNC0**
Sync unit cycle: a multiple of the bus cycle time. The counter value is periodically determined at this interval (in µs).

- **User-defined**
Arbitrary number up to 2^{32} ns \approx 4.3 secs. Decimal point values are possible.
- **Shift Time**
The Shift Time can be used to shift the SYNC0 pulse for this EL51xx relative to other terminals and the global SYNC pulse in nanosecond steps. If the data of several EL51xx terminals are to be read simultaneously, the same value must be entered here.
- **Based on input reference**
If this option is activated an additional Input Shift is added to the configurable terminal-specific SYNC0 shift (user-defined). This value is calculated and made available by the EtherCAT master (SysMan/EtherCAT device/EtherCAT tab/Advanced Settings/Distributed Clocks/Input Shift Time/, see Fig. *EtherCAT Master, EtherCAT tab, Advanced Settings + EtherCAT Master, Advanced Settings, Distributed Clock*). In this way *all* input terminals in the system (EL1xxx, EL3xxx and appropriately set ELxxx such as the EL51xx) read their inputs as close as possible to the time of the EtherCAT frame that will fetch them, thereby supplying the most recent possible input data to the controller. In input-based mode this value is taken into account automatically.
- **Enable SYNC0**
Automatically activated in DC Synchronous operating mode.
- **SYNC1**
Additional SYNC pulse, derived from SYNC0 or from the DC itself. Not required by the EL51xx.

DC settings for EtherCAT master

Higher-level distributed clock parameters can be modified under advanced settings for the EtherCAT master. Refer also to the basic introduction to the topic of EtherCAT and Distributed Clocks; download: the [“Distributed clocks system description”](#).

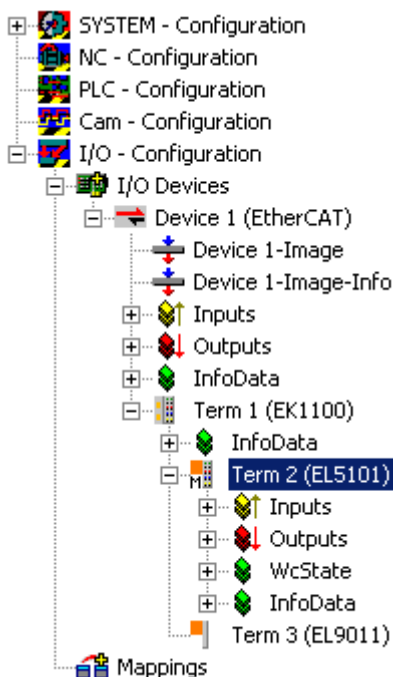

Fig. 20: EtherCAT Master, EtherCAT tab, Advanced Settings

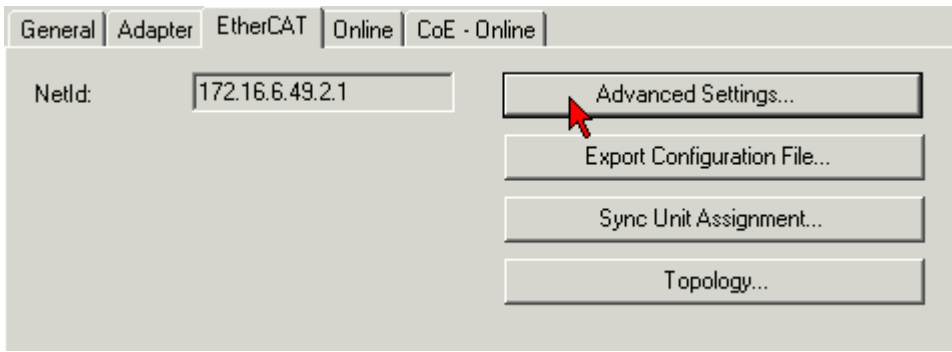

Fig. 21: EtherCAT Master, EtherCAT tab, Advanced Settings

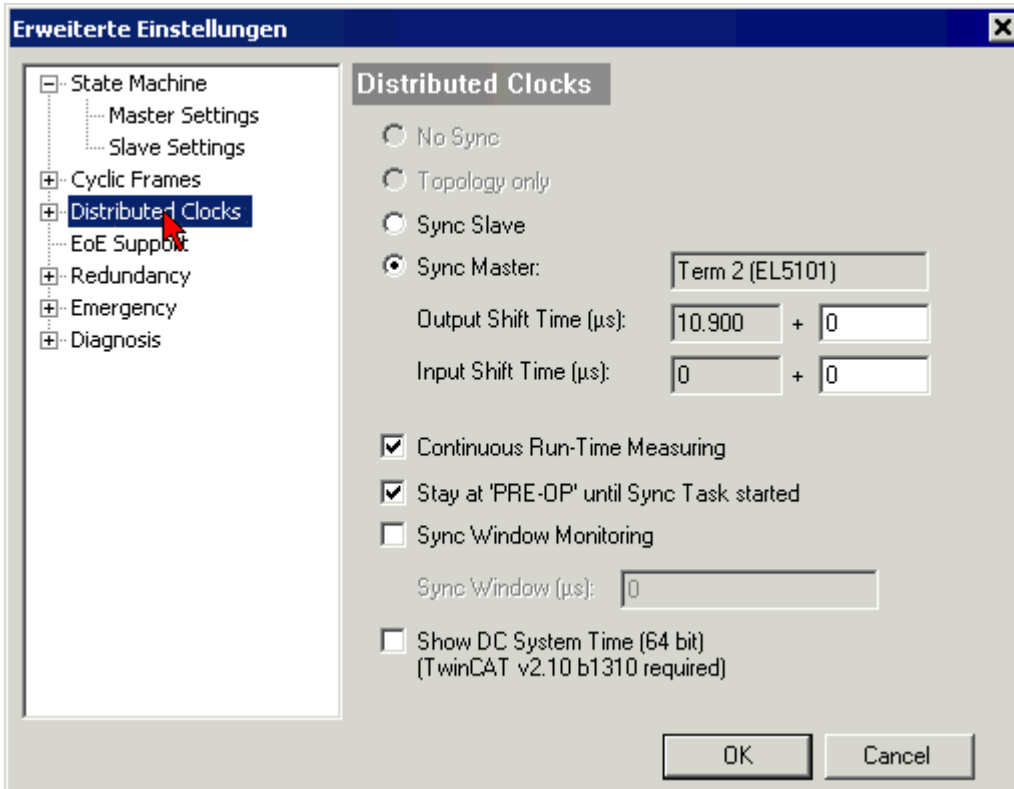

Fig. 22: EtherCAT Master, Advanced Settings, Distributed Clock

12 Mounting and wiring

12.1 Instructions for ESD protection

NOTICE

Destruction of the devices by electrostatic discharge possible!

The devices contain components at risk from electrostatic discharge caused by improper handling.

- Please ensure you are electrostatically discharged and avoid touching the contacts of the device directly.
- Avoid contact with highly insulating materials (synthetic fibers, plastic film etc.).
- Surroundings (working place, packaging and personnel) should be grounded probably, when handling with the devices.
- Each assembly must be terminated at the right hand end with an [EL9011](#) or [EL9012](#) bus end cap, to ensure the protection class and ESD protection.

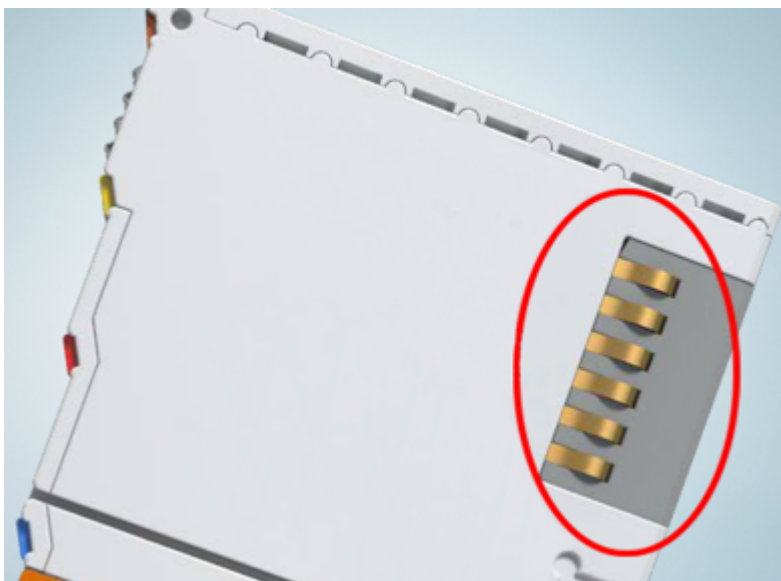

Fig. 23: Spring contacts of the Beckhoff I/O components

12.2 Installation on mounting rails

⚠ WARNING

Risk of electric shock and damage of device!

Bring the bus terminal system into a safe, powered down state before starting installation, disassembly or wiring of the bus terminals!

The Bus Terminal system and is designed for mounting in a control cabinet or terminal box.

Assembly

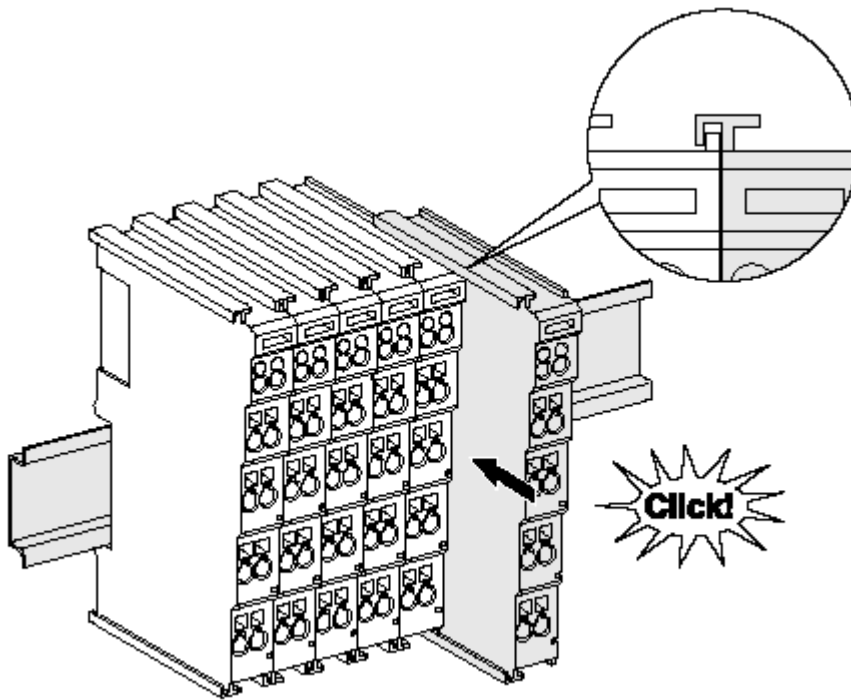

Fig. 24: Attaching on mounting rail

The bus coupler and bus terminals are attached to commercially available 35 mm mounting rails (DIN rails according to EN 60715) by applying slight pressure:

1. First attach the fieldbus coupler to the mounting rail.
2. The bus terminals are now attached on the right-hand side of the fieldbus coupler. Join the components with tongue and groove and push the terminals against the mounting rail, until the lock clicks onto the mounting rail.

If the terminals are clipped onto the mounting rail first and then pushed together without tongue and groove, the connection will not be operational! When correctly assembled, no significant gap should be visible between the housings.

i Fixing of mounting rails

The locking mechanism of the terminals and couplers extends to the profile of the mounting rail. At the installation, the locking mechanism of the components must not come into conflict with the fixing bolts of the mounting rail. To mount the mounting rails with a height of 7.5 mm under the terminals and couplers, you should use flat mounting connections (e.g. countersunk screws or blind rivets).

Disassembly

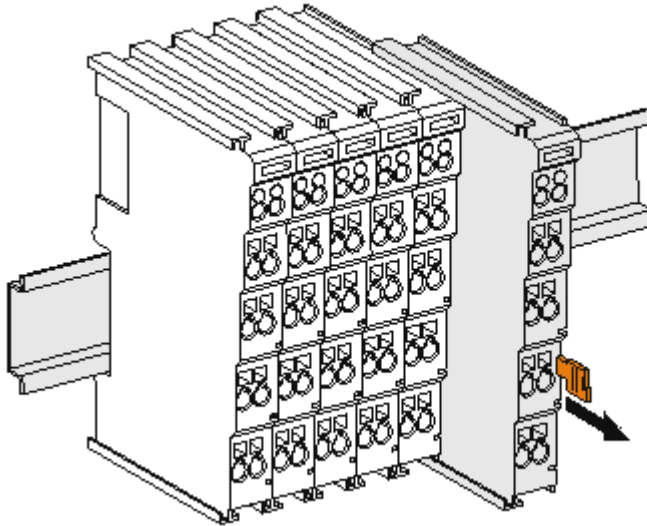

Fig. 25: Disassembling of terminal

Each terminal is secured by a lock on the mounting rail, which must be released for disassembly:

1. Pull the terminal by its orange-colored lugs approximately 1 cm away from the mounting rail. In doing so for this terminal the mounting rail lock is released automatically and you can pull the terminal out of the bus terminal block easily without excessive force.
2. Grasp the released terminal with thumb and index finger simultaneous at the upper and lower grooved housing surfaces and pull the terminal out of the bus terminal block.

Connections within a bus terminal block

The electric connections between the Bus Coupler and the Bus Terminals are automatically realized by joining the components:

- The six spring contacts of the K-Bus/E-Bus deal with the transfer of the data and the supply of the Bus Terminal electronics.
- The power contacts deal with the supply for the field electronics and thus represent a supply rail within the bus terminal block. The power contacts are supplied via terminals on the Bus Coupler (up to 24 V) or for higher voltages via power feed terminals.

● Power Contacts

i During the design of a bus terminal block, the pin assignment of the individual Bus Terminals must be taken account of, since some types (e.g. analog Bus Terminals or digital 4-channel Bus Terminals) do not or not fully loop through the power contacts. Power Feed Terminals (KL91xx, KL92xx or EL91xx, EL92xx) interrupt the power contacts and thus represent the start of a new supply rail.

PE power contact

The power contact labeled PE can be used as a protective earth. For safety reasons this contact mates first when plugging together, and can ground short-circuit currents of up to 125 A.

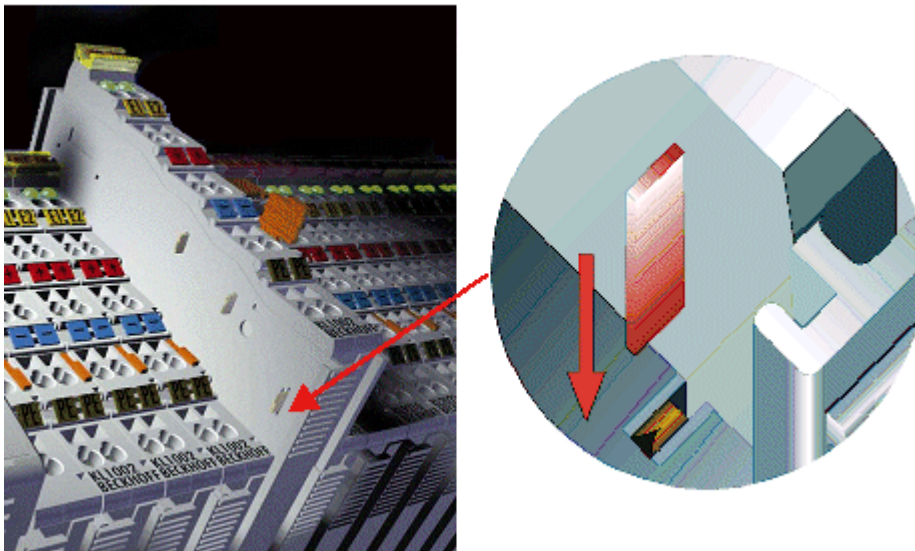

Fig. 26: Power contact on left side

NOTICE

Possible damage of the device

Note that, for reasons of electromagnetic compatibility, the PE contacts are capacitatively coupled to the mounting rail. This may lead to incorrect results during insulation testing or to damage on the terminal (e.g. disruptive discharge to the PE line during insulation testing of a consumer with a nominal voltage of 230 V). For insulation testing, disconnect the PE supply line at the Bus Coupler or the Power Feed Terminal! In order to decouple further feed points for testing, these Power Feed Terminals can be released and pulled at least 10 mm from the group of terminals.

⚠ WARNING

Risk of electric shock!

The PE power contact must not be used for other potentials!

12.3 Usage in potentially explosive areas (ATEX)

12.3.1 ATEX - Special conditions (extended temperature range)

⚠ WARNING

Observe the special conditions for the intended use of Beckhoff fieldbus components with extended temperature range (ET) in potentially explosive areas (directive 2014/34/EU)!

- The certified components are to be installed in a suitable housing that guarantees a protection class of at least IP54 in accordance with EN 60079-15! The environmental conditions during use are thereby to be taken into account!
- For dust (only the fieldbus components of certificate no. KEMA 10ATEX0075 X Issue 9): The equipment shall be installed in a suitable enclosure providing a degree of protection of IP54 according to EN 60079-31 for group IIIA or IIIB and IP6X for group IIIC, taking into account the environmental conditions under which the equipment is used!
- If the temperatures during rated operation are higher than 70°C at the feed-in points of cables, lines or pipes, or higher than 80°C at the wire branching points, then cables must be selected whose temperature data correspond to the actual measured temperature values!
- Observe the permissible ambient temperature range of -25 to 60°C for the use of Beckhoff fieldbus components with extended temperature range (ET) in potentially explosive areas!
- Measures must be taken to protect against the rated operating voltage being exceeded by more than 40% due to short-term interference voltages!
- The individual terminals may only be unplugged or removed from the Bus Terminal system if the supply voltage has been switched off or if a non-explosive atmosphere is ensured!
- The connections of the certified components may only be connected or disconnected if the supply voltage has been switched off or if a non-explosive atmosphere is ensured!
- The fuses of the KL92xx/EL92xx power feed terminals may only be exchanged if the supply voltage has been switched off or if a non-explosive atmosphere is ensured!
- Address selectors and ID switches may only be adjusted if the supply voltage has been switched off or if a non-explosive atmosphere is ensured!

Standards

The fundamental health and safety requirements are fulfilled by compliance with the following standards:

- EN 60079-0:2012+A11:2013
- EN 60079-15:2010
- EN 60079-31:2013 (only for certificate no. KEMA 10ATEX0075 X Issue 9)

Marking

The Beckhoff fieldbus components with extended temperature range (ET) certified according to the ATEX directive for potentially explosive areas bear the following marking:



II 3G KEMA 10ATEX0075 X Ex nA IIC T4 Gc Ta: -25 ... +60°C

II 3D KEMA 10ATEX0075 X Ex tc IIIC T135°C Dc Ta: -25 ... +60°C
(only for fieldbus components of certificate no. KEMA 10ATEX0075 X Issue 9)

or



II 3G KEMA 10ATEX0075 X Ex nA nC IIC T4 Gc Ta: -25 ... +60°C

II 3D KEMA 10ATEX0075 X Ex tc IIIC T135°C Dc Ta: -25 ... +60°C
(only for fieldbus components of certificate no. KEMA 10ATEX0075 X Issue 9)

12.3.2 IECEx - Special conditions

⚠ WARNING

Observe the special conditions for the intended use of Beckhoff fieldbus components in potentially explosive areas!

- For gas: The equipment shall be installed in a suitable enclosure providing a degree of protection of IP54 according to IEC 60079-15, taking into account the environmental conditions under which the equipment is used!
- For dust (only the fieldbus components of certificate no. IECEx DEK 16.0078X Issue 3): The equipment shall be installed in a suitable enclosure providing a degree of protection of IP54 according to EN 60079-31 for group IIIA or IIIB and IP6X for group IIIC, taking into account the environmental conditions under which the equipment is used!
- The equipment shall only be used in an area of at least pollution degree 2, as defined in IEC 60664-1!
- Provisions shall be made to prevent the rated voltage from being exceeded by transient disturbances of more than 119 V!
- If the temperatures during rated operation are higher than 70°C at the feed-in points of cables, lines or pipes, or higher than 80°C at the wire branching points, then cables must be selected whose temperature data correspond to the actual measured temperature values!
- Observe the permissible ambient temperature range for the use of Beckhoff fieldbus components in potentially explosive areas!
- The individual terminals may only be unplugged or removed from the Bus Terminal system if the supply voltage has been switched off or if a non-explosive atmosphere is ensured!
- The connections of the certified components may only be connected or disconnected if the supply voltage has been switched off or if a non-explosive atmosphere is ensured!
- Address selectors and ID switches may only be adjusted if the supply voltage has been switched off or if a non-explosive atmosphere is ensured!
- The front hatch of certified units may only be opened if the supply voltage has been switched off or a non-explosive atmosphere is ensured!

Standards

The fundamental health and safety requirements are fulfilled by compliance with the following standards:

- EN 60079-0:2011
- EN 60079-15:2010
- EN 60079-31:2013 (only for certificate no. IECEx DEK 16.0078X Issue 3)

Marking

Beckhoff fieldbus components that are certified in accordance with IECEx for use in areas subject to an explosion hazard bear the following markings:

Marking for fieldbus components of certificate no. IECEx DEK 16.0078X Issue 3:	IECEx DEK 16.0078 X Ex nA IIC T4 Gc Ex tc IIIC T135°C Dc
--	---

Marking for fieldbus components of certificates with later issues:	IECEx DEK 16.0078 X Ex nA IIC T4 Gc
--	--

12.3.3 Continulative documentation for ATEX and IECEx

NOTICE



Continulative documentation about explosion protection according to ATEX and IECEx



Pay also attention to the continuative documentation

Ex. Protection for Terminal Systems

Notes on the use of the Beckhoff terminal systems in hazardous areas according to ATEX and IECEx,

that is available for [download](#) within the download area of your product on the Beckhoff homepage www.beckhoff.com!

12.4 UL notice

⚠ CAUTION	
	<p>Application Beckhoff EtherCAT modules are intended for use with Beckhoff's UL Listed EtherCAT System only.</p>
⚠ CAUTION	
	<p>Examination For cULus examination, the Beckhoff I/O System has only been investigated for risk of fire and electrical shock (in accordance with UL508 and CSA C22.2 No. 142).</p>
⚠ CAUTION	
	<p>For devices with Ethernet connectors Not for connection to telecommunication circuits.</p>

Basic principles

UL certification according to UL508. Devices with this kind of certification are marked by this sign:



12.5 Installation instructions for enhanced mechanical load capacity

⚠ WARNING

Risk of injury through electric shock and damage to the device!

Bring the Bus Terminal system into a safe, de-energized state before starting mounting, disassembly or wiring of the Bus Terminals!

Additional checks

The terminals have undergone the following additional tests:

Verification	Explanation
Vibration	10 frequency runs in 3 axes
	6 Hz < f < 60 Hz displacement 0.35 mm, constant amplitude
	60.1 Hz < f < 500 Hz acceleration 5 g, constant amplitude
Shocks	1000 shocks in each direction, in 3 axes
	25 g, 6 ms

Additional installation instructions

For terminals with enhanced mechanical load capacity, the following additional installation instructions apply:

- The enhanced mechanical load capacity is valid for all permissible installation positions
- Use a mounting rail according to EN 60715 TH35-15
- Fix the terminal segment on both sides of the mounting rail with a mechanical fixture, e.g. an earth terminal or reinforced end clamp
- The maximum total extension of the terminal segment (without coupler) is: 64 terminals (12 mm mounting with) or 32 terminals (24 mm mounting with)
- Avoid deformation, twisting, crushing and bending of the mounting rail during edging and installation of the rail
- The mounting points of the mounting rail must be set at 5 cm intervals
- Use countersunk head screws to fasten the mounting rail
- The free length between the strain relief and the wire connection should be kept as short as possible. A distance of approx. 10 cm should be maintained to the cable duct.

12.6 Connection

12.6.1 Connection system

⚠ WARNING

Risk of electric shock and damage of device!

Bring the bus terminal system into a safe, powered down state before starting installation, disassembly or wiring of the bus terminals!

Overview

The bus terminal system offers different connection options for optimum adaptation to the respective application:

- The terminals of ELxxxx and KLxxxx series with standard wiring include electronics and connection level in a single enclosure.
- The terminals of ESxxxx and KSxxxx series feature a pluggable connection level and enable steady wiring while replacing.

- The High Density Terminals (HD Terminals) include electronics and connection level in a single enclosure and have advanced packaging density.

Standard wiring (ELxxxx / KLxxxx)

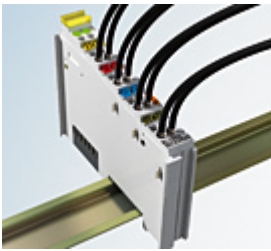

Fig. 27: Standard wiring

The terminals of ELxxxx and KLxxxx series have been tried and tested for years. They feature integrated screwless spring force technology for fast and simple assembly.

Pluggable wiring (ESxxxx / KSxxxx)

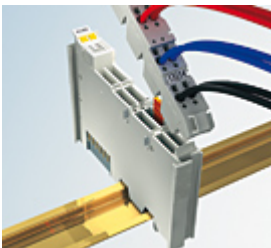

Fig. 28: Pluggable wiring

The terminals of ESxxxx and KSxxxx series feature a pluggable connection level. The assembly and wiring procedure is the same as for the ELxxxx and KLxxxx series. The pluggable connection level enables the complete wiring to be removed as a plug connector from the top of the housing for servicing. The lower section can be removed from the terminal block by pulling the unlocking tab. Insert the new component and plug in the connector with the wiring. This reduces the installation time and eliminates the risk of wires being mixed up.

The familiar dimensions of the terminal only had to be changed slightly. The new connector adds about 3 mm. The maximum height of the terminal remains unchanged.

A tab for strain relief of the cable simplifies assembly in many applications and prevents tangling of individual connection wires when the connector is removed.

Conductor cross sections between 0.08 mm² and 2.5 mm² can continue to be used with the proven spring force technology.

The overview and nomenclature of the product names for ESxxxx and KSxxxx series has been retained as known from ELxxxx and KLxxxx series.

High Density Terminals (HD Terminals)



Fig. 29: High Density Terminals

The terminals from these series with 16 terminal points are distinguished by a particularly compact design, as the packaging density is twice as large as that of the standard 12 mm bus terminals. Massive conductors and conductors with a wire end sleeve can be inserted directly into the spring loaded terminal point without tools.

● **Wiring HD Terminals**

i The High Density Terminals of the ELx8xx and KLx8xx series doesn't support pluggable wiring.

Ultrasonically “bonded” (ultrasonically welded) conductors

● **Ultrasonically “bonded” conductors**

i It is also possible to connect the Standard and High Density Terminals with ultrasonically “bonded” (ultrasonically welded) conductors. In this case, please note the tables concerning the wire-size width [▶ 65]!

12.6.2 Wiring

⚠ WARNING

Risk of electric shock and damage of device!

Bring the bus terminal system into a safe, powered down state before starting installation, disassembly or wiring of the bus terminals!

Terminals for standard wiring ELxxxx/KLxxxx and for pluggable wiring ESxxxx/KSxxxx

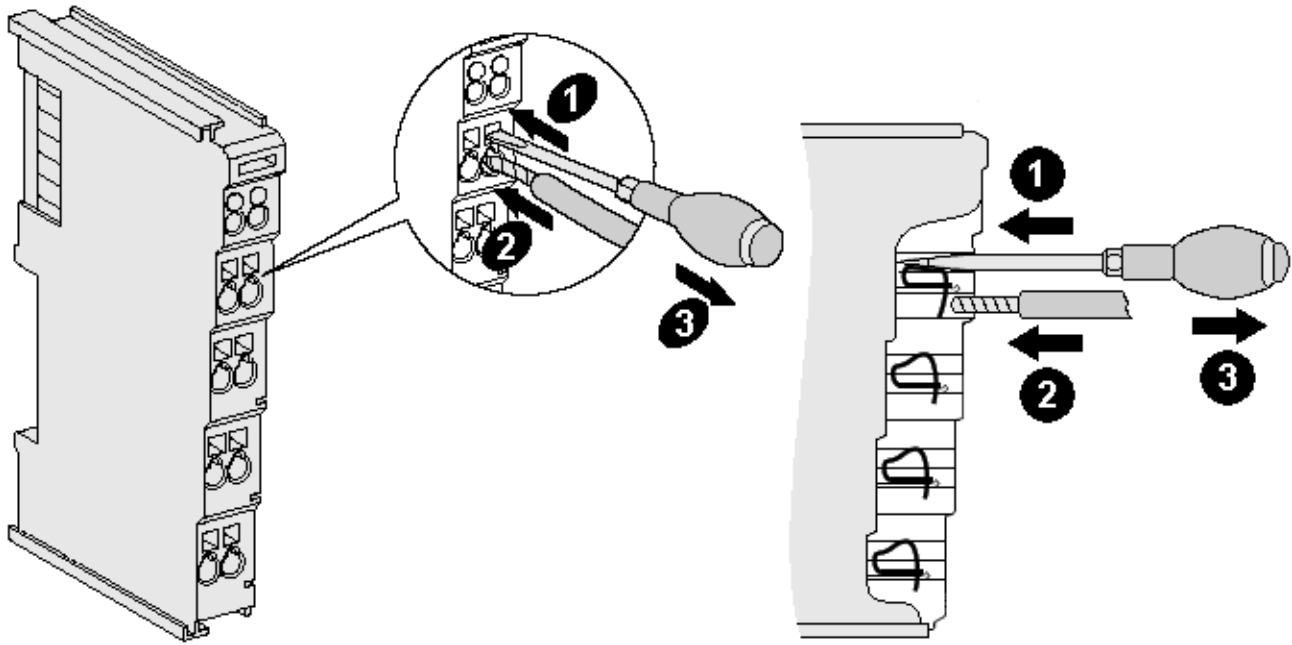

Fig. 30: Connecting a cable on a terminal point

Up to eight terminal points enable the connection of solid or finely stranded cables to the bus terminal. The terminal points are implemented in spring force technology. Connect the cables as follows:

1. Open a terminal point by pushing a screwdriver straight against the stop into the square opening above the terminal point. Do not turn the screwdriver or move it alternately (don't toggle).
2. The wire can now be inserted into the round terminal opening without any force.
3. The terminal point closes automatically when the pressure is released, holding the wire securely and permanently.

See the following table for the suitable wire size width.

Terminal housing	ELxxxx, KLxxxx	ESxxxx, KSxxxx
Wire size width (single core wires)	0.08 ... 2.5 mm ²	0.08 ... 2.5 mm ²
Wire size width (fine-wire conductors)	0.08 ... 2.5 mm ²	0.08 ... 2.5 mm ²
Wire size width (conductors with a wire end sleeve)	0.14 ... 1.5 mm ²	0.14 ... 1.5 mm ²
Wire stripping length	8 ... 9 mm	9 ... 10 mm

High Density Terminals ([HD Terminals](#) [▶ 63]) with 16 terminal points

The conductors of the HD Terminals are connected without tools for single-wire conductors using the direct plug-in technique, i.e. after stripping the wire is simply plugged into the terminal point. The cables are released, as usual, using the contact release with the aid of a screwdriver. See the following table for the suitable wire size width.

Terminal housing	High Density Housing
Wire size width (single core wires)	0.08 ... 1.5 mm ²
Wire size width (fine-wire conductors)	0.25 ... 1.5 mm ²
Wire size width (conductors with a wire end sleeve)	0.14 ... 0.75 mm ²
Wire size width (ultrasonically "bonded" conductors)	only 1.5 mm ² (see notice [▶ 64])
Wire stripping length	8 ... 9 mm

12.6.3 Shielding

● Shielding



Encoder, analog sensors and actuators should always be connected with shielded, twisted paired wires.

12.7 Note - Power supply

⚠ WARNING

Power supply from SELV/PELV power supply unit!

SELV/PELV circuits (Safety Extra Low Voltage, Protective Extra Low Voltage) according to IEC 61010-2-201 must be used to supply this device.

Notes:

- SELV/PELV circuits may give rise to further requirements from standards such as IEC 60204-1 et al, for example with regard to cable spacing and insulation.
- A SELV (Safety Extra Low Voltage) supply provides safe electrical isolation and limitation of the voltage without a connection to the protective conductor, a PELV (Protective Extra Low Voltage) supply also requires a safe connection to the protective conductor.

12.8 Installation positions

NOTICE

Constraints regarding installation position and operating temperature range

Please refer to the technical data for a terminal to ascertain whether any restrictions regarding the installation position and/or the operating temperature range have been specified. When installing high power dissipation terminals ensure that an adequate spacing is maintained between other components above and below the terminal in order to guarantee adequate ventilation!

Optimum installation position (standard)

The optimum installation position requires the mounting rail to be installed horizontally and the connection surfaces of the EL/KL terminals to face forward (see Fig. *Recommended distances for standard installation position*). The terminals are ventilated from below, which enables optimum cooling of the electronics through convection. "From below" is relative to the acceleration of gravity.

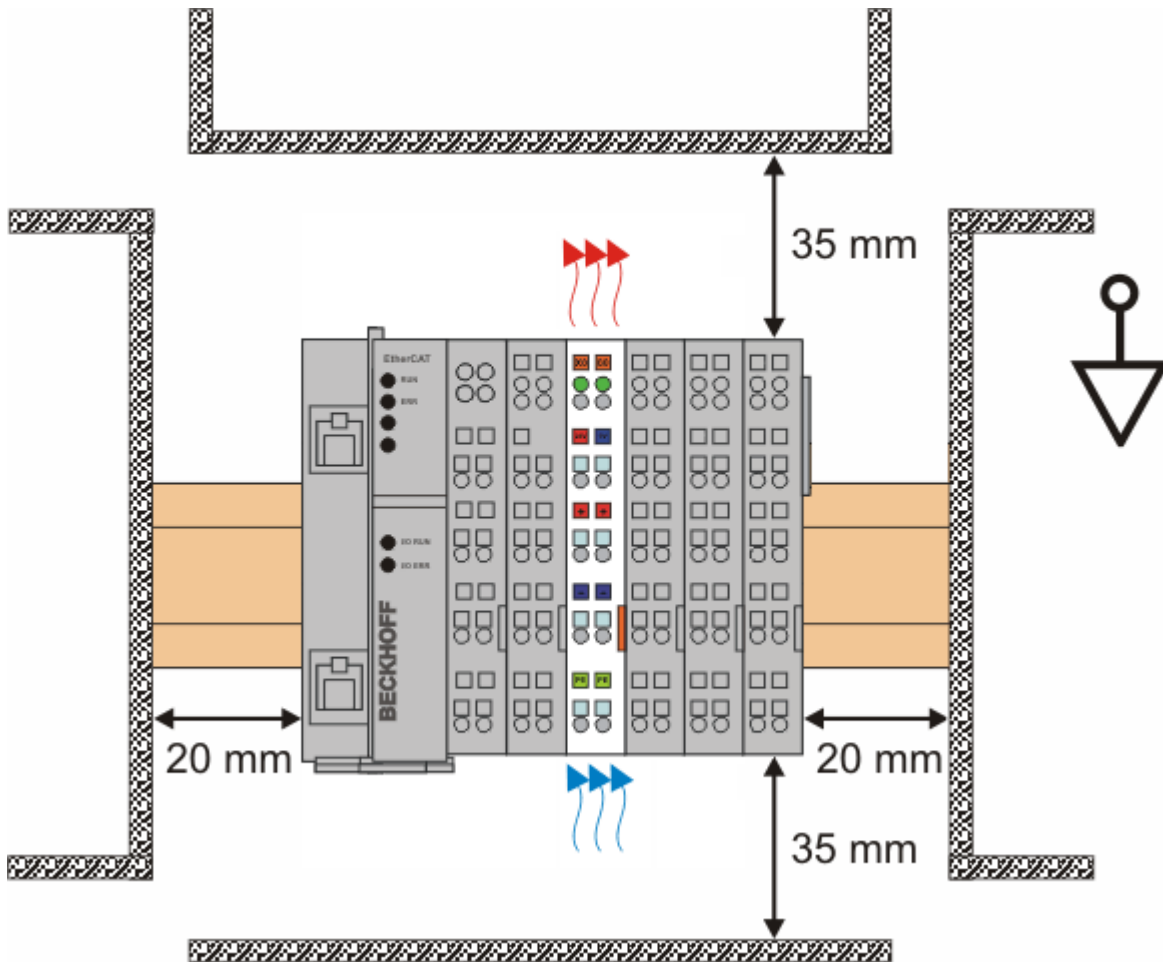

Fig. 31: Recommended distances for standard installation position

Compliance with the distances shown in Fig. *Recommended distances for standard installation position* is recommended.

Other installation positions

All other installation positions are characterized by different spatial arrangement of the mounting rail - see Fig *Other installation positions*.

The minimum distances to ambient specified above also apply to these installation positions.

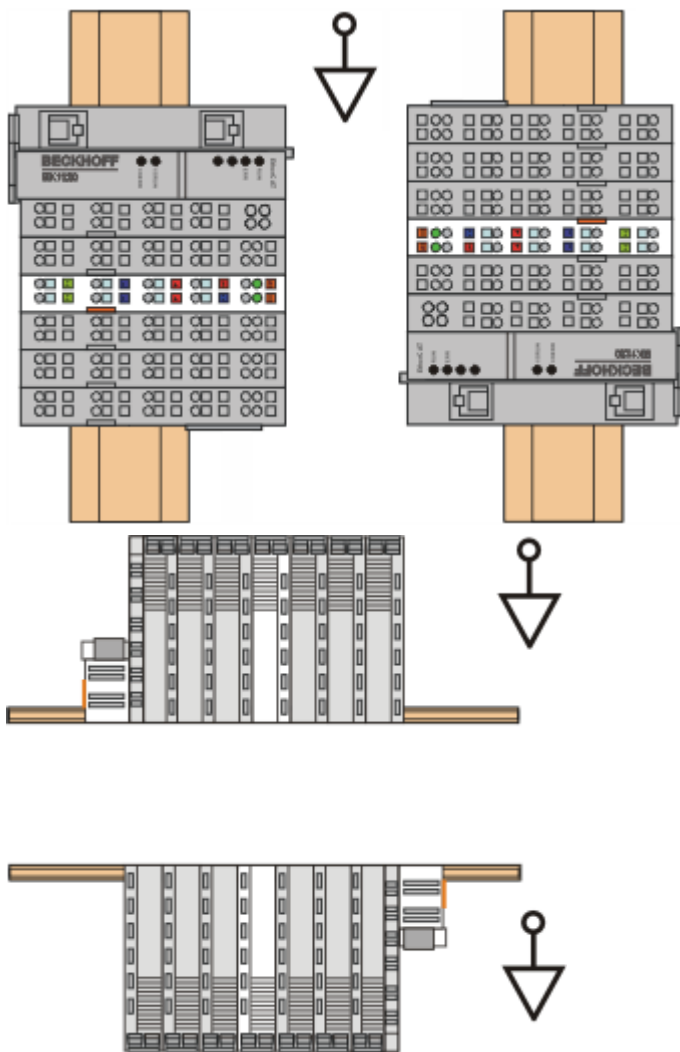

Fig. 32: Other installation positions

12.9 Positioning of passive Terminals

i **Hint for positioning of passive terminals in the bus terminal block**

EtherCAT Terminals (ELxxxx / ESxxxx), which do not take an active part in data transfer within the bus terminal block are so called passive terminals. The passive terminals have no current consumption out of the E-Bus.

To ensure an optimal data transfer, you must not directly string together more than two passive terminals!

Examples for positioning of passive terminals (highlighted)

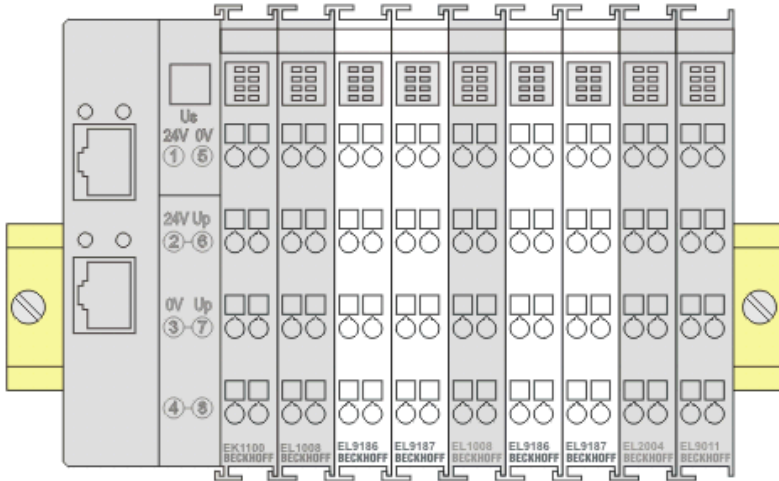

Fig. 33: Correct positioning

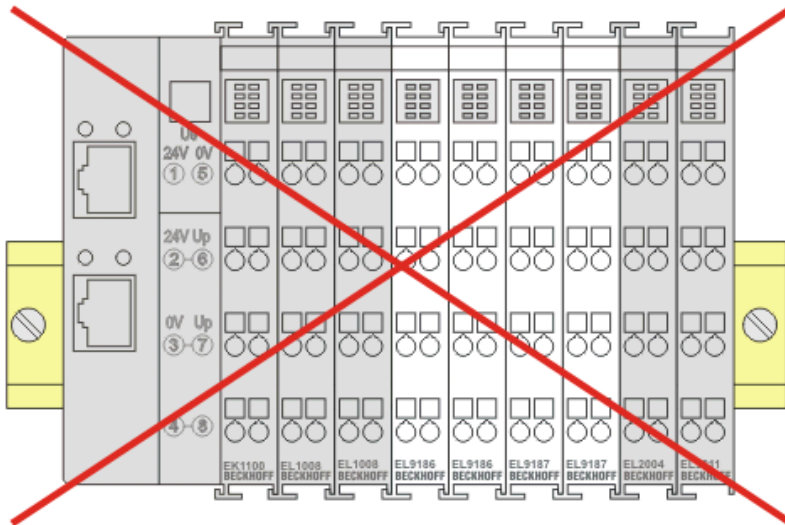

Fig. 34: Incorrect positioning

12.10 EL5101-00x0 - LEDs and Connection

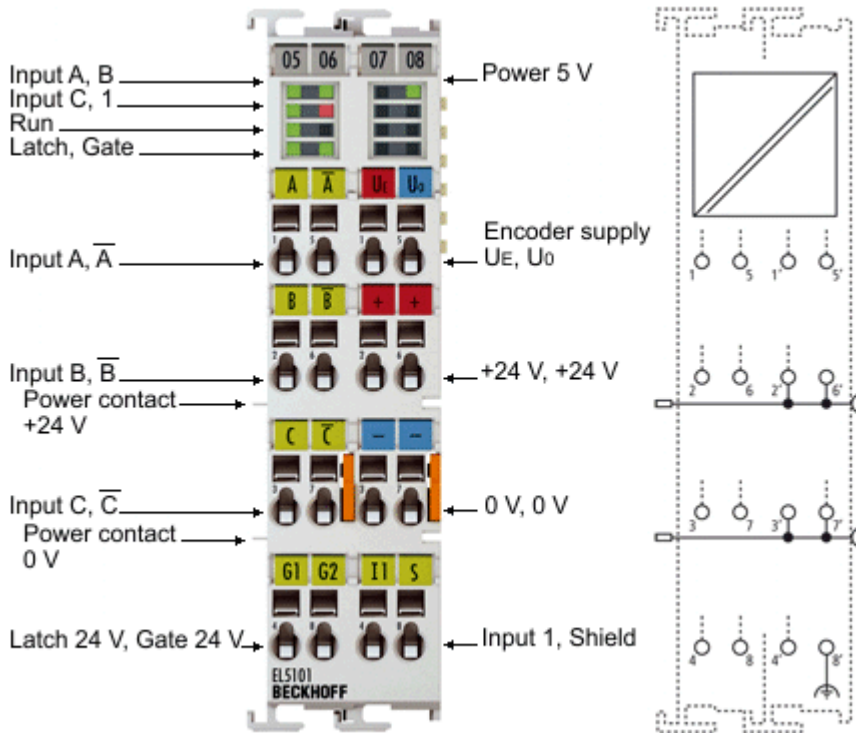

Fig. 35: EL5101

NOTICE

Encoder supply via the terminal

The encoder supply voltage, can be taken from the terminal points 1'(5 V) and 5'(0 V).

NOTICE

Single-ended connection for TTL encoder

For information on the single-ended connection for TTL encoders, please refer to chapter "Single-Ended Connection for TTL Encoders ("Normal Operating Mode [▶ 161]" or "Enhanced Operating Mode [▶ 190]").

- No Single-ended connection is possible for the terminals EL5101-0010 and EL5101-0011.

Connection		
Terminal point	No.	Comment
A	1	Encoder input A
B	2	Encoder input B
C	3	Encoder input C
Latch 24 V	4	Latch input
¬A	5	Encoder input A
¬B	6	Encoder input B
¬C	7	Encoder input C
Gate 24 V	8	Gate input
U _e = +5 V	1'	+5 V encoder supply
+24 V	2'	+24 V (internally connected to terminal point 6' and positive power contact)
0 V	3'	0 V (internally connected to terminal point 7' and negative power contact)
Input 1	4'	Status input 1 Alarm input from rotary encoder. Internally connected to 5 V via pull-up. Switching to negative potential, i.e. connection to GND leads to error bit and LED display. If externally supplied (not recommended) 5 V max. against GND is permitted.
U ₀ = 0 V	5'	0 V encoder supply
+24 V	6'	+24 V (internally connected to terminal point 2' and positive power contact)
0 V	7'	0 V (internally connected to terminal point 3' and negative power contact)
Shield	8'	Screen

LEDs

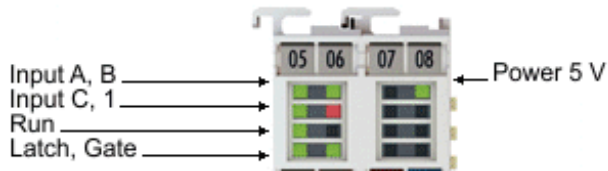

Fig. 36: EL5101-00x0 - LEDs

LED	Color	Meaning	
INPUT A, B, C	green	indicates TRUE level	
INPUT 1	red	is lit, if INPUT 1 is connected to GND [INPUT 1 is connected to an internal 5 V HIGH level though internal pull-up (default)]	
LATCH	green	is lit, if a signal (+24 V) is connected to the latch input	
GATE	green	is lit, if a signal (+24 V) is connected to the gate input	
RUN	green	This LED indicates the terminal's operating state:	
		off	State of the EtherCAT State Machine [► 44] : INIT = initialization of the terminal or BOOTSTRAP = function for firmware updates [► 261] of the terminal
		flashing	State of the EtherCAT State Machine: PREOP = function for mailbox communication and different standard-settings set
		single flash	State of the EtherCAT State Machine: SAFEOP = verification of the Sync Manager [► 125] channels and the distributed clocks. Outputs remain in safe state
on	State of the EtherCAT State Machine: OP = normal operating state; mailbox and process data communication is possible		
POWER 5 V	green	Operating voltage display for incremental encoder power supply	

12.11 EL5101-0011 - LEDs and Connection

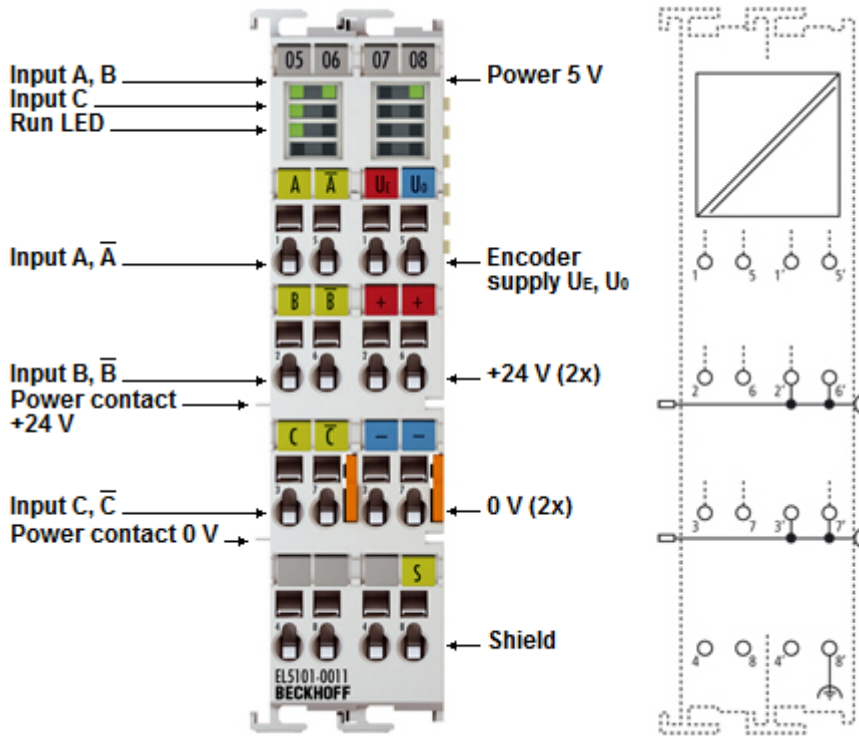

Fig. 37: EL5101-0011

NOTICE

Encoder supply via the terminal

The encoder supply voltage, can be taken from the terminal points 1' (5 V) and 5' (0 V).

NOTICE

Single-ended connection for TTL encoder

For information on the single-ended connection for TTL encoders, please refer to chapter "Single-Ended Connection for TTL Encoders ("Normal Operating Mode [[▶ 161](#)]" or "Enhanced Operating Mode [[▶ 190](#)]").

- No Single-ended connection is possible for the terminals EL5101-0010 and EL5101-0011.

Connection		
Terminal point	No.	Comment
A	1	Encoder input A
B	2	Encoder input B
C	3	Encoder input C
-	4	-
\neg A	5	Encoder input A
\neg B	6	Encoder input B
\neg C	7	Encoder input C
-	8	-
$U_E = +5\text{ V}$	1'	+5 V encoder supply
+24 V	2'	+24 V (internally connected to terminal point 6' and positive power contact)
0 V	3'	0 V (internally connected to terminal point 7' and negative power contact)
-	4'	-
$U_0 = 0\text{ V}$	5'	0 V encoder supply
+24 V	6'	+24 V (internally connected to terminal point 2' and positive power contact)
0 V	7'	0 V (internally connected to terminal point 3' and negative power contact)
Shield	8'	Shield

LEDs

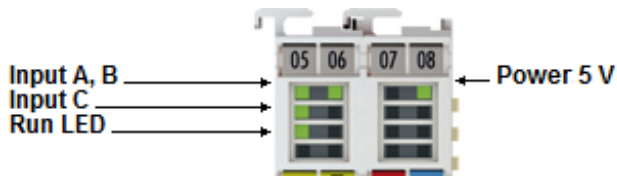

Fig. 38: EL5101-0011 - LEDs

LED	Color	Meaning	
INPUT A, B, C	green	indicates TRUE level	
RUN	green	This LED indicates the terminal's operating state:	
		off	State of the EtherCAT State Machine [▶ 44] : INIT = initialization of the terminal or BOOTSTRAP = function for firmware updates [▶ 261] of the terminal
		flashing	State of the EtherCAT State Machine: PREOP = function for mailbox communication and different standard-settings set
		Single flash	State of the EtherCAT State Machine: SAFEOP = verification of the Sync Manager [▶ 125] channels and the distributed clocks. Outputs remain in safe state
on	State of the EtherCAT State Machine: OP = normal operating state; mailbox and process data communication is possible		
POWER 5 V	green	Operating voltage display for incremental encoder power supply	

12.12 Disposal



Products marked with a crossed-out wheeled bin shall not be discarded with the normal waste stream. The device is considered as waste electrical and electronic equipment. The national regulations for the disposal of waste electrical and electronic equipment must be observed.

13 Commissioning

13.1 TwinCAT Quick Start

TwinCAT is a development environment for real-time control including a multi PLC system, NC axis control, programming and operation. The whole system is mapped through this environment and enables access to a programming environment (including compilation) for the controller. Individual digital or analog inputs or outputs can also be read or written directly, in order to verify their functionality, for example.

For further information, please refer to <http://infosys.beckhoff.com>:

- **EtherCAT System Manual:**
Fieldbus Components → EtherCAT Terminals → EtherCAT System Documentation → Setup in the TwinCAT System Manager
- **TwinCAT 2** → TwinCAT System Manager → I/O Configuration
- In particular, for TwinCAT – driver installation:
Fieldbus components → Fieldbus Cards and Switches → FC900x – PCI Cards for Ethernet → Installation

Devices contain the relevant terminals for the actual configuration. All configuration data can be entered directly via editor functions (offline) or via the `scan function (online):

- **“offline”**: The configuration can be customized by adding and positioning individual components. These can be selected from a directory and configured.
 - The procedure for the offline mode can be found under <http://infosys.beckhoff.com>:
TwinCAT 2 → TwinCAT System Manager → IO Configuration → Add an I/O device
- **“online”**: The existing hardware configuration is read
 - See also <http://infosys.beckhoff.com>:
Fieldbus components → Fieldbus Cards and Switches → FC900x – PCI Cards for Ethernet → Installation → Searching for devices

The following relationship is envisaged between the user PC and individual control elements:

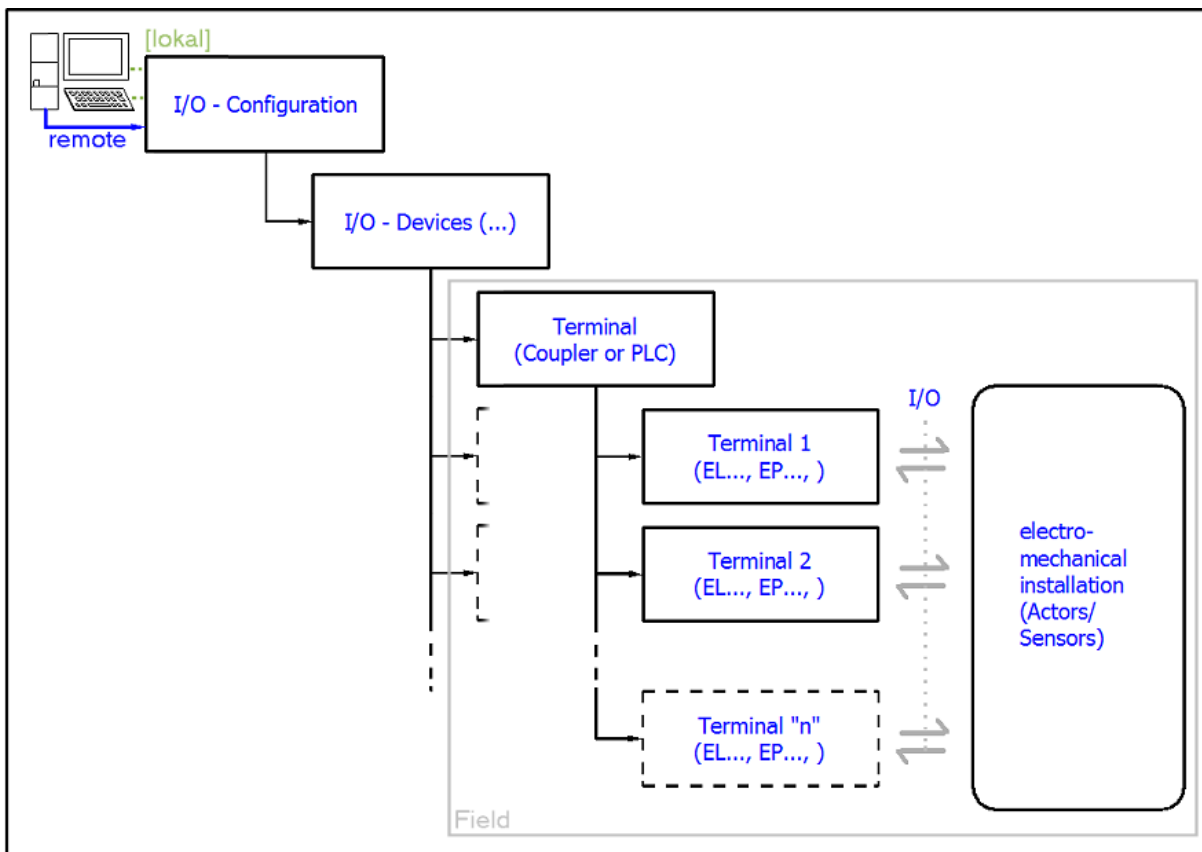

Fig. 39: Relationship between user side (commissioning) and installation

Insertion of certain components (I/O device, terminal, box...) by users functions the same way as in TwinCAT 2 and TwinCAT 3. The descriptions below relate solely to the online procedure.

Example configuration (actual configuration)

Based on the following example configuration, the subsequent subsections describe the procedure for TwinCAT 2 and TwinCAT 3:

- **CX2040** control system (PLC) including **CX2100-0004** power supply unit
- Connected to CX2040 on the right (E-bus):
EL1004 (4-channel digital input terminal 24 V_{DC})
- Linked via the X001 port (RJ-45): **EK1100** EtherCAT Coupler
- Connected to the EK1100 EtherCAT Coupler on the right (E-bus):
EL2008 (8-channel digital output terminal 24 V_{DC}; 0.5 A)
- (Optional via X000: a link to an external PC for the user interface)

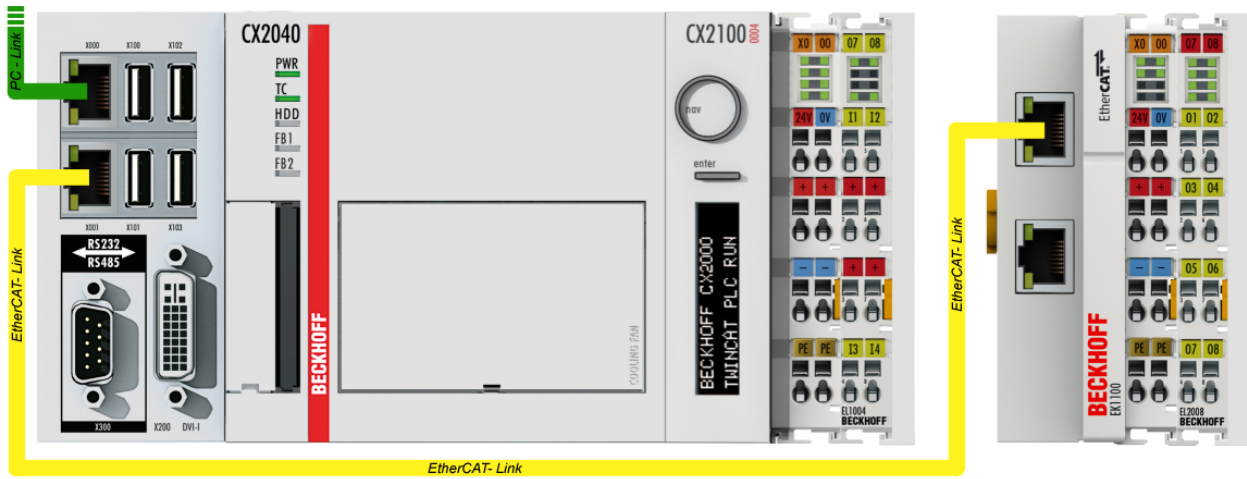

Fig. 40: Control configuration with Embedded PC, input (EL1004) and output (EL2008)

Note that all combinations of a configuration are possible; for example, the EL1004 terminal could also be connected after the coupler, or the EL2008 terminal could additionally be connected to the CX2040 on the right, in which case the EK1100 coupler wouldn't be necessary.

13.1.1 TwinCAT 2

Startup

TwinCAT 2 basically uses two user interfaces: the TwinCAT System Manager for communication with the electromechanical components and TwinCAT PLC Control for the development and compilation of a controller. The starting point is the TwinCAT System Manager.

After successful installation of the TwinCAT system on the PC to be used for development, the TwinCAT 2 System Manager displays the following user interface after startup:

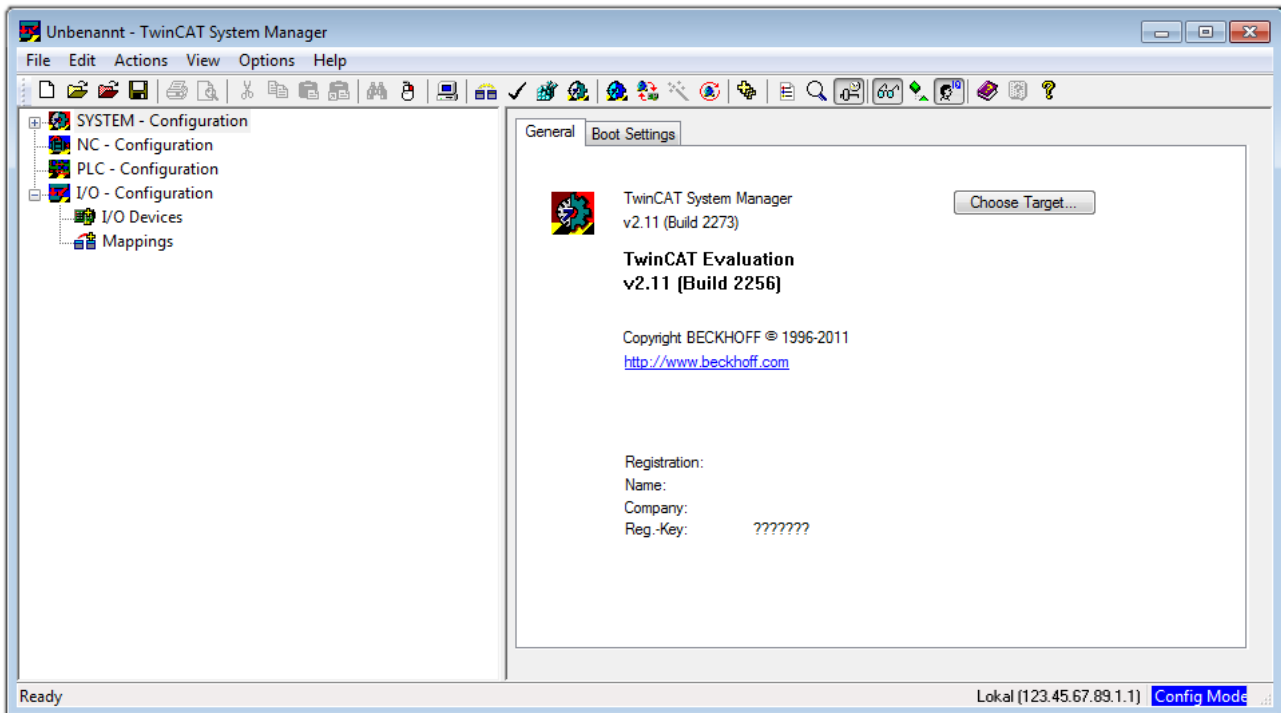



Fig. 41: Initial TwinCAT 2 user interface

Generally, TwinCAT can be used in local or remote mode. Once the TwinCAT system, including the user interface (standard) is installed on the respective PLC, TwinCAT can be used in local mode and thus the next step is “[Insert Device \[▶ 79\]](#)”.

If the intention is to address the TwinCAT runtime environment installed on a PLC remotely from another system used as a development environment, the target system must be made known first. In the menu under

“Actions” → “Choose Target System...”, the following window is opened for this via the symbol “” or the “F8” key:

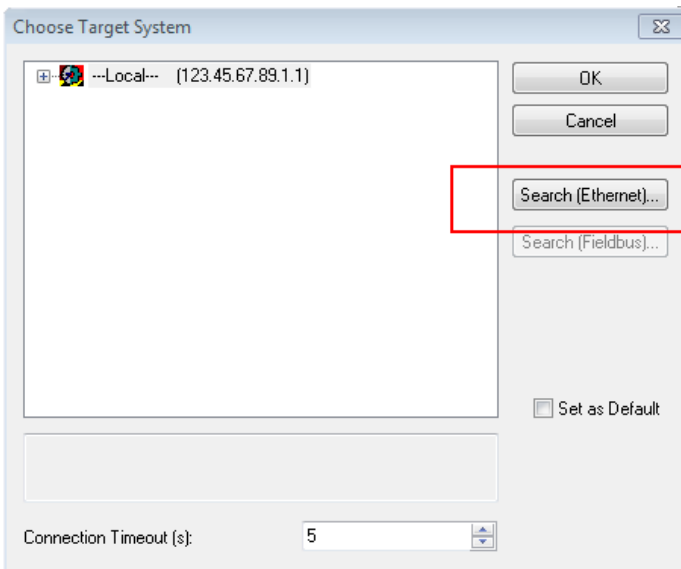

Fig. 42: Selection of the target system

Use “Search (Ethernet)...” to enter the target system. Thus another dialog opens to either:

- enter the known computer name after “Enter Host Name / IP:” (as shown in red)
- perform a “Broadcast Search” (if the exact computer name is not known)
- enter the known computer – IP or AmsNetID

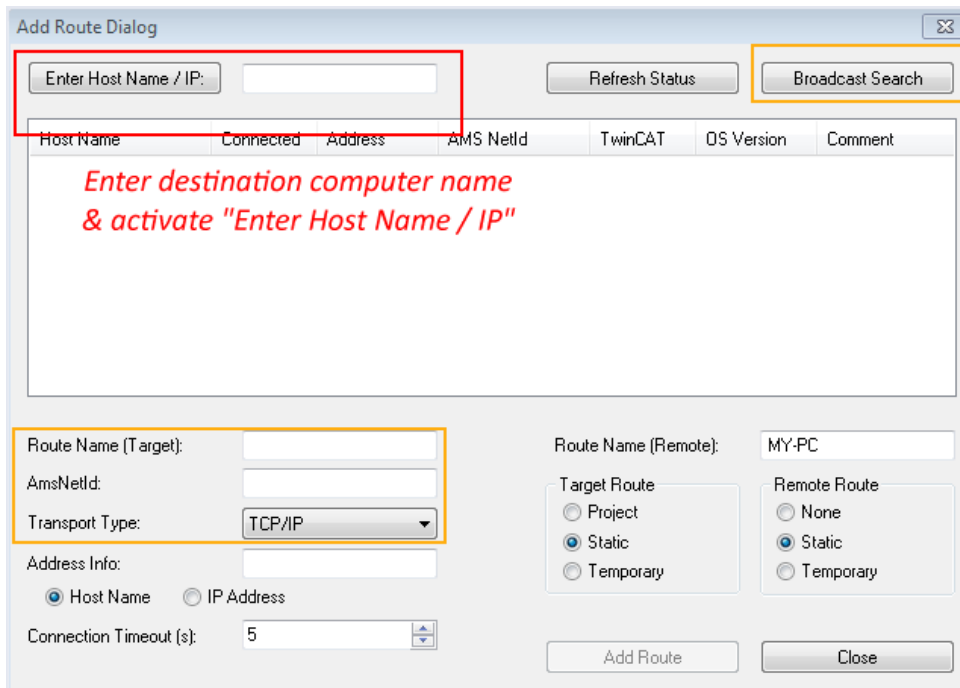
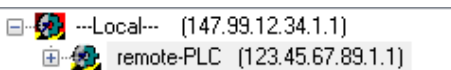

Fig. 43: specify the PLC for access by the TwinCAT System Manager: selection of the target system



Once the target system has been entered, it is available for selection as follows (a correct password may have to be entered before this):



After confirmation with “OK”, the target system can be accessed via the System Manager.

Adding devices

In the configuration tree of the TwinCAT 2 System Manager user interface on the left, select “I/O Devices” and then right-click to open a context menu and select “Scan Devices...”, or start the action in the menu bar

via . The TwinCAT System Manager may first have to be set to “Config Mode” via  or via the menu “Actions” → “Set/Reset TwinCAT to Config Mode...” (Shift + F4).

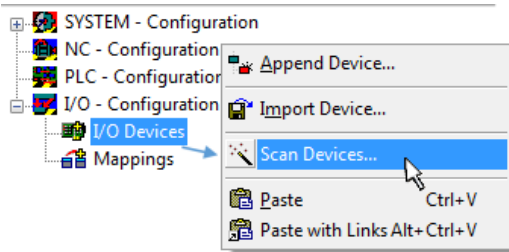

Fig. 44: Select “Scan Devices...”

Confirm the warning message, which follows, and select the “EtherCAT” devices in the dialog:

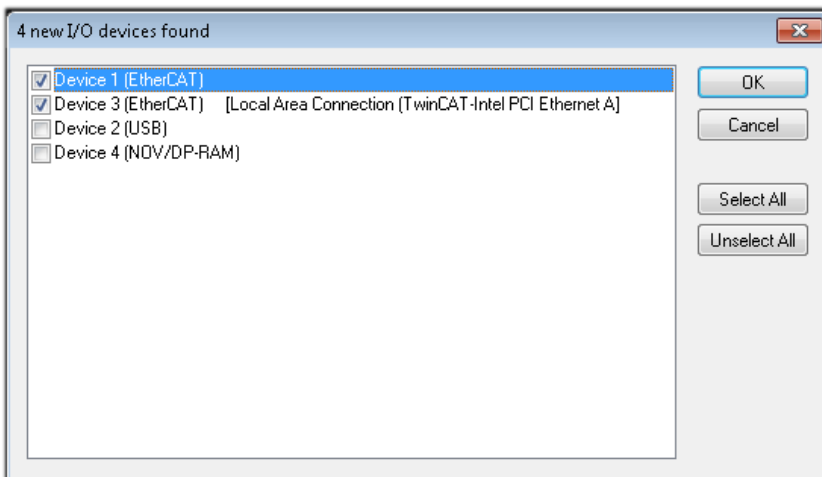

Fig. 45: Automatic detection of I/O devices: selection of the devices to be integrated

Confirm the message “Find new boxes”, in order to determine the terminals connected to the devices. “Free Run” enables manipulation of input and output values in “Config Mode” and should also be acknowledged.

Based on the [example configuration \[▶ 75\]](#) described at the beginning of this section, the result is as follows:

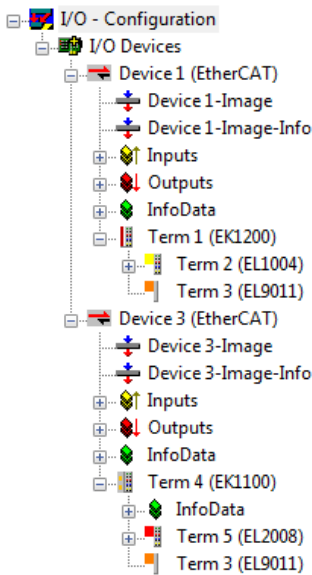

Fig. 46: Mapping of the configuration in the TwinCAT 2 System Manager

The whole process consists of two stages, which can also be performed separately (first determine the devices, then determine the connected elements such as boxes, terminals, etc.). A scan (search function) can also be initiated by selecting “Device ...” from the context menu, which then only reads the elements below which are present in the configuration:

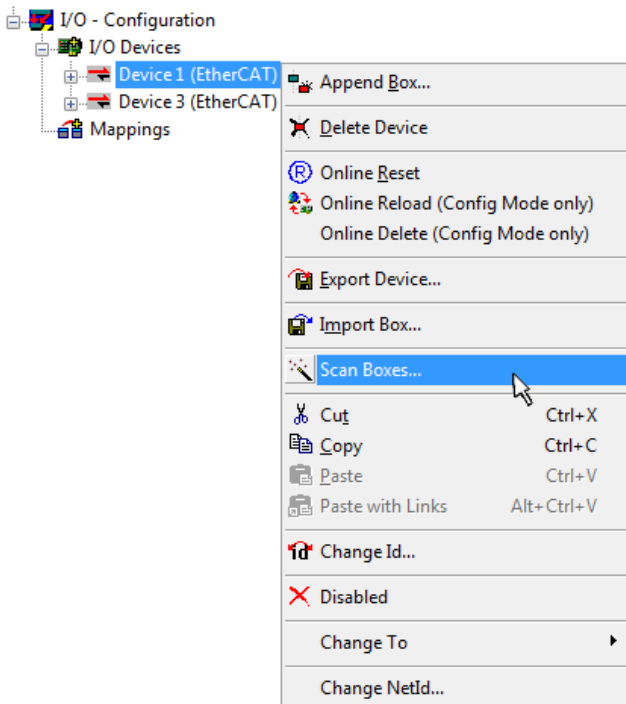

Fig. 47: Reading of individual terminals connected to a device

This functionality is useful if the actual configuration is modified at short notice.

Programming and integrating the PLC

TwinCAT PLC Control is the development environment for generating the controller in different program environments: TwinCAT PLC Control supports all languages described in IEC 61131-3. There are two text-based languages and three graphical languages.

- **Text-based languages**
 - Instruction List (IL)
 - Structured Text (ST)

- **Graphical languages**
 - Function Block Diagram (FBD)
 - Ladder Diagram (LD)
 - The Continuous Function Chart Editor (CFC)
 - Sequential Function Chart (SFC)

The following section refers solely to Structured Text (ST).

After starting TwinCAT PLC Control, the following user interface is shown for an initial project:

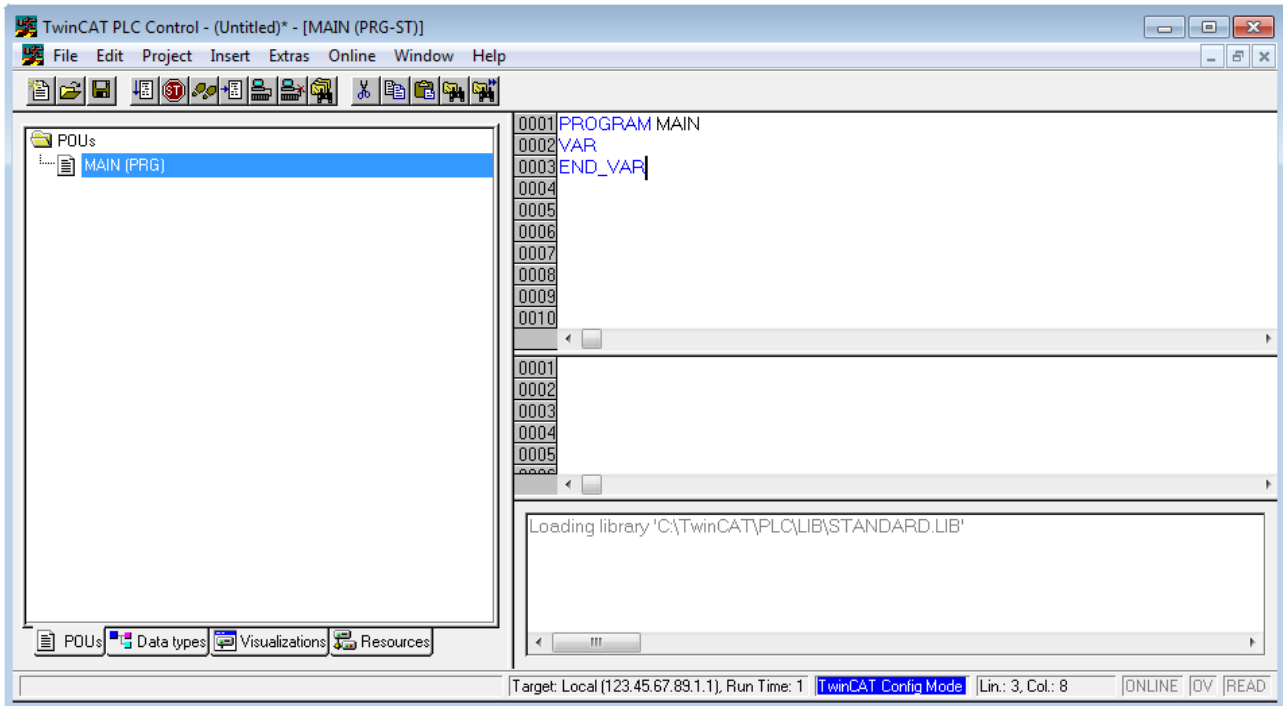

Fig. 48: TwinCAT PLC Control after startup

Example variables and an example program have been created and stored under the name “PLC_example.pro”:

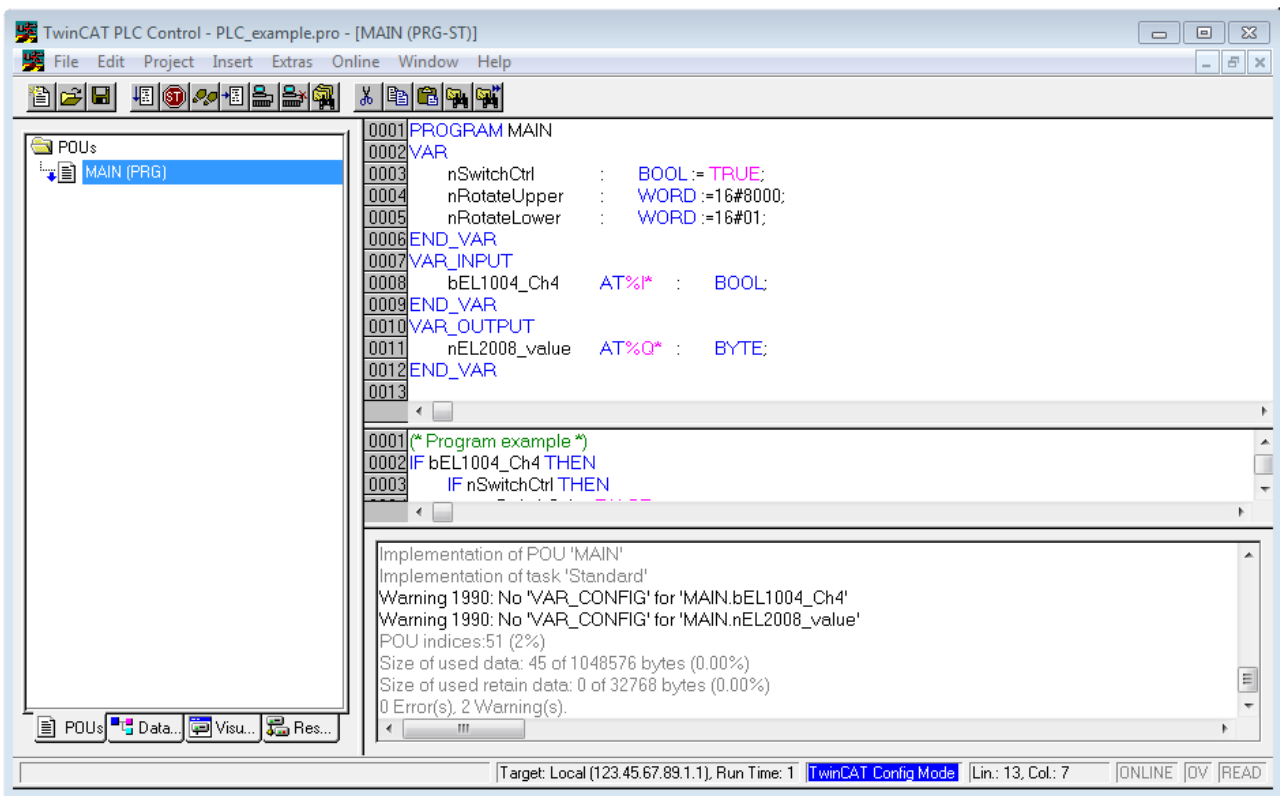

Fig. 49: Example program with variables after a compile process (without variable integration)

Warning 1990 (missing “VAR_CONFIG”) after a compile process indicates that the variables defined as external (with the ID “AT%I*” or “AT%Q*”) have not been assigned. After successful compilation, TwinCAT PLC Control creates a “*.tpy” file in the directory in which the project was stored. This file (“*.tpy”) contains variable assignments and is not known to the System Manager, hence the warning. Once the System Manager has been notified, the warning no longer appears.

First, integrate the TwinCAT PLC Control project in the **System Manager**. This is performed via the context menu of the PLC configuration (right-click) and selecting “Append PLC Project...”:

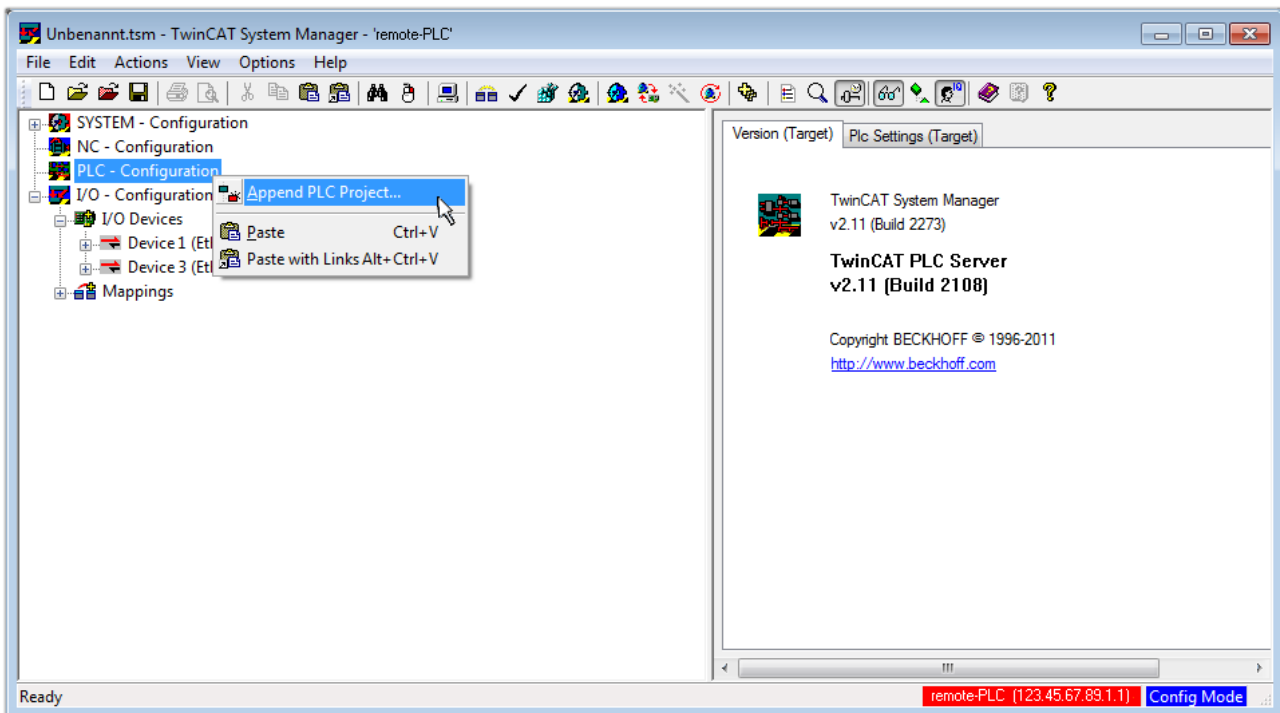

Fig. 50: Appending the TwinCAT PLC Control project

Select the PLC configuration “PLC_example.tpy” in the browser window that opens. The project including the two variables identified with “AT” are then integrated in the configuration tree of the System Manager:

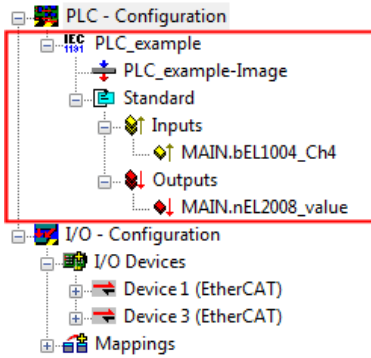

Fig. 51: PLC project integrated in the PLC configuration of the System Manager

The two variables “bEL1004_Ch4” and “nEL2008_value” can now be assigned to certain process objects of the I/O configuration.

Assigning variables

Open a window for selecting a suitable process object (PDO) via the context menu of a variable of the integrated project “PLC_example” and via “Modify Link...” “Standard”:

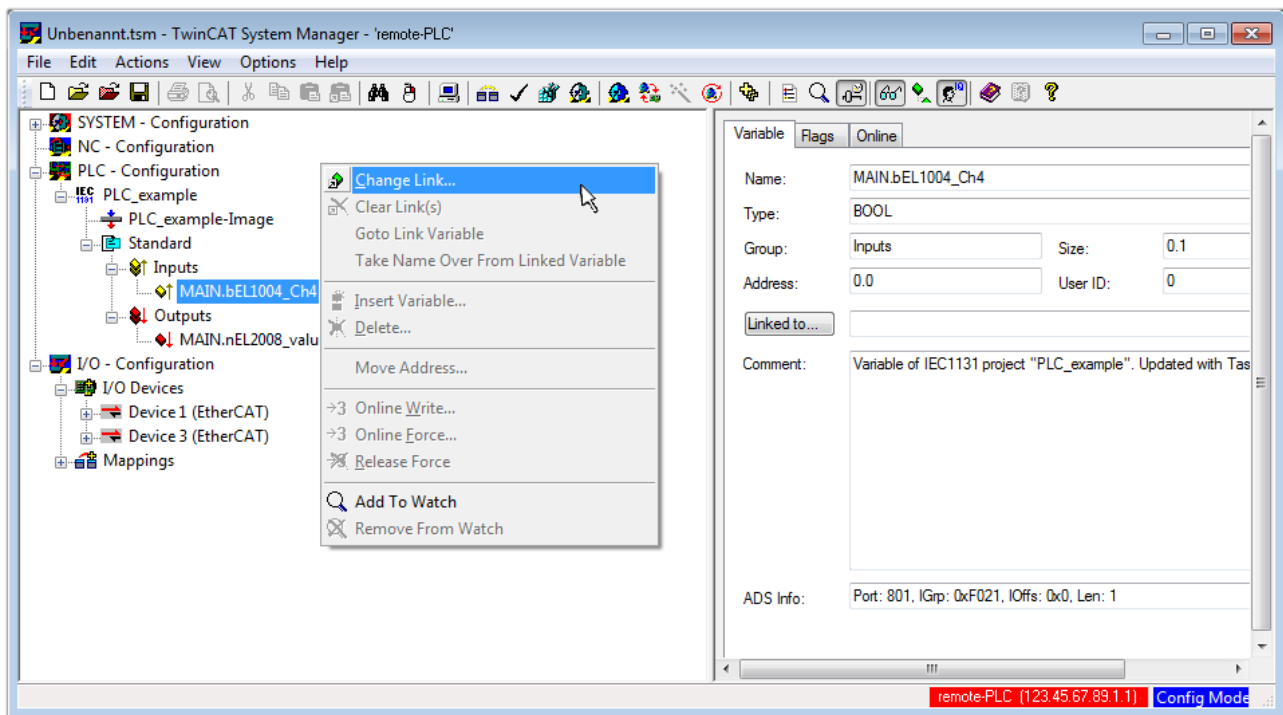

Fig. 52: Creating the links between PLC variables and process objects

In the window that opens, the process object for the “bEL1004_Ch4” BOOL-type variable can be selected from the PLC configuration tree:

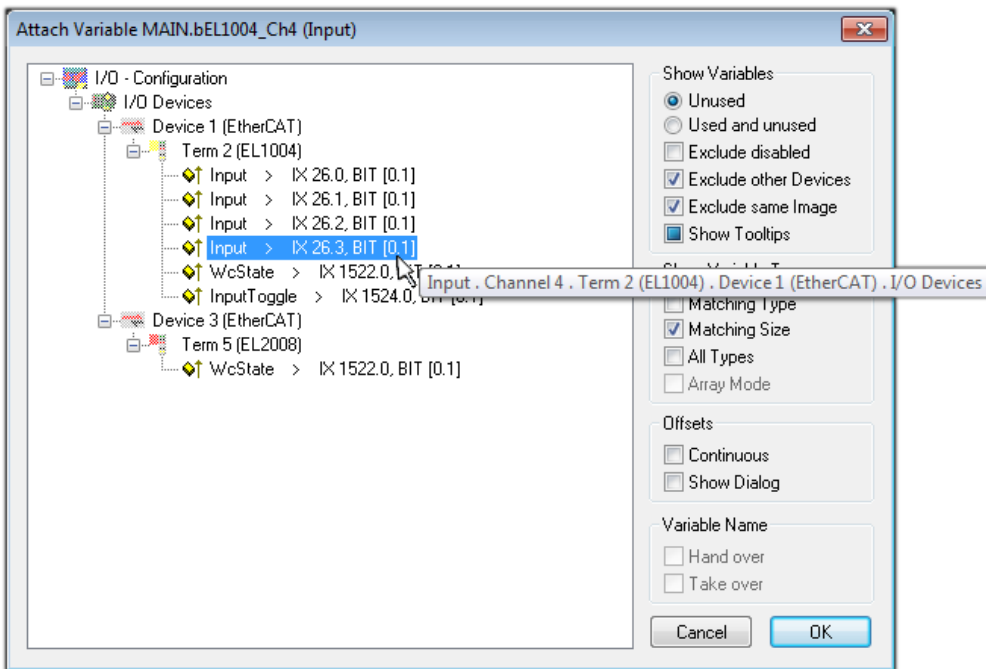

Fig. 53: Selecting BOOL-type PDO

According to the default setting, only certain PDO objects are now available for selection. In this example, the input of channel 4 of the EL1004 terminal is selected for linking. In contrast, the checkbox “All types” must be ticked to create the link for the output variables, in order to allocate a set of eight separate output bits to a byte variable in this case. The following diagram shows the whole process:

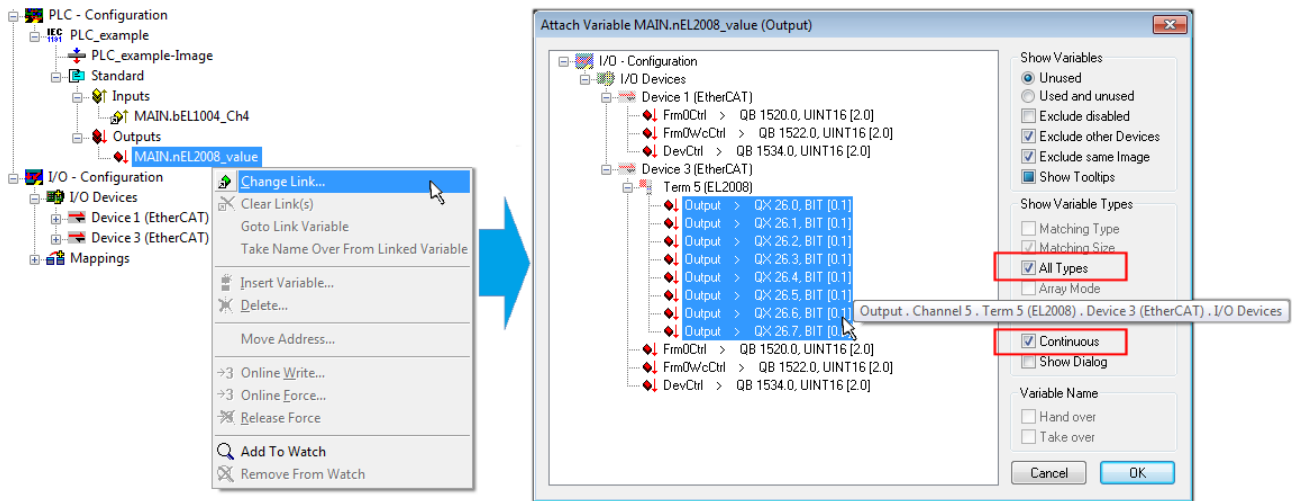



Fig. 54: Selecting several PDOs simultaneously: activate “Continuous” and “All types”

Note that the “Continuous” checkbox was also activated. This is designed to allocate the bits contained in the byte of the “nEL2008_value” variable sequentially to all eight selected output bits of the EL2008 Terminal. It is thus possible to subsequently address all eight outputs of the terminal in the program with a byte corresponding to bit 0 for channel 1 to bit 7 for channel 8 of the PLC. A special symbol () on the yellow or red object of the variable indicates that a link exists. The links can also be checked by selecting “Goto Link Variable” from the context menu of a variable. The opposite linked object, in this case the PDO, is automatically selected:

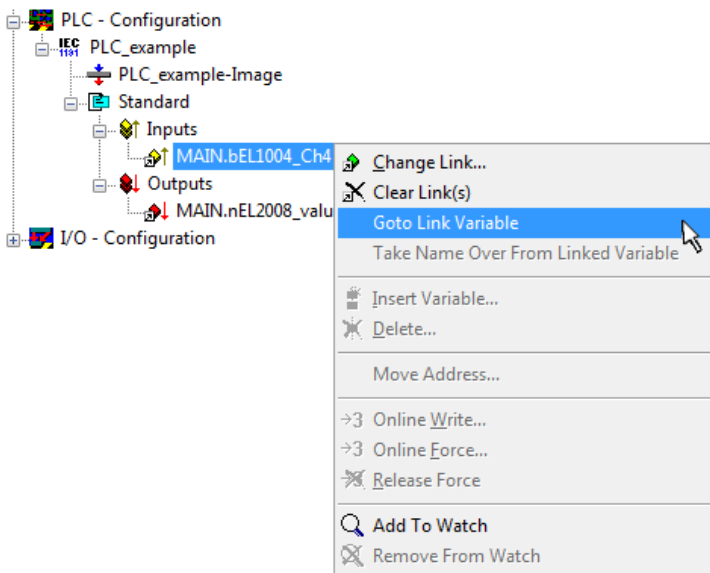

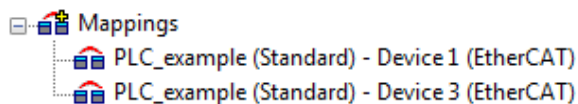

Fig. 55: Application of a “Goto Link Variable”, using “MAIN.bEL1004_Ch4” as an example

The process of assigning variables to the PDO is completed via the menu option “Actions” → “Create assignment”, or via  .

This can be visualized in the configuration:



The process of creating links can also be performed in the opposite direction, i.e. starting with individual PDOs to a variable. However, in this example, it would not be possible to select all output bits for the EL2008, since the terminal only makes individual digital outputs available. If a terminal has a byte, word, integer or similar PDO, it is also possible to allocate this to a set of bit-standardized variables. Here, too, a “Goto Link Variable” can be executed in the other direction, so that the respective PLC instance can then be selected.

Activation of the configuration

The allocation of PDO to PLC variables has now established the connection from the controller to the inputs and outputs of the terminals. The configuration can now be activated. First, the configuration can be verified

via  (or via “Actions” → “Check Configuration”). If no error is present, the configuration can be

activated via  (or via “Actions” → “Activate Configuration...”) to transfer the System Manager settings to the runtime system. Confirm the messages “Old configurations will be overwritten!” and “Restart TwinCAT system in Run mode” with “OK”.

A few seconds later, the real-time status **RTime 0%** is displayed at the bottom right in the System Manager. The PLC system can then be started as described below.

Starting the controller

Starting from a remote system, the PLC control has to be linked with the embedded PC over the Ethernet via “Online” → “Choose Runtime System...”:

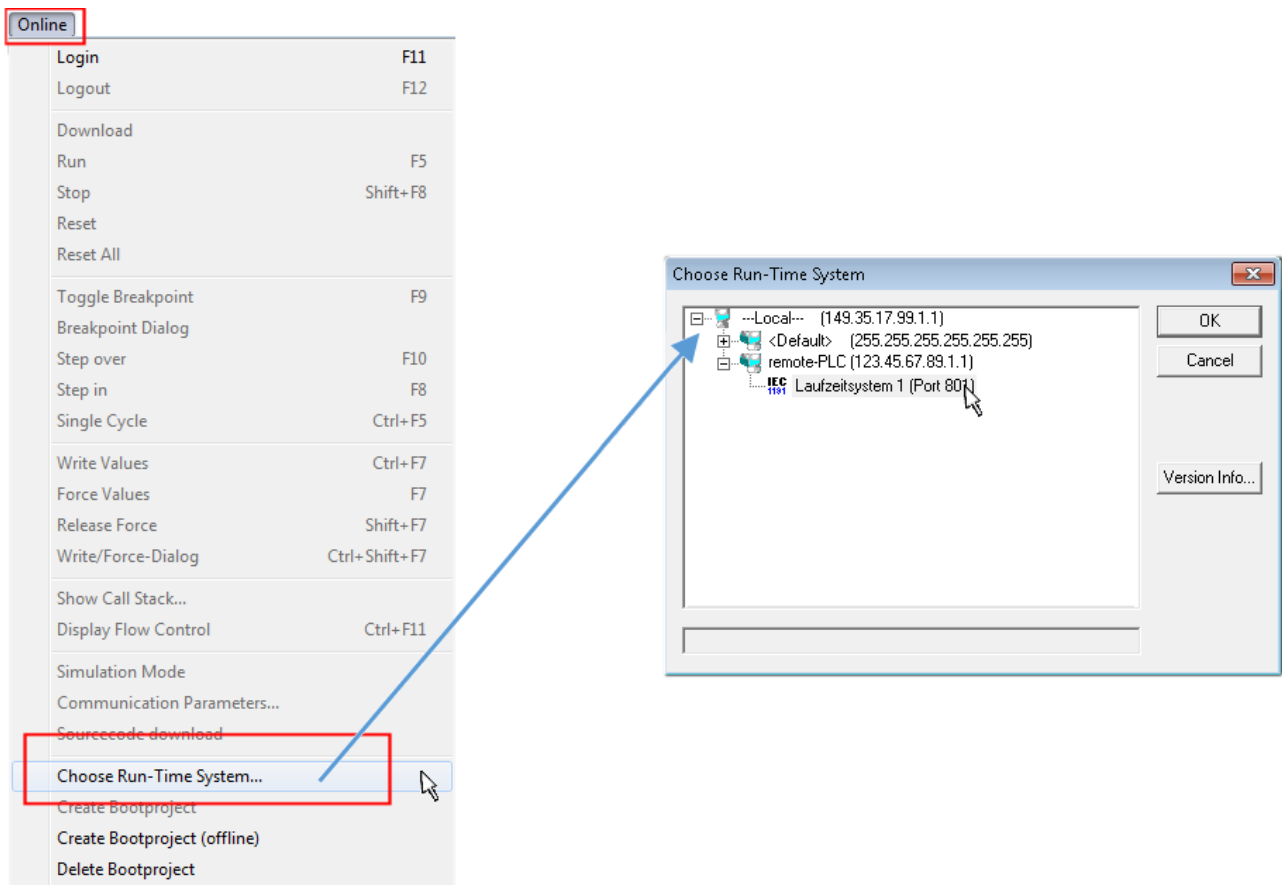



Fig. 56: Choose target system (remote)

In this example, "Runtime system 1 (port 801)" is selected and confirmed. Link the PLC with the real-time

system via the menu option "Online" → "Login", the F11 key or by clicking on the symbol . The control program can then be loaded for execution. This results in the message "No program on the controller! Should the new program be loaded?", which should be confirmed with "Yes". The runtime environment is ready for the program start:

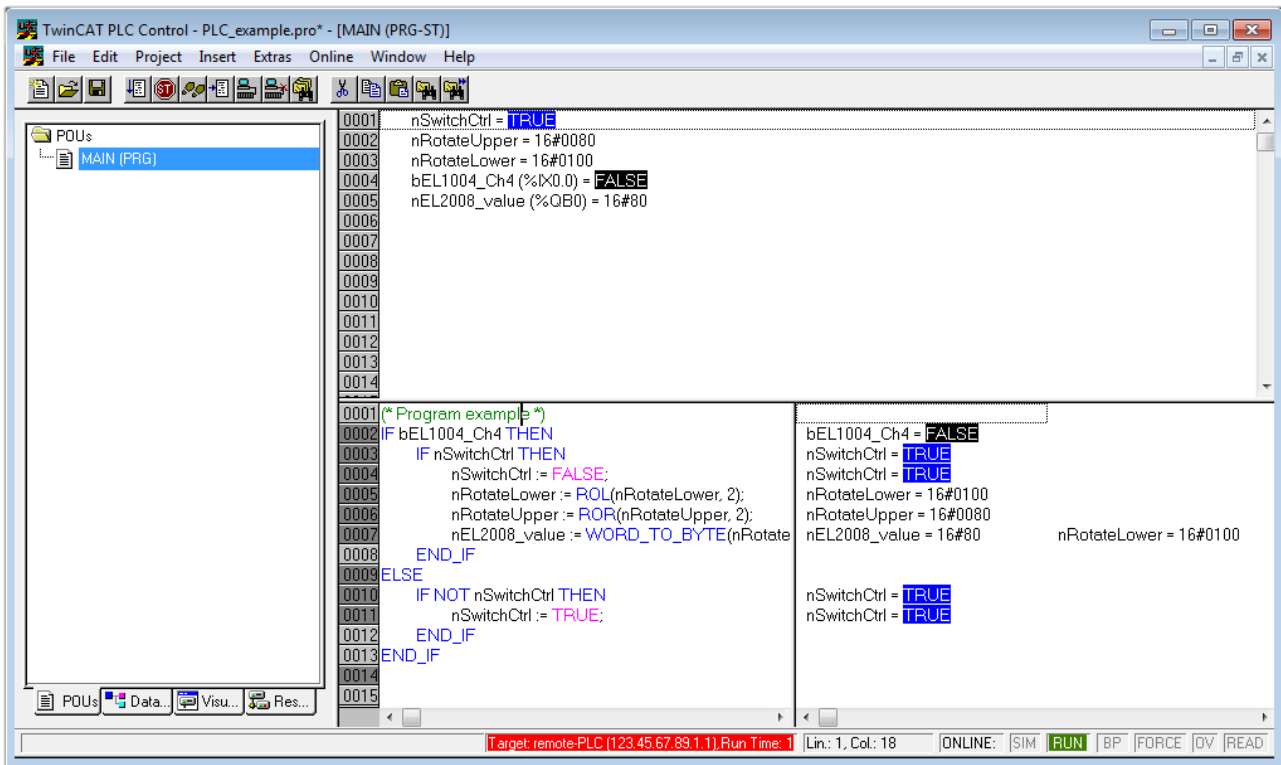

Fig. 57: PLC Control logged in, ready for program startup

The PLC can now be started via “Online” → “Run”, F5 key or .

13.1.2 TwinCAT 3

Startup

TwinCAT 3 makes the development environment areas available all together, with Microsoft Visual Studio: after startup, the project folder explorer appears on the left in the general window area (see “TwinCAT System Manager” of TwinCAT 2) for communication with the electromechanical components.

After successful installation of the TwinCAT system on the PC to be used for development, TwinCAT 3 (shell) displays the following user interface after startup:



Fig. 58: Initial TwinCAT 3 user interface

First create a new project via  **New TwinCAT Project...** (or under “File”→“New”→“Project...”). In the following dialog, make the corresponding entries as required (as shown in the diagram):

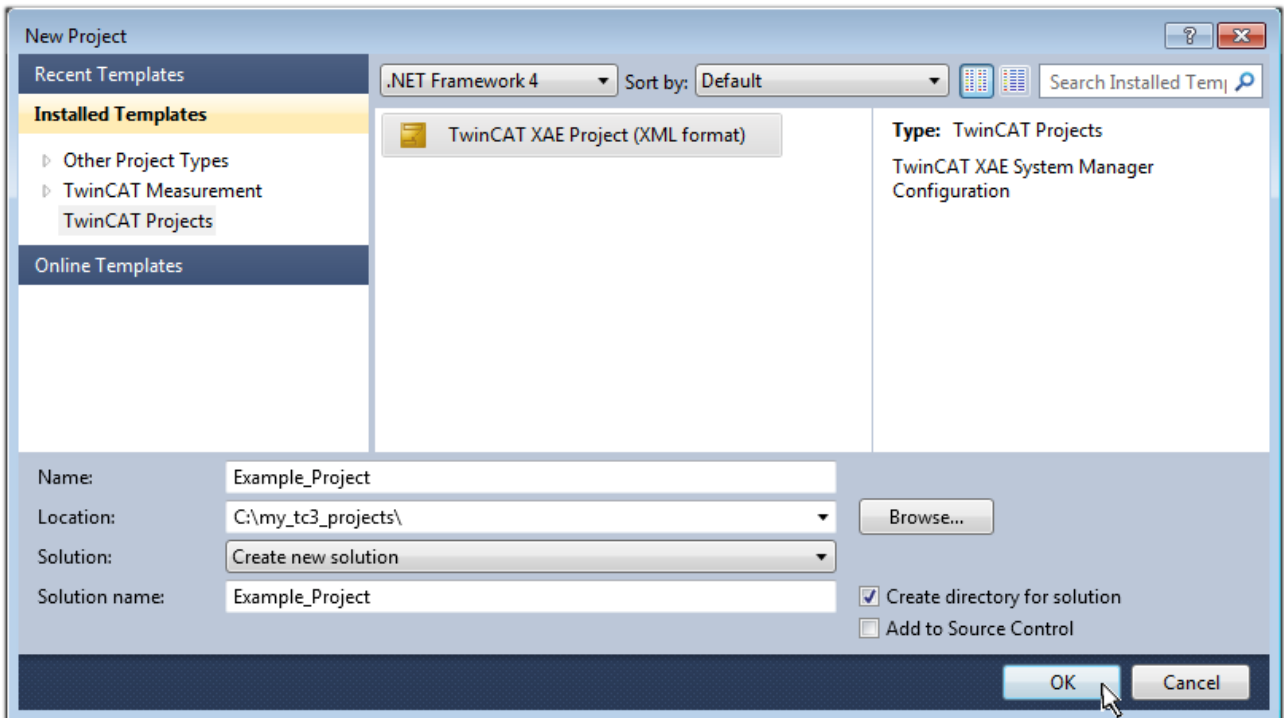

Fig. 59: Create new TwinCAT 3 project

The new project is then available in the project folder explorer:

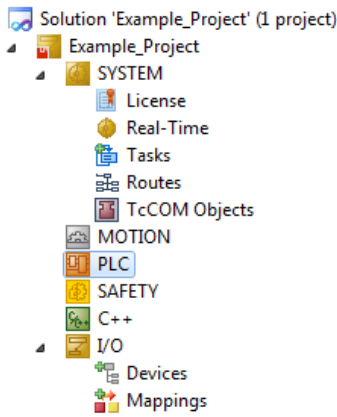
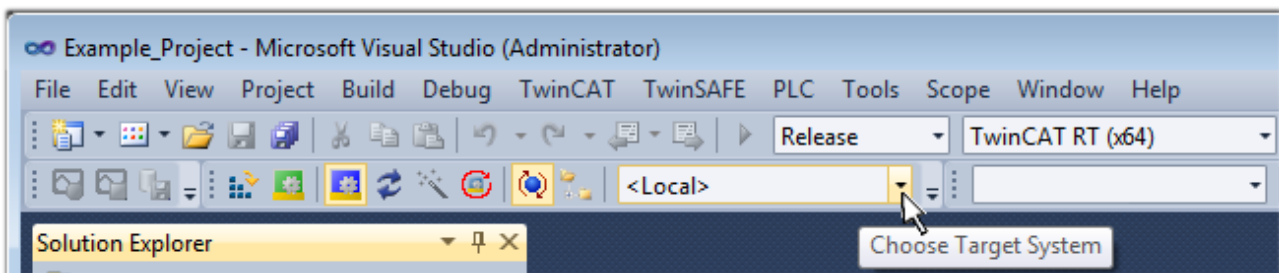

Fig. 60: New TwinCAT 3 project in the project folder explorer

Generally, TwinCAT can be used in local or remote mode. Once the TwinCAT system including the user interface (standard) is installed on the respective PLC (locally), TwinCAT can be used in local mode and the process can be continued with the next step, “Insert Device [► 90]”.

If the intention is to address the TwinCAT runtime environment installed on a PLC remotely from another system used as a development environment, the target system must be made known first. Via the symbol in the menu bar:



expand the pull-down menu:

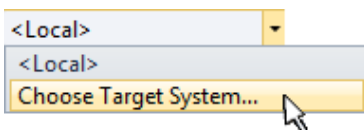

and open the following window:

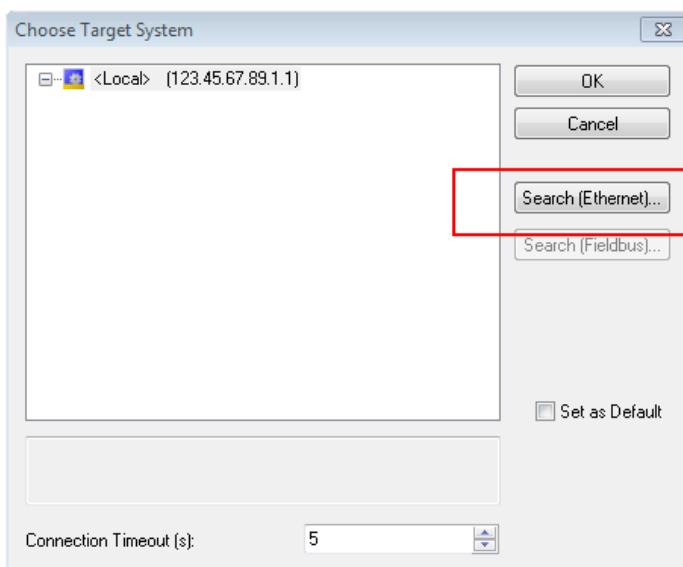

Fig. 61: Selection dialog: Choose the target system

Use “Search (Ethernet)...” to enter the target system. Thus another dialog opens to either:

- enter the known computer name after “Enter Host Name / IP:” (as shown in red)
- perform a “Broadcast Search” (if the exact computer name is not known)
- enter the known computer – IP or AmsNetID

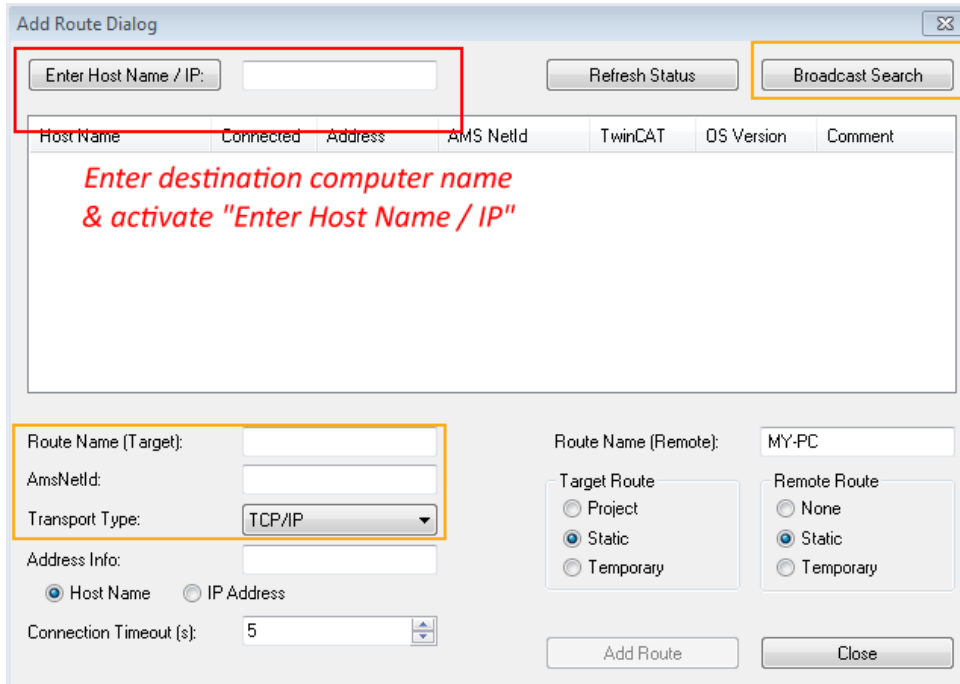
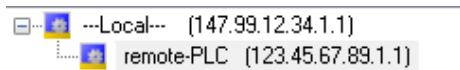

Fig. 62: specify the PLC for access by the TwinCAT System Manager: selection of the target system

Once the target system has been entered, it is available for selection as follows (the correct password may have to be entered beforehand):



After confirmation with “OK” the target system can be accessed via the Visual Studio shell.

Adding devices

In the project folder explorer on the left of the Visual Studio shell user interface, select “Devices” within the

element “I/O”, then right-click to open a context menu and select “Scan” or start the action via  in the

menu bar. The TwinCAT System Manager may first have to be set to “Config mode” via  or via the menu “TwinCAT” → “Restart TwinCAT (Config Mode)”.

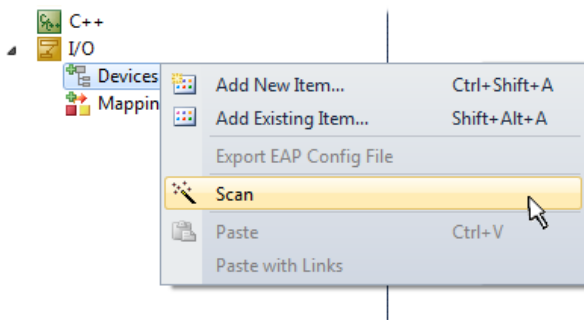

Fig. 63: Select “Scan”

Confirm the warning message, which follows, and select the “EtherCAT” devices in the dialog:

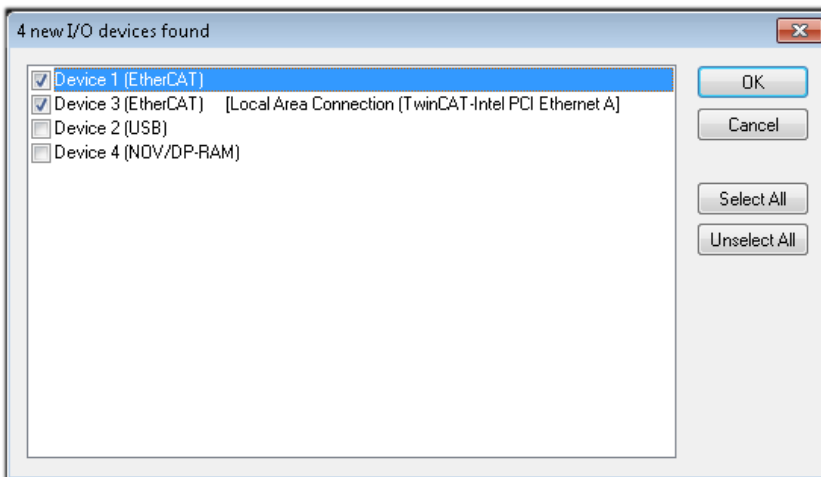

Fig. 64: Automatic detection of I/O devices: selection of the devices to be integrated

Confirm the message “Find new boxes”, in order to determine the terminals connected to the devices. “Free Run” enables manipulation of input and output values in “Config Mode” and should also be acknowledged.

Based on the [example configuration \[▶ 75\]](#) described at the beginning of this section, the result is as follows:

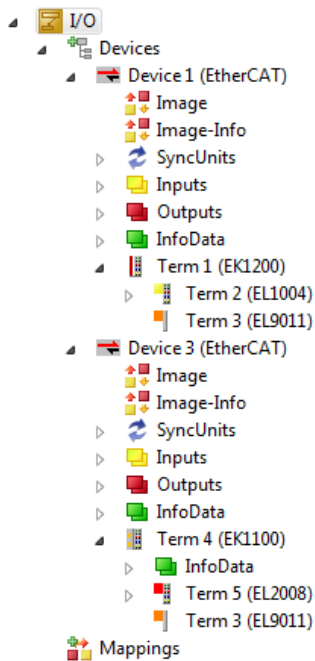

Fig. 65: Mapping of the configuration in VS shell of the TwinCAT 3 environment

The whole process consists of two stages, which can also be performed separately (first determine the devices, then determine the connected elements such as boxes, terminals, etc.). A scan (search function) can also be initiated by selecting “Device ...” from the context menu, which then only reads the elements below which are present in the configuration:

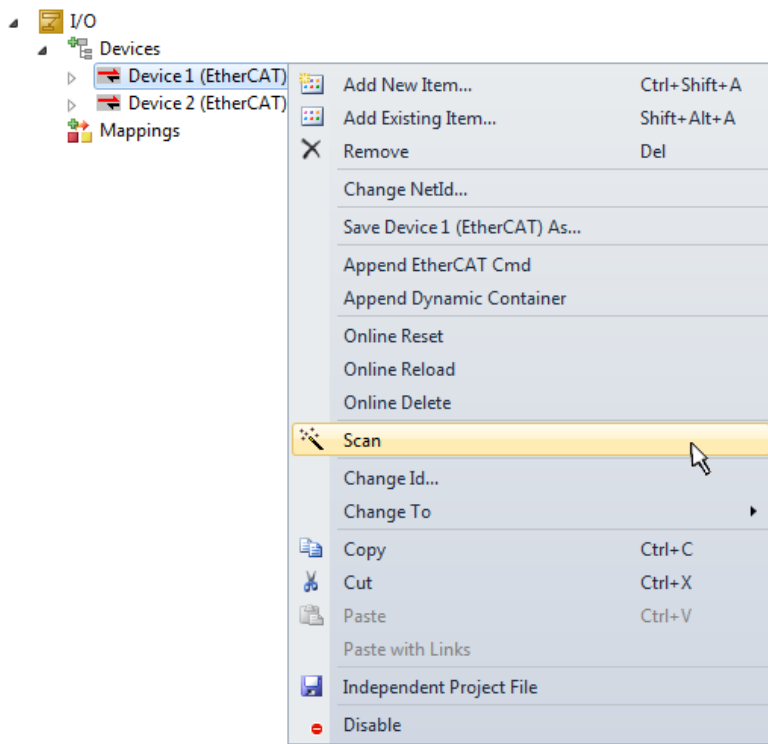

Fig. 66: Reading of individual terminals connected to a device

This functionality is useful if the actual configuration is modified at short notice.

Programming the PLC

TwinCAT PLC Control is the development environment for generating the controller in different program environments: TwinCAT PLC Control supports all languages described in IEC 61131-3. There are two text-based languages and three graphical languages.

- **Text-based languages**
 - Instruction List (IL)
 - Structured Text (ST)
- **Graphical languages**
 - Function Block Diagram (FBD)
 - Ladder Diagram (LD)
 - The Continuous Function Chart Editor (CFC)
 - Sequential Function Chart (SFC)

The following section refers solely to Structured Text (ST).

In order to create a programming environment, a PLC subproject is added to the example project via the context menu of the "PLC" in the project folder explorer by selecting "Add New Item....":

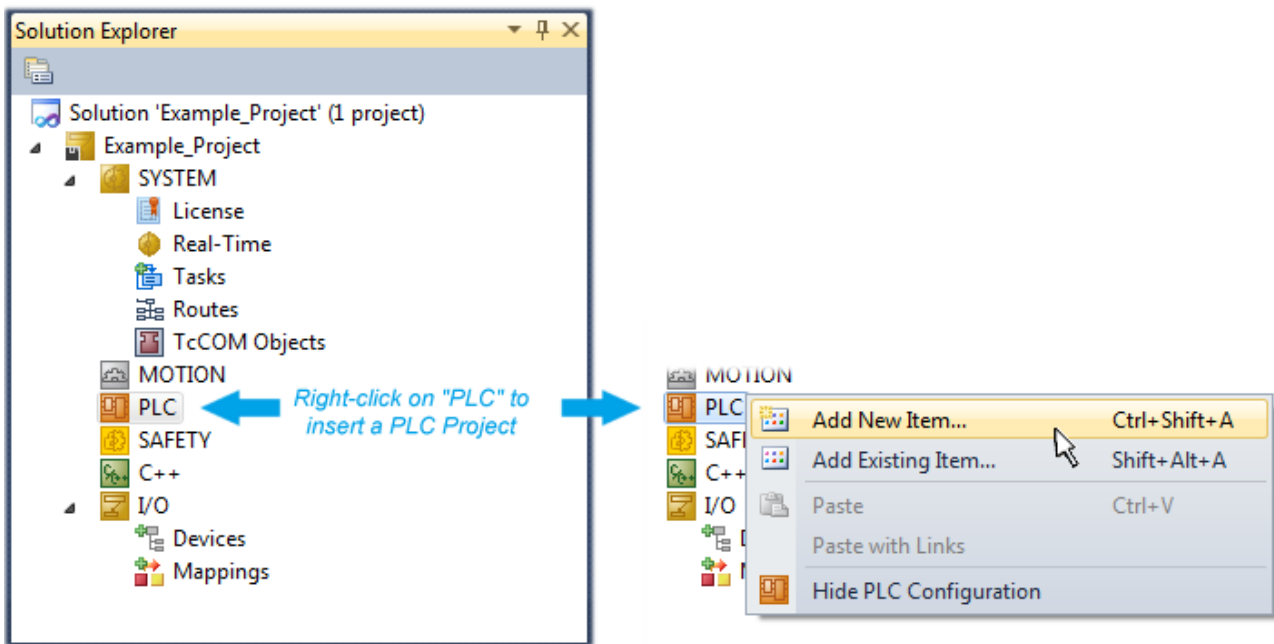

Fig. 67: Adding the programming environment in “PLC”

In the dialog that opens, select “Standard PLC project” and enter “PLC_example” as project name, for example, and select a corresponding directory:

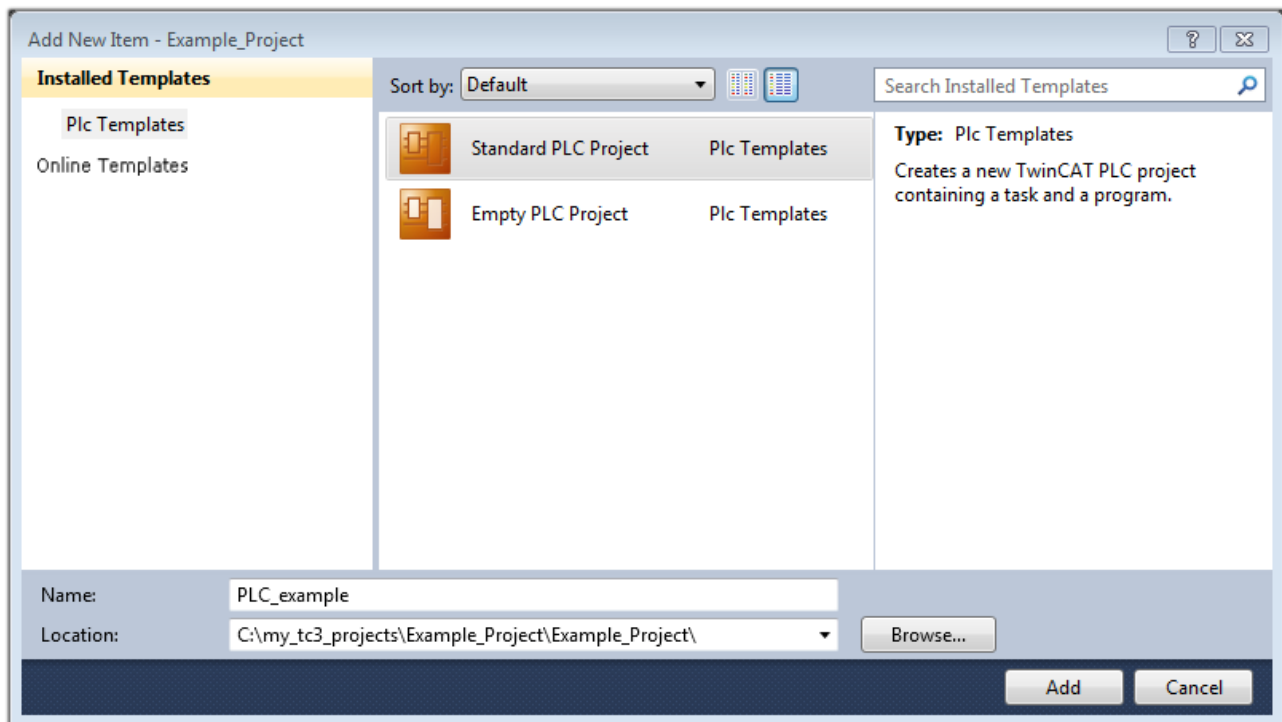

Fig. 68: Specifying the name and directory for the PLC programming environment

The “Main” program, which already exists due to selecting “Standard PLC project”, can be opened by double-clicking on “PLC_example_project” in “POUs”. The following user interface is shown for an initial project:

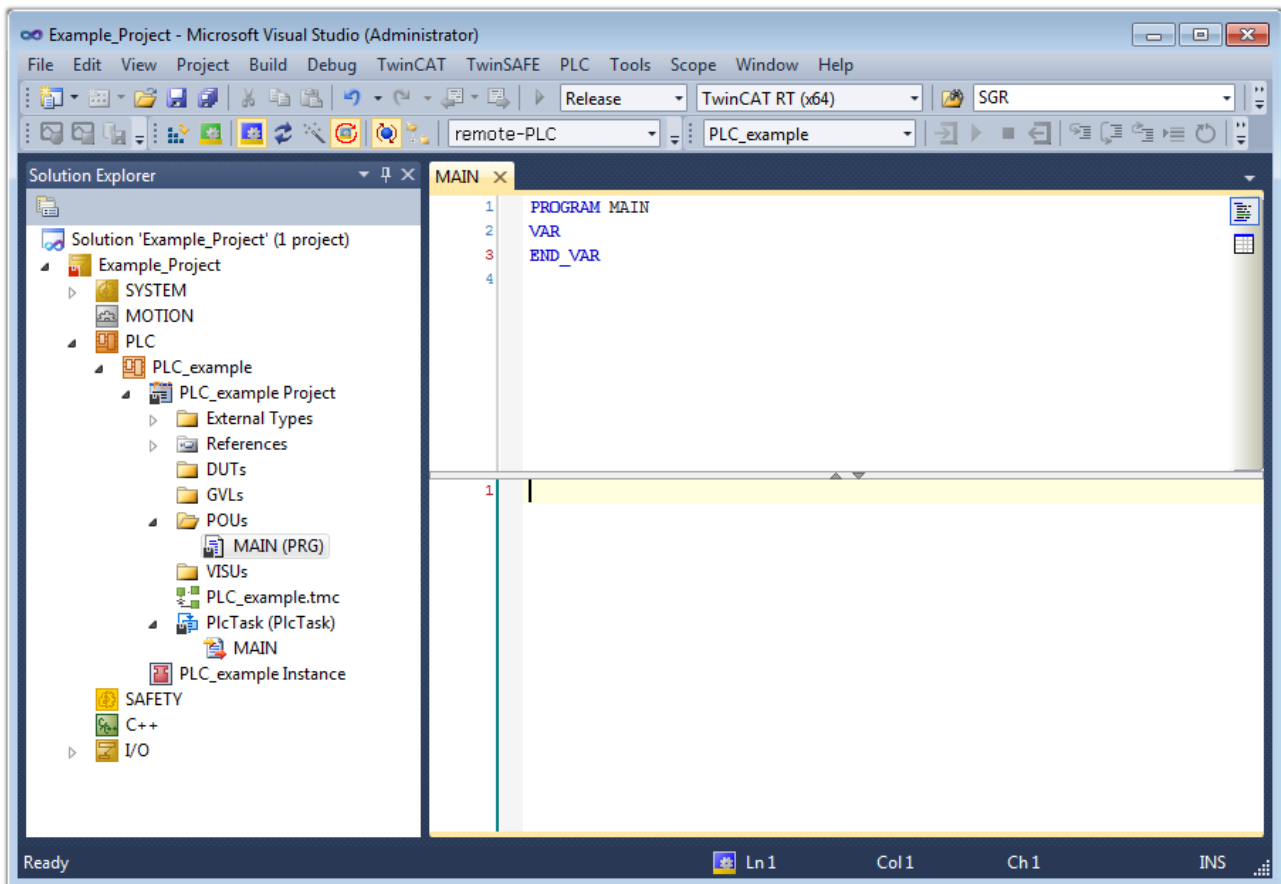

Fig. 69: Initial “Main” program for the standard PLC project

Now example variables and an example program have been created for the next stage of the process:

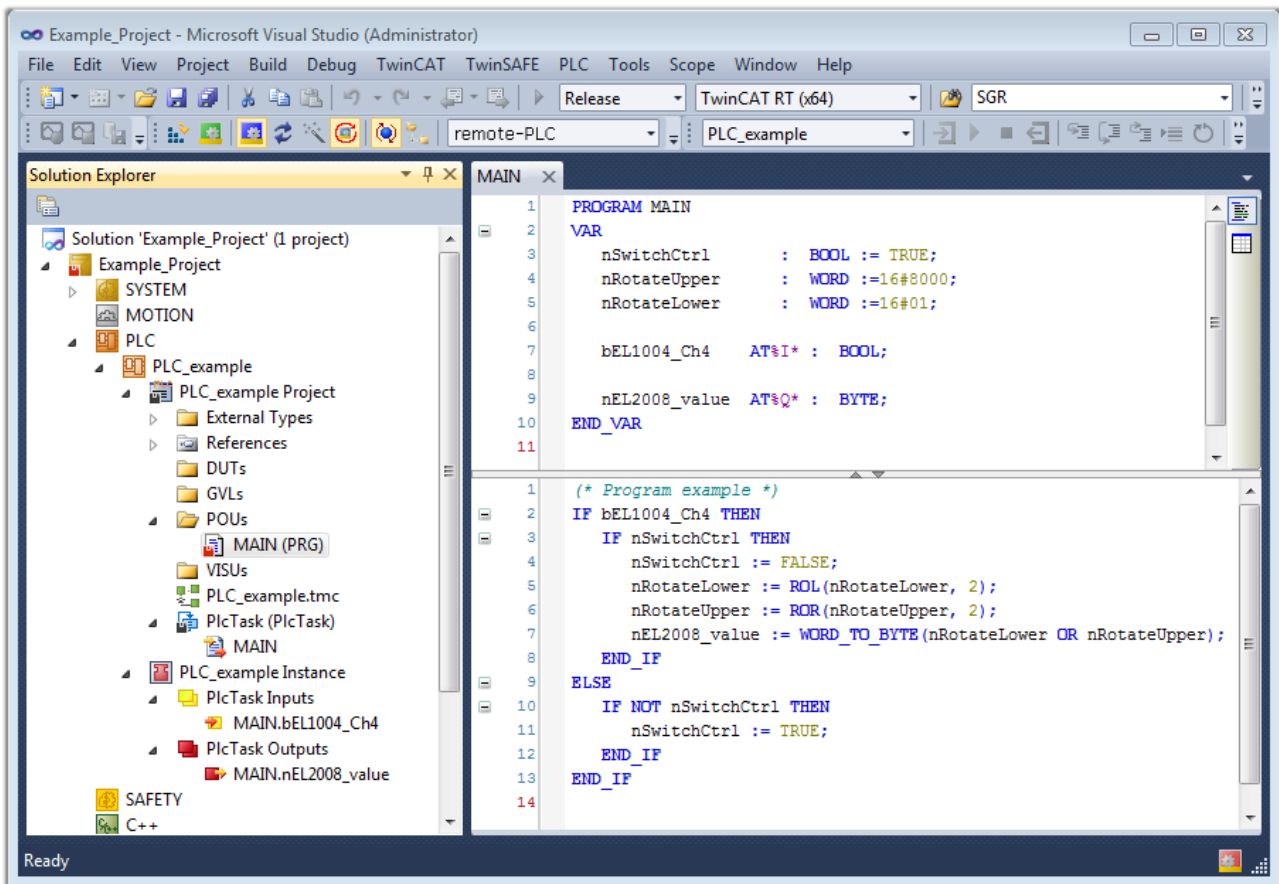

Fig. 70: Example program with variables after a compile process (without variable integration)

The control program is now created as a project folder, followed by the compile process:

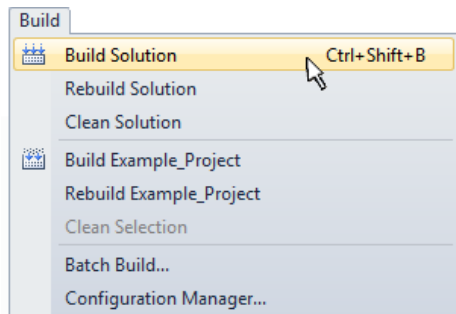
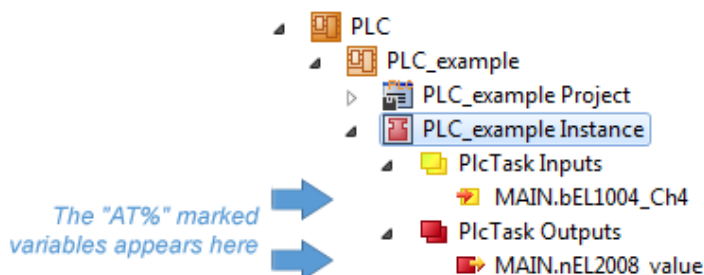

Fig. 71: Start program compilation

The following variables, identified in the ST/PLC program with “AT%”, are then available under “Assignments” in the project folder explorer:



Assigning variables

Via the menu of an instance – variables in the “PLC” context, use the “Modify Link...” option to open a window to select a suitable process object (PDO) for linking:

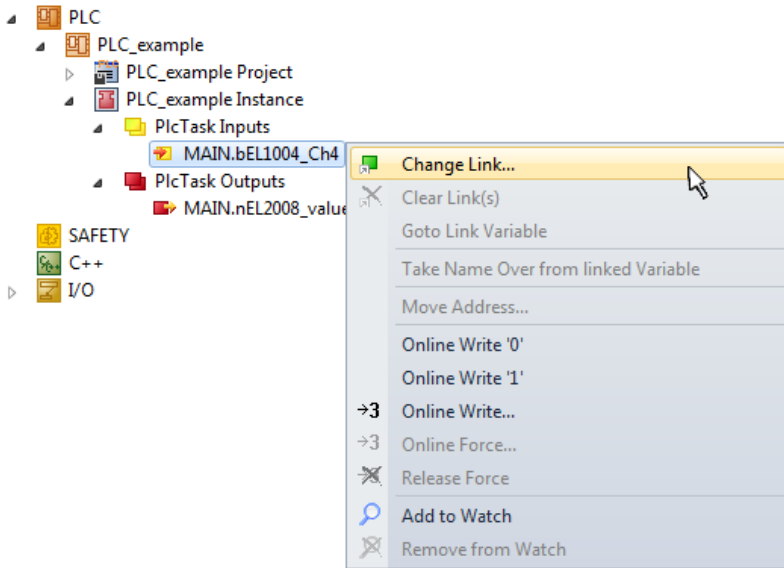

Fig. 72: Creating the links between PLC variables and process objects

In the window that opens, the process object for the “bEL1004_Ch4” BOOL-type variable can be selected from the PLC configuration tree:

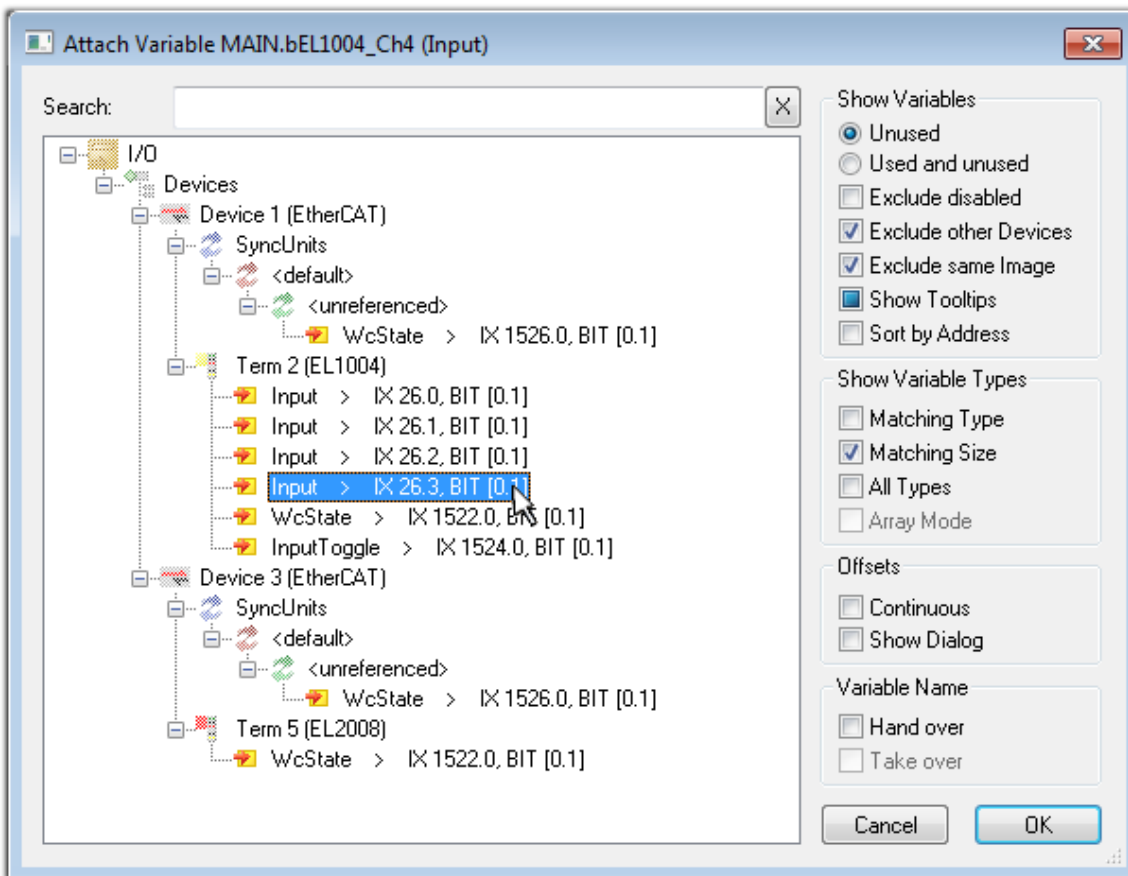

Fig. 73: Selecting BOOL-type PDO

According to the default setting, only certain PDO objects are now available for selection. In this example, the input of channel 4 of the EL1004 terminal is selected for linking. In contrast, the checkbox “All types” must be ticked to create the link for the output variables, in order to allocate a set of eight separate output bits to a byte variable in this case. The following diagram shows the whole process:

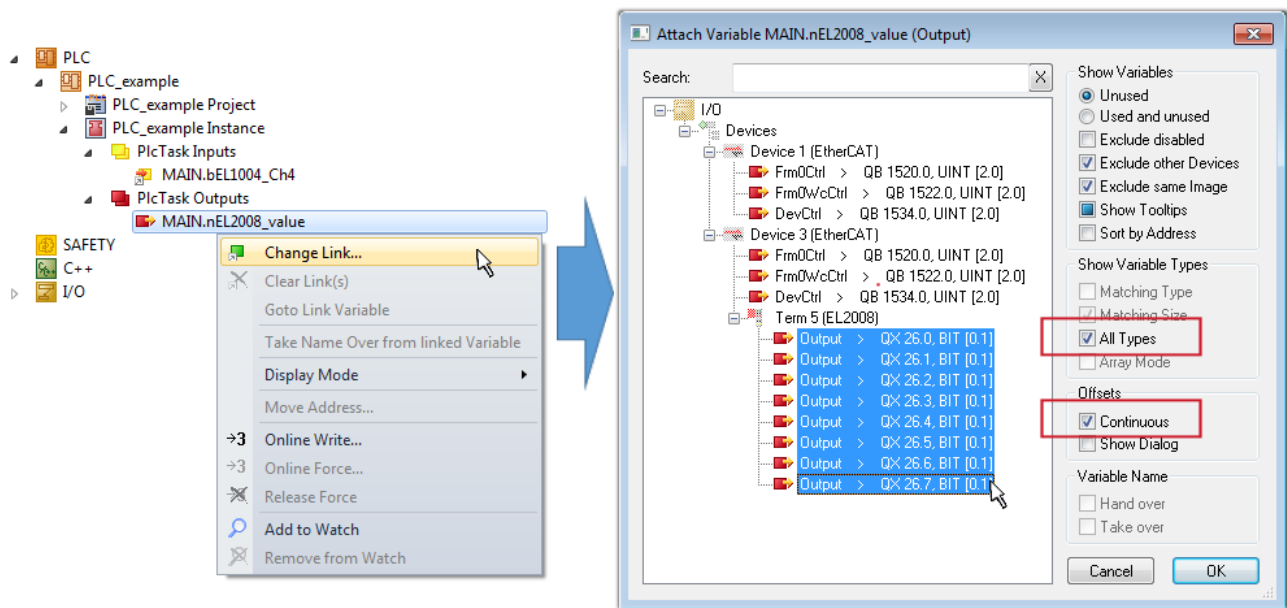



Fig. 74: Selecting several PDOs simultaneously: activate “Continuous” and “All types”

Note that the “Continuous” checkbox was also activated. This is designed to allocate the bits contained in the byte of the “nEL2008_value” variable sequentially to all eight selected output bits of the EL2008 Terminal. It is thus possible to subsequently address all eight outputs of the terminal in the program with a byte corresponding to bit 0 for channel 1 to bit 7 for channel 8 of the PLC. A special symbol () on the yellow or red object of the variable indicates that a link exists. The links can also be checked by selecting “Goto Link Variable” from the context menu of a variable. The opposite linked object, in this case the PDO, is automatically selected:

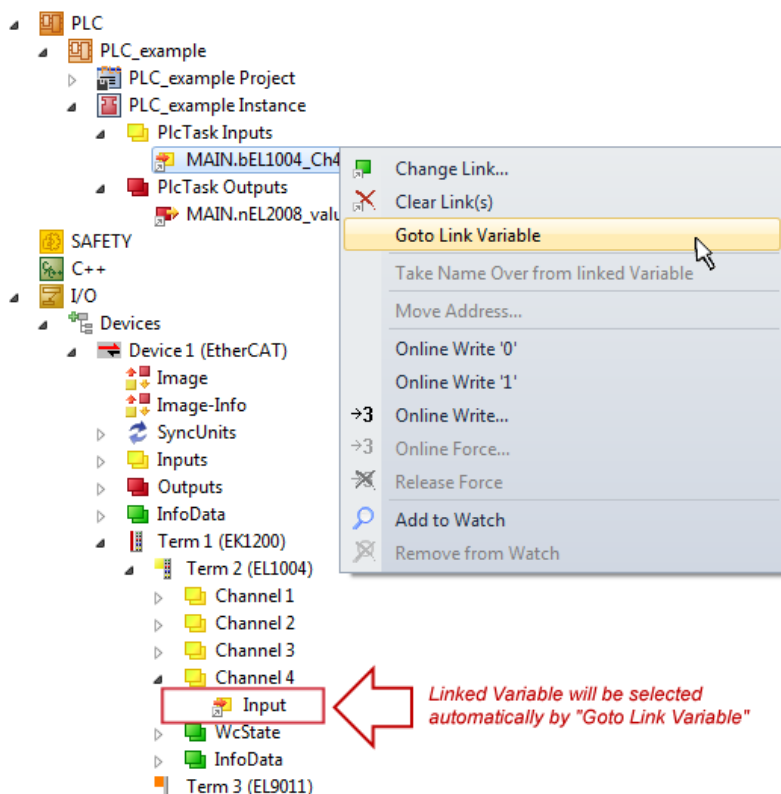

Fig. 75: Application of a “Goto Link Variable”, using “MAIN.bEL1004_Ch4” as an example

The process of creating links can also be performed in the opposite direction, i.e. starting with individual PDOs to a variable. However, in this example, it would not be possible to select all output bits for the EL2008, since the terminal only makes individual digital outputs available. If a terminal has a byte, word,

integer or similar PDO, it is also possible to allocate this to a set of bit-standardized variables. Here, too, a “Goto Link Variable” can be executed in the other direction, so that the respective PLC instance can then be selected.

● Note on type of variable assignment

i The following type of variable assignment can only be used from TwinCAT version V3.1.4024.4 onwards and is only available for terminals with a microcontroller.

In TwinCAT, a structure can be created from the mapped process data of a terminal. An instance of this structure can then be created in the PLC, so it is possible to access the process data directly from the PLC without having to declare own variables.

The procedure for the EL3001 1-channel analog input terminal -10...+10 V is shown as an example.

1. First, the required process data must be selected in the “Process data” tab in TwinCAT.
2. After that, the PLC data type must be generated in the “PLC” tab via the check box.
3. The data type in the “Data Type” field can then be copied using the “Copy” button.

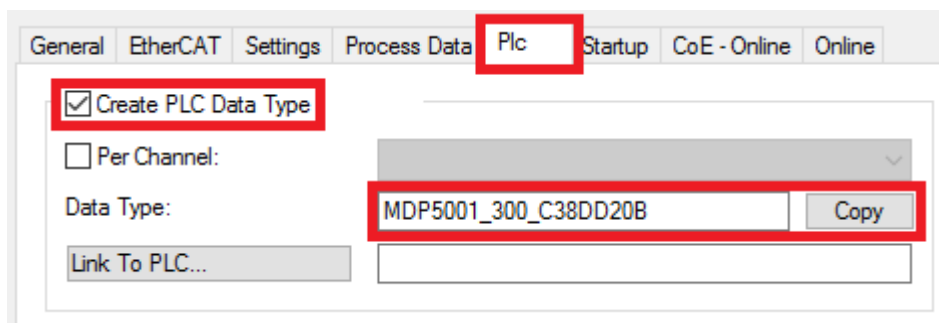

Fig. 76: Creating a PLC data type

4. An instance of the data structure of the copied data type must then be created in the PLC.

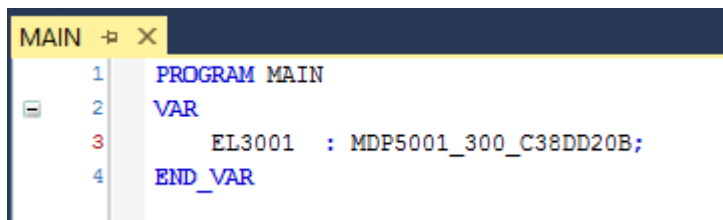

Fig. 77: Instance_of_struct

5. Then the project folder must be created. This can be done either via the key combination “CTRL + Shift + B” or via the “Build” tab in TwinCAT.
6. The structure in the “PLC” tab of the terminal must then be linked to the created instance.

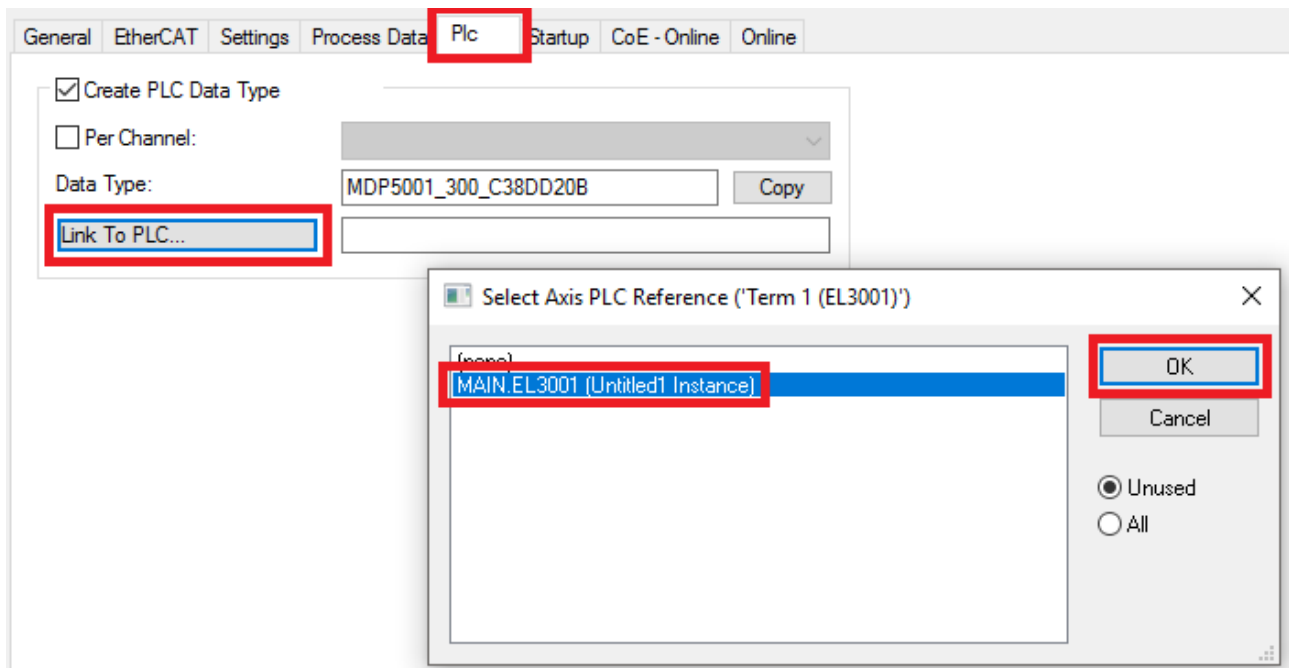

Fig. 78: Linking the structure

7. In the PLC, the process data can then be read or written via the structure in the program code.

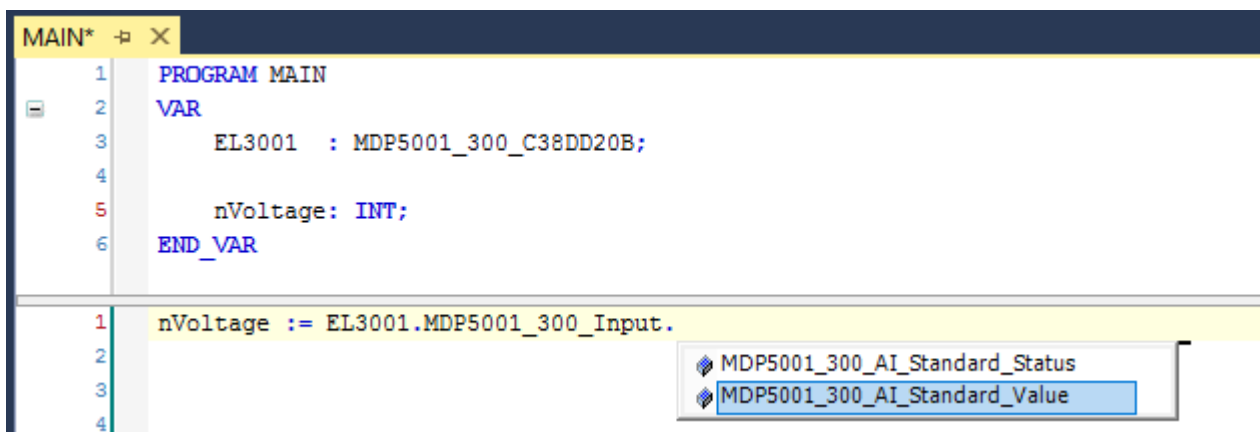

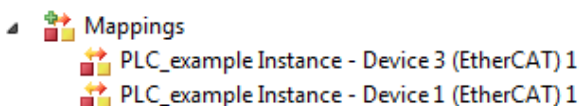

Fig. 79: Reading a variable from the structure of the process data

Activation of the configuration

The allocation of PDO to PLC variables has now established the connection from the controller to the inputs

and outputs of the terminals. The configuration can now be activated with  or via the menu under “TwinCAT” in order to transfer the settings of the development environment to the runtime system. Confirm the messages “Old configurations will be overwritten!” and “Restart TwinCAT system in Run mode” with “OK”. The corresponding assignments can be seen in the project folder explorer:



A few seconds later, the corresponding status of the Run mode is displayed in the form of a rotating symbol

 at the bottom right of the VS shell development environment. The PLC system can then be started as described below.

Starting the controller

Select the menu option “PLC” → “Login” or click on  to link the PLC with the real-time system and load the control program for execution. This results in the message “No program on the controller! Should the new program be loaded?”, which should be acknowledged with “Yes”. The runtime environment is ready for

the program to be started by clicking on symbol , the “F5” key or via “PLC” in the menu, by selecting “Start”. The started programming environment shows the runtime values of individual variables:

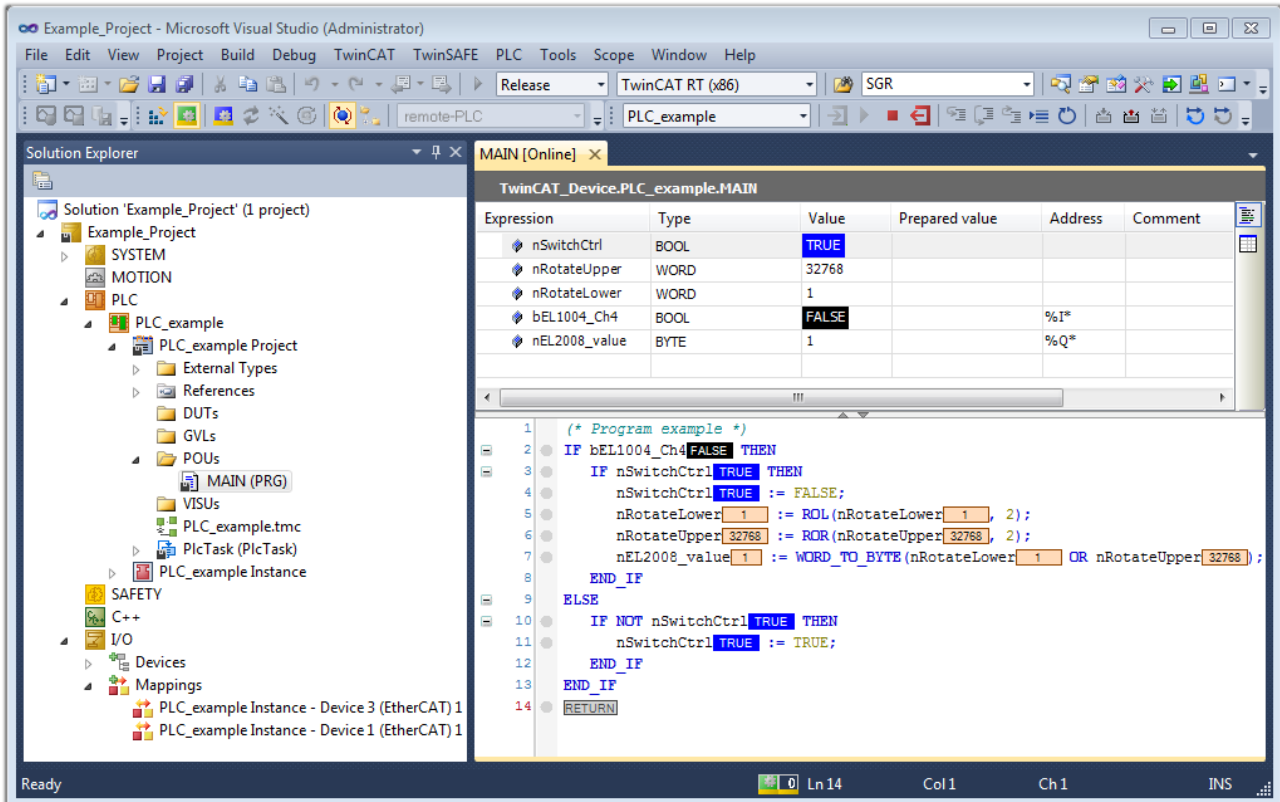



Fig. 80: TwinCAT 3 development environment (VS shell): logged-in, after program startup

The two operator control elements for stopping  and logout  result in the required action (also, “Shift + F5” can be used for stop, or both actions can be selected via the PLC menu).

13.2 TwinCAT Development Environment

The Software for automation TwinCAT (The Windows Control and Automation Technology) will be distinguished into:

- TwinCAT 2: System Manager (Configuration) & PLC Control (Programming)
- TwinCAT 3: Enhancement of TwinCAT 2 (Programming and Configuration takes place via a common Development Environment)

Details:

- **TwinCAT 2:**
 - Connects I/O devices to tasks in a variable-oriented manner
 - Connects tasks to tasks in a variable-oriented manner
 - Supports units at the bit level
 - Supports synchronous or asynchronous relationships
 - Exchange of consistent data areas and process images

- Datalink on NT - Programs by open Microsoft Standards (OLE, OCX, ActiveX, DCOM+, etc.)
- Integration of IEC 61131-3-Software-SPS, Software- NC and Software-CNC within Windows NT/2000/XP/Vista, Windows 7, NT/XP Embedded, CE
- Interconnection to all common fieldbusses
- More...

Additional features:

- **TwinCAT 3 (eXtended Automation):**
 - Visual Studio® integration
 - Choice of the programming language
 - Supports object orientated extension of IEC 61131-3
 - Usage of C/C++ as programming language for real time applications
 - Connection to MATLAB®/Simulink®
 - Open interface for expandability
 - Flexible run-time environment
 - Active support of multi-core- and 64 bit operating system
 - Automatic code generation and project creation with the TwinCAT Automation Interface
 - More...

Within the following sections commissioning of the TwinCAT Development Environment on a PC System for the control and also the basically functions of unique control elements will be explained.

Please see further information to TwinCAT 2 and TwinCAT 3 at <http://infosys.beckhoff.com>.

13.2.1 Installation of the TwinCAT real-time driver

In order to assign real-time capability to a standard Ethernet port of an IPC controller, the Beckhoff real-time driver has to be installed on this port under Windows.

This can be done in several ways.

A: Via the TwinCAT Adapter dialog

In the System Manager call up the TwinCAT overview of the local network interfaces via Options → Show Real Time Ethernet Compatible Devices.

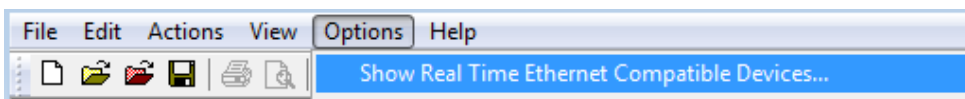

Fig. 81: System Manager "Options" (TwinCAT 2)

This have to be called up by the menu "TwinCAT" within the TwinCAT 3 environment:

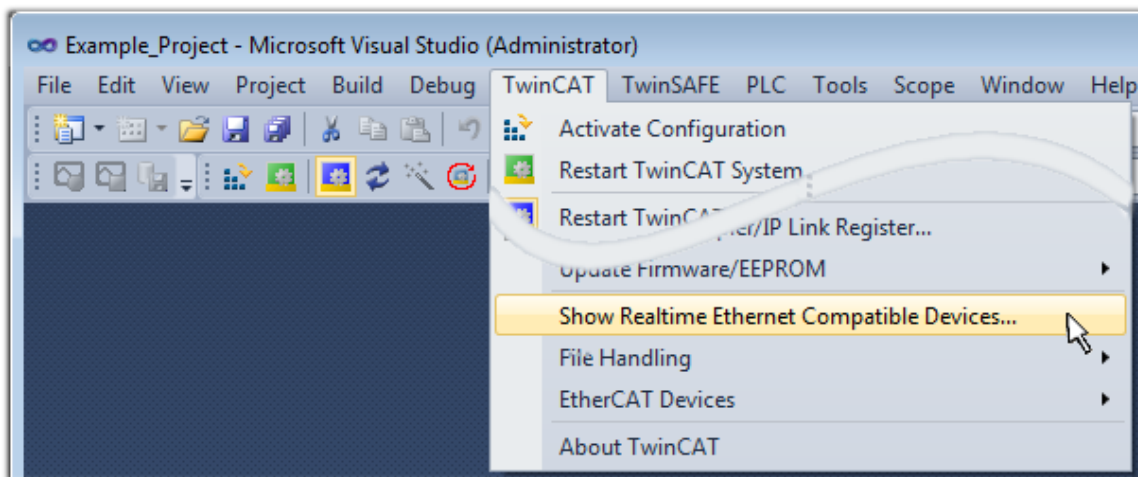

Fig. 82: Call up under VS Shell (TwinCAT 3)

B: Via TcRtelInstall.exe in the TwinCAT directory

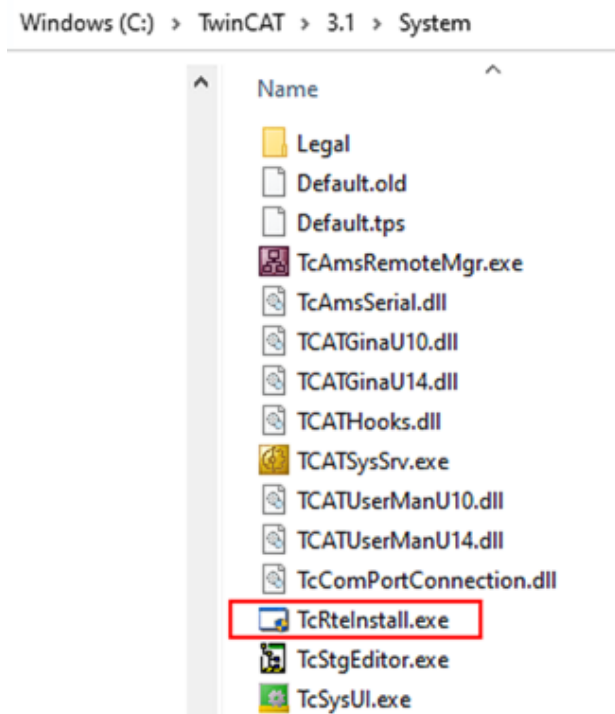

Fig. 83: TcRtelInstall in the TwinCAT directory

In both cases, the following dialog appears:

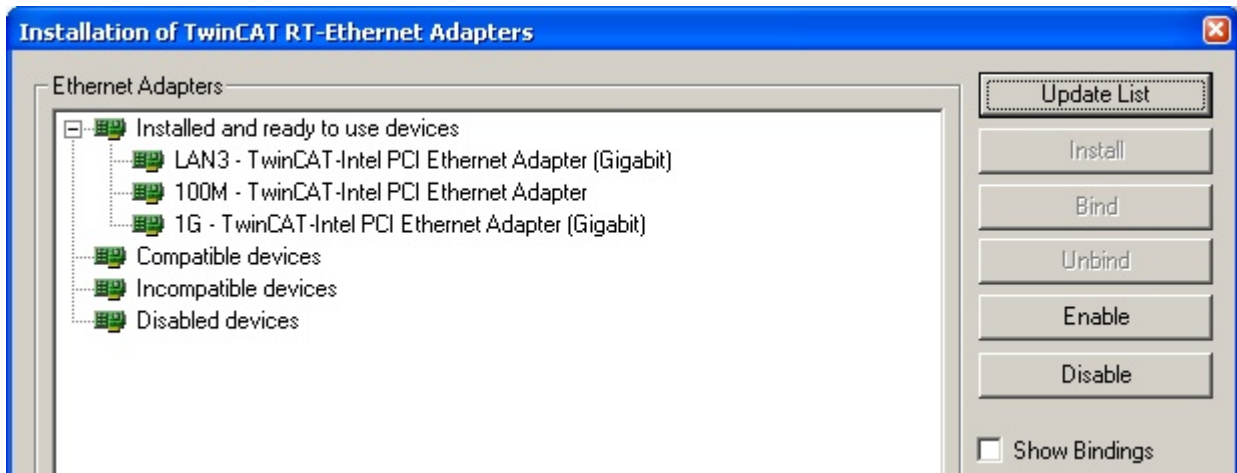

Fig. 84: Overview of network interfaces

Interfaces listed under “Compatible devices” can be assigned a driver via the “Install” button. A driver should only be installed on compatible devices.

A Windows warning regarding the unsigned driver can be ignored.

Alternatively an EtherCAT-device can be inserted first of all as described in chapter [Offline configuration creation](#), section “Creating the EtherCAT device” [▶ 112] in order to view the compatible ethernet ports via its EtherCAT properties (tab “Adapter”, button “Compatible Devices...”):



Fig. 85: EtherCAT device properties (TwinCAT 2): click on “Compatible Devices...” of tab “Adapter”

TwinCAT 3: the properties of the EtherCAT device can be opened by double click on “Device .. (EtherCAT)” within the Solution Explorer under “I/O”:

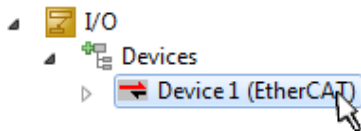

After the installation the driver appears activated in the Windows overview for the network interface (Windows Start → System Properties → Network)

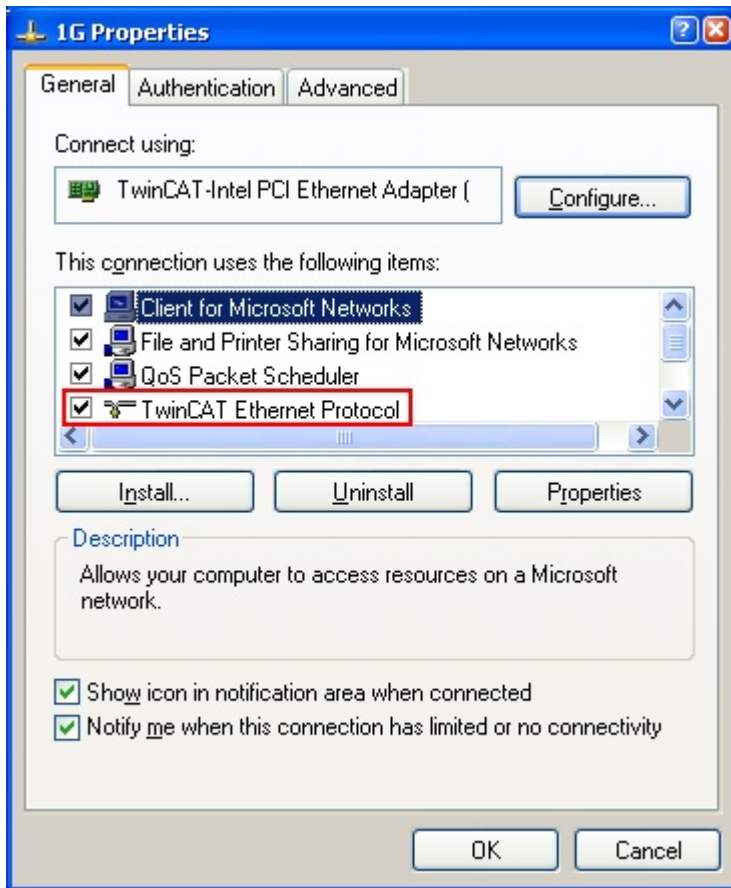

Fig. 86: Windows properties of the network interface

A correct setting of the driver could be:

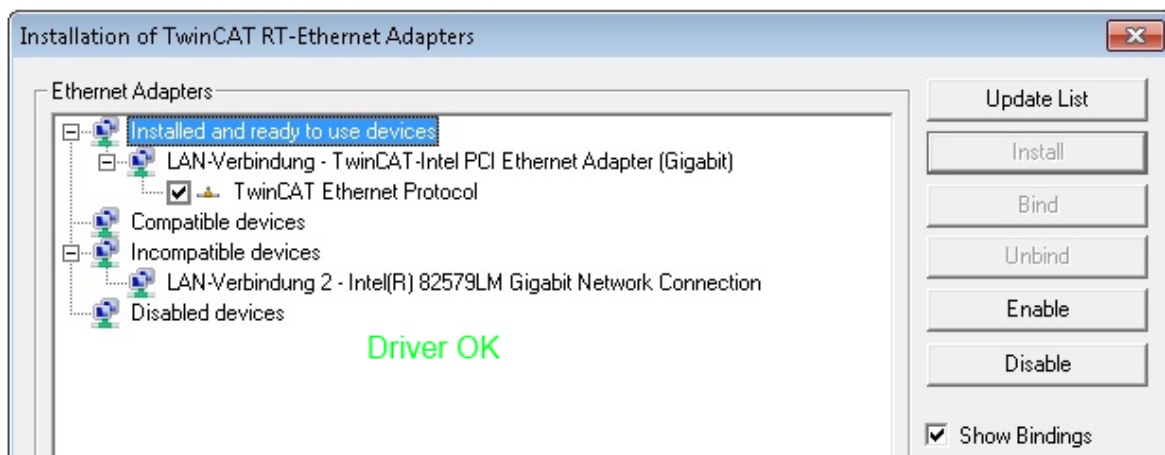

Fig. 87: Exemplary correct driver setting for the Ethernet port

Other possible settings have to be avoided:

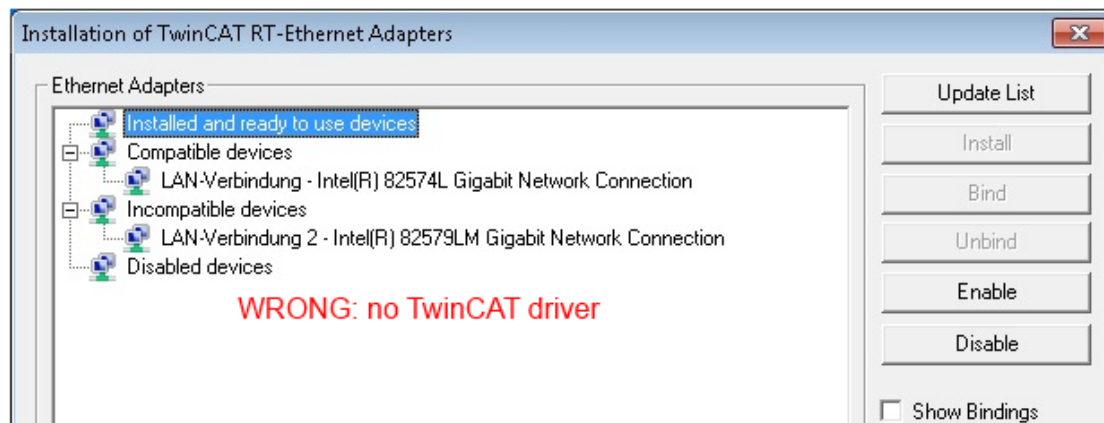
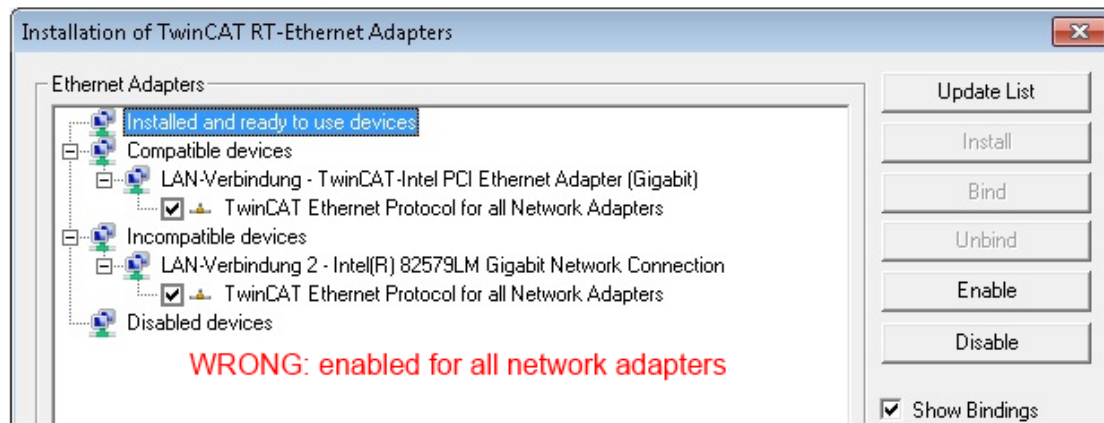
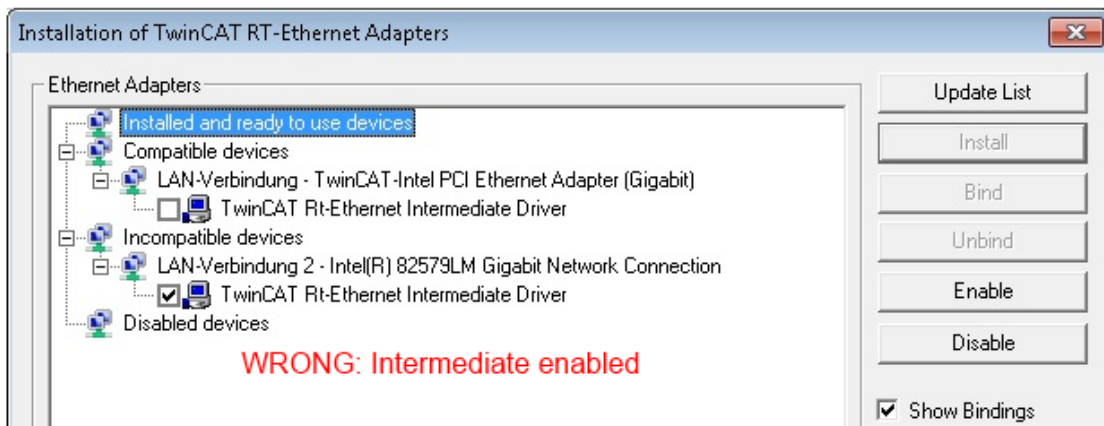
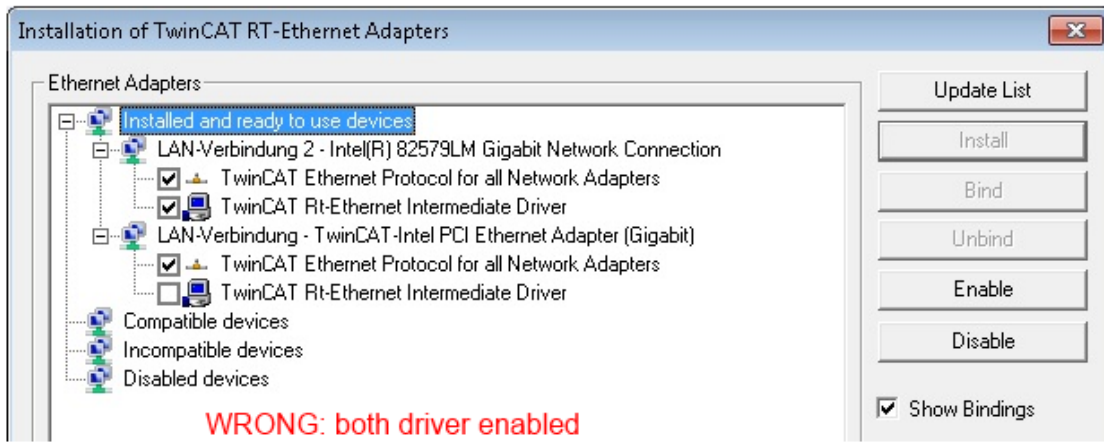

Fig. 88: Incorrect driver settings for the Ethernet port

IP address of the port used

i IP address/DHCP

In most cases an Ethernet port that is configured as an EtherCAT device will not transport general IP packets. For this reason and in cases where an EL6601 or similar devices are used it is useful to specify a fixed IP address for this port via the “Internet Protocol TCP/IP” driver setting and to disable DHCP. In this way the delay associated with the DHCP client for the Ethernet port assigning itself a default IP address in the absence of a DHCP server is avoided. A suitable address space is 192.168.x.x, for example.

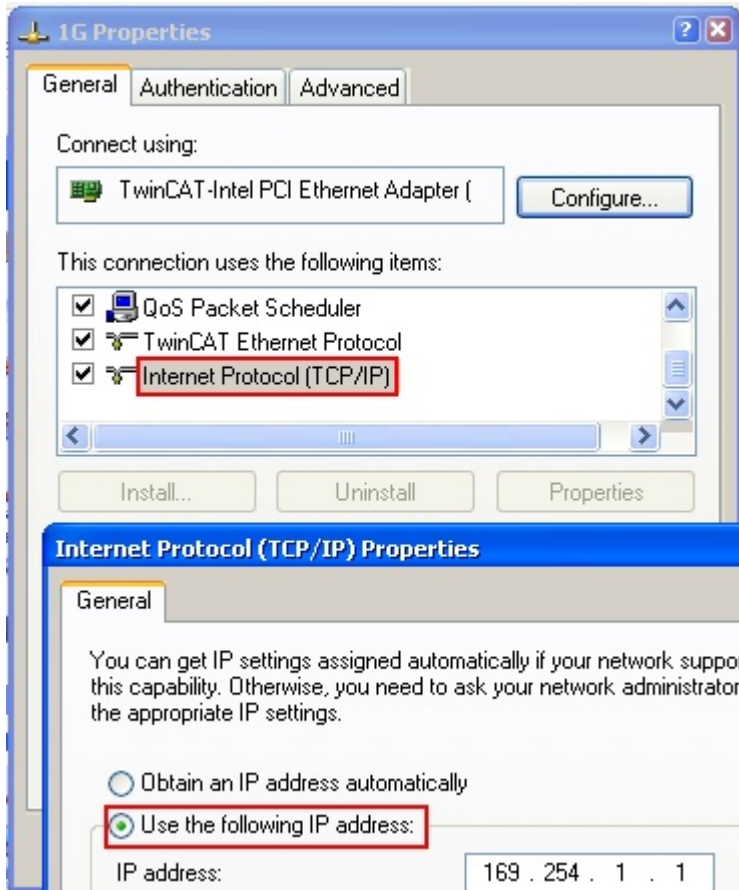

Fig. 89: TCP/IP setting for the Ethernet port

13.2.2 Notes regarding ESI device description

Installation of the latest ESI device description

The TwinCAT EtherCAT master/System Manager needs the device description files for the devices to be used in order to generate the configuration in online or offline mode. The device descriptions are contained in the so-called ESI files (EtherCAT Slave Information) in XML format. These files can be requested from the respective manufacturer and are made available for download. An *.xml file may contain several device descriptions.

The ESI files for Beckhoff EtherCAT devices are available on the [Beckhoff website](#).

The ESI files should be stored in the TwinCAT installation directory.

Default settings:

- **TwinCAT 2:** C:\TwinCAT\IO\EtherCAT
- **TwinCAT 3:** C:\TwinCAT\3.1\Config\Io\EtherCAT

The files are read (once) when a new System Manager window is opened, if they have changed since the last time the System Manager window was opened.

A TwinCAT installation includes the set of Beckhoff ESI files that was current at the time when the TwinCAT build was created.

For TwinCAT 2.11/TwinCAT 3 and higher, the ESI directory can be updated from the System Manager, if the programming PC is connected to the Internet; by

- **TwinCAT 2:** Option → “Update EtherCAT Device Descriptions”
- **TwinCAT 3:** TwinCAT → EtherCAT Devices → “Update Device Descriptions (via ETG Website)...”

The [TwinCAT ESI Updater \[▶ 111\]](#) is available for this purpose.



ESI

The *.xml files are associated with *.xsd files, which describe the structure of the ESI XML files. To update the ESI device descriptions, both file types should therefore be updated.

Device differentiation

EtherCAT devices/slaves are distinguished by four properties, which determine the full device identifier. For example, the device identifier EL2521-0025-1018 consists of:

- family key “EL”
- name “2521”
- type “0025”
- and revision “1018”

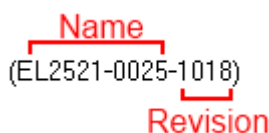

Fig. 90: Identifier structure

The order identifier consisting of name + type (here: EL2521-0025) describes the device function. The revision indicates the technical progress and is managed by Beckhoff. In principle, a device with a higher revision can replace a device with a lower revision, unless specified otherwise, e.g. in the documentation. Each revision has its own ESI description. See [further notes \[▶ 12\]](#).

Online description

If the EtherCAT configuration is created online through scanning of real devices (see section Online setup) and no ESI descriptions are available for a slave (specified by name and revision) that was found, the System Manager asks whether the description stored in the device should be used. In any case, the System Manager needs this information for setting up the cyclic and acyclic communication with the slave correctly.

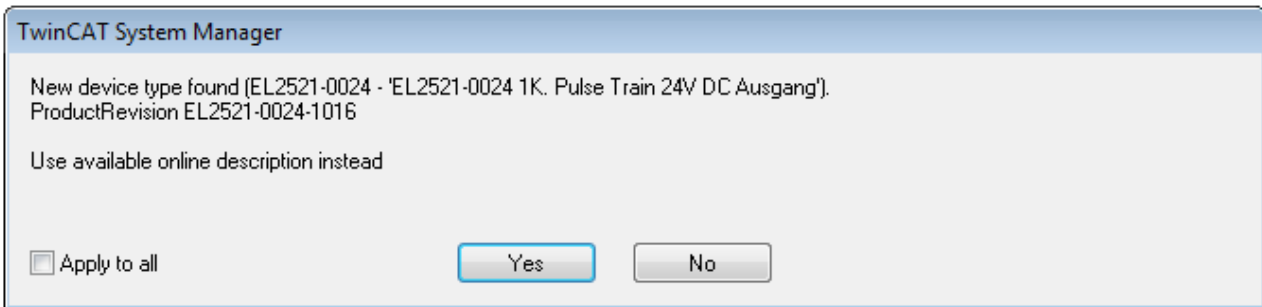

Fig. 91: OnlineDescription information window (TwinCAT 2)

In TwinCAT 3 a similar window appears, which also offers the Web update:

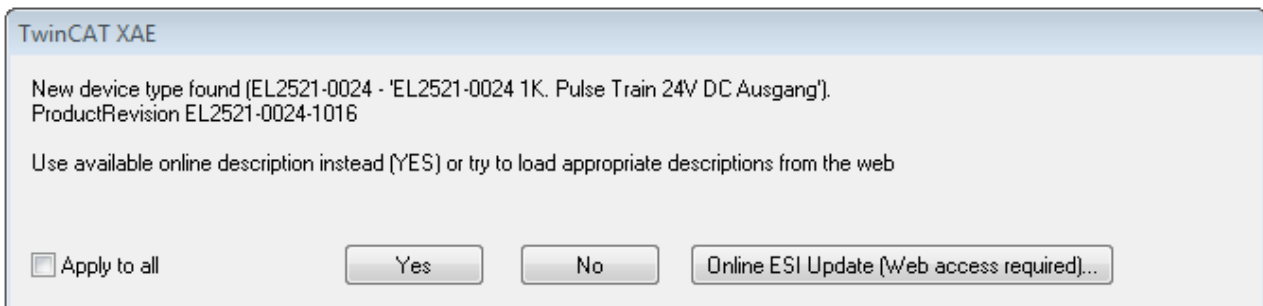

Fig. 92: Information window OnlineDescription (TwinCAT 3)

If possible, the Yes is to be rejected and the required ESI is to be requested from the device manufacturer. After installation of the XML/XSD file the configuration process should be repeated.

NOTICE

Changing the “usual” configuration through a scan

- ✓ If a scan discovers a device that is not yet known to TwinCAT, distinction has to be made between two cases. Taking the example here of the EL2521-0000 in the revision 1019
 - a) no ESI is present for the EL2521-0000 device at all, either for the revision 1019 or for an older revision. The ESI must then be requested from the manufacturer (in this case Beckhoff).
 - b) an ESI is present for the EL2521-0000 device, but only in an older revision, e.g. 1018 or 1017. In this case an in-house check should first be performed to determine whether the spare parts stock allows the integration of the increased revision into the configuration at all. A new/higher revision usually also brings along new features. If these are not to be used, work can continue without reservations with the previous revision 1018 in the configuration. This is also stated by the Beckhoff compatibility rule.

Refer in particular to the chapter “[General notes on the use of Beckhoff EtherCAT IO components](#)” and for manual configuration to the chapter “[Offline configuration creation \[► 112\]](#)”.

If the OnlineDescription is used regardless, the System Manager reads a copy of the device description from the EEPROM in the EtherCAT slave. In complex slaves the size of the EEPROM may not be sufficient for the complete ESI, in which case the ESI would be *incomplete* in the configurator. Therefore it's recommended using an offline ESI file with priority in such a case.

The System Manager creates for online recorded device descriptions a new file “OnlineDescription0000...xml” in its ESI directory, which contains all ESI descriptions that were read online.

OnlineDescriptionCache00000002.xml

Fig. 93: File OnlineDescription.xml created by the System Manager

If a slave desired to be added manually to the configuration at a later stage, online created slaves are indicated by a prepended symbol ">" in the selection list (see Figure *Indication of an online recorded ESI of EL2521 as an example*).

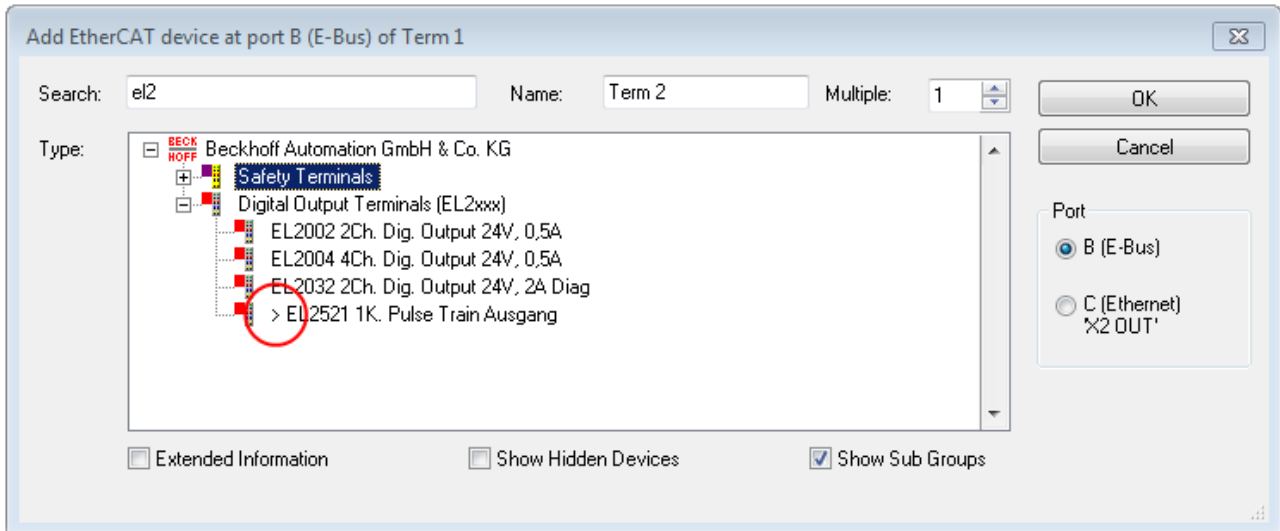

Fig. 94: Indication of an online recorded ESI of EL2521 as an example

If such ESI files are used and the manufacturer's files become available later, the file OnlineDescription.xml should be deleted as follows:

- close all System Manager windows
- restart TwinCAT in Config mode
- delete "OnlineDescription0000...xml"
- restart TwinCAT System Manager

This file should not be visible after this procedure, if necessary press <F5> to update

i OnlineDescription for TwinCAT 3.x

In addition to the file described above "OnlineDescription0000...xml", a so called EtherCAT cache with new discovered devices is created by TwinCAT 3.x, e.g. under Windows 7:

```
C:\User\[USERNAME]\AppData\Roaming\Beckhoff\TwinCAT3\Components\Base\EtherCATCache.xml
```

(Please note the language settings of the OS!)
You have to delete this file, too.

Faulty ESI file

If an ESI file is faulty and the System Manager is unable to read it, the System Manager brings up an information window.

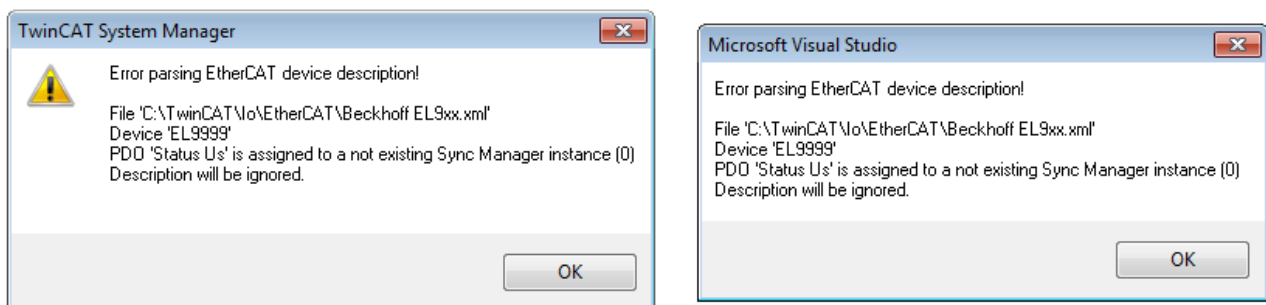

Fig. 95: Information window for faulty ESI file (left: TwinCAT 2; right: TwinCAT 3)

Reasons may include:

- Structure of the *.xml does not correspond to the associated *.xsd file → check your schematics
- Contents cannot be translated into a device description → contact the file manufacturer

13.2.3 TwinCAT ESI Updater

For TwinCAT 2.11 and higher, the System Manager can search for current Beckhoff ESI files automatically, if an online connection is available:

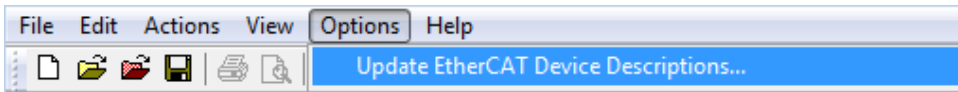

Fig. 96: Using the ESI Updater (>= TwinCAT 2.11)

The call up takes place under:
 “Options” → “Update EtherCAT Device Descriptions”

Selection under TwinCAT 3:

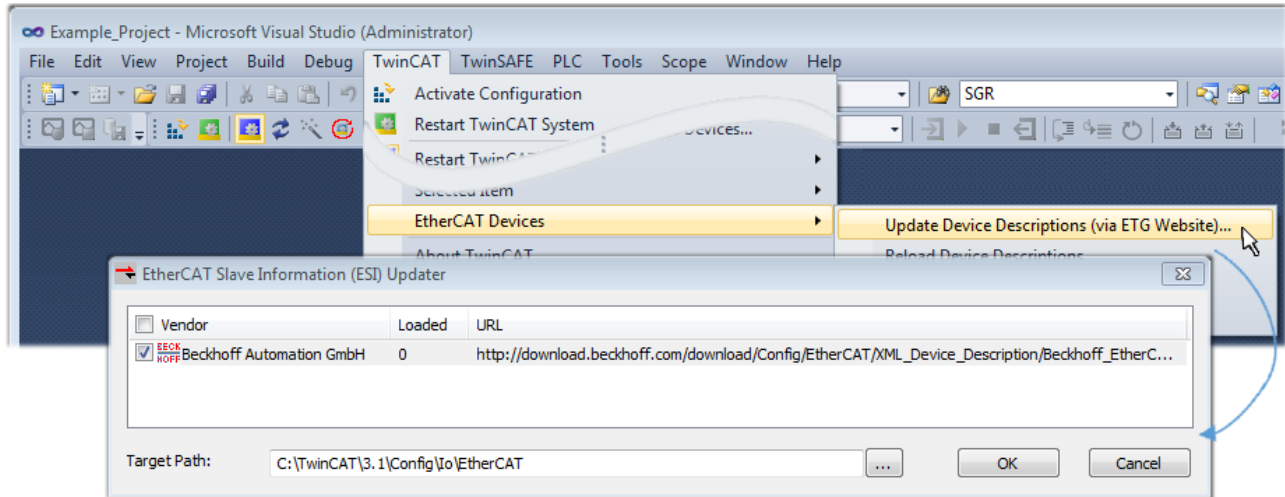

Fig. 97: Using the ESI Updater (TwinCAT 3)

The ESI Updater (TwinCAT 3) is a convenient option for automatic downloading of ESI data provided by EtherCAT manufacturers via the Internet into the TwinCAT directory (ESI = EtherCAT slave information). TwinCAT accesses the central ESI ULR directory list stored at ETG; the entries can then be viewed in the Updater dialog, although they cannot be changed there.

The call up takes place under:
 “TwinCAT” → “EtherCAT Devices” → “Update Device Description (via ETG Website)...”.

13.2.4 Distinction between Online and Offline

The distinction between online and offline refers to the presence of the actual I/O environment (drives, terminals, EJ-modules). If the configuration is to be prepared in advance of the system configuration as a programming system, e.g. on a laptop, this is only possible in “Offline configuration” mode. In this case all components have to be entered manually in the configuration, e.g. based on the electrical design.

If the designed control system is already connected to the EtherCAT system and all components are energised and the infrastructure is ready for operation, the TwinCAT configuration can simply be generated through “scanning” from the runtime system. This is referred to as online configuration.

In any case, during each startup the EtherCAT master checks whether the slaves it finds match the configuration. This test can be parameterised in the extended slave settings. Refer to [note “Installation of the latest ESI-XML device description” \[▶ 107\]](#).

For preparation of a configuration:

- the real EtherCAT hardware (devices, couplers, drives) must be present and installed
- the devices/modules must be connected via EtherCAT cables or in the terminal/ module strand in the same way as they are intended to be used later
- the devices/modules be connected to the power supply and ready for communication

- TwinCAT must be in CONFIG mode on the target system.

The online scan process consists of:

- [detecting the EtherCAT device \[▶ 117\]](#) (Ethernet port at the IPC)
- [detecting the connected EtherCAT devices \[▶ 118\]](#). This step can be carried out independent of the preceding step
- [troubleshooting \[▶ 121\]](#)

The [scan with existing configuration \[▶ 122\]](#) can also be carried out for comparison.

13.2.5 OFFLINE configuration creation

Creating the EtherCAT device

Create an EtherCAT device in an empty System Manager window.

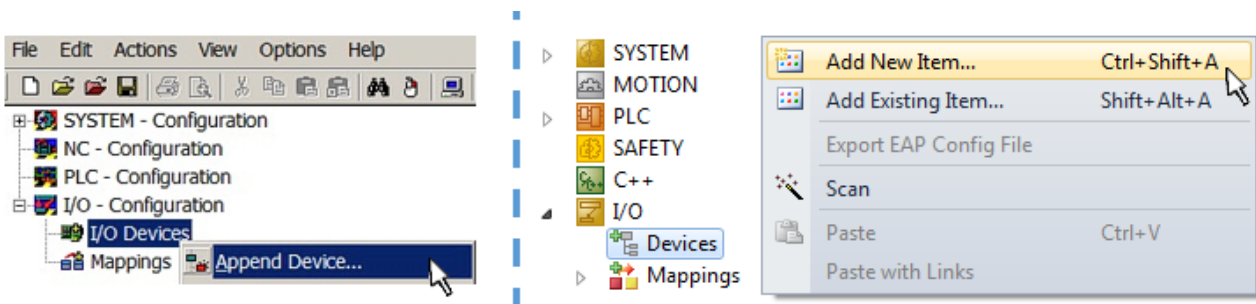

Fig. 98: Append EtherCAT device (left: TwinCAT 2; right: TwinCAT 3)

Select type “EtherCAT” for an EtherCAT I/O application with EtherCAT slaves. For the present publisher/ subscriber service in combination with an EL6601/EL6614 terminal select “EtherCAT Automation Protocol via EL6601”.

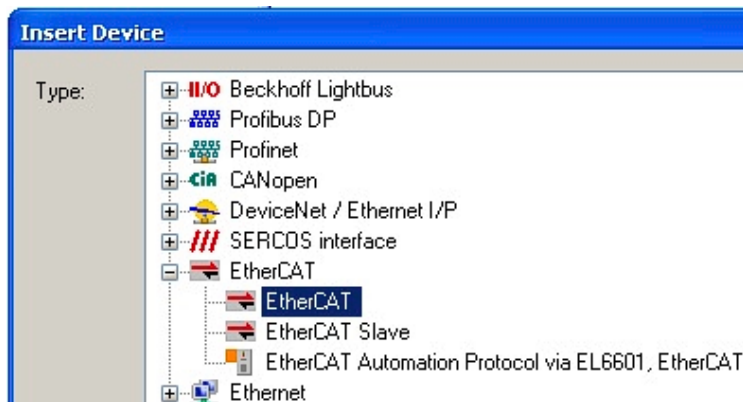

Fig. 99: Selecting the EtherCAT connection (TwinCAT 2.11, TwinCAT 3)

Then assign a real Ethernet port to this virtual device in the runtime system.

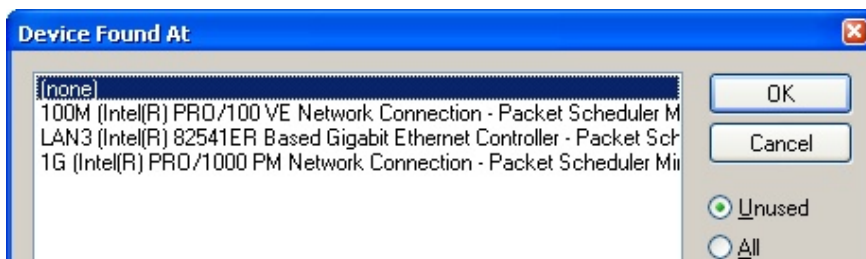

Fig. 100: Selecting the Ethernet port

This query may appear automatically when the EtherCAT device is created, or the assignment can be set/modified later in the properties dialog; see Fig. “EtherCAT device properties (TwinCAT 2)”.

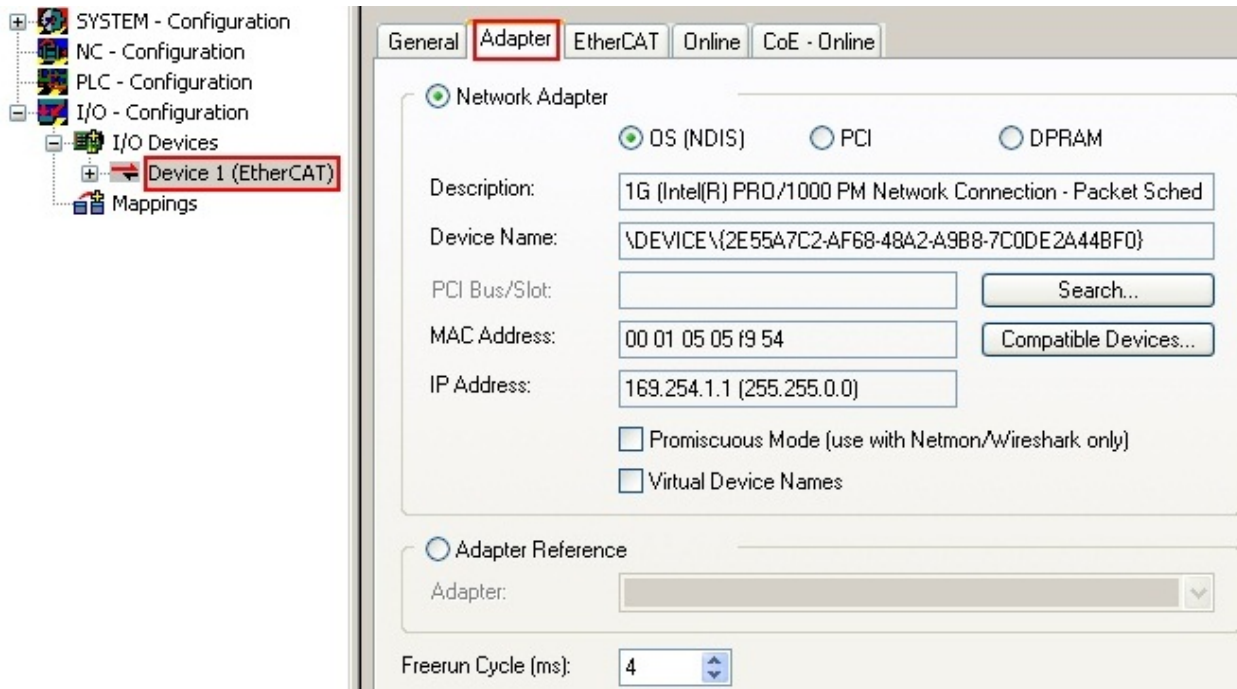
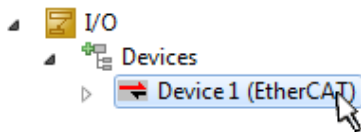

Fig. 101: EtherCAT device properties (TwinCAT 2)

TwinCAT 3: the properties of the EtherCAT device can be opened by double click on “Device .. (EtherCAT)” within the Solution Explorer under “I/O”:



i **Selecting the Ethernet port**

Ethernet ports can only be selected for EtherCAT devices for which the TwinCAT real-time driver is installed. This has to be done separately for each port. Please refer to the respective [installation page \[▶ 101\]](#).

Defining EtherCAT slaves

Further devices can be appended by right-clicking on a device in the configuration tree.

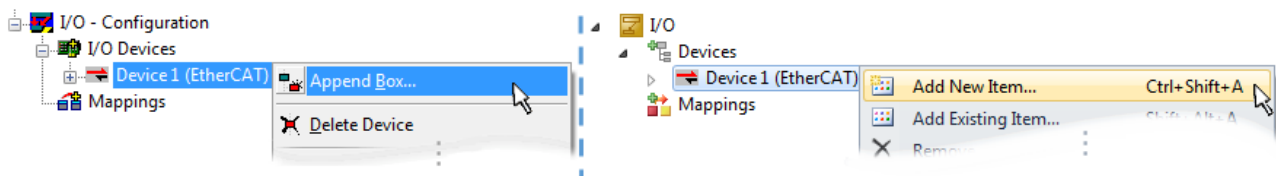

Fig. 102: Appending EtherCAT devices (left: TwinCAT 2; right: TwinCAT 3)

The dialog for selecting a new device opens. Only devices for which ESI files are available are displayed.

Only devices are offered for selection that can be appended to the previously selected device. Therefore, the physical layer available for this port is also displayed (Fig. “Selection dialog for new EtherCAT device”, A). In the case of cable-based Fast-Ethernet physical layer with PHY transfer, then also only cable-based devices are available, as shown in Fig. “Selection dialog for new EtherCAT device”. If the preceding device has several free ports (e.g. EK1122 or EK1100), the required port can be selected on the right-hand side (A).

Overview of physical layer

- “Ethernet”: cable-based 100BASE-TX: couplers, box modules, devices with RJ45/M8/M12 connector

- “E-Bus”: LVDS “terminal bus”, EtherCAT plug-in modules (EJ), EtherCAT terminals (EL/ES), various modular modules

The search field facilitates finding specific devices (since TwinCAT 2.11 or TwinCAT 3).

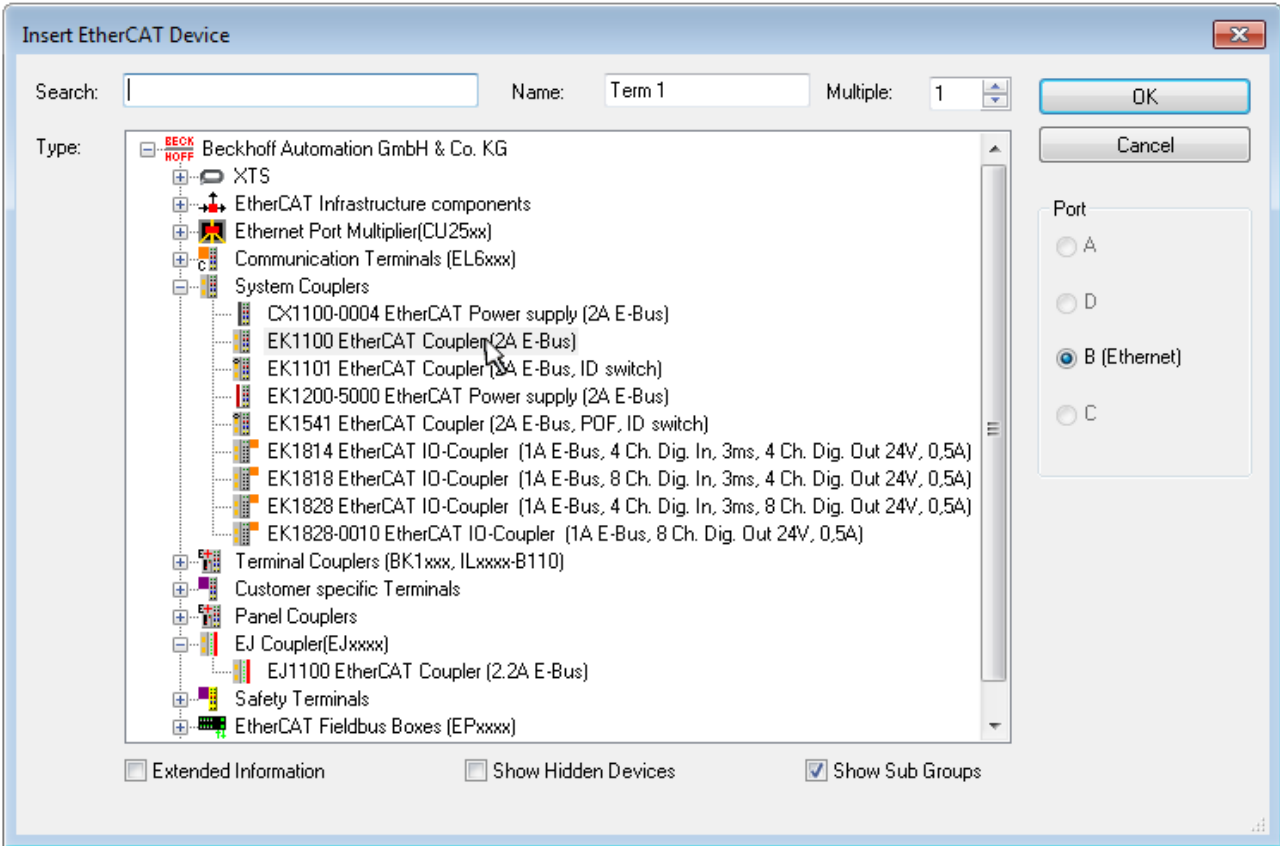

Fig. 103: Selection dialog for new EtherCAT device

By default, only the name/device type is used as selection criterion. For selecting a specific revision of the device, the revision can be displayed as “Extended Information”.

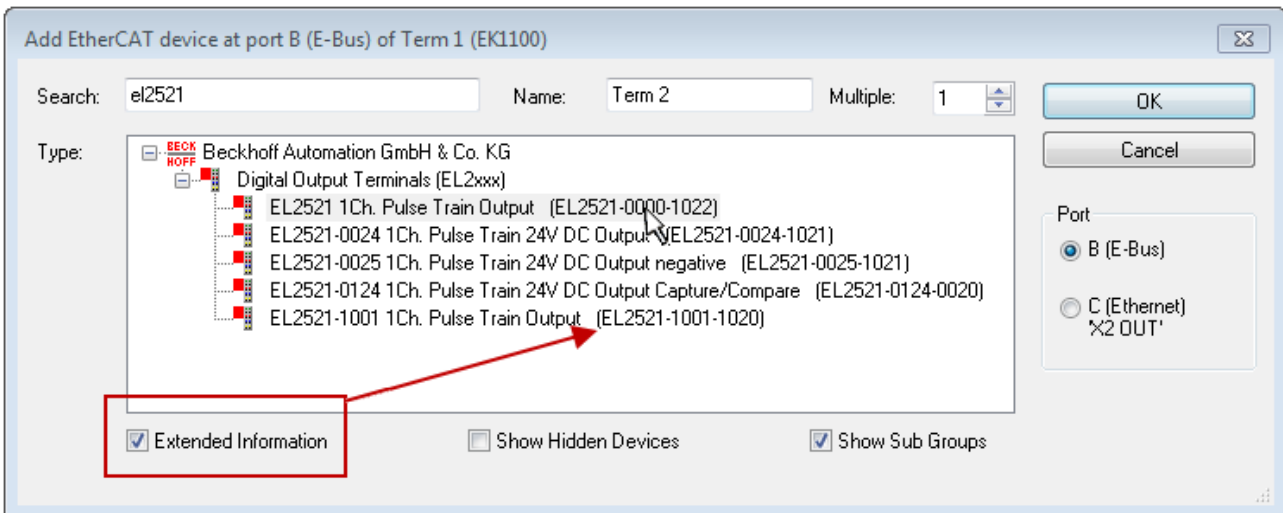

Fig. 104: Display of device revision

In many cases several device revisions were created for historic or functional reasons, e.g. through technological advancement. For simplification purposes (see Fig. “Selection dialog for new EtherCAT device”) only the last (i.e. highest) revision and therefore the latest state of production is displayed in the selection dialog for Beckhoff devices. To show all device revisions available in the system as ESI descriptions tick the “Show Hidden Devices” check box, see Fig. “Display of previous revisions”.

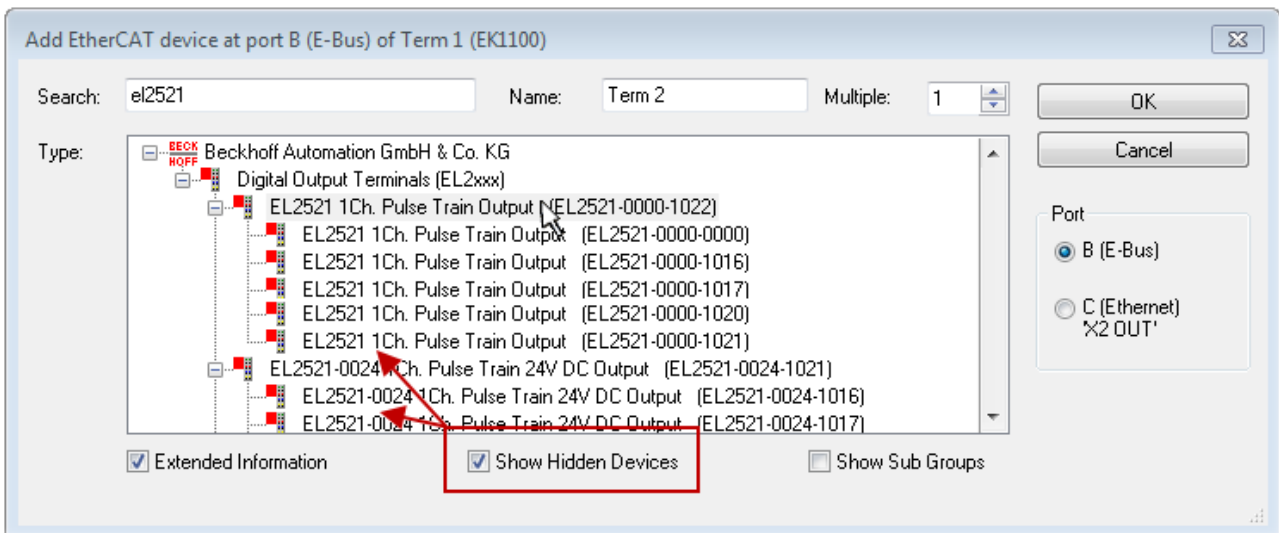

Fig. 105: Display of previous revisions

i Device selection based on revision, compatibility

The ESI description also defines the process image, the communication type between master and slave/device and the device functions, if applicable. The physical device (firmware, if available) has to support the communication queries/settings of the master. This is backward compatible, i.e. newer devices (higher revision) should be supported if the EtherCAT master addresses them as an older revision. The following compatibility rule of thumb is to be assumed for Beckhoff EtherCAT Terminals/ Boxes/ EJ-modules:

device revision in the system >= device revision in the configuration

This also enables subsequent replacement of devices without changing the configuration (different specifications are possible for drives).

Example

If an EL2521-0025-1018 is specified in the configuration, an EL2521-0025-1018 or higher (-1019, -1020) can be used in practice.

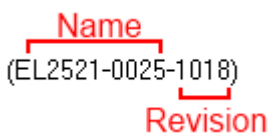

Fig. 106: Name/revision of the terminal

If current ESI descriptions are available in the TwinCAT system, the last revision offered in the selection dialog matches the Beckhoff state of production. It is recommended to use the last device revision when creating a new configuration, if current Beckhoff devices are used in the real application. Older revisions should only be used if older devices from stock are to be used in the application.

In this case the process image of the device is shown in the configuration tree and can be parameterized as follows: linking with the task, CoE/DC settings, plug-in definition, startup settings, ...

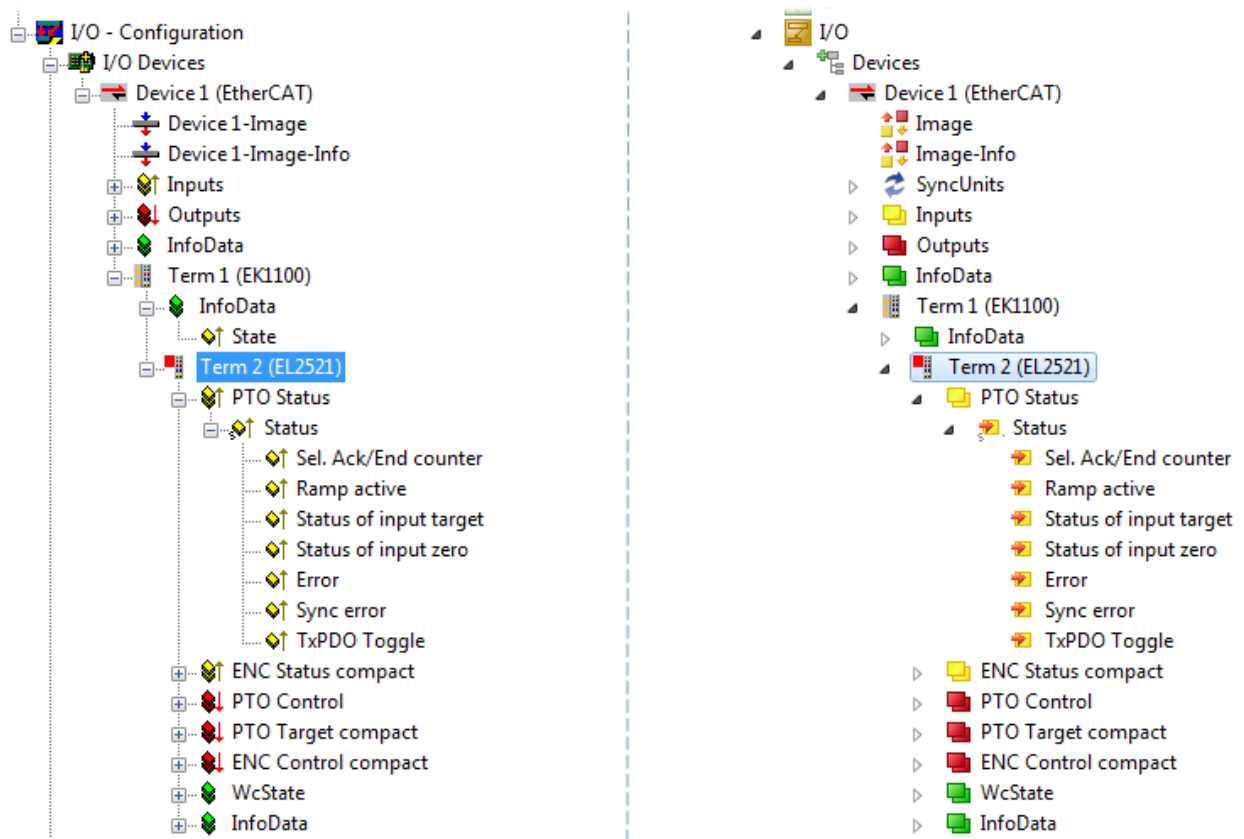



Fig. 107: EtherCAT terminal in the TwinCAT tree (left: TwinCAT 2; right: TwinCAT 3)



13.2.6 ONLINE configuration creation

Detecting/scanning of the EtherCAT device

The online device search can be used if the TwinCAT system is in CONFIG mode. This can be indicated by a symbol right below in the information bar:



- on TwinCAT 2 by a blue display “Config Mode” within the System Manager window:  .
- on TwinCAT 3 within the user interface of the development environment by a symbol  .

TwinCAT can be set into this mode:

- TwinCAT 2: by selection of  in the Menubar or by “Actions” → “Set/Reset TwinCAT to Config Mode...”
- TwinCAT 3: by selection of  in the Menubar or by “TwinCAT” → “Restart TwinCAT (Config Mode)”

● Online scanning in Config mode

i The online search is not available in RUN mode (production operation). Note the differentiation between TwinCAT programming system and TwinCAT target system.

The TwinCAT 2 icon () or TwinCAT 3 icon () within the Windows-Taskbar always shows the TwinCAT mode of the local IPC. Compared to that, the System Manager window of TwinCAT 2 or the user interface of TwinCAT 3 indicates the state of the target system.

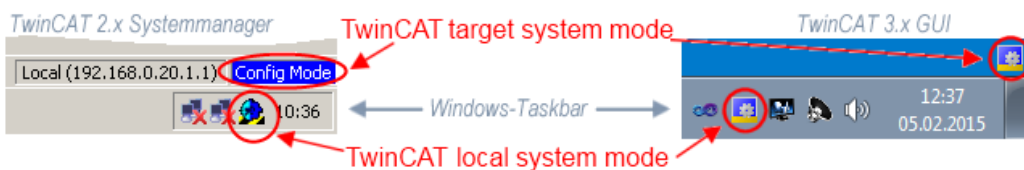

Fig. 108: Differentiation local/target system (left: TwinCAT 2; right: TwinCAT 3)

Right-clicking on “I/O Devices” in the configuration tree opens the search dialog.

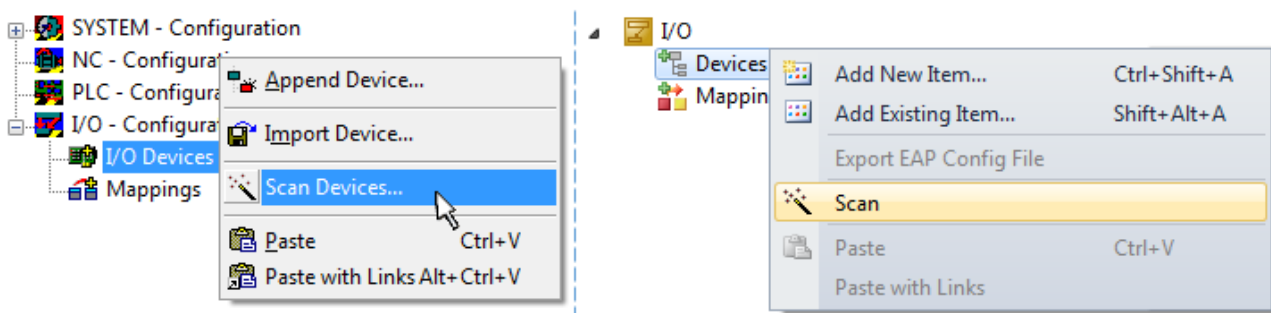

Fig. 109: Scan Devices (left: TwinCAT 2; right: TwinCAT 3)

This scan mode attempts to find not only EtherCAT devices (or Ethernet ports that are usable as such), but also NOVDRAM, fieldbus cards, SMB etc. However, not all devices can be found automatically.

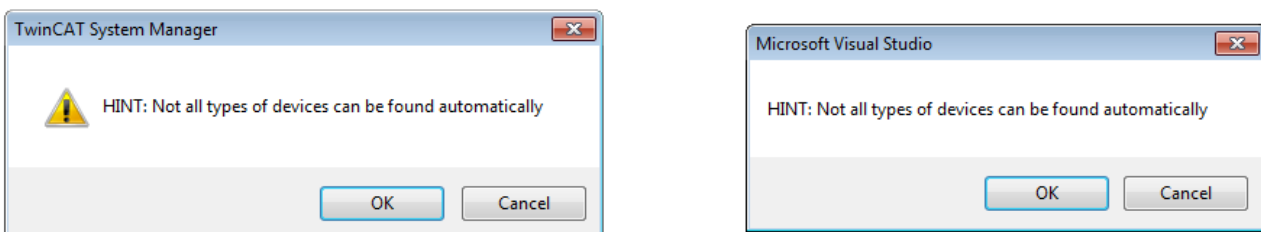

Fig. 110: Note for automatic device scan (left: TwinCAT 2; right: TwinCAT 3)

Ethernet ports with installed TwinCAT real-time driver are shown as “RT Ethernet” devices. An EtherCAT frame is sent to these ports for testing purposes. If the scan agent detects from the response that an EtherCAT slave is connected, the port is immediately shown as an “EtherCAT Device” .

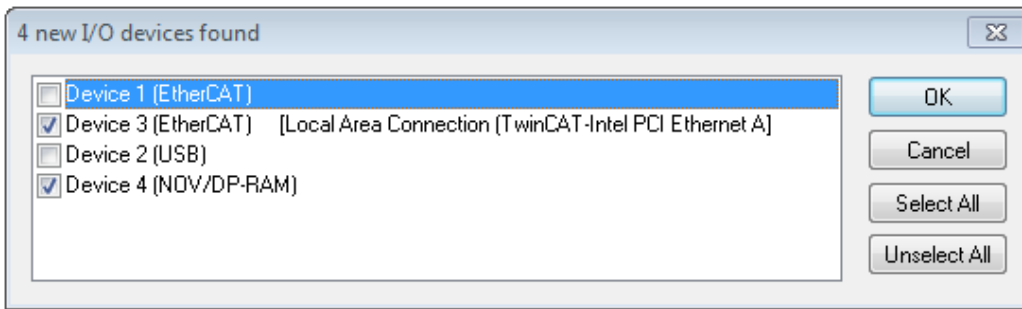

Fig. 111: Detected Ethernet devices

Via respective checkboxes devices can be selected (as illustrated in Fig. “Detected Ethernet devices” e.g. Device 3 and Device 4 were chosen). After confirmation with “OK” a device scan is suggested for all selected devices, see Fig.: “Scan query after automatic creation of an EtherCAT device”.

● Selecting the Ethernet port



Ethernet ports can only be selected for EtherCAT devices for which the TwinCAT real-time driver is installed. This has to be done separately for each port. Please refer to the respective [installation page](#) [▶ 101].

Detecting/Scanning the EtherCAT devices

● Online scan functionality



During a scan the master queries the identity information of the EtherCAT slaves from the slave EEPROM. The name and revision are used for determining the type. The respective devices are located in the stored ESI data and integrated in the configuration tree in the default state defined there.

Name
(EL2521-0025-1018)
Revision

Fig. 112: Example default state

NOTICE

Slave scanning in practice in series machine production

The scanning function should be used with care. It is a practical and fast tool for creating an initial configuration as a basis for commissioning. In series machine production or reproduction of the plant, however, the function should no longer be used for the creation of the configuration, but if necessary for [comparison](#) [▶ 122] with the defined initial configuration. Background: since Beckhoff occasionally increases the revision version of the delivered products for product maintenance reasons, a configuration can be created by such a scan which (with an identical machine construction) is identical according to the device list; however, the respective device revision may differ from the initial configuration.

Example:

Company A builds the prototype of a machine B, which is to be produced in series later on. To do this the prototype is built, a scan of the IO devices is performed in TwinCAT and the initial configuration “B.tsm” is created. The EL2521-0025 EtherCAT terminal with the revision 1018 is located somewhere. It is thus built into the TwinCAT configuration in this way:

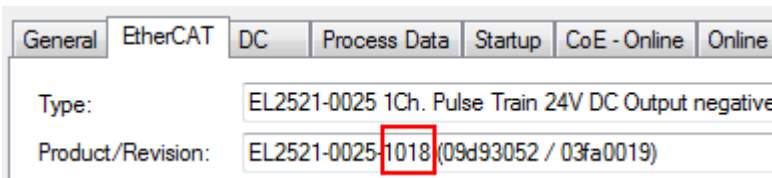

Fig. 113: Installing EthetCAT terminal with revision -1018

Likewise, during the prototype test phase, the functions and properties of this terminal are tested by the programmers/commissioning engineers and used if necessary, i.e. addressed from the PLC “B.pro” or the NC. (the same applies correspondingly to the TwinCAT 3 solution files).

The prototype development is now completed and series production of machine B starts, for which Beckhoff continues to supply the EL2521-0025-0018. If the commissioning engineers of the series machine production department always carry out a scan, a B configuration with the identical contents results again for each machine. Likewise, A might create spare parts stores worldwide for the coming series-produced machines with EL2521-0025-1018 terminals.

After some time Beckhoff extends the EL2521-0025 by a new feature C. Therefore the FW is changed, outwardly recognizable by a higher FW version and a **new revision -1019**. Nevertheless the new device naturally supports functions and interfaces of the predecessor version(s); an adaptation of “B.tsm” or even “B.pro” is therefore unnecessary. The series-produced machines can continue to be built with “B.tsm” and “B.pro”; it makes sense to perform a comparative scan [► 122] against the initial configuration “B.tsm” in order to check the built machine.

However, if the series machine production department now doesn't use “B.tsm”, but instead carries out a scan to create the productive configuration, the revision **-1019** is automatically detected and built into the configuration:

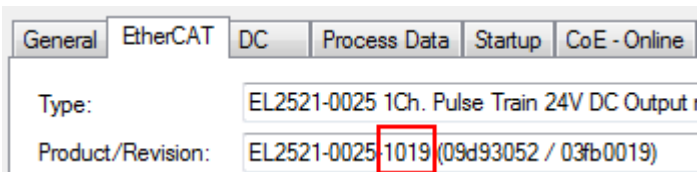

Fig. 114: Detection of EtherCAT terminal with revision -1019

This is usually not noticed by the commissioning engineers. TwinCAT cannot signal anything either, since a new configuration is essentially created. According to the compatibility rule, however, this means that no EL2521-0025-**1018** should be built into this machine as a spare part (even if this nevertheless works in the vast majority of cases).

In addition, it could be the case that, due to the development accompanying production in company A, the new feature C of the EL2521-0025-1019 (for example, an improved analog filter or an additional process data for the diagnosis) is discovered and used without in-house consultation. The previous stock of spare part devices are then no longer to be used for the new configuration “B2.tsm” created in this way. If series machine production is established, the scan should only be performed for informative purposes for comparison with a defined initial configuration. Changes are to be made with care!

If an EtherCAT device was created in the configuration (manually or through a scan), the I/O field can be scanned for devices/slaves.



Fig. 115: Scan query after automatic creation of an EtherCAT device (left: TwinCAT 2; right: TwinCAT 3)

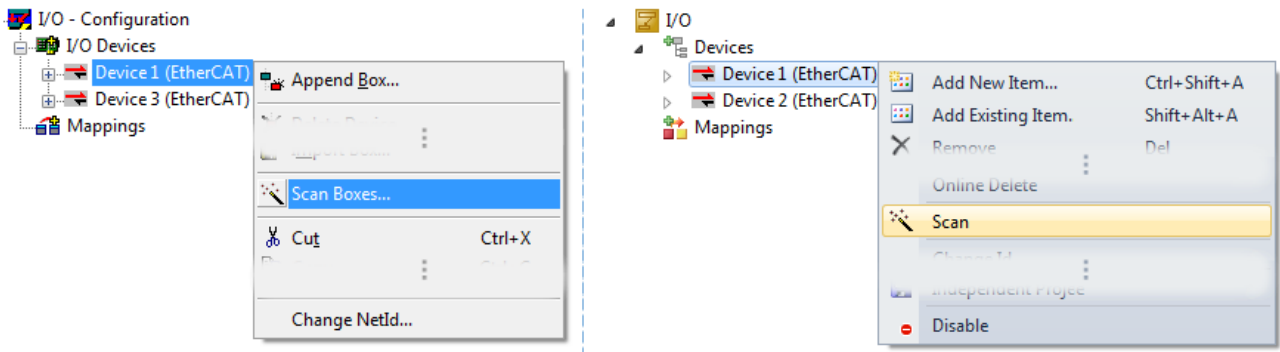

Fig. 116: Manual scanning for devices on a specified EtherCAT device (left: TwinCAT 2; right: TwinCAT 3)

In the System Manager (TwinCAT 2) or the User Interface (TwinCAT 3) the scan process can be monitored via the progress bar at the bottom in the status bar.



Fig. 117: Scan progress example by TwinCAT 2

The configuration is established and can then be switched to online state (OPERATIONAL).



Fig. 118: Config/FreeRun query (left: TwinCAT 2; right: TwinCAT 3)

In Config/FreeRun mode the System Manager display alternates between blue and red, and the EtherCAT device continues to operate with the idling cycle time of 4 ms (default setting), even without active task (NC, PLC).



Fig. 119: Displaying of “Free Run” and “Config Mode” toggling right below in the status bar



Fig. 120: TwinCAT can also be switched to this state by using a button (left: TwinCAT 2; right: TwinCAT 3)

The EtherCAT system should then be in a functional cyclic state, as shown in Fig. *Online display example*.

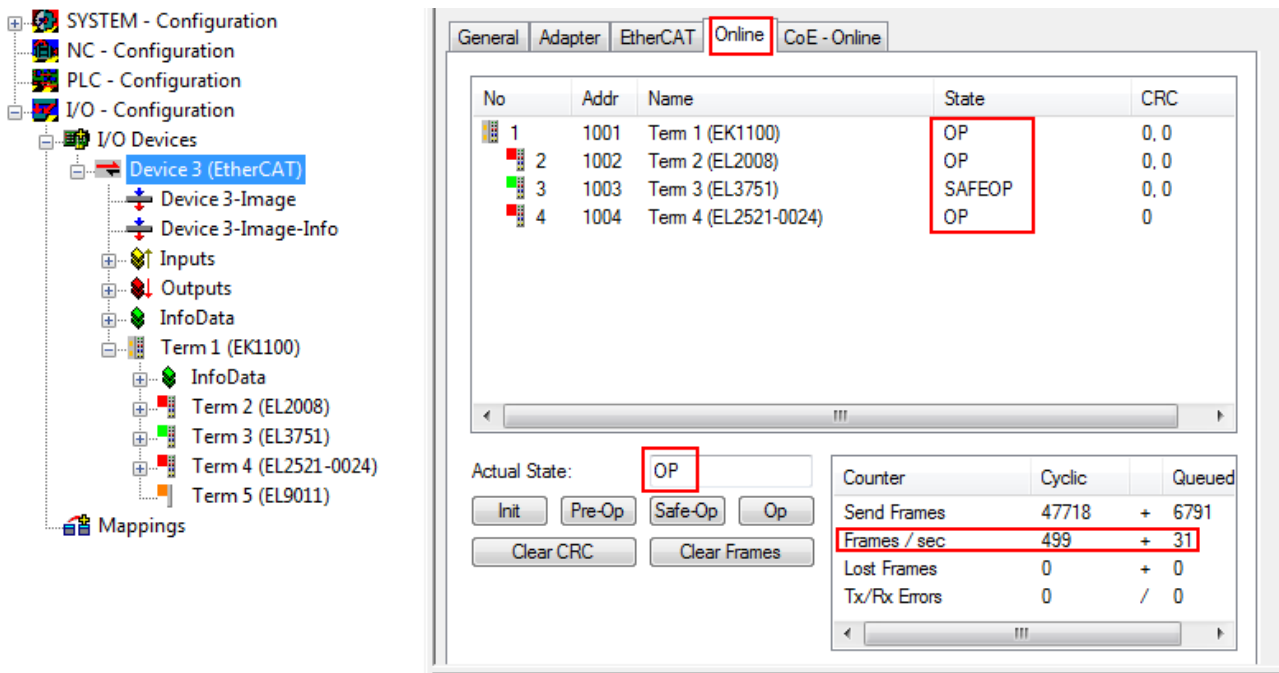

Fig. 121: Online display example

Please note:

- all slaves should be in OP state
- the EtherCAT master should be in “Actual State” OP
- “frames/sec” should match the cycle time taking into account the sent number of frames
- no excessive “LostFrames” or CRC errors should occur

The configuration is now complete. It can be modified as described under [manual procedure \[► 112\]](#).

Troubleshooting

Various effects may occur during scanning.

- An **unknown device** is detected, i.e. an EtherCAT slave for which no ESI XML description is available. In this case the System Manager offers to read any ESI that may be stored in the device. This case is described in the chapter “Notes regarding ESI device description”.
- **Device are not detected properly**
Possible reasons include:
 - faulty data links, resulting in data loss during the scan
 - slave has invalid device description

The connections and devices should be checked in a targeted manner, e.g. via the emergency scan. Then re-run the scan.

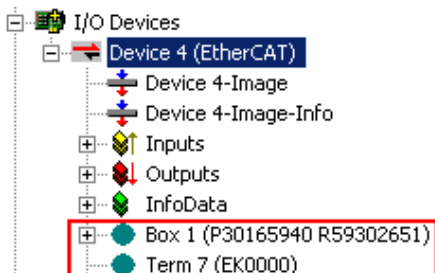

Fig. 122: Faulty identification

In the System Manager such devices may be set up as EK0000 or unknown devices. Operation is not possible or meaningful.

Scan over existing Configuration

NOTICE

Change of the configuration after comparison

With this scan (TwinCAT 2.11 or 3.1) only the device properties vendor (manufacturer), device name and revision are compared at present! A “ChangeTo” or “Copy” should only be carried out with care, taking into consideration the Beckhoff IO compatibility rule (see above). The device configuration is then replaced by the revision found; this can affect the supported process data and functions.

If a scan is initiated for an existing configuration, the actual I/O environment may match the configuration exactly or it may differ. This enables the configuration to be compared.



Fig. 123: Identical configuration (left: TwinCAT 2; right: TwinCAT 3)

If differences are detected, they are shown in the correction dialog, so that the user can modify the configuration as required.

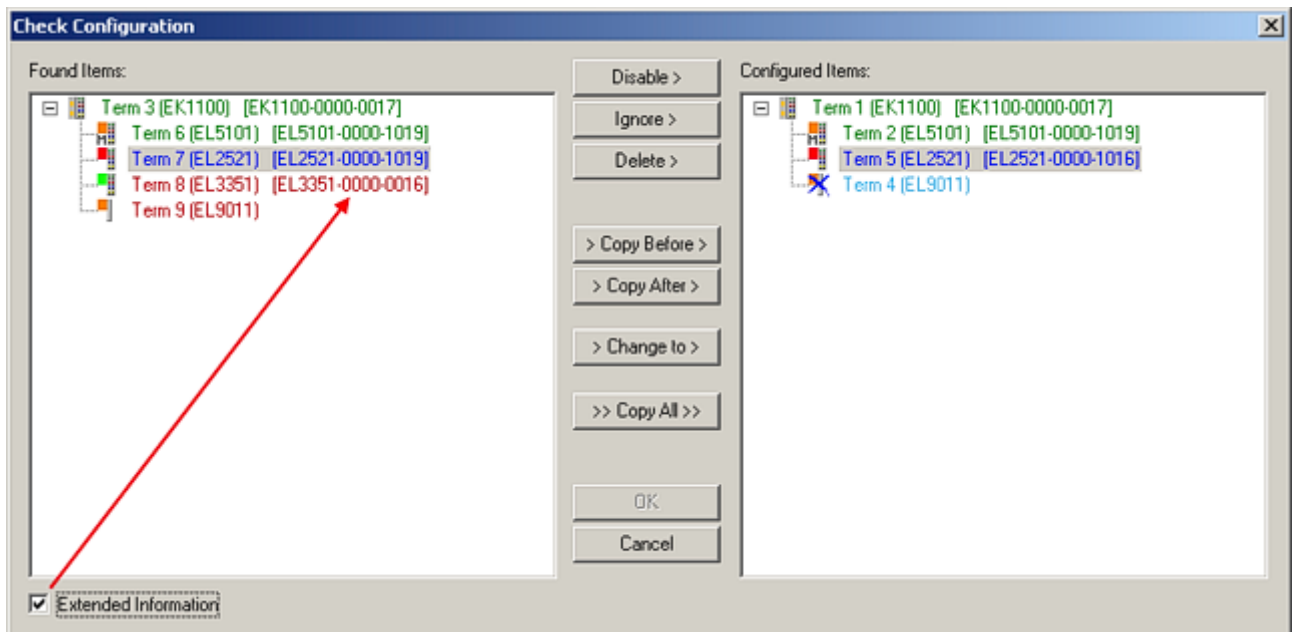

Fig. 124: Correction dialog

It is advisable to tick the “Extended Information” check box to reveal differences in the revision.

Color	Explanation
green	This EtherCAT slave matches the entry on the other side. Both type and revision match.
blue	This EtherCAT slave is present on the other side, but in a different revision. This other revision can have other default values for the process data as well as other/additional functions. If the found revision is higher than the configured revision, the slave may be used provided compatibility issues are taken into account. If the found revision is lower than the configured revision, it is likely that the slave cannot be used. The found device may not support all functions that the master expects based on the higher revision number.
light blue	This EtherCAT slave is ignored ("Ignore" button)
red	<ul style="list-style-type: none"> This EtherCAT slave is not present on the other side. It is present, but in a different revision, which also differs in its properties from the one specified. The compatibility principle then also applies here: if the found revision is higher than the configured revision, use is possible provided compatibility issues are taken into account, since the successor devices should support the functions of the predecessor devices. If the found revision is lower than the configured revision, it is likely that the slave cannot be used. The found device may not support all functions that the master expects based on the higher revision number.

i Device selection based on revision, compatibility

The ESI description also defines the process image, the communication type between master and slave/device and the device functions, if applicable. The physical device (firmware, if available) has to support the communication queries/settings of the master. This is backward compatible, i.e. newer devices (higher revision) should be supported if the EtherCAT master addresses them as an older revision. The following compatibility rule of thumb is to be assumed for Beckhoff EtherCAT Terminals/ Boxes/ EJ-modules:

device revision in the system >= device revision in the configuration

This also enables subsequent replacement of devices without changing the configuration (different specifications are possible for drives).

Example

If an EL2521-0025-**1018** is specified in the configuration, an EL2521-0025-**1018** or higher (**-1019, -1020**) can be used in practice.

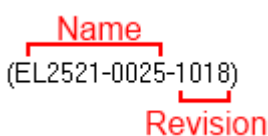

Fig. 125: Name/revision of the terminal

If current ESI descriptions are available in the TwinCAT system, the last revision offered in the selection dialog matches the Beckhoff state of production. It is recommended to use the last device revision when creating a new configuration, if current Beckhoff devices are used in the real application. Older revisions should only be used if older devices from stock are to be used in the application.

In this case the process image of the device is shown in the configuration tree and can be parameterized as follows: linking with the task, CoE/DC settings, plug-in definition, startup settings, ...

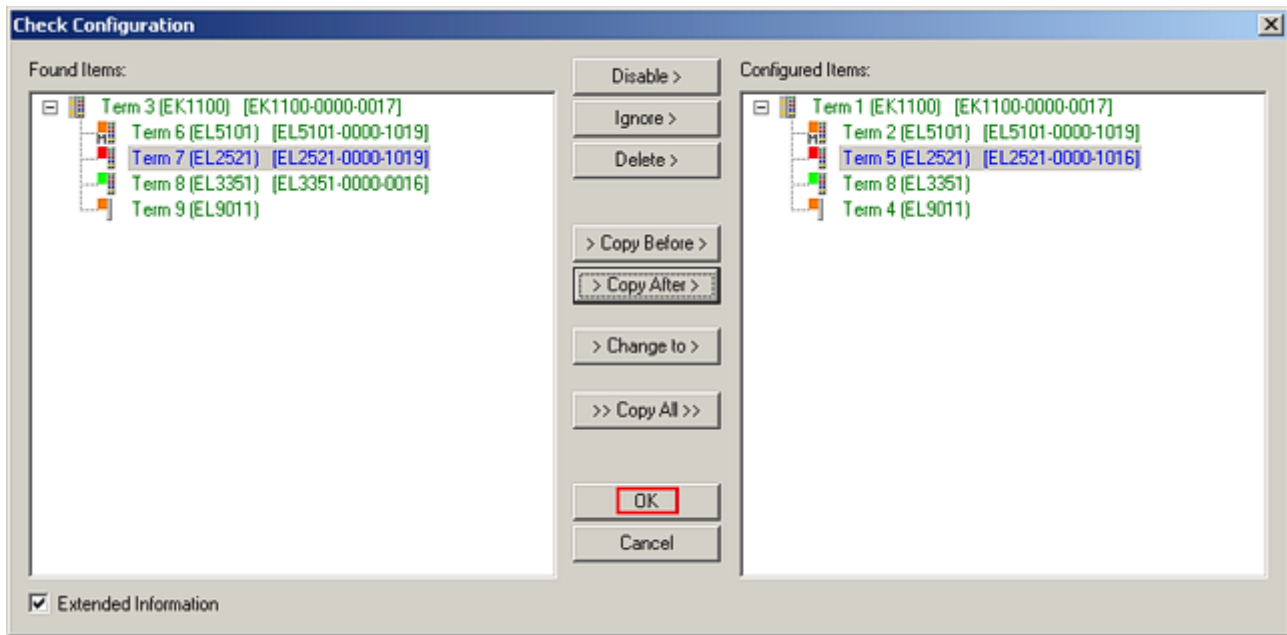

Fig. 126: Correction dialog with modifications

Once all modifications have been saved or accepted, click “OK” to transfer them to the real *.tsm configuration.

Change to Compatible Type

TwinCAT offers a function *Change to Compatible Type...* for the exchange of a device whilst retaining the links in the task.

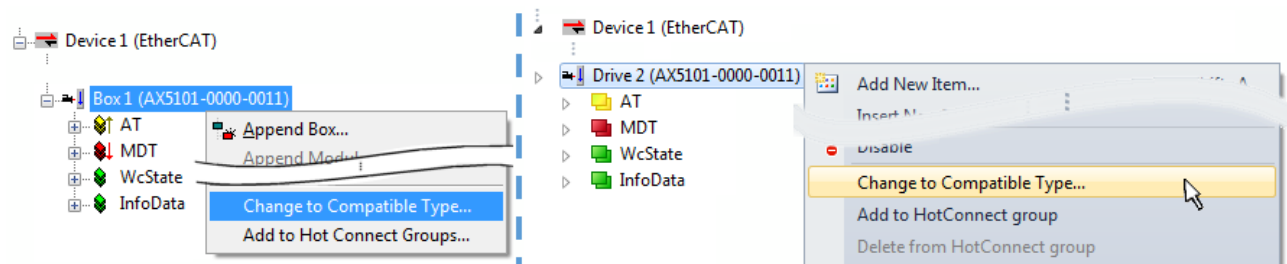

Fig. 127: Dialog “Change to Compatible Type...” (left: TwinCAT 2; right: TwinCAT 3)

The following elements in the ESI of an EtherCAT device are compared by TwinCAT and assumed to be the same in order to decide whether a device is indicated as “compatible”:

- Physics (e.g. RJ45, Ebus...)
- FMMU (additional ones are allowed)
- SyncManager (SM, additional ones are allowed)
- EoE (attributes MAC, IP)
- CoE (attributes SdoInfo, PdoAssign, PdoConfig, PdoUpload, CompleteAccess)
- FoE
- PDO (process data: Sequence, SyncUnit SU, SyncManager SM, EntryCount, Entry.Datatype)

This function is preferably to be used on AX5000 devices.

Change to Alternative Type

The TwinCAT System Manager offers a function for the exchange of a device: Change to Alternative Type

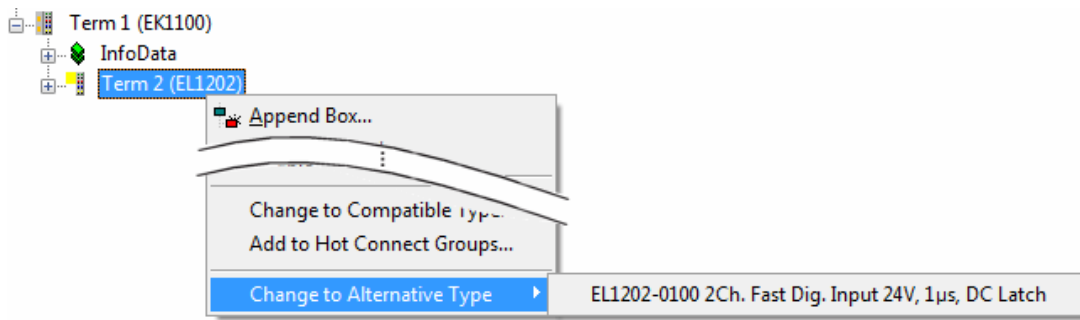

Fig. 128: TwinCAT 2 Dialog Change to Alternative Type

If called, the System Manager searches in the procured device ESI (in this example: EL1202-0000) for details of compatible devices contained there. The configuration is changed and the ESI-EEPROM is overwritten at the same time – therefore this process is possible only in the online state (ConfigMode).

13.2.7 EtherCAT subscriber configuration

In the left-hand window of the TwinCAT 2 System Manager or the Solution Explorer of the TwinCAT 3 Development Environment respectively, click on the element of the terminal within the tree you wish to configure (in the example: EL3751 Terminal 3).

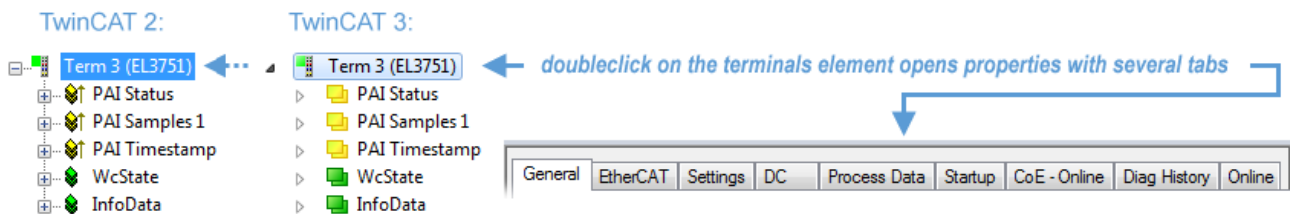

Fig. 129: Branch element as terminal EL3751

In the right-hand window of the TwinCAT System Manager (TwinCAT 2) or the Development Environment (TwinCAT 3), various tabs are now available for configuring the terminal. And yet the dimension of complexity of a subscriber determines which tabs are provided. Thus as illustrated in the example above the terminal EL3751 provides many setup options and also a respective number of tabs are available. On the contrary by the terminal EL1004 for example the tabs “General”, “EtherCAT”, “Process Data” and “Online” are available only. Several terminals, as for instance the EL6695 provide special functions by a tab with its own terminal name, so “EL6695” in this case. A specific tab “Settings” by terminals with a wide range of setup options will be provided also (e.g. EL3751).

“General” tab

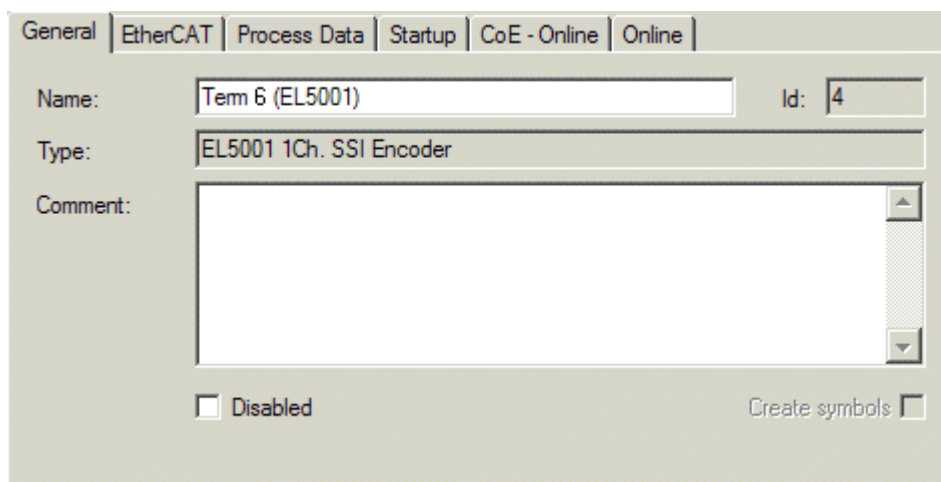

Fig. 130: “General” tab

Name	Name of the EtherCAT device
Id	Number of the EtherCAT device
Type	EtherCAT device type
Comment	Here you can add a comment (e.g. regarding the system).
Disabled	Here you can deactivate the EtherCAT device.
Create symbols	Access to this EtherCAT slave via ADS is only available if this control box is activated.

“EtherCAT” tab

Fig. 131: “EtherCAT” tab

Type	EtherCAT device type
Product/Revision	Product and revision number of the EtherCAT device
Auto Inc Addr.	Auto increment address of the EtherCAT device. The auto increment address can be used for addressing each EtherCAT device in the communication ring through its physical position. Auto increment addressing is used during the start-up phase when the EtherCAT master allocates addresses to the EtherCAT devices. With auto increment addressing the first EtherCAT slave in the ring has the address 0000 _{hex} . For each further slave the address is decremented by 1 (FFFF _{hex} , FFFE _{hex} etc.).
EtherCAT Addr.	Fixed address of an EtherCAT slave. This address is allocated by the EtherCAT master during the start-up phase. Tick the control box to the left of the input field in order to modify the default value.
Previous Port	Name and port of the EtherCAT device to which this device is connected. If it is possible to connect this device with another one without changing the order of the EtherCAT devices in the communication ring, then this combination field is activated and the EtherCAT device to which this device is to be connected can be selected.
Advanced Settings	This button opens the dialogs for advanced settings.

The link at the bottom of the tab points to the product page for this EtherCAT device on the web.

“Process Data” tab

Indicates the configuration of the process data. The input and output data of the EtherCAT slave are represented as CANopen process data objects (**Process Data Objects**, PDOs). The user can select a PDO via PDO assignment and modify the content of the individual PDO via this dialog, if the EtherCAT slave supports this function.

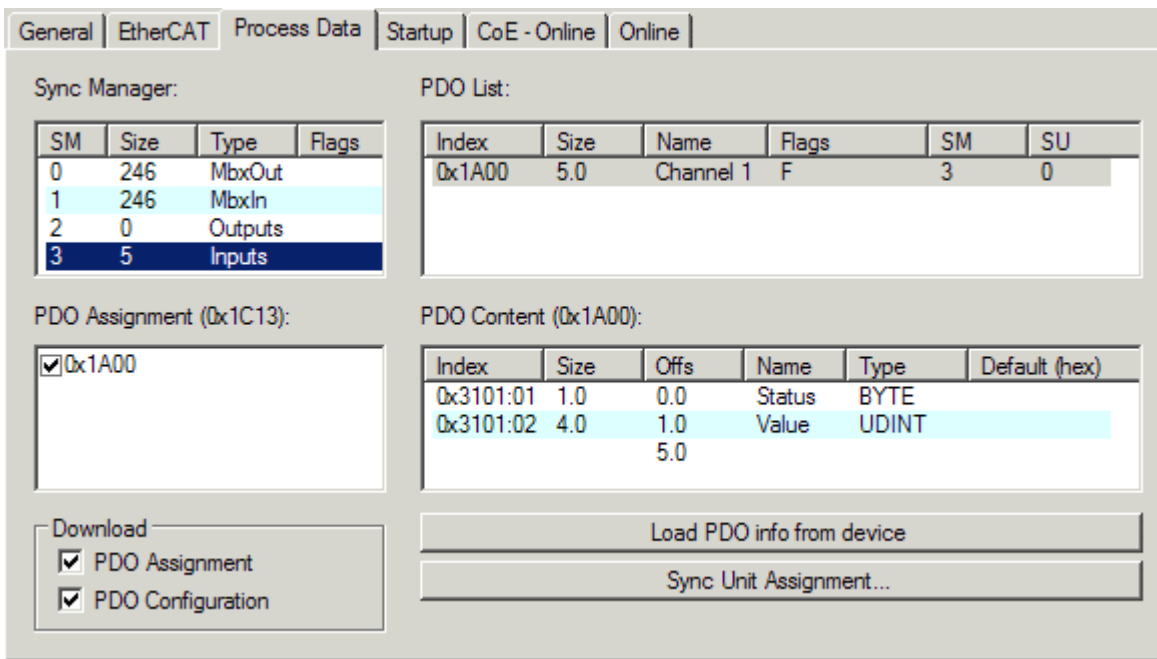

Fig. 132: "Process Data" tab

The process data (PDOs) transferred by an EtherCAT slave during each cycle are user data which the application expects to be updated cyclically or which are sent to the slave. To this end the EtherCAT master (Beckhoff TwinCAT) parameterizes each EtherCAT slave during the start-up phase to define which process data (size in bits/bytes, source location, transmission type) it wants to transfer to or from this slave. Incorrect configuration can prevent successful start-up of the slave.

For Beckhoff EtherCAT EL, ES, EM, EJ and EP slaves the following applies in general:

- The input/output process data supported by the device are defined by the manufacturer in the ESI/XML description. The TwinCAT EtherCAT Master uses the ESI description to configure the slave correctly.
- The process data can be modified in the System Manager. See the device documentation. Examples of modifications include: mask out a channel, displaying additional cyclic information, 16-bit display instead of 8-bit data size, etc.
- In so-called "intelligent" EtherCAT devices the process data information is also stored in the CoE directory. Any changes in the CoE directory that lead to different PDO settings prevent successful startup of the slave. It is not advisable to deviate from the designated process data, because the device firmware (if available) is adapted to these PDO combinations.

If the device documentation allows modification of process data, proceed as follows (see Figure *Configuring the process data*).

- A: select the device to configure
- B: in the "Process Data" tab select Input or Output under SyncManager (C)
- D: the PDOs can be selected or deselected
- H: the new process data are visible as linkable variables in the System Manager
The new process data are active once the configuration has been activated and TwinCAT has been restarted (or the EtherCAT master has been restarted)
- E: if a slave supports this, Input and Output PDO can be modified simultaneously by selecting a so-called PDO record ("predefined PDO settings").

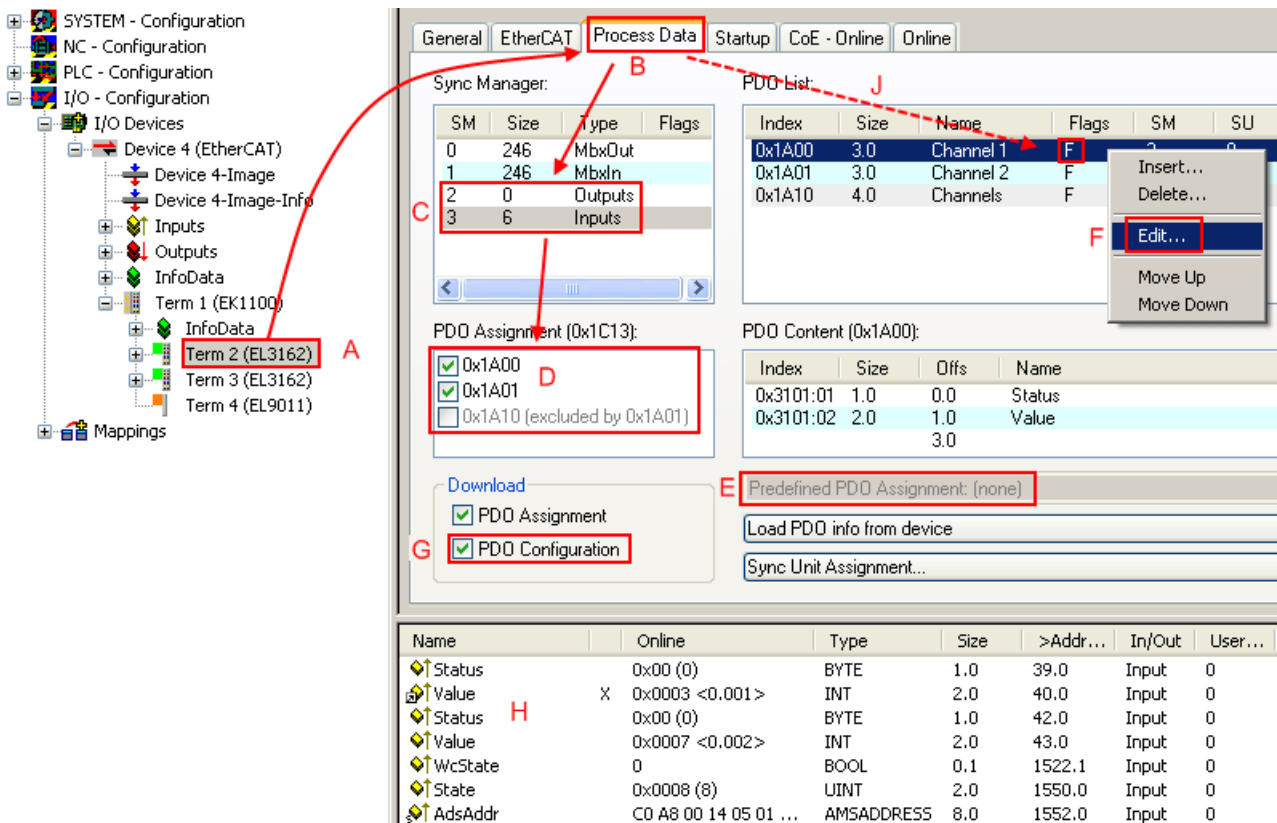

Fig. 133: Configuring the process data

i Manual modification of the process data

According to the ESI description, a PDO can be identified as “fixed” with the flag “F” in the PDO overview (Fig. *Configuring the process data*, J). The configuration of such PDOs cannot be changed, even if TwinCAT offers the associated dialog (“Edit”). In particular, CoE content cannot be displayed as cyclic process data. This generally also applies in cases where a device supports download of the PDO configuration, “G”. In case of incorrect configuration the EtherCAT slave usually refuses to start and change to OP state. The System Manager displays an “invalid SM cfg” logger message: This error message (“invalid SM IN cfg” or “invalid SM OUT cfg”) also indicates the reason for the failed start.

A detailed description [► 133] can be found at the end of this section.

“Startup” tab

The *Startup* tab is displayed if the EtherCAT slave has a mailbox and supports the *CANopen over EtherCAT* (CoE) or *Servo drive over EtherCAT* protocol. This tab indicates which download requests are sent to the mailbox during startup. It is also possible to add new mailbox requests to the list display. The download requests are sent to the slave in the same order as they are shown in the list.

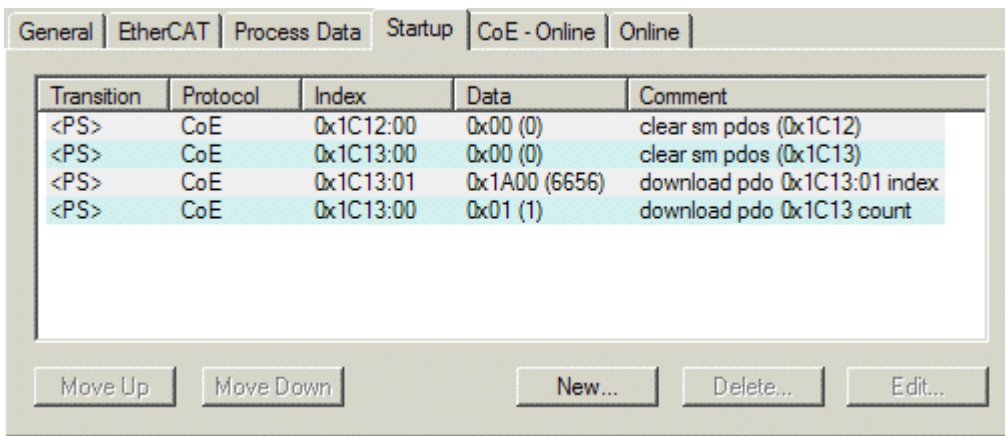

Fig. 134: "Startup" tab

Column	Description
Transition	Transition to which the request is sent. This can either be <ul style="list-style-type: none"> the transition from pre-operational to safe-operational (PS), or the transition from safe-operational to operational (SO). If the transition is enclosed in "<>" (e.g. <PS>), the mailbox request is fixed and cannot be modified or deleted by the user.
Protocol	Type of mailbox protocol
Index	Index of the object
Data	Date on which this object is to be downloaded.
Comment	Description of the request to be sent to the mailbox

- Move Up** This button moves the selected request up by one position in the list.
- Move Down** This button moves the selected request down by one position in the list.
- New** This button adds a new mailbox download request to be sent during startup.
- Delete** This button deletes the selected entry.
- Edit** This button edits an existing request.

"CoE - Online" tab

The additional *CoE - Online* tab is displayed if the EtherCAT slave supports the *CANopen over EtherCAT* (CoE) protocol. This dialog lists the content of the object list of the slave (SDO upload) and enables the user to modify the content of an object from this list. Details for the objects of the individual EtherCAT devices can be found in the device-specific object descriptions.

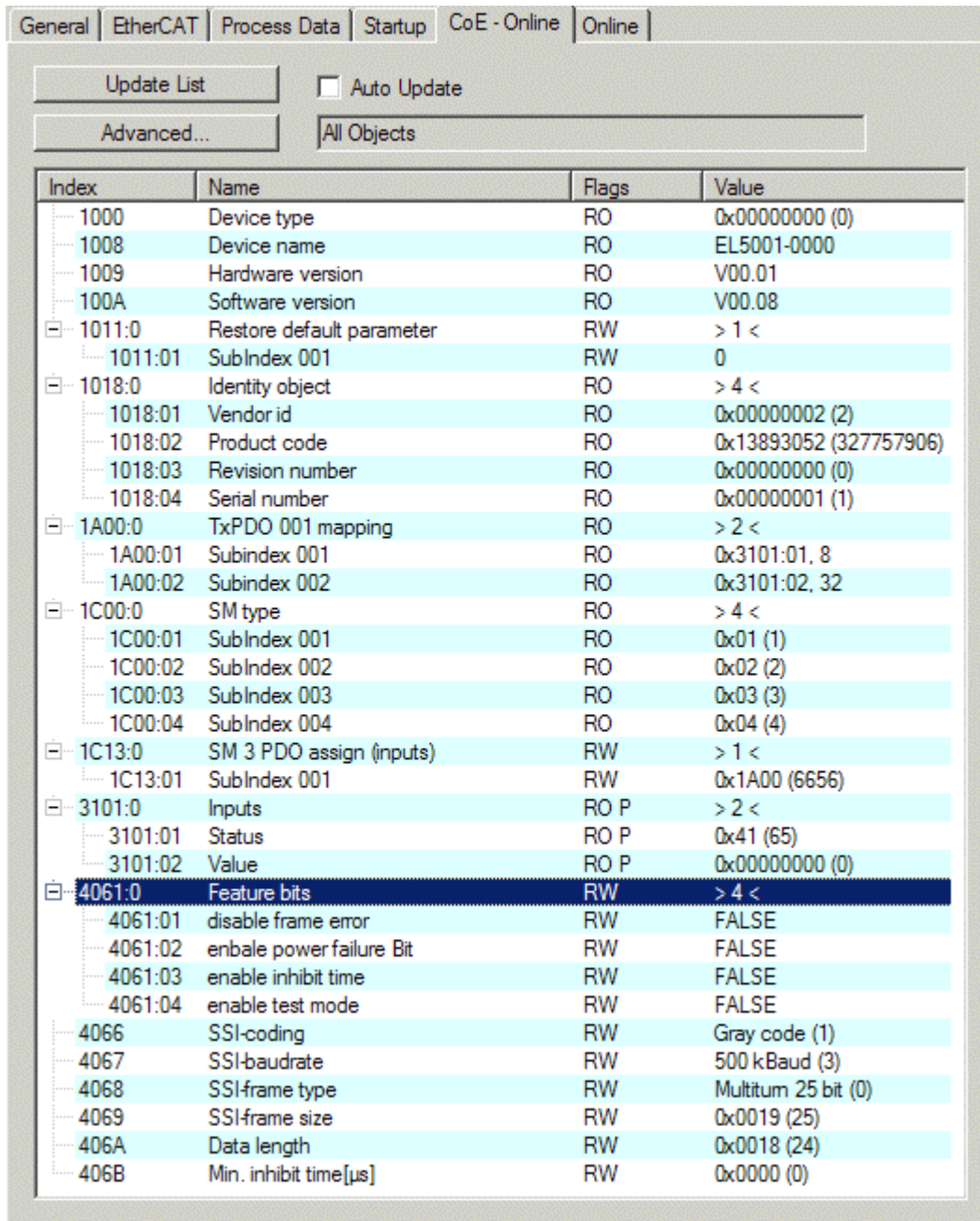

Fig. 135: "CoE - Online" tab

Object list display

Column	Description
Index	Index and sub-index of the object
Name	Name of the object
Flags	RW The object can be read, and data can be written to the object (read/write)
	RO The object can be read, but no data can be written to the object (read only)
	P An additional P identifies the object as a process data object.
Value	Value of the object

- Update List** The *Update list* button updates all objects in the displayed list
- Auto Update** If this check box is selected, the content of the objects is updated automatically.
- Advanced** The *Advanced* button opens the *Advanced Settings* dialog. Here you can specify which objects are displayed in the list.

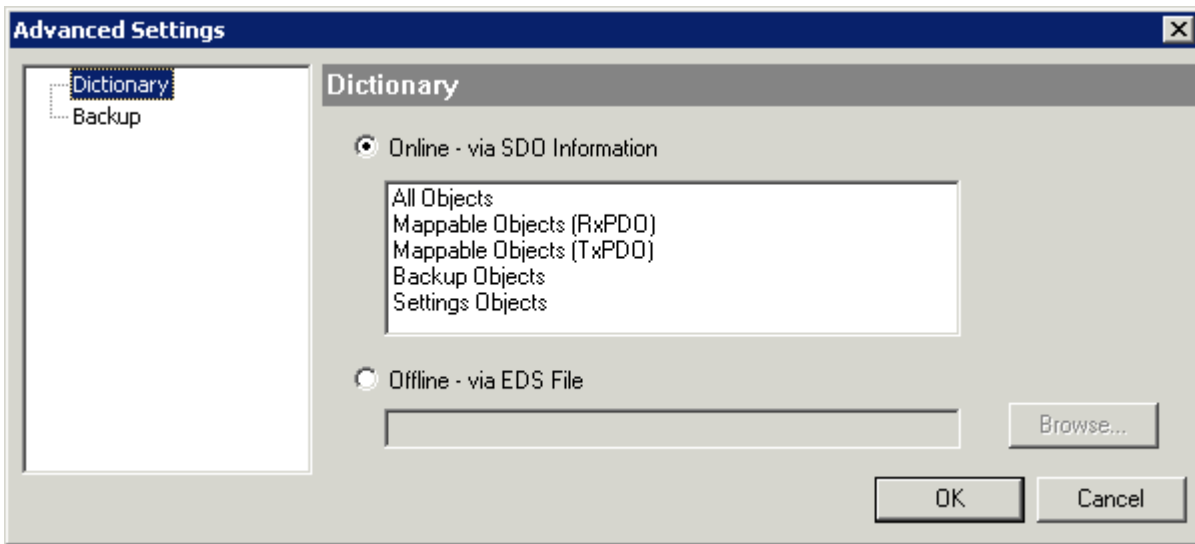

Fig. 136: Dialog “Advanced settings”

Online - via SDO Information If this option button is selected, the list of the objects included in the object list of the slave is uploaded from the slave via SDO information. The list below can be used to specify which object types are to be uploaded.

Offline - via EDS File If this option button is selected, the list of the objects included in the object list is read from an EDS file provided by the user.

“Online” tab

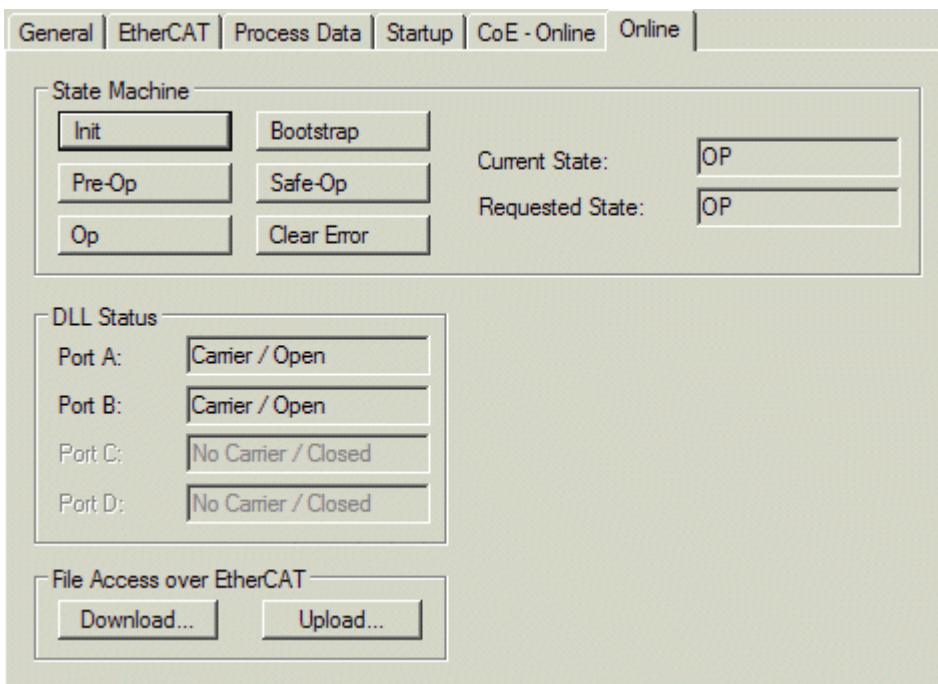

Fig. 137: “Online” tab

State Machine

Init	This button attempts to set the EtherCAT device to the <i>Init</i> state.
Pre-Op	This button attempts to set the EtherCAT device to the <i>pre-operational</i> state.
Op	This button attempts to set the EtherCAT device to the <i>operational</i> state.
Bootstrap	This button attempts to set the EtherCAT device to the <i>Bootstrap</i> state.
Safe-Op	This button attempts to set the EtherCAT device to the <i>safe-operational</i> state.
Clear Error	This button attempts to delete the fault display. If an EtherCAT slave fails during change of state it sets an error flag. Example: An EtherCAT slave is in PREOP state (pre-operational). The master now requests the SAFEOP state (safe-operational). If the slave fails during change of state it sets the error flag. The current state is now displayed as ERR PREOP. When the <i>Clear Error</i> button is pressed the error flag is cleared, and the current state is displayed as PREOP again.
Current State	Indicates the current state of the EtherCAT device.
Requested State	Indicates the state requested for the EtherCAT device.

DLL Status

Indicates the DLL status (data link layer status) of the individual ports of the EtherCAT slave. The DLL status can have four different states:

Status	Description
No Carrier / Open	No carrier signal is available at the port, but the port is open.
No Carrier / Closed	No carrier signal is available at the port, and the port is closed.
Carrier / Open	A carrier signal is available at the port, and the port is open.
Carrier / Closed	A carrier signal is available at the port, but the port is closed.

File Access over EtherCAT

Download	With this button a file can be written to the EtherCAT device.
Upload	With this button a file can be read from the EtherCAT device.

“DC” tab (Distributed Clocks)

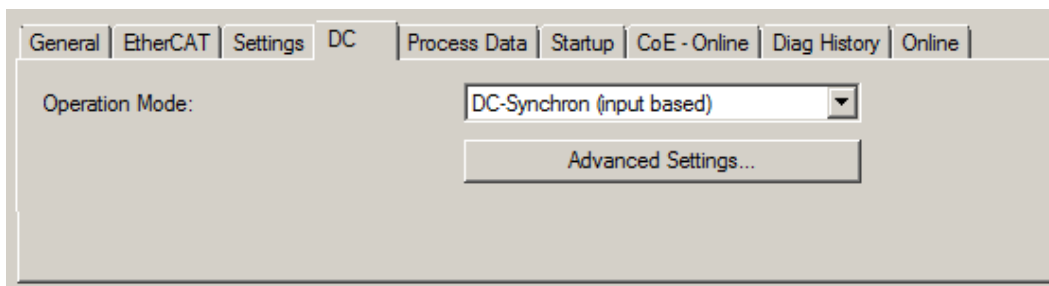

Fig. 138: “DC” tab (Distributed Clocks)

Operation Mode	Options (optional): <ul style="list-style-type: none"> • FreeRun • SM-Synchron • DC-Synchron (Input based) • DC-Synchron
Advanced Settings...	Advanced settings for readjustment of the real time determinant TwinCAT-clock

Detailed information to Distributed Clocks is specified on <http://infosys.beckhoff.com>:

Fieldbus Components → EtherCAT Terminals → EtherCAT System documentation → EtherCAT basics → Distributed Clocks

13.2.7.1 Detailed description of Process Data tab

Sync Manager

Lists the configuration of the Sync Manager (SM).

If the EtherCAT device has a mailbox, SM0 is used for the mailbox output (MbxOut) and SM1 for the mailbox input (MbxIn).

SM2 is used for the output process data (outputs) and SM3 (inputs) for the input process data.

If an input is selected, the corresponding PDO assignment is displayed in the *PDO Assignment* list below.

PDO Assignment



PDO assignment of the selected Sync Manager. All PDOs defined for this Sync Manager type are listed here:

- If the output Sync Manager (outputs) is selected in the Sync Manager list, all RxPDOs are displayed.
- If the input Sync Manager (inputs) is selected in the Sync Manager list, all TxPDOs are displayed.

The selected entries are the PDOs involved in the process data transfer. In the tree diagram of the System Manager these PDOs are displayed as variables of the EtherCAT device. The name of the variable is identical to the *Name* parameter of the PDO, as displayed in the PDO list. If an entry in the PDO assignment list is deactivated (not selected and greyed out), this indicates that the input is excluded from the PDO assignment. In order to be able to select a greyed out PDO, the currently selected PDO has to be deselected first.

i Activation of PDO assignment

- ✓ If you have changed the PDO assignment, in order to activate the new PDO assignment,
 - a) the EtherCAT slave has to run through the PS status transition cycle (from pre-operational to safe-operational) once (see [Online tab \[▶ 131\]](#)),
 - b) and the System Manager has to reload the EtherCAT slaves

( button for TwinCAT 2 or  button for TwinCAT 3)

PDO list

List of all PDOs supported by this EtherCAT device. The content of the selected PDOs is displayed in the *PDO Content* list. The PDO configuration can be modified by double-clicking on an entry.

Column	Description	
Index	PDO index.	
Size	Size of the PDO in bytes.	
Name	Name of the PDO. If this PDO is assigned to a Sync Manager, it appears as a variable of the slave with this parameter as the name.	
Flags	F	Fixed content: The content of this PDO is fixed and cannot be changed by the System Manager.
	M	Mandatory PDO. This PDO is mandatory and must therefore be assigned to a Sync Manager! Consequently, this PDO cannot be deleted from the <i>PDO Assignment</i> list
SM	Sync Manager to which this PDO is assigned. If this entry is empty, this PDO does not take part in the process data traffic.	
SU	Sync unit to which this PDO is assigned.	

PDO Content

Indicates the content of the PDO. If flag F (fixed content) of the PDO is not set the content can be modified.

Download

If the device is intelligent and has a mailbox, the configuration of the PDO and the PDO assignments can be downloaded to the device. This is an optional feature that is not supported by all EtherCAT slaves.

PDO Assignment

If this check box is selected, the PDO assignment that is configured in the PDO Assignment list is downloaded to the device on startup. The required commands to be sent to the device can be viewed in the Startup [► 128] tab.

PDO Configuration

If this check box is selected, the configuration of the respective PDOs (as shown in the PDO list and the PDO Content display) is downloaded to the EtherCAT slave.

13.2.8 NC configuration

NC configuration – for axis configuration and connection of the EL51x1 in the TwinCAT System Manager (Config mode) proceed as follows:

Right-click on *NC Configuration* - > *Append Task* (Fig. *NC Configuration, Append Task*), enter a name for the task and confirm with *OK* (Fig. *Entering a name for the task and confirming*)

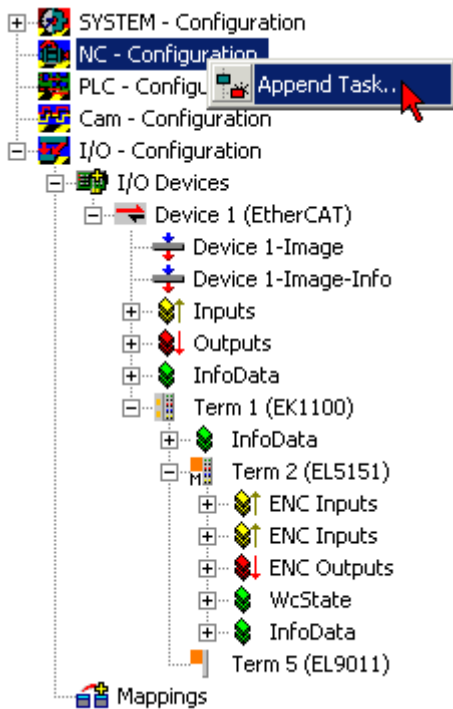

Fig. 139: NC - Configuration, Append Task

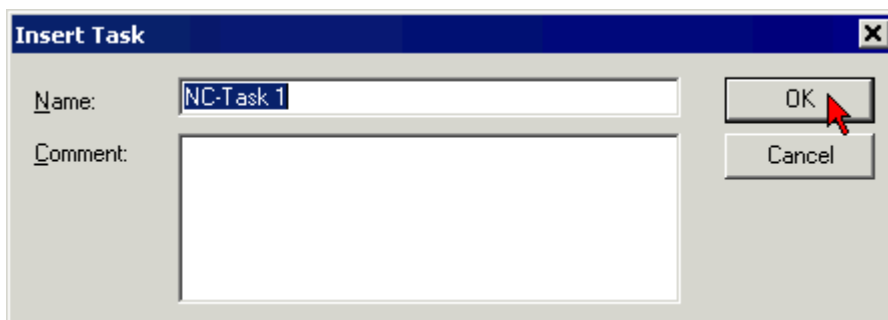

Fig. 140: Entering a name for the task and confirming

Right-click on *Axes* -> *Append Axis* (Fig. *Insert axis*), enter a name, select a type for the axis and confirm with *OK* (Fig. *Entering a name for the axis and selecting a type*)

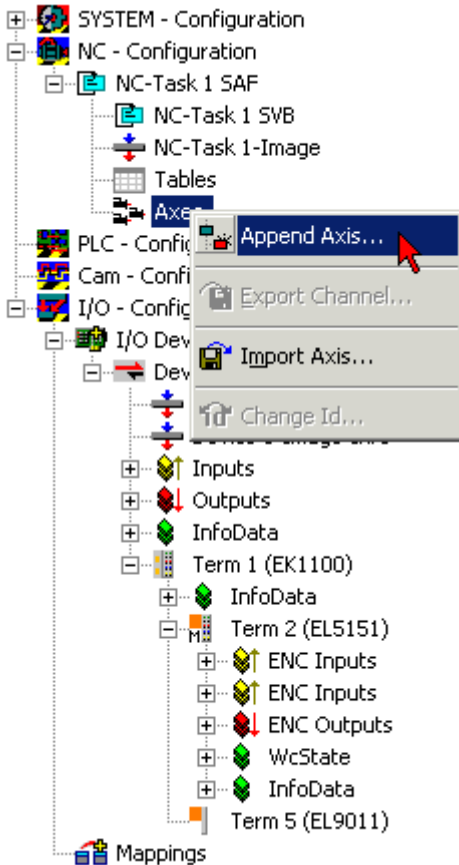

Fig. 141: Insert axis

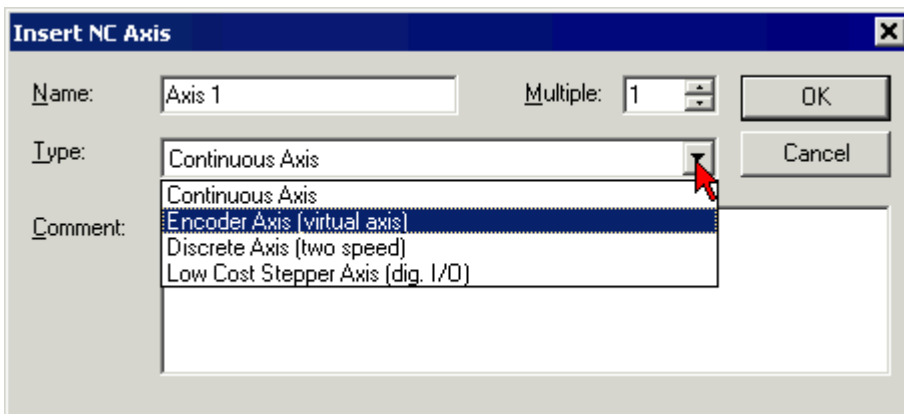

Fig. 142: Entering a name for the axis and selecting a type

On the *NC-Encoder* tab select the *encoder* (KL5101/KI5111/IP5109/EL5101) in the *Type* pull-down menu (Fig. *Selecting the encoder*)

Click on the button *Link To...*, select *Terminal EL51x1* and confirm with *OK* (Fig. *Selecting and confirming an encoder terminal*)

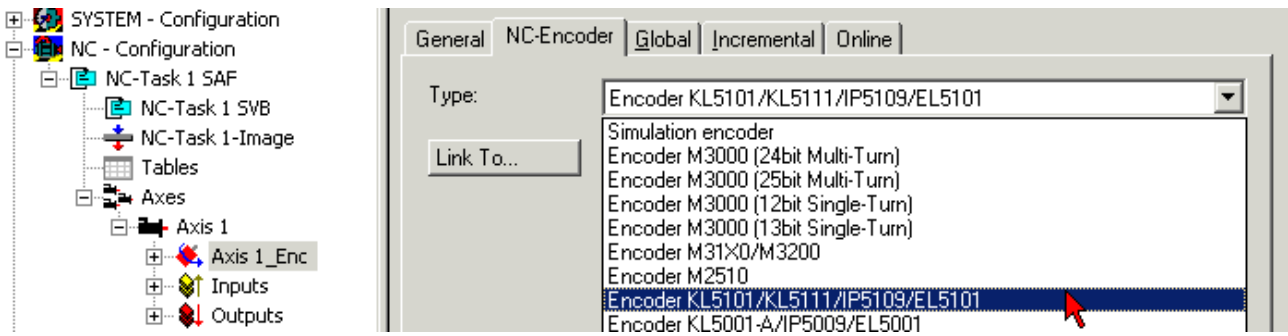

Fig. 143: Selecting the encoder

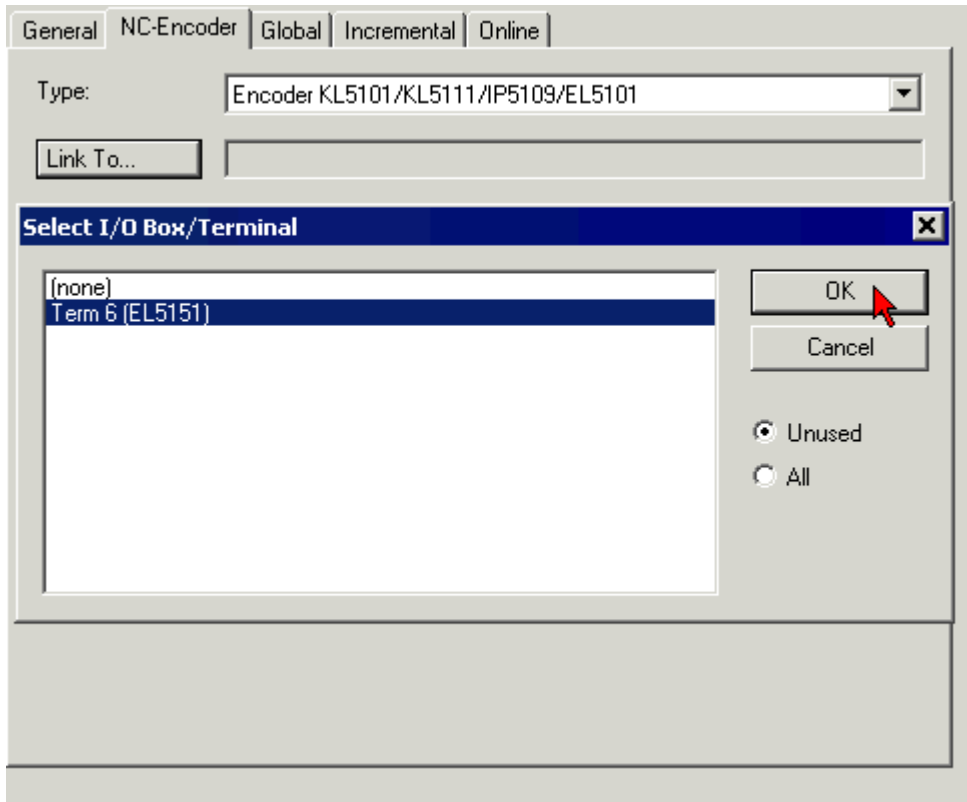

Fig. 144: Selecting and confirming an encoder terminal

The corresponding inputs of the EL51x1 are now linked with the NC task (Fig. *EL51x1 inputs linked with the NC task*)

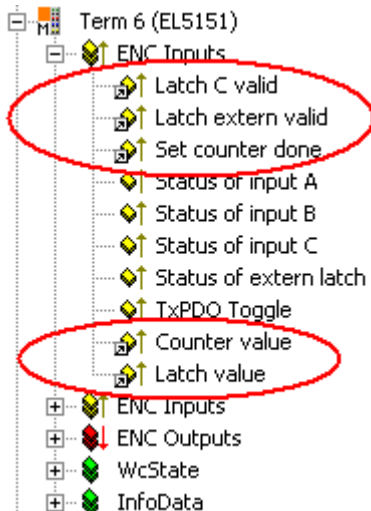

Fig. 145: EL51x1 inputs linked with the NC task

13.3 General Commissioning Instructions for an EtherCAT Slave

This summary briefly deals with a number of aspects of EtherCAT Slave operation under TwinCAT. More detailed information on this may be found in the corresponding sections of, for instance, the EtherCAT System Documentation.

Diagnosis in real time: WorkingCounter, EtherCAT State and Status

Generally speaking an EtherCAT Slave provides a variety of diagnostic information that can be used by the controlling task.

This diagnostic information relates to differing levels of communication. It therefore has a variety of sources, and is also updated at various times.

Any application that relies on I/O data from a fieldbus being correct and up to date must make diagnostic access to the corresponding underlying layers. EtherCAT and the TwinCAT System Manager offer comprehensive diagnostic elements of this kind. Those diagnostic elements that are helpful to the controlling task for diagnosis that is accurate for the current cycle when in operation (not during commissioning) are discussed below.

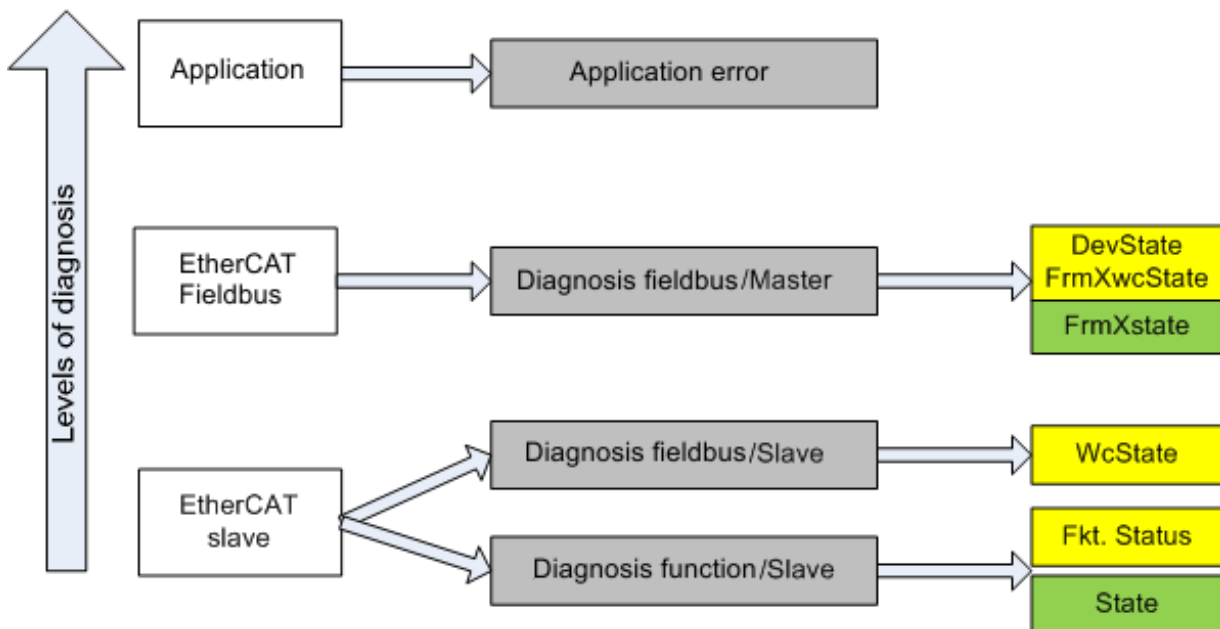

Fig. 146: Selection of the diagnostic information of an EtherCAT Slave

In general, an EtherCAT Slave offers

- communication diagnosis typical for a slave (diagnosis of successful participation in the exchange of process data, and correct operating mode)
This diagnosis is the same for all slaves.

as well as

- function diagnosis typical for a channel (device-dependent)
See the corresponding device documentation

The colors in Fig. *Selection of the diagnostic information of an EtherCAT Slave* also correspond to the variable colors in the System Manager, see Fig. *Basic EtherCAT Slave Diagnosis in the PLC*.

Colour	Meaning
yellow	Input variables from the Slave to the EtherCAT Master, updated in every cycle
red	Output variables from the Slave to the EtherCAT Master, updated in every cycle
green	Information variables for the EtherCAT Master that are updated acyclically. This means that it is possible that in any particular cycle they do not represent the latest possible status. It is therefore useful to read such variables through ADS.

Fig. Basic EtherCAT Slave Diagnosis in the PLC shows an example of an implementation of basic EtherCAT Slave Diagnosis. A Beckhoff EL3102 (2-channel analogue input terminal) is used here, as it offers both the communication diagnosis typical of a slave and the functional diagnosis that is specific to a channel. Structures are created as input variables in the PLC, each corresponding to the process image.

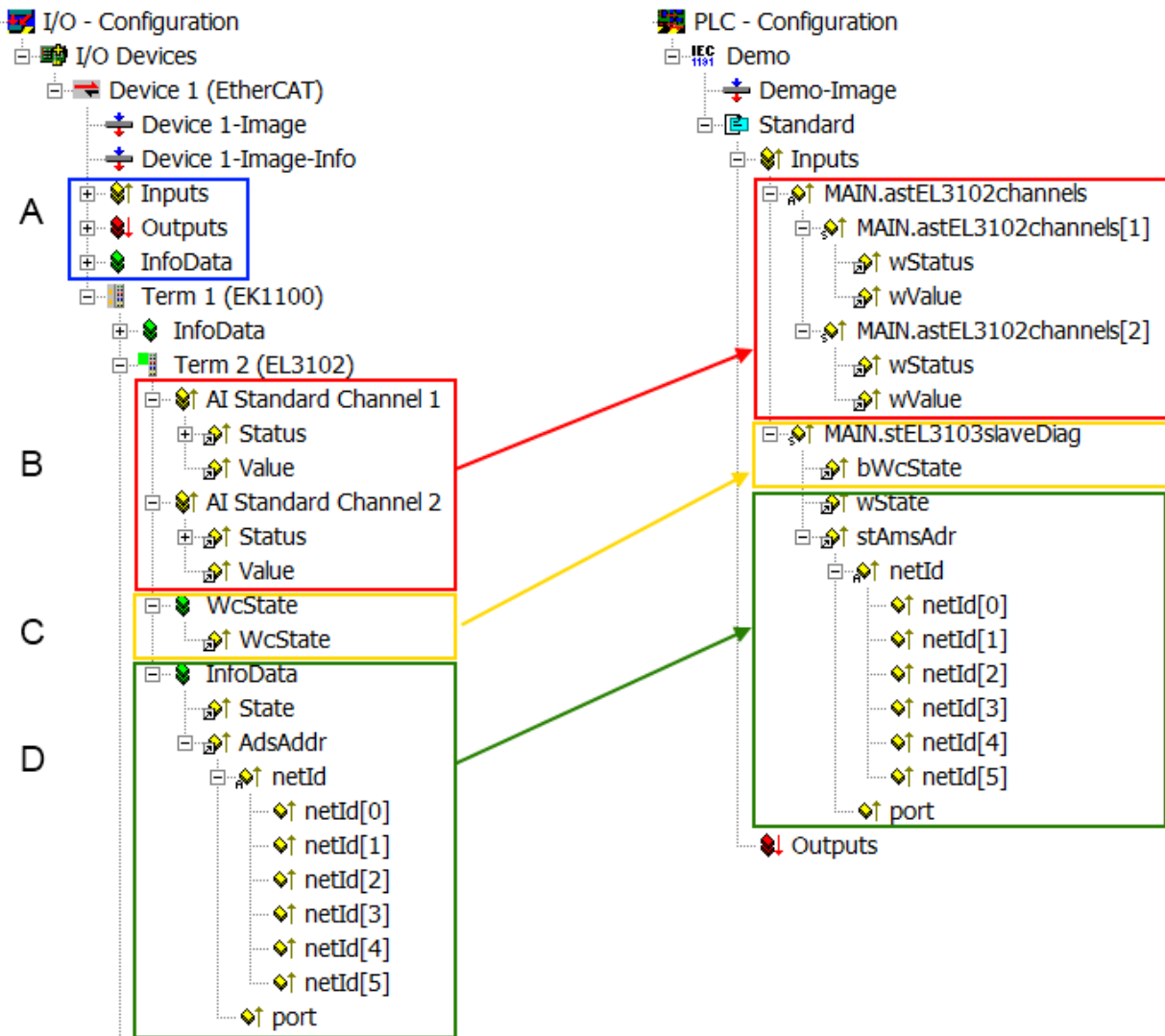

Fig. 147: Basic EtherCAT Slave Diagnosis in the PLC

The following aspects are covered here:

Code	Function	Implementation	Application/evaluation
A	The EtherCAT Master's diagnostic information updated acyclically (yellow) or provided acyclically (green).		At least the DevState is to be evaluated for the most recent cycle in the PLC. The EtherCAT Master's diagnostic information offers many more possibilities than are treated in the EtherCAT System Documentation. A few keywords: <ul style="list-style-type: none"> • CoE in the Master for communication with/through the Slaves • Functions from <i>TcEtherCAT.lib</i> • Perform an OnlineScan
B	In the example chosen (EL3102) the EL3102 comprises two analogue input channels that transmit a single function status for the most recent cycle.	Status <ul style="list-style-type: none"> • the bit significations may be found in the device documentation • other devices may supply more information, or none that is typical of a slave 	In order for the higher-level PLC task (or corresponding control applications) to be able to rely on correct data, the function status must be evaluated there. Such information is therefore provided with the process data for the most recent cycle.
C	For every EtherCAT Slave that has cyclic process data, the Master displays, using what is known as a WorkingCounter, whether the slave is participating successfully and without error in the cyclic exchange of process data. This important, elementary information is therefore provided for the most recent cycle in the System Manager <ol style="list-style-type: none"> 1. at the EtherCAT Slave, and, with identical contents 2. as a collective variable at the EtherCAT Master (see Point A) for linking. 	WcState (Working Counter) 0: valid real-time communication in the last cycle 1: invalid real-time communication This may possibly have effects on the process data of other Slaves that are located in the same SyncUnit	In order for the higher-level PLC task (or corresponding control applications) to be able to rely on correct data, the communication status of the EtherCAT Slave must be evaluated there. Such information is therefore provided with the process data for the most recent cycle.
D	Diagnostic information of the EtherCAT Master which, while it is represented at the slave for linking, is actually determined by the Master for the Slave concerned and represented there. This information cannot be characterized as real-time, because it <ul style="list-style-type: none"> • is only rarely/never changed, except when the system starts up • is itself determined acyclically (e.g. EtherCAT Status) 	State current Status (INIT..OP) of the Slave. The Slave must be in OP (=8) when operating normally. <i>AdsAddr</i> The ADS address is useful for communicating from the PLC/task via ADS with the EtherCAT Slave, e.g. for reading/writing to the CoE. The AMS-NetID of a slave corresponds to the AMS-NetID of the EtherCAT Master; communication with the individual Slave is possible via the <i>port</i> (= EtherCAT address).	Information variables for the EtherCAT Master that are updated acyclically. This means that it is possible that in any particular cycle they do not represent the latest possible status. It is therefore possible to read such variables through ADS.

NOTICE

Diagnostic information

It is strongly recommended that the diagnostic information made available is evaluated so that the application can react accordingly.

CoE Parameter Directory

The CoE parameter directory (CanOpen-over-EtherCAT) is used to manage the set values for the slave concerned. Changes may, in some circumstances, have to be made here when commissioning a relatively complex EtherCAT Slave. It can be accessed through the TwinCAT System Manager, see Fig. *EL3102, CoE directory*:

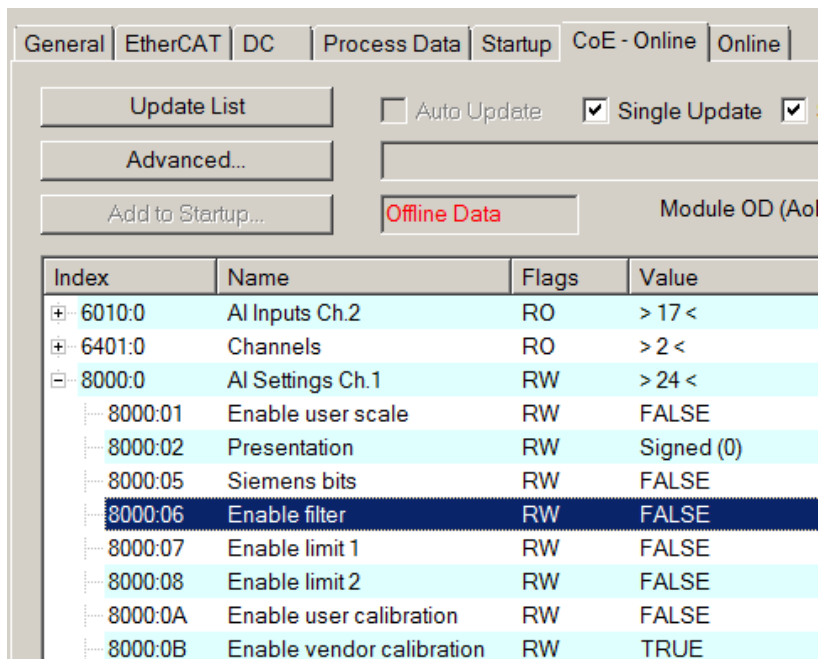

Fig. 148: EL3102, CoE directory

i EtherCAT System Documentation

The comprehensive description in the [EtherCAT System Documentation](#) (EtherCAT Basics --> CoE Interface) must be observed!

A few brief extracts:

- Whether changes in the online directory are saved locally in the slave depends on the device. EL terminals (except the EL66xx) are able to save in this way.
- The user must manage the changes to the StartUp list.

Commissioning aid in the TwinCAT System Manager

Commissioning interfaces are being introduced as part of an ongoing process for EL/EP EtherCAT devices. These are available in TwinCAT System Managers from TwinCAT 2.11R2 and above. They are integrated into the System Manager through appropriately extended ESI configuration files.

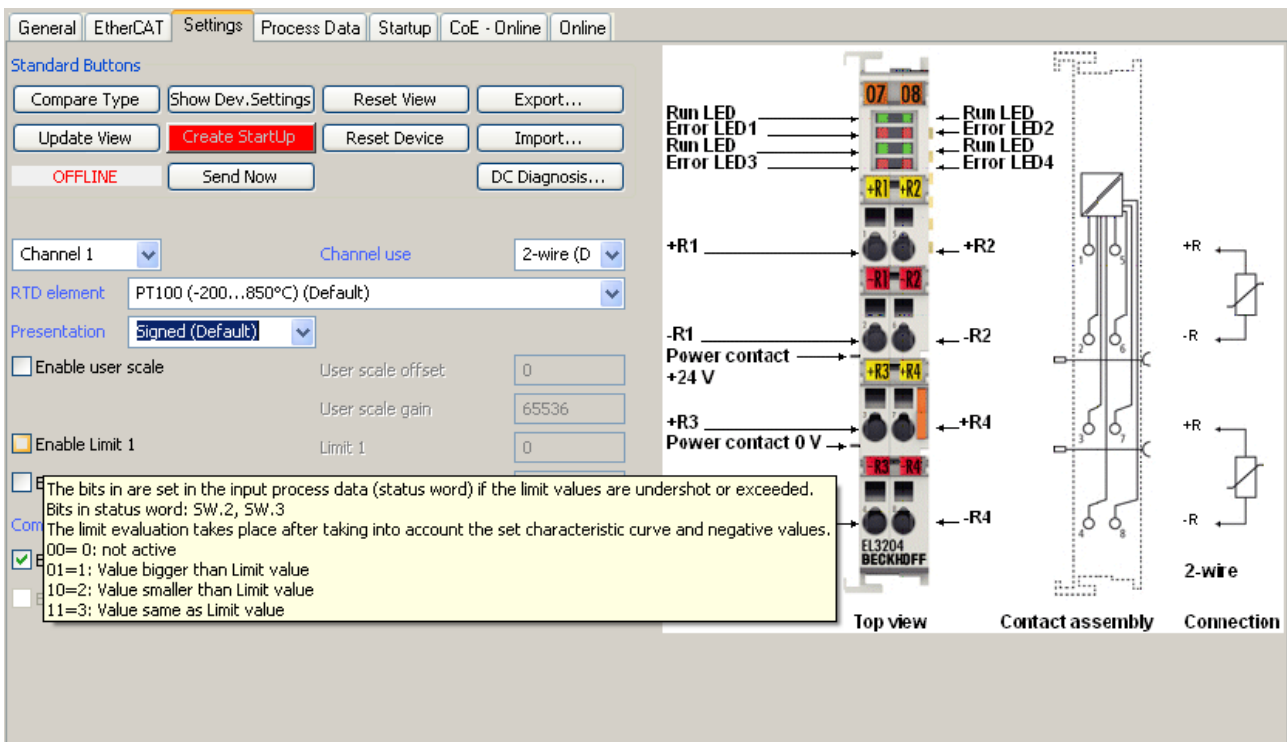

Fig. 149: Example of commissioning aid for a EL3204

This commissioning process simultaneously manages

- CoE Parameter Directory
- DC/FreeRun mode
- the available process data records (PDO)

Although the “Process Data”, “DC”, “Startup” and “CoE-Online” that used to be necessary for this are still displayed, it is recommended that, if the commissioning aid is used, the automatically generated settings are not changed by it.

The commissioning tool does not cover every possible application of an EL/EP device. If the available setting options are not adequate, the user can make the DC, PDO and CoE settings manually, as in the past.

EtherCAT State: automatic default behaviour of the TwinCAT System Manager and manual operation

After the operating power is switched on, an EtherCAT Slave must go through the following statuses

- INIT
- PREOP
- SAFEOP
- OP

to ensure sound operation. The EtherCAT Master directs these statuses in accordance with the initialization routines that are defined for commissioning the device by the ES/XML and user settings (Distributed Clocks (DC), PDO, CoE). See also the section on "Principles of [Communication, EtherCAT State Machine \[▶ 44\]](#)" in this connection. Depending how much configuration has to be done, and on the overall communication, booting can take up to a few seconds.

The EtherCAT Master itself must go through these routines when starting, until it has reached at least the OP target state.

The target state wanted by the user, and which is brought about automatically at start-up by TwinCAT, can be set in the System Manager. As soon as TwinCAT reaches the status RUN, the TwinCAT EtherCAT Master will approach the target states.

Standard setting

The advanced settings of the EtherCAT Master are set as standard:

- EtherCAT Master: OP
- Slaves: OP
This setting applies equally to all Slaves.

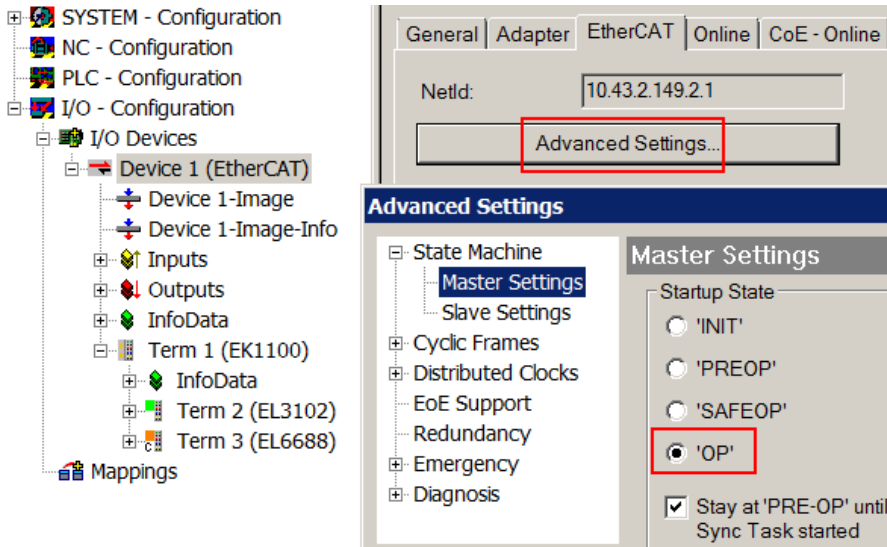

Fig. 150: Default behaviour of the System Manager

In addition, the target state of any particular Slave can be set in the “Advanced Settings” dialogue; the standard setting is again OP.

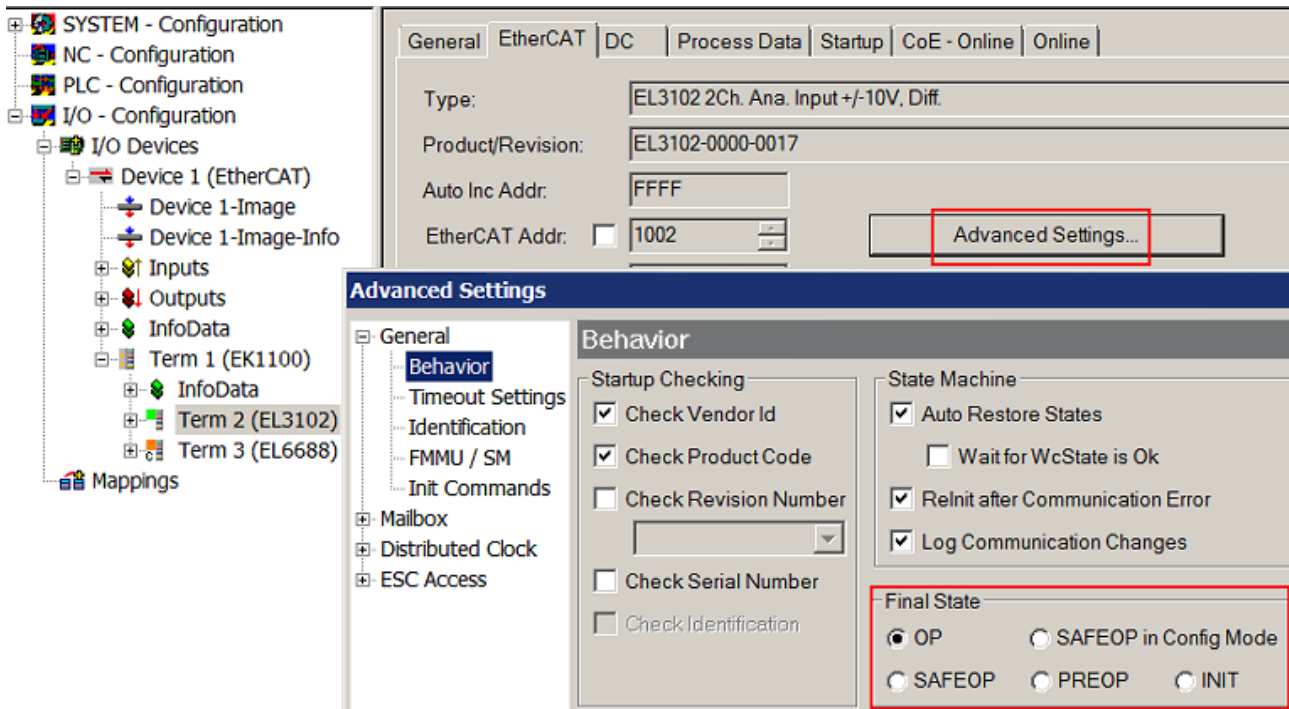

Fig. 151: Default target state in the Slave

Manual Control

There are particular reasons why it may be appropriate to control the states from the application/task/PLC. For instance:

- for diagnostic reasons
- to induce a controlled restart of axes

- because a change in the times involved in starting is desirable

In that case it is appropriate in the PLC application to use the PLC function blocks from the *TcEtherCAT.lib*, which is available as standard, and to work through the states in a controlled manner using, for instance, *FB_EcSetMasterState*.

It is then useful to put the settings in the EtherCAT Master to INIT for master and slave.

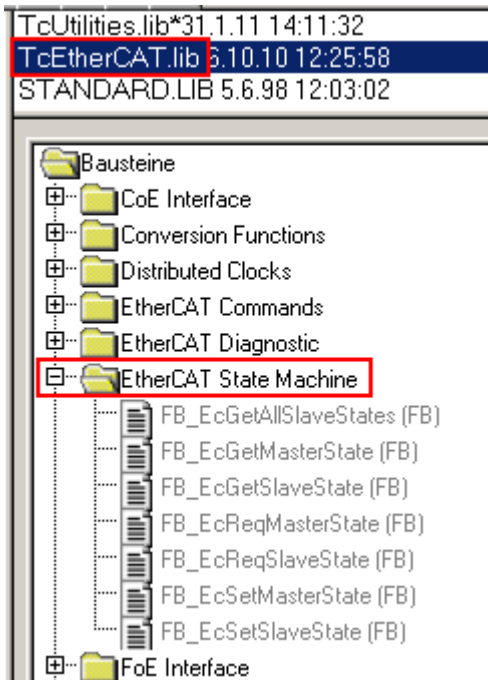

Fig. 152: PLC function blocks

Note regarding E-Bus current

EL/ES terminals are placed on the DIN rail at a coupler on the terminal strand. A Bus Coupler can supply the EL terminals added to it with the E-bus system voltage of 5 V; a coupler is thereby loadable up to 2 A as a rule. Information on how much current each EL terminal requires from the E-bus supply is available online and in the catalogue. If the added terminals require more current than the coupler can supply, then power feed terminals (e.g. EL9410) must be inserted at appropriate places in the terminal strand.

The pre-calculated theoretical maximum E-Bus current is displayed in the TwinCAT System Manager as a column value. A shortfall is marked by a negative total amount and an exclamation mark; a power feed terminal is to be placed before such a position.

General Adapter EtherCAT Online CoE - Online						
NetId:		10.43.2.149.2.1		Advanced Settings...		
Number	Box Name	Address	Type	In Size	Out S...	E-Bus (..
1	Term 1 (EK1100)	1001	EK1100			
2	Term 2 (EL3102)	1002	EL3102	8.0		1830
3	Term 4 (EL2004)	1003	EL2004		0.4	1730
4	Term 5 (EL2004)	1004	EL2004		0.4	1630
5	Term 6 (EL7031)	1005	EL7031	8.0	8.0	1510
6	Term 7 (EL2808)	1006	EL2808		1.0	1400
7	Term 8 (EL3602)	1007	EL3602	12.0		1210
8	Term 9 (EL3602)	1008	EL3602	12.0		1020
9	Term 10 (EL3602)	1009	EL3602	12.0		830
10	Term 11 (EL3602)	1010	EL3602	12.0		640
11	Term 12 (EL3602)	1011	EL3602	12.0		450
12	Term 13 (EL3602)	1012	EL3602	12.0		260
13	Term 14 (EL3602)	1013	EL3602	12.0		70
14	Term 3 (EL6688)	1014	EL6688	22.0		-240 !

Fig. 153: Illegally exceeding the E-Bus current

From TwinCAT 2.11 and above, a warning message “E-Bus Power of Terminal...” is output in the logger window when such a configuration is activated:



Fig. 154: Warning message for exceeding E-Bus current

NOTICE
<p>Caution! Malfunction possible!</p> <p>The same ground potential must be used for the E-Bus supply of all EtherCAT terminals in a terminal block!</p>

14 EL5101 - Commissioning

14.1 Normal operation mode

14.1.1 Operation modes

In EL5101 “normal operation mode” the following modes are available:

Mode	DC	Main PDO	Comment	Optional PDO 1	Comment	Features CoE	Comment
1	FreeRun	0x1A00 [▶ 157] + 0x1600 [▶ 156]	16 bit Value/Latch Byte-Alignment	0x1A02 [▶ 157]	Frequency: 32 bit Period: 16 bit Window: 16 bit CoE object 0x8001:02 [▶ 155] : window	0x8000:01 [▶ 155] + 0x8001:02 [▶ 155]	Register reload + Reload Value
2	"	"	"	"	"	0x8000:02 [▶ 155]	Index Reset
3	"	"	"	"	"	0x8000:03 [▶ 155] , :04 [▶ 155] , :05 [▶ 155]	FWD Cnt + pos/ neg Gate
4	FreeRun	0x1A01 [▶ 157] + 0x1601 [▶ 157]	16 bit Value/Latch Word Alignment	0x1A02 [▶ 157]	Frequency: 32 bit Period: 16 bit Window: 16 bit CoE object 0x8001:02 [▶ 155] : window	0x8000:01 [▶ 155] + 0x8001:02 [▶ 155]	Register reload + Reload Value
5	"	"	"	"	"	0x8000:02 [▶ 155]	Index Reset
6	"	"	"	"	"	0x8000:03 [▶ 155] , :04 [▶ 155] , :05 [▶ 155]	FWD Cnt + pos/ neg Gate

Other settings may result in irregular process data and lead to error messages in the TwinCAT System Manager logger window.

● EL5101 parameterization



- Use a [CoE reset \[▶ 273\]](#) in order to deactivate any previous settings

- To activate the new operation mode, reload the EtherCAT slaves (button  in the System Manager)

DC (Distributed Clocks)

Describes whether the terminal is operated with distributed clocks support:

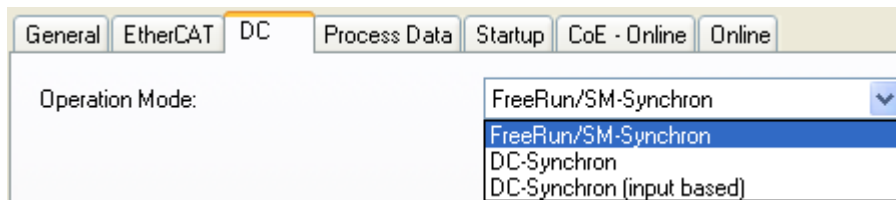

Fig. 155: “DC” tab

● Distributed Clocks in normal operating mode



In normal operating mode no DC functions are available.

14.1.2 Process data

Main PDO

Selection of basic process data:

The screenshot shows the 'Process Data' configuration window. It contains the following data:

Sync Manager:

SM	Size	Type	Flags
0	48	MbxOut	
1	48	MbxIn	
2	3	Outputs	
3	13	Inputs	

PDO List:

Index	Size	Name
0x1A00	5.0	Inputs
0x1A01	6.0	Inputs
0x1A02	8.0	Inputs
0x1A03	6.0	ENC Status compact
0x1A04	10.0	ENC Status
0x1A05	4.0	ENC Frequency
0x1A06	4.0	ENC Period
0x1A07	8.0	ENC Timest.
0x1A08	4.0	ENC Timest. compact
0x1600	3.0	Outputs
0x1601	4.0	Outputs

PDO Assignment (0x1C13):

- 0x1A00
- 0x1A01 (excluded by 0x1A00)
- 0x1A02
- 0x1A03 (excluded by 0x1A02)
- 0x1A04 (excluded by 0x1A02)
- 0x1A05 (excluded by 0x1A02)
- 0x1A06 (excluded by 0x1A02)

PDO Content (0x1A01):

Index	Size	Offs	Name
0x6000:01	1.0	0.0	Status
---	1.0	1.0	---
0x6000:02	2.0	2.0	Value
0x6000:03	2.0	4.0	Latch
		6.0	

Fig. 156: "Process data" tab

A: Selection of data direction: input or output

B: Selection of (optional) PDOs (process data objects)

C: Explanatory notes for PDOs

- Byte/word alignment: By default the EL5101 is operated in normal operation mode with byte alignment and therefore efficiently few process data. In cases where an EtherCAT master requires the process data in word alignment (filled to 16 bit), PDO [0x1A01 \[► 157\]](#) and [0x1601 \[► 157\]](#) should be used.

Optional PDOs

Optional PDOs, in addition to the main PDO:

- PDO 1 ([0x1A02 \[► 157\]](#)):
 - The **frequency** is determined over 10 ms (fixed) as a number of increments.
 - The **period** (time interval between two positive edges of input A) is determined as often as possible in the unit 500 ns/digit. If no increment event occurs for approx. 1.6 seconds, the frequency/period is set to 0.
 - **Window:** A user-defined time window can be parameterized via CoE object [0x8001:02 \[► 155\]](#) with the unit 16 µs/digit. During this window time the encoder increments are counted and output in the process record *window*.

Process data description

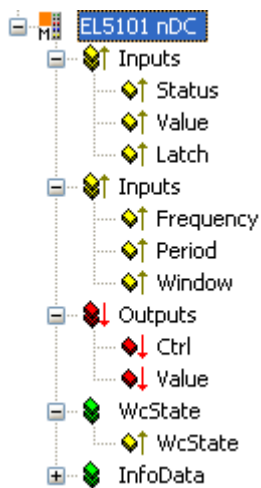

Fig. 157: Process data description

The process data are generated from CoE objects `0x6000` (inputs) [[▶ 155](#)] and `0x7000` (outputs) [[▶ 156](#)].

- **Status:** Status bits (see section [Control and status word](#) [[▶ 160](#)])
- **Value:** Encoder position
- **Latch:** Latch position
- **Frequency:** Current calculated frequency
- **Period:** Period of the last possible measurement
The refresh rate depends on the cycle time and the current frequency
- **Window:** Number of edges counted during the time window
- **Ctrl:** Control bits (see section [Control and status word](#) [[▶ 160](#)])
- **Value:** Relevant counter value

14.1.2.1 Sync Manager (SM)

The scope of process data offered can be modified via the "Process Data" tab (see Fig. *EL5101 - Process Data tab SM3, (Legacy)* below).

1. In order to configure the process data, select the desired Sync Manager (SM2 and SM3 can be edited here) in the upper left-hand "Sync Manager" field (see fig. below).
2. The process data assigned to this Sync Manager can then be switched on or off in the "PDO Assignment" box underneath.
3. Restarting the EtherCAT system, or reloading the configuration in configuration mode (F4), causes the EtherCAT communication to restart, and the process data is transferred from the terminal.

A detailed description for setting the process data can be found in chapter [Process Data tab](#) [▶ 126].

The screenshot shows the 'Process Data' configuration window for Sync Manager SM3. It is divided into several sections:

- Sync Manager:** A table listing SMs 0, 1, 2, and 3 with their sizes and types.
- PDO List:** A table listing PDOs from 0x1A00 to 0x1603, including their sizes, names, flags, SMs, and SUs.
- PDO Assignment (0x1C13):** A list of checkboxes for PDOs 0x1A00 through 0x1A08, with 0x1A00 checked.
- PDO Content (0x1A00):** A table showing the content of PDO 0x1A00, including fields like Status, Value, and Latch.
- Download:** Checkboxes for 'PDO Assignment' (checked) and 'PDO Configuration'.
- Predefined PDO Assignment:** A dropdown menu set to 'Legacy (MDP 510)'.
- Buttons:** 'Load PDO info from device' and 'Sync Unit Assignment...'.

Fig. 158: EL5101 - Process data SM3 tab (Legacy)

14.1.2.2 PDO assignment

The EL5101 offers different process data objects (PDO) in normal and enhanced operation mode. The PDOs of the two operation modes are mutually exclusive.

In this chapter only the PDOs of the normal operation mode are described. Excluded PDOs of the enhanced operation mode are shown in gray font in the following tables and are described in chapter "Enhanced operation mode". [▶ 165]

14.1.2.2.1 SM3 - Inputs (0x1A00 .. 0x1A02)

0x1A00 - Inputs (5.0)	
Contents Index - name size (byte.bit)	Excluded PDOs Index - name size (byte.bit)
0x6000:01 [▶ 155] - Status (1.0) 0x6000:02 [▶ 155] - Value (2.0) 0x6000:03 [▶ 155] - Latch (2.0)	Objects for normal operation mode: 0x1A01 [▶ 157] - Inputs (6.0) Objects for enhanced mode: 0x1A03 - ENC Status compact (6.0) 0x1A04 - ENC Status (10.0) 0x1A05 - ENC Frequency (4.0) 0x1A06 - ENC Period (4.0) 0x1A07 - ENC Timest. (8.0) 0x1A08 - ENC Timest. compact (4.0)

0x1A01 - Inputs (6.0)	
Contents Index - name size (byte.bit)	Excluded PDOs Index - name size (byte.bit)
0x6000:01 [▶ 155] - Status (1.0) 0x6000:02 [▶ 155] - Value (2.0) 0x6000:03 [▶ 155] - Latch (2.0)	Objects for normal operation mode: 0x1A00 [▶ 184] - Inputs (5.0) Objects for enhanced mode: 0x1A03 - ENC Status compact (6.0) 0x1A04 - ENC Status (10.0) 0x1A05 - ENC Frequency (4.0) 0x1A06 - ENC Period (4.0) 0x1A07 - ENC Timest. (8.0) 0x1A08 - ENC Timest. Compact (4.0)

0x1A02 - Inputs (8.0)	
Contents Index - name size (byte.bit)	Excluded PDOs Index - name size (byte.bit)
0x6000:04 [▶ 155] - Frequency (4.0) 0x6000:05 [▶ 155] - Period (2.0) 0x6000:06 [▶ 155] - Window (2.0)	Objects for enhanced mode: 0x1A03 - ENC Status compact (6.0) 0x1A04 - ENC Status (10.0) 0x1A05 - ENC Frequency (4.0) 0x1A06 - ENC Period (4.0) 0x1A07 - ENC Timest. (8.0) 0x1A08 - ENC Timest. compact (4.0)

14.1.2.2 SM2 - Outputs (0x1600 .. 0x1601)

0x1600 - Outputs (3.0)	
Contents Index - name size (byte.bit)	Excluded PDOs Index - name size (byte.bit)
0x7000:01 [▶ 156] - Ctrl (1.0) 0x7000:02 [▶ 156] - Value (2.0)	Objects for normal operation mode: 0x1601 [▶ 157] - Outputs (4.0) Objects for enhanced operation mode: 0x1602 - ENC Control compact (4.0) 0x1603 - ENC Control (6.0)

0x1601 - Outputs (4.0)	
Contents Index - name size (byte.bit)	Excluded PDOs Index - name size (byte.bit)
0x7000:01 [▶ 156] - Ctrl (1.0) 0x7000:02 [▶ 156] - Value (2.0)	Objects for normal operation mode: 0x1600 [▶ 156] - Outputs (3.0) Objects for enhanced operation mode: 0x1602 - ENC Control compact (4.0) 0x1603 - ENC Control (6.0)

14.1.2.3 Predefined PDO Assignment

The "Predefined PDO Assignment" enables a simplified selection of the process data. The desired function is selected on the lower part of the Process Data tab. As a result, all necessary PDOs are automatically activated and the unnecessary PDOs are deactivated.

The screenshot shows the 'Process Data' configuration window. It includes several sections:

- Sync Manager:** A table with columns SM, Size, Type, and Flags.

SM	Size	Type	Flags
0	48	MbxOut	
1	48	MbxIn	
2	3	Outputs	
3	5	Inputs	
- PDO List:** A table with columns Index, Size, Name, Flags, SM, and SI.

Index	Size	Name	Flags	SM	SI
0x1A00	5.0	Inputs	F	3	0
0x1A01	6.0	Inputs	F		0
0x1A02	8.0	Inputs	F		0
0x1A03	6.0	ENC Status compact	F		0
0x1A04	10.0	ENC Status	F		0
0x1A05	4.0	ENC Frequency	F		0
0x1A06	4.0	ENC Period	F		0
0x1A07	8.0	ENC Timest.	F		0
0x1A08	4.0	ENC Timest. compact	F		0
0x1600	3.0	Outputs	F	2	0
0x1601	4.0	Outputs	F		0
0x1602	4.0	ENC Control compact	F		0
0x1603	6.0	ENC Control	F		0
- PDO Assignment (0x1C13):** A list of checkboxes for PDO indices 0x1A00 through 0x1A08. 0x1A00 is checked, while others are excluded by it.
- PDO Content (0x1A00):** A table with columns Index, Size, Offs, Name, and Type.

Index	Size	Offs	Name	Type
0x6000:01	1.0	0.0	Status	USINT
0x6000:02	2.0	1.0	Value	UINT
0x6000:03	2.0	3.0	Latch	UINT
		5.0		
- Download:** A section with checkboxes for 'PDO Assignment' (checked) and 'PDO Configuration'.
- Predefined PDO Assignment:** A dropdown menu showing 'Legacy (MDP 510)' as the selected option. Other options include 'Standard 16 Bit (MDP 511)', 'Standard 32 Bit (MDP 511)', 'Line Motion (MDP 511)', and 'Line Motion DC (MDP 511)'.

Fig. 159: EL5101 - Process data, Predefined PDO (Legacy (MDP 510))

For the normal operation mode one PDO assignments is available in mode "Legacy".

Predefined PDO assignment for Legacy mode

Predefined PDO Assignment	PDO Assignment
Legacy (MDP 510)	SM3: 0x1A00 [▶_149] - Inputs (5.0) SM2: 0x1600 [▶_150] - Outputs (3.0)

14.1.3 Features CoE

NOTICE



Parameterization via the CoE list (CAN over EtherCAT)

The EtherCAT device is parameterized via the CoE - Online tab (with a double click on the respective object) or via the Process Data tab (assignment of PDOs). A detailed description can be found in the EtherCAT System-Documentation in chapter “[EtherCAT subscriber configuration](#)”

Please note the general CoE notes in the EtherCAT System Documentation in chapter “[CoE-interface](#)” when using/manipulating the CoE parameters:

- Keep a startup list if components have to be replaced
- Differentiation between online/offline dictionary,
- existence of current XML description
- use "CoE reload" for resetting changes

Depending on the main PDO/optional PDOs further settings can be selected in the CoE (CAN over EtherCAT list).

The following CoE settings from objects [0x8000 \[▸ 155\]](#) and [0x8001 \[▸ 155\]](#) are possible and are shown below in their default settings:

Index	Name	Flags	Value
8000:0	Non-Volatile Settings 0	RW	> 5 <
8000:01	Enable register reload	RW	FALSE
8000:02	Enable index reset	RW	FALSE
8000:03	Enable FWD count	RW	FALSE
8000:04	Enable pos. gate	RW	TRUE
8000:05	Enable neg. gate	RW	FALSE
8001:0	Non-Volatile Settings 1	RW	> 2 <
8001:01	Frequency window	RW	0x0064 (100)
8001:02	Counter reload value	RW	0xFFFF (65535)
8010:0	ENC Settings	RW	> 22 <

Fig. 160: “CoE-Online” tab

The parameters are described on page [object description and parameterization \[▸ 154\]](#).

Register Reload

If Register Reload is enabled in CoE object [0x8000:01 \[▸ 155\]](#), the counter value is set

- to zero in the event of overflow over the value in CoE object [0x8001:02 \[▸ 155\]](#) and
- to the value in CoE object [0x8001:02 \[▸ 155\]](#) in the event of underflow below 0.

Index Reset

If Index Reset is enabled in CoE object [0x8000:02 \[▸ 155\]](#), input C resets the counter to 0.



“Register Reload” and “Index Reset”

“Register Reload” and “Index Reset” cannot be operated simultaneously.

Forward/backward counter “Enable FWD count”

If “Enable FWD Count” is activated in CoE object [0x8000:03 \[▶ 155\]](#), the EL5101 operates as counter on channel A. Channel B indicates the counting direction: B=TRUE forward, B=FALSE backward. The counter can be locked via the gate input (24 V).

- CoE object [0x8000:04 \[▶ 155\]](#) (TRUE):
Locking of the counter at the gate input with positive edge (0 V -> + 24 V).
- CoE object [0x8000:05 \[▶ 155\]](#) (TRUE):
Locking of the counter at the gate input with negative edge (+ 24 V -> + 0 V).

Frequency

- The timeframe for the frequency calculation is set to 10 ms (see Fig. “Process data” tab); in addition a variably configurable measuring window is available (parameterization via object [0x8001:01 \[▶ 155\]](#), output frequency value in object [0x6000:06 \[▶ 155\]](#))
- Only the increment edges in the specified time window are counted.
- If no edge change occurs for approx. 1.6 s, any frequency specification is cancelled.
- This calculation is carried out in the slave without reference to the distributed clocks system. It is therefore independent of the DC mode.
- No frequency measurement is possible if the counter is blocked by the gate. In this case the period can be measured regardless.
- If an encoder signal is only present at input A/A and the frequency/period is to be measured, the terminal must be set to “Enable FWD count” in CoE [0x8000:03 \[▶ 155\]](#).
- A C or external reset restarts the frequency measurement. The last frequency value remains unchanged until a new frequency value is determined.

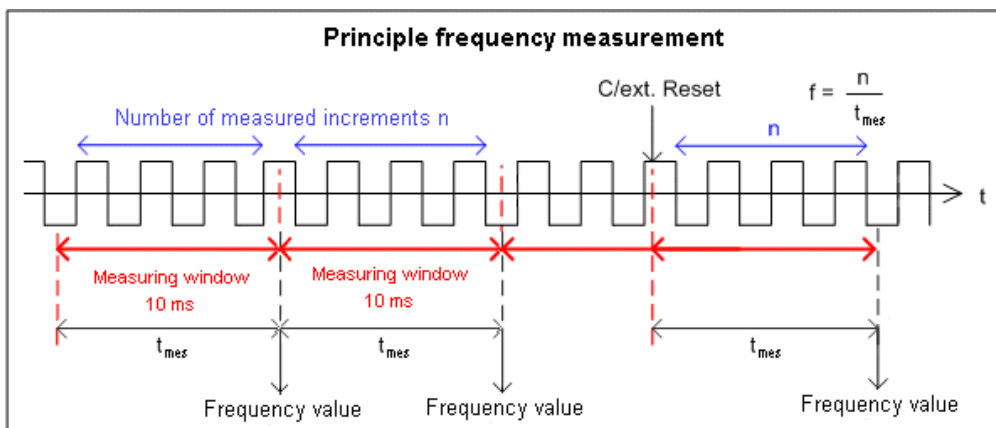

Fig. 161: Frequency measurement principle in normal operation mode

Period calculation

- This calculation is carried out in the slave without reference to the distributed clocks system. It is therefore independent of the DC mode.
- In each cycle the interval between two positive edges of input A is counted with a resolution of 100 ns.
- If no edge change occurs for approx. 1.6 s, any period specification is cancelled.

● Frequency and period measurement

I From the explanatory notes above it is apparent that the frequency measurement can measure the current axis status (velocity) significantly more accurately than the period measurement. Frequency measurement is therefore preferable, if possible.

Latch

Latch control is implemented via the [control and status word \[▶ 160\]](#).

14.1.4 Object description and parameterization - normal operation mode

i EtherCAT XML Device Description

The display matches that of the CoE objects from the EtherCAT XML Device Description. We recommend downloading the latest XML file from the download area of the Beckhoff website and installing it according to installation instructions.

NOTICE



Parameterization via the CoE list (CAN over EtherCAT)

The EtherCAT device is parameterized via the CoE - Online tab (with a double click on the respective object) or via the Process Data tab (assignment of PDOs). A detailed description can be found in the EtherCAT System-Documentation in chapter "[EtherCAT subscriber configuration](#)"

Please note the general CoE notes in the EtherCAT System Documentation in chapter "[CoE-interface](#)" when using/manipulating the CoE parameters:

- Keep a startup list if components have to be replaced
- Differentiation between online/offline dictionary,
- existence of current XML description
- use "CoE reload" for resetting changes

14.1.4.1 Restore object

Index 1011 Restore default parameters

Index (hex)	Name	Meaning	Data type	Flags	Default
1011:0	Restore default parameters [▶ 273]	Restore default parameters	UINT8	RO	0x01 (1 _{dec})
1011:01	SubIndex 001	If this object is set to " 0x64616F6C " in the set value dialog, all backup objects are reset to their delivery state.	UINT32	RW	0x00000000 (0 _{dec})

14.1.4.2 Configuration data

Index 8000 Non-Volatile Settings 0

Index (hex)	Name	Meaning	Data type	Flags	Default
8000:0	Non-Volatile Settings 0	Maximum subindex	UINT8	RO	0x05 (5 _{dec})
8000:01	Enable register reload [▶ 152]	The counter counts up to the “Counter reload value”, or the “Counter reload value” (0x8001:02 [▶ 155]) is loaded in the event of an underflow Example 360° encoder with set bit: Moves in positive direction via Counter reload value [▶ 155]: Reset counter value to 0. Moves in negative direction less than 0: Reset counter value to Counter reload value [▶ 155].	BOOLEAN	RW	0x00 (0 _{dec})
8000:02	Enable index reset [▶ 152]	Activates input “C” for resetting the counter. Example 360° encoder with set bit: Moves in positive direction (signal at input “C”): Reset counter value to 0 Moves in negative direction (signal at input “C”): underflow with FFFF, FFFE etc.)	BOOLEAN	RW	0x00 (0 _{dec})
8000:03	Enable FWD count [▶ 153]	FALSE The terminal operates in quadrature decoder mode TRUE The terminal operates as counter, count direction to input B	BOOLEAN	RW	0x00 (0 _{dec})
8000:04	Enable pos. gate [▶ 153]	Gate input responds to positive edge and locks the counter	BOOLEAN	RW	0x01 (1 _{dec})
8000:05	Enable neg. gate [▶ 153]	Gate input responds to negative edge and locks the counter	BOOLEAN	RW	0x00 (0 _{dec})

Index 8001 Non-Volatile Settings 1

Index (hex)	Name	Meaning	Data type	Flags	Default
8001:0	Non-Volatile Settings 1	Maximum subindex	UINT8	RO	0x02 (2 _{dec})
8001:01	Frequency window [▶ 153]	The value specifies the size of the time window for the “Window [▶ 155]” variable. resolution: 16 µs; e.g. default value: 16 µs x 100 _{dec} = 1.6 ms	UINT16	RW	0x0064 (100 _{dec})
8001:02	Counter reload value [▶ 152]	If “ Enable register reload [▶ 155]” = TRUE, the counter counts up to this value and is loaded with this value in the event of an underflow	UINT16	RW	0xFFFF (65535 _{dec})

14.1.4.3 Input data

Index 6000 Inputs

Index (hex)	Name	Meaning	Data type	Flags	Default
6000:0	Inputs	Length of this object	UINT8	RO	0x06 (6 _{dec})
6000:01	Status	Status byte [▶ 160]	UINT8	RO	0x00 (0 _{dec})
6000:02	Value	meter reading	UINT16	RO	0x0000 (0 _{dec})
6000:03	Latch	Latch value	UINT16	RO	0x0000 (0 _{dec})
6000:04	Frequency	Frequency value (resolution: 0.01 Hz / digit) [fixed 10 ms measuring window]	UINT32	RO	0x00000000 (0 _{dec})
6000:05	Period	Period (resolution 500 ns / digit)	UINT16	RO	0x0000 (0 _{dec})
6000:06	Window	Measured value of the variable timeframe (“Frequency window” (0x8001:01 [▶ 155]))	UINT16	RO	0x0000 (0 _{dec})

14.1.4.4 Output data

Index 7000 Outputs

Index (hex)	Name	Meaning	Data type	Flags	Default
7000:0	Outputs	Length of this object	UINT8	RO	0x02 (2 _{dec})
7000:01	Ctrl [▶_160]	Control byte [▶_160]	UINT8	RO	0x00 (0 _{dec})
7000:02	Value	The counter value to be set via CNT_SET (CB_02 [▶_160]).	UINT16	RO	0x0000 (0 _{dec})

14.1.4.5 Standard objects

The standard objects have the same meaning for all EtherCAT slaves.

Index 1000 Device type

Index (hex)	Name	Meaning	Data type	Flags	Default
1000:0	Device type	Device type of the EtherCAT slave: the Lo-Word contains the CoE profile used (5001). The Hi-Word contains the module profile according to the modular device profile.	UINT32	RO	0x00001389 (5001 _{dec})

Index 1008 Device name

Index (hex)	Name	Meaning	Data type	Flags	Default
1008:0	Device name	Device name of the EtherCAT slave	STRING	RO	EL5101

Index 1009 Hardware version

Index (hex)	Name	Meaning	Data type	Flags	Default
1009:0	Hardware version	Hardware version of the EtherCAT slave	STRING	RO	09

Index 100A Software version

Index (hex)	Name	Meaning	Data type	Flags	Default
100A:0	Software version	Firmware version of the EtherCAT slave	STRING	RO	10

Index 1018 Identity

Index (hex)	Name	Meaning	Data type	Flags	Default
1018:0	Identity	Information for identifying the slave	UINT8	RO	0x04 (4 _{dec})
1018:01	Vendor ID	Vendor ID of the EtherCAT slave	UINT32	RO	0x00000002 (2 _{dec})
1018:02	Product code	Product code of the EtherCAT slave	UINT32	RO	0x13ED3052 (334311506 _{dec})
1018:03	Revision	Revision number of the EtherCAT slave; the low word (bit 0-15) indicates the special terminal number, the high word (bit 16-31) refers to the device description	UINT32	RO	0x03F90000 (66650112 _{dec})
1018:04	Serial number	Serial number of the EtherCAT slave; the low byte (bit 0-7) of the low word contains the year of production, the high byte (bit 8-15) of the low word contains the week of production, the high word (bit 16-31) is 0	UINT32	RO	0x00000000 (0 _{dec})

Index 1600 RxPDO-Map Outputs

Index (hex)	Name	Meaning	Data type	Flags	Default
1600:0	RxPDO-Map Outputs	PDO Mapping RxPDO 1	UINT8	RO	0x02 (2 _{dec})
1600:01	SubIndex 001	1. PDO Mapping entry (object 0x7000 (Outputs), entry 0x01 (Ctrl))	UINT32	RO	0x7000:01, 8
1600:02	SubIndex 002	2. PDO Mapping entry (object 0x7000 (Outputs), entry 0x02 (Value))	UINT32	RO	0x7000:02, 16

Index 1601 RxPDO-Map Outputs Word-Aligned

Index (hex)	Name	Meaning	Data type	Flags	Default
1601:0	RxPDO-Map Outputs Word-Aligned	PDO Mapping RxPDO 2	UINT8	RO	0x03 (3 _{dec})
1601:01	SubIndex 001	1. PDO Mapping entry (object 0x7000 (Outputs), entry 0x01 (Ctrl))	UINT32	RO	0x7000:01, 8
1601:02	SubIndex 002	2. PDO Mapping entry (8 bits align)	UINT32	RO	0x0000:00, 8
1601:03	SubIndex 003	3. PDO Mapping entry (object 0x7000 (Outputs), entry 0x02 (Value))	UINT32	RO	0x7000:02, 16

Index 1A00 TxPDO-Map Inputs

Index (hex)	Name	Meaning	Data type	Flags	Default
1A00:0	TxPDO-Map Inputs	PDO Mapping TxPDO 1	UINT8	RO	0x03 (3 _{dec})
1A00:01	SubIndex 001	1. PDO Mapping entry (object 0x6000 (Inputs), entry 0x01 (Status))	UINT32	RO	0x6000:01, 8
1A00:02	SubIndex 002	2. PDO Mapping entry (object 0x6000 (Inputs), entry 0x02 (Value))	UINT32	RO	0x6000:02, 16
1A00:03	SubIndex 003	3. PDO Mapping entry (object 0x6000 (Inputs), entry 0x03 (Latch))	UINT32	RO	0x6000:03, 16

Index 1A01 TxPDO-Map Inputs Word-Aligned

Index (hex)	Name	Meaning	Data type	Flags	Default
1A01:0	TxPDO-Map Inputs Word-Aligned	PDO Mapping TxPDO 2	UINT8	RO	0x04 (4 _{dec})
1A01:01	SubIndex 001	1. PDO Mapping entry (object 0x6000 (Inputs), entry 0x01 (Status))	UINT32	RO	0x6000:01, 8
1A01:02	SubIndex 002	2. PDO Mapping entry (8 bits align)	UINT32	RO	0x0000:00, 8
1A01:03	SubIndex 003	3. PDO Mapping entry (object 0x6000 (Inputs), entry 0x02 (Value))	UINT32	RO	0x6000:02, 16
1A01:04	SubIndex 004	4. PDO Mapping entry (object 0x6000 (Inputs), entry 0x03 (Latch))	UINT32	RO	0x6000:03, 16

Index 1A02 TxPDO-Map Inputs Optional

Index (hex)	Name	Meaning	Data type	Flags	Default
1A02:0	TxPDO-Map Inputs Optional	PDO Mapping TxPDO 3	UINT8	RO	0x03 (3 _{dec})
1A02:01	SubIndex 001	1. PDO Mapping entry (object 0x6000 (Inputs), entry 0x04 (Frequency))	UINT32	RO	0x6000:04, 32
1A02:02	SubIndex 002	2. PDO Mapping entry (object 0x6000 (Inputs), entry 0x05 (Period))	UINT32	RO	0x6000:05, 16
1A02:03	SubIndex 003	3. PDO Mapping entry (object 0x6000 (Inputs), entry 0x06 (Window))	UINT32	RO	0x6000:06, 16

Index 1C00 Sync manager type

Index (hex)	Name	Meaning	Data type	Flags	Default
1C00:0	Sync manager type	Using the sync managers	UINT8	RO	0x04 (4 _{dec})
1C00:01	SubIndex 001	Sync-Manager Type Channel 1: Mailbox Write	UINT8	RO	0x01 (1 _{dec})
1C00:02	SubIndex 002	Sync-Manager Type Channel 2: Mailbox Read	UINT8	RO	0x02 (2 _{dec})
1C00:03	SubIndex 003	Sync-Manager Type Channel 3: Process Data Write (Outputs)	UINT8	RO	0x03 (3 _{dec})
1C00:04	SubIndex 004	Sync-Manager Type Channel 4: Process Data Read (Inputs)	UINT8	RO	0x04 (4 _{dec})

Index 1C12 RxPDO assign

Index (hex)	Name	Meaning	Data type	Flags	Default
1C12:0	RxPDO assign	PDO Assign Outputs	UINT8	RW	0x01 (1 _{dec})
1C12:01	SubIndex 001	1 st allocated RxPDO (contains the index of the associated RxPDO mapping object)	UINT16	RW	0x1600 (5632 _{dec})

Index 1C13 TxPDO assign

Index (hex)	Name	Meaning	Data type	Flags	Default
1C13:0	TxPDO assign	PDO Assign Inputs	UINT8	RW	0x01 (1 _{dec})
1C13:01	SubIndex 001	1 st allocated TxPDO (contains the index of the associated TxPDO mapping object)	UINT16	RW	0x1A00 (6656 _{dec})
1C13:02	SubIndex 002	2 nd allocated TxPDO (contains the index of the associated TxPDO mapping object)	UINT16	RW	0x0000 (0 _{dec})
1C13:03	SubIndex 003	3 rd allocated TxPDO (contains the index of the associated TxPDO mapping object)	UINT16	RW	0x0000 (0 _{dec})

Index 1C32 SM output parameter

Index (hex)	Name	Meaning	Data type	Flags	Default
1C32:0	SM output parameter	Synchronization parameters for the outputs	UINT8	RO	0x20 (32 _{dec})
1C32:01	Sync mode	Current synchronization mode: <ul style="list-style-type: none"> 0: Free Run 1: Synchron with SM 2 Event 2: DC-Mode - Synchron with SYNC0 Event 3: DC-Mode - Synchron with SYNC1 Event 	UINT16	RW	0x0001 (1 _{dec})
1C32:02	Cycle time	Cycle time (in ns): <ul style="list-style-type: none"> Free Run: Cycle time of the local timer Synchronous with SM 2 event: Master cycle time DC mode: SYNC0/SYNC1 Cycle Time 	UINT32	RW	0x00000000 (0 _{dec})
1C32:03	Shift time	Time between SYNC0 event and output of the outputs (in ns, DC mode only)	UINT32	RO	0x00000000 (0 _{dec})
1C32:04	Sync modes supported	Supported synchronization modes: <ul style="list-style-type: none"> Bit 0 = 1: free run is supported Bit 1 = 1: Synchronous with SM 2 event is supported Bit 2-3 = 01: DC mode is supported Bit 4-5 = 10: Output shift with SYNC1 event (only DC mode) Bit 14 = 1: dynamic times (measurement through writing of 0x1C32:08) 	UINT16	RO	0xC007 (49159 _{dec})
1C32:05	Minimum cycle time	Minimum cycle time (in ns)	UINT32	RO	0x00000000 (0 _{dec})
1C32:06	Calc and copy time	Minimum time between SYNC0 and SYNC1 event (in ns, DC mode only)	UINT32	RO	0x00000000 (0 _{dec})
1C32:08	Command	<ul style="list-style-type: none"> 0: Measurement of the local cycle time is stopped 1: Measurement of the local cycle time is started <p>The entries 0x1C32:03, 0x1C32:05, 0x1C32:06, 0x1C32:09, 0x1C33:03, 0x1C33:06, 0x1C33:09 are updated with the maximum measured values. For a subsequent measurement the measured values are reset</p>	UINT16	RW	0x0000 (0 _{dec})
1C32:09	Delay time	Time between SYNC1 event and output of the outputs (in ns, DC mode only)	UINT32	RO	0x00000000 (0 _{dec})
1C32:0B	SM event missed counter	Number of missed SM events in OPERATIONAL (DC mode only)	UINT16	RO	0x0000 (0 _{dec})
1C32:0C	Cycle exceeded counter	Number of occasions the cycle time was exceeded in OPERATIONAL (cycle was not completed in time or the next cycle began too early)	UINT16	RO	0x0000 (0 _{dec})
1C32:0D	Shift too short counter	Number of occasions that the interval between SYNC0 and SYNC1 event was too short (DC mode only)	UINT16	RO	0x0000 (0 _{dec})
1C32:20	Sync error	The synchronization was not correct in the last cycle (outputs were output too late; DC mode only)	BOOLEAN	RO	0x00 (0 _{dec})

Index F000 Modular device profile

Index (hex)	Name	Meaning	Data type	Flags	Default
F000:0	Modular device profile	General information for the modular device profile	UINT8	RO	0x02 (2 _{dec})
F000:01	Module index distance	Index spacing of the objects of the individual channels	UINT16	RO	0x0010 (16 _{dec})
F000:02	Maximum number of modules	Number of channels	UINT16	RO	0x0002 (2 _{dec})

Index F008 Code word

Index (hex)	Name	Meaning	Data type	Flags	Default
F008:0	Code word	reserved	UINT32	RW	0x00000000 (0 _{dec})

14.1.5 Control and status byte

Control byte

The control byte (CB) is located in the output process image, and is transmitted from the controller to the terminal.

Bit	CB.7	CB.6	CB.5	CB.4	CB.3	CB.2	CB.1	CB.0
Name	-	-	-	-	EN_LATCH_EXTN	CNT_SET	EN_LATCH_EXTP	EN_LATC

Legend

Bit	Name	Description
CB.3	EN_LATCH_EXTN	1 _{bin} With a valid EN_LATCH_EXTN bit the counter value is stored in latch input (index 0x6000:03 [► 155]) when the first external latch pulse with falling edge is encountered. Subsequent pulses have no influence on the latch value. Please note: A new counter value can only be written to the latch input when the Latch Valid bit (LAT_EXT_VAL) in the status byte has a low signal level.
CB.2	CNT_SET	rise The counter is set with rising edge of CNT_SET to the value specified via the process data (index 0x7000:02 [► 156]).
CB.1	EN_LATCH_EXTP	1 _{bin} With a valid EN_LATCH_EXTP bit the counter value is stored in latch input (index 0x6000:03 [► 155]) when the first external latch pulse with rising edge is encountered. Subsequent pulses have no influence on the latch value. Please note: A new counter value can only be written to the latch input when the Latch Valid bit (LAT_EXT_VAL) in the status byte has a low signal level.
CB.0	EN_LATC	1 _{bin} The null point latch (C input) is activated. The counter value is saved when the first external latch pulse after a valid EN_LATC bit encountered (this has priority over EN_LAT_EXTN / EN_LAT_EXTP). If the bit is set subsequent pulses have no influence on the latch value. Please note: A new counter value can only be written to the latch input when the Latch Valid bit (LATC_VAL) in the status byte has a low signal level (the LATC_VAL bit (SB.0) is only cleared by the terminal when the C pulse = LOW).

Status byte

The status byte (SB) is located in the input process image, and is transmitted from terminal to the controller.

Bit	SB.7	SB.6	SB.5	SB.4	SB.3	SB.2	SB.1	SB.0
Name	-	-	STATUS_INPUT	OVERFLOW	UNDERFLOW	CNTSET_ACC	LAT_EXT_VAL	LATC_VAL

Legend

Bit	Name	Description
SB.5	STATUS_INPUT	0 _{bin} / 1 _{bin} Indicates the status of INPUT 1
SB.4	OVERFLOW	1 _{bin} This bit is set if the 16-bit counter overflows (65535 to 0). It is reset when the counter exceeds one third of its measuring range (21845 to 21846) or immediately an underflow occurs.
SB.3	UNDERFLOW	1 _{bin} This bit is set if the 16-bit counter underflows (0 to 65535). It is reset when the counter drops below two thirds of its measuring range (43690 to 43689) or immediately an overflow occurs.
SB.2	CNTSET_ACC	1 _{bin} The data for setting the counter (index 0x7000:02 [► 156]) is accepted from the terminal.
SB.1	LAT_EXT_VAL	1 _{bin} An external latch pulse has occurred. The data with index 0x6000:03 [► 155] match the latched value when the bit is set. To reactivate the latch input EN_LAT_EXTN or EN_LATCH_EXTP (CB.3 or CB.1) has first to be cleared and then to be set once more.
SB.0	LATC_VAL	1 _{bin} A zero point latch has occurred. The data with index 0x6000:03 [► 155] match the latched value when the bit is set. In order to reactivate the latch input, it is necessary for EN_LATC (CB.0) first be cleared and then to be set once more.

14.1.6 Single-ended connection for TTL encoder

In addition to encoders with differential RS422 interface, single-ended encoders with TTL interface are also supported. Please note the following:

- Operating mode selection encoder [0x8000:03 \[▶ 155\]](#) "Enable FWD count" = FALSE.
- The differential inputs (/A, /B, /C) must remain open and must not be connected to ground

14.2 Enhanced operation mode

14.2.1 Operation modes

In EL5101 “enhanced operation mode” the following modes are available:

Mode	DC	Main PDO	Comment	Optional PDO 1	Comment	Optional PDO 2	Comment	Features CoE	Comment
7	FreeRun	0x1A04 [▶_186] + 0x1603 [▶_182]	Count/Latch in 32 bit	0x1A05 [▶_186] or 0x1A06 [▶_186]	Frequency (32 bit) or Period (32 bit)	--		0x8010 [▶_177]:nn	CoE combinations 0x8010 [▶_177]:nn
8	"	0x1A03 [▶_185] + 0x1602 [▶_182]	compact: Count/Latch in 16 bit	"	"	--		"	"
9	DC/DCi	0x1A04 [▶_186] + 0x1603 [▶_182]	Count/Latch in 32 bit	"	"	0x1A07 [▶_186] or 0x1A08 [▶_187]	Timestamp 64 bit Timestamp 32 bit (compact)	"	"
10	"	0x1A03 [▶_185] + 0x1602 [▶_182]	compact: Count/Latch in 16 bit	"	"	"	"	"	"

Other settings may result in irregular process data and lead to error messages in the TwinCAT System Manager logger window.

● Parameterization



- Use a [CoE reset \[▶_273\]](#) in order to deactivate any previous settings
- In order to activate the new operating mode, reload the EtherCAT slaves ( button)

DC (Distributed Clocks)

Describes whether the terminal is operated with distributed clocks support:

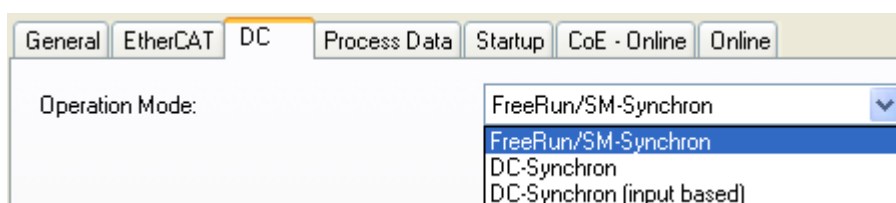

Fig. 162: “DC” tab

- **FreeRun:** the terminal operates frame-triggered. Cyclic operation is started via the SyncManagers of the EtherCAT frame processing.
- **DC-Synchron:** cyclic operation in the terminal is started by the local distributed clock at exact intervals. The start time is chosen such that it coincides with other output slaves in the EtherCAT system.
- **DC-Synchron (input based):** as DC-Synchron mode, with the cyclic start time chosen such that it coincides with other input slaves in the EtherCAT system.

14.2.2 Process data

Main PDO

Selection of basic process data

General EtherCAT DC **Process Data** Plc Startup CoE - Online Online

Sync Manager:

SM	Size	Type	Flags
0	48	MbxOut	
1	48	MbxIn	
2	4	Outputs	
A 3	6	Inputs	

PDO List:

Index	Size	Name	Flags	SM	SU
0x1A00	5.0	Inputs	F	0	
0x1A01	6.0	Inputs	F	0	
0x1A02	8.0	Inputs	F	0	
C 0x1A03	6.0	ENC Status compact	F	3	0
C 0x1A04	10.0	ENC Status	F	0	0
0x1A05	4.0	ENC Frequency	F	0	0
0x1A06	4.0	ENC Period	F	0	0
0x1A07	8.0	ENC Timest.	F	0	0
0x1A08	4.0	ENC Timest. compact	F	0	0
0x1600	3.0	Outputs	F	0	0
0x1601	4.0	Outputs	F	0	0
0x1602	4.0	ENC Control compact	F	2	0
0x1603	6.0	ENC Control	F	0	0

PDO Assignment (0x1C13):

B 0x1A00 (excluded by 0x1A03)
 0x1A01 (excluded by 0x1A03)
 0x1A02 (excluded by 0x1A03)
 0x1A03
 0x1A04 (excluded by 0x1A03)
 0x1A05
 0x1A06
 0x1A07
 0x1A08

PDO Content (0x1A03):

Index	Size	Offs	Name	Type
0x6010:01	0.1	0.0	Status__Latch C valid	BIT
0x6010:02	0.1	0.1	Status__Latch extern valid	BIT
0x6010:03	0.1	0.2	Status__Set counter done	BIT
0x6010:04	0.1	0.3	Status__Counter underflow	BIT
0x6010:05	0.1	0.4	Status__Counter overflow	BIT
0x6010:06	0.1	0.5	Status__Status of input status	BIT

Download
 PDO Assignment
 PDO Configuration

Predefined PDO Assignment: 'Standard 16 Bit (MDP 511)'
 Load PDO info from device
 Sync Unit Assignment...

Fig. 163: "Process data" tab

A: Selection of data direction: input or output

B: Selection of (optional) PDOs (process data objects)

C: Explanatory notes for PDOs

compact: The process data can be represented with 16 bits (compact) or with 32 bits.

Optional PDOs

Optional PDOs, in addition to the main PDO:

- PDO 1 (0x1A05 [▶ 186] or 0x1A06 [▶ 186]): The **frequency** or the **period** can be selected as optional PDO 1
- PDO 2 (0x1A07 [▶ 186] or 0x1A08 [▶ 187]): In one of the DC modes a 64 bit or 32 bit **timestamp** can be selected. The timestamp specifies the time of the last registered increment edge, based on the DistributedClocks system.

Process data description

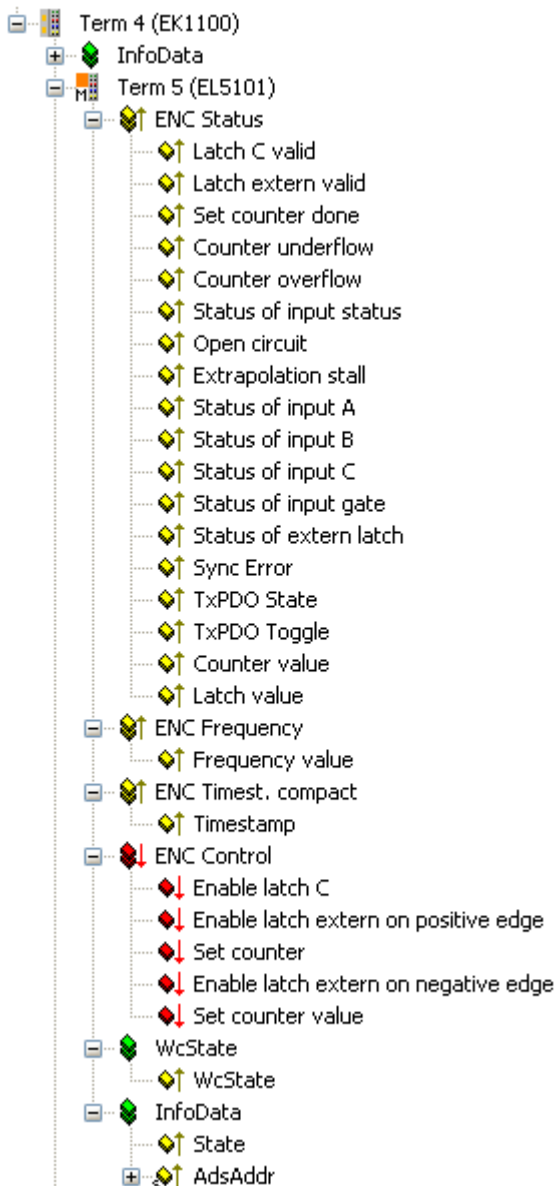

Fig. 164: Process data description

The process data are generated from CoE objects 0x6010 (inputs) and 0x7010 (outputs) and are described in section [Object description and parameterization \[► 176\]](#)

14.2.2.1 Sync Manager (SM)

The scope of process data offered can be modified via the "Process Data" tab (see Fig. *EL5101 - Process Data tab SM3, (Standard 16 Bit (MDP)* below).

A detailed description for setting the process data can be found in chapter *Process Data tab* [▶ 126].

General EtherCAT DC Process Data Plc Startup CoE - Online Online

Sync Manager:

SM	Size	Type	Flags
0	48	MbxOut	
1	48	MbxIn	
2	4	Outputs	
3	6	Inputs	

PDO List:

Index	Size	Name	Flags	SM	SU
0x1A00	5.0	Inputs	F		0
0x1A01	6.0	Inputs	F		0
0x1A02	8.0	Inputs	F		0
0x1A03	6.0	ENC Status compact	F	3	0
0x1A04	10.0	ENC Status	F		0
0x1A05	4.0	ENC Frequency	F		0
0x1A06	4.0	ENC Period	F		0
0x1A07	8.0	ENC Timest.	F		0
0x1A08	4.0	ENC Timest. compact	F		0
0x1600	3.0	Outputs	F		0
0x1601	4.0	Outputs	F		0
0x1602	4.0	ENC Control compact	F	2	0
0x1603	6.0	ENC Control	F		0

PDO Assignment (0x1C13):

- 0x1A00 (excluded by 0x1A03)
- 0x1A01 (excluded by 0x1A03)
- 0x1A02 (excluded by 0x1A03)
- 0x1A03
- 0x1A04 (excluded by 0x1A03)
- 0x1A05
- 0x1A06
- 0x1A07
- 0x1A08

PDO Content (0x1A03):

Index	Size	Offs	Name	Type
0x6010:01	0.1	0.0	Status__Latch C valid	BIT
0x6010:02	0.1	0.1	Status__Latch extem valid	BIT
0x6010:03	0.1	0.2	Status__Set counter done	BIT
0x6010:04	0.1	0.3	Status__Counter underflow	BIT
0x6010:05	0.1	0.4	Status__Counter overflow	BIT
0x6010:06	0.1	0.5	Status__Status of input status	BIT
0x6010:07	0.1	0.6	Status__Open circuit	BIT
0x6010:08	0.1	0.7	Status__Extrapolation stall	BIT
0x6010:09	0.1	1.0	Status__Status of input A	BIT
0x6010:0A	0.1	1.1	Status__Status of input B	BIT
0x6010:0B	0.1	1.2	Status__Status of input C	BIT
0x6010:0C	0.1	1.3	Status__Status of input gate	BIT
0x6010:0D	0.1	1.4	Status__Status of extem latch	BIT
0x6010:0E	0.1	1.5	Status__Sync error	BIT
0x6010:0F	0.1	1.6	Status__TxPDO State	BIT
0x6010:10	0.1	1.7	Status__TxPDO Toggle	BIT
0x6010:11	2.0	2.0	Counter value	UINT
0x6010:12	2.0	4.0	Latch value	UINT
		6.0		

Download

 PDO Assignment
 PDO Configuration

Predefined PDO Assignment: 'Standard 16 Bit (MDP 511)'

Load PDO info from device

Sync Unit Assignment...

Fig. 165: EL5101 - Process data SM3 tab (Standard 16 Bit (MDP 511))

14.2.2.2 PDO assignment

The EL5101 offers different process data objects (PDO) in normal and enhanced operation mode. The PDOs of the two operation modes are mutually exclusive.

In this chapter only the PDOs of the enhanced operation mode are described.

Excluded PDOs of the normal operation mode are shown in gray font in the following tables and are described in chapter “Normal operation mode [▶ 148]”.

14.2.2.2.1 SM3 - Inputs (0x1A03 .. 0x1A08)

0x1A03 - ENC Status compact (6.0)	
Contents Index - name size (byte.bit)	Excluded PDOs Index - name size (byte.bit)
0x6010:01 [▶ 179] - Status_Latch C valid (0.1)	Objects for normal operation mode: [▶ 149] 0x1A00 - Inputs (5.0) 0x1A01 - Inputs (6.0) 0x1A02 - Inputs (8.0) Objects for enhanced operation mode: 0x1A04 [▶ 186] - ENC Status (10.0)
0x6010:02 [▶ 179] - Status_Latch extern valid (0.1)	
0x6010:03 [▶ 179] - Status_Set counter done (0.1)	
0x6010:04 [▶ 179] - Status_Counter underflow (0.1)	
0x6010:05 [▶ 179] - Status_Counter overflow (0.1)	
0x6010:06 [▶ 179] - Status_Status of input status (0.1)	
0x6010:07 [▶ 179] - Status_Open circuit (0.1)	
0x6010:08 [▶ 179] - Status_Extrapolation stall (0.1)	
0x6010:09 [▶ 179] - Status_Status of input A (0.1)	
0x6010:0A [▶ 179] - Status_Status of input B (0.1)	
0x6010:0B [▶ 179] - Status_Status of input C (0.1)	
0x6010:0C [▶ 179] - Status_Status of input gate (0.1)	
0x6010:0D [▶ 179] - Status_Status of extern latch (0.1)	
0x6010:0E [▶ 179] - Status_Sync error (0.1)	
0x6010:0F [▶ 179] - Status_Status TxPDO State (0.1)	
0x6010:10 [▶ 179] - Status_Status TxPDO Toggle (0.1)	
0x6010:11 [▶ 179] - Counter value (2.0)	
0x6010:12 [▶ 179] - Latch value (2.0)	

0x1A04 - ENC Status (10.0)	
Contents Index - name size (byte.bit)	Excluded PDOs Index - name size (byte.bit)
0x6010:01 [▶ 179] - Status_Latch C valid (0.1)	Objects for normal operation mode: [▶ 149] 0x1A00 - Inputs (5.0) 0x1A01 - Inputs (6.0) 0x1A02 - Inputs (8.0) Objects for enhanced operation mode: 0x1A03 [▶ 185] - ENC Status compact (6.0)
0x6010:02 [▶ 179] - Status_Latch extern valid (0.1)	
0x6010:03 [▶ 179] - Status_Set counter done (0.1)	
0x6010:04 [▶ 179] - Status_Counter underflow (0.1)	
0x6010:05 [▶ 179] - Status_Counter overflow (0.1)	
0x6010:06 [▶ 179] - Status_Status of input status (0.1)	
0x6010:07 [▶ 179] - Status_Open circuit (0.1)	
0x6010:08 [▶ 179] - Status_Extrapolation stall (0.1)	
0x6010:09 [▶ 179] - Status_Status of input A (0.1)	
0x6010:0A [▶ 179] - Status_Status of input B (0.1)	
0x6010:0B [▶ 179] - Status_Status of input C (0.1)	
0x6010:0C [▶ 179] - Status_Status of input gate (0.1)	
0x6010:0D [▶ 179] - Status_Status of extern latch (0.1)	
0x6010:0E [▶ 179] - Status_Sync error (0.1)	
0x6010:0F [▶ 179] - Status_Status TxPDO State (0.1)	
0x6010:10 [▶ 179] - Status_Status TxPDO Toggle (0.1)	
0x6010:11 [▶ 179] - Counter value (4.0)	
0x6010:12 [▶ 179] - Latch value (4.0)	

0x1A05 - ENC Frequency (4.0)	
Contents Index - name size (byte.bit)	Excluded PDOs Index name size (byte.bit)
0x6010:13 [▶ 179] - Frequency value (4.0)	Objects for normal operation mode: [▶ 149] 0x1A00 - Inputs (5.0) 0x1A01 - Inputs (6.0) 0x1A02 - Inputs (8.0) Objects for enhanced operation mode: 0x1A06 [▶ 186] - ENC Period (4.0)

0x1A06 - ENC Period (4.0)	
Contents	Excluded PDOs
Index - name size (byte.bit)	Index name size (byte.bit)
0x6010:14 [▶ 179] - Period value (4.0)	Objects for normal operation mode: [▶ 149] 0x1A00 - Inputs (5.0) 0x1A01 - Inputs (6.0) 0x1A02 - Inputs (8.0) Objects for enhanced operation mode: 0x1A05 [▶ 186] - ENC Frequency (4.0)

0x1A07 - ENC Timest. (8.0)	
Contents	Excluded PDOs
Index - name size (byte.bit)	Index name size (byte.bit)
0x6010:16 [▶ 179] - Timestamp (8.0)	Objects for normal operation mode: [▶ 149] 0x1A00 - Inputs (5.0) 0x1A01 - Inputs (6.0) 0x1A02 - Inputs (8.0) Objects for enhanced operation mode: 0x1A08 [▶ 187] - ENC Timest. compact (4.0)

0x1A08 - ENC Timest. compact (4.0)	
Contents	Excluded PDOs
Index - name size (byte.bit)	Index name size (byte.bit)
0x6010:16 [▶ 179] - Timestamp (4.0)	Objects for normal operation mode: [▶ 149] 0x1A00 - Inputs (5.0) 0x1A01 - Inputs (6.0) 0x1A02 - Inputs (8.0) Objects for enhanced operation mode: 0x1A07 [▶ 186] - ENC Timest.(8.0)

14.2.2.2 SM2 - Outputs (0x1602 .. 0x1603)

0x1602 - ENC Control compact (4.0)	
Contents Index - name size (byte.bit)	Excluded PDOs Index - name size (byte.bit)
0x7010:01 [▶_180] - Control_Enable latch C (0.1)	Objects for normal operation mode: [▶_150] 0x1600 - Outputs (3.0) 0x1601 - Outputs (4.0) Objects for enhanced operation mode: 0x1603 [▶_182] - ENC Control (6.0)
0x7010:02 [▶_180] - Control_Enable latch extern on positive edge (0.1)	
0x7010:03 [▶_180] - Control_Set counter (0.1)	
0x7010:04 [▶_180] - Control_Enable latch extern on negative edge (0.1)	
0x7010:11 [▶_180] - Set counter value (2.0)	

0x1603 - ENC Control (6.0)	
Contents Index - name size (byte.bit)	Excluded PDOs Index - name size (byte.bit)
0x7010:01 [▶_180] - Control_Enable latch C (0.1)	Objects for normal operation mode: [▶_150] 0x1600 - Outputs (3.0) 0x1601 - Outputs (4.0) Objects for enhanced operation mode: 0x1602 [▶_182] - ENC Control compact (4.0)
0x7010:02 [▶_180] - Control_Enable latch extern on positive edge (0.1)	
0x7010:03 [▶_180] - Control_Set counter (0.1)	
0x7010:04 [▶_180] - Control_Enable latch extern on negative edge (0.1)	
0x7010:11 [▶_180] - Set counter value (4.0)	

14.2.2.3 Predefined PDO Assignment

The "Predefined PDO Assignment" enables a simplified selection of the process data. The desired function is selected on the lower part of the Process Data tab. As a result, all necessary PDOs are automatically activated and the unnecessary PDOs are deactivated.

General EtherCAT DC Process Data Plc Startup CoE - Online Online

Sync Manager:

SM	Size	Type	Flags
0	48	MbxOut	
1	48	MbxIn	
2	4	Outputs	
3	6	Inputs	

PDO List:

Index	Size	Name	Flags	SM	SU
0x1A00	5.0	Inputs	F		0
0x1A01	6.0	Inputs	F		0
0x1A02	8.0	Inputs	F		0
0x1A03	6.0	ENC Status compact	F	3	0
0x1A04	10.0	ENC Status	F		0
0x1A05	4.0	ENC Frequency	F		0
0x1A06	4.0	ENC Period	F		0
0x1A07	8.0	ENC Timest.	F		0
0x1A08	4.0	ENC Timest. compact	F		0
0x1600	3.0	Outputs	F		0
0x1601	4.0	Outputs	F		0
0x1602	4.0	ENC Control compact	F	2	0
0x1603	6.0	ENC Control	F		0

PDO Assignment (0x1C13):

- 0x1A00 (excluded by 0x1A03)
- 0x1A01 (excluded by 0x1A03)
- 0x1A02 (excluded by 0x1A03)
- 0x1A03
- 0x1A04 (excluded by 0x1A03)
- 0x1A05
- 0x1A06
- 0x1A07
- 0x1A08

PDO Content (0x1A03):

Index	Size	Offs	Name	Type
0x6010:01	0.1	0.0	Status__Latch C valid	BIT
0x6010:02	0.1	0.1	Status__Latch extem valid	BIT
0x6010:03	0.1	0.2	Status__Set counter done	BIT
0x6010:04	0.1	0.3	Status__Counter underflow	BIT
0x6010:05	0.1	0.4	Status__Counter overflow	BIT
0x6010:06	0.1	0.5	Status__Status of input status	BIT

Download

- PDO Assignment
- PDO Configuration

Predefined PDO Assignment: 'Standard 16 Bit (MDP 511)'

- Predefined PDO Assignment: (none)
- Predefined PDO Assignment: 'Legacy (MDP 510)'
- Predefined PDO Assignment: 'Standard 16 Bit (MDP 511)'
- Predefined PDO Assignment: 'Standard 32 Bit (MDP 511)'
- Predefined PDO Assignment: 'Line Motion (MDP 511)'
- Predefined PDO Assignment: 'Line Motion DC (MDP 511)'

Fig. 166: EL5101 - Process data, Predefined PDO (Default: Standard 16 Bit (MDP 511))

For the enhanced operation mode four PDO assignments are available in modes Standard, and "Line Motion".

Note on the use of timestamp function

I In order to be able to use the timestamp function, the EL5101 must be operated in "DC Synchron" or "DC Synchron (input based)" mode.

Predefined PDO Assignments for “Standard” mode

Predefined PDO Assignment	PDO Assignment
Standard 16 Bit (MDP 511)	SM3: 0x1A03 [▶ 185] - ENC Status compact (6.0) SM2: 0x1602 [▶ 182] - ENC Control compact (4.0)
Standard 32 Bit (MDP 511)	SM3: 0x1A04 [▶ 186] - ENC Status (10.0) SM2: 0x1603 [▶ 182] - ENC Control (6.0)

Predefined PDO Assignments for “Line Motion” mode

Predefined PDO Assignment	PDO Assignment
Line Motion (MDP 511)	SM3: 0x1A03 [▶ 185] - ENC Status compact (6.0) 0x1A06 [▶ 186] - ENC Period (4.0) SM2: 0x1602 [▶ 182] - ENC Control compact (4.0)
Line Motion DC (MDP 511)	SM3: 0x1A03 [▶ 185] - ENC Status compact (6.0) 0x1A08 [▶ 187] - ENC Timest. compact (4.0) SM2: 0x1602 [▶ 182] - ENC Control compact (4.0)

14.2.3 Features CoE

Depending on the main PDO/optional PDOs further settings can be selected in the CoE list (CAN over EtherCAT).

● Parameterization via the CoE list (CAN over EtherCAT)

- i** Please note the following general CoE information when using/manipulating the CoE parameters:
- Keep a startup list if components have to be replaced
 - Differentiation between online/offline dictionary,
 - existence of current XML description
 - Use “CoE reload [[▶ 273](#)]” for resetting changes

The following CoE settings are possible from object [0x8010 \[\[▶ 177\]\(#\)\]](#) and are shown below in their default settings:

Index	Name	Flags	Value	Unit
8001:0	Non-Volatile Settings 1	RW	> 2 <	
8010:0	ENC Settings	RW	> 23 <	
8010:01	Enable C reset	RW	FALSE	
8010:02	Enable extem reset	RW	FALSE	
8010:03	Enable up/down counter	RW	FALSE	
8010:04	Gate polarity	RW	Enable pos. gate (1)	
8010:08	Disable filter	RW	TRUE	
8010:0A	Enable micro increments	RW	FALSE	
8010:0B	Open circuit detection A	RW	TRUE	
8010:0C	Open circuit detection B	RW	TRUE	
8010:0D	Open circuit detection C	RW	FALSE	
8010:0E	Reversion of rotation	RW	FALSE	
8010:10	Extem reset polarity	RW	Rise (1)	
8010:11	Frequency window	RW	0x2710 (10000)	
8010:13	Frequency scaling	RW	0.01Hz (100)	
8010:14	Period scaling	RW	100ns (100)	
8010:15	Frequency resolution	RW	0.01Hz (100)	
8010:16	Period resolution	RW	100ns (100)	
8010:17	Frequency wait time	RW	0x0640 (1600)	
A010:0	ENC Diag data	RO	> 3 <	

Fig. 167: “CoE-Online” tab

The parameters are described on page [object description and parameterization \[\[▶ 176\]\(#\)\]](#).

Frequency

- The time window for the frequency calculation and the resolution can be parameterized in CoE objects [0x8010:11 \[▶ 177\]](#), [0x8010:13 \[▶ 177\]](#), [0x8010:15 \[▶ 177\]](#), [0x8010:17 \[▶ 177\]](#).
- The positive edges of track A are counted within the specified timeframe and the next edge including the time up to it are counted. The waiting time can be set in CoE object [0x8010:17](#) "Frequency Wait Time" (unit: ms). The default value is 1.6 sec. This is also the maximum value.
- The time window is 10 ms (default), min. 1 μ s. With the default setting it is possible to measure frequencies up to approx. 800 kHz. At higher frequencies a smaller value must be selected for the timeframe.
- The time is measured with a resolution of 100 ns.
- This calculation is carried out in the slave without reference to the distributed clocks system. It is therefore independent of the DC mode.
- No frequency measurement is possible if the counter is blocked by the gate. In this case the period can be measured regardless.
- If an encoder signal only is only present at input A/A and the frequency/period is to be measured, the terminal must be set to "Up/Down Counter" in CoE [0x8010:03 \[▶ 177\]](#).
- A C or external reset restarts the frequency measurement. The last frequency value remains unchanged until a new frequency value is determined.

Frequency measurement

- Basic unit 1 μ s: all window sizes

Measurement sequence

- The measurement starts with a positive edge at track A. The current counter value and time (resolution: 100 ns) are stored.
- After the measuring window time has elapsed (index [0x8010:11 \[▶ 177\]](#)), the system waits for the following rising edge at track A or a maximum of 1.6 sec or the time from [0x8010:17 \[▶ 177\]](#)
- The frequency is calculated from the edge difference and the actual elapsed time.

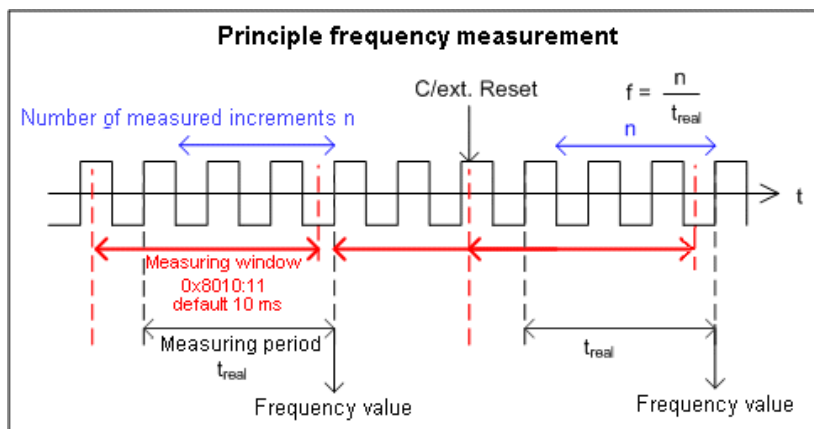

Fig. 168: Frequency measurement principle in enhanced operation mode

Period calculation

- This calculation is carried out in the slave without reference to the distributed clocks system. It is therefore independent of the DC mode.
- In each cycle the interval between two positive edges of input A is counted with a resolution of 100 ns.
- If no edge change occurs for approx. 1.6 s, any period specification is cancelled.

● Frequency and period measurement

I From the explanatory notes above it is apparent that the frequency measurement can measure the current axis status (velocity) significantly more accurately than the period measurement. Frequency measurement is therefore preferable, if possible.

Latch

- **Activation of latch C input (“C”) and saving (“latching”) of the counter value (index [0x70n0:01](#) [[▶ 180](#)])**
 - The counter value is saved at the first external latch pulse (positive edge at input “C”) after the bit has been set (TRUE) in index [0x7010:01](#) [[▶ 180](#)] (has priority before [0x7010:02](#) [[▶ 180](#)] / [0x7010:04](#) [[▶ 180](#)]). The subsequent pulses at the other inputs have no influence on the latch value in index [0x6010:12](#) [[▶ 179](#)] if the bit is set.
 - Note for “Latch C valid” bit: A new counter value at the latch input can only be written once the value of the “Latch C valid” bit (index [0x6010:01](#) [[▶ 179](#)]) is FALSE.
- **Activation of the external latch input (“gate/latch”) and latching of the counter value (index [0x7010:02](#) [[▶ 180](#)], [0x7010:04](#) [[▶ 180](#)])**
 - The counter value at the latch input (Index [0x6010:12](#) [[▶ 179](#)]) will be saved upon the first external latch pulse with a rising edge if the bit (TRUE) is set in index [0x7010:02](#) [[▶ 180](#)]. The subsequent pulses have no influence on the latch value in index [0x6010:12](#) [[▶ 179](#)].
 - The counter value at the latch input (Index [0x6010:12](#) [[▶ 179](#)]) will be saved upon the first external latch pulse with a falling edge if the bit (TRUE) is set in index [0x7010:04](#) [[▶ 180](#)]. The subsequent pulses have no influence on the latch value in index [0x6010:12](#) [[▶ 179](#)].
 - Note for “Latch extern valid” bit: A new counter value at the latch input can only be written once the value of the “Latch extern valid” bit (index [0x6010:02](#) [[▶ 179](#)]) is FALSE.

Reset

- Counter reset (index [0x8010:01](#) [[▶ 177](#)], [0x8010:02](#) [[▶ 177](#)], [0x8010:10](#) [[▶ 177](#)]): For a counter reset via input C set the bit in index [0x8010:01](#) [[▶ 177](#)], for a reset via the external latch input set the bit in index [0x8010:02](#) [[▶ 177](#)].
- The functions “Enable C reset” ([0x8010:01](#) [[▶ 177](#)]) and “Enable extern reset” ([0x8010:02](#) [[▶ 177](#)]) cannot be activated simultaneously.
- Note for “Extern reset polarity”, index [0x8010:10](#) [[▶ 177](#)]: The edge for setting the counter to zero can be selected via index [0x8010:10](#) [[▶ 177](#)].
Bit not set: counter is set to zero with falling edge.
Bit set: counter is set to zero with rising edge.

Up/down counter

- The mode (encoder or up/down counter) is set via the CoE objects (profile-specific objects, tab CoE - Online, index [0x8010:03](#) [[▶ 177](#)] “Enable up/down counter”). Click on the corresponding row of the index to be parameterized, enter 1 in the SetValue dialog and confirm with OK.
- Set the gate polarity accordingly via object [0x8010:04](#) [[▶ 177](#)].
- An additional option for reversing the rotation direction is available by setting the bit in index [0x8010:0E](#) [[▶ 177](#)].

Overflow/underflow

- Overflow/underflow control is inactive in combination with an activated reset function (C/external).
- The *underflow* bit (0x6010:04 [▶ 179]) is set if an underflow ...00 →...FF occurs. It is reset if 2/3 of the counter range are underrun.
- The *overflow* bit (0x6010:05 [▶ 179]) is set if an overflow FF... → 00... occurs. It is reset if 1/3 of the counter range is exceeded.

Open circuit detection

- A separate open circuit detection can be activated for each of the channels A, B and C (index 0x8010:0B [▶ 177], 0x8010:0C [▶ 177], 0x8010:0D [▶ 177]).
- Open circuit detection is activated for channels A and B by default.
- A differential voltage of typically $-1.5\text{ V} > V_{id} > +1.5\text{ V}$ is detected as an open circuit.
- If an open circuit is detected, it is indicated as process data *open circuit* = TRUE. The bit in object 0x6010:07 [▶ 179] is set. An open circuit is indicated separately in indices 0xA010:01 [▶ 180] (track A), 0xA010:02 [▶ 180] (track B) and 0xA010:03 [▶ 180] (track C).
- TxPDO state also becomes TRUE if an open circuit is detected, since invalid data have to be assumed.

NOTICE**Open circuit detection vs. single-ended lines (TTL interface)**

The open circuit detection does principally not work with single-ended lines (TTL interface).

Micro-increments

- Works with and without distributed clocks, but is only meaningful in conjunction with one of the DC modes
- By setting the counter value only the integer component can be modified.
- The principle:

DC supported microelements - Application for determination of an axis position

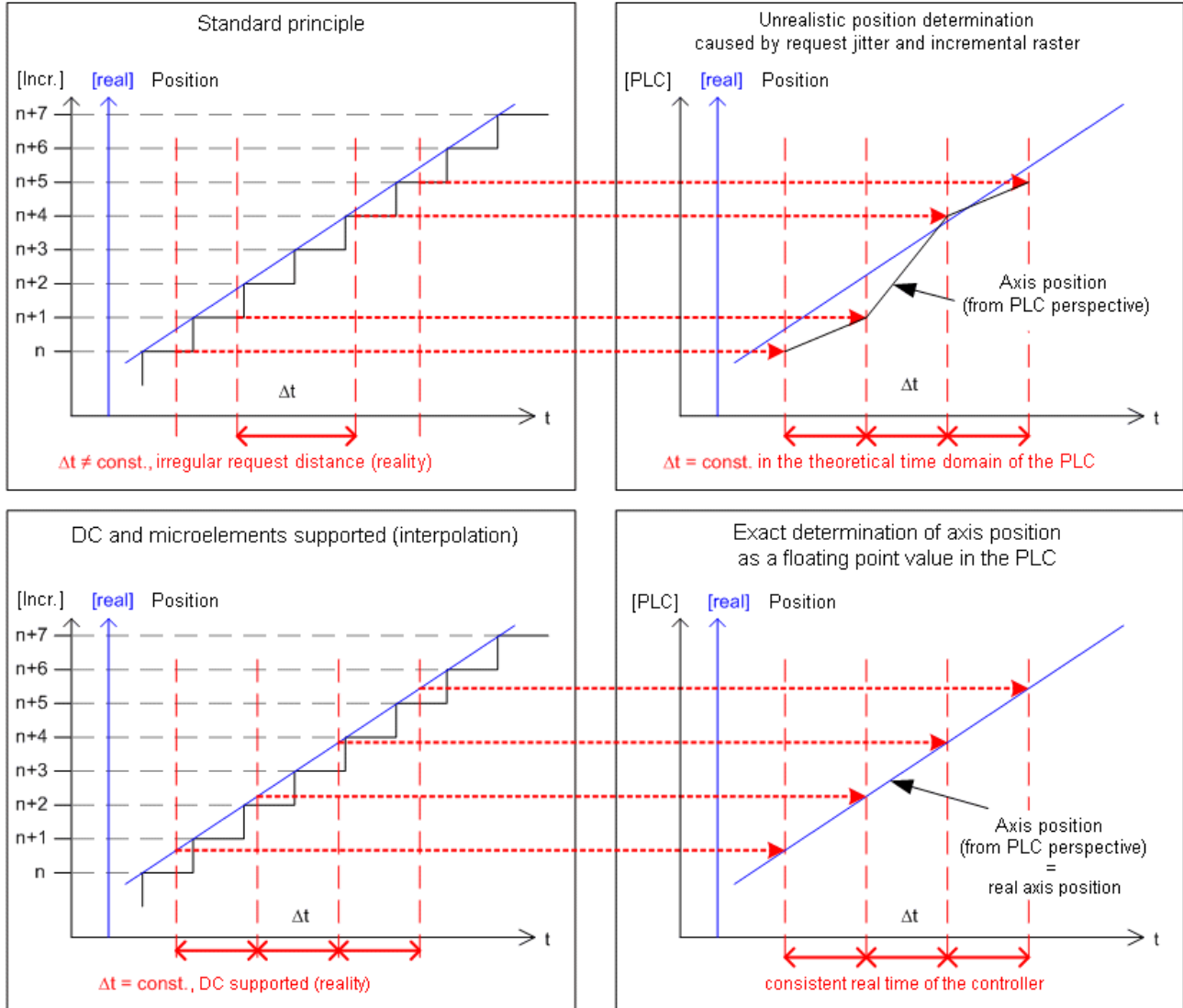

Fig. 169: Frequency measurement principle in enhanced operation mode

The highly constant query cycles (accuracy: 100 ns) of the distributed clocks systems enable the terminal to interpolate axis positions between the counted encoder increments from a certain speed. The interpolation resolution is 8 bit, corresponding to 256 values. A standard encoder with 1,024 bars with 4-fold evaluation and micro-increments thus becomes a high-resolution axis encoder with $4096 * 256 = 1,048,567$ bars. Underrunning of the minimum velocity is indicated by the object `0x6010:08 [▶ 179]` (extrapolation stall) in the process data.

14.2.4 Object description and parameterization - enhanced operation mode

i EtherCAT XML Device Description

The display matches that of the CoE objects from the EtherCAT XML Device Description. We recommend downloading the latest XML file from the download area of the Beckhoff website and installing it according to installation instructions.

NOTICE



Parameterization via the CoE list (CAN over EtherCAT)

The EtherCAT device is parameterized via the CoE - Online tab (with a double click on the respective object) or via the Process Data tab (assignment of PDOs). A detailed description can be found in the EtherCAT System-Documentation in chapter "[EtherCAT subscriber configuration](#)"

Please note the general CoE notes in the EtherCAT System Documentation in chapter "[CoE-interface](#)" when using/manipulating the CoE parameters:

- Keep a startup list if components have to be replaced
- Differentiation between online/offline dictionary,
- existence of current XML description
- use "CoE reload" for resetting changes

14.2.4.1 Restore object

Index 1011 Restore default parameters

Index (hex)	Name	Meaning	Data type	Flags	Default
1011:0	Restore default parameters [▶ 273]	Restore default parameters	UINT8	RO	0x01 (1 _{dec})
1011:01	SubIndex 001	If this object is set to " 0x64616F6C " in the set value dialog, all backup objects are reset to their delivery state.	UINT32	RW	0x00000000 (0 _{dec})

14.2.4.2 Configuration data

Index 8010 ENC Settings (EL5101, EL5101-0090)

Index (hex)	Name	Meaning	Data type	Flags	Default
8010:0	ENC Settings	Maximum subindex	UINT8	RO	0x17 (23 _{dec})
8010:01	Enable C reset [▶ 173]	The counter is reset via the C input.	BOOLEAN	RW	0x00 (0 _{dec})
8010:02	Enable extern reset [▶ 173]	A counter reset is triggered via the external latch input (24 V)	BOOLEAN	RW	0x00 (0 _{dec})
8010:03	Enable up/down counter [▶ 173]	Enablement of the up/down counter in place of the encoder with the bit set. Increments are counted at input A. Input B specifies the counting direction.	BOOLEAN	RW	0x00 (0 _{dec})
8010:04	Gate polarity [▶ 173]	0: Disable gate 1: Enable pos. gate (gate locks with HIGH level) 2: Enable neg. gate (gate locks with LOW level)	BIT2	RW	0x01 (1 _{dec})
8010:08	Disable filter	0: Activates the input filter (inputs A, /A, B, /B, C, /C only) 1: Deactivates the input filter If a filter is activated a signal edge must be present for at least 2.4 µs in order to be counted as an increment.	BOOLEAN	RW	0x01 (1 _{dec})
8010:0A	Enable micro increments [▶ 175]	If DC mode is activated, the terminal interpolates micro-increments between the integer encoder increments. The lower 8 bits of the counter value are used in each case for the display. A 32-bit counter thus becomes a 24+8-bit counter, a 16-bit counter becomes an 8+8-bit counter.	BOOLEAN	RW	0x00 (0 _{dec})
8010:0B	Open circuit detection A [▶ 174]	An open circuit on track A is indicated in index 0x6010:07 [▶ 179] and as process data. Diagnosis is only possible if the corresponding input is wired differentially. A differential voltage $-1.5 V > Vid > 1.5 V$ (typical, subject to change) is detected as a broken wire.	BOOLEAN	RW	0x01 (1 _{dec})
8010:0C	Open circuit detection B [▶ 174]	An open circuit on track B is indicated in index 0x6010:07 [▶ 179] and as process data. Diagnosis is only possible if the corresponding input is wired differentially. A differential voltage $-1.5 V > Vid > 1.5 V$ (typical, subject to change) is detected as a broken wire.	BOOLEAN	RW	0x01 (1 _{dec})
8010:0D	Open circuit detection C [▶ 174]	An open circuit on track C is indicated in index 0x6010:07 [▶ 179] and as process data. Diagnosis is only possible if the corresponding input is wired differentially. A differential voltage $-1.5 V > Vid > 1.5 V$ (typical, subject to change) is detected as a broken wire.	BOOLEAN	RW	0x00 (0 _{dec})
8010:0E	Reversion of rotation [▶ 173]	Activates reversion of rotation	BOOLEAN	RW	0x00 (0 _{dec})
8010:10	Extern reset polarity [▶ 173]	0: Fall (the counter is set to zero with a falling edge) 1: Rise (the counter is set to zero with a rising edge)	BIT1	RW	0x01 (1 _{dec})
8010:11	Frequency window [▶ 172]	This is the minimum time over which the frequency is determined. Default 10 ms [resolution: 1 µs] The number of pulses in the time window + the following is measured. The maximum waiting time is specified in the "Frequency Wait Time" parameter. The number of pulses is divided by the actual time window size. The determined frequency is output in index 0x6010:13 [▶ 179] and as a process data. The frequency calculation is carried out locally without distributed clocks function.	UINT16	RW	0x2710 (10000 _{dec})
8010:13	Frequency scaling [▶ 172]	Scaling of the frequency measurement (must be divided by this value to obtain the unit in Hz): 100: "0.01 Hz"	UINT16	RW	0x0064 (100 _{dec})

Index 8010 ENC Settings (EL5101, EL5101-0090)

Index (hex)	Name	Meaning	Data type	Flags	Default
8010:14	Period scaling [► 172]	Resolution of the period in the process data: 100: "100 ns" period value is a multiple of 100 ns 500: "500 ns" period value is a multiple of 500 ns	UINT16	RW	0x0064 (100 _{dec})
8010:15	Frequency resolution [► 172]	Resolution of the frequency measurement: 100: "0.01 Hz"	UINT16	RW	0x0064 (100 _{dec})
8010:16	Period resolution [► 172]	Internal resolution of the period measurement: 100: "100 ns" period value is a multiple of 100 ns The period is calculated internally with a resolution of 100 ns. The max. measurable period can then be approx. 1.6 seconds. 500: "500 ns" period value is a multiple of 500 ns Internally the period is calculated with 500 ns resolution. The maximum measurable period is approx. 32.7 ms. The resolution of process data continues to be the value according to index 0x8010:14 [► 177] (e.g. 100 ns [default]).	UINT16	RW	0x01F4 (500 _{dec})
8010:17	Frequency Wait Time [► 172]	Waiting time [ms] for frequency measurement Once the time specified in the frequency window [► 172] has elapsed, the system waits for the next positive edge from track A. This enables the update speed for the Frequency process data to be optimized, depending on the expected frequencies. At least double the period of the minimum frequency to be measured should be entered here. $t \geq 2 * (1 / f_{min})$	UINT16	RW	0x0640 (1600 _{dec})

14.2.4.3 Input data

Index 6010 ENC Inputs (EL5101)

Index (hex)	Name	Meaning	Data type	Flags	Default
6010:0	ENC Inputs	Maximum subindex	UINT8	RO	0x16 (22 _{dec})
6010:01	Latch C valid [▶ 173]	The counter value was locked with the “C” input. The data with index 0x6010:12 [▶ 179] match the latched value when the bit is set. To reactivate the latch input, index 0x7010:01 [▶ 180] must be cancelled and then reset.	BOOLEAN	RO	0x00 (0 _{dec})
6010:02	Latch extern valid [▶ 173]	The counter value was locked via the external latch. The data with index 0x6010:12 [▶ 179] match the latched value when the bit is set. To reactivate the latch input, index 0x7000:02 [▶ 180] or object index 0x7000:04 [▶ 180] must be cancelled and then reset.	BOOLEAN	RO	0x00 (0 _{dec})
6010:03	Set counter done	The counter was set.	BOOLEAN	RO	0x00 (0 _{dec})
6010:04	Counter underflow [▶ 174]	Counter underflow. Overflow/underflow control is inactive in combination with a reset function (C/external).	BOOLEAN	RO	0x00 (0 _{dec})
6010:05	Counter overflow [▶ 174]	Counter overflow. Overflow/underflow control is inactive in combination with a reset function (C/external).	BOOLEAN	RO	0x00 (0 _{dec})
6010:06	Status of input status	State of the status input (alarm “input 1”)	BOOLEAN	RO	0x00 (0 _{dec})
6010:07	Open circuit [▶ 174]	Indicates an open circuit. Configuration via index 0x8010:0A, [▶ 177] 0x8010:0B [▶ 177] , 0x8010:0C [▶ 177]	BOOLEAN	RO	0x00 (0 _{dec})
6010:08	Extrapolation stall [▶ 175]	The extrapolated part of the counter is invalid	BOOLEAN	RO	0x00 (0 _{dec})
6010:09	Status of input A	Status of input A	BOOLEAN	RO	0x00 (0 _{dec})
6010:0A	Status of input B	Status of input B	BOOLEAN	RO	0x00 (0 _{dec})
6010:0B	Status of input C	Status of input C	BOOLEAN	RO	0x00 (0 _{dec})
6010:0C	Status of input gate	The state of the gate input	BOOLEAN	RO	0x00 (0 _{dec})
6010:0D	Status of extern latch	Status of the extern latch input	BOOLEAN	RO	0x00 (0 _{dec})
6010:0E	Sync Error	The Sync error bit is only required for DC mode. It indicates whether a synchronization error has occurred during the previous cycle. This means a SYNC signal was triggered in the terminal, although no new process data were available (0=OK, 1=NOK).	BOOLEAN	RO	0x00 (0 _{dec})
6010:0F	TxPDO State	Validity of the data of the associated TxPDO (0 = valid, 1 = invalid).	BOOLEAN	RO	0x00 (0 _{dec})
6010:10	TxPDO Toggle	The TxPDO toggle is toggled by the slave when the data of the associated TxPDO is updated.	BOOLEAN	RO	0x00 (0 _{dec})
6010:11	Counter value	Counter value	UINT32	RO	0x00000000 (0 _{dec})
6010:12	Latch value	Latch value	UINT32	RO	0x00000000 (0 _{dec})
6010:13	Frequency value [▶ 177]	The frequency (setting of the scaling and resolution in index 0x8010:13 [▶ 177] and 0x8010:15 [▶ 177])	UINT32	RO	0x00000000 (0 _{dec})
6010:14	Period value [▶ 177]	The period (setting of the scaling and resolution in index 0x8010:14 [▶ 177] and 0x8010:16 [▶ 177])	UINT32	RO	0x00000000 (0 _{dec})
6010:16	Timestamp [▶ 163]	Timestamp of the last counter change	UINT64	RO	

14.2.4.4 Output data

Index 7010 ENC Outputs (EL5101, EL5101-0090)

Index (hex)	Name	Meaning	Data type	Flags	Default
7010:0	ENC Outputs	Maximum subindex	UINT8	RO	0x11 (17 _{dec})
7010:01	Enable latch C [► 173]	Activate latching via input "C".	BOOLEAN	RO	0x00 (0 _{dec})
7010:02	Enable latch extern on positive edge [► 173]	Activate external latch with positive edge.	BOOLEAN	RO	0x00 (0 _{dec})
7010:03	Set counter	Set counter	BOOLEAN	RO	0x00 (0 _{dec})
7010:04	Enable latch extern on negative edge [► 173]	Activate external latch with negative edge.	BOOLEAN	RO	0x00 (0 _{dec})
7010:11	Set counter value	The counter value to be set via "Set counter" (index 0x7010:03 [► 180]).	UINT32	RO	0x00000000 (0 _{dec})

14.2.4.5 Information / diagnostic data (channel specific)

Index A010 ENC Diag data (EL5101, EL5101-0090)

Index (hex)	Name	Meaning	Data type	Flags	Default
A010:0	ENC Diag data	Maximum subindex	UINT8	RO	0x03 (3 _{dec})
A010:01	Open circuit A [► 174]	Open circuit on track A	BOOLEAN	RO	0x00 (0 _{dec})
A010:02	Open circuit B [► 174]	Open circuit on track B	BOOLEAN	RO	0x00 (0 _{dec})
A010:03	Open circuit C [► 174]	Open circuit on track C	BOOLEAN	RO	0x00 (0 _{dec})

14.2.4.6 Standard objects

The standard objects have the same meaning for all EtherCAT slaves.

Index 1000 Device type

Index (hex)	Name	Meaning	Data type	Flags	Default
1000:0	Device type	Device type of the EtherCAT slave: the Lo-Word contains the CoE profile used (5001). The Hi-Word contains the module profile according to the modular device profile.	UINT32	RO	0x00001389 (5001 _{dec})

Index 1008 Device name

Index (hex)	Name	Meaning	Data type	Flags	Default
1008:0	Device name	Device name of the EtherCAT slave	STRING	RO	EL5101

Index 1009 Hardware version

Index (hex)	Name	Meaning	Data type	Flags	Default
1009:0	Hardware version	Hardware version of the EtherCAT slave	STRING	RO	09

Index 100A Software version

Index (hex)	Name	Meaning	Data type	Flags	Default
100A:0	Software version	Firmware version of the EtherCAT slave	STRING	RO	10

Index 1018 Identity

Index (hex)	Name	Meaning	Data type	Flags	Default
1018:0	Identity	Information for identifying the slave	UINT8	RO	0x04 (4 _{dec})
1018:01	Vendor ID	Vendor ID of the EtherCAT slave	UINT32	RO	0x00000002 (2 _{dec})
1018:02	Product code	Product code of the EtherCAT slave	UINT32	RO	0x13ED3052 (334311506 _{dec})
1018:03	Revision	Revision number of the EtherCAT slave; the low word (bit 0-15) indicates the special terminal number, the high word (bit 16-31) refers to the device description	UINT32	RO	0x00000000 (0 _{dec})
1018:04	Serial number	Serial number of the EtherCAT slave; the low byte (bit 0-7) of the low word contains the year of production, the high byte (bit 8-15) of the low word contains the week of production, the high word (bit 16-31) is 0	UINT32	RO	0x00000000 (0 _{dec})

Index 10F0 Backup parameter handling

Index (hex)	Name	Meaning	Data type	Flags	Default
10F0:0	Backup parameter handling	Information for standardized loading and saving of backup entries	UINT8	RO	0x01 (1 _{dec})
10F0:01	Checksum	Checksum across all backup entries of the EtherCAT slave	UINT32	RO	0x00000000 (0 _{dec})

Index 1400 RxPDO-Par Outputs (EL5101)

Index (hex)	Name	Meaning	Data type	Flags	Default
1400:0	RxPDO-Par Outputs	PDO Parameter RxPDO 1	UINT8	RO	0x06 (6 _{dec})
1400:06	Exclude RxPDOs	Specifies the RxPDOs (index of RxPDO mapping objects) that must not be transferred together with RxPDO 1	OCTET-STRING[6]	RO	01 16 02 16 03 16

Index 1401 RxPDO-Par Outputs Word-Aligned (EL5101)

Index (hex)	Name	Meaning	Data type	Flags	Default
1401:0	RxPDO-Par Outputs Word-Aligned	PDO Parameter RxPDO 2	UINT8	RO	0x06 (6 _{dec})
1401:06	Exclude RxPDOs	Specifies the RxPDOs (index of RxPDO mapping objects) that must not be transferred together with RxPDO 2	OCTET-STRING[6]	RO	00 16 02 16 03 16

Index 1402 ENC RxPDO-Par Control compact (EL5101)

Index (hex)	Name	Meaning	Data type	Flags	Default
1402:0	ENC RxPDO-Par Control compact	PDO Parameter RxPDO 3	UINT8	RO	0x06 (6 _{dec})
1402:06	Exclude RxPDOs	Specifies the RxPDOs (index of RxPDO mapping objects) that must not be transferred together with RxPDO 3	OCTET-STRING[6]	RO	03 16 00 16 01 16

Index 1403 ENC RxPDO-Par Control (EL5101)

Index (hex)	Name	Meaning	Data type	Flags	Default
1403:0	ENC RxPDO-Par Control	PDO Parameter RxPDO 4	UINT8	RO	0x06 (6 _{dec})
1403:06	Exclude RxPDOs	Specifies the RxPDOs (index of RxPDO mapping objects) that must not be transferred together with RxPDO 4	OCTET-STRING[6]	RO	02 16 00 16 01 16

Index 1600 RxPDO-Map Outputs (EL5101, EL5101-0090)

Index (hex)	Name	Meaning	Data type	Flags	Default
1600:0	RxPDO-Map Outputs	PDO Mapping RxPDO 1	UINT8	RO	0x02 (2 _{dec})
1600:01	SubIndex 001	1. PDO Mapping entry (object 0x7000 (Outputs), entry 0x01 (Ctrl))	UINT32	RO	0x7000:01, 8
1600:02	SubIndex 002	2. PDO Mapping entry (object 0x7000 (Outputs), entry 0x02 (Value))	UINT32	RO	0x7000:02, 16

Index 1601 RxPDO-Map Outputs Word-Aligned (EL5101, EL5101-0090)

Index (hex)	Name	Meaning	Data type	Flags	Default
1601:0	RxPDO-Map Outputs Word-Aligned	PDO Mapping RxPDO 2	UINT8	RO	0x03 (3 _{dec})
1601:01	SubIndex 001	1. PDO Mapping entry (object 0x7000 (Outputs), entry 0x01 (Ctrl))	UINT32	RO	0x7000:01, 8
1601:02	SubIndex 002	2. PDO Mapping entry (8 bits align)	UINT32	RO	0x0000:00, 8
1601:03	SubIndex 003	3. PDO Mapping entry (object 0x7000 (Outputs), entry 0x02 (Value))	UINT32	RO	0x7000:02, 16

Index 1602 ENC RxPDO-Map Control compact (EL5101, EL5101-0090)

Index (hex)	Name	Meaning	Data type	Flags	Default
1602:0	ENC RxPDO-Map Control compact	PDO Mapping RxPDO 3	UINT8	RO	0x07 (7 _{dec})
1602:01	SubIndex 001	1. PDO Mapping entry (object 0x7010 (ENC Outputs), entry 0x01 (Enable latch C))	UINT32	RO	0x7010:01, 1
1602:02	SubIndex 002	2. PDO Mapping entry (object 0x7010 (ENC Outputs), entry 0x02 (Enable latch extern on positive edge))	UINT32	RO	0x7010:02, 1
1602:03	SubIndex 003	3. PDO Mapping entry (object 0x7010 (ENC Outputs), entry 0x03 (Set counter))	UINT32	RO	0x7010:03, 1
1602:04	SubIndex 004	4. PDO Mapping entry (object 0x7010 (ENC Outputs), entry 0x04 (Enable latch extern on negative edge))	UINT32	RO	0x7010:04, 1
1602:05	SubIndex 005	5. PDO Mapping entry (4 bits align)	UINT32	RO	0x0000:00, 4
1602:06	SubIndex 006	6. PDO Mapping entry (8 bits align)	UINT32	RO	0x0000:00, 8
1602:07	SubIndex 007	7. PDO Mapping entry (object 0x7010 (ENC Outputs), entry 0x11 (Set counter value))	UINT32	RO	0x7010:11, 16

Index 1603 ENC RxPDO-Map Control (EL5101, EL5101-0090)

Index (hex)	Name	Meaning	Data type	Flags	Default
1603:0	ENC RxPDO-Map Control	PDO Mapping RxPDO 4	UINT8	RO	0x07 (7 _{dec})
1603:01	SubIndex 001	1. PDO Mapping entry (object 0x7010 (ENC Outputs), entry 0x01 (Enable latch C))	UINT32	RO	0x7010:01, 1
1603:02	SubIndex 002	2. PDO Mapping entry (object 0x7010 (ENC Outputs), entry 0x02 (Enable latch extern on positive edge))	UINT32	RO	0x7010:02, 1
1603:03	SubIndex 003	3. PDO Mapping entry (object 0x7010 (ENC Outputs), entry 0x03 (Set counter))	UINT32	RO	0x7010:03, 1
1603:04	SubIndex 004	4. PDO Mapping entry (object 0x7010 (ENC Outputs), entry 0x04 (Enable latch extern on negative edge))	UINT32	RO	0x7010:04, 1
1603:05	SubIndex 005	5. PDO Mapping entry (4 bits align)	UINT32	RO	0x0000:00, 4
1603:06	SubIndex 006	6. PDO Mapping entry (8 bits align)	UINT32	RO	0x0000:00, 8
1603:07	SubIndex 007	7. PDO Mapping entry (object 0x7010 (ENC Outputs), entry 0x11 (Set counter value))	UINT32	RO	0x7010:11, 32

Index 1800 TxPDO-Par Inputs (EL5101)

Index (hex)	Name	Meaning	Data type	Flags	Default
1800:0	TxPDO-Par Inputs	PDO Parameter TxPDO 1	UINT8	RO	0x06 (6 _{dec})
1800:06	Exclude TxPDOs	Specifies the TxPDOs (index of TxPDO mapping objects) that must not be transferred together with TxPDO 1	OCTET-STRING[14]	RO	01 1A 03 1A 04 1A 05 1A 06 1A 07 1A 08 1A

Index 1801 TxPDO-Par Inputs Word-Aligned (EL5101)

Index (hex)	Name	Meaning	Data type	Flags	Default
1801:0	TxPDO-Par Inputs Word-Aligned	PDO Parameter TxPDO 2	UINT8	RO	0x06 (6 _{dec})
1801:06	Exclude TxPDOs	Specifies the TxPDOs (index of TxPDO mapping objects) that must not be transferred together with TxPDO 2	OCTET-STRING[14]	RO	00 1A 03 1A 04 1A 05 1A 06 1A 07 1A 08 1A

Index 1802 TxPDO-Par Inputs Optional (EL5101)

Index (hex)	Name	Meaning	Data type	Flags	Default
1802:0	TxPDO-Par Inputs Optional	PDO Parameter TxPDO 3	UINT8	RO	0x06 (6 _{dec})
1802:06	Exclude TxPDOs	Specifies the TxPDOs (index of TxPDO mapping objects) that must not be transferred together with TxPDO 3	OCTET-STRING[14]	RO	03 1A 04 1A 05 1A 06 1A 07 1A 08 1A 00 00

Index 1803 ENC TxPDO-Par Status compact (EL5101)

Index (hex)	Name	Meaning	Data type	Flags	Default
1803:0	ENC TxPDO-Par Status compact	PDO Parameter TxPDO 4	UINT8	RO	0x09 (9 _{dec})
1803:06	Exclude TxPDOs	Specifies the TxPDOs (index of TxPDO mapping objects) that must not be transferred together with TxPDO 4	OCTET-STRING[14]	RO	04 1A 00 1A 01 1A 02 1A 00 00 00 00 00 00
1803:07	TxPDO-State	The TxPDO state is set if it was not possible to correctly read in the associated input data	BOOLEAN	RO	0x00 (0 _{dec})
1803:09	TxPDO Toggle	The TxPDO toggle is toggled with each update the corresponding input data	BOOLEAN	RO	0x00 (0 _{dec})

Index 1804 ENC TxPDO-Par Status (EL5101)

Index (hex)	Name	Meaning	Data type	Flags	Default
1804:0	ENC TxPDO-Par Status	PDO Parameter TxPDO 5	UINT8	RO	0x09 (9 _{dec})
1804:06	Exclude TxPDOs	Specifies the TxPDOs (index of TxPDO mapping objects) that must not be transferred together with TxPDO 5	OCTET-STRING[14]	RO	03 1A 00 1A 01 1A 02 1A 00 00 00 00 00 00
1804:07	TxPDO State	The TxPDO state is set if it was not possible to correctly read in the associated input data	BOOLEAN	RO	0x00 (0 _{dec})
1804:09	TxPDO Toggle	The TxPDO toggle is toggled with each update the corresponding input data	BOOLEAN	RO	0x00 (0 _{dec})

Index 1805 ENC TxPDO-Par Frequency (EL5101)

Index (hex)	Name	Meaning	Data type	Flags	Default
1805:0	ENC TxPDO-Par Frequency	PDO Parameter TxPDO 6	UINT8	RO	0x06 (6 _{dec})
1805:06	Exclude TxPDOs	Specifies the TxPDOs (index of TxPDO mapping objects) that must not be transferred together with TxPDO 6	OCTET-STRING[14]	RO	00 1A 01 1A 02 1A 06 1A 00 00 00 00 00 00

Index 1806 ENC TxPDO-Par Period (EL5101)

Index (hex)	Name	Meaning	Data type	Flags	Default
1806:0	ENC TxPDO-Par Period	PDO Parameter TxPDO 7	UINT8	RO	0x06 (6 _{dec})
1806:06	Exclude TxPDOs	Specifies the TxPDOs (index of TxPDO mapping objects) that must not be transferred together with TxPDO 7	OCTET-STRING[14]	RO	00 1A 01 1A 02 1A 05 1A 00 00 00 00 00 00

Index 1807 ENC TxPDO-Par Timest. (EL5101)

Index (hex)	Name	Meaning	Data type	Flags	Default
1807:0	ENC TxPDO-Par Timest.	PDO Parameter TxPDO 8	UINT8	RO	0x06 (6 _{dec})
1807:06	Exclude TxPDOs	Specifies the TxPDOs (index of TxPDO mapping objects) that must not be transferred together with TxPDO 8	OCTET-STRING[14]	RO	08 1A 00 1A 01 1A 02 1A 00 00 00 00 00 00

Index 1808 ENC TxPDO-Par Timest. compact (EL5101)

Index (hex)	Name	Meaning	Data type	Flags	Default
1808:0	ENC TxPDO-Par Timest. compact	PDO Parameter TxPDO 9	UINT8	RO	0x06 (6 _{dec})
1808:06	Exclude TxPDOs	Specifies the TxPDOs (index of TxPDO mapping objects) that must not be transferred together with TxPDO 9	OCTET-STRING[14]	RO	07 1A 00 1A 01 1A 02 1A 00 00 00 00 00 00

Index 1A00 TxPDO-Map Inputs (EL5101, EL5101-0090)

Index (hex)	Name	Meaning	Data type	Flags	Default
1A00:0	TxPDO-Map Inputs	PDO Mapping TxPDO 1	UINT8	RO	0x03 (3 _{dec})
1A00:01	SubIndex 001	1. PDO Mapping entry (object 0x6000 (Inputs), entry 0x01 (Status))	UINT32	RO	0x6000:01, 8
1A00:02	SubIndex 002	2. PDO Mapping entry (object 0x6000 (Inputs), entry 0x02 (Value))	UINT32	RO	0x6000:02, 16
1A00:03	SubIndex 003	3. PDO Mapping entry (object 0x6000 (Inputs), entry 0x03 (Latch))	UINT32	RO	0x6000:03, 16

Index 1A01 TxPDO-Map Inputs Word-Aligned (EL5101, EL5101-0090)

Index (hex)	Name	Meaning	Data type	Flags	Default
1A01:0	TxPDO-Map Inputs Word-Aligned	PDO Mapping TxPDO 2	UINT8	RO	0x04 (4 _{dec})
1A01:01	SubIndex 001	1. PDO Mapping entry (object 0x6000 (Inputs), entry 0x01 (Status))	UINT32	RO	0x6000:01, 8
1A01:02	SubIndex 002	2. PDO Mapping entry (8 bits align)	UINT32	RO	0x0000:00, 8
1A01:03	SubIndex 003	3. PDO Mapping entry (object 0x6000 (Inputs), entry 0x02 (Value))	UINT32	RO	0x6000:02, 16
1A01:04	SubIndex 004	4. PDO Mapping entry (object 0x6000 (Inputs), entry 0x03 (Latch))	UINT32	RO	0x6000:03, 16

Index 1A02 TxPDO-Map Inputs Optional (EL5101, EL5101-0090)

Index (hex)	Name	Meaning	Data type	Flags	Default
1A02:0	TxPDO-Map Inputs Optional	PDO Mapping TxPDO 3	UINT8	RO	0x03 (3 _{dec})
1A02:01	SubIndex 001	1. PDO Mapping entry (object 0x6000 (Inputs), entry 0x04 (Frequency))	UINT32	RO	0x6000:04, 32
1A02:02	SubIndex 002	2. PDO Mapping entry (object 0x6000 (Inputs), entry 0x05 (Period))	UINT32	RO	0x6000:05, 16
1A02:03	SubIndex 003	3. PDO Mapping entry (object 0x6000 (Inputs), entry 0x06 (Window))	UINT32	RO	0x6000:06, 16

Index 1A03 ENC TxPDO-Map Status compact (EL5101, EL5101-0090)

Index (hex)	Name	Meaning	Data type	Flags	Default
1A03:0	ENC TxPDO-Map Status compact	PDO Mapping TxPDO 4	UINT8	RO	0x12 (18 _{dec})
1A03:01	SubIndex 001	1. PDO Mapping entry (object 0x6010 (ENC Inputs), entry 0x01 (Latch C valid))	UINT32	RO	0x6010:01, 1
1A03:02	SubIndex 002	2. PDO Mapping entry (object 0x6010 (ENC Inputs), entry 0x02 (Latch extern valid))	UINT32	RO	0x6010:02, 1
1A03:03	SubIndex 003	3. PDO Mapping entry (object 0x6010 (ENC Inputs), entry 0x03 (Set counter done))	UINT32	RO	0x6010:03, 1
1A03:04	SubIndex 004	4. PDO Mapping entry (object 0x6010 (ENC Inputs), entry 0x04 (Counter underflow))	UINT32	RO	0x6010:04, 1
1A03:05	SubIndex 005	5. PDO Mapping entry (object 0x6010 (ENC Inputs), entry 0x05 (Counter overflow))	UINT32	RO	0x6010:05, 1
1A03:06	SubIndex 006	6. PDO Mapping entry (object 0x6010 (ENC Inputs), entry 0x06 (Status of input status))	UINT32	RO	0x6010:06, 1
1A03:07	SubIndex 007	7. PDO Mapping entry (object 0x6010 (ENC Inputs), entry 0x07 (Open circuit))	UINT32	RO	0x6010:07, 1
1A03:08	SubIndex 008	8. PDO Mapping entry (object 0x6010 (ENC Inputs), entry 0x08 (Extrapolation stall))	UINT32	RO	0x6010:08, 1
1A03:09	SubIndex 009	9. PDO Mapping entry (object 0x6010 (ENC Inputs), entry 0x09 (Status of input A))	UINT32	RO	0x6010:09, 1
1A03:0A	SubIndex 010	10. PDO Mapping entry (object 0x6010 (ENC Inputs), entry 0x0A (Status of input B))	UINT32	RO	0x6010:0A, 1
1A03:0B	SubIndex 011	11. PDO Mapping entry (object 0x6010 (ENC Inputs), entry 0x0B (Status of input C))	UINT32	RO	0x6010:0B, 1
1A03:0C	SubIndex 012	12. PDO Mapping entry (object 0x6010 (ENC Inputs), entry 0x0C (Status of input gate))	UINT32	RO	0x6010:0C, 1
1A03:0D	SubIndex 013	13. PDO Mapping entry (object 0x6010 (ENC Inputs), entry 0x0D (Status of extern latch))	UINT32	RO	0x6010:0D, 1
1A03:0E	SubIndex 014	14. PDO Mapping entry (object 0x1C32 (SM output parameter), entry 0x20 (Sync error))	UINT32	RO	0x6010:0E:20, 1
1A03:0F	SubIndex 015	15. PDO Mapping entry (object 0x1803 (ENC TxPDO-Par Status compact), entry 0x07 (TxPDO-State))	UINT32	RO	0x6010:0F, 1
1A03:10	SubIndex 016	16. PDO Mapping entry (object 0x1803 (ENC TxPDO-Par Status compact), entry 0x09 (TxPDO-Toggle))	UINT32	RO	0x6010:10, 1
1A03:11	SubIndex 017	17. PDO Mapping entry (object 0x6010 (ENC Inputs), entry 0x11 (Counter value))	UINT32	RO	0x6010:11, 16
1A03:12	SubIndex 018	18. PDO Mapping entry (object 0x6010 (ENC Inputs), entry 0x12 (Latch value))	UINT32	RO	0x6010:12, 16

Index 1A04 ENC TxPDO-Map Status (EL5101, EL5101-0090)

Index (hex)	Name	Meaning	Data type	Flags	Default
1A04:0	ENC TxPDO-Map Status	PDO Mapping TxPDO 5	UINT8	RO	0x12 (18 _{dec})
1A04:01	SubIndex 001	1. PDO Mapping entry (object 0x6010 (ENC Inputs), entry 0x01 (Latch C valid))	UINT32	RO	0x6010:01, 1
1A04:02	SubIndex 002	2. PDO Mapping entry (object 0x6010 (ENC Inputs), entry 0x02 (Latch extern valid))	UINT32	RO	0x6010:02, 1
1A04:03	SubIndex 003	3. PDO Mapping entry (object 0x6010 (ENC Inputs), entry 0x03 (Set counter done))	UINT32	RO	0x6010:03, 1
1A04:04	SubIndex 004	4. PDO Mapping entry (object 0x6010 (ENC Inputs), entry 0x04 (Counter underflow))	UINT32	RO	0x6010:04, 1
1A04:05	SubIndex 005	5. PDO Mapping entry (object 0x6010 (ENC Inputs), entry 0x05 (Counter overflow))	UINT32	RO	0x6010:05, 1
1A04:06	SubIndex 006	6. PDO Mapping entry (object 0x6010 (ENC Inputs), entry 0x06 (Status of input status))	UINT32	RO	0x6010:06, 1
1A04:07	SubIndex 007	7. PDO Mapping entry (object 0x6010 (ENC Inputs), entry 0x07 (Open circuit))	UINT32	RO	0x6010:07, 1
1A04:08	SubIndex 008	8. PDO Mapping entry (object 0x6010 (ENC Inputs), entry 0x08 (Extrapolation stall))	UINT32	RO	0x6010:08, 1
1A04:09	SubIndex 009	9. PDO Mapping entry (object 0x6010 (ENC Inputs), entry 0x09 (Status of input A))	UINT32	RO	0x6010:09, 1
1A04:0A	SubIndex 010	10. PDO Mapping entry (object 0x6010 (ENC Inputs), entry 0x0A (Status of input B))	UINT32	RO	0x6010:0A, 1
1A04:0B	SubIndex 011	11. PDO Mapping entry (object 0x6010 (ENC Inputs), entry 0x0B (Status of input C))	UINT32	RO	0x6010:0B, 1
1A04:0C	SubIndex 012	12. PDO Mapping entry (object 0x6010 (ENC Inputs), entry 0x0C (Status of input gate))	UINT32	RO	0x6010:0C, 1
1A04:0D	SubIndex 013	13. PDO Mapping entry (object 0x6010 (ENC Inputs), entry 0x0D (Status of extern latch))	UINT32	RO	0x6010:0D, 1
1A04:0E	SubIndex 014	14. PDO Mapping entry (object 0x1C32 (SM output parameter), entry 0x20 (Sync error))	UINT32	RO	0x6010:0E, 1
1A04:0F	SubIndex 015	15. PDO Mapping entry (object 0x1804 (ENC TxPDO-Par Status), entry 0x07 (TxPDO-State))	UINT32	RO	0x6010:0F, 1
1A04:10	SubIndex 016	16. PDO Mapping entry (object 0x1804 (ENC TxPDO-Par Status), entry 0x09 (TxPDO-Toggle))	UINT32	RO	0x6010:10, 1
1A04:11	SubIndex 017	17. PDO Mapping entry (object 0x6010 (ENC Inputs), entry 0x11 (Counter value))	UINT32	RO	0x6010:11, 32
1A04:12	SubIndex 018	18. PDO Mapping entry (object 0x6010 (ENC Inputs), entry 0x12 (Latch value))	UINT32	RO	0x6010:12, 32

Index 1A05 ENC TxPDO-Map Frequency (EL5101, EL5101-0090)

Index (hex)	Name	Meaning	Data type	Flags	Default
1A05:0	ENC TxPDO-Map Frequency	PDO Mapping TxPDO 6	UINT8	RO	0x01 (1 _{dec})
1A05:01	SubIndex 001	1. PDO Mapping entry (object 0x6010 (ENC Inputs), entry 0x13 (Frequency value))	UINT32	RO	0x6010:13, 32

Index 1A06 ENC TxPDO-Map Period (EL5101, EL5101-0090)

Index (hex)	Name	Meaning	Data type	Flags	Default
1A06:0	ENC TxPDO-Map Period	PDO Mapping TxPDO 7	UINT8	RO	0x01 (1 _{dec})
1A06:01	SubIndex 001	1. PDO Mapping entry (object 0x6010 (ENC Inputs), entry 0x14 (Period value))	UINT32	RO	0x6010:14, 32

Index 1A07 ENC TxPDO-Map Timest. (EL5101, EL5101-0090)

Index (hex)	Name	Meaning	Data type	Flags	Default
1A07:0	ENC TxPDO-Map Timest.	PDO Mapping TxPDO 8	UINT8	RO	0x01 (1 _{dec})
1A07:01	SubIndex 001	1. PDO Mapping entry (object 0x6010 (ENC Inputs), entry 0x16 (Timestamp))	UINT32	RO	0x6010:16, 64

Index 1A08 ENC TxPDO-Map Timest. compact (EL5101, EL5101-0090)

Index (hex)	Name	Meaning	Data type	Flags	Default
1A08:0	ENC TxPDO-Map Timest. compact	PDO Mapping TxPDO 9	UINT8	RO	0x01 (1 _{dec})
1A08:01	SubIndex 001	1. PDO Mapping entry (object 0x6010 (ENC Inputs), entry 0x16 (Timestamp))	UINT32	RO	0x6010:16, 32

Index 1C00 Sync manager type

Index (hex)	Name	Meaning	Data type	Flags	Default
1C00:0	Sync manager type	Using the sync managers	UINT8	RO	0x04 (4 _{dec})
1C00:01	SubIndex 001	Sync-Manager Type Channel 1: Mailbox Write	UINT8	RO	0x01 (1 _{dec})
1C00:02	SubIndex 002	Sync-Manager Type Channel 2: Mailbox Read	UINT8	RO	0x02 (2 _{dec})
1C00:03	SubIndex 003	Sync-Manager Type Channel 3: Process Data Write (Outputs)	UINT8	RO	0x03 (3 _{dec})
1C00:04	SubIndex 004	Sync-Manager Type Channel 4: Process Data Read (Inputs)	UINT8	RO	0x04 (4 _{dec})

Index 1C12 RxPDO assign

Index (hex)	Name	Meaning	Data type	Flags	Default
1C12:0	RxPDO assign	PDO Assign Outputs	UINT8	RW	0x01 (1 _{dec})
1C12:01	SubIndex 001	1 st allocated RxPDO (contains the index of the associated RxPDO mapping object)	UINT16	RW	0x1600 (5632 _{dec})

Index 1C13 TxPDO assign

Index (hex)	Name	Meaning	Data type	Flags	Default
1C13:0	TxPDO assign	PDO Assign Inputs	UINT8	RW	0x01 (1 _{dec})
1C13:01	SubIndex 001	1 st allocated TxPDO (contains the index of the associated TxPDO mapping object)	UINT16	RW	0x1A00 (6656 _{dec})
1C13:02	SubIndex 002	2 nd allocated TxPDO (contains the index of the associated TxPDO mapping object)	UINT16	RW	0x0000 (0 _{dec})
1C13:03	SubIndex 003	3 rd allocated TxPDO (contains the index of the associated TxPDO mapping object)	UINT16	RW	0x0000 (0 _{dec})

Index 1C32 SM output parameter

Index (hex)	Name	Meaning	Data type	Flags	Default
1C32:0	SM output parameter	Synchronization parameters for the outputs	UINT8	RO	0x20 (32 _{dec})
1C32:01	Sync mode	Current synchronization mode: <ul style="list-style-type: none"> 0: Free Run 1: Synchron with SM 2 Event 2: DC-Mode - Synchron with SYNC0 Event 3: DC-Mode - Synchron with SYNC1 Event 	UINT16	RW	0x0001 (1 _{dec})
1C32:02	Cycle time	Cycle time (in ns): <ul style="list-style-type: none"> Free Run: Cycle time of the local timer Synchronous with SM 2 event: Master cycle time DC-Mode: SYNC0/SYNC1 Cycle Time 	UINT32	RW	0x00000000 (0 _{dec})
1C32:03	Shift time	Time between SYNC0 event and output of the outputs (in ns, DC mode only)	UINT32	RO	0x00000000 (0 _{dec})
1C32:04	Sync modes supported	Supported synchronization modes: <ul style="list-style-type: none"> Bit 0 = 1: free run is supported Bit 1 = 1: Synchronous with SM 2 event is supported Bit 2-3 = 01: DC mode is supported Bit 4-5 = 10: Output shift with SYNC1 event (only DC mode) Bit 14 = 1: dynamic times (measurement through writing of 0x1C32:08 [► 188]) 	UINT16	RO	0xC007 (49159 _{dec})
1C32:05	Minimum cycle time	Minimum cycle time (in ns)	UINT32	RO	0x00000000 (0 _{dec})
1C32:06	Calc and copy time	Minimum time between SYNC0 and SYNC1 event (in ns, DC mode only)	UINT32	RO	0x00000000 (0 _{dec})
1C32:08	Command	With this entry the real required process data provision time can be measured. <ul style="list-style-type: none"> 0: Measurement of the local cycle time is stopped 1: Measurement of the local cycle time is started <p>The entries 0x1C32:03 [► 188], 0x1C32:05 [► 188], 0x1C32:06 [► 188], 0x1C32:09 [► 188], 0x1C33:03 [► 189], 0x1C33:06 [► 188], and 0x1C33:09 [► 189] are updated with the maximum measured values. For a subsequent measurement the measured values are reset</p>	UINT16	RW	0x0000 (0 _{dec})
1C32:09	Delay time	Time between SYNC1 event and output of the outputs (in ns, DC mode only)	UINT32	RO	0x00000000 (0 _{dec})
1C32:0B	SM event missed counter	Number of missed SM events in OPERATIONAL (DC mode only)	UINT16	RO	0x0000 (0 _{dec})
1C32:0C	Cycle exceeded counter	Number of occasions the cycle time was exceeded in OPERATIONAL (cycle was not completed in time or the next cycle began too early)	UINT16	RO	0x0000 (0 _{dec})
1C32:0D	Shift too short counter	Number of occasions that the interval between SYNC0 and SYNC1 event was too short (DC mode only)	UINT16	RO	0x0000 (0 _{dec})
1C32:20	Sync error	The synchronization was not correct in the last cycle (outputs were output too late; DC mode only)	BOOLEAN	RO	0x00 (0 _{dec})

Index 1C33 SM input parameter

Index (hex)	Name	Meaning	Data type	Flags	Default
1C33:0	SM input parameter	Synchronization parameters for the inputs	UINT8	RO	0x20 (32 _{dec})
1C33:01	Sync mode	Current synchronization mode: <ul style="list-style-type: none"> • 0: Free Run • 1: Synchronous with SM 3 event (no outputs available) • 2: DC - Synchron with SYNC0 Event • 3: DC - Synchron with SYNC1 Event • 34: Synchronous with SM 2 event (outputs available) 	UINT16	RW	0x0022 (34 _{dec})
1C33:02	Cycle time	as 0x1C32:02 [▶ 188]	UINT32	RW	0x00000000 (0 _{dec})
1C33:03	Shift time	Time between SYNC0 event and reading of the inputs (in ns, only DC mode)	UINT32	RO	0x00000000 (0 _{dec})
1C33:04	Sync modes supported	Supported synchronization modes: <ul style="list-style-type: none"> • Bit 0: free run is supported • Bit 1: synchronous with SM 2 event is supported (outputs available) • Bit 1: synchronous with SM 3 event is supported (no outputs available) • Bit 2-3 = 01: DC mode is supported • Bit 4-5 = 01: input shift through local event (outputs available) • Bit 4-5 = 10: input shift with SYNC1 event (no outputs available) • Bit 14 = 1: dynamic times (measurement through writing of 0x1C32:08 [▶ 188] or 0x1C33:08 [▶ 189]) 	UINT16	RO	0xC007 (49159 _{dec})
1C33:05	Minimum cycle time	as 0x1C32:05 [▶ 188]	UINT32	RO	0x00000000 (0 _{dec})
1C33:06	Calc and copy time	Time between reading of the inputs and availability of the inputs for the master (in ns, only DC mode)	UINT32	RO	0x00000000 (0 _{dec})
1C33:08	Command	as 0x1C32:08 [▶ 188]	UINT16	RW	0x0000 (0 _{dec})
1C33:09	Delay time	Time between SYNC1 event and reading of the inputs (in ns, only DC mode)	UINT32	RO	0x00000000 (0 _{dec})
1C33:0B	SM event missed counter	as 0x1C32:11 [▶ 188]	UINT16	RO	0x0000 (0 _{dec})
1C33:0C	Cycle exceeded counter	as 0x1C32:12 [▶ 188]	UINT16	RO	0x0000 (0 _{dec})
1C33:0D	Shift too short counter	as 0x1C32:13 [▶ 188]	UINT16	RO	0x0000 (0 _{dec})
1C33:20	Sync error	as 0x1C32:32 [▶ 188]	BOOLEAN	RO	0x00 (0 _{dec})

Index F000 Modular device profile

Index (hex)	Name	Meaning	Data type	Flags	Default
F000:0	Modular device profile	General information for the modular device profile	UINT8	RO	0x02 (2 _{dec})
F000:01	Module index distance	Index spacing of the objects of the individual channels	UINT16	RO	0x0010 (16 _{dec})
F000:02	Maximum number of modules	Number of channels	UINT16	RO	0x0002 (2 _{dec})

Index F008 Code word

Index (hex)	Name	Meaning	Data type	Flags	Default
F008:0	Code word	reserved	UINT32	RW	0x00000000 (0 _{dec})

Index F010 Module list

Index (hex)	Name	Meaning	Data type	Flags	Default
F010:0	Module list	Maximum subindex	UINT8	RW	0x02 (2 _{dec})
F010:01	SubIndex 001	reserved	UINT32	RW	0x000001FE (510 _{dec})
F010:02	SubIndex 002	reserved	UINT32	RW	0x000001FF (511 _{dec})

14.2.5 Single-ended connection for TTL encoder

In addition to encoders with differential RS422 interface, single-ended encoders with TTL interface are also supported. Please note the following:

- Operating mode selection encoder [0x8010:03](#) [[▶ 177](#)] "Enable up/down counter" = FALSE.
- The differential inputs (/A, /B, /C) must remain open and must not be connected to ground.
- The option to reverse the direction of rotation is given by setting the bit in index [0x8010:0E](#) [[▶ 177](#)] "reversion of rotation" = TRUE.
- The open circuit detection does not work in principle conditionally with single-ended connection.

15 EL5101-0010 - Commissioning

15.1 Enhanced operation mode

15.1.1 Operation modes

In EL5101-0010 “enhanced operation mode” the following modes are available:

Mode	DC	Main PDO	Comment	Optional PDO 1	Comment	Optional PDO 2	Comment	Features CoE	Comment
7	FreeRun	0x1A00 [▶ 208] + 0x1600 [▶ 206]	Count/Latch in 32 bit	0x1A03 [▶ 209] or 0x1A02 [▶ 209]	Frequency (32 bit) or Period (32 bit)	--		0x8000:nn [▶ 202]	CoE combinations 0x8000:nn [▶ 202]
8	"	0x1A01 [▶ 209] + 0x1601 [▶ 206]	compact: Count/Latch in 16 bit	"	"	--		"	"
9	DC/DCi	0x1A00 [▶ 208] + 0x1600 [▶ 206]	Count/Latch in 32 bit	"	"	0x1A04 [▶ 209] or 0x1A05 [▶ 210]	Timestamp 64 bit Timestamp 32 bit (compact)	"	"
10	"	0x1A01 [▶ 209] + 0x1601 [▶ 206]	compact: Count/Latch in 16 bit	"	"	"	"	"	"

Other settings may result in irregular process data and lead to error messages in the TwinCAT System Manager logger window.



Parameterization

- Use a [CoE reset \[▶ 273\]](#) in order to deactivate any previous settings
- In order to activate the new operating mode, reload the EtherCAT slaves ( button)

DC (Distributed Clocks)

Describes whether the terminal is operated with distributed clocks support:

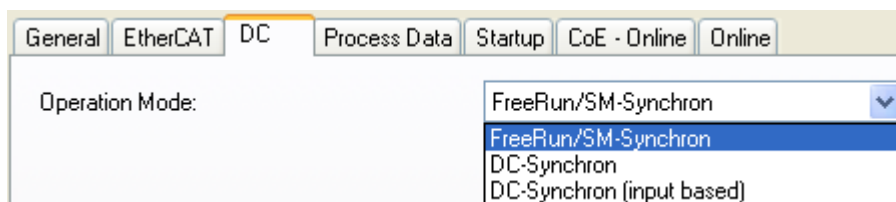

Fig. 170: “DC” tab

- **FreeRun:** the terminal operates frame-triggered. Cyclic operation is started via the SyncManagers of the EtherCAT frame processing.
- **DC-Synchron:** cyclic operation in the terminal is started by the local distributed clock at exact intervals. The start time is chosen such that it coincides with other output slaves in the EtherCAT system.
- **DC-Synchron (input based):** as DC-Synchron mode, with the cyclic start time chosen such that it coincides with other input slaves in the EtherCAT system.

15.1.2 Process data

Main PDO

Selection of basic process data

General EtherCAT DC **Process Data** Plc Startup CoE - Online Online

Sync Manager:

SM	Size	Type	Flags
0	128	MbxOut	
1	128	MbxIn	
2	4	Outputs	
A 3	6	Inputs	

PDO List:

Index	Size	Name	Flags	SM	SI
0x1A00	10.0	ENC Status	F		0
C 0x1A01	6.0	ENC Status compact	F	3	0
0x1A02	4.0	ENC Period	F		0
0x1A03	4.0	ENC Frequency	F		0
0x1A04	8.0	ENC Timest.	F		0
0x1A05	4.0	ENC Timest. compact	F		0
0x1600	6.0	ENC Control	F		0
0x1601	4.0	ENC Control compact	F	2	0

PDO Assignment (0x1C13):

B 0x1A00 (excluded by 0x1A01)
 0x1A01
 0x1A02
 0x1A03
 0x1A04
 0x1A05

PDO Content (0x1A01):

Index	Size	Offs	Name	Type	D
0x6000:01	0.1	0.0	Status__Latch C valid	BIT	
0x6000:02	0.1	0.1	Status__Latch extern valid	BIT	
0x6000:03	0.1	0.2	Status__Set counter done	BIT	
--	0.2	0.3	--		

Download
 PDO Assignment
 PDO Configuration

Predefined PDO Assignment: 'Standard 16 Bit (MDP 511)'
 Load PDO info from device
 Sync Unit Assignment...

Fig. 171: "Process data" tab

A: Selection of data direction: input or output

B: Selection of (optional) PDOs (process data objects)

C: Explanatory notes for PDOs

compact: The process data can be represented with 16 bits (compact) or with 32 bits.

Optional PDOs

Optional PDOs, in addition to the main PDO:

- PDO 1 (0x1A03 [▶ 209] or 0x1A02 [▶ 209]): The **frequency** or the **period** can be selected as optional PDO 1
- PDO 2 (0x1A05 [▶ 210] or 0x1A04 [▶ 209]): In one of the DC modes a 32 bit or 64 bit **timestamp** can be selected. The timestamp specifies the time of the last registered increment edge, based on the DistributedClocks system.

Process data description

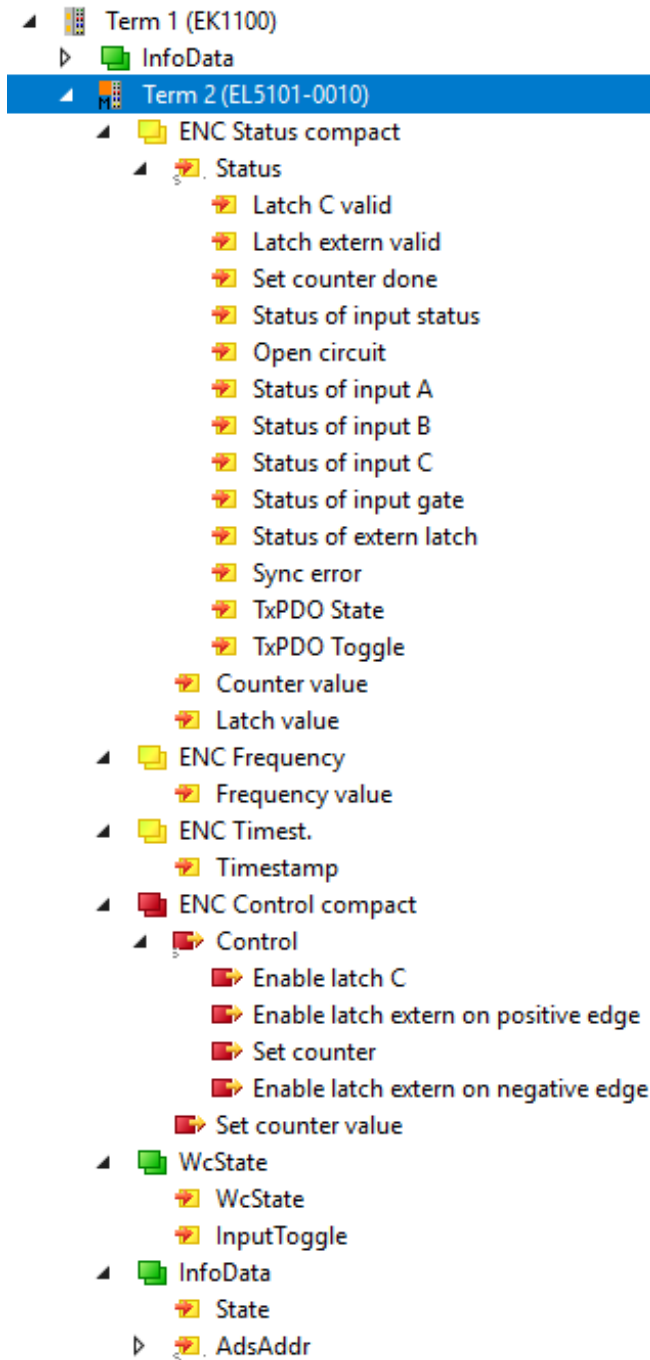

Fig. 172: Process data description

The process data are generated from CoE objects 0x6000 (inputs) and 0x7000 (outputs) and are described in section [Object description and parameterization \[► 201\]](#)

15.1.2.1 Sync Manager (SM)

The scope of process data offered can be modified via the "Process Data" tab (see Fig. *EL5101-0010 - Process Data tab SM3, (default)* below).

A detailed description for setting the process data can be found in chapter [Process Data tab](#) [▶ 126].

Sync Manager:

SM	Size	Type	Flags
0	128	MbxOut	
1	128	MbxIn	
2	4	Outputs	
3	6	Inputs	

PDO List:

Index	Size	Name	Flags	SM	SI
0x1A00	10.0	ENC Status	F		0
0x1A01	6.0	ENC Status compact	F	3	0
0x1A02	4.0	ENC Period	F		0
0x1A03	4.0	ENC Frequency	F		0
0x1A04	8.0	ENC Timest.	F		0
0x1A05	4.0	ENC Timest. compact	F		0
0x1600	6.0	ENC Control	F		0
0x1601	4.0	ENC Control compact	F	2	0

PDO Assignment (0x1C13):

- 0x1A00 (excluded by 0x1A01)
- 0x1A01
- 0x1A02
- 0x1A03
- 0x1A04
- 0x1A05

PDO Content (0x1A01):

Index	Size	Offs	Name	Type	D
0x6000:01	0.1	0.0	Status__Latch C valid	BIT	
0x6000:02	0.1	0.1	Status__Latch extern valid	BIT	
0x6000:03	0.1	0.2	Status__Set counter done	BIT	
---	0.2	0.3	---		
0x6000:06	0.1	0.5	Status__Status of input status	BIT	
0x6000:07	0.1	0.6	Status__Open circuit	BIT	
---	0.1	0.7	---		
0x6000:09	0.1	1.0	Status__Status of input A	BIT	
0x6000:0A	0.1	1.1	Status__Status of input B	BIT	
0x6000:0B	0.1	1.2	Status__Status of input C	BIT	
0x6000:0C	0.1	1.3	Status__Status of input gate	BIT	
0x6000:0D	0.1	1.4	Status__Status of extern latch	BIT	
0x6000:0E	0.1	1.5	Status__Sync error	BIT	
0x6000:0F	0.1	1.6	Status__TxPDO State	BIT	
0x6000:10	0.1	1.7	Status__TxPDO Toggle	BIT	
0x6000:11	2.0	2.0	Counter value	UINT	
0x6000:12	2.0	4.0	Latch value	UINT	
		6.0			

Download

- PDO Assignment
- PDO Configuration

Predefined PDO Assignment: 'Standard 16 Bit (MDP 511)'

Load PDO info from device

Sync Unit Assignment...

EL5101-0010 - Process data SM3 tab (default)

15.1.2.2 PDO assignment

This chapter describes the assignment of the Process data objects (PDO) of the EL5101-0010 terminal.

15.1.2.2.1 SM3 - Inputs (0x1A00 .. 0x1A05)

0x1A00 - ENC Status (10.0)	
Contents	Excluded PDOs
Index - name size (byte.bit)	Index - name size (byte.bit)
0x6000:01 [▶ 204] - Status_Latch C valid (0.1)	0x1A01 [▶ 209] - ENC Status compact (6.0)
0x6000:02 [▶ 204] - Status_Latch extern valid (0.1)	
0x6000:03 [▶ 204] - Status_Set counter done (0.1)	
0x6000:06 [▶ 204] - Status_Status of input status (0.1)	
0x6000:07 [▶ 204] - Status_Open circuit (0.1)	
0x6000:09 [▶ 204] - Status_Status of input A (0.1)	
0x6000:0A [▶ 204] - Status_Status of input B (0.1)	
0x6000:0B [▶ 204] - Status_Status of input C (0.1)	
0x6000:0C [▶ 204] - Status_Status of input gate (0.1)	
0x6000:0D [▶ 204] - Status_Status Status of extern latch (0.1)	
0x6000:0E [▶ 204] - Status_Sync error (0.1)	
0x6000:0F [▶ 204] - Status_Status TxPDO State (0.1)	
0x6000:10 [▶ 204] - Status_Status TxPDO Toggle (0.1)	
0x6000:11 [▶ 204] - Counter value (4.0)	
0x6000:12 [▶ 204] - Latch value (4.0)	

0x1A01 - ENC Status compact (6.0)	
Contents	Excluded PDOs
Index - name size (byte.bit)	Index - name size (byte.bit)
0x6000:01 [▶ 204] - Status_Latch C valid (0.1)	0x1A00 [▶ 208] - ENC Status (10.0)
0x6000:02 [▶ 204] - Status_Latch extern valid (0.1)	
0x6000:03 [▶ 204] - Status_Set counter done (0.1)	
0x6000:06 [▶ 204] - Status_Status of input status (0.1)	
0x6000:07 [▶ 204] - Status_Open circuit (0.1)	
0x6000:09 [▶ 204] - Status_Status of input A (0.1)	
0x6000:0A [▶ 204] - Status_Status of input B (0.1)	
0x6000:0B [▶ 204] - Status_Status of input C (0.1)	
0x6000:0C [▶ 204] - Status_Status of input gate (0.1)	
0x6000:0D [▶ 204] - Status_Status Status of extern latch (0.1)	
0x6000:0E [▶ 204] - Status_Sync error (0.1)	
0x6000:0F [▶ 204] - Status_Status TxPDO State (0.1)	
0x6000:10 [▶ 204] - Status_Status TxPDO Toggle (0.1)	
0x6000:11 [▶ 204] - Counter value (2.0)	
0x6000:12 [▶ 204] - Latch value (2.0)	

0x1A02 - ENC Period (4.0)	
Contents	Excluded PDOs
Index - name size (byte.bit)	Index name size (byte.bit)
0x6000:14 [▶ 204] - Period value (4.0)	0x1A03 [▶ 209] - ENC Frequency (4.0)

0x1A03 - ENC Frequency (4.0)	
Contents	Excluded PDOs
Index - name size (byte.bit)	Index name size (byte.bit)
0x6000:13 [▶ 204] - Frequency value (4.0)	0x1A02 [▶ 209] - ENC Period (4.0)

0x1A04 - ENC Timest. (8.0)	
Contents	Excluded PDOs
Index - name size (byte.bit)	Index name size (byte.bit)
0x6000:16 [▶ 204] - Timestamp (8.0)	0x1A05 [▶ 210] - ENC Timest. compact (4.0)

0x1A05 - ENC Timest. compact (4.0)	
Contents Index - name size (byte.bit)	Excluded PDOs Index name size (byte.bit)
0x6000:16 [▶ 204] - Timestamp (4.0)	0x1A04 [▶ 209] - ENC Timest. (8.0)

15.1.2.2.2 SM2 - Outputs (0x1600 .. 0x1601)

0x1600 - ENC Control (6.0)	
Contents Index - name size (byte.bit)	Excluded PDOs Index - name size (byte.bit)
0x7000:01 [▶ 204] - Control_Enable latch C (0.1)	0x1601 [▶ 206] - ENC Control compact (4.0)
0x7000:02 [▶ 204] - Control_Enable latch extern on positive edge (0.1)	
0x7000:03 [▶ 204] - Control_Set counter (0.1)	
0x7000:04 [▶ 204] - Control_Enable latch extern on negative edge (0.1)	
0x7000:11 [▶ 204] - Set counter value (4.0)	

0x1601 - ENC Control compact (4.0)	
Contents Index - name size (byte.bit)	Excluded PDOs Index - name size (byte.bit)
0x7000:01 [▶ 204] - Control_Enable latch C (0.1)	0x1600 [▶ 206] - ENC Control (6.0)
0x7000:02 [▶ 204] - Control_Enable latch extern on positive edge (0.1)	
0x7000:03 [▶ 204] - Control_Set counter (0.1)	
0x7000:04 [▶ 204] - Control_Enable latch extern on negative edge (0.1)	
0x7000:11 [▶ 204] - Set counter value (2.0)	

15.1.2.3 Predefined PDO Assignment

The "Predefined PDO Assignment" enables a simplified selection of the process data. The desired function is selected on the lower part of the Process Data tab. As a result, all necessary PDOs are automatically activated and the unnecessary PDOs are deactivated.

Fig. 173: EL5101-0010 - Process data, Predefined PDO (default: Standard 16 Bit (MDP 511))

Four PDO assignments are available in modes "Standard" and "Line Motion".

Note on the use of timestamp function

I In order to be able to use the timestamp function, the EL5101-0010 must be operated in "DC Synchron" or "DC Synchron (input based)" mode.

Predefined PDO assignments for "Standard" mode

Predefined PDO Assignment	PDO Assignment
Standard 16 Bit (MDP 511)	SM3: 0x1A01 [▶ 209] - ENC Status compact (6.0) SM2: 0x1601 [▶ 206] - ENC Control compact (4.0)
Standard 32 Bit (MDP 511)	SM3: 0x1A00 [▶ 208] - ENC Status (10.0) SM2: 0x1600 [▶ 206] - ENC Control (6.0)

Predefined PDO Assignments for “Line Motion” mode

Predefined PDO Assignment	PDO Assignment
Line Motion (MDP 511)	SM3: 0x1A01 [▶ 209] - ENC Status compact (6.0) 0x1A02 [▶ 209] - ENC Period (4.0) SM2: 0x1601 [▶ 206] - ENC Control compact (4.0)
Line Motion DC (MDP 511)	SM3: 0x1A01 [▶ 209] - ENC Status compact (6.0) 0x1A05 [▶ 210] - ENC Timest. Compact (4.0) SM2: 0x1601 [▶ 206] - ENC Control compact (4.0)

15.1.3 Features CoE

Depending on the main PDO/optional PDOs further settings can be selected in the CoE list (CAN over EtherCAT).

i Parameterization via the CoE list (CAN over EtherCAT)

Please note the following general CoE information when using/manipulating the CoE parameters: - Keep a startup list if components have to be replaced - Differentiation between online/offline dictionary, existence of current XML description - Use “CoE reload [▶ 273]” for resetting changes

The following CoE settings are possible from object [0x8000 \[▶ 202\]](#) and are shown below in their default settings:

Index	Name	Flags	Value	Unit
8001:0	Non-Volatile Settings 1	RW	> 2 <	
8010:0	ENC Settings	RW	> 23 <	
8010:01	Enable C reset	RW	FALSE	
8010:02	Enable extem reset	RW	FALSE	
8010:03	Enable up/down counter	RW	FALSE	
8010:04	Gate polarity	RW	Enable pos. gate (1)	
8010:08	Disable filter	RW	TRUE	
8010:0A	Enable micro increments	RW	FALSE	
8010:0B	Open circuit detection A	RW	TRUE	
8010:0C	Open circuit detection B	RW	TRUE	
8010:0D	Open circuit detection C	RW	FALSE	
8010:0E	Reversion of rotation	RW	FALSE	
8010:10	Extem reset polarity	RW	Rise (1)	
8010:11	Frequency window	RW	0x2710 (10000)	
8010:13	Frequency scaling	RW	0.01Hz (100)	
8010:14	Period scaling	RW	100ns (100)	
8010:15	Frequency resolution	RW	0.01Hz (100)	
8010:16	Period resolution	RW	100ns (100)	
8010:17	Frequency wait time	RW	0x0640 (1600)	
A010:0	ENC Diag data	RO	> 3 <	

Fig. 174: “CoE-Online” tab

The parameters are described on page [object description and parameterization \[▶ 201\]](#).

Frequency

- The time window for the frequency calculation and the resolution can be parameterized in CoE objects [0x8000:11](#), [0x8000:13](#), [0x8000:15](#), [0x8000:17](#) [[▶ 202](#)].
- The positive edges of track A are counted within the specified timeframe and the next edge including the time up to it are counted. The waiting time can be set in CoE object [0x8000:17](#) [[▶ 202](#)] “Frequency Wait Time” (unit: ms). The default value is 1.6 sec. This is also the maximum value.
- The time window is 10 ms (default), min. 1 μs. With the default setting it is possible to measure frequencies up to approx. 800 kHz. At higher frequencies a smaller value must be selected for the timeframe.
- The time is measured with a resolution of 100 ns.
- This calculation is carried out in the slave without reference to the distributed clocks system. It is therefore independent of the DC mode.
- No frequency measurement is possible if the counter is blocked by the gate. In this case the period can be measured regardless.
- A C or external reset restarts the frequency measurement. The last frequency value remains unchanged until a new frequency value is determined.

Frequency measurement

- Basic unit 1 μs: all window sizes

Measurement sequence

- The measurement starts with a positive edge at track A. The current counter value and time (resolution: 100 ns) are stored.
- After the measuring window time has elapsed (index [0x8000:11](#) [[▶ 202](#)]), the system waits for the following rising edge at track A or a maximum of 1.6 sec or the time from [0x8000:17](#) [[▶ 202](#)]
- The frequency is calculated from the edge difference and the actual elapsed time.

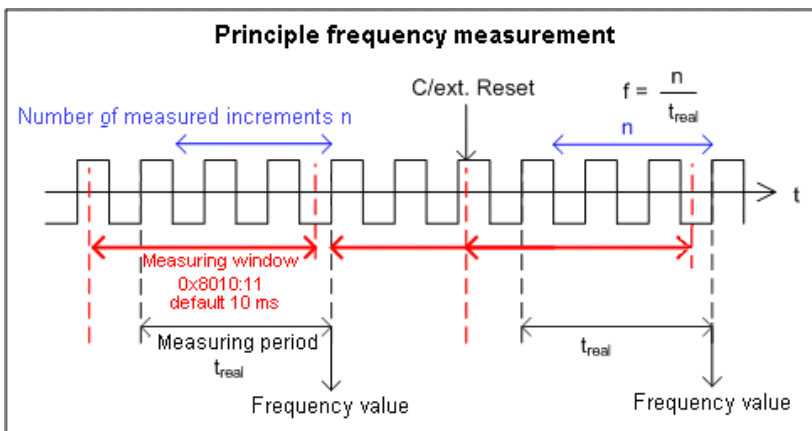

Fig. 175: Frequency measurement principle in enhanced operation mode

Period calculation

- This calculation is carried out in the slave without reference to the distributed clocks system. It is therefore independent of the DC mode.
- In each cycle the interval between two positive edges of input A is counted with a resolution of 100 ns.
- If no edge change occurs for approx. 1.6 s, any period specification is cancelled.

● **Frequency and period measurement**

I From the explanatory notes above it is apparent that the frequency measurement can measure the current axis status (velocity) significantly more accurately than the period measurement. Frequency measurement is therefore preferable, if possible.

Latch

- **Activation of latch C input (“C”) and saving (“latching”) of the counter value (index [0x7000:01](#) [[▶ 204](#)])**
 - The counter value is saved at the first external latch pulse (positive edge at input “C”) after the bit has been set (TRUE) in index [0x7000:01](#) [[▶ 204](#)] (has priority before [0x7000:02](#) / [0x7000:04](#) [[▶ 204](#)]). The subsequent pulses at the other inputs have no influence on the latch value in index [0x6000:12](#) [[▶ 204](#)] if the bit is set.
 - Note for “Latch C valid” bit: A new counter value at the latch input can only be written once the value of the “Latch C valid” bit (index [0x6000:01](#)) is FALSE.
- **Activation of the external latch input (“gate/latch”) and latching of the counter value (index [0x7000:02](#), [0x7000:04](#) [[▶ 204](#)])**
 - The counter value at the latch input (Index [0x6000:12](#) [[▶ 204](#)]) will be saved upon the first external latch pulse with a rising edge if the bit (TRUE) is set in index [0x7000:02](#) [[▶ 204](#)]. The subsequent pulses have no influence on the latch value in index [0x6000:12](#) [[▶ 204](#)].
 - The counter value at the latch input (Index [0x6000:12](#) [[▶ 204](#)]) will be saved upon the first external latch pulse with a falling edge if the bit (TRUE) is set in index [0x7000:04](#) [[▶ 204](#)]. The subsequent pulses have no influence on the latch value in index [0x6000:12](#) [[▶ 204](#)].
 - Note for "Latch extern valid" bit: A new counter value at the latch input can only be written once the value of the “Latch extern valid” bit (index [0x6000:02](#) [[▶ 204](#)]) is FALSE.

Reset

- Counter reset (index [0x8000:01](#), [0x8000:02](#), [0x8000:10](#) [[▶ 202](#)]): For a counter reset via input C set the bit in index [0x80n0:01](#), for a reset via the external latch input set the bit in index [0x80n0:02](#).
- The functions “Enable C reset” ([0x8000:01](#) [[▶ 202](#)]) and “Enable extern reset” ([0x8000:02](#) [[▶ 202](#)]) cannot be activated simultaneously.
- Note for “Extern reset polarity”, index [0x8000:10](#) [[▶ 202](#)]: The edge for setting the counter to zero can be selected via index [0x8000:10](#) [[▶ 202](#)].
Bit not set: counter is set to zero with falling edge.
Bit set: counter is set to zero with rising edge.

Open circuit detection

- A separate open circuit detection can be activated for each of the channels A, B and C (index [0x8000:0B](#), [0x8000:0C](#), [0x8000:0D](#) [[▶ 202](#)]).
- Open circuit detection is activated for channels A and B by default.
- A differential voltage of typically) and in the range of typically $-0.475\text{ V} > V_{id} > +0.475\text{ V}$ is detected as an open ircuit.
- If an open circuit is detected, it is indicated as process data *open circuit* = TRUE. The bit in object [0x6000:07](#) [[▶ 204](#)] is set. An open circuit is indicated separately in indices [0xA000:01](#) [[▶ 205](#)] (track A), [0xA000:02](#) [[▶ 205](#)] (track B) and [0xA0n0:03](#) (track C).
- TxPDO state also becomes TRUE if an open circuit is detected, since invalid data have to be assumed.

15.1.4 Object description and parameterization - enhanced operation mode

EtherCAT XML Device Description

The display matches that of the CoE objects from the EtherCAT XML Device Description. We recommend downloading the latest XML file from the download area of the Beckhoff website and installing it according to installation instructions.

NOTICE



Parameterization via the CoE list (CAN over EtherCAT)

The EtherCAT device is parameterized via the CoE - Online tab (with a double click on the respective object) or via the Process Data tab (assignment of PDOs). A detailed description can be found in the EtherCAT System-Documentation in chapter "[EtherCAT subscriber configuration](#)"

Please note the general CoE notes in the EtherCAT System Documentation in chapter "[CoE-interface](#)" when using/manipulating the CoE parameters:

- Keep a startup list if components have to be replaced
- Differentiation between online/offline dictionary,
- existence of current XML description
- use "CoE reload" for resetting changes

15.1.4.1 Restore object

Index 1011 Restore default parameters

Index (hex)	Name	Meaning	Data type	Flags	Default
1011:0	Restore default parameters [▶ 273]	Restore default parameters	UINT8	RO	0x01 (1 _{dec})
1011:01	SubIndex 001	If this object is set to " 0x64616F6C " in the set value dialog, all backup objects are reset to their delivery state.	UINT32	RW	0x00000000 (0 _{dec})

15.1.4.2 Configuration data

Index 8000 ENC Settings (EL5101-0010)

Index (hex)	Name	Meaning	Data type	Flags	Default
8000:0	ENC Settings	Maximum subindex	UINT8	RO	0x17 (23 _{dec})
8000:01	Enable C reset [► 200]	The counter is reset via the C input.	BOOLEAN	RW	0x00 (0 _{dec})
8000:02	Enable extern reset	A counter reset is triggered via the external latch input (24 V)	BOOLEAN	RW	0x00 (0 _{dec})
8000:04	Gate polarity	0: Disable gate 1: Enable pos. gate (gate locks with HIGH level) 2: Enable neg. gate (gate locks with LOW level)	BIT2	RW	0x01 (1 _{dec})
8000:0B	Open circuit detection A [► 200]	An open circuit on track A is indicated in index 0x6000:07 [► 204] and as process data. Diagnosis is only possible if the corresponding input is wired differentially. A differential voltage $-0.475\text{ V} > \text{Vid} > +0.475\text{ V}$ (typical, subject to change) is detected as a broken wire.	BOOLEAN	RW	0x01 (1 _{dec})
8000:0C	Open circuit detection B [► 200]	An open circuit on track B is indicated in index 0x6000:07 [► 204] and as process data. Diagnosis is only possible if the corresponding input is wired differentially. A differential voltage $-0.475\text{ V} > \text{Vid} > +0.475\text{ V}$ (typical, subject to change) is detected as a broken wire.	BOOLEAN	RW	0x01 (1 _{dec})
8000:0D	Open circuit detection C [► 200]	An open circuit on track C is indicated in index 0x6000:07 [► 204] and as process data. Diagnosis is only possible if the corresponding input is wired differentially. A differential voltage $-0.475\text{ V} > \text{Vid} > +0.475\text{ V}$ (typical, subject to change) is detected as a broken wire.	BOOLEAN	RW	0x00 (0 _{dec})
8000:0E	Reversion of rotation	Activates reversion of rotation	BOOLEAN	RW	0x00 (0 _{dec})
8000:10	Extern reset polarity [► 200]	0: Fall (the counter is set to zero with a falling edge) 1: Rise (the counter is set to zero with a rising edge)	BIT1	RW	0x01 (1 _{dec})
8000:11	Frequency window [► 199]	This is the minimum time over which the frequency is determined. Default 10 ms [resolution: 1 μs] The number of pulses in the time window + the following is measured. The maximum waiting time is specified in the "Frequency Wait Time" parameter. The number of pulses is divided by the actual time window size. The determined frequency is output in index 0x6000:13 [► 204] and as a process data. The frequency calculation is carried out locally without distributed clocks function.	UINT16	RW	0x2710 (10000 _{dec})
8000:13	Frequency scaling [► 199]	Scaling of the frequency measurement (must be divided by this value to obtain the unit in Hz): 100: "0.01 Hz"	UINT16	RW	0x0064 (100 _{dec})
8000:14	Period scaling [► 199]	Resolution of the period in the process data: 100: "100 ns" period value is a multiple of 100 ns 500: "500 ns" period value is a multiple of 500 ns	UINT16	RW	0x0064 (100 _{dec})
8000:15	Frequency resolution [► 199]	Resolution of the frequency measurement: 100: "0.01 Hz"	UINT16	RW	0x0064 (100 _{dec})

Index 8000 ENC Settings (EL5101-0010)

Index (hex)	Name	Meaning	Data type	Flags	Default
8000:16	Period resolution ▶ 199	<p>Internal resolution of the period measurement:</p> <p>100: "100 ns" period value is a multiple of 100 ns The period is calculated internally with a resolution of 100 ns. The max. measurable period can then be approx. 1.6 seconds.</p> <p>500: "500 ns" period value is a multiple of 500 ns Internally the period is calculated with 500 ns resolution. The maximum measurable period is approx. 32.7 ms. The resolution of process data continues to be the value according to index 0x8000:14 ▶ 202 (e.g. 100 ns [default]).</p>	UINT16	RW	0x0064 (100 _{dec})
8000:17	Frequency Wait Time ▶ 199	<p>Waiting time [ms] for frequency measurement</p> <p>Once the time specified in the frequency window ▶ 199 has elapsed, the system waits for the next positive edge from track A. This enables the update speed for the Frequency process data to be optimized, depending on the expected frequencies. At least double the period of the minimum frequency to be measured should be entered here. $t \geq 2 * (1 / f_{min})$</p>	UINT16	RW	0x0190 (400 _{dec})

15.1.4.3 Input data

Index 6000 ENC Inputs (EL5101-0010)

Index (hex)	Name	Meaning	Data type	Flags	Default
6000:0	ENC Inputs	Maximum subindex	UINT8	RO	0x16 (22 _{dec})
6000:01	Latch C valid [► 200]	The counter value was locked with the “C” input. The data with index 0x6000:12 [► 204] match the latched value when the bit is set. To reactivate the latch input, index 0x7000:01 [► 204] must be cancelled and then reset.	BOOLEAN	RO	0x00 (0 _{dec})
6000:02	Latch extern valid [► 200]	The counter value was locked via the external latch. The data with index 0x6000:12 [► 204] match the latched value when the bit is set. To reactivate the latch input, index 0x7000:02 [► 204] or object index 0x7000:04 [► 204] must be cancelled and then reset.	BOOLEAN	RO	0x00 (0 _{dec})
6000:03	Set counter done	The counter was set.	BOOLEAN	RO	0x00 (0 _{dec})
6000:06	Status of input status	State of the status input (alarm “input 1”)	BOOLEAN	RO	0x00 (0 _{dec})
6000:07	Open circuit [► 200]	Indicates an open circuit. Configuration via index 0x8000:0A, 0x8000:0B [► 202], 0x8000:0C [► 202]	BOOLEAN	RO	0x00 (0 _{dec})
6000:09	Status of input A	Status of input A	BOOLEAN	RO	0x00 (0 _{dec})
6000:0A	Status of input B	Status of input B	BOOLEAN	RO	0x00 (0 _{dec})
6000:0B	Status of input C	Status of input C	BOOLEAN	RO	0x00 (0 _{dec})
6000:0C	Status of input gate	The state of the gate input	BOOLEAN	RO	0x00 (0 _{dec})
6000:0D	Status of extern latch	Status of the ext. latch input	BOOLEAN	RO	0x00 (0 _{dec})
6000:0E	Sync Error	The Sync error bit is only required for DC mode. It indicates whether a synchronization error has occurred during the previous cycle. This means a SYNC signal was triggered in the terminal, although no new process data were available (0=OK, 1=NOK).	BOOLEAN	RO	0x00 (0 _{dec})
6000:0F	TxPDO State	Validity of the data of the associated TxPDO (0 = valid, 1 = invalid).	BOOLEAN	RO	0x00 (0 _{dec})
6000:10	TxPDO Toggle	The TxPDO toggle is toggled by the slave when the data of the associated TxPDO is updated.	BOOLEAN	RO	0x00 (0 _{dec})
6000:11	Counter value	Counter value	UINT32	RO	0x00000000 (0 _{dec})
6000:12	Latch value	Latch value	UINT32	RO	0x00000000 (0 _{dec})
6000:13	Frequency value [► 199]	The frequency (setting of the scaling and resolution in index 0x8000:13 [► 202] and 0x8000:15 [► 202])	UINT32	RO	0x00000000 (0 _{dec})
6000:14	Period value [► 202]	The period (setting of the scaling and resolution in index 0x8000:14 [► 202] and 0x8000:16 [► 202])	UINT32	RO	0x00000000 (0 _{dec})
6000:16	Timestamp [► 192]	Timestamp of the last counter change	UINT64	RO	

15.1.4.4 Output data

Index 7000 ENC Outputs (EL5101-0010)

Index (hex)	Name	Meaning	Data type	Flags	Default
7000:0	ENC Outputs	Maximum subindex	UINT8	RO	0x11 (17 _{dec})
7000:01	Enable latch C [► 200]	Activate latching via input “C”.	BOOLEAN	RO	0x00 (0 _{dec})
7000:02	Enable latch extern on positive edge [► 200]	Activate external latch with positive edge.	BOOLEAN	RO	0x00 (0 _{dec})
7000:03	Set counter	Set counter	BOOLEAN	RO	0x00 (0 _{dec})
7000:04	Enable latch extern on negative edge [► 200]	Activate external latch with negative edge.	BOOLEAN	RO	0x00 (0 _{dec})
7000:11	Set counter value	The counter value to be set via “Set counter” (index 0x7000:03 [► 204]).	UINT32	RO	0x00000000 (0 _{dec})

15.1.4.5 Information / diagnostic data (channel specific)

Index A000 ENC Diag data (EL5101-0010)

Index (hex)	Name	Meaning	Data type	Flags	Default
A000:0	ENC Diag data	Maximum subindex	UINT8	RO	0x04 (4 _{dec})
A000:01	Open circuit A [▶ 200]	Open circuit on track A	BOOLEAN	RO	0x00 (0 _{dec})
A000:02	Open circuit B [▶ 200]	Open circuit on track B	BOOLEAN	RO	0x00 (0 _{dec})
A000:03	Open circuit C [▶ 200]	Open circuit on track C	BOOLEAN	RO	0x00 (0 _{dec})
A000:04	Field power failure	Field bus voltage error	BOOLEAN	RO	0x00 (0 _{dec})

15.1.4.6 Standard objects

The standard objects have the same meaning for all EtherCAT slaves.

Index 1000 Device type

Index (hex)	Name	Meaning	Data type	Flags	Default
1000:0	Device type	Device type of the EtherCAT slave: the Lo-Word contains the CoE profile used (5001). The Hi-Word contains the module profile according to the modular device profile.	UINT32	RO	0x00001389 (5001 _{dec})

Index 1008 Device name

Index (hex)	Name	Meaning	Data type	Flags	Default
1008:0	Device name	Device name of the EtherCAT slave	STRING	RO	EL5101-0010

Index 1009 Hardware version

Index (hex)	Name	Meaning	Data type	Flags	Default
1009:0	Hardware version	Hardware version of the EtherCAT slave	STRING	RO	09

Index 100A Software version

Index (hex)	Name	Meaning	Data type	Flags	Default
100A:0	Software version	Firmware version of the EtherCAT slave	STRING	RO	10

Index 1018 Identity

Index (hex)	Name	Meaning	Data type	Flags	Default
1018:0	Identity	Information for identifying the slave	UINT8	RO	0x04 (4 _{dec})
1018:01	Vendor ID	Vendor ID of the EtherCAT slave	UINT32	RO	0x00000002 (2 _{dec})
1018:02	Product code	Product code of the EtherCAT slave	UINT32	RO	0x13ED3052 (334311506 _{dec})
1018:03	Revision	Revision number of the EtherCAT slave; the low word (bit 0-15) indicates the special terminal number, the high word (bit 16-31) refers to the device description	UINT32	RO	0x00000000 (0 _{dec})
1018:04	Serial number	Serial number of the EtherCAT slave; the low byte (bit 0-7) of the low word contains the year of production, the high byte (bit 8-15) of the low word contains the week of production, the high word (bit 16-31) is 0	UINT32	RO	0x00000000 (0 _{dec})

Index 10F0 Backup parameter handling

Index (hex)	Name	Meaning	Data type	Flags	Default
10F0:0	Backup parameter handling	Information for standardized loading and saving of backup entries	UINT8	RO	0x01 (1 _{dec})
10F0:01	Checksum	Checksum across all backup entries of the EtherCAT slave	UINT32	RO	0x00000000 (0 _{dec})

Index 1400 ENC RxPDO-Par Control (EL5101-0010)

Index (hex)	Name	Meaning	Data type	Flags	Default
1400:0	ENC RxPDO-Par Control	PDO Parameter RxPDO 1	UINT8	RO	0x06 (6 _{dec})
1400:06	Exclude RxPDOs	Specifies the RxPDOs (index of RxPDO mapping objects) that must not be transferred together with RxPDO 1	OCTET-STRING[2]	RO	01 16

Index 1401 ENC RxPDO-Par Control compact (EL5101-0010)

Index (hex)	Name	Meaning	Data type	Flags	Default
1401:0	ENC RxPDO-Par Control compact	PDO Parameter RxPDO 2	UINT8	RO	0x06 (6 _{dec})
1401:06	Exclude RxPDOs	Specifies the RxPDOs (index of RxPDO mapping objects) that must not be transferred together with RxPDO 2	OCTET-STRING[2]	RO	00 16

Index 1600 ENC RxPDO-Map Control (EL5101-0010)

Index (hex)	Name	Meaning	Data type	Flags	Default
1600:0	ENC RxPDO-Map Control	PDO Mapping RxPDO 1	UINT8	RO	0x07 (7 _{dec})
1600:01	SubIndex 001	1. PDO Mapping entry (object 0x7000 (ENC Outputs), entry 0x01 (Enable latch C))	UINT32	RO	0x7000:01, 1
1600:02	SubIndex 002	2. PDO Mapping entry (object 0x7000 (ENC Outputs), entry 0x02 (Enable latch extern on positive edge))	UINT32	RO	0x7000:02, 1
1600:03	SubIndex 003	3. PDO Mapping entry (object 0x7000 (ENC Outputs), entry 0x03 (Set counter))	UINT32	RO	0x7000:03, 1
1600:04	SubIndex 004	4. PDO Mapping entry (object 0x7000 (ENC Outputs), entry 0x04 (Enable latch extern on negative edge))	UINT32	RO	0x7000:04, 1
1600:05	SubIndex 005	5. PDO Mapping entry (4 bits align)	UINT32	RO	0x0000:00, 4
1600:06	SubIndex 006	6. PDO Mapping entry (8 bits align)	UINT32	RO	0x0000:00, 8
1600:07	SubIndex 007	7. PDO Mapping entry (object 0x7000 (ENC Outputs), entry 0x11 (Set counter value))	UINT32	RO	0x7000:11, 32

Index 1601 ENC RxPDO-Map Control compact (EL5101-0010)

Index	Name	Meaning	Data type	Flags	Default
1601:0	ENC RxPDO-Map Control compact	PDO Mapping RxPDO 2	UINT8	RO	0x07 (7 _{dec})
1601:01	SubIndex 001	1. PDO Mapping entry (object 0x7000 (ENC Outputs), entry 0x01 (Enable latch C))	UINT32	RO	0x7000:01, 1
1601:02	SubIndex 002	2. PDO Mapping entry (object 0x7000 (ENC Outputs), entry 0x02 (Enable latch extern on positive edge))	UINT32	RO	0x7000:02, 1
1601:03	SubIndex 003	3. PDO Mapping entry (object 0x7000 (ENC Outputs), entry 0x03 (Set counter))	UINT32	RO	0x7000:03, 1
1601:04	SubIndex 004	4. PDO Mapping entry (object 0x7000 (ENC Outputs), entry 0x04 (Enable latch extern on negative edge))	UINT32	RO	0x7000:04, 1
1601:05	SubIndex 005	5. PDO Mapping entry (4 bits align)	UINT32	RO	0x0000:00, 4
1601:06	SubIndex 006	6. PDO Mapping entry (8 bits align)	UINT32	RO	0x0000:00, 8
1601:07	SubIndex 007	7. PDO Mapping entry (object 0x7000 (ENC Outputs), entry 0x11 (Set counter value))	UINT32	RO	0x7000:11, 16

Index 1800 ENC TxPDO-Par Status (EL5101-0010)

Index (hex)	Name	Meaning	Data type	Flags	Default
1800:0	ENC TxPDO-Par Status	PDO Parameter TxPDO 1	UINT8	RO	0x09 (9 _{dec})
1800:06	Exclude TxPDOs	Specifies the TxPDOs (index of TxPDO mapping objects) that must not be transferred together with TxPDO 1	OCTET-STRING[2]	RO	01 1A
1800:07	TxPDO State	The TxPDO state is set if it was not possible to correctly read in the associated input data	BOOLEAN	RO	0x00 (0 _{dec})
1800:09	TxPDO Toggle	The TxPDO toggle is toggled with each update the corresponding input data	BOOLEAN	RO	0x00 (0 _{dec})

Index 1801 ENC TxPDO-Par Status compact (EL5101-0010)

Index (hex)	Name	Meaning	Data type	Flags	Default
1801:0	ENC TxPDO-Par Status compact	PDO Parameter TxPDO 2	UINT8	RO	0x09 (9 _{dec})
1801:06	Exclude TxPDOs	Specifies the TxPDOs (index of TxPDO mapping objects) that must not be transferred together with TxPDO 2	OCTET-STRING[2]	RO	00 1A
1801:07	TxPDO State	The TxPDO state is set if it was not possible to correctly read in the associated input data	BOOLEAN	RO	0x00 (0 _{dec})
1801:09	TxPDO Toggle	The TxPDO toggle is toggled with each update the corresponding input data	BOOLEAN	RO	0x00 (0 _{dec})

Index 1802 ENC TxPDO-Par Period (EL5101-0010)

Index (hex)	Name	Meaning	Data type	Flags	Default
1802:0	ENC TxPDO-Par Period	PDO Parameter TxPDO 3	UINT8	RO	0x06 (6 _{dec})
1802:06	Exclude TxPDOs	Specifies the TxPDOs (index of TxPDO mapping objects) that must not be transferred together with TxPDO 3	OCTET-STRING[2]	RO	03 1A

Index 1803 ENC TxPDO-Par Frequency (EL5101-0010)

Index (hex)	Name	Meaning	Data type	Flags	Default
1803:0	ENC TxPDO-Par Frequency	PDO Parameter TxPDO 4	UINT8	RO	0x06 (6 _{dec})
1803:06	Exclude TxPDOs	Specifies the TxPDOs (index of TxPDO mapping objects) that must not be transferred together with TxPDO 4	OCTET-STRING[2]	RO	02 1A

Index 1804 ENC TxPDO-Par Timest. (EL5101-0010)

Index (hex)	Name	Meaning	Data type	Flags	Default
1804:0	ENC TxPDO-Par Timest.	PDO Parameter TxPDO 5	UINT8	RO	0x06 (6 _{dec})
1804:06	Exclude TxPDOs	Specifies the TxPDOs (index of TxPDO mapping objects) that must not be transferred together with TxPDO 5	OCTET-STRING[2]	RO	05 1A

Index 1805 ENC TxPDO-Par Timest. compact (EL5101-0010)

Index (hex)	Name	Meaning	Data type	Flags	Default
1805:0	ENC TxPDO-Par Timest. compact	PDO Parameter TxPDO 6	UINT8	RO	0x06 (6 _{dec})
1805:06	Exclude TxPDOs	Specifies the TxPDOs (index of TxPDO mapping objects) that must not be transferred together with TxPDO 6	OCTET-STRING[2]	RO	04 1A

Index 1A00 ENC TxPDO-Map Status (EL5101-0010)

Index (hex)	Name	Meaning	Data type	Flags	Default
1A00:0	ENC TxPDO-Map Status	PDO Mapping TxPDO 1	UINT8	RO	0x11 (17 _{dec})
1A00:01	SubIndex 001	1. PDO Mapping entry (object 0x6000 (ENC Inputs), entry 0x01 (Latch C valid))	UINT32	RO	0x6000:01, 1
1A00:02	SubIndex 002	2. PDO Mapping entry (object 0x6000 (ENC Inputs), entry 0x02 (Latch extern valid))	UINT32	RO	0x6000:02, 1
1A00:03	SubIndex 003	3. PDO Mapping entry (object 0x6000 (ENC Inputs), entry 0x03 (Set counter done))	UINT32	RO	0x6000:03, 1
1A00:04	SubIndex 004	4. PDO Mapping entry (2 bits align)	UINT32	RO	0x0000:00, 2
1A00:05	SubIndex 005	5. PDO Mapping entry (object 0x6000 (ENC Inputs), entry 0x06 (Status of input status))	UINT32	RO	0x6000:06, 1
1A00:06	SubIndex 006	6. PDO Mapping entry (object 0x6000 (ENC Inputs), entry 0x07 (Open circuit))	UINT32	RO	0x6000:07, 1
1A00:07	SubIndex 007	7. PDO Mapping entry (1 bit align)	UINT32	RO	0x0000:00, 1
1A00:08	SubIndex 008	8. PDO Mapping entry (object 0x6000 (ENC Inputs), entry 0x09 (Status of input A))	UINT32	RO	0x6000:09, 1
1A00:09	SubIndex 009	9. PDO Mapping entry (object 0x6000 (ENC Inputs), entry 0x0A (Status of input B))	UINT32	RO	0x6000:0A, 1
1A00:0A	SubIndex 010	10. PDO Mapping entry (object 0x6000 (ENC Inputs), entry 0x0B (Status of input C))	UINT32	RO	0x6000:0B, 1
1A00:0B	SubIndex 011	11. PDO Mapping entry (object 0x6000 (ENC Inputs), entry 0x0C (Status of input gate))	UINT32	RO	0x6000:0C, 1
1A00:0C	SubIndex 012	12. PDO Mapping entry (object 0x6000 (ENC Inputs), entry 0x0D (Status of extern latch))	UINT32	RO	0x6000:0D, 1
1A00:0D	SubIndex 013	13. PDO Mapping entry (object 0x6000 (ENC Inputs), entry 0x0E (Sync error))	UINT32	RO	0x6000:0E, 1
1A00:0E	SubIndex 014	14. PDO Mapping entry (object 0x6000 (ENC Inputs), entry 0x0F (TxPDO State))	UINT32	RO	0x6000:0F, 1
1A00:0F	SubIndex 015	15. PDO Mapping entry (object 0x6000 (ENC Inputs), entry 0x10 (TxPDO Toggle))	UINT32	RO	0x6000:10, 1
1A00:10	SubIndex 016	16. PDO Mapping entry (object 0x6000 (ENC Inputs), entry 0x11 (Counter value))	UINT32	RO	0x6000:11, 32
1A00:11	SubIndex 017	17. PDO Mapping entry (object 0x6000 (ENC Inputs), entry 0x12 (Latch value))	UINT32	RO	0x6000:12, 32

Index 1A01 ENC TxPDO-Map Status compact (EL5101-0010)

Index (hex)	Name	Meaning	Data type	Flags	Default
1A01:0	ENC TxPDO-Map Status compact	PDO Mapping TxPDO 2	UINT8	RO	0x11 (17 _{dec})
1A01:01	SubIndex 001	1. PDO Mapping entry (object 0x6000 (ENC Inputs), entry 0x01 (Latch C valid))	UINT32	RO	0x6000:01, 1
1A01:02	SubIndex 002	2. PDO Mapping entry (object 0x6000 (ENC Inputs), entry 0x02 (Latch extern valid))	UINT32	RO	0x6000:02, 1
1A01:03	SubIndex 003	3. PDO Mapping entry (object 0x6000 (ENC Inputs), entry 0x03 (Set counter done))	UINT32	RO	0x6000:03, 1
1A01:04	SubIndex 004	4. PDO Mapping entry (2 bits align)	UINT32	RO	0x0000:00, 2
1A01:05	SubIndex 005	5. PDO Mapping entry (object 0x6000 (ENC Inputs), entry 0x06 (Status of input status))	UINT32	RO	0x6000:06, 1
1A01:06	SubIndex 006	6. PDO Mapping entry (object 0x6000 (ENC Inputs), entry 0x07 (Open circuit))	UINT32	RO	0x6000:07, 1
1A01:07	SubIndex 007	7. PDO Mapping entry (1 bit align)	UINT32	RO	0x0000:00, 1
1A01:08	SubIndex 008	8. PDO Mapping entry (object 0x6000 (ENC Inputs), entry 0x09 (Status of input A))	UINT32	RO	0x6000:09, 1
1A01:09	SubIndex 009	9. PDO Mapping entry (object 0x6000 (ENC Inputs), entry 0x0A (Status of input B))	UINT32	RO	0x6000:0A, 1
1A01:0A	SubIndex 010	10. PDO Mapping entry (object 0x6000 (ENC Inputs), entry 0x0B (Status of input C))	UINT32	RO	0x6000:0B, 1
1A01:0B	SubIndex 011	11. PDO Mapping entry (object 0x6000 (ENC Inputs), entry 0x0C (Status of input gate))	UINT32	RO	0x6000:0C, 1
1A01:0C	SubIndex 012	12. PDO Mapping entry (object 0x6000 (ENC Inputs), entry 0x0D (Status of extern latch))	UINT32	RO	0x6000:0D, 1
1A01:0D	SubIndex 013	13. PDO Mapping entry (object 0x6000 (ENC Inputs), entry 0x0E (Sync error))	UINT32	RO	0x6000:0E, 1
1A01:0E	SubIndex 014	14. PDO Mapping entry (object 0x6000 (ENC Inputs), entry 0x0F (TxPDO State))	UINT32	RO	0x6000:0F, 1
1A01:0F	SubIndex 015	15. PDO Mapping entry (object 0x6000 (ENC Inputs), entry 0x10 (TxPDO Toggle))	UINT32	RO	0x6000:10, 1
1A01:10	SubIndex 016	16. PDO Mapping entry (object 0x6000 (ENC Inputs), entry 0x11 (Counter value))	UINT32	RO	0x6000:11, 16
1A01:11	SubIndex 017	17. PDO Mapping entry (object 0x6000 (ENC Inputs), entry 0x12 (Latch value))	UINT32	RO	0x6000:12, 16

Index 1A02 ENC TxPDO-Map Period (EL5101-0010)

Index (hex)	Name	Meaning	Data type	Flags	Default
1A02:0	ENC TxPDO-Map Period	PDO Mapping TxPDO 3	UINT8	RO	0x01 (1 _{dec})
1A02:01	SubIndex 001	1. PDO Mapping entry (object 0x6000 (ENC Inputs), entry 0x14 (Period value))	UINT32	RO	0x6000:14, 32

Index 1A03 ENC TxPDO-Map Frequency (EL5101-0010)

Index (hex)	Name	Meaning	Data type	Flags	Default
1A03:0	ENC TxPDO-Map Frequency	PDO Mapping TxPDO 4	UINT8	RO	0x01 (1 _{dec})
1A03:01	SubIndex 001	1. PDO Mapping entry (object 0x6000 (ENC Inputs), entry 0x13 (Frequency value))	UINT32	RO	0x6000:13, 32

Index 1A04 ENC TxPDO-Map Timest. (EL5101-0010)

Index (hex)	Name	Meaning	Data type	Flags	Default
1A04:0	ENC TxPDO-Map Timest.	PDO Mapping TxPDO 5	UINT8	RO	0x01 (1 _{dec})
1A04:01	SubIndex 001	1. PDO Mapping entry (object 0x6000 (ENC Inputs), entry 0x16 (Timestamp))	UINT32	RO	0x6000:16, 64

Index 1A05 ENC TxPDO-Map Timest. compact (EL5101-0010)

Index (hex)	Name	Meaning	Data type	Flags	Default
1A05:0	ENC TxPDO-Map Timest. compact	PDO Mapping TxPDO 6	UINT8	RO	0x01 (1 _{dec})
1A05:01	SubIndex 001	1. PDO Mapping entry (object 0x6000 (ENC Inputs), entry 0x16 (Timestamp))	UINT32	RO	0x6000:16, 32

Index 1C00 Sync manager type

Index (hex)	Name	Meaning	Data type	Flags	Default
1C00:0	Sync manager type	Using the sync managers	UINT8	RO	0x04 (4 _{dec})
1C00:01	SubIndex 001	Sync-Manager Type Channel 1: Mailbox Write	UINT8	RO	0x01 (1 _{dec})
1C00:02	SubIndex 002	Sync-Manager Type Channel 2: Mailbox Read	UINT8	RO	0x02 (2 _{dec})
1C00:03	SubIndex 003	Sync-Manager Type Channel 3: Process Data Write (Outputs)	UINT8	RO	0x03 (3 _{dec})
1C00:04	SubIndex 004	Sync-Manager Type Channel 4: Process Data Read (Inputs)	UINT8	RO	0x04 (4 _{dec})

Index 1C12 RxPDO assign

Index (hex)	Name	Meaning	Data type	Flags	Default
1C12:0	RxPDO assign	PDO Assign Outputs	UINT8	RW	0x01 (1 _{dec})
1C12:01	SubIndex 001	1 st allocated RxPDO (contains the index of the associated RxPDO mapping object)	UINT16	RW	0x1600 (5632 _{dec})

Index 1C13 TxPDO assign

Index (hex)	Name	Meaning	Data type	Flags	Default
1C13:0	TxPDO assign	PDO Assign Inputs	UINT8	RW	0x01 (1 _{dec})
1C13:01	SubIndex 001	1 st allocated TxPDO (contains the index of the associated TxPDO mapping object)	UINT16	RW	0x1A00 (6656 _{dec})
1C13:02	SubIndex 002	2 nd allocated TxPDO (contains the index of the associated TxPDO mapping object)	UINT16	RW	0x0000 (0 _{dec})
1C13:03	SubIndex 003	3 rd allocated TxPDO (contains the index of the associated TxPDO mapping object)	UINT16	RW	0x0000 (0 _{dec})

Index 1C32 SM output parameter

Index (hex)	Name	Meaning	Data type	Flags	Default
1C32:0	SM output parameter	Synchronization parameters for the outputs	UINT8	RO	0x20 (32 _{dec})
1C32:01	Sync mode	Current synchronization mode: <ul style="list-style-type: none"> • 0: Free Run • 1: Synchron with SM 2 Event • 2: DC-Mode - Synchron with SYNC0 Event • 3: DC-Mode - Synchron with SYNC1 Event 	UINT16	RW	0x0001 (1 _{dec})
1C32:02	Cycle time	Cycle time (in ns): <ul style="list-style-type: none"> • Free Run: Cycle time of the local timer • Synchronous with SM 2 event: Master cycle time • DC-Mode: SYNC0/SYNC1 Cycle Time 	UINT32	RW	0x00000000 (0 _{dec})
1C32:03	Shift time	Time between SYNC0 event and output of the outputs (in ns, DC mode only)	UINT32	RO	0x00000000 (0 _{dec})
1C32:04	Sync modes supported	Supported synchronization modes: <ul style="list-style-type: none"> • Bit 0 = 1: free run is supported • Bit 1 = 1: Synchronous with SM 2 event is supported • Bit 2-3 = 01: DC mode is supported • Bit 4-5 = 10: Output shift with SYNC1 event (only DC mode) • Bit 14 = 1: dynamic times (measurement through writing of 0x1C32:08 [▶ 211]) 	UINT16	RO	0xC007 (49159 _{dec})
1C32:05	Minimum cycle time	Minimum cycle time (in ns)	UINT32	RO	0x00000000 (0 _{dec})
1C32:06	Calc and copy time	Minimum time between SYNC0 and SYNC1 event (in ns, DC mode only)	UINT32	RO	0x00000000 (0 _{dec})
1C32:08	Command	With this entry the real required process data provision time can be measured. <ul style="list-style-type: none"> • 0: Measurement of the local cycle time is stopped • 1: Measurement of the local cycle time is started <p>The entries 0x1C32:03 [▶ 211], 0x1C32:05 [▶ 211], 0x1C32:06 [▶ 211], 0x1C32:09 [▶ 211], 0x1C33:03 [▶ 212], 0x1C33:06 [▶ 211], and 0x1C33:09 [▶ 212] are updated with the maximum measured values. For a subsequent measurement the measured values are reset</p>	UINT16	RW	0x0000 (0 _{dec})
1C32:09	Delay time	Time between SYNC1 event and output of the outputs (in ns, DC mode only)	UINT32	RO	0x00000000 (0 _{dec})
1C32:0B	SM event missed counter	Number of missed SM events in OPERATIONAL (DC mode only)	UINT16	RO	0x0000 (0 _{dec})
1C32:0C	Cycle exceeded counter	Number of occasions the cycle time was exceeded in OPERATIONAL (cycle was not completed in time or the next cycle began too early)	UINT16	RO	0x0000 (0 _{dec})
1C32:0D	Shift too short counter	Number of occasions that the interval between SYNC0 and SYNC1 event was too short (DC mode only)	UINT16	RO	0x0000 (0 _{dec})
1C32:20	Sync error	The synchronization was not correct in the last cycle (outputs were output too late; DC mode only)	BOOLEAN	RO	0x00 (0 _{dec})

Index 1C33 SM input parameter

Index (hex)	Name	Meaning	Data type	Flags	Default
1C33:0	SM input parameter	Synchronization parameters for the inputs	UINT8	RO	0x20 (32 _{dec})
1C33:01	Sync mode	Current synchronization mode: <ul style="list-style-type: none"> 0: Free Run 1: Synchronous with SM 3 event (no outputs available) 2: DC - Synchron with SYNC0 Event 3: DC - Synchron with SYNC1 Event 34: Synchronous with SM 2 event (outputs available) 	UINT16	RW	0x0022 (34 _{dec})
1C33:02	Cycle time	as 0x1C32:02 211	UINT32	RW	0x00000000 (0 _{dec})
1C33:03	Shift time	Time between SYNC0 event and reading of the inputs (in ns, only DC mode)	UINT32	RO	0x00000000 (0 _{dec})
1C33:04	Sync modes supported	Supported synchronization modes: <ul style="list-style-type: none"> Bit 0: free run is supported Bit 1: synchronous with SM 2 event is supported (outputs available) Bit 1: synchronous with SM 3 event is supported (no outputs available) Bit 2-3 = 01: DC mode is supported Bit 4-5 = 01: input shift through local event (outputs available) Bit 4-5 = 10: input shift with SYNC1 event (no outputs available) Bit 14 = 1: dynamic times (measurement through writing of 0x1C32:08 211 or 0x1C33:08 212) 	UINT16	RO	0xC007 (49159 _{dec})
1C33:05	Minimum cycle time	as 0x1C32:05 211	UINT32	RO	0x00000000 (0 _{dec})
1C33:06	Calc and copy time	Time between reading of the inputs and availability of the inputs for the master (in ns, only DC mode)	UINT32	RO	0x00000000 (0 _{dec})
1C33:08	Command	as 0x1C32:08 211	UINT16	RW	0x0000 (0 _{dec})
1C33:09	Delay time	Time between SYNC1 event and reading of the inputs (in ns, only DC mode)	UINT32	RO	0x00000000 (0 _{dec})
1C33:0B	SM event missed counter	as 0x1C32:11 211	UINT16	RO	0x0000 (0 _{dec})
1C33:0C	Cycle exceeded counter	as 0x1C32:12 211	UINT16	RO	0x0000 (0 _{dec})
1C33:0D	Shift too short counter	as 0x1C32:13 211	UINT16	RO	0x0000 (0 _{dec})
1C33:20	Sync error	as 0x1C32:32 211	BOOLEAN	RO	0x00 (0 _{dec})

Index F000 Modular device profile

Index (hex)	Name	Meaning	Data type	Flags	Default
F000:0	Modular device profile	General information for the modular device profile	UINT8	RO	0x02 (2 _{dec})
F000:01	Module index distance	Index spacing of the objects of the individual channels	UINT16	RO	0x0010 (16 _{dec})
F000:02	Maximum number of modules	Number of channels	UINT16	RO	0x0001 (1 _{dec})

Index F008 Code word

Index (hex)	Name	Meaning	Data type	Flags	Default
F008:0	Code word	reserved	UINT32	RW	0x00000000 (0 _{dec})

Index F010 Module list

Index (hex)	Name	Meaning	Data type	Flags	Default
F010:0	Module list	Maximum subindex	UINT8	RW	0x01 (1 _{dec})
F010:01	SubIndex 001	reserved	UINT32	RW	0x000001FF (511 _{dec})

16 EL5101-0011 - Commissioning

16.1 Principles of the oversampling function

The EL5101-0011 EtherCAT Terminal is an interface for direct connection of incremental encoders with differential inputs (RS422). Through the oversampling property the terminal can read the current counter value several times per bus cycle.

Oversampling

A conventional incremental encoder interface terminal reads a counter value with each bus cycle and passes it on to the higher-level controller in the next fieldbus cycle. The EL5101-0011 reads the current counter value at several configurable and equidistant times between two fieldbus communication cycles. The transfer of a packet of x position values of 32 bits each to the higher-level controller takes place in the next fieldbus communication cycle. This procedure is referred to as oversampling.

Distributed Clocks

Oversampling requires a clock generator in the terminal that triggers the individual data sampling events. The local clock in the terminal, referred to as distributed clock, is used for this purpose.

The distributed clock represents a local clock in the EtherCAT slave controller (ESC) with the following characteristics:

- Unit 1 ns
- Zero point 1.1.2000 00:00
- Size 64 bit (sufficient for the next 584 years); however, some EtherCAT slaves only offer 32-bit support, i.e. the variable overflows after approx. 4,2 seconds
- The EtherCAT master automatically synchronizes the local clock with the master clock in the EtherCAT bus with a precision of < 100 ns.

The EL5101-0011 offers 64-bit support.

Sample Oversampling with SYNC0 and SYNC1:

The fieldbus/EtherCAT master is operated with a cycle time (T_{SYNC1}) of 1 ms to match the higher-level PLC cycle time of 1 ms, for example. This means that an EtherCAT frame is sent every 1 ms to the EL5101-0011 to collect the process data. Therefore, the local clock in the terminal triggers an interrupt every 1 ms (1 kHz) in the ESC (EtherCAT Slave Controller) that provides the process data promptly for the collecting EtherCAT frame. This first interrupt is called SYNC1.

The EL5101-0011 is set in the TwinCAT System Manager to an oversampling factor $n = 100$. This causes the ESC to generate a second interrupt in the terminal with an n -times higher frequency (F_{SYNC0}), in this case 100 kHz or 10 μs period (T_{SYNC0}). This interrupt is called SYNC0. The counter value is read on each SYNC0 signal; the values are stored in succession in a buffer. Generation of the SYNC0 pulse from the local synchronized clock within the distributed clock network ensures that the position values are sampled at highly equidistant intervals with the period of the SYNC1 pulse.

● **Maximum sampling frequency / minimum cycle time**

I A sampling time shorter than (T_{SYNC0}) 10 μs is not permissible for the EL5101-0011! The maximum sample frequency (F_{SYNC0}) for the EL5101-0011 is thus 100 kSps (samples per second).

The cycle time (T_{SYNC1}) may not be shorter than the minimum cycle time of 500 μs with an oversampling factor of $n = 50$.

Regarding the calculation of SYNC0 from the SYNC1 pulse based on manual specification of an oversampling factor, please note that for T_{SYNC0} only integer values are calculated at nanosecond intervals.

Sample: 187,500 ns are permissible, 333,333.3333 ns are not.

Sample permissible and impermissible oversampling factors:

For $T_{\text{SYNC1}} = 1 \text{ ms}$ oversampling factors such as 1, 2, 5 or 100 are permitted, but not 3! If implausible values are used the terminal will reach the OP state but will not supply any process data.

This may result in a working counter error.

The 32-bit measured values accumulated in the buffer are sent as a packet to the higher-level control system.

Summary:

Symbol	Description	Permissible values	Example (OK)	Example (NOK)
F_{Sync1}	Frequency of the fieldbus/EtherCAT master		$F_{\text{Sync1}} = 1 \text{ kHz}$	$F_{\text{Sync1}} = 1 \text{ kHz}$
T_{Sync1}	Cycle time of the fieldbus/EtherCAT master	$T_{\text{Sync1}} \geq 500 \mu\text{s}$ at $n = 50$	$T_{\text{Sync1}} = 1 \text{ ms}$	$T_{\text{Sync1}} = 1 \text{ ms}$
n	Oversampling factor	$n = 0 \dots 100$	$n = 100$	$n = 3$
F_{Sync0}	Sampling frequency ($F_{\text{Sync0}} = F_{\text{Sync1}} * n$)	$F_{\text{Sync0}} \leq 100 \text{ kSps}$ (Samples per second)	$F_{\text{Sync0}} = 100 \text{ kHz}$	$F_{\text{Sync0}} = 3 \text{ kHz}$
T_{Sync0}	Sampling time	$T_{\text{Sync0}} \geq 10 \mu\text{s}$ only integer values are calculated at nanosecond intervals!	$T_{\text{Sync0}} = 10 \mu\text{s}$	$T_{\text{Sync0}} =$ 333,333.333 ns

Time-related cooperation with other terminals

The reading of the measured values in the EL5101-0011 is triggered by an interrupt generated by the local clock in the terminal. All local clocks in the supporting EtherCAT slaves are synchronized. This enables EtherCAT slaves (here: terminals) to sample measured values simultaneously (simultaneous interrupt generation), independent of the distance between them. This simultaneity is within the distributed clock precision range of $< 100 \text{ ns}$.

Sample for Coordination of two EL5101-0011 terminals with each other:

The EtherCAT master, e.g. Beckhoff TwinCAT, configures both EL5101-0011 terminals such that their SYNC1 pulses occur at the same time.

Assumption: The EtherCAT bus cycle time is $500 \mu\text{s}$. The SYNC1 is thus triggered in all EL5101-0011 terminals every $500 \mu\text{s}$.

- If both terminals operate with a corresponding oversampling factor (e.g. $n = 20$), the SYNC0 pulse correlating to SYNC1 will occur simultaneously in all EL5101-0011, in this sample $T_{\text{SYNC0}} = 25 \mu\text{s}$.
- If different oversampling factors are used in the EL5101-0011 terminals employed, their SYNC0 pulses no longer occur simultaneously. The higher-level SYNC1 pulse is retained.

Timestamp of the process data

The EL5101-0011 offers a "timestamp" for each process data block. This process data is already activated as *StartTimeNextLatch* through the activation of 0x1A01 *ENC NextSync1Time* as a 64-bit value in default on the Process data tab (see chapter [Process data](#) [▶ 216]).

The data block consisting of sample value + timestamp, which is transferred in each cycle, is not related. The relationship is shown in the figure below.

To explain in more detail:

- The sample is based on an oversampling factor $n = 100$.
- The SYNC0 signal in the terminal fills the internal buffer with 100 position values.
- SYNC1, which triggers the filled buffer to be made available as process data and at the same time fetches the *StartTimeNextLatch* from the local distributed clock, runs synchronous with the cycle time.
- The data array is thereby assembled together with the next SYNC1 Time.
- The next EtherCAT cycle fetches this data.

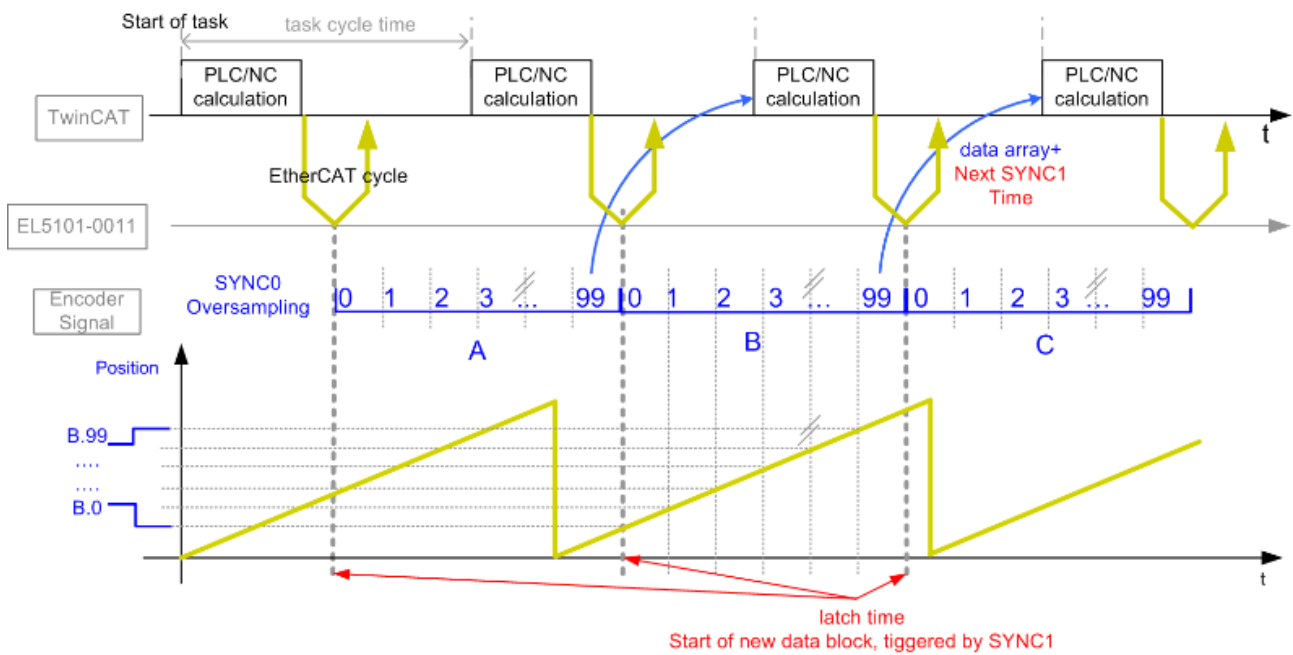

Fig. 176: Temporal relationship between SYNC signals and SyncManager interrupt

16.2 Process data and configuration

The principles for the oversampling function and the mode of operation of the EL5101-0011 with the use of the SYNC0 and SYNC1 pulses are explained in the section "[Principles of the oversampling function \[► 213\]](#)". The setting of the various parameters using the Beckhoff TwinCAT System Manager is described in the following chapter. The EL5101-0011 offers the following process data:

The screenshot displays the Beckhoff TwinCAT System Manager interface for configuring the EL5101-0011 process data. The interface is divided into several panes:

- Solution Explorer (Left):** Shows the project structure for Term 2 (EL5101-0011) and Term 3 (EL9011). The EL5101-0011 folder is expanded, showing sub-folders like ENC Status, ENC NextSync1Time, ENC TxPdo, and ENC Control.
- Sync Manager (Top Left):** A table showing the configuration for the Sync Manager.

SM	Size	Type	Flags
0	128	MbxOut	
1	128	MbxIn	
2	6	Outputs	
3	14	Inputs	
- PDO List (Top Right):** A table showing the configuration for the PDO List.

Index	Size	Name	Flags	SM	SU
0x1A00	2.0	ENC Status	F	3	0
0x1A01	8.0	ENC NextSync1Time	F	3	0
0x1A10	4.0	ENC TxPdo 1 Samples Counter value	F	3	0
0x1A11	8.0	ENC TxPdo 2 Samples Counter value	F	0	0
0x1A12	16.0	ENC TxPdo 4 Samples Counter value	F	0	0
0x1A13	20.0	ENC TxPdo 5 Samples Counter value	F	0	0
0x1A14	32.0	ENC TxPdo 8 Samples Counter value	F	0	0
0x1A15	40.0	ENC TxPdo 10 Samples Counter value	F	0	0
0x1A16	64.0	ENC TxPdo 16 Samples Counter value	F	0	0
0x1A17	80.0	ENC TxPdo 20 Samples Counter value	F	0	0
0x1A18	100.0	ENC TxPdo 25 Samples Counter value	F	0	0
0x1A19	128.0	ENC TxPdo 32 Samples Counter value	F	0	0
0x1A1A	160.0	ENC TxPdo 40 Samples Counter value	F	0	0
0x1A1B	200.0	ENC TxPdo 50 Samples Counter value	F	0	0
0x1A1C	256.0	ENC TxPdo 64 Samples Counter value	F	0	0
0x1A1D	320.0	ENC TxPdo 80 Samples Counter value	F	0	0
0x1A1E	400.0	ENC TxPdo 100 Samples Counter value	F	0	0
0x1600	6.0	ENC Control	F	2	0
- PDO Assignment (0x1C13) (Bottom Left):** A list of PDOs with checkboxes for assignment.

Index	Type
0x1A00	BIT
0x1A01	BIT
0x1A10	BIT
0x1A11	excluded by 0x1A10
0x1A12	excluded by 0x1A10
0x1A13	excluded by 0x1A10
0x1A14	excluded by 0x1A10
0x1A15	excluded by 0x1A10
0x1A16	excluded by 0x1A10
0x1A17	excluded by 0x1A10
0x1A18	excluded by 0x1A10
0x1A19	excluded by 0x1A10
0x1A1A	excluded by 0x1A10
0x1A1B	excluded by 0x1A10
0x1A1C	excluded by 0x1A10
0x1A1D	excluded by 0x1A10
0x1A1E	excluded by 0x1A10
- PDO Content (0x1A00) (Bottom Right):** A table showing the content of the PDOs.

Index	Size	Offs	Name	Type
---	0.2	0.0	---	---
0x6000:03	0.1	0.2	Status__Set counter done	BIT
---	0.3	0.3	---	---
0x6000:07	0.1	0.6	Status__Open circuit	BIT
---	0.1	0.7	---	---
0x6000:09	0.1	1.0	Status__Status of input A	BIT
0x6000:0A	0.1	1.1	Status__Status of input B	BIT
0x6000:0B	0.1	1.2	Status__Status of input C	BIT
---	0.2	1.3	---	---
0x6000:0E	0.1	1.5	Status__Sync error	BIT
0x6000:0F	0.1	1.6	Status__TxPDO State	BIT
0x6000:10	0.1	1.7	Status__TxPDO Toggle	BIT
---	2.0	---	---	---

EL5101-0011 - Process data (default)

Oversampling settings, distributed clocks (DC)

The oversampling factor can be set on the "DC" tab (see figure below). The oversampling factor n is set to 1 in the delivery condition. When an entry is selected in the dialog, the correct sampling ratio at distributed clock level and the correct number of process data to be transferred are set automatically.

● Sampling frequency

i If an oversampling factor is required that does not appear in the list, the user has to specify the ratio between the SYNC0 pulse and the SYNC1 pulse within the permitted limits, based on the information found in "[Principles of the oversampling function \[► 213\]](#)". Please refer to the note "[Maximum sampling frequency / minimum cycle time \[► 213\]](#)".

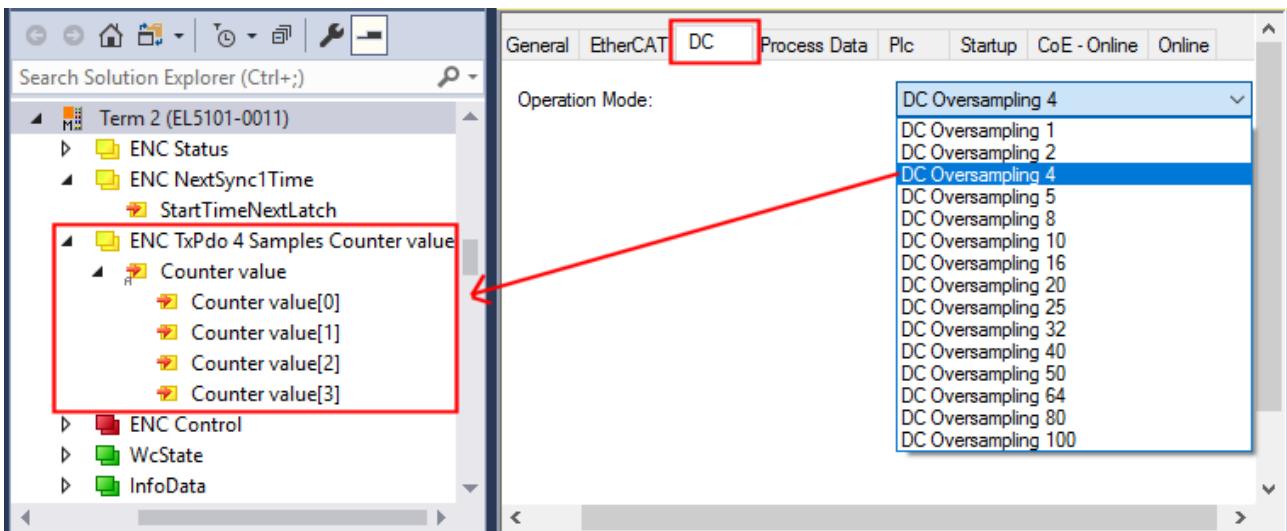

Fig. 177: Setting of the oversampling factor n = 4 and display of the process data to be transferred

The following sampling times / sampling frequencies apply to EL5101-0011:

	Sampling Time T_{SYNCO}	Cycle time T_{SYNCl}				
		500 μ s	1,000 μ s	2,000 μ s	5,000 μ s	10,000 μ s
Oversampling factor	1	500.00 μ s	1,000.00 μ s	2,000.00 μ s	5,000.00 μ s	10,000.00 μ s
	2	250.00 μ s	500.00 μ s	1,000.00 μ s	2,500.00 μ s	5,000.00 μ s
	4	125.00 μ s	250.00 μ s	500.00 μ s	1,250.00 μ s	2,500.00 μ s
	5	100.00 μ s	200.00 μ s	400.00 μ s	1,000.00 μ s	2,000.00 μ s
	8	62.50 μ s	125.00 μ s	250.00 μ s	625.00 μ s	1,250.00 μ s
	10	50.00 μ s	100.00 μ s	200.00 μ s	500.00 μ s	1,000.00 μ s
	16	31.25 μ s	62.50 μ s	125.00 μ s	312.50 μ s	625.00 μ s
	20	25.00 μ s	50.00 μ s	100.00 μ s	250.00 μ s	500.00 μ s
	25	20.00 μ s	40.00 μ s	80.00 μ s	200.00 μ s	400.00 μ s
	32	15.63 μ s	31.25 μ s	62.50 μ s	156.25 μ s	312.50 μ s
	40	12.50 μ s	25.00 μ s	50.00 μ s	125.00 μ s	250.00 μ s
	50	10.00 μ s	20.00 μ s	40.00 μ s	100.00 μ s	200.00 μ s
	64	not permissible, because $T_{SYNCO} < 10 \mu$ s	15.63 μ s	31.25 μ s	78.125 μ s	156.25 μ s
	80		12.50 μ s	25.00 μ s	62.50 μ s	125.00 μ s
	100		10.00 μ s	20.00 μ s	50.00 μ s	100.00 μ s

	Sampling frequency F_{SYNCO}	Cycle time T_{SYNCl}				
		500 μ s	1,000 μ s	2,000 μ s	5,000 μ s	10,000 μ s
Oversampling factor	1	2.0 kSps	1.0 kSps	0.5 kSps	0.2 kSps	0.1 kSps
	2	4.0 kSps	2.0 kSps	1.0 kSps	0.4 kSps	0.2 kSps
	4	8.0 kSps	4.0 kSps	2.0 kSps	0.8 kSps	0.4 kSps
	5	10.0 kSps	5.0 kSps	2.5 kSps	1.0 kSps	0.5 kSps
	8	16.0 kSps	8.0 kSps	4.0 kSps	1.6 kSps	0.8 kSps
	10	20.0 kSps	10.0 kSps	5.0 kSps	2.0 kSps	1.0 kSps
	16	32.0 kSps	16.0 kSps	8.0 kSps	3.2 kSps	1.6 kSps
	20	40.0 kSps	20.0 kSps	10.0 kSps	4.0 kSps	2.0 kSps
	25	50.0 kSps	25.0 kSps	12.5 kSps	5.0 kSps	2.5 kSps
	32	64.0 kSps	32.0 kSps	16.0 kSps	6.4 kSps	3.2 kSps
	40	80.0 kSps	40.0 kSps	20.0 kSps	8.0 kSps	4.0 kSps
	50	100.0 kSps	50.0 kSps	25.0 kSps	10.0 kSps	5.0 kSps
	64	not permissible, because $F_{SYNCO} > 100$ kSps	64.0 kSps	32.0 kSps	12.8 kSps	6.4 kSps
	80		80.0 kSps	40.0 kSps	16.0 kSps	8.0 kSps
	100		100.0 kSps	50.0 kSps	20.0 kSps	10.0 kSps

"StartTimeNextLatch"

The process data "StartTimeNextLatch" (index 1A01) is activated by default.

The "StartTimeNextLatch" process data is 32 bits wide. During each process data cycle the time is specified at which the next SYNC1 pulse and therefore the next block of sample values begins. "StartTimeNextLatch" thus changes in each cycle by the amount of that task cycle time with which this terminal is operated. This time specification is based on the terminal's local Distributed Clocks time. The EL5101-0011 maps only the 64-bit distributed clocks time.

In this way all samples can be synchronized with other time data within the EtherCAT bus based on the known oversampling factor.

Sample:

The EL5101-0011 supplies in the regarded cycle with
cycle time = 1 ms (= 1,000,000 ns) and
oversampling factor $n = 20$,

a "StartTimeNextLatch" of 503,330,625,067,077,000_{dec} and 20 measured values (counter value) of 32 bits each as process data.

The time of measurement of the 5th supplied position value is now to be determined, i.e. the Distributed Clocks time at which the 5th position value was determined.

The currently delivered set of 20 counter values was started at the time:

$503,330,625,067,077,000 - 1,000,000$ (cycle time) = 503,330,625,066,077,000 ns.

The time interval between the samples is $1.000.000/20 = 50.000$ ns.

The 5th position value was thus determined at the time:

$503,330,625,066,077,000 + ((5 - 1) * 50,000) = 503,330,625,066,027,000$ ns

Special oversampling factor and Shift Time for the SYNC0 pulse**NOTICE****CAUTION! Risk of device damage!**

If these settings are changed in the System Manager, no plausibility checks are carried out on the software side.

Correct function of the terminal with all conceivable setting options cannot be guaranteed.

Setting the counter value - referencing:

Since incremental encoders do not deliver an unambiguous position value after switching on, a homing must be carried out.

The EL5101-0011 offers the option to set the reference point manually via "Set counter" (index 0x7000:03).

"Set counter" (index 0x7000:03)

- The value to be set as reference value (default: 0) is written in "Set counter value" (index 0x7000:11).
- The function is activated by setting the bit in "Set counter" (index 0x7000:03) to TRUE.
- The value from "Set counter value" (index 0x7000:11) is written in "counter value" (index 0x6000:11).
- The value of the bit in "Set counter done" (index 0x6000:03) is set to TRUE.
- After re-activation of "Set counter" (Index 0x7000:03), the next reference value can be written in "counter value" (Index 0x6000:11) only if the value of the "Set counter done" bit (index 0x6000:03) is FALSE.

Open circuit detection

- A separate open circuit detection can be activated for each of the channels A, B and C (index 0x8000:0B, 0x8000:0C, 0x8000:0D).
- The open circuit detection for channels A and B is activated by default.
- A differential voltage of $-0.475\text{ V} > V_{id} > +0.475\text{ V}$ (typical, subject to change) is detected as an open circuit.
- If an open circuit is detected, it is indicated as process data "Open circuit" = TRUE. The bit in object 0x6000:07 is set. An open circuit is indicated separately in indices 0xA000:01 (track A), 0xA000:02 (track B) and 0xA000:03 (track C).
- "TxPDO state" also becomes TRUE if an open circuit is detected, since invalid data have to be assumed.

Further cyclic information

Furthermore, the EL5101-0011 offers the following cyclic information:

Variable	Meaning
Sync error	In DC mode: indicates whether a synchronization error occurred in the expired cycle. This means a SYNC signal was triggered in the terminal, although no new process data were available (0=OK, 1=NOK).
TxPDO State	Indicates whether an error has occurred (= TRUE). TxPDO State is set to TRUE if internal errors are detected or an open circuit is signaled, since invalid data must be assumed.
DcOutputShift, DcInputShift	In these static variables the System Manager announces the shift time to which this terminal has been set. The value is set once on activating/calculating the configuration and also depends on the customer-specific settings in the extended slave settings. It can be linked to offset calculations in the PLC.
StartTimeNextLatch	See chapter " StartTimeNextLatch [► 218] "

16.3 Object description and parameterization - enhanced operation mode

EtherCAT XML Device Description

The display matches that of the CoE objects from the EtherCAT XML Device Description. We recommend downloading the latest XML file from the download area of the Beckhoff website and installing it according to installation instructions.

NOTICE



Parameterization via the CoE list (CAN over EtherCAT)

The EtherCAT device is parameterized via the CoE - Online tab (with a double click on the respective object) or via the Process Data tab (assignment of PDOs). A detailed description can be found in the EtherCAT System-Documentation in chapter "[EtherCAT subscriber configuration](#)"

Please note the general CoE notes in the EtherCAT System Documentation in chapter "[CoE-interface](#)" when using/manipulating the CoE parameters:

- Keep a startup list if components have to be replaced
- Differentiation between online/offline dictionary,
- existence of current XML description
- use "CoE reload" for resetting changes

16.3.1 Restore object

Index 1011 Restore default parameters

Index (hex)	Name	Meaning	Data type	Flags	Default
1011:0	Restore default parameters [▶ 273]	Restore default parameters	UINT8	RO	0x01 (1 _{dec})
1011:01	SubIndex 001	If this object is set to "0x64616F6C" in the set value dialog, all backup objects are reset to their delivery state.	UINT32	RW	0x00000000 (0 _{dec})

16.3.2 Configuration data

Index 8000 ENC Settings

Index (hex)	Name	Meaning	Data type	Flags	Default
8000:0	ENC Settings	Maximum subindex	UINT8	RO	0x0E (14 _{dec})
8000:01	Enable C reset	The counter is reset via the C input.	BOOLEAN	RW	0x00 (0 _{dec})
8000:0B	Open circuit detection A	An open circuit on track A is indicated in index 0x6000:07 and as process data. Diagnosis is only possible if the corresponding input is wired differentially. A differential voltage $-0.475\text{ V} > \text{Vid} > +0.475\text{ V}$ (typical, subject to change) is detected as a broken wire.	BOOLEAN	RW	0x01 (1 _{dec})
8000:0C	Open circuit detection B	An open circuit on track B is indicated in index 0x6000:07 and as process data. Diagnosis is only possible if the corresponding input is wired differentially. A differential voltage $-0.475\text{ V} > \text{Vid} > +0.475\text{ V}$ (typical, subject to change) is detected as a broken wire.	BOOLEAN	RW	0x01 (1 _{dec})
8000:0D	Open circuit detection C	An open circuit on track C is indicated in index 0x6000:07 and as process data. Diagnosis is only possible if the corresponding input is wired differentially. A differential voltage $-0.475\text{ V} > \text{Vid} > +0.475\text{ V}$ (typical, subject to change) is detected as a broken wire.	BOOLEAN	RW	0x00 (0 _{dec})
8000:0E	Reversion of rotation	Activates reversion of rotation	BOOLEAN	RW	0x00 (0 _{dec})

16.3.3 Input data

Index 6000 ENC Inputs

Index (hex)	Name	Meaning	Data type	Flags	Default
6000:0	ENC Inputs	Maximum subindex	UINT8	RO	0x19 (25 _{dec})
6000:03	Set counter done	The counter was set.	BOOLEAN	RO	0x00 (0 _{dec})
6000:07	Open circuit	Indicates an open circuit. Configuration via index 0x8000:0A, 0x8000:0B, 0x8000:0C	BOOLEAN	RO	0x00 (0 _{dec})
6000:09	Status of input A	Status of input A	BOOLEAN	RO	0x00 (0 _{dec})
6000:0A	Status of input B	Status of input B	BOOLEAN	RO	0x00 (0 _{dec})
6000:0B	Status of input C	Status of input C	BOOLEAN	RO	0x00 (0 _{dec})
6000:0E	Sync Error	The Sync error bit is only required for DC mode. It indicates whether a synchronization error has occurred during the previous cycle. This means a SYNC signal was triggered in the terminal, although no new process data were available (0=OK, 1=NOK).	BOOLEAN	RO	0x00 (0 _{dec})
6000:0F	TxPDO State	Validity of the data of the associated TxPDO (0 = valid, 1 = invalid).	BOOLEAN	RO	0x00 (0 _{dec})
6000:10	TxPDO Toggle	The TxPDO toggle is toggled by the slave when the data of the associated TxPDO is updated.	BOOLEAN	RO	0x00 (0 _{dec})
6000:11	Counter value	Counter value	UINT32	RO	0x00000000 (0 _{dec})
6000:19	StartTimeNextLatch		UINT64	RO	

16.3.4 Output data

Index 7000 ENC Outputs

Index (hex)	Name	Meaning	Data type	Flags	Default
7000:0	ENC Outputs	Maximum subindex	UINT8	RO	0x11 (17 _{dec})
7000:03	Set counter	Set counter	BOOLEAN	RO	0x00 (0 _{dec})
7000:11	Set counter value	The counter value to be set via "Set counter" (index 0x7000:03).	UINT32	RO	0x00000000 (0 _{dec})

16.3.5 Information / diagnostic data (channel specific)

Index A000 ENC Diag data

Index (hex)	Name	Meaning	Data type	Flags	Default
A000:0	ENC Diag data	Maximum subindex	UINT8	RO	0x04 (4 _{dec})
A000:01	Open circuit A	Open circuit on track A	BOOLEAN	RO	0x00 (0 _{dec})
A000:02	Open circuit B	Open circuit on track B	BOOLEAN	RO	0x00 (0 _{dec})
A000:03	Open circuit C	Open circuit on track C	BOOLEAN	RO	0x00 (0 _{dec})
A000:04	Field power failure	Field bus voltage error	BOOLEAN	RO	0x00 (0 _{dec})

16.3.6 Standard objects

The standard objects have the same meaning for all EtherCAT slaves.

Index 1000 Device type

Index (hex)	Name	Meaning	Data type	Flags	Default
1000:0	Device type	Device type of the EtherCAT slave: the Lo-Word contains the CoE profile used (5001). The Hi-Word contains the module profile according to the modular device profile.	UINT32	RO	0x00001389 (5001 _{dec})

Index 1008 Device name

Index (hex)	Name	Meaning	Data type	Flags	Default
1008:0	Device name	Device name of the EtherCAT slave	STRING	RO	EL5101-0011

Index 1009 Hardware version

Index (hex)	Name	Meaning	Data type	Flags	Default
1009:0	Hardware version	Hardware version of the EtherCAT slave	STRING	RO	-

Index 100A Software version

Index (hex)	Name	Meaning	Data type	Flags	Default
100A:0	Software version	Firmware version of the EtherCAT slave	STRING	RO	-

Index 1018 Identity

Index (hex)	Name	Meaning	Data type	Flags	Default
1018:0	Identity	Information for identifying the slave	UINT8	RO	0x04 (4 _{dec})
1018:01	Vendor ID	Vendor ID of the EtherCAT slave	UINT32	RO	0x00000002 (2 _{dec})
1018:02	Product code	Product code of the EtherCAT slave	UINT32	RO	0x13ED3052 (334311506 _{dec})
1018:03	Revision	Revision number of the EtherCAT slave; the low word (bit 0-15) indicates the special terminal number, the high word (bit 16-31) refers to the device description	UINT32	RO	0x00000000 (0 _{dec})
1018:04	Serial number	Serial number of the EtherCAT slave; the low byte (bit 0-7) of the low word contains the year of production, the high byte (bit 8-15) of the low word contains the week of production, the high word (bit 16-31) is 0	UINT32	RO	0x00000000 (0 _{dec})

Index 10F0 Backup parameter handling

Index (hex)	Name	Meaning	Data type	Flags	Default
10F0:0	Backup parameter handling	Information for standardized loading and saving of backup entries	UINT8	RO	0x01 (1 _{dec})
10F0:01	Checksum	Checksum across all backup entries of the EtherCAT slave	UINT32	RO	0x00000000 (0 _{dec})

Index 1600 ENC RxPDO-Map Control

Index (hex)	Name	Meaning	Data type	Flags	Default
1600:0	ENC RxPDO-Map Control	PDO Mapping RxPDO 1	UINT8	RO	0x04 (4 _{dec})
1600:01	SubIndex 001	1. PDO Mapping entry (2 bits align)	UINT32	RO	0x0000:00, 2
1600:02	SubIndex 002	2. PDO Mapping entry (object 0x7000 (ENC Outputs), entry 0x03 (Set counter))	UINT32	RO	0x7000:03, 1
1600:03	SubIndex 003	3. PDO Mapping entry (13 bits align)	UINT32	RO	0x0000:00, 13
1600:04	SubIndex 004	4. PDO Mapping entry (object 0x7000 (ENC Outputs), entry 0x11 (Set counter value))	UINT32	RO	0x7000:11, 32

Index 1810 ENC TxPDO-Par TxPdo 1 Samples Counter value

Index (hex)	Name	Meaning	Data type	Flags	Default
1810:0	ENC TxPDO-Par TxPdo 1 Samples Counter value	PDO Parameter TxPDO 17	UINT8	RO	0x06 (6 _{dec})
1810:06	Exclude TxPDOs	Specifies the TxPDOs (index of TxPDO mapping objects) that must be transferred together with TxPDO 17.	OCTET-STRING[28]	RO	11 1A 12 1A 13 1A 14 1A 15 1A 16 1A 17 1A 18 1A 19 1A 1A 1A 1B 1A 1C 1A 1D 1A 1E 1A

Index 1811 ENC TxPDO-Par TxPdo 2 Samples Counter value

Index (hex)	Name	Meaning	Data type	Flags	Default
1811:0	ENC TxPDO-Par TxPdo 2 Samples Counter value	PDO Parameter TxPDO 18	UINT8	RO	0x06 (6 _{dec})
1811:06	Exclude TxPDOs	Specifies the TxPDOs (index of TxPDO mapping objects) that must not be transferred together with TxPDO 18.	OCTET-STRING[28]	RO	10 1A 12 1A 13 1A 14 1A 15 1A 16 1A 17 1A 18 1A 19 1A 1A 1A 1B 1A 1C 1A 1D 1A 1E 1A

Index 1812 ENC TxPDO-Par TxPdo 4 Samples Counter value

Index (hex)	Name	Meaning	Data type	Flags	Default
1812:0	ENC TxPDO-Par TxPdo 4 Samples Counter value	PDO Parameter TxPDO 19	UINT8	RO	0x06 (6 _{dec})
1812:06	Exclude TxPDOs	Specifies the TxPDOs (index of TxPDO mapping objects) that must not be transferred together with TxPDO 19.	OCTET-STRING[28]	RO	10 1A 11 1A 13 1A 14 1A 15 1A 16 1A 17 1A 18 1A 19 1A 1A 1A 1B 1A 1C 1A 1D 1A 1E 1A

Index 1813 ENC TxPDO-Par TxPdo 5 Samples Counter value

Index (hex)	Name	Meaning	Data type	Flags	Default
1813:0	ENC TxPDO-Par TxPdo 5 Samples Counter value	PDO Parameter TxPDO 20	UINT8	RO	0x06 (6 _{dec})
1813:06	Exclude TxPDOs	Specifies the TxPDOs (index of TxPDO mapping objects) that must not be transferred together with TxPDO 20.	OCTET-STRING[28]	RO	10 1A 11 1A 12 1A 14 1A 15 1A 16 1A 17 1A 18 1A 19 1A 1A 1A 1B 1A 1C 1A 1D 1A 1E 1A

Index 1814 ENC TxPDO-Par TxPdo 8 Samples Counter value

Index (hex)	Name	Meaning	Data type	Flags	Default
1814:0	ENC TxPDO-Par TxPdo 8 Samples Counter value	PDO Parameter TxPDO 21	UINT8	RO	0x06 (6 _{dec})
1814:06	Exclude TxPDOs	Specifies the TxPDOs (index of TxPDO mapping objects) that must not be transferred together with TxPDO 21.	OCTET-STRING[28]	RO	10 1A 11 1A 12 1A 13 1A 15 1A 16 1A 17 1A 18 1A 19 1A 1A 1A 1B 1A 1C 1A 1D 1A 1E 1A

Index 1815 ENC TxPDO-Par TxPdo 10 Samples Counter value

Index (hex)	Name	Meaning	Data type	Flags	Default
1815:0	ENC TxPDO-Par TxPdo 10 Samples Counter value	PDO Parameter TxPDO 22	UINT8	RO	0x06 (6 _{dec})
1815:06	Exclude TxPDOs	Specifies the TxPDOs (index of TxPDO mapping objects) that must not be transferred together with TxPDO 22.	OCTET-STRING[28]	RO	10 1A 11 1A 12 1A 13 1A 14 1A 16 1A 17 1A 18 1A 19 1A 1A 1A 1B 1A 1C 1A 1D 1A 1E 1A

Index 1816 ENC TxPDO-Par TxPdo 16 Samples Counter value

Index (hex)	Name	Meaning	Data type	Flags	Default
1816:0	ENC TxPDO-Par TxPdo 16 Samples Counter value	PDO Parameter TxPDO 23	UINT8	RO	0x06 (6 _{dec})
1816:06	Exclude TxPDOs	Specifies the TxPDOs (index of TxPDO mapping objects) that must not be transferred together with TxPDO 23.	OCTET-STRING[28]	RO	10 1A 11 1A 12 1A 13 1A 14 1A 15 1A 17 1A 18 1A 19 1A 1A 1A 1B 1A 1C 1A 1D 1A 1E 1A

Index 1817 ENC TxPDO-Par TxPdo 20 Samples Counter value

Index (hex)	Name	Meaning	Data type	Flags	Default
1817:0	ENC TxPDO-Par TxPdo 20 Samples Counter value	PDO Parameter TxPDO 24	UINT8	RO	0x06 (6 _{dec})
1817:06	Exclude TxPDOs	Specifies the TxPDOs (index of TxPDO mapping objects) that must not be transferred together with TxPDO 24.	OCTET-STRING[28]	RO	10 1A 11 1A 12 1A 13 1A 14 1A 15 1A 16 1A 18 1A 19 1A 1A 1A 1B 1A 1C 1A 1D 1A 1E 1A

Index 1818 ENC TxPDO-Par TxPdo 25 Samples Counter value

Index (hex)	Name	Meaning	Data type	Flags	Default
1818:0	ENC TxPDO-Par TxPdo 25 Samples Counter value	PDO Parameter TxPDO 25	UINT8	RO	0x06 (6 _{dec})
1818:06	Exclude TxPDOs	Specifies the TxPDOs (index of TxPDO mapping objects) that must not be transferred together with TxPDO 25.	OCTET-STRING[28]	RO	10 1A 11 1A 12 1A 13 1A 14 1A 15 1A 16 1A 17 1A 19 1A 1A 1A 1B 1A 1C 1A 1D 1A 1E 1A

Index 1819 ENC TxPDO-Par TxPdo 32 Samples Counter value

Index (hex)	Name	Meaning	Data type	Flags	Default
1819:0	ENC TxPDO-Par TxPdo 32 Samples Counter value	PDO Parameter TxPDO 26	UINT8	RO	0x06 (6 _{dec})
1819:06	Exclude TxPDOs	Specifies the TxPDOs (index of TxPDO mapping objects) that must not be transferred together with TxPDO 26.	OCTET-STRING[28]	RO	10 1A 11 1A 12 1A 13 1A 14 1A 15 1A 16 1A 17 1A 18 1A 1A 1A 1B 1A 1C 1A 1D 1A 1E 1A

Index 181A ENC TxPDO-Par TxPdo 40 Samples Counter value

Index (hex)	Name	Meaning	Data type	Flags	Default
181A:0	ENC TxPDO-Par TxPdo 40 Samples Counter value	PDO Parameter TxPDO 27	UINT8	RO	0x06 (6 _{dec})
181A:06	Exclude TxPDOs	Specifies the TxPDOs (index of TxPDO mapping objects) that must not be transferred together with TxPDO 27.	OCTET-STRING[28]	RO	10 1A 11 1A 12 1A 13 1A 14 1A 15 1A 16 1A 17 1A 18 1A 19 1A 1B 1A 1C 1A 1D 1A 1E 1A

Index 181B ENC TxPDO-Par TxPdo 50 Samples Counter value

Index (hex)	Name	Meaning	Data type	Flags	Default
181B:0	ENC TxPDO-Par TxPdo 50 Samples Counter value	PDO Parameter TxPDO 28	UINT8	RO	0x06 (6 _{dec})
181B:06	Exclude TxPDOs	Specifies the TxPDOs (index of TxPDO mapping objects) that must not be transferred together with TxPDO 28.	OCTET-STRING[28]	RO	10 1A 11 1A 12 1A 13 1A 14 1A 15 1A 16 1A 17 1A 18 1A 19 1A 1A 1A 1C 1A 1D 1A 1E 1A

Index 181C ENC TxPDO-Par TxPdo 64 Samples Counter value

Index (hex)	Name	Meaning	Data type	Flags	Default
181C:0	ENC TxPDO-Par TxPdo 64 Samples Counter value	PDO Parameter TxPDO 29	UINT8	RO	0x06 (6 _{dec})
181C:06	Exclude TxPDOs	Specifies the TxPDOs (index of TxPDO mapping objects) that must not be transferred together with TxPDO 29.	OCTET-STRING[28]	RO	10 1A 11 1A 12 1A 13 1A 14 1A 15 1A 16 1A 17 1A 18 1A 19 1A 1A 1A 1B 1A 1D 1A 1E 1A

Index 181D ENC TxPDO-Par TxPdo 80 Samples Counter value

Index (hex)	Name	Meaning	Data type	Flags	Default
181D:0	ENC TxPDO-Par TxPdo 80 Samples Counter value	PDO Parameter TxPDO 30	UINT8	RO	0x06 (6 _{dec})
181D:06	Exclude TxPDOs	Specifies the TxPDOs (index of TxPDO mapping objects) that must not be transferred together with TxPDO 30.	OCTET-STRING[28]	RO	10 1A 11 1A 12 1A 13 1A 14 1A 15 1A 16 1A 17 1A 18 1A 19 1A 1A 1A 1B 1A 1C 1A 1E 1A

Index 181E ENC TxPDO-Par TxPdo 100 Samples Counter value

Index (hex)	Name	Meaning	Data type	Flags	Default
181E:0	ENC TxPDO-Par TxPdo 100 Samples Counter value	PDO Parameter TxPDO 31	UINT8	RO	0x06 (6 _{dec})
181E:06	Exclude TxPDOs	Specifies the TxPDOs (index of TxPDO mapping objects) that must not be transferred together with TxPDO 31.	OCTET-STRING[28]	RO	10 1A 11 1A 12 1A 13 1A 14 1A 15 1A 16 1A 17 1A 18 1A 19 1A 1A 1A 1B 1A 1C 1A 1D 1A

Index 1A00 ENC TxPDO-Map Status

Index (hex)	Name	Meaning	Data type	Flags	Default
1A00:0	ENC TxPDO-Map Status	PDO Mapping TxPDO 1	UINT8	RO	0x0C (12 _{dec})
1A00:01	SubIndex 001	1. PDO Mapping entry (2 bits align)	UINT32	RO	0x0000:00, 2
1A00:02	SubIndex 002	2. PDO Mapping entry (object 0x6000 (ENC Inputs), entry 0x03 (Set counter done))	UINT32	RO	0x6000:03, 1
1A00:03	SubIndex 003	3. PDO Mapping entry (3 bits align)	UINT32	RO	0x0000:00, 3
1A00:04	SubIndex 004	4. PDO Mapping entry (object 0x6000 (ENC Inputs), entry 0x07 (Open circuit))	UINT32	RO	0x6000:07, 1
1A00:05	SubIndex 005	5. PDO Mapping entry (1 bit align)	UINT32	RO	0x0000:00, 1
1A00:06	SubIndex 006	6. PDO Mapping entry (object 0x6000 (ENC Inputs), entry 0x09 (Status of input A))	UINT32	RO	0x6000:09, 1
1A00:07	SubIndex 007	7. PDO Mapping entry (object 0x6000 (ENC Inputs), entry 0x0A (Status of input B))	UINT32	RO	0x6000:0A, 1
1A00:08	SubIndex 008	8. PDO Mapping entry (object 0x6000 (ENC Inputs), entry 0x0B (Status of input C))	UINT32	RO	0x6000:0B, 1
1A00:09	SubIndex 009	9. PDO Mapping entry (2 bits align)	UINT32	RO	0x0000:00, 2
1A00:0A	SubIndex 010	10. PDO Mapping entry (object 0x6000 (ENC Inputs), entry 0x0E (Sync error))	UINT32	RO	0x6000:0E, 1
1A00:0B	SubIndex 011	11. PDO Mapping entry (object 0x6000 (ENC Inputs), entry 0x0F (TxPDO State))	UINT32	RO	0x6000:0F, 1
1A00:0C	SubIndex 012	12. PDO Mapping entry (object 0x6000 (ENC Inputs), entry 0x10 (TxPDO Toggle))	UINT32	RO	0x6000:10, 1

Index 1A01 ENC TxPDO-Map NextSync1Time

Index (hex)	Name	Meaning	Data type	Flags	Default
1A01:0	ENC TxPDO-Map NextSync1Time	PDO Mapping TxPDO 2	UINT8	RO	0x01 (1 _{dec})
1A01:01	SubIndex 001	1. PDO Mapping entry (object 0x6000 (ENC Inputs), entry 0x19 (StartTimeNextLatch))	UINT32	RO	0x6000:19, 64

Index 1A10 ENC TxPDO-Map TxPdo 1 Samples Counter value

Index (hex)	Name	Meaning	Data type	Flags	Default
1A10:0	ENC TxPDO-Map TxPdo 1 Samples Counter value	PDO Mapping TxPDO 17	UINT8	RO	0x01 (1 _{dec})
1A10:01	SubIndex 001	1. PDO Mapping entry (object 0x6000 (ENC Inputs), entry 0x11 (Counter value))	UINT32	RO	0x6000:11, 32

Index 1A11 ENC TxPDO-Map TxPdo 2 Samples Counter value

Index (hex)	Name	Meaning	Data type	Flags	Default
1A11:0	ENC TxPDO-Map TxPdo 2 Samples Counter value	PDO Mapping TxPDO 18	UINT8	RO	0x02 (2 _{dec})
1A11:01	SubIndex 001	1. PDO Mapping entry (object 0x6000 (ENC Inputs), entry 0x11 (Counter value))	UINT32	RO	0x6000:11, 32
1A11:02	SubIndex 002	2. PDO Mapping entry (object 0x6000 (ENC Inputs), entry 0x11 (Counter value))	UINT32	RO	0x6000:11, 32

Index 1A12 ENC TxPDO-Map TxPdo 4 Samples Counter value

Index (hex)	Name	Meaning	Data type	Flags	Default
1A12:0	ENC TxPDO-Map TxPdo 4 Samples Counter value	PDO Mapping TxPDO 19	UINT8	RO	0x04 (4 _{dec})
1A12:01	SubIndex 001	1. PDO Mapping entry (object 0x6000 (ENC Inputs), entry 0x11 (Counter value))	UINT32	RO	0x6000:11, 32
...
1A12:04	SubIndex 004	4. PDO Mapping entry (object 0x6000 (ENC Inputs), entry 0x11 (Counter value))	UINT32	RO	0x6000:11, 32

Index 1A13 ENC TxPDO-Map TxPdo 5 Samples Counter value

Index (hex)	Name	Meaning	Data type	Flags	Default
1A13:0	ENC TxPDO-Map TxPdo 5 Samples Counter value	PDO Mapping TxPDO 20	UINT8	RO	0x05 (5 _{dec})
1A13:01	SubIndex 001	1. PDO Mapping entry (object 0x6000 (ENC Inputs), entry 0x11 (Counter value))	UINT32	RO	0x6000:11, 32
...
1A13:05	SubIndex 005	5. PDO Mapping entry (object 0x6000 (ENC Inputs), entry 0x11 (Counter value))	UINT32	RO	0x6000:11, 32

Index 1A14 ENC TxPDO-Map TxPdo 8 Samples Counter value

Index (hex)	Name	Meaning	Data type	Flags	Default
1A14:0	ENC TxPDO-Map TxPdo 8 Samples Counter value	PDO Mapping TxPDO 21	UINT8	RO	0x08 (8 _{dec})
1A14:01	SubIndex 001	1. PDO Mapping entry (object 0x6000 (ENC Inputs), entry 0x11 (Counter value))	UINT32	RO	0x6000:11, 32
...
1A14:08	SubIndex 008	8. PDO Mapping entry (object 0x6000 (ENC Inputs), entry 0x11 (Counter value))	UINT32	RO	0x6000:11, 32

Index 1A15 ENC TxPDO-Map TxPdo 10 Samples Counter value

Index (hex)	Name	Meaning	Data type	Flags	Default
1A15:0	ENC TxPDO-Map TxPdo 10 Samples Counter value	PDO Mapping TxPDO 22	UINT8	RO	0x0A (10 _{dec})
1A15:01	SubIndex 001	1. PDO Mapping entry (object 0x6000 (ENC Inputs), entry 0x11 (Counter value))	UINT32	RO	0x6000:11, 32
...
1A15:0A	SubIndex 010	10. PDO Mapping entry (object 0x6000 (ENC Inputs), entry 0x11 (Counter value))	UINT32	RO	0x6000:11, 32

Index 1A16 ENC TxPDO-Map TxPdo 16 Samples Counter value

Index (hex)	Name	Meaning	Data type	Flags	Default
1A16:0	ENC TxPDO-Map TxPdo 16 Samples Counter value	PDO Mapping TxPDO 23	UINT8	RO	0x10 (16 _{dec})
1A16:01	SubIndex 001	1. PDO Mapping entry (object 0x6000 (ENC Inputs), entry 0x11 (Counter value))	UINT32	RO	0x6000:11, 32
...
1A16:10	SubIndex 016	16. PDO Mapping entry (object 0x6000 (ENC Inputs), entry 0x11 (Counter value))	UINT32	RO	0x6000:11, 32

Index 1A17 ENC TxPDO-Map TxPdo 20 Samples Counter value

Index (hex)	Name	Meaning	Data type	Flags	Default
1A17:0	ENC TxPDO-Map TxPdo 20 Samples Counter value	PDO Mapping TxPDO 24	UINT8	RO	0x14 (20 _{dec})
1A17:01	SubIndex 001	1. PDO Mapping entry (object 0x6000 (ENC Inputs), entry 0x11 (Counter value))	UINT32	RO	0x6000:11, 32
...
1A17:14	SubIndex 020	20. PDO Mapping entry (object 0x6000 (ENC Inputs), entry 0x11 (Counter value))	UINT32	RO	0x6000:11, 32

Index 1A18 ENC TxPDO-Map TxPdo 25 Samples Counter value

Index (hex)	Name	Meaning	Data type	Flags	Default
1A18:0	ENC TxPDO-Map TxPdo 25 Samples Counter value	PDO Mapping TxPDO 25	UINT8	RO	0x19 (25 _{dec})
1A18:01	SubIndex 001	1. PDO Mapping entry (object 0x6000 (ENC Inputs), entry 0x11 (Counter value))	UINT32	RO	0x6000:11, 32
...
1A18:19	SubIndex 025	25. PDO Mapping entry (object 0x6000 (ENC Inputs), entry 0x11 (Counter value))	UINT32	RO	0x6000:11, 32

Index 1A19 ENC TxPDO-Map TxPdo 32 Samples Counter value

Index (hex)	Name	Meaning	Data type	Flags	Default
1A19:0	ENC TxPDO-Map TxPdo 32 Samples Counter value	PDO Mapping TxPDO 26	UINT8	RO	0x20 (32 _{dec})
1A19:01	SubIndex 001	1. PDO Mapping entry (object 0x6000 (ENC Inputs), entry 0x11 (Counter value))	UINT32	RO	0x6000:11, 32
...
1A19:20	SubIndex 032	32. PDO Mapping entry (object 0x6000 (ENC Inputs), entry 0x11 (Counter value))	UINT32	RO	0x6000:11, 32

Index 1A1A ENC TxPDO-Map TxPdo 40 Samples Counter value

Index (hex)	Name	Meaning	Data type	Flags	Default
1A1A:0	ENC TxPDO-Map TxPdo 40 Samples Counter value	PDO Mapping TxPDO 27	UINT8	RO	0x28 (40 _{dec})
1A1A:01	SubIndex 001	1. PDO Mapping entry (object 0x6000 (ENC Inputs), entry 0x11 (Counter value))	UINT32	RO	0x6000:11, 32
...
1A1A:28	SubIndex 040	40. PDO Mapping entry (object 0x6000 (ENC Inputs), entry 0x11 (Counter value))	UINT32	RO	0x6000:11, 32

Index 1A1B ENC TxPDO-Map TxPdo 50 Samples Counter value

Index (hex)	Name	Meaning	Data type	Flags	Default
1A1B:0	ENC TxPDO-Map TxPdo 50 Samples Counter value	PDO Mapping TxPDO 28	UINT8	RO	0x32 (50 _{dec})
1A1B:01	SubIndex 001	1. PDO Mapping entry (object 0x6000 (ENC Inputs), entry 0x11 (Counter value))	UINT32	RO	0x6000:11, 32
...
1A1B:32	SubIndex 050	50. PDO Mapping entry (object 0x6000 (ENC Inputs), entry 0x11 (Counter value))	UINT32	RO	0x6000:11, 32

Index 1A1C ENC TxPDO-Map TxPdo 64 Samples Counter value

Index (hex)	Name	Meaning	Data type	Flags	Default
1A1C:0	ENC TxPDO-Map TxPdo 64 Samples Counter value	PDO Mapping TxPDO 29	UINT8	RO	0x40 (64 _{dec})
1A1C:01	SubIndex 001	1. PDO Mapping entry (object 0x6000 (ENC Inputs), entry 0x11 (Counter value))	UINT32	RO	0x6000:11, 32
...
1A1C:40	SubIndex 064	64. PDO Mapping entry (object 0x6000 (ENC Inputs), entry 0x11 (Counter value))	UINT32	RO	0x6000:11, 32

Index 1A1D ENC TxPDO-Map TxPdo 80 Samples Counter value

Index (hex)	Name	Meaning	Data type	Flags	Default
1A1D:0	ENC TxPDO-Map TxPdo 80 Samples Counter value	PDO Mapping TxPDO 30	UINT8	RO	0x50 (80 _{dec})
1A1D:01	SubIndex 001	1. PDO Mapping entry (object 0x6000 (ENC Inputs), entry 0x11 (Counter value))	UINT32	RO	0x6000:11, 32
...
1A1D:50	SubIndex 080	80. PDO Mapping entry (object 0x6000 (ENC Inputs), entry 0x11 (Counter value))	UINT32	RO	0x6000:11, 32

Index 1A1E ENC TxPDO-Map TxPdo 100 Samples Counter value

Index (hex)	Name	Meaning	Data type	Flags	Default
1A1E:0	ENC TxPDO-Map TxPdo 100 Samples Counter value	PDO Mapping TxPDO 31	UINT8	RO	0x64 (100 _{dec})
1A1E:01	SubIndex 001	1. PDO Mapping entry (object 0x6000 (ENC Inputs), entry 0x11 (Counter value))	UINT32	RO	0x6000:11, 32
...
1A1E:64	SubIndex 100	100. PDO Mapping entry (object 0x6000 (ENC Inputs), entry 0x11 (Counter value))	UINT32	RO	0x6000:11, 32

Index 1C00 Sync manager type

Index (hex)	Name	Meaning	Data type	Flags	Default
1C00:0	Sync manager type	Using the sync managers	UINT8	RO	0x04 (4 _{dec})
1C00:01	SubIndex 001	Sync-Manager Type Channel 1: Mailbox Write	UINT8	RO	0x01 (1 _{dec})
1C00:02	SubIndex 002	Sync-Manager Type Channel 2: Mailbox Read	UINT8	RO	0x02 (2 _{dec})
1C00:03	SubIndex 003	Sync-Manager Type Channel 3: Process Data Write (Outputs)	UINT8	RO	0x03 (3 _{dec})
1C00:04	SubIndex 004	Sync-Manager Type Channel 4: Process Data Read (Inputs)	UINT8	RO	0x04 (4 _{dec})

Index 1C12 RxPDO assign

Index (hex)	Name	Meaning	Data type	Flags	Default
1C12:0	RxPDO assign	PDO Assign Outputs	UINT8	RW	0x01 (1 _{dec})
1C12:01	SubIndex 001	1 st allocated RxPDO (contains the index of the associated RxPDO mapping object)	UINT16	RW	0x1600 (5632 _{dec})

Index 1C13 TxPDO assign

Index (hex)	Name	Meaning	Data type	Flags	Default
1C13:0	TxPDO assign	PDO Assign Inputs	UINT8	RW	0x03 (3 _{dec})
1C13:01	SubIndex 001	1 st allocated TxPDO (contains the index of the associated TxPDO mapping object)	UINT16	RW	0x1A00 (6656 _{dec})
1C13:02	SubIndex 002	2 nd allocated TxPDO (contains the index of the associated TxPDO mapping object)	UINT16	RW	0x1A01 (6657 _{dec})
1C13:03	SubIndex 003	3 rd allocated TxPDO (contains the index of the associated TxPDO mapping object)	UINT16	RW	0x1A10 (6672 _{dec})

Index 1C32 SM output parameter

Index (hex)	Name	Meaning	Data type	Flags	Default
1C32:0	SM output parameter	Synchronization parameters for the outputs	UINT8	RO	0x20 (32 _{dec})
1C32:01	Sync mode	Current synchronization mode: <ul style="list-style-type: none"> 0: Free Run 1: Synchron with SM 2 Event 2: DC-Mode - Synchron with SYNC0 Event 3: DC-Mode - Synchron with SYNC1 Event 	UINT16	RW	0x0001 (1 _{dec})
1C32:02	Cycle time	Cycle time (in ns): <ul style="list-style-type: none"> Free Run: Cycle time of the local timer Synchronous with SM 2 event: Master cycle time DC-Mode: SYNC0/SYNC1 Cycle Time 	UINT32	RW	0x00000000 (0 _{dec})
1C32:03	Shift time	Time between SYNC0 event and output of the outputs (in ns, DC mode only)	UINT32	RO	0x00000000 (0 _{dec})
1C32:04	Sync modes supported	Supported synchronization modes: <ul style="list-style-type: none"> Bit 0 = 1: free run is supported Bit 1 = 1: Synchronous with SM 2 event is supported Bit 2-3 = 01: DC mode is supported Bit 4-5 = 10: Output shift with SYNC1 event (only DC mode) Bit 14 = 1: dynamic times (measurement through writing of 0x1C32:08 [▶ 230]) 	UINT16	RO	0xC007 (49159 _{dec})
1C32:05	Minimum cycle time	Minimum cycle time (in ns)	UINT32	RO	0x00000000 (0 _{dec})
1C32:06	Calc and copy time	Minimum time between SYNC0 and SYNC1 event (in ns, DC mode only)	UINT32	RO	0x00000000 (0 _{dec})
1C32:07	Minimum delay time		UINT32	RO	0x00000000 (0 _{dec})
1C32:08	Command	With this entry the real required process data provision time can be measured. <ul style="list-style-type: none"> 0: Measurement of the local cycle time is stopped 1: Measurement of the local cycle time is started <p>The entries 0x1C32:03 [▶ 230], 0x1C32:05 [▶ 230], 0x1C32:06 [▶ 230], 0x1C32:09 [▶ 230], 0x1C33:03 [▶ 231], 0x1C33:06 [▶ 230], and 0x1C33:09 [▶ 231] are updated with the maximum measured values. For a subsequent measurement the measured values are reset</p>	UINT16	RW	0x0000 (0 _{dec})
1C32:09	Maximum delay time	Time between SYNC1 event and output of the outputs (in ns, DC mode only)	UINT32	RO	0x00000000 (0 _{dec})
1C32:0B	SM event missed counter	Number of missed SM events in OPERATIONAL (DC mode only)	UINT16	RO	0x0000 (0 _{dec})
1C32:0C	Cycle exceeded counter	Number of occasions the cycle time was exceeded in OPERATIONAL (cycle was not completed in time or the next cycle began too early)	UINT16	RO	0x0000 (0 _{dec})
1C32:0D	Shift too short counter	Number of occasions that the interval between SYNC0 and SYNC1 event was too short (DC mode only)	UINT16	RO	0x0000 (0 _{dec})
1C32:20	Sync error	The synchronization was not correct in the last cycle (outputs were output too late; DC mode only)	BOOLEAN	RO	0x00 (0 _{dec})

Index 1C33 SM input parameter

Index (hex)	Name	Meaning	Data type	Flags	Default
1C33:0	SM input parameter	Synchronization parameters for the inputs	UINT8	RO	0x20 (32 _{dec})
1C33:01	Sync mode	Current synchronization mode: <ul style="list-style-type: none"> • 0: Free Run • 1: Synchronous with SM 3 event (no outputs available) • 2: DC - Synchron with SYNC0 Event • 3: DC - Synchron with SYNC1 Event • 34: Synchronous with SM 2 event (outputs available) 	UINT16	RW	0x0022 (34 _{dec})
1C33:02	Cycle time	as 0x1C32:02 230	UINT32	RW	0x00000000 (0 _{dec})
1C33:03	Shift time	Time between SYNC0 event and reading of the inputs (in ns, only DC mode)	UINT32	RO	0x00000000 (0 _{dec})
1C33:04	Sync modes supported	Supported synchronization modes: <ul style="list-style-type: none"> • Bit 0: free run is supported • Bit 1: synchronous with SM 2 event is supported (outputs available) • Bit 1: synchronous with SM 3 event is supported (no outputs available) • Bit 2-3 = 01: DC mode is supported • Bit 4-5 = 01: input shift through local event (outputs available) • Bit 4-5 = 10: input shift with SYNC1 event (no outputs available) • Bit 14 = 1: dynamic times (measurement through writing of 0x1C32:08 230 or 0x1C33:08 231) 	UINT16	RO	0xC007 (49159 _{dec})
1C33:05	Minimum cycle time	as 0x1C32:05 230	UINT32	RO	0x00000000 (0 _{dec})
1C33:06	Calc and copy time	Time between reading of the inputs and availability of the inputs for the master (in ns, only DC mode)	UINT32	RO	0x00000000 (0 _{dec})
1C33:07	Minimum delay time		UINT32	RO	0x00000000 (0 _{dec})
1C33:08	Command	as 0x1C32:08 230	UINT16	RW	0x0000 (0 _{dec})
1C33:09	Delay time	Time between SYNC1 event and reading of the inputs (in ns, only DC mode)	UINT32	RO	0x00000000 (0 _{dec})
1C33:0B	SM event missed counter	as 0x1C32:11 230	UINT16	RO	0x0000 (0 _{dec})
1C33:0C	Cycle exceeded counter	as 0x1C32:12 230	UINT16	RO	0x0000 (0 _{dec})
1C33:0D	Shift too short counter	as 0x1C32:13 230	UINT16	RO	0x0000 (0 _{dec})
1C33:20	Sync error	as 0x1C32:32 230	BOOLEAN	RO	0x00 (0 _{dec})

Index F000 Modular device profile

Index (hex)	Name	Meaning	Data type	Flags	Default
F000:0	Modular device profile	General information for the modular device profile	UINT8	RO	0x02 (2 _{dec})
F000:01	Module index distance	Index spacing of the objects of the individual channels	UINT16	RO	0x0010 (16 _{dec})
F000:02	Maximum number of modules	Number of channels	UINT16	RO	0x0001 (1 _{dec})

Index F008 Code word

Index (hex)	Name	Meaning	Data type	Flags	Default
F008:0	Code word	reserved	UINT32	RW	0x00000000 (0 _{dec})

Index F010 Module list

Index (hex)	Name	Meaning	Data type	Flags	Default
F010:0	Module list	Maximum subindex	UINT8	RW	0x02 (2 _{dec})
F010:01	SubIndex 001	Profile 510	UINT32	RW	0x000001FF (511 _{dec})

Index F082 MDP Profile Compatibility

Index (hex)	Name	Meaning	Data type	Flags	Default
F082:0	MDP Profile Compatibility	Maximum subindex	UINT8	RO	0x01 (1 _{dec})
F082:01	Compatible input cycle counter	-	BOOLEAN	RW	0x00 (0 _{dec})

17 EL5101-0090 - Commissioning

The EL5101-0090 supports the full functionality of the EL5101 (please refer to chapter “[EL5101 - Commissioning \[▶ 145\]](#)”).

In addition, the EL5101-0090 supports the TwinSAFE SC technology.

17.1 TwinSAFE SC

17.1.1 TwinSAFE SC - operating principle

The TwinSAFE SC (Single Channel) technology enables the use of standard signals for safety tasks in any networks of fieldbuses. To do this, EtherCAT Terminals from the areas of analog input, angle/displacement measurement or communication (4...20 mA, incremental encoder, IO-Link, etc.) are extended by the TwinSAFE SC function. The typical signal characteristics and standard functionalities of the I/O components are retained. TwinSAFE SC I/Os have a yellow strip at the front of the housing to distinguish them from standard I/Os.

The TwinSAFE SC technology enables communication via a TwinSAFE protocol. These connections can be distinguished from the usual safe communication via Safety over EtherCAT.

The data of the TwinSAFE SC components are transferred via a TwinSAFE protocol to the TwinSAFE logic, where they can be used in the context of safety-relevant applications. Detailed examples for the correct application of the TwinSAFE SC components and the respective normative classification, which were confirmed/calculated by TÜV SÜD, can be found in the [TwinSAFE application manual](#).

17.1.2 TwinSAFE SC - configuration

The TwinSAFE SC technology enables communication with standard EtherCAT terminals via the Safety over EtherCAT protocol. These connections use another checksum, in order to be able to distinguish between TwinSAFE SC and TwinSAFE. Eight fixed CRCs can be selected, or a free CRC can be entered by the user.

By default the TwinSAFE SC communication channel of the respective TwinSAFE SC component is not enabled. In order to be able to use the data transfer, the corresponding TwinSAFE SC module must first be added under the Slots tab. Only then is it possible to link to a corresponding alias device.

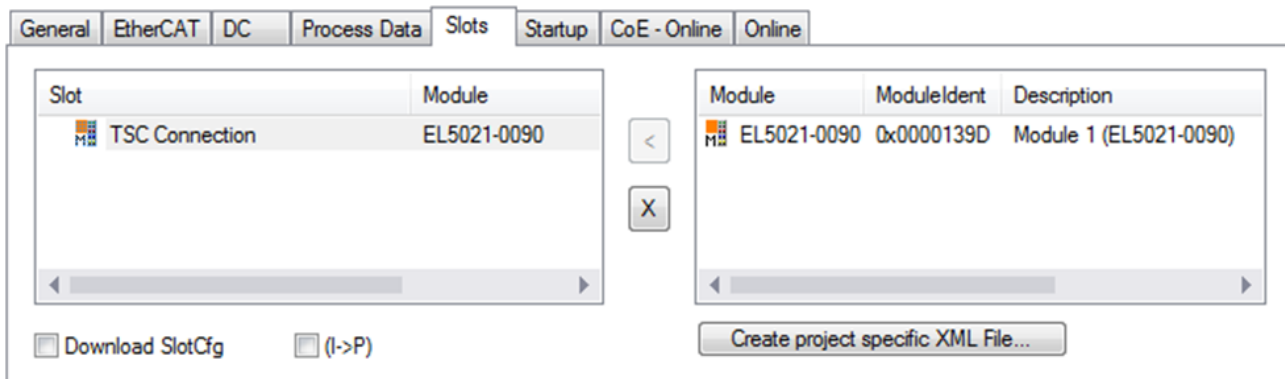

Fig. 178: Adding the TwinSAFE SC process data under the component, e.g. EL5021-0090

Additional process data with the ID TSC Inputs, TSC Outputs are generated (TSC - TwinSAFE Single Channel).

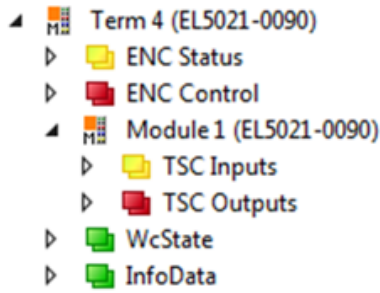

Fig. 179: TwinSAFE SC component process data, example EL5021-0090

A TwinSAFE SC connection is added by adding an alias devices in the safety project and selecting TSC (*TwinSAFE Single Channel*)

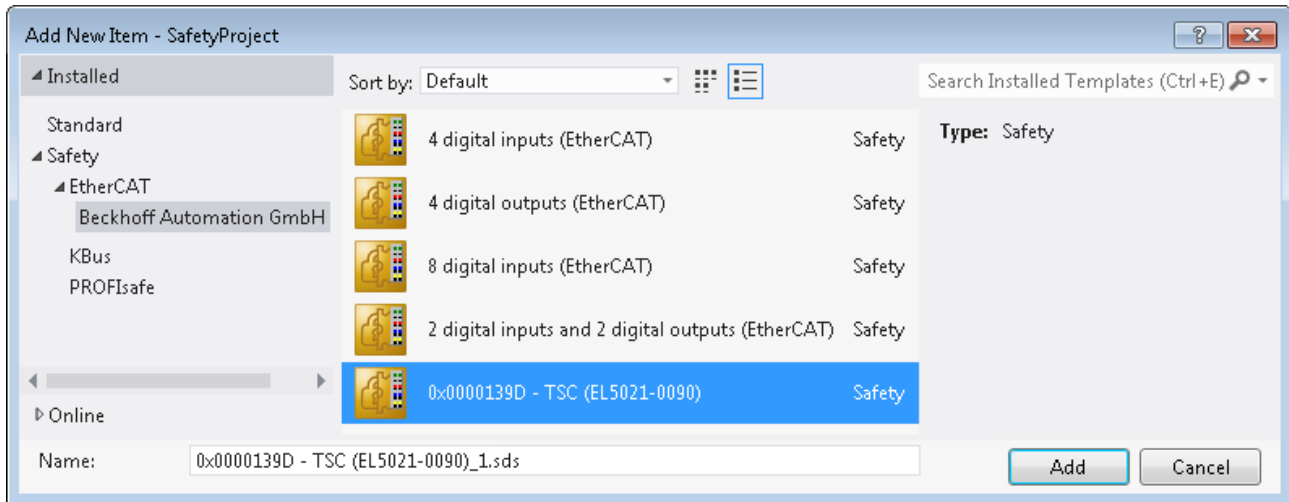



Fig. 180: Adding a TwinSAFE SC connection

After opening the alias device by double-clicking, select the Link button  next to *Physical Device*, in order to create the link to a TwinSAFE SC terminal. Only suitable TwinSAFE SC terminals are offered in the selection dialog.

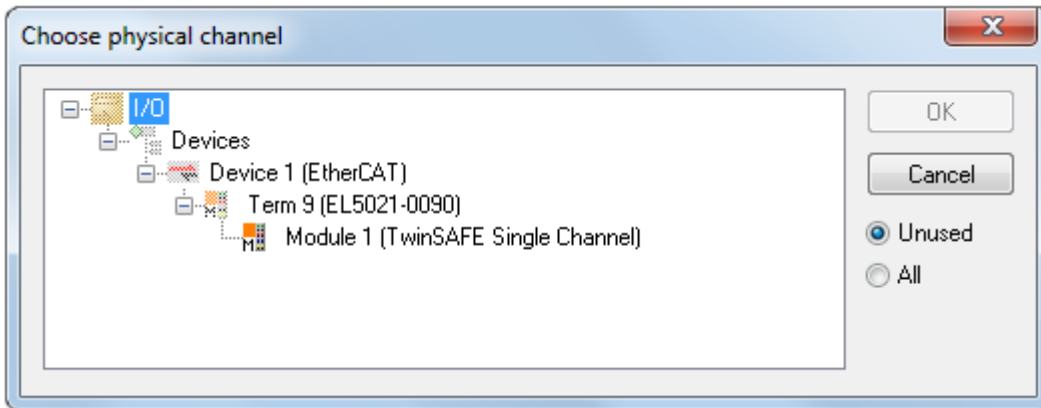

Fig. 181: Creating a link to TwinSAFE SC terminal

The CRC to be used can be selected or a free CRC can be entered under the Connection tab of the alias device.

Entry Mode	Used CRCs
TwinSAFE SC CRC 1 master	0x17B0F
TwinSAFE SC CRC 2 master	0x1571F
TwinSAFE SC CRC 3 master	0x11F95
TwinSAFE SC CRC 4 master	0x153F1
TwinSAFE SC CRC 5 master	0x1F1D5
TwinSAFE SC CRC 6 master	0x1663B
TwinSAFE SC CRC 7 master	0x1B8CD
TwinSAFE SC CRC 8 master	0x1E1BD

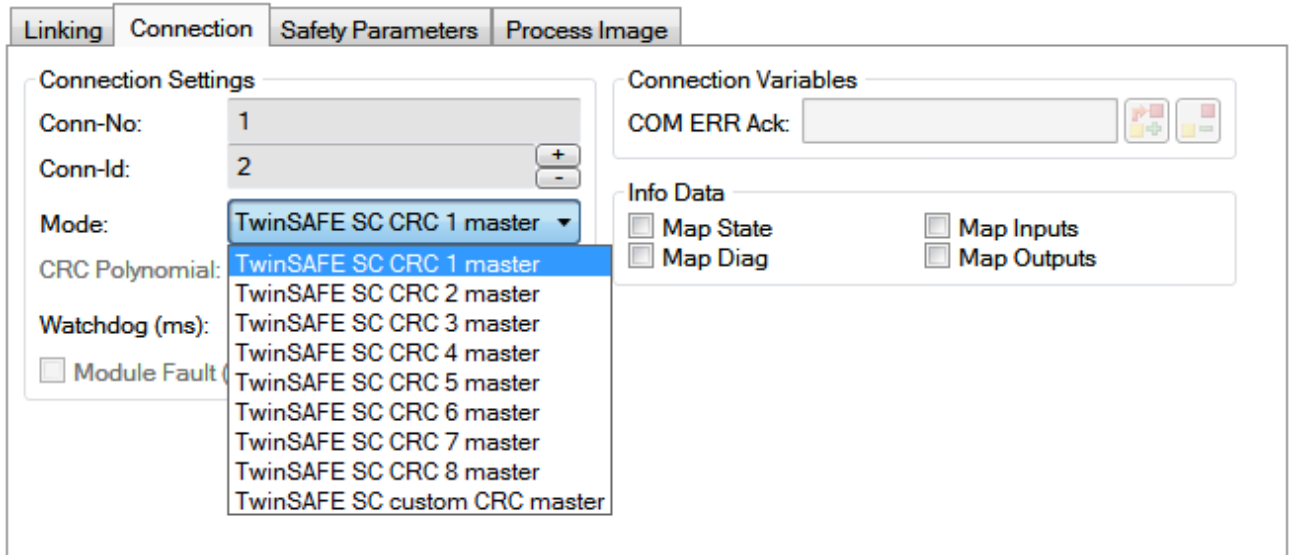

Fig. 182: Selecting a free CRC

These settings must match the settings in the CoE objects of the TwinSAFE SC component. The TwinSAFE SC component initially makes all available process data available. The *Safety Parameters* tab typically contains no parameters. The process data size and the process data themselves can be selected under the *Process Image* tab.

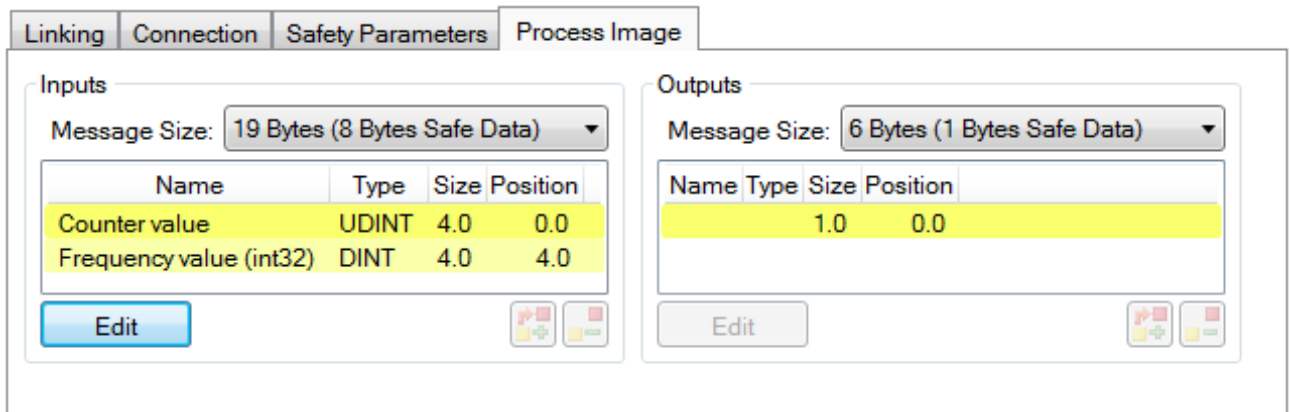

Fig. 183: Selecting the process data size and the process data

The process data (defined in the ESI file) can be adjusted to user requirements by selecting the *Edit* button in the dialog *Configure I/O element(s)*.

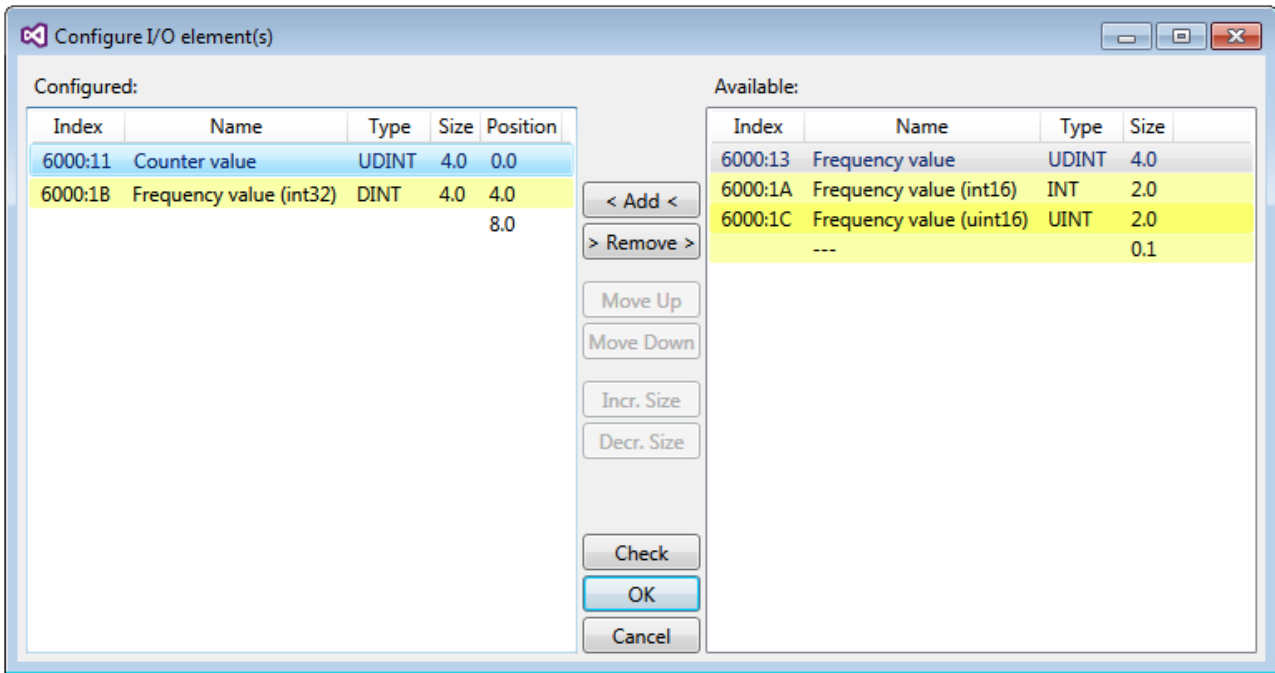

Fig. 184: Selection of the process data

The safety address together with the CRC must be entered on the TwinSAFE SC slave side. This is done via the CoE objects under *TSC settings* of the corresponding TwinSAFE SC component (here, for example, EL5021-0090, 0x8010: 01 and 0x8010: 02). The address set here must also be set in the *alias device* as *FSoE* address under the *Linking* tab.

Under the object 0x80n0:02 Connection Mode the CRC to be used is selected or a free CRC is entered. A total of 8 CRCs are available. A free CRC must start with 0x00ff in the high word.

8010:0	TSC Settings	RW	> 2 <
8010:01	Address	RW	0x0000 (0)
8010:02	Connection Mode	RW	TwinSAFE SC CRC1 master (97039)

Fig. 185: CoE objects 0x8010:01 and 0x8010:02

Object TSC Settings

Depending on the terminal, the index designation of the configuration object *TSC Settings* can vary. Example:

- EL3214-0090 and EL3314-0090, TSC Settings, Index 8040
- EL5021-0090, TSC Settings, Index 8010
- EL6224-0090, TSC Settings, Index 800F

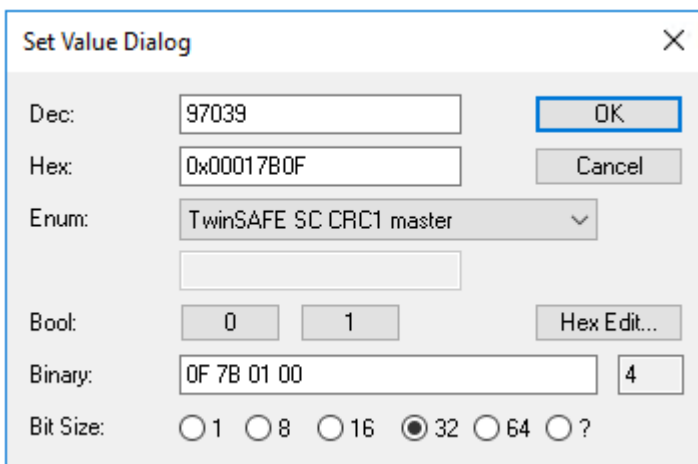

Fig. 186: Entering the safety address and the CRC

● TwinSAFE SC connections

i If several TwinSAFE SC connections are used within a configuration, a different CRC must be selected for each TwinSAFE SC connection.

17.1.3 TwinSAFE SC process data EL5101-0090

The EL5101-0090 transmits the following process data to the TwinSAFE logic:

Index (hex)	Name	Type	Size
6010:1D	Counter value (uint16)	UINT	2.0
6010:11	Counter value	UDINT	4.0
6010:13	Frequency value	UDINT	4.0
6010:14	Period value	UDINT	4.0
6010:1C	Frequency value (uint16)	UINT	2.0
6010:1E	Period value (uint16)	UINT	2.0

The Counter Value (uint16) (0x6010:1D) is transferred as default value. Via the „Process Image“ tab, other data types can be selected or completely deselected in the Safety Editor.

Depending on the TwinCAT 3.1 version, process data can be renamed automatically when linking to the Safety Editor.

● TwinSAFE SC Objects

i The TwinSAFE SC objects of the EL5101-0090 are listed in chapter [Objects TwinSAFE Single Channel \(EL5101-0090 \[▶ 257\]\)](#).

17.2 Process data and operation modes

Information on process data and operating modes can be found in chapter [EL5101 - Commissioning \[▶ 145\]](#).

17.3 Object description and parameterization - normal operation mode

EtherCAT XML Device Description

The display matches that of the CoE objects from the EtherCAT XML Device Description. We recommend downloading the latest XML file from the download area of the Beckhoff website and installing it according to installation instructions.

NOTICE



Parameterization via the CoE list (CAN over EtherCAT)

The EtherCAT device is parameterized via the CoE - Online tab (with a double click on the respective object) or via the Process Data tab (assignment of PDOs). A detailed description can be found in the EtherCAT System-Documentation in chapter "EtherCAT subscriber configuration"

Please note the general CoE notes in the EtherCAT System Documentation in chapter "CoE-interface" when using/manipulating the CoE parameters:

- Keep a startup list if components have to be replaced
- Differentiation between online/offline dictionary,
- existence of current XML description
- use "CoE reload" for resetting changes

17.3.1 Restore object

Index 1011 Restore default parameters

Index (hex)	Name	Meaning	Data type	Flags	Default
1011:0	<u>Restore default parameters</u> [▶ 273]	Restore default parameters	UINT8	RO	0x01 (1 _{dec})
1011:01	SubIndex 001	If this object is set to " 0x64616F6C " in the set value dialog, all backup objects are reset to their delivery state.	UINT32	RW	0x00000000 (0 _{dec})

17.3.2 Configuration data

Index 8000 Non-Volatile Settings 0

Index (hex)	Name	Meaning	Data type	Flags	Default
8000:0	Non-Volatile Settings 0	Maximum subindex	UINT8	RO	0x05 (5 _{dec})
8000:01	Enable register reload [▶ 152]	The counter counts up to the "Counter reload value", or the "Counter reload value" (0x8001:02 [▶ 239]) is loaded in the event of an underflow Example 360° encoder with set bit: Moves in positive direction via Counter reload value [▶ 239]: Reset counter value to 0. Moves in negative direction less than 0: Reset counter value to Counter reload value [▶ 239].	BOOLEAN	RW	0x00 (0 _{dec})
8000:02	Enable index reset [▶ 152]	Activates input "C" for resetting the counter. Example 360° encoder with set bit: Moves in positive direction (signal at input "C"): Reset counter value to 0 Moves in negative direction (signal at input "C"): underflow with FFFF, FFFE etc.)	BOOLEAN	RW	0x00 (0 _{dec})
8000:03	Enable FWD count [▶ 153]	FALSE The terminal operates in quadrature decoder mode TRUE The terminal operates as counter, count direction to input B	BOOLEAN	RW	0x00 (0 _{dec})
8000:04	Enable pos. gate [▶ 153]	Gate input responds to positive edge and locks the counter	BOOLEAN	RW	0x01 (1 _{dec})
8000:05	Enable neg. gate [▶ 153]	Gate input responds to negative edge and locks the counter	BOOLEAN	RW	0x00 (0 _{dec})

Index 8001 Non-Volatile Settings 1

Index (hex)	Name	Meaning	Data type	Flags	Default
8001:0	Non-Volatile Settings 1	Maximum subindex	UINT8	RO	0x02 (2 _{dec})
8001:01	Frequency window [▶ 153]	The value specifies the size of the time window for the "Window [▶ 239]" variable. resolution: 16 μs; e.g. default value: 16 μs x 100 _{dec} = 1.6 ms	UINT16	RW	0x0064 (100 _{dec})
8001:02	Counter reload value [▶ 152]	If " Enable register reload [▶ 239]" = TRUE, the counter counts up to this value and is loaded with this value in the event of an underflow	UINT16	RW	0xFFFF (65535 _{dec})

17.3.3 Input data

Index 6000 Inputs

Index (hex)	Name	Meaning	Data type	Flags	Default
6000:0	Inputs	Length of this object	UINT8	RO	0x06 (6 _{dec})
6000:01	Status	Status byte [▶ 160]	UINT8	RO	0x00 (0 _{dec})
6000:02	Value	meter reading	UINT16	RO	0x0000 (0 _{dec})
6000:03	Latch	Latch value	UINT16	RO	0x0000 (0 _{dec})
6000:04	Frequency	Frequency value (resolution: 0.01 Hz / digit) [fixed 10 ms measuring window]	UINT32	RO	0x00000000 (0 _{dec})
6000:05	Period	Period (resolution 500 ns / digit)	UINT16	RO	0x0000 (0 _{dec})
6000:06	Window	Measured value of the variable timeframe ("Frequency window" (0x8001:01 [▶ 239]))	UINT16	RO	0x0000 (0 _{dec})

17.3.4 Output data

Index 7000 Outputs

Index (hex)	Name	Meaning	Data type	Flags	Default
7000:0	Outputs	Length of this object	UINT8	RO	0x02 (2 _{dec})
7000:01	Ctrl [▶_160]	Control byte [▶_160]	UINT8	RO	0x00 (0 _{dec})
7000:02	Value	The counter value to be set via CNT_SET (CB.02 [▶_160]).	UINT16	RO	0x0000 (0 _{dec})

17.3.5 Standard objects

The standard objects have the same meaning for all EtherCAT slaves.

Index 1000 Device type

Index (hex)	Name	Meaning	Data type	Flags	Default
1000:0	Device type	Device type of the EtherCAT slave: the Lo-Word contains the CoE profile used (5001). The Hi-Word contains the module profile according to the modular device profile.	UINT32	RO	0x00001389 (5001 _{dec})

Index 1008 Device name

Index (hex)	Name	Meaning	Data type	Flags	Default
1008:0	Device name	Device name of the EtherCAT slave	STRING	RO	EL5101-0090

Index 1009 Hardware version

Index (hex)	Name	Meaning	Data type	Flags	Default
1009:0	Hardware version	Hardware version of the EtherCAT slave	STRING	RO	09

Index 100A Software version

Index (hex)	Name	Meaning	Data type	Flags	Default
100A:0	Software version	Firmware version of the EtherCAT slave	STRING	RO	10

Index 1018 Identity

Index (hex)	Name	Meaning	Data type	Flags	Default
1018:0	Identity	Information for identifying the slave	UINT8	RO	0x04 (4 _{dec})
1018:01	Vendor ID	Vendor ID of the EtherCAT slave	UINT32	RO	0x00000002 (2 _{dec})
1018:02	Product code	Product code of the EtherCAT slave	UINT32	RO	0x13ED3052 (334311506 _{dec})
1018:03	Revision	Revision number of the EtherCAT slave; the low word (bit 0-15) indicates the special terminal number, the high word (bit 16-31) refers to the device description	UINT32	RO	0x00000000 (0 _{dec})
1018:04	Serial number	Serial number of the EtherCAT slave; the low byte (bit 0-7) of the low word contains the year of production, the high byte (bit 8-15) of the low word contains the week of production, the high word (bit 16-31) is 0	UINT32	RO	0x00000000 (0 _{dec})

Index 1600 RxPDO-Map Outputs

Index (hex)	Name	Meaning	Data type	Flags	Default
1600:0	RxPDO-Map Outputs	PDO Mapping RxPDO 1	UINT8	RO	0x02 (2 _{dec})
1600:01	SubIndex 001	1. PDO Mapping entry (object 0x7000 (Outputs), entry 0x01 (Ctrl))	UINT32	RO	0x7000:01, 8
1600:02	SubIndex 002	2. PDO Mapping entry (object 0x7000 (Outputs), entry 0x02 (Value))	UINT32	RO	0x7000:02, 16

Index 1601 RxPDO-Map Outputs Word-Aligned

Index (hex)	Name	Meaning	Data type	Flags	Default
1601:0	RxPDO-Map Outputs Word-Aligned	PDO Mapping RxPDO 2	UINT8	RO	0x03 (3 _{dec})
1601:01	SubIndex 001	1. PDO Mapping entry (object 0x7000 (Outputs), entry 0x01 (Ctrl))	UINT32	RO	0x7000:01, 8
1601:02	SubIndex 002	2. PDO Mapping entry (8 bits align)	UINT32	RO	0x0000:00, 8
1601:03	SubIndex 003	3. PDO Mapping entry (object 0x7000 (Outputs), entry 0x02 (Value))	UINT32	RO	0x7000:02, 16

Index 1A00 TxPDO-Map Inputs

Index (hex)	Name	Meaning	Data type	Flags	Default
1A00:0	TxPDO-Map Inputs	PDO Mapping TxPDO 1	UINT8	RO	0x03 (3 _{dec})
1A00:01	SubIndex 001	1. PDO Mapping entry (object 0x6000 (Inputs), entry 0x01 (Status))	UINT32	RO	0x6000:01, 8
1A00:02	SubIndex 002	2. PDO Mapping entry (object 0x6000 (Inputs), entry 0x02 (Value))	UINT32	RO	0x6000:02, 16
1A00:03	SubIndex 003	3. PDO Mapping entry (object 0x6000 (Inputs), entry 0x03 (Latch))	UINT32	RO	0x6000:03, 16

Index 1A01 TxPDO-Map Inputs Word-Aligned

Index (hex)	Name	Meaning	Data type	Flags	Default
1A01:0	TxPDO-Map Inputs Word-Aligned	PDO Mapping TxPDO 2	UINT8	RO	0x04 (4 _{dec})
1A01:01	SubIndex 001	1. PDO Mapping entry (object 0x6000 (Inputs), entry 0x01 (Status))	UINT32	RO	0x6000:01, 8
1A01:02	SubIndex 002	2. PDO Mapping entry (8 bits align)	UINT32	RO	0x0000:00, 8
1A01:03	SubIndex 003	3. PDO Mapping entry (object 0x6000 (Inputs), entry 0x02 (Value))	UINT32	RO	0x6000:02, 16
1A01:04	SubIndex 004	4. PDO Mapping entry (object 0x6000 (Inputs), entry 0x03 (Latch))	UINT32	RO	0x6000:03, 16

Index 1A02 TxPDO-Map Inputs Optional

Index (hex)	Name	Meaning	Data type	Flags	Default
1A02:0	TxPDO-Map Inputs Optional	PDO Mapping TxPDO 3	UINT8	RO	0x03 (3 _{dec})
1A02:01	SubIndex 001	1. PDO Mapping entry (object 0x6000 (Inputs), entry 0x04 (Frequency))	UINT32	RO	0x6000:04, 32
1A02:02	SubIndex 002	2. PDO Mapping entry (object 0x6000 (Inputs), entry 0x05 (Period))	UINT32	RO	0x6000:05, 16
1A02:03	SubIndex 003	3. PDO Mapping entry (object 0x6000 (Inputs), entry 0x06 (Window))	UINT32	RO	0x6000:06, 16

Index 1C00 Sync manager type

Index (hex)	Name	Meaning	Data type	Flags	Default
1C00:0	Sync manager type	Using the sync managers	UINT8	RO	0x04 (4 _{dec})
1C00:01	SubIndex 001	Sync-Manager Type Channel 1: Mailbox Write	UINT8	RO	0x01 (1 _{dec})
1C00:02	SubIndex 002	Sync-Manager Type Channel 2: Mailbox Read	UINT8	RO	0x02 (2 _{dec})
1C00:03	SubIndex 003	Sync-Manager Type Channel 3: Process Data Write (Outputs)	UINT8	RO	0x03 (3 _{dec})
1C00:04	SubIndex 004	Sync-Manager Type Channel 4: Process Data Read (Inputs)	UINT8	RO	0x04 (4 _{dec})

Index 1C12 RxPDO assign

Index (hex)	Name	Meaning	Data type	Flags	Default
1C12:0	RxPDO assign	PDO Assign Outputs	UINT8	RW	0x02 (2 _{dec})
1C12:01	SubIndex 001	1 st allocated RxPDO (contains the index of the associated RxPDO mapping object)	UINT16	RW	0x1600 (5632 _{dec})
1C12:02	SubIndex 002	1 st allocated RxPDO (contains the index of the associated RxPDO mapping object)	UINT16	RW	0x1610 (5648 _{dec})

Index 1C13 TxPDO assign

Index (hex)	Name	Meaning	Data type	Flags	Default
1C13:0	TxPDO assign	PDO Assign Inputs	UINT8	RW	0x01 (1 _{dec})
1C13:01	SubIndex 001	1 st allocated TxPDO (contains the index of the associated TxPDO mapping object)	UINT16	RW	0x1A00 (6656 _{dec})
1C13:02	SubIndex 002	2 nd allocated TxPDO (contains the index of the associated TxPDO mapping object)	UINT16	RW	0x1A10 (6672 _{dec})
1C13:03	SubIndex 003	2 nd allocated TxPDO (contains the index of the associated TxPDO mapping object)	UINT16	RW	0x0000 (0 _{dec})
1C13:04	SubIndex 004	3 rd allocated TxPDO (contains the index of the associated TxPDO mapping object)	UINT16	RW	0x0000 (0 _{dec})

Index 1C32 SM output parameter

Index (hex)	Name	Meaning	Data type	Flags	Default
1C32:0	SM output parameter	Synchronization parameters for the outputs	UINT8	RO	0x20 (32 _{dec})
1C32:01	Sync mode	Current synchronization mode: <ul style="list-style-type: none"> 0: Free Run 1: Synchron with SM 2 Event 2: DC-Mode - Synchron with SYNC0 Event 3: DC-Mode - Synchron with SYNC1 Event 	UINT16	RW	0x0001 (1 _{dec})
1C32:02	Cycle time	Cycle time (in ns): <ul style="list-style-type: none"> Free Run: Cycle time of the local timer Synchronous with SM 2 event: Master cycle time DC mode: SYNC0/SYNC1 Cycle Time 	UINT32	RW	0x000F4240 (1000000 _{dec})
1C32:03	Shift time	Time between SYNC0 event and output of the outputs (in ns, DC mode only)	UINT32	RO	0x00000000 (0 _{dec})
1C32:04	Sync modes supported	Supported synchronization modes: <ul style="list-style-type: none"> Bit 0 = 1: free run is supported Bit 1 = 1: Synchronous with SM 2 event is supported Bit 2-3 = 01: DC mode is supported Bit 4-5 = 10: Output shift with SYNC1 event (only DC mode) Bit 14 = 1: dynamic times (measurement through writing of 0x1C32:08 [▶ 242]) 	UINT16	RO	0x4807 (18439 _{dec})
1C32:05	Minimum cycle time	Minimum cycle time (in ns)	UINT32	RO	0x000103C4 (66500 _{dec})
1C32:06	Calc and copy time	Minimum time between SYNC0 and SYNC1 event (in ns, DC mode only)	UINT32	RO	0x00000000 (0 _{dec})
1C32:07	Minimum delay time		UINT32	RO	0x00000000 (0 _{dec})
1C32:08	Command	<ul style="list-style-type: none"> 0: Measurement of the local cycle time is stopped 1: Measurement of the local cycle time is started <p>The entries 0x1C32:03 [▶ 242], 0x1C32:05 [▶ 242], 0x1C32:06 [▶ 242], 0x1C32:09 [▶ 242], 0x1C33:03, 0x1C33:06 [▶ 242], 0x1C33:09 are updated with the maximum measured values. For a subsequent measurement the measured values are reset</p>	UINT16	RW	0x0000 (0 _{dec})
1C32:09	Delay time	Time between SYNC1 event and output of the outputs (in ns, DC mode only)	UINT32	RO	0x00000000 (0 _{dec})
1C32:0B	SM event missed counter	Number of missed SM events in OPERATIONAL (DC mode only)	UINT16	RO	0x0000 (0 _{dec})
1C32:0C	Cycle exceeded counter	Number of occasions the cycle time was exceeded in OPERATIONAL (cycle was not completed in time or the next cycle began too early)	UINT16	RO	0x0000 (0 _{dec})
1C32:0D	Shift too short counter	Number of occasions that the interval between SYNC0 and SYNC1 event was too short (DC mode only)	UINT16	RO	0x0000 (0 _{dec})
1C32:20	Sync error	The synchronization was not correct in the last cycle (outputs were output too late; DC mode only)	BOOLEAN	RO	0x00 (0 _{dec})

Index F000 Modular device profile

Index (hex)	Name	Meaning	Data type	Flags	Default
F000:0	Modular device profile	General information for the modular device profile	UINT8	RO	0x02 (2 _{dec})
F000:01	Module index distance	Index spacing of the objects of the individual channels	UINT16	RO	0x0010 (16 _{dec})
F000:02	Maximum number of modules	Number of channels	UINT16	RO	0x0003 (3 _{dec})

Index F008 Code word

Index (hex)	Name	Meaning	Data type	Flags	Default
F008:0	Code word	reserved	UINT32	RW	0x00000000 (0 _{dec})

17.4 Object description and parameterization - enhanced operation mode

i EtherCAT XML Device Description

The display matches that of the CoE objects from the EtherCAT XML Device Description. We recommend downloading the latest XML file from the download area of the Beckhoff website and installing it according to installation instructions.

NOTICE



Parameterization via the CoE list (CAN over EtherCAT)

The EtherCAT device is parameterized via the CoE - Online tab (with a double click on the respective object) or via the Process Data tab (assignment of PDOs). A detailed description can be found in the EtherCAT System-Documentation in chapter “[EtherCAT subscriber configuration](#)”

Please note the general CoE notes in the EtherCAT System Documentation in chapter “[CoE-interface](#)” when using/manipulating the CoE parameters:

- Keep a startup list if components have to be replaced
- Differentiation between online/offline dictionary,
- existence of current XML description
- use "CoE reload" for resetting changes

17.4.1 Restore object

Index 1011 Restore default parameters

Index (hex)	Name	Meaning	Data type	Flags	Default
1011:0	Restore default parameters [▶ 273]	Restore default parameters	UINT8	RO	0x01 (1 _{dec})
1011:01	SubIndex 001	If this object is set to “ 0x64616F6C ” in the set value dialog, all backup objects are reset to their delivery state.	UINT32	RW	0x00000000 (0 _{dec})

17.4.2 Configuration data

Index 8010 ENC Settings (EL5101, EL5101-0090)

Index (hex)	Name	Meaning	Data type	Flags	Default
8010:0	ENC Settings	Maximum subindex	UINT8	RO	0x17 (23 _{dec})
8010:01	Enable C reset [▶ 173]	The counter is reset via the C input.	BOOLEAN	RW	0x00 (0 _{dec})
8010:02	Enable extern reset [▶ 173]	A counter reset is triggered via the external latch input (24 V)	BOOLEAN	RW	0x00 (0 _{dec})
8010:03	Enable up/down counter [▶ 173]	Enablement of the up/down counter in place of the encoder with the bit set. Increments are counted at input A. Input B specifies the counting direction.	BOOLEAN	RW	0x00 (0 _{dec})
8010:04	Gate polarity [▶ 173]	0: Disable gate 1: Enable pos. gate (gate locks with HIGH level) 2: Enable neg. gate (gate locks with LOW level)	BIT2	RW	0x01 (1 _{dec})
8010:08	Disable filter	0: Activates the input filter (inputs A, /A, B, /B, C, /C only) 1: Deactivates the input filter If a filter is activated a signal edge must be present for at least 2.4 μs in order to be counted as an increment.	BOOLEAN	RW	0x01 (1 _{dec})
8010:0A	Enable micro increments [▶ 175]	If DC mode is activated, the terminal interpolates micro-increments between the integer encoder increments. The lower 8 bits of the counter value are used in each case for the display. A 32-bit counter thus becomes a 24+8-bit counter, a 16-bit counter becomes an 8+8-bit counter.	BOOLEAN	RW	0x00 (0 _{dec})
8010:0B	Open circuit detection A [▶ 174]	An open circuit on track A is indicated in index 0x6010:07 [▶ 179] and as process data. Diagnosis is only possible if the corresponding input is wired differentially. A differential voltage $-1.5\text{ V} > \text{Vid} > 1.5\text{ V}$ (typical, subject to change) is detected as a broken wire.	BOOLEAN	RW	0x01 (1 _{dec})
8010:0C	Open circuit detection B [▶ 174]	An open circuit on track B is indicated in index 0x6010:07 [▶ 179] and as process data. Diagnosis is only possible if the corresponding input is wired differentially. A differential voltage $-1.5\text{ V} > \text{Vid} > 1.5\text{ V}$ (typical, subject to change) is detected as a broken wire.	BOOLEAN	RW	0x01 (1 _{dec})
8010:0D	Open circuit detection C [▶ 174]	An open circuit on track C is indicated in index 0x6010:07 [▶ 179] and as process data. Diagnosis is only possible if the corresponding input is wired differentially. A differential voltage $-1.5\text{ V} > \text{Vid} > 1.5\text{ V}$ (typical, subject to change) is detected as a broken wire.	BOOLEAN	RW	0x00 (0 _{dec})
8010:0E	Reversion of rotation [▶ 173]	Activates reversion of rotation	BOOLEAN	RW	0x00 (0 _{dec})
8010:10	Extern reset polarity [▶ 173]	0: Fall (the counter is set to zero with a falling edge) 1: Rise (the counter is set to zero with a rising edge)	BIT1	RW	0x01 (1 _{dec})
8010:11	Frequency window [▶ 172]	This is the minimum time over which the frequency is determined. Default 10 ms [resolution: 1 μs] The number of pulses in the time window + the following is measured. The maximum waiting time is specified in the "Frequency Wait Time" parameter. The number of pulses is divided by the actual time window size. The determined frequency is output in index 0x6010:13 [▶ 179] and as a process data. The frequency calculation is carried out locally without distributed clocks function.	UINT16	RW	0x2710 (10000 _{dec})
8010:13	Frequency scaling [▶ 172]	Scaling of the frequency measurement (must be divided by this value to obtain the unit in Hz): 100: "0.01 Hz"	UINT16	RW	0x0064 (100 _{dec})

Index 8010 ENC Settings (EL5101, EL5101-0090)

Index (hex)	Name	Meaning	Data type	Flags	Default
8010:14	Period scaling [▶ 172]	Resolution of the period in the process data: 100: "100 ns" period value is a multiple of 100 ns 500: "500 ns" period value is a multiple of 500 ns	UINT16	RW	0x0064 (100 _{dec})
8010:15	Frequency resolution [▶ 172]	Resolution of the frequency measurement: 100: "0.01 Hz"	UINT16	RW	0x0064 (100 _{dec})
8010:16	Period resolution [▶ 172]	Internal resolution of the period measurement: 100: "100 ns" period value is a multiple of 100 ns The period is calculated internally with a resolution of 100 ns. The max. measurable period can then be approx. 1.6 seconds. 500: "500 ns" period value is a multiple of 500 ns Internally the period is calculated with 500 ns resolution. The maximum measurable period is approx. 32.7 ms. The resolution of process data continues to be the value according to index 0x8010:14 [▶ 244] (e.g. 100 ns [default]).	UINT16	RW	0x01F4 (500 _{dec})
8010:17	Frequency Wait Time [▶ 172]	Waiting time [ms] for frequency measurement Once the time specified in the frequency window [▶ 172] has elapsed, the system waits for the next positive edge from track A. This enables the update speed for the Frequency process data to be optimized, depending on the expected frequencies. At least double the period of the minimum frequency to be measured should be entered here. $t \geq 2 * (1 / f_{min})$	UINT16	RW	0x0640 (1600 _{dec})

17.4.3 Input data

Index 6010 ENC Inputs (EL5101-0090)

Index (hex)	Name	Meaning	Data type	Flags	Default
6010:0	ENC Inputs	Maximum subindex	UINT8	RO	0x1E (30 _{dec})
6010:01	Latch C valid [▶ 200]	The counter value was locked with the "C" input. The data with index 0x6010:12 [▶ 246] match the latched value when the bit is set. To reactivate the latch input, index 0x7010:01 [▶ 247] must be cancelled and then reset.	BOOLEAN	RO	0x00 (0 _{dec})
6010:02	Latch extern valid [▶ 200]	The counter value was locked via the external latch. The data with index 0x6010:12 [▶ 246] match the latched value when the bit is set. To reactivate the latch input, index 0x7000:02 [▶ 247] or object index 0x7000:04 [▶ 247] must be cancelled and then reset.	BOOLEAN	RO	0x00 (0 _{dec})
6010:03	Set counter done	The counter was set.	BOOLEAN	RO	0x00 (0 _{dec})
6010:04	Counter underflow [▶ 174]	Counter underflow. Overflow/underflow control is inactive in combination with a reset function (C/external).	BOOLEAN	RO	0x00 (0 _{dec})
6010:05	Counter overflow [▶ 174]	Counter overflow. Overflow/underflow control is inactive in combination with a reset function (C/external).	BOOLEAN	RO	0x00 (0 _{dec})
6010:06	Status of input status	State of the status input (alarm "input 1")	BOOLEAN	RO	0x00 (0 _{dec})
6010:07	Open circuit [▶ 174]	Indicates an open circuit. Configuration via index 0x8010:0A, [▶ 244] 0x8010:0B [▶ 244] , 0x8010:0C [▶ 244]	BOOLEAN	RO	0x00 (0 _{dec})
6010:08	Extrapolation stall [▶ 175]	The extrapolated part of the counter is invalid	BOOLEAN	RO	0x00 (0 _{dec})
6010:09	Status of input A	Status of input A	BOOLEAN	RO	0x00 (0 _{dec})
6010:0A	Status of input B	Status of input B	BOOLEAN	RO	0x00 (0 _{dec})
6010:0B	Status of input C	Status of input C	BOOLEAN	RO	0x00 (0 _{dec})
6010:0C	Status of input gate	The state of the gate input	BOOLEAN	RO	0x00 (0 _{dec})
6010:0D	Status of extern latch	Status of the extern latch input	BOOLEAN	RO	0x00 (0 _{dec})
6010:0E	Sync Error	The Sync error bit is only required for DC mode. It indicates whether a synchronization error has occurred during the previous cycle. This means a SYNC signal was triggered in the EL5101, although no new process data were available (0=OK, 1=NOK).	BOOLEAN	RO	0x00 (0 _{dec})
6010:0F	TxPDO State	Validity of the data of the associated TxPDO (0 = valid, 1 = invalid).	BOOLEAN	RO	0x00 (0 _{dec})
6010:10	TxPDO Toggle	The TxPDO toggle is toggled by the slave when the data of the associated TxPDO is updated.	BOOLEAN	RO	0x00 (0 _{dec})
6010:11	Counter value	Counter value	UINT32	RO	0x00000000 (0 _{dec})
6010:12	Latch value	Latch value	UINT32	RO	0x00000000 (0 _{dec})
6010:13	Frequency value [▶ 244]	The frequency (setting of the scaling and resolution in index 0x8010:13 [▶ 244] and 0x8010:15 [▶ 244])	UINT32	RO	0x00000000 (0 _{dec})
6010:14	Period value [▶ 244]	The period (setting of the scaling and resolution in index 0x8010:14 [▶ 244] and 0x8010:16 [▶ 244])	UINT32	RO	0x00000000 (0 _{dec})
6010:16	Timestamp [▶ 163]	Timestamp of the last counter change	UINT64	RO	
6010:1C	Frequency value (uint16)	Frequency (16-bit value)	UINT16	RO	0x0000 (0 _{dec})
6010:1D	Counter value (uint16)	Counter (16-bit value)	UINT16	RO	0x0000 (0 _{dec})
6010:1E	Period value (uint16)	Period (16-bit value)	UINT16	RO	0x0000 (0 _{dec})

17.4.4 Output data

Index 7010 ENC Outputs (EL5101, EL5101-0090)

Index (hex)	Name	Meaning	Data type	Flags	Default
7010:0	ENC Outputs	Maximum subindex	UINT8	RO	0x11 (17 _{dec})
7010:01	Enable latch C [▶ 200]	Activate latching via input "C".	BOOLEAN	RO	0x00 (0 _{dec})
7010:02	Enable latch extern on positive edge [▶ 200]	Activate external latch with positive edge.	BOOLEAN	RO	0x00 (0 _{dec})
7010:03	Set counter	Set counter	BOOLEAN	RO	0x00 (0 _{dec})
7010:04	Enable latch extern on negative edge [▶ 200]	Activate external latch with negative edge.	BOOLEAN	RO	0x00 (0 _{dec})
7010:11	Set counter value	The counter value to be set via "Set counter" (index 0x7010:03 [▶ 247]).	UINT32	RO	0x00000000 (0 _{dec})

17.4.5 Information / diagnostic data (channel specific)

Index A010 ENC Diag data (EL5101, EL5101-0090)

Index (hex)	Name	Meaning	Data type	Flags	Default
A010:0	ENC Diag data	Maximum subindex	UINT8	RO	0x03 (3 _{dec})
A010:01	Open circuit A [▶ 174]	Open circuit on track A	BOOLEAN	RO	0x00 (0 _{dec})
A010:02	Open circuit B [▶ 174]	Open circuit on track B	BOOLEAN	RO	0x00 (0 _{dec})
A010:03	Open circuit C [▶ 174]	Open circuit on track C	BOOLEAN	RO	0x00 (0 _{dec})

17.4.6 Standard objects

The standard objects have the same meaning for all EtherCAT slaves.

Index 1000 Device type

Index (hex)	Name	Meaning	Data type	Flags	Default
1000:0	Device type	Device type of the EtherCAT slave: the Lo-Word contains the CoE profile used (5001). The Hi-Word contains the module profile according to the modular device profile.	UINT32	RO	0x00001389 (5001 _{dec})

Index 1008 Device name

Index (hex)	Name	Meaning	Data type	Flags	Default
1008:0	Device name	Device name of the EtherCAT slave	STRING	RO	EL5101-0090

Index 1009 Hardware version

Index (hex)	Name	Meaning	Data type	Flags	Default
1009:0	Hardware version	Hardware version of the EtherCAT slave	STRING	RO	09

Index 100A Software version

Index (hex)	Name	Meaning	Data type	Flags	Default
100A:0	Software version	Firmware version of the EtherCAT slave	STRING	RO	10

Index 1018 Identity

Index (hex)	Name	Meaning	Data type	Flags	Default
1018:0	Identity	Information for identifying the slave	UINT8	RO	0x04 (4 _{dec})
1018:01	Vendor ID	Vendor ID of the EtherCAT slave	UINT32	RO	0x00000002 (2 _{dec})
1018:02	Product code	Product code of the EtherCAT slave	UINT32	RO	0x13ED3052 (334311506 _{dec})
1018:03	Revision	Revision number of the EtherCAT slave; the low word (bit 0-15) indicates the special terminal number, the high word (bit 16-31) refers to the device description	UINT32	RO	0x00000000 (0 _{dec})
1018:04	Serial number	Serial number of the EtherCAT slave; the low byte (bit 0-7) of the low word contains the year of production, the high byte (bit 8-15) of the low word contains the week of production, the high word (bit 16-31) is 0	UINT32	RO	0x00000000 (0 _{dec})

Index 10F0 Backup parameter handling

Index (hex)	Name	Meaning	Data type	Flags	Default
10F0:0	Backup parameter handling	Information for standardized loading and saving of backup entries	UINT8	RO	0x01 (1 _{dec})
10F0:01	Checksum	Checksum across all backup entries of the EtherCAT slave	UINT32	RO	0x00000000 (0 _{dec})

Index 1400 RxPDO-Par Outputs (EL5101-0090)

Index (hex)	Name	Meaning	Data type	Flags	Default
1400:0	RxPDO-Par Outputs	PDO Parameter RxPDO 1	UINT8	RO	0x06 (6 _{dec})
1400:06	Exclude RxPDOs	Specifies the RxPDOs (index of RxPDO mapping objects) that must not be transferred together with RxPDO 1	OCTET-STRING[8]	RO	01 16 02 16 03 16 10 16

Index 1401 RxPDO-Par Outputs Word-Aligned (EL5101-0090)

Index (hex)	Name	Meaning	Data type	Flags	Default
1401:0	RxPDO-Par Outputs Word-Aligned	PDO Parameter RxPDO 2	UINT8	RO	0x06 (6 _{dec})
1401:06	Exclude RxPDOs	Specifies the RxPDOs (index of RxPDO mapping objects) that must not be transferred together with RxPDO 2	OCTET-STRING[8]	RO	00 16 02 16 03 16 10 16

Index 1402 ENC RxPDO-Par Control compact (EL5101-0090)

Index (hex)	Name	Meaning	Data type	Flags	Default
1402:0	ENC RxPDO-Par Control compact	PDO Parameter RxPDO 3	UINT8	RO	0x06 (6 _{dec})
1402:06	Exclude RxPDOs	Specifies the RxPDOs (index of RxPDO mapping objects) that must not be transferred together with RxPDO 3	OCTET-STRING[8]	RO	03 16 00 16 01 16 00 00

Index 1403 ENC RxPDO-Par Control (EL5101-0090)

Index (hex)	Name	Meaning	Data type	Flags	Default
1403:0	ENC RxPDO-Par Control	PDO Parameter RxPDO 4	UINT8	RO	0x06 (6 _{dec})
1403:06	Exclude RxPDOs	Specifies the RxPDOs (index of RxPDO mapping objects) that must not be transferred together with RxPDO 4	OCTET-STRING[8]	RO	02 16 00 16 01 16 00 00

Index 1600 RxPDO-Map Outputs (EL5101, EL5101-0090)

Index (hex)	Name	Meaning	Data type	Flags	Default
1600:0	RxPDO-Map Outputs	PDO Mapping RxPDO 1	UINT8	RO	0x02 (2 _{dec})
1600:01	SubIndex 001	1. PDO Mapping entry (object 0x7000 (Outputs), entry 0x01 (Ctrl))	UINT32	RO	0x7000:01, 8
1600:02	SubIndex 002	2. PDO Mapping entry (object 0x7000 (Outputs), entry 0x02 (Value))	UINT32	RO	0x7000:02, 16

Index 1601 RxPDO-Map Outputs Word-Aligned (EL5101, EL5101-0090)

Index (hex)	Name	Meaning	Data type	Flags	Default
1601:0	RxPDO-Map Outputs Word-Aligned	PDO Mapping RxPDO 2	UINT8	RO	0x03 (3 _{dec})
1601:01	SubIndex 001	1. PDO Mapping entry (object 0x7000 (Outputs), entry 0x01 (Ctrl))	UINT32	RO	0x7000:01, 8
1601:02	SubIndex 002	2. PDO Mapping entry (8 bits align)	UINT32	RO	0x0000:00, 8
1601:03	SubIndex 003	3. PDO Mapping entry (object 0x7000 (Outputs), entry 0x02 (Value))	UINT32	RO	0x7000:02, 16

Index 1602 ENC RxPDO-Map Control compact (EL5101, EL5101-0090)

Index (hex)	Name	Meaning	Data type	Flags	Default
1602:0	ENC RxPDO-Map Control compact	PDO Mapping RxPDO 3	UINT8	RO	0x07 (7 _{dec})
1602:01	SubIndex 001	1. PDO Mapping entry (object 0x7010 (ENC Outputs), entry 0x01 (Enable latch C))	UINT32	RO	0x7010:01, 1
1602:02	SubIndex 002	2. PDO Mapping entry (object 0x7010 (ENC Outputs), entry 0x02 (Enable latch extern on positive edge))	UINT32	RO	0x7010:02, 1
1602:03	SubIndex 003	3. PDO Mapping entry (object 0x7010 (ENC Outputs), entry 0x03 (Set counter))	UINT32	RO	0x7010:03, 1
1602:04	SubIndex 004	4. PDO Mapping entry (object 0x7010 (ENC Outputs), entry 0x04 (Enable latch extern on negative edge))	UINT32	RO	0x7010:04, 1
1602:05	SubIndex 005	5. PDO Mapping entry (4 bits align)	UINT32	RO	0x0000:00, 4
1602:06	SubIndex 006	6. PDO Mapping entry (8 bits align)	UINT32	RO	0x0000:00, 8
1602:07	SubIndex 007	7. PDO Mapping entry (object 0x7010 (ENC Outputs), entry 0x11 (Set counter value))	UINT32	RO	0x7010:11, 16

Index 1603 ENC RxPDO-Map Control (EL5101, EL5101-0090)

Index (hex)	Name	Meaning	Data type	Flags	Default
1603:0	ENC RxPDO-Map Control	PDO Mapping RxPDO 4	UINT8	RO	0x07 (7 _{dec})
1603:01	SubIndex 001	1. PDO Mapping entry (object 0x7010 (ENC Outputs), entry 0x01 (Enable latch C))	UINT32	RO	0x7010:01, 1
1603:02	SubIndex 002	2. PDO Mapping entry (object 0x7010 (ENC Outputs), entry 0x02 (Enable latch extern on positive edge))	UINT32	RO	0x7010:02, 1
1603:03	SubIndex 003	3. PDO Mapping entry (object 0x7010 (ENC Outputs), entry 0x03 (Set counter))	UINT32	RO	0x7010:03, 1
1603:04	SubIndex 004	4. PDO Mapping entry (object 0x7010 (ENC Outputs), entry 0x04 (Enable latch extern on negative edge))	UINT32	RO	0x7010:04, 1
1603:05	SubIndex 005	5. PDO Mapping entry (4 bits align)	UINT32	RO	0x0000:00, 4
1603:06	SubIndex 006	6. PDO Mapping entry (8 bits align)	UINT32	RO	0x0000:00, 8
1603:07	SubIndex 007	7. PDO Mapping entry (object 0x7010 (ENC Outputs), entry 0x11 (Set counter value))	UINT32	RO	0x7010:11, 32

Index 1800 TxPDO-Par Inputs (EL5101-0090)

Index (hex)	Name	Meaning	Data type	Flags	Default
1800:0	TxPDO-Par Inputs	PDO Parameter TxPDO 1	UINT8	RO	0x06 (6 _{dec})
1800:06	Exclude TxPDOs	Specifies the TxPDOs (index of TxPDO mapping objects) that must not be transferred together with TxPDO 1	OCTET-STRING[16]	RO	01 1A 03 1A 04 1A 05 1A 06 1A 07 1A 08 1A 11 1A

Index 1801 TxPDO-Par Inputs Word-Aligned (EL5101-0090)

Index (hex)	Name	Meaning	Data type	Flags	Default
1801:0	TxPDO-Par Inputs Word-Aligned	PDO Parameter TxPDO 2	UINT8	RO	0x06 (6 _{dec})
1801:06	Exclude TxPDOs	Specifies the TxPDOs (index of TxPDO mapping objects) that must not be transferred together with TxPDO 2	OCTET-STRING[16]	RO	00 1A 03 1A 04 1A 05 1A 06 1A 07 1A 08 1A 10 1A

Index 1802 TxPDO-Par Inputs Optional (EL5101-0090)

Index (hex)	Name	Meaning	Data type	Flags	Default
1802:0	TxPDO-Par Inputs Optional	PDO Parameter TxPDO 3	UINT8	RO	0x06 (6 _{dec})
1802:06	Exclude TxPDOs	Specifies the TxPDOs (index of TxPDO mapping objects) that must not be transferred together with TxPDO 3	OCTET-STRING[16]	RO	03 1A 04 1A 05 1A 06 1A 07 1A 08 1A 00 00

Index 1803 ENC TxPDO-Par Status compact (EL5101-0090)

Index (hex)	Name	Meaning	Data type	Flags	Default
1803:0	ENC TxPDO-Par Status compact	PDO Parameter TxPDO 4	UINT8	RO	0x06 (6 _{dec})
1803:06	Exclude TxPDOs	Specifies the TxPDOs (index of TxPDO mapping objects) that must not be transferred together with TxPDO 4	OCTET-STRING[16]	RO	04 1A 00 1A 01 1A 02 1A 00 00 00 00 00 00 00

Index 1804 ENC TxPDO-Par Status (EL5101-0090)

Index (hex)	Name	Meaning	Data type	Flags	Default
1804:0	ENC TxPDO-Par Status	PDO Parameter TxPDO 5	UINT8	RO	0x06 (6 _{dec})
1804:06	Exclude TxPDOs	Specifies the TxPDOs (index of TxPDO mapping objects) that must not be transferred together with TxPDO 5	OCTET-STRING[16]	RO	03 1A 00 1A 01 1A 02 1A 00 00 00 00 00 00 00

Index 1805 ENC TxPDO-Par Frequency (EL5101-0090)

Index (hex)	Name	Meaning	Data type	Flags	Default
1805:0	ENC TxPDO-Par Frequency	PDO Parameter TxPDO 6	UINT8	RO	0x06 (6 _{dec})
1805:06	Exclude TxPDOs	Specifies the TxPDOs (index of TxPDO mapping objects) that must not be transferred together with TxPDO 6	OCTET-STRING[16]	RO	00 1A 01 1A 02 1A 06 1A 00 00 00 00 00 00 00

Index 1806 ENC TxPDO-Par Period (EL5101-0000)

Index (hex)	Name	Meaning	Data type	Flags	Default
1806:0	ENC TxPDO-Par Period	PDO Parameter TxPDO 7	UINT8	RO	0x06 (6 _{dec})
1806:06	Exclude TxPDOs	Specifies the TxPDOs (index of TxPDO mapping objects) that must not be transferred together with TxPDO 7	OCTET-STRING[16]	RO	00 1A 01 1A 02 1A 05 1A 00 00 00 00 00 00 00

Index 1807 ENC TxPDO-Par Timest. (EL5101-0090)

Index (hex)	Name	Meaning	Data type	Flags	Default
1807:0	ENC TxPDO-Par Timest.	PDO Parameter TxPDO 8	UINT8	RO	0x06 (6 _{dec})
1807:06	Exclude TxPDOs	Specifies the TxPDOs (index of TxPDO mapping objects) that must not be transferred together with TxPDO 8	OCTET-STRING[16]	RO	08 1A 00 1A 01 1A 02 1A 00 00 00 00 00 00 00

Index 1808 ENC TxPDO-Par Timest. compact (EL5101-0090)

Index (hex)	Name	Meaning	Data type	Flags	Default
1808:0	ENC TxPDO-Par Timest. compact	PDO Parameter TxPDO 9	UINT8	RO	0x06 (6 _{dec})
1808:06	Exclude TxPDOs	Specifies the TxPDOs (index of TxPDO mapping objects) that must not be transferred together with TxPDO 9	OCTET-STRING[16]	RO	07 1A 00 1A 01 1A 02 1A 00 00 00 00 00 00 00

Index 1A00 TxPDO-Map Inputs (EL5101, EL5101-0090)

Index (hex)	Name	Meaning	Data type	Flags	Default
1A00:0	TxPDO-Map Inputs	PDO Mapping TxPDO 1	UINT8	RO	0x03 (3 _{dec})
1A00:01	SubIndex 001	1. PDO Mapping entry (object 0x6000 (Inputs), entry 0x01 (Status))	UINT32	RO	0x6000:01, 8
1A00:02	SubIndex 002	2. PDO Mapping entry (object 0x6000 (Inputs), entry 0x02 (Value))	UINT32	RO	0x6000:02, 16
1A00:03	SubIndex 003	3. PDO Mapping entry (object 0x6000 (Inputs), entry 0x03 (Latch))	UINT32	RO	0x6000:03, 16

Index 1A01 TxPDO-Map Inputs Word-Aligned (EL5101, EL5101-0090)

Index (hex)	Name	Meaning	Data type	Flags	Default
1A01:0	TxPDO-Map Inputs Word-Aligned	PDO Mapping TxPDO 2	UINT8	RO	0x04 (4 _{dec})
1A01:01	SubIndex 001	1. PDO Mapping entry (object 0x6000 (Inputs), entry 0x01 (Status))	UINT32	RO	0x6000:01, 8
1A01:02	SubIndex 002	2. PDO Mapping entry (8 bits align)	UINT32	RO	0x0000:00, 8
1A01:03	SubIndex 003	3. PDO Mapping entry (object 0x6000 (Inputs), entry 0x02 (Value))	UINT32	RO	0x6000:02, 16
1A01:04	SubIndex 004	4. PDO Mapping entry (object 0x6000 (Inputs), entry 0x03 (Latch))	UINT32	RO	0x6000:03, 16

Index 1A02 TxPDO-Map Inputs Optional (EL5101, EL5101-0090)

Index (hex)	Name	Meaning	Data type	Flags	Default
1A02:0	TxPDO-Map Inputs Optional	PDO Mapping TxPDO 3	UINT8	RO	0x03 (3 _{dec})
1A02:01	SubIndex 001	1. PDO Mapping entry (object 0x6000 (Inputs), entry 0x04 (Frequency))	UINT32	RO	0x6000:04, 32
1A02:02	SubIndex 002	2. PDO Mapping entry (object 0x6000 (Inputs), entry 0x05 (Period))	UINT32	RO	0x6000:05, 16
1A02:03	SubIndex 003	3. PDO Mapping entry (object 0x6000 (Inputs), entry 0x06 (Window))	UINT32	RO	0x6000:06, 16

Index 1A03 ENC TxPDO-Map Status compact (EL5101, EL5101-0090)

Index (hex)	Name	Meaning	Data type	Flags	Default
1A03:0	ENC TxPDO-Map Status compact	PDO Mapping TxPDO 4	UINT8	RO	0x12 (18 _{dec})
1A03:01	SubIndex 001	1. PDO Mapping entry (object 0x6010 (ENC Inputs), entry 0x01 (Latch C valid))	UINT32	RO	0x6010:01, 1
1A03:02	SubIndex 002	2. PDO Mapping entry (object 0x6010 (ENC Inputs), entry 0x02 (Latch extern valid))	UINT32	RO	0x6010:02, 1
1A03:03	SubIndex 003	3. PDO Mapping entry (object 0x6010 (ENC Inputs), entry 0x03 (Set counter done))	UINT32	RO	0x6010:03, 1
1A03:04	SubIndex 004	4. PDO Mapping entry (object 0x6010 (ENC Inputs), entry 0x04 (Counter underflow))	UINT32	RO	0x6010:04, 1
1A03:05	SubIndex 005	5. PDO Mapping entry (object 0x6010 (ENC Inputs), entry 0x05 (Counter overflow))	UINT32	RO	0x6010:05, 1
1A03:06	SubIndex 006	6. PDO Mapping entry (object 0x6010 (ENC Inputs), entry 0x06 (Status of input status))	UINT32	RO	0x6010:06, 1
1A03:07	SubIndex 007	7. PDO Mapping entry (object 0x6010 (ENC Inputs), entry 0x07 (Open circuit))	UINT32	RO	0x6010:07, 1
1A03:08	SubIndex 008	8. PDO Mapping entry (object 0x6010 (ENC Inputs), entry 0x08 (Extrapolation stall))	UINT32	RO	0x6010:08, 1
1A03:09	SubIndex 009	9. PDO Mapping entry (object 0x6010 (ENC Inputs), entry 0x09 (Status of input A))	UINT32	RO	0x6010:09, 1
1A03:0A	SubIndex 010	10. PDO Mapping entry (object 0x6010 (ENC Inputs), entry 0x0A (Status of input B))	UINT32	RO	0x6010:0A, 1
1A03:0B	SubIndex 011	11. PDO Mapping entry (object 0x6010 (ENC Inputs), entry 0x0B (Status of input C))	UINT32	RO	0x6010:0B, 1
1A03:0C	SubIndex 012	12. PDO Mapping entry (object 0x6010 (ENC Inputs), entry 0x0C (Status of input gate))	UINT32	RO	0x6010:0C, 1
1A03:0D	SubIndex 013	13. PDO Mapping entry (object 0x6010 (ENC Inputs), entry 0x0D (Status of extern latch))	UINT32	RO	0x6010:0D, 1
1A03:0E	SubIndex 014	14. PDO Mapping entry (object 0x1C32 (SM output parameter), entry 0x20 (Sync error))	UINT32	RO	0x6010:0E:20, 1
1A03:0F	SubIndex 015	15. PDO Mapping entry (object 0x1803 (ENC TxPDO-Par Status compact), entry 0x07 (TxPDO-State))	UINT32	RO	0x6010:0F, 1
1A03:10	SubIndex 016	16. PDO Mapping entry (object 0x1803 (ENC TxPDO-Par Status compact), entry 0x09 (TxPDO-Toggle))	UINT32	RO	0x6010:10, 1
1A03:11	SubIndex 017	17. PDO Mapping entry (object 0x6010 (ENC Inputs), entry 0x11 (Counter value))	UINT32	RO	0x6010:11, 16
1A03:12	SubIndex 018	18. PDO Mapping entry (object 0x6010 (ENC Inputs), entry 0x12 (Latch value))	UINT32	RO	0x6010:12, 16

Index 1A04 ENC TxPDO-Map Status (EL5101, EL5101-0090)

Index (hex)	Name	Meaning	Data type	Flags	Default
1A04:0	ENC TxPDO-Map Status	PDO Mapping TxPDO 5	UINT8	RO	0x12 (18 _{dec})
1A04:01	SubIndex 001	1. PDO Mapping entry (object 0x6010 (ENC Inputs), entry 0x01 (Latch C valid))	UINT32	RO	0x6010:01, 1
1A04:02	SubIndex 002	2. PDO Mapping entry (object 0x6010 (ENC Inputs), entry 0x02 (Latch extern valid))	UINT32	RO	0x6010:02, 1
1A04:03	SubIndex 003	3. PDO Mapping entry (object 0x6010 (ENC Inputs), entry 0x03 (Set counter done))	UINT32	RO	0x6010:03, 1
1A04:04	SubIndex 004	4. PDO Mapping entry (object 0x6010 (ENC Inputs), entry 0x04 (Counter underflow))	UINT32	RO	0x6010:04, 1
1A04:05	SubIndex 005	5. PDO Mapping entry (object 0x6010 (ENC Inputs), entry 0x05 (Counter overflow))	UINT32	RO	0x6010:05, 1
1A04:06	SubIndex 006	6. PDO Mapping entry (object 0x6010 (ENC Inputs), entry 0x06 (Status of input status))	UINT32	RO	0x6010:06, 1
1A04:07	SubIndex 007	7. PDO Mapping entry (object 0x6010 (ENC Inputs), entry 0x07 (Open circuit))	UINT32	RO	0x6010:07, 1
1A04:08	SubIndex 008	8. PDO Mapping entry (object 0x6010 (ENC Inputs), entry 0x08 (Extrapolation stall))	UINT32	RO	0x6010:08, 1
1A04:09	SubIndex 009	9. PDO Mapping entry (object 0x6010 (ENC Inputs), entry 0x09 (Status of input A))	UINT32	RO	0x6010:09, 1
1A04:0A	SubIndex 010	10. PDO Mapping entry (object 0x6010 (ENC Inputs), entry 0x0A (Status of input B))	UINT32	RO	0x6010:0A, 1
1A04:0B	SubIndex 011	11. PDO Mapping entry (object 0x6010 (ENC Inputs), entry 0x0B (Status of input C))	UINT32	RO	0x6010:0B, 1
1A04:0C	SubIndex 012	12. PDO Mapping entry (object 0x6010 (ENC Inputs), entry 0x0C (Status of input gate))	UINT32	RO	0x6010:0C, 1
1A04:0D	SubIndex 013	13. PDO Mapping entry (object 0x6010 (ENC Inputs), entry 0x0D (Status of extern latch))	UINT32	RO	0x6010:0D, 1
1A04:0E	SubIndex 014	14. PDO Mapping entry (object 0x1C32 (SM output parameter), entry 0x20 (Sync error))	UINT32	RO	0x6010:0E, 1
1A04:0F	SubIndex 015	15. PDO Mapping entry (object 0x1804 (ENC TxPDO-Par Status), entry 0x07 (TxPDO-State))	UINT32	RO	0x6010:0F, 1
1A04:10	SubIndex 016	16. PDO Mapping entry (object 0x1804 (ENC TxPDO-Par Status), entry 0x09 (TxPDO-Toggle))	UINT32	RO	0x6010:10, 1
1A04:11	SubIndex 017	17. PDO Mapping entry (object 0x6010 (ENC Inputs), entry 0x11 (Counter value))	UINT32	RO	0x6010:11, 32
1A04:12	SubIndex 018	18. PDO Mapping entry (object 0x6010 (ENC Inputs), entry 0x12 (Latch value))	UINT32	RO	0x6010:12, 32

Index 1A05 ENC TxPDO-Map Frequency (EL5101, EL5101-0090)

Index (hex)	Name	Meaning	Data type	Flags	Default
1A05:0	ENC TxPDO-Map Frequency	PDO Mapping TxPDO 6	UINT8	RO	0x01 (1 _{dec})
1A05:01	SubIndex 001	1. PDO Mapping entry (object 0x6010 (ENC Inputs), entry 0x13 (Frequency value))	UINT32	RO	0x6010:13, 32

Index 1A06 ENC TxPDO-Map Period (EL5101, EL5101-0090)

Index (hex)	Name	Meaning	Data type	Flags	Default
1A06:0	ENC TxPDO-Map Period	PDO Mapping TxPDO 7	UINT8	RO	0x01 (1 _{dec})
1A06:01	SubIndex 001	1. PDO Mapping entry (object 0x6010 (ENC Inputs), entry 0x14 (Period value))	UINT32	RO	0x6010:14, 32

Index 1A07 ENC TxPDO-Map Timest. (EL5101, EL5101-0090)

Index (hex)	Name	Meaning	Data type	Flags	Default
1A07:0	ENC TxPDO-Map Timest.	PDO Mapping TxPDO 8	UINT8	RO	0x01 (1 _{dec})
1A07:01	SubIndex 001	1. PDO Mapping entry (object 0x6010 (ENC Inputs), entry 0x16 (Timestamp))	UINT32	RO	0x6010:16, 64

Index 1A08 ENC TxPDO-Map Timest. compact (EL5101, EL5101-0090)

Index (hex)	Name	Meaning	Data type	Flags	Default
1A08:0	ENC TxPDO-Map Timest. compact	PDO Mapping TxPDO 9	UINT8	RO	0x01 (1 _{dec})
1A08:01	SubIndex 001	1. PDO Mapping entry (object 0x6010 (ENC Inputs), entry 0x16 (Timestamp))	UINT32	RO	0x6010:16, 32

Index 1C00 Sync manager type

Index (hex)	Name	Meaning	Data type	Flags	Default
1C00:0	Sync manager type	Using the sync managers	UINT8	RO	0x04 (4 _{dec})
1C00:01	SubIndex 001	Sync-Manager Type Channel 1: Mailbox Write	UINT8	RO	0x01 (1 _{dec})
1C00:02	SubIndex 002	Sync-Manager Type Channel 2: Mailbox Read	UINT8	RO	0x02 (2 _{dec})
1C00:03	SubIndex 003	Sync-Manager Type Channel 3: Process Data Write (Outputs)	UINT8	RO	0x03 (3 _{dec})
1C00:04	SubIndex 004	Sync-Manager Type Channel 4: Process Data Read (Inputs)	UINT8	RO	0x04 (4 _{dec})

Index 1C12 RxPDO assign

Index (hex)	Name	Meaning	Data type	Flags	Default
1C12:0	RxPDO assign	PDO Assign Outputs	UINT8	RW	0x02 (2 _{dec})
1C12:01	SubIndex 001	1 st allocated RxPDO (contains the index of the associated RxPDO mapping object)	UINT16	RW	0x1600 (5632 _{dec})
1C12:02	SubIndex 002	1 st allocated RxPDO (contains the index of the associated RxPDO mapping object)	UINT16	RW	0x1610 (5648 _{dec})

Index 1C13 TxPDO assign

Index (hex)	Name	Meaning	Data type	Flags	Default
1C13:0	TxPDO assign	PDO Assign Inputs	UINT8	RW	0x01 (1 _{dec})
1C13:01	SubIndex 001	1 st allocated TxPDO (contains the index of the associated TxPDO mapping object)	UINT16	RW	0x1A00 (6656 _{dec})
1C13:02	SubIndex 002	2 nd allocated TxPDO (contains the index of the associated TxPDO mapping object)	UINT16	RW	0x1A10 (6672 _{dec})
1C13:03	SubIndex 003	2 nd allocated TxPDO (contains the index of the associated TxPDO mapping object)	UINT16	RW	0x0000 (0 _{dec})
1C13:04	SubIndex 004	3 rd allocated TxPDO (contains the index of the associated TxPDO mapping object)	UINT16	RW	0x0000 (0 _{dec})

Index 1C32 SM output parameter

Index (hex)	Name	Meaning	Data type	Flags	Default
1C32:0	SM output parameter	Synchronization parameters for the outputs	UINT8	RO	0x20 (32 _{dec})
1C32:01	Sync mode	Current synchronization mode: <ul style="list-style-type: none"> • 0: Free Run • 1: Synchron with SM 2 Event • 2: DC-Mode - Synchron with SYNC0 Event • 3: DC-Mode - Synchron with SYNC1 Event 	UINT16	RW	0x0001 (1 _{dec})
1C32:02	Cycle time	Cycle time (in ns): <ul style="list-style-type: none"> • Free Run: Cycle time of the local timer • Synchronous with SM 2 event: Master cycle time • DC mode: SYNC0/SYNC1 Cycle Time 	UINT32	RW	0x000F4240 (1000000 _{dec})
1C32:03	Shift time	Time between SYNC0 event and output of the outputs (in ns, DC mode only)	UINT32	RO	0x00000000 (0 _{dec})
1C32:04	Sync modes supported	Supported synchronization modes: <ul style="list-style-type: none"> • Bit 0 = 1: free run is supported • Bit 1 = 1: Synchronous with SM 2 event is supported • Bit 2-3 = 01: DC mode is supported • Bit 4-5 = 10: Output shift with SYNC1 event (only DC mode) • Bit 14 = 1: dynamic times (measurement through writing of 0x1C32:08 [▶ 255]) 	UINT16	RO	0x4807 (18439 _{dec})
1C32:05	Minimum cycle time	Minimum cycle time (in ns)	UINT32	RO	0x000103C4 (66500 _{dec})
1C32:06	Calc and copy time	Minimum time between SYNC0 and SYNC1 event (in ns, DC mode only)	UINT32	RO	0x00000000 (0 _{dec})
1C32:07	Minimum delay time		UINT32	RO	0x00000000 (0 _{dec})
1C32:08	Command	<ul style="list-style-type: none"> • 0: Measurement of the local cycle time is stopped • 1: Measurement of the local cycle time is started <p>The entries 0x1C32:03 [▶ 255], 0x1C32:05 [▶ 255], 0x1C32:06 [▶ 255], 0x1C32:09 [▶ 255], 0x1C33:03, 0x1C33:06 [▶ 255], 0x1C33:09 are updated with the maximum measured values. For a subsequent measurement the measured values are reset</p>	UINT16	RW	0x0000 (0 _{dec})
1C32:09	Delay time	Time between SYNC1 event and output of the outputs (in ns, DC mode only)	UINT32	RO	0x00000000 (0 _{dec})
1C32:0B	SM event missed counter	Number of missed SM events in OPERATIONAL (DC mode only)	UINT16	RO	0x0000 (0 _{dec})
1C32:0C	Cycle exceeded counter	Number of occasions the cycle time was exceeded in OPERATIONAL (cycle was not completed in time or the next cycle began too early)	UINT16	RO	0x0000 (0 _{dec})
1C32:0D	Shift too short counter	Number of occasions that the interval between SYNC0 and SYNC1 event was too short (DC mode only)	UINT16	RO	0x0000 (0 _{dec})
1C32:20	Sync error	The synchronization was not correct in the last cycle (outputs were output too late; DC mode only)	BOOLEAN	RO	0x00 (0 _{dec})

Index 1C33 SM input parameter

Index (hex)	Name	Meaning	Data type	Flags	Default
1C33:0	SM input parameter	Synchronization parameters for the inputs	UINT8	RO	0x20 (32 _{dec})
1C33:01	Sync mode	Current synchronization mode: <ul style="list-style-type: none"> 0: Free Run 1: Synchronous with SM 3 event (no outputs available) 2: DC - Synchron with SYNC0 Event 3: DC - Synchron with SYNC1 Event 34: Synchronous with SM 2 event (outputs available) 	UINT16	RW	0x0022 (34 _{dec})
1C33:02	Cycle time	as 0x1C32:02 > 211]	UINT32	RW	0x000F4240 (0 _{dec})
1C33:03	Shift time	Time between SYNC0 event and reading of the inputs (in ns, only DC mode)	UINT32	RO	0x00000000 (0 _{dec})
1C33:04	Sync modes supported	Supported synchronization modes: <ul style="list-style-type: none"> Bit 0: free run is supported Bit 1: synchronous with SM 2 event is supported (outputs available) Bit 1: synchronous with SM 3 event is supported (no outputs available) Bit 2-3 = 01: DC mode is supported Bit 4-5 = 01: input shift through local event (outputs available) Bit 4-5 = 10: input shift with SYNC1 event (no outputs available) Bit 14 = 1: dynamic times (measurement through writing of 0x1C32:08 > 211] or 0x1C33:08 > 256]) 	UINT16	RO	0x4807 (18439 _{dec})
1C33:05	Minimum cycle time	as 0x1C32:05 > 211]	UINT32	RO	0x000103C4 (66500 _{dec})
1C33:06	Calc and copy time	Time between reading of the inputs and availability of the inputs for the master (in ns, only DC mode)	UINT32	RO	0x00000000 (0 _{dec})
1C33:07	Minimum delay time		UINT32	RO	0x000103C14 (66500 _{dec})
1C33:08	Command	as 0x1C32:08 > 211]	UINT16	RW	0x0000 (0 _{dec})
1C33:09	Delay time	Time between SYNC1 event and reading of the inputs (in ns, only DC mode)	UINT32	RO	0x00000000 (0 _{dec})
1C33:0B	SM event missed counter	as 0x1C32:11 > 211]	UINT16	RO	0x0000 (0 _{dec})
1C33:0C	Cycle exceeded counter	as 0x1C32:12 > 211]	UINT16	RO	0x0000 (0 _{dec})
1C33:0D	Shift too short counter	as 0x1C32:13 > 211]	UINT16	RO	0x0000 (0 _{dec})
1C33:20	Sync error	as 0x1C32:32 > 211]	BOOLEAN	RO	0x00 (0 _{dec})

Index F000 Modular device profile

Index (hex)	Name	Meaning	Data type	Flags	Default
F000:0	Modular device profile	General information for the modular device profile	UINT8	RO	0x02 (2 _{dec})
F000:01	Module index distance	Index spacing of the objects of the individual channels	UINT16	RO	0x0010 (16 _{dec})
F000:02	Maximum number of modules	Number of channels	UINT16	RO	0x0003 (3 _{dec})

Index F008 Code word

Index (hex)	Name	Meaning	Data type	Flags	Default
F008:0	Code word	reserved	UINT32	RW	0x00000000 (0 _{dec})

Index F010 Module list

Index (hex)	Name	Meaning	Data type	Flags	Default
F010:0	Module list	Maximum subindex	UINT8	RW	0x02 (2 _{dec})
F010:01	SubIndex 001	reserved	UINT32	RW	0x000001FE (510 _{dec})
F010:02	SubIndex 002	reserved	UINT32	RW	0x000001FF (511 _{dec})
F010:03	SubIndex 003	reserved	UINT32	RW	0x000003B6 (950 _{dec})

Index F082 MDP Profile Compatibility

Index (hex)	Name	Meaning	Data type	Flags	Default
F082:0	Module list	Maximum subindex	UINT8	RW	0x01 (1 _{dec})
F082:01	SubIndex 001	reserved	UINT32	RW	0x00 (0 _{dec})

17.5 Objects TwinSAFE Single Channel (EL5101-0090)

Index 1410 TSC RxPDO-Par Master Message

Index (hex)	Name	Meaning	Data type	Flags	Default
1410:0	TSC RxPDO-Map Master Message	PDO Parameter RxPDO 17	UINT8	RO	0x06 (6 _{dec})
1410:06	Exclude RxPDOs	Specifies the RxPDOs (index of RxPDO mapping objects) which must not be transferred together with this PDO.	OCTET-STRING[8]	RO	00 16 01 16 00 00 00 00

Index 1610 TSC RxPDO-Map Master Message

Index (hex)	Name	Meaning	Data type	Flags	Default
1610:0	TSC RxPDO-Map Master Message	PDO Mapping RxPDO 17	UINT8	RO	0x04 (4 _{dec})
1610:01	SubIndex 001	1. PDO Mapping entry (object 0x7020 (TSC Master Frame Elements), entry 0x01 (TSC__Master Cmd))	UINT32	RO	0x7020:01, 8
1610:02	SubIndex 002	2. PDO Mapping entry (8 bits align)	UINT32	RO	0x0000:00, 8
1610:03	SubIndex 003	3. PDO Mapping entry (object 0x7020 (TSC Master Frame Elements), entry 0x03 (TSC__Master CRC_0))	UINT32	RO	0x7020:03, 16
1610:04	SubIndex 004	4. PDO Mapping entry (object 0x7020 (TSC Master Frame Elements), entry 0x02 (TSC__Master ConnID))	UINT32	RO	0x7020:02, 16

Index 1810 TSC TxPDO-Par Slave Message

Index (hex)	Name	Meaning	Data type	Flags	Default
1810:0	TSC TxPDO-Par Slave Message	PDO Mapping TxPDO 17	UINT8	RO	0x06 (6 _{dec})
1810:06	Exclude TxPDOs	Specifies the TxPDOs (index of TxPDO mapping objects) which must not be transferred together with this PDO	OCTET-STRING[16]	RO	00 1A 01 1A 02 1A 00 00 00 00 00 00 00 00 00 00

Index 1A10 TSC TxPDO-Map Slave Message

Index (hex)	Name	Meaning	Data type	Flags	Default
1A10:0	TSC TxPDO-Map Slave Message	PDO Mapping TxPDO	UINT8	RW	0x14 (20 _{dec})
1A10:01	SubIndex 001	1. PDO Mapping entry (object 0x6020 (TSC Slave Frame Elements), entry 0x01 (TSC__Slave Cmd))	UINT32	RW	0x6020:01, 8
1A10:02	SubIndex 002	2. PDO Mapping entry (object 0x6010 (ENC Inputs), entry 0x11 (Counter value))	UINT32	RW	0x6010:11, 16
1A10:03	SubIndex 003	3. PDO Mapping entry (object 0x6020 (TSC Slave Frame Elements), entry 0x03 (TSC__Slave CRC_0))	UINT32	RW	0x6020:03, 16
1A10:04	SubIndex 004	4. PDO Mapping entry (16 bits align)	UINT32	RW	0x0000:00, 16
1A10:05	SubIndex 005	5. PDO Mapping entry (object 0x6020 (TSC Slave Frame Elements), entry 0x04 (TSC__Slave CRC_1))	UINT32	RW	0x6020:04, 16
1A10:06	SubIndex 006	6. PDO Mapping entry (object 0x6010 (ENC Inputs), entry 0x13 (Frequency value))	UINT32	RW	0x6010:13, 16
1A10:07	SubIndex 007	7. PDO Mapping entry (object 0x6020 (TSC Slave Frame Elements), entry 0x05 (TSC__Slave CRC_2))	UINT32	RW	0x6020:05, 16
1A10:08	SubIndex 008	8. PDO Mapping entry (16 bits align)	UINT32	RW	0x0000:00, 16
1A10:09	SubIndex 009	9. PDO Mapping entry (object 0x6020 (TSC Slave Frame Elements), entry 0x06 (TSC__Slave CRC_3))	UINT32	RW	0x6020:06, 16
1A10:0A	SubIndex 010	10. PDO Mapping entry (object 0x6010 (ENC Inputs), entry 0x14 (Period value))	UINT32	RW	0x6010:14, 16
1A10:0B	SubIndex 011	11. PDO Mapping entry (object 0x6020 (TSC Slave Frame Elements), entry 0x07 (TSC__Slave CRC_4))	UINT32	RW	0x6020:07, 16
1A10:0C	SubIndex 012	12. PDO Mapping entry (16 bits align)	UINT32	RW	0x0000:00, 16
1A10:0D	SubIndex 013	13. PDO Mapping entry (object 0x6020 (TSC Slave Frame Elements), entry 0x08 (TSC__Slave CRC_5))	UINT32	RW	0x6020:08, 16
1A10:0E	SubIndex 014	14. PDO Mapping entry (object 0x6010 (ENC Inputs), entry 0x1C (Frequency value (uint16)))	UINT32	RW	0x6010:1C, 16
1A10:0F	SubIndex 015	15. PDO Mapping entry (object 0x6020 (TSC Slave Frame Elements), entry 0x09 (TSC__Slave CRC_6))	UINT32	RW	0x6020:09, 16
1A10:10	SubIndex 016	16. PDO Mapping entry (object 0x6010 (ENC Inputs), entry 0x1D (Counter value (uint16)))	UINT32	RW	0x6010:1D, 16
1A10:11	SubIndex 017	17. PDO Mapping entry (object 0x6020 (TSC Slave Frame Elements), entry 0x0A (TSC__Slave CRC_7))	UINT32	RW	0x6020:0A, 16
1A10:12	SubIndex 018	18. PDO Mapping entry (object 0x6010 (ENC Inputs), entry 0x1E (Period value (uint16)))	UINT32	RW	0x6010:1E, 16
1A10:13	SubIndex 019	19. PDO Mapping entry (object 0x6020 (TSC Slave Frame Elements), entry 0x0B (TSC__Slave CRC_8))	UINT32	RW	0x6020:0B, 16
1A10:14	SubIndex 020	20. PDO Mapping entry (object 0x6020 (TSC Slave Frame Elements), entry 0x02 (TSC__Slave ConnID))	UINT32	RW	0x6020:02, 16

Index 6020 TSC Slave Frame Elements

Index (hex)	Name	Meaning	Data type	Flags	Default
6020:0	TSC Slave Frame Elements	Max. Subindex	UINT8	RO	0x0B (11 _{dec})
6020:01	TSC__Slave Cmd	reserved	UINT8	RO	0x00 (0 _{dec})
6020:02	TSC__Slave ConnID	reserved	UINT16	RO	0x0000 (0 _{dec})
6020:03	TSC__Slave CRC_0	reserved	UINT16	RO	0x0000 (0 _{dec})
6020:04	TSC__Slave CRC_1	reserved	UINT16	RO	0x0000 (0 _{dec})
6020:05	TSC__Slave CRC_2	reserved	UINT16	RO	0x0000 (0 _{dec})
6020:06	TSC__Slave CRC_3	reserved	UINT16	RO	0x0000 (0 _{dec})
6020:07	TSC__Slave CRC_4	reserved	UINT16	RO	0x0000 (0 _{dec})
6020:08	TSC__Slave CRC_5	reserved	UINT16	RO	0x0000 (0 _{dec})
6020:09	TSC__Slave CRC_6	reserved	UINT16	RO	0x0000 (0 _{dec})
6020:0A	TSC__Slave CRC_7	reserved	UINT16	RO	0x0000 (0 _{dec})
6020:0B	TSC__Slave CRC_8	reserved	UINT16	RO	0x0000 (0 _{dec})

Index 7020 TSC Master Frame Elements

Index (hex)	Name	Meaning	Data type	Flags	Default
7020:0	TSC Master Frame Elements	Maximaler Subindex	UINT8	RO	0x03 (3 _{dec})
7020:01	TSC__Master Cmd	reserved	UINT8	RO	0x00 (0 _{dec})
7020:02	TSC__Master ConnID	reserved	UINT16	RO	0x0000 (0 _{dec})
7020:03	TSC__Master CRC_0	reserved	UINT16	RO	0x0000 (0 _{dec})

Index 8020 TSC Settings

Index (hex)	Name	Meaning	Data type	Flags	Default	
8020:0	TSC Settings	Max. Subindex	UINT8	RO	0x02 (2 _{dec})	
8020:01	Address	TwinSAFE SC Address	UINT16	RO	0x0000 (0 _{dec})	
8020:02	Connection Mode	Selection of the TwinSAFE SC CRC	UINT32	RO	0x00000000 (0 _{dec})	
		97039 _{dec}				TwinSAFE SC CRC1 master
		153375 _{dec}				TwinSAFE SC CRC2 master
		20469 _{dec}				TwinSAFE SC CRC3 master
		283633 _{dec}				TwinSAFE SC CRC4 master
		389589 _{dec}				TwinSAFE SC CRC5 master
		419387 _{dec}				TwinSAFE SC CRC6 master
		506061 _{dec}				TwinSAFE SC CRC7 master
		582077 _{dec}				TwinSAFE SC CRC8 master

18 Appendix

18.1 EtherCAT AL Status Codes

For detailed information please refer to the [EtherCAT system description](#).

18.2 Firmware compatibility

Beckhoff EtherCAT devices are delivered with the latest available firmware version. Compatibility of firmware and hardware is mandatory; not every combination ensures compatibility. The overview below shows the hardware versions on which a firmware can be operated.

Note

- It is recommended to use the newest possible firmware for the respective hardware
- Beckhoff is not under any obligation to provide customers with free firmware updates for delivered products.

NOTICE

Risk of damage to the device!

Pay attention to the instructions for firmware updates on the [separate page \[▶ 261\]](#).

If a device is placed in BOOTSTRAP mode for a firmware update, it does not check when downloading whether the new firmware is suitable.

This can result in damage to the device! Therefore, always make sure that the firmware is suitable for the hardware version!

EL5101				
Hardware (HW)	Firmware	Revision no.	Release date	
07	04		2007/12	
08	05		2008/02	
07 - 10	06		2008/03	
	07		2008/04	
	08		2008/05	
	09		2008/05	
	10		2008/08	
08 - 17	11	EL5101-0000-1018	2009/01	
	12		2009/02	
	13		2009/02	
	14		2009/02	
	15	EL5101-0000-1019	2009/04	
	16		2009/09	
	17			2009/09
			EL5101-0000-1020	2010/05
			EL5101-0000-1021	2012/06
			EL5101-0000-1022	2012/10
18 - 31*	18	EL5101-0000-1023	2013/04	
		EL5101-0000-1024	2014/11	
	19*		2018/11	

EL5101-0010			
Hardware (HW)	Firmware	Revision no.	Release date
00 - 12	01	EL5101-0010-0016	2010/10
		EL5101-0010-0017	2012/06
		EL5101-0010-0018	2012/10
		EL5101-0010-0019	2014/11
13 - 16*	02*		2022/04

EL5101-0011			
Hardware (HW)	Firmware	Revision no.	Release date
07 - 15*	01*	EL5101-0011-0016	2016/10

EL5101-0090			
Hardware (HW)	Firmware	Revision no.	Release date
24 - 25	01	EL5101-0090-0016	2017/10
26 - 31*	02	EL5101-0090-0017	2018/11
	03*		2020/11

*) This is the current compatible firmware/hardware version at the time of the preparing this documentation. Check on the Beckhoff web page whether more up-to-date [documentation](#) is available.

18.3 Firmware Update EL/ES/EM/ELM/EP/EPP/ERPxxxx

This section describes the device update for Beckhoff EtherCAT slaves from the EL/ES, ELM, EM, EK, EP, EPP and ERP series. A firmware update should only be carried out after consultation with Beckhoff support.

NOTICE
<p>Only use TwinCAT 3 software!</p> <p>A firmware update of Beckhoff IO devices must only be performed with a TwinCAT 3 installation. It is recommended to build as up-to-date as possible, available for free download on the Beckhoff website.</p> <p>To update the firmware, TwinCAT can be operated in the so-called FreeRun mode, a paid license is not required.</p> <p>The device to be updated can usually remain in the installation location, but TwinCAT has to be operated in the FreeRun. Please make sure that EtherCAT communication is trouble-free (no LostFrames etc.).</p> <p>Other EtherCAT master software, such as the EtherCAT Configurator, should not be used, as they may not support the complexities of updating firmware, EEPROM and other device components.</p>

Storage locations

An EtherCAT slave stores operating data in up to three locations:

- Each EtherCAT slave has a device description, consisting of identity (name, product code), timing specifications, communication settings, etc.
This device description (ESI; EtherCAT Slave Information) can be downloaded from the Beckhoff website in the download area as a [zip file](#) and used in EtherCAT masters for offline configuration, e.g. in TwinCAT.
Above all, each EtherCAT slave carries its device description (ESI) electronically readable in a local memory chip, the so-called **ESI EEPROM**. When the slave is switched on, this description is loaded locally in the slave and informs it of its communication configuration; on the other hand, the EtherCAT master can identify the slave in this way and, among other things, set up the EtherCAT communication accordingly.

NOTICE**Application-specific writing of the ESI-EEPROM**

The ESI is developed by the device manufacturer according to ETG standard and released for the corresponding product.

- Meaning for the ESI file: Modification on the application side (i.e. by the user) is not permitted.
- Meaning for the ESI EEPROM: Even if a writeability is technically given, the ESI parts in the EEPROM and possibly still existing free memory areas must not be changed beyond the normal update process. Especially for cyclic memory processes (operating hours counter etc.), dedicated memory products such as EL6080 or IPC's own NOVRAM must be used.

- Depending on functionality and performance EtherCAT slaves have one or several local controllers for processing I/O data. The corresponding program is the so-called **firmware** in *.efw format.
- In some EtherCAT slaves the EtherCAT communication may also be integrated in these controllers. In this case the controller is usually a so-called **FPGA** chip with *.rbf firmware.

Customers can access the data via the EtherCAT fieldbus and its communication mechanisms. Acyclic mailbox communication or register access to the ESC is used for updating or reading of these data.

The TwinCAT System Manager offers mechanisms for programming all three parts with new data, if the slave is set up for this purpose. Generally the slave does not check whether the new data are suitable, i.e. it may no longer be able to operate if the data are unsuitable.

Simplified update by bundle firmware

The update using so-called **bundle firmware** is more convenient: in this case the controller firmware and the ESI description are combined in a *.efw file; during the update both the firmware and the ESI are changed in the terminal. For this to happen it is necessary

- for the firmware to be in a packed format: recognizable by the file name, which also contains the revision number, e.g. ELxxx-xxx_REV0016_SW01.efw
- for password=1 to be entered in the download dialog. If password=0 (default setting) only the firmware update is carried out, without an ESI update.
- for the device to support this function. The function usually cannot be retrofitted; it is a component of many new developments from year of manufacture 2016.

Following the update, its success should be verified

- ESI/Revision: e.g. by means of an online scan in TwinCAT ConfigMode/FreeRun – this is a convenient way to determine the revision
- Firmware: e.g. by looking in the online CoE of the device

NOTICE**Risk of damage to the device!**

✓ Note the following when downloading new device files

- a) Firmware downloads to an EtherCAT device must not be interrupted
 - b) Flawless EtherCAT communication must be ensured. CRC errors or LostFrames must be avoided.
 - c) The power supply must adequately dimensioned. The signal level must meet the specification.
- ⇒ In the event of malfunctions during the update process the EtherCAT device may become unusable and require re-commissioning by the manufacturer.

18.3.1 Device description ESI file/XML**NOTICE****Attention regarding update of the ESI description/EEPROM**

Some slaves have stored calibration and configuration data from the production in the EEPROM. These are irretrievably overwritten during an update.

The ESI device description is stored locally on the slave and loaded on start-up. Each device description has a unique identifier consisting of slave name (9 characters/digits) and a revision number (4 digits). Each slave configured in the System Manager shows its identifier in the EtherCAT tab:

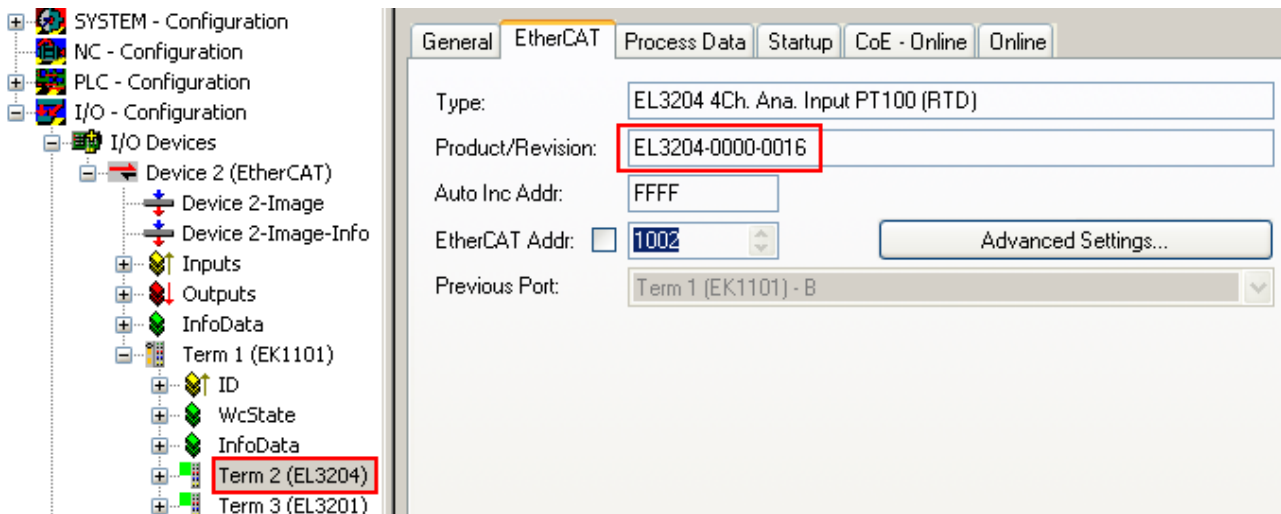

Fig. 187: Device identifier consisting of name EL3204-0000 and revision -0016

The configured identifier must be compatible with the actual device description used as hardware, i.e. the description which the slave has loaded on start-up (in this case EL3204). Normally the configured revision must be the same or lower than that actually present in the terminal network.

For further information on this, please refer to the [EtherCAT system documentation](#).

Update of XML/ESI description

The device revision is closely linked to the firmware and hardware used. Incompatible combinations lead to malfunctions or even final shutdown of the device. Corresponding updates should only be carried out in consultation with Beckhoff support.

Display of ESI slave identifier

The simplest way to ascertain compliance of configured and actual device description is to scan the EtherCAT boxes in TwinCAT mode Config/FreeRun:

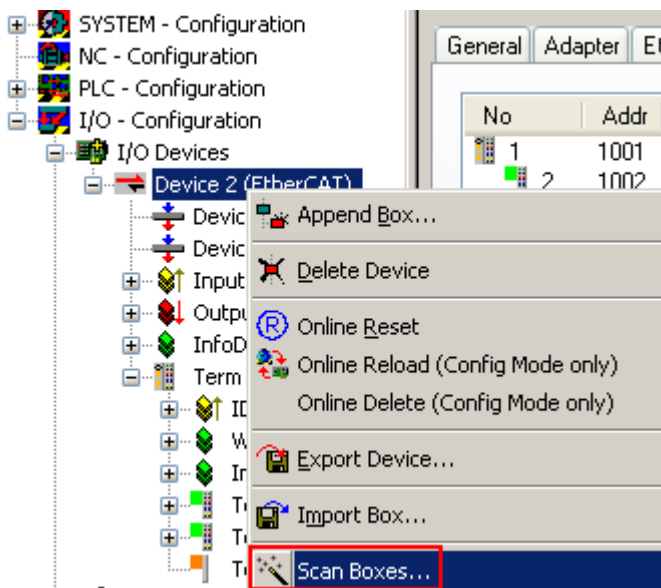

Fig. 188: Scan the subordinate field by right-clicking on the EtherCAT device

If the found field matches the configured field, the display shows



Fig. 189: Configuration is identical

otherwise a change dialog appears for entering the actual data in the configuration.

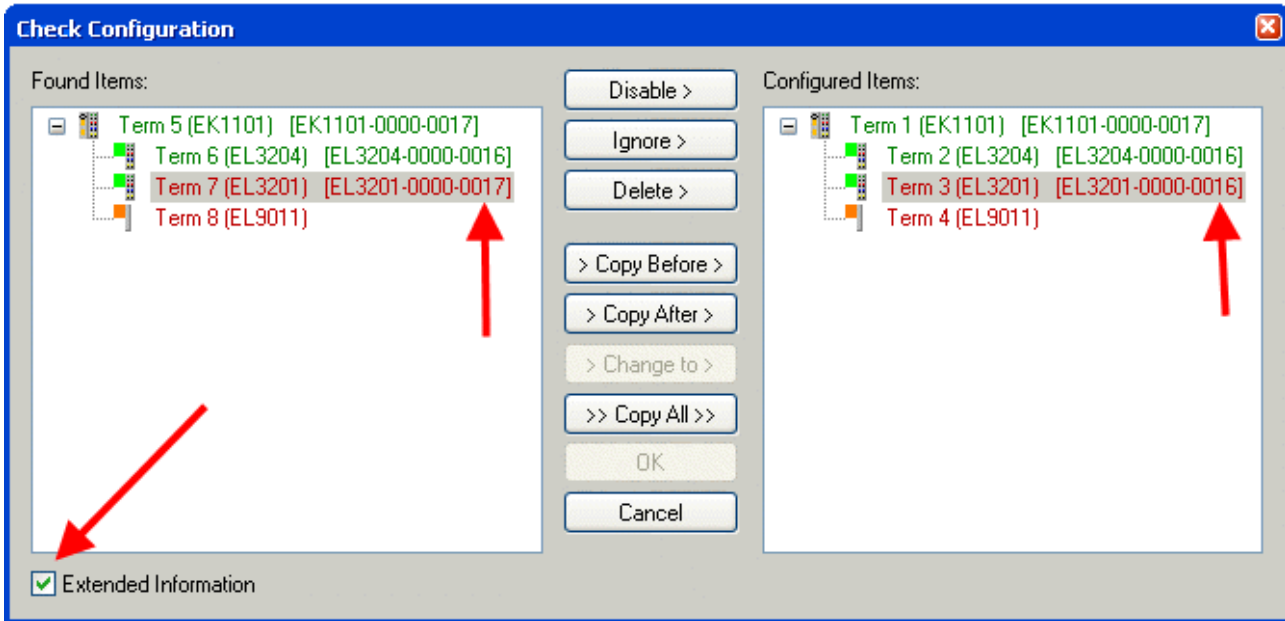

Fig. 190: Change dialog

In this example in Fig. *Change dialog*, an EL3201-0000-**0017** was found, while an EL3201-0000-**0016** was configured. In this case the configuration can be adapted with the *Copy Before* button. The *Extended Information* checkbox must be set in order to display the revision.

Changing the ESI slave identifier

The ESI/EEPROM identifier can be updated as follows under TwinCAT:

- Trouble-free EtherCAT communication must be established with the slave.
- The state of the slave is irrelevant.
- Right-clicking on the slave in the online display opens the *EEPROM Update* dialog, Fig. *EEPROM Update*

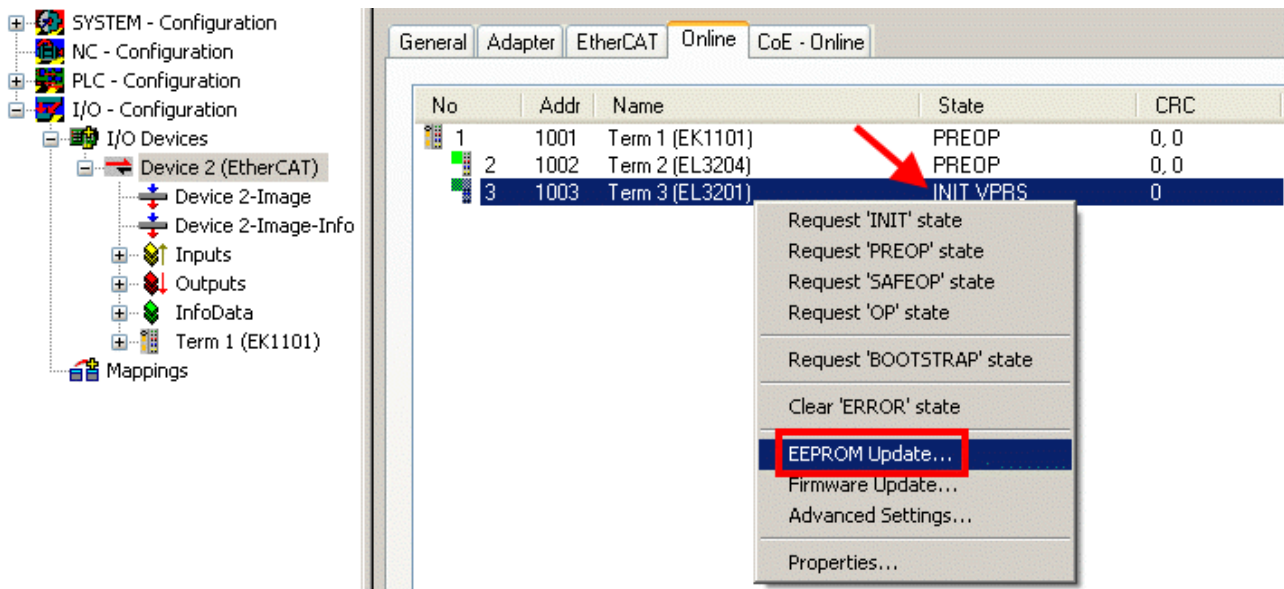

Fig. 191: EEPROM Update

The new ESI description is selected in the following dialog, see Fig. *Selecting the new ESI*. The checkbox *Show Hidden Devices* also displays older, normally hidden versions of a slave.

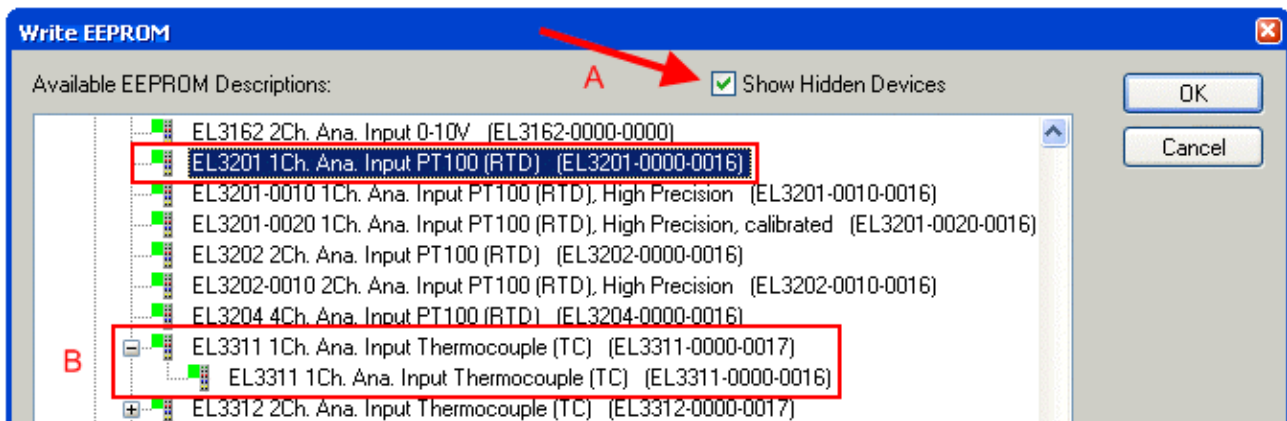

Fig. 192: Selecting the new ESI

A progress bar in the System Manager shows the progress. Data are first written, then verified.

● The change only takes effect after a restart.

i Most EtherCAT devices read a modified ESI description immediately or after startup from the INIT. Some communication settings such as distributed clocks are only read during power-on. The EtherCAT slave therefore has to be switched off briefly in order for the change to take effect.

18.3.2 Firmware explanation

Determining the firmware version

Determining the version via the System Manager

The TwinCAT System Manager shows the version of the controller firmware if the master can access the slave online. Click on the E-Bus Terminal whose controller firmware you want to check (in the example terminal 2 (EL3204)) and select the tab *CoE Online* (CAN over EtherCAT).

CoE Online and Offline CoE

Two CoE directories are available:

- **online:** This is offered in the EtherCAT slave by the controller, if the EtherCAT slave supports this. This CoE directory can only be displayed if a slave is connected and operational.
- **offline:** The EtherCAT Slave Information ESI/XML may contain the default content of the CoE. This CoE directory can only be displayed if it is included in the ESI (e.g. "Beckhoff EL5xxx.xml").

The Advanced button must be used for switching between the two views.

In Fig. *Display of EL3204 firmware version* the firmware version of the selected EL3204 is shown as 03 in CoE entry 0x100A.

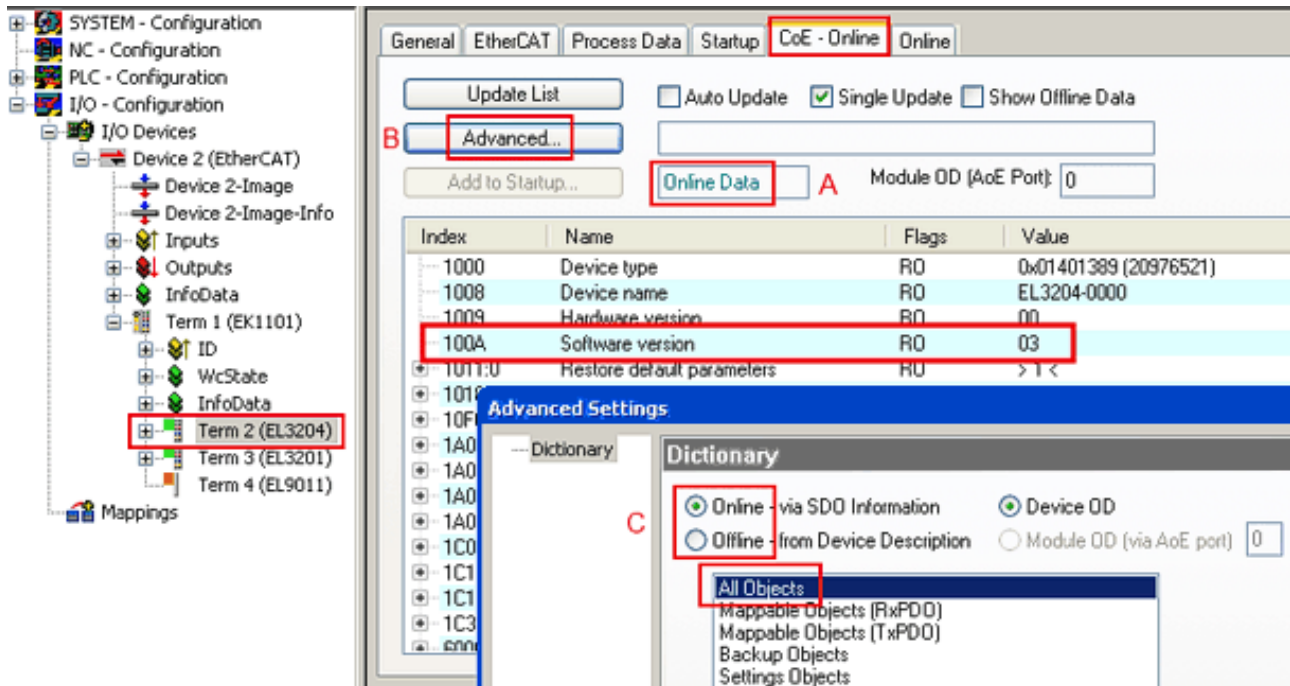

Fig. 193: Display of EL3204 firmware version

In (A) TwinCAT 2.11 shows that the Online CoE directory is currently displayed. If this is not the case, the Online directory can be loaded via the *Online* option in Advanced Settings (B) and double-clicking on *AllObjects*.

18.3.3 Updating controller firmware *.efw

CoE directory

The Online CoE directory is managed by the controller and stored in a dedicated EEPROM, which is generally not changed during a firmware update.

Switch to the *Online* tab to update the controller firmware of a slave, see Fig. *Firmware Update*.

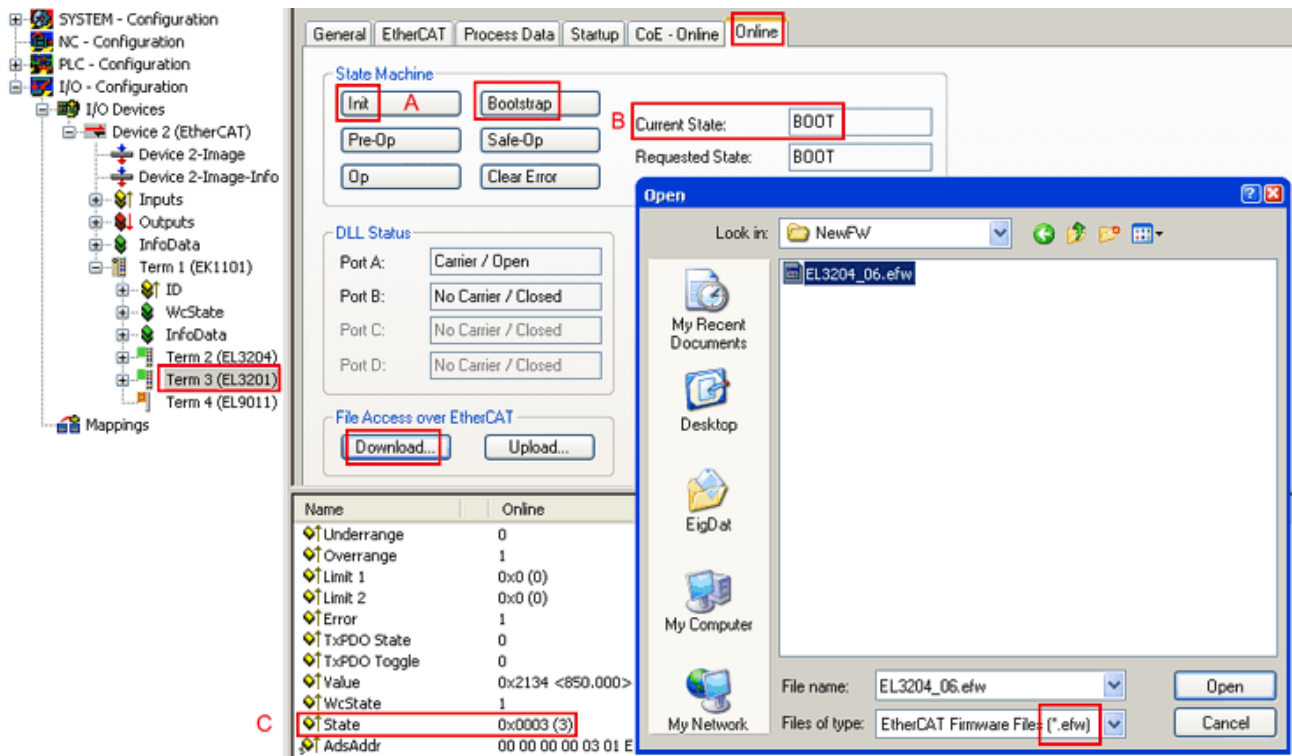
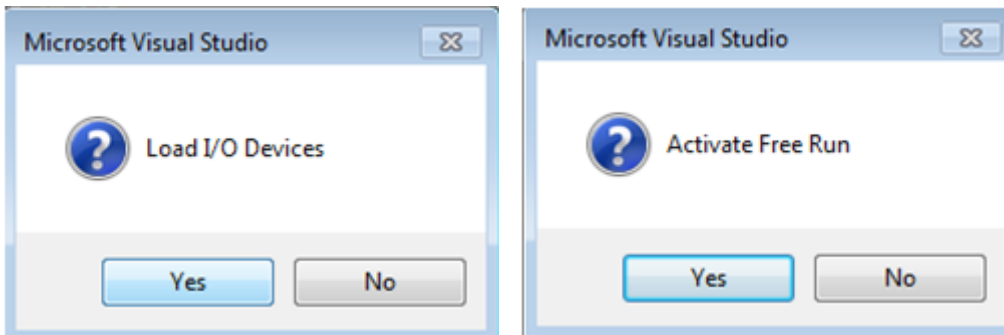

Fig. 194: Firmware Update

Proceed as follows, unless instructed otherwise by Beckhoff support. Valid for TwinCAT 2 and 3 as EtherCAT master.

- Switch TwinCAT system to ConfigMode/FreeRun with cycle time ≥ 1 ms (default in ConfigMode is 4 ms). A FW-Update during real time operation is not recommended.



- Switch EtherCAT Master to PreOP

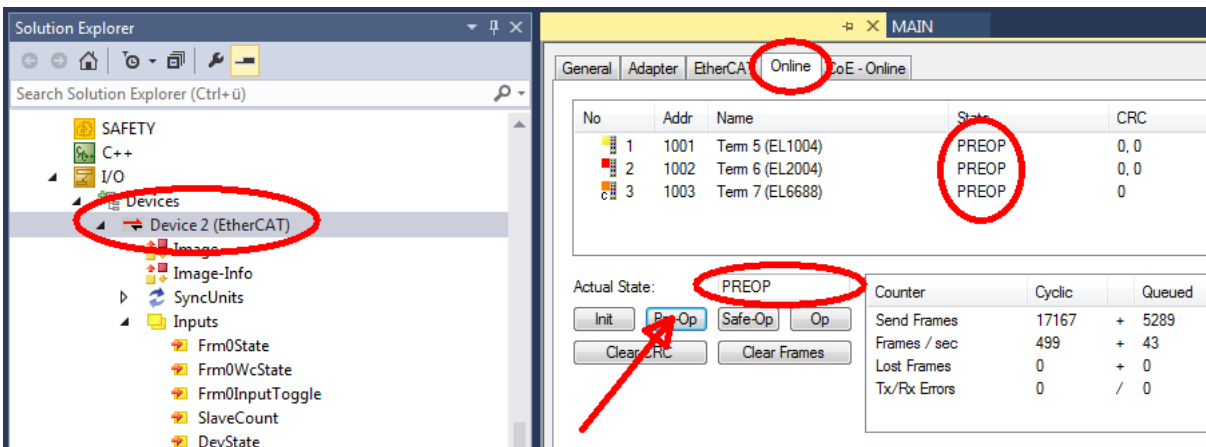

- Switch slave to INIT (A)
- Switch slave to BOOTSTRAP

- Check the current status (B, C)
- Download the new *efw file (wait until it ends). A password will not be necessary usually.

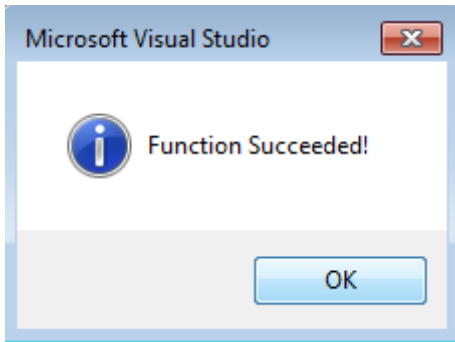

- After the download switch to INIT, then PreOP
- Switch off the slave briefly (don't pull under voltage!)
- Check within CoE 0x100A, if the FW status was correctly overtaken.

18.3.4 FPGA firmware *.rbf

If an FPGA chip deals with the EtherCAT communication an update may be accomplished via an *.rbf file.

- Controller firmware for processing I/O signals
- FPGA firmware for EtherCAT communication (only for terminals with FPGA)

The firmware version number included in the terminal serial number contains both firmware components. If one of these firmware components is modified this version number is updated.

Determining the version via the System Manager

The TwinCAT System Manager indicates the FPGA firmware version. Click on the Ethernet card of your EtherCAT strand (Device 2 in the example) and select the *Online* tab.

The *Reg:0002* column indicates the firmware version of the individual EtherCAT devices in hexadecimal and decimal representation.

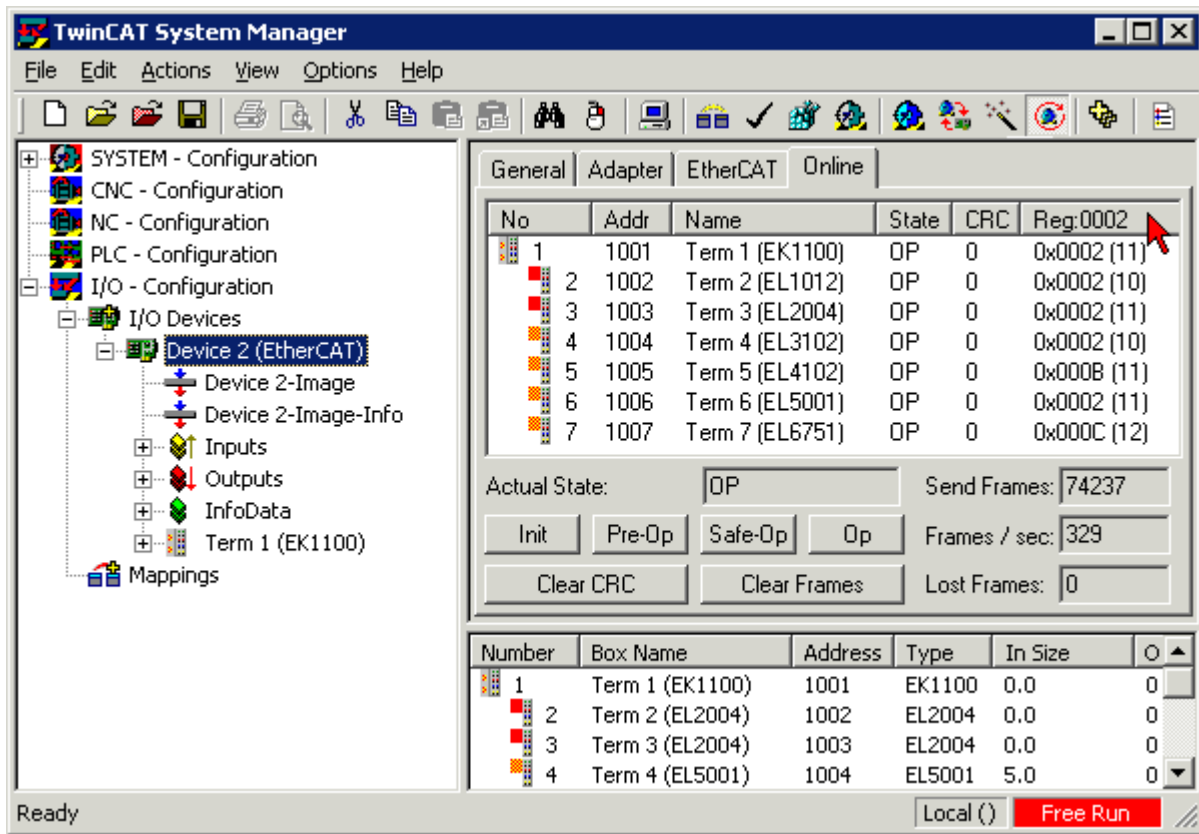

Fig. 195: FPGA firmware version definition

If the column *Reg:0002* is not displayed, right-click the table header and select *Properties* in the context menu.

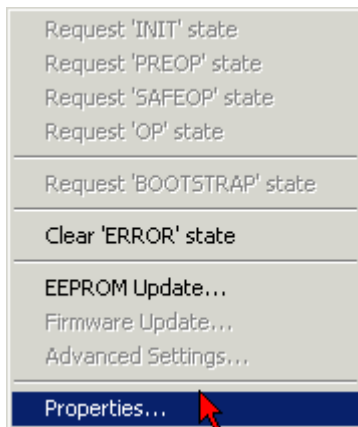

Fig. 196: Context menu *Properties*

The *Advanced Settings* dialog appears where the columns to be displayed can be selected. Under *Diagnosis/Online View* select the *'0002 ETxxxx Build'* check box in order to activate the FPGA firmware version display.

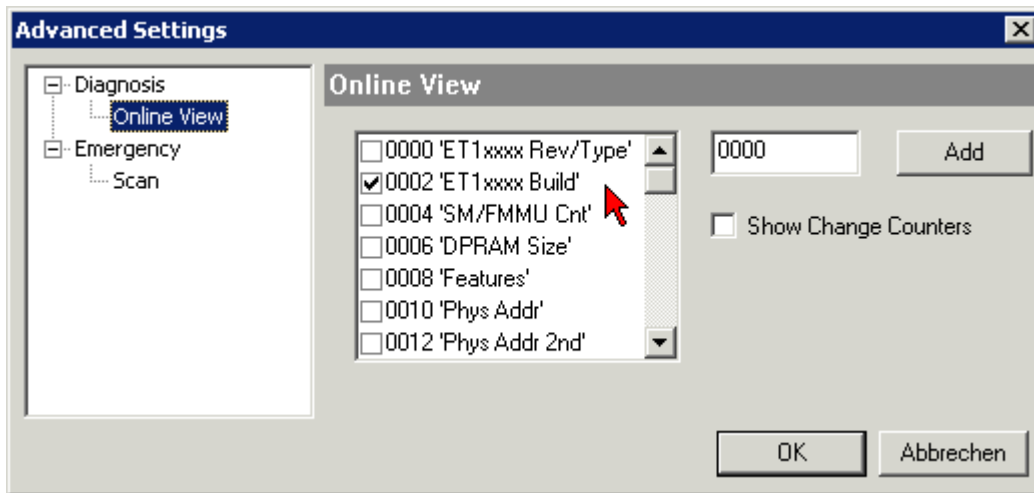

Fig. 197: Dialog *Advanced Settings*

Update

For updating the FPGA firmware

- of an EtherCAT coupler the coupler must have FPGA firmware version 11 or higher;
- of an E-Bus Terminal the terminal must have FPGA firmware version 10 or higher.

Older firmware versions can only be updated by the manufacturer!

Updating an EtherCAT device

The following sequence order have to be met if no other specifications are given (e.g. by the Beckhoff support):

- Switch TwinCAT system to ConfigMode/FreeRun with cycle time ≥ 1 ms (default in ConfigMode is 4 ms). A FW-Update during real time operation is not recommended.

- In the TwinCAT System Manager select the terminal for which the FPGA firmware is to be updated (in the example: Terminal 5: EL5001) and click the *Advanced Settings* button in the *EtherCAT* tab:

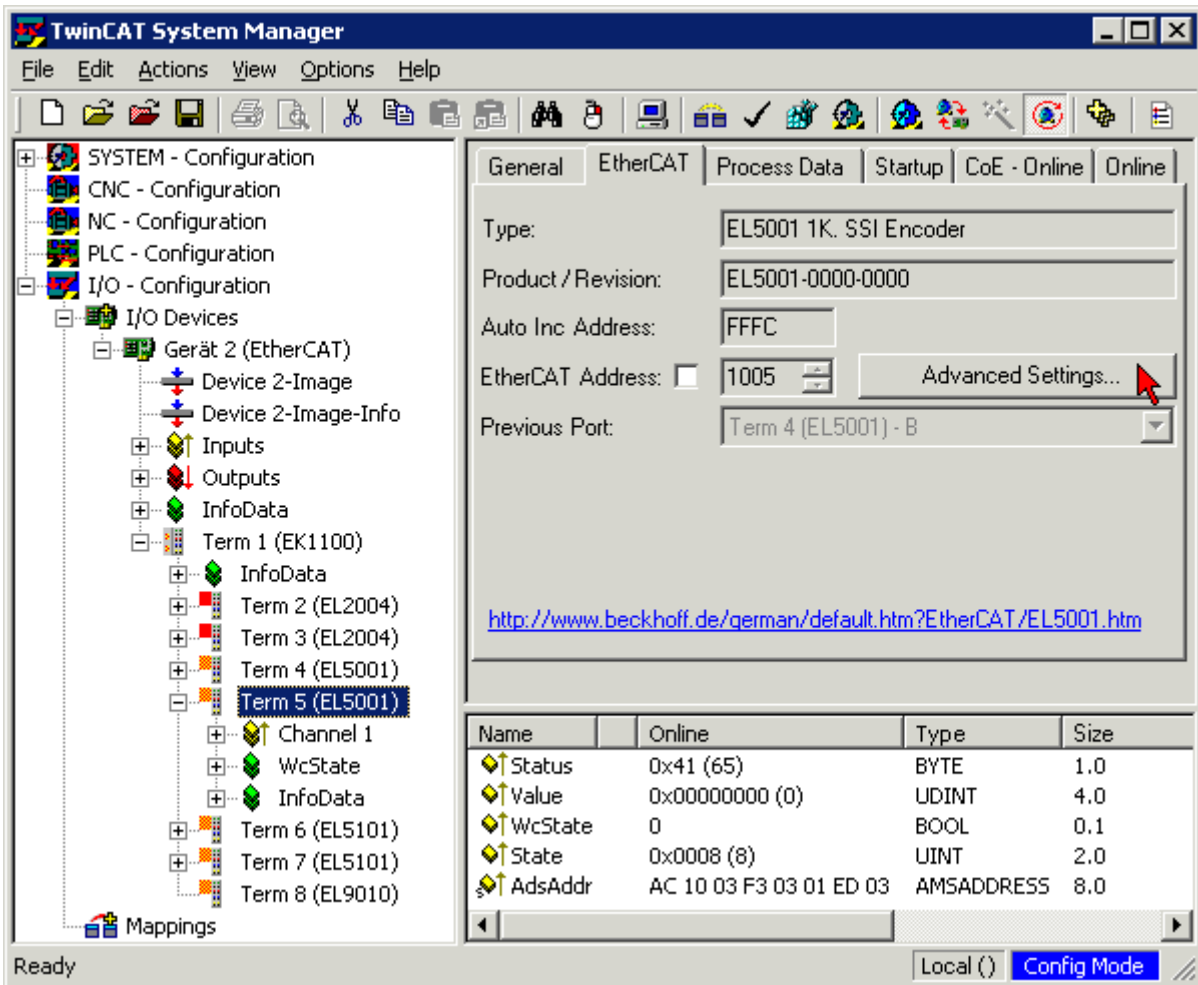

- The *Advanced Settings* dialog appears. Under *ESC Access/E²PROM/FPGA* click on *Write FPGA* button:

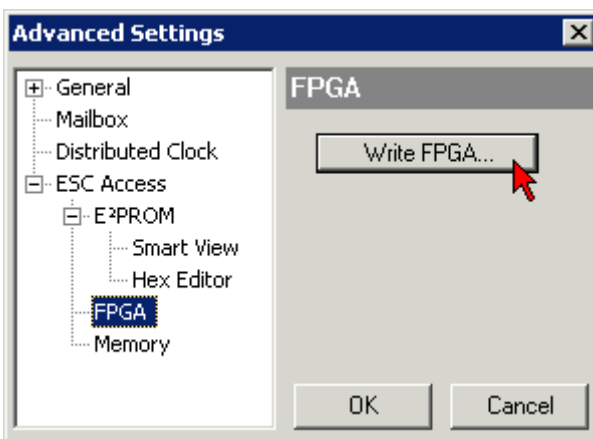

- Select the file (*.rbf) with the new FPGA firmware, and transfer it to the EtherCAT device:

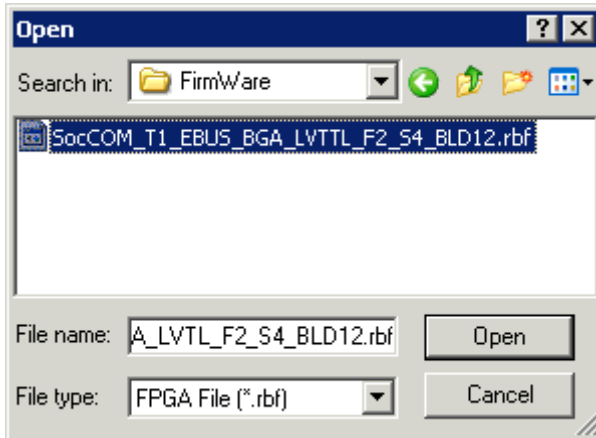

- Wait until download ends
- Switch slave current less for a short time (don't pull under voltage!). In order to activate the new FPGA firmware a restart (switching the power supply off and on again) of the EtherCAT device is required.
- Check the new FPGA status

NOTICE

Risk of damage to the device!

A download of firmware to an EtherCAT device must not be interrupted in any case! If you interrupt this process by switching off power supply or disconnecting the Ethernet link, the EtherCAT device can only be recommissioned by the manufacturer!

18.3.5 Simultaneous updating of several EtherCAT devices

The firmware and ESI descriptions of several devices can be updated simultaneously, provided the devices have the same firmware file/ESI.

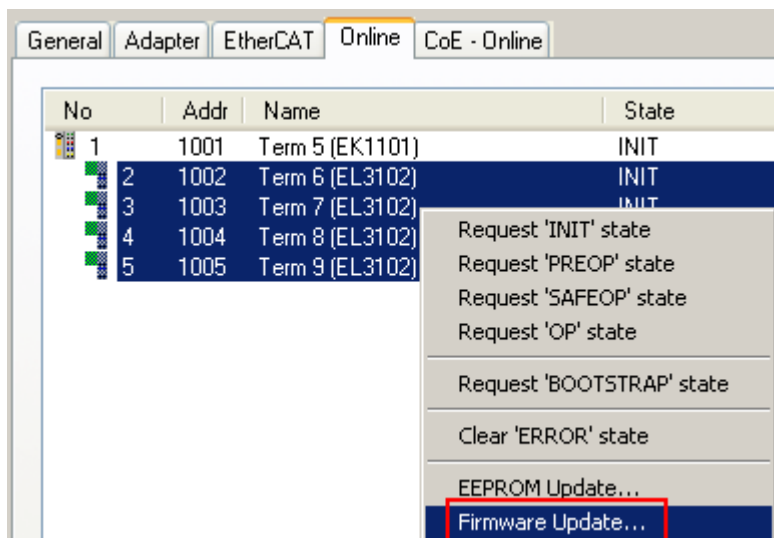

Fig. 198: Multiple selection and firmware update

Select the required slaves and carry out the firmware update in BOOTSTRAP mode as described above.

18.4 Restoring the delivery state

To restore the delivery state (factory settings) of CoE objects for EtherCAT devices (“slaves”), the CoE object *Restore default parameters*, SubIndex 001 can be used via EtherCAT master (e.g. TwinCAT) (see Fig. *Selecting the Restore default parameters PDO*).

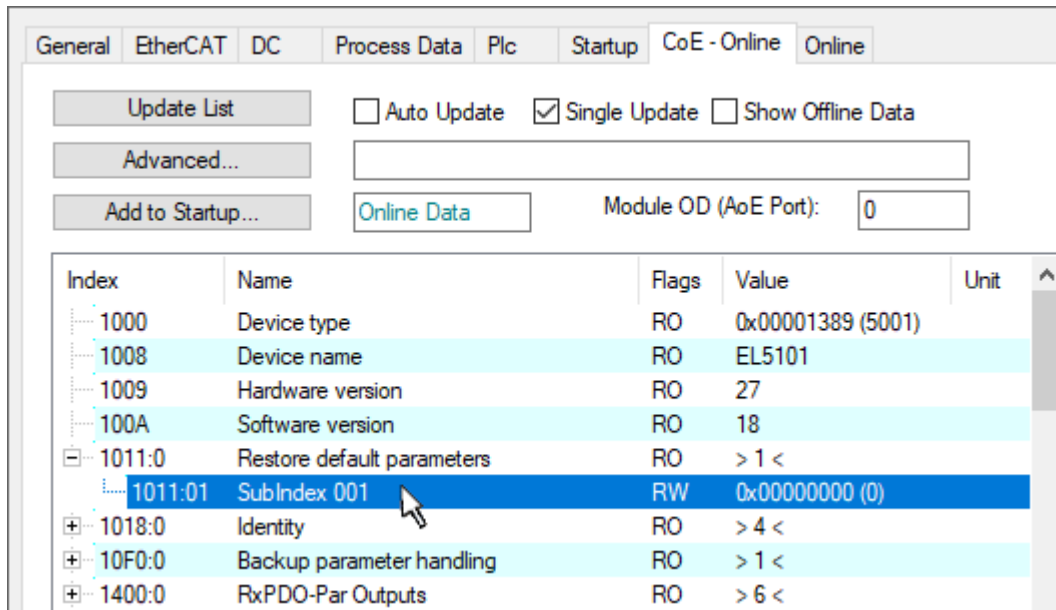

Fig. 199: Selecting the *Restore default parameters* PDO

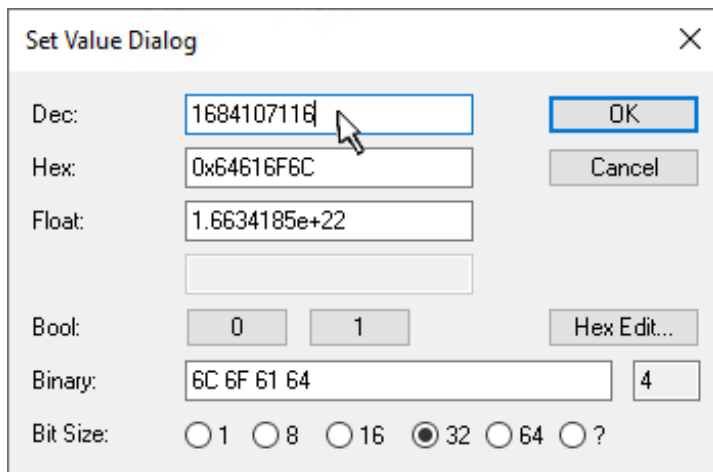

Fig. 200: Entering a restore value in the Set Value dialog

Double-click on *SubIndex 001* to enter the Set Value dialog. Enter the reset value **1684107116** in field *Dec* or the value **0x64616F6C** in field *Hex* (ASCII: “load”) and confirm with *OK* (Fig. *Entering a restore value in the Set Value dialog*).

- All changeable entries in the slave are reset to the default values.
- The values can only be successfully restored if the reset is directly applied to the online CoE, i.e. to the slave. No values can be changed in the offline CoE.
- TwinCAT must be in the RUN or CONFIG/Freerun state for this; that means EtherCAT data exchange takes place. Ensure error-free EtherCAT transmission.
- No separate confirmation takes place due to the reset. A changeable object can be manipulated beforehand for the purposes of checking.
- This reset procedure can also be adopted as the first entry in the startup list of the slave, e.g. in the state transition PREOP->SAFEOP or, as in Fig. *CoE reset as a startup entry*, in SAFEOP->OP.

All backup objects are reset to the delivery state.

i **Alternative restore value**

In some older terminals (FW creation approx. before 2007) the backup objects can be switched with an alternative restore value: Decimal value: 1819238756, Hexadecimal value: 0x6C6F6164.

An incorrect entry for the restore value has no effect.

18.5 Support and Service

Beckhoff and their partners around the world offer comprehensive support and service, making available fast and competent assistance with all questions related to Beckhoff products and system solutions.

Beckhoff's branch offices and representatives

Please contact your Beckhoff branch office or representative for local support and service on Beckhoff products!

The addresses of Beckhoff's branch offices and representatives round the world can be found on her internet pages: www.beckhoff.com

You will also find further documentation for Beckhoff components there.

Support

The Beckhoff Support offers you comprehensive technical assistance, helping you not only with the application of individual Beckhoff products, but also with other, wide-ranging services:

- support
- design, programming and commissioning of complex automation systems
- and extensive training program for Beckhoff system components

Hotline: +49 5246 963 157
e-mail: support@beckhoff.com
web: www.beckhoff.com/support

Service

The Beckhoff Service Center supports you in all matters of after-sales service:

- on-site service
- repair service
- spare parts service
- hotline service

Hotline: +49 5246 963 460
e-mail: service@beckhoff.com
web: www.beckhoff.com/service

Headquarters Germany

Beckhoff Automation GmbH & Co. KG

Hülshorstweg 20
33415 Verl
Germany

Phone: +49 5246 963 0
e-mail: info@beckhoff.com
web: www.beckhoff.com

More Information:
www.beckhoff.com/el5xxx

Beckhoff Automation GmbH & Co. KG
Hülshorstweg 20
33415 Verl
Germany
Phone: +49 5246 9630
info@beckhoff.com
www.beckhoff.com

