





# Table of contents

<b>1 Foreword</b> .....	<b>5</b>
1.1 Notes on the documentation.....	5
1.2 Safety instructions .....	6
1.3 Documentation Issue Status.....	7
1.4 Marking of ELX terminals .....	8
<b>2 Product overview</b> .....	<b>12</b>
2.1 ELX9560 - Introduction .....	12
2.2 Technical data .....	13
2.3 ELX9410 - Introduction .....	14
2.4 Technical data .....	15
2.5 ELX9012 - Introduction.....	16
2.6 Technical data .....	16
2.7 Intended use.....	17
<b>3 Mounting and wiring</b> .....	<b>18</b>
3.1 Special conditions of use for ELX terminals .....	18
3.2 Installation notes for ELX terminals .....	18
3.3 Arrangement of ELX terminals within a bus terminal block .....	20
3.4 Installation position and minimum distances .....	23
3.5 Installation of ELX terminals on mounting rails.....	24
3.6 Connection .....	25
3.6.1 Connection system .....	25
3.6.2 Wiring.....	26
3.6.3 Proper line connection .....	28
3.6.4 Shielding and potential separation.....	28
3.6.5 ELX9560 - Contact assignment .....	29
3.6.6 ELX9410 Contact assignment .....	30
<b>4 Appendix</b> .....	<b>31</b>
4.1 UL notice .....	31
4.2 FM notice .....	32
4.3 Support and Service .....	33



# 1 Foreword

## 1.1 Notes on the documentation

### Intended audience

This description is only intended for the use of trained specialists in control and automation engineering who are familiar with the applicable national standards.

It is essential that the documentation and the following notes and explanations are followed when installing and commissioning these components.

It is the duty of the technical personnel to use the documentation published at the respective time of each installation and commissioning.

The responsible staff must ensure that the application or use of the products described satisfy all the requirements for safety, including all the relevant laws, regulations, guidelines and standards.

### Disclaimer

The documentation has been prepared with care. The products described are, however, constantly under development.

We reserve the right to revise and change the documentation at any time and without prior announcement.

No claims for the modification of products that have already been supplied may be made on the basis of the data, diagrams and descriptions in this documentation.

### Trademarks

Beckhoff®, TwinCAT®, EtherCAT®, EtherCAT G®, EtherCAT G10®, EtherCAT P®, Safety over EtherCAT®, TwinSAFE®, XFC®, XTS® and XPlanar® are registered trademarks of and licensed by Beckhoff Automation GmbH. Other designations used in this publication may be trademarks whose use by third parties for their own purposes could violate the rights of the owners.

### Patent Pending

The EtherCAT Technology is covered, including but not limited to the following patent applications and patents: EP1590927, EP1789857, EP1456722, EP2137893, DE102015105702 with corresponding applications or registrations in various other countries.

The logo for EtherCAT, featuring the word "EtherCAT" in a bold, black, sans-serif font. A red arrow points from the top of the "A" towards the right, ending above the "T". A registered trademark symbol (®) is located to the right of the "T".

EtherCAT® is registered trademark and patented technology, licensed by Beckhoff Automation GmbH, Germany.

### Copyright

© Beckhoff Automation GmbH & Co. KG, Germany.

The reproduction, distribution and utilization of this document as well as the communication of its contents to others without express authorization are prohibited.

Offenders will be held liable for the payment of damages. All rights reserved in the event of the grant of a patent, utility model or design.

## 1.2 Safety instructions

### Safety regulations

Please note the following safety instructions and explanations!  
Product-specific safety instructions can be found on following pages or in the areas mounting, wiring, commissioning etc.

### Exclusion of liability

All the components are supplied in particular hardware and software configurations appropriate for the application. Modifications to hardware or software configurations other than those described in the documentation are not permitted, and nullify the liability of Beckhoff Automation GmbH & Co. KG.

### Personnel qualification

This description is only intended for trained specialists in control, automation and drive engineering who are familiar with the applicable national standards.

### Description of instructions

In this documentation the following instructions are used.  
These instructions must be read carefully and followed without fail!

#### **DANGER**

##### **Serious risk of injury!**

Failure to follow this safety instruction directly endangers the life and health of persons.

#### **WARNING**

##### **Risk of injury!**

Failure to follow this safety instruction endangers the life and health of persons.

#### **CAUTION**

##### **Personal injuries!**

Failure to follow this safety instruction can lead to injuries to persons.

#### **NOTE**

##### **Damage to environment/equipment or data loss**

Failure to follow this instruction can lead to environmental damage, equipment damage or data loss.



##### **Tip or pointer**

This symbol indicates information that contributes to better understanding.

### 1.3 Documentation Issue Status

Version	Comment
1.8.0	<ul style="list-style-type: none"> <li>• Chapter <i>ELX9560-0000 - Introduction</i> updated</li> <li>• Technical data of ELX9560-0000 updated</li> <li>• Download links updated</li> <li>• Design of the safety instructions adapted to IEC 82079-1.</li> <li>• New title page</li> </ul>
1.7.0	<ul style="list-style-type: none"> <li>• FM notice regarding ANSI/ISA EX added</li> <li>• Chapter <i>Marking of ELX terminals</i> updated</li> </ul>
1.6.0	<ul style="list-style-type: none"> <li>• Technical data of ELX9560-0000 updated</li> <li>• Chapter <i>Marking of ELX Terminals</i> updated</li> </ul>
1.5.0	<ul style="list-style-type: none"> <li>• ELX9410 added</li> <li>• Chapter <i>Contact assignment</i> extended</li> <li>• Chapter <i>Arrangement of ELX terminals within a bus terminal block</i> updated</li> <li>• Chapter <i>Marking of ELX Terminals</i> updated</li> <li>• Technical data updated</li> </ul>
1.4.0	<ul style="list-style-type: none"> <li>• Chapter <i>Arrangement of ELX terminals at the bus terminal</i> updated</li> </ul>
1.3.0	<ul style="list-style-type: none"> <li>• Chapter <i>Installation notes for ELX terminals</i> updated</li> <li>• Technical data updated</li> </ul>
1.2.0	<ul style="list-style-type: none"> <li>• Chapter <i>Marking of ELX Terminals</i> updated</li> </ul>
1.1.0	<ul style="list-style-type: none"> <li>• Chapter <i>Marking of ELX Terminals</i> updated</li> <li>• Technical data updated</li> </ul>
1.0.0	<ul style="list-style-type: none"> <li>• Technical data updated</li> <li>• Intended use added</li> <li>• Contact assignment for ELX9560 added</li> </ul>
0.1	<ul style="list-style-type: none"> <li>• First preliminary version</li> </ul>

## 1.4 Marking of ELX terminals

### Name

An ELX terminal has a 15-digit technical designation, composed of

- family key
- type
- software variant
- revision

example	family	type	software variant	revision
ELX1052-0000-0001	ELX terminal	1052: two-channel digital input terminal for NAMUR sensors, Ex i	0000: basic type	0001
ELX9560-0000-0001	ELX terminal	9560: power supply terminal	0000: basic type	0001

### Notes

- The elements mentioned above result in the **technical designation**. ELX1052-0000-0001 is used in the example below.
- Of these, ELX1052-0000 is the order identifier, commonly called just ELX1052 in the "-0000" revision. "-0001" is the EtherCAT revision.
- The **order identifier** is made up of
  - family key (ELX)
  - type (1052)
  - software version (-0000)
- The **Revision** -0001 shows the technical progress, such as the extension of features with regard to the EtherCAT communication, and is managed by Beckhoff. In principle, a device with a higher revision can replace a device with a lower revision, unless specified otherwise, e.g. in the documentation. Associated and synonymous with each revision there is usually a description (ESI, EtherCAT Slave Information) in the form of an XML file, which is available for download from the Beckhoff website. The revision has been applied to the terminals on the outside, see *ELX1052 with date code 3218FMFM, BTN 10000100 and Ex marking*.
- The hyphen is omitted in the labeling on the side of the terminal. Example:  
Name: ELX1052-0000  
Label: ELX1052<sub>0000</sub>
- The type, software version and revision are read as decimal numbers, even if they are technically saved in hexadecimal.

### Identification numbers

ELX terminals have two different identification numbers:

- date code (batch number)
- **Beckhoff Traceability Number**, or BTN for short (as a serial number it clearly identifies each terminal)

### Date code

The date code is an eight-digit number given by Beckhoff and printed on the ELX terminal. The date code indicates the build version in the delivery state and thus identifies an entire production batch, but does not distinguish between the terminals in a batch.

Structure of the date code: **WW YY FF HH**  
 WW - week of production (calendar week)  
 YY - year of production  
 FF - firmware version  
 HH - hardware version

Example with date code: 02180100:  
 02 - week of production 02  
 18 - year of production 2018  
 01 - firmware version 01  
 00 - hardware version 00



**Beckhoff Traceability Number (BTN)**

In addition, each ELX terminal has a unique **Beckhoff Traceability Number (BTN)**.

**Ex marking**

The Ex marking can be found at the top left on the terminal:

II 3 (1) G Ex ec [ia Ga] IIC T4 Gc  
 II (1) D [Ex ia Da] IIIC  
 I (M1) [Ex ia Ma] I  
 IECEx BVS 18.0005X  
 BVS 18 ATEX E 005 X

**Examples**

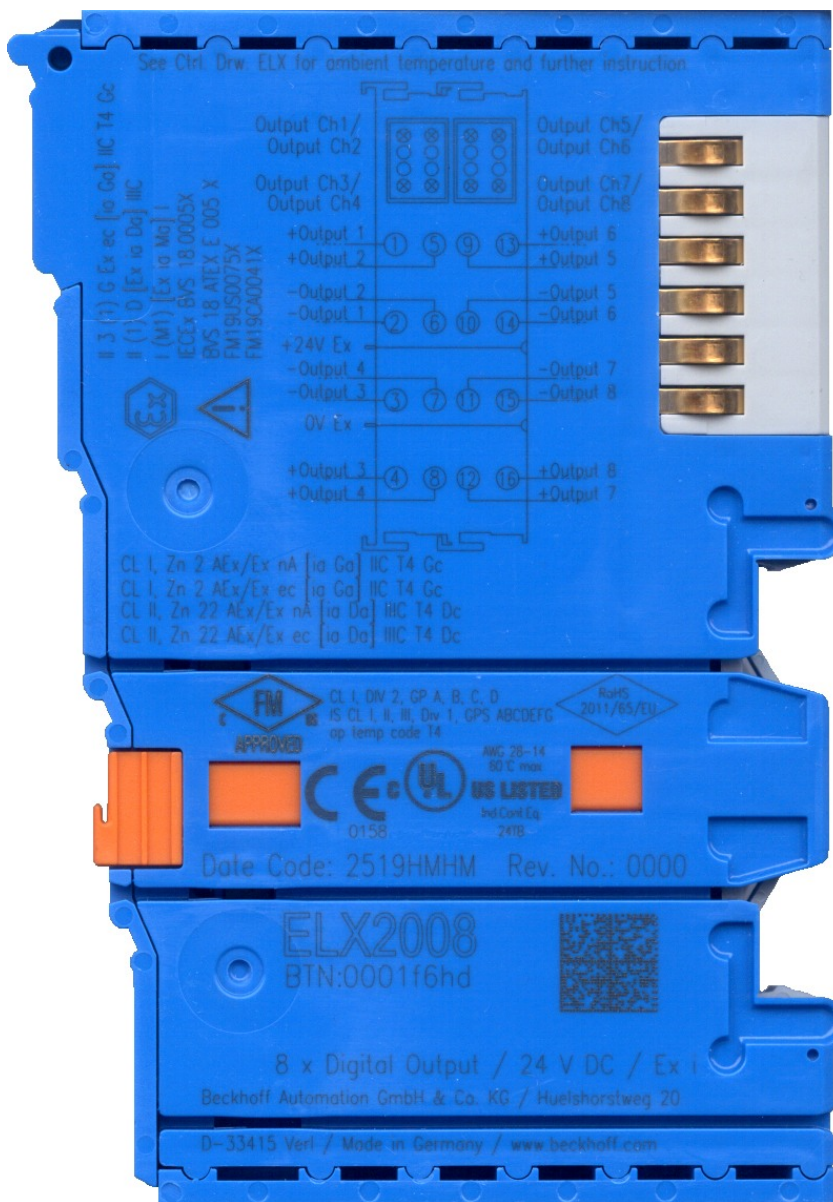

Fig. 1: ELX2008-0000 with date code 2519HMHM, BTN 0001f6hd and Ex marking



Fig. 2: ELX9560-0000 with date code 12150000, BTN 000b000 and Ex marking



Fig. 3: ELX9012 with date code 12174444, BTN 0000b0si and Ex marking

## 2 Product overview

### 2.1 ELX9560 - Introduction

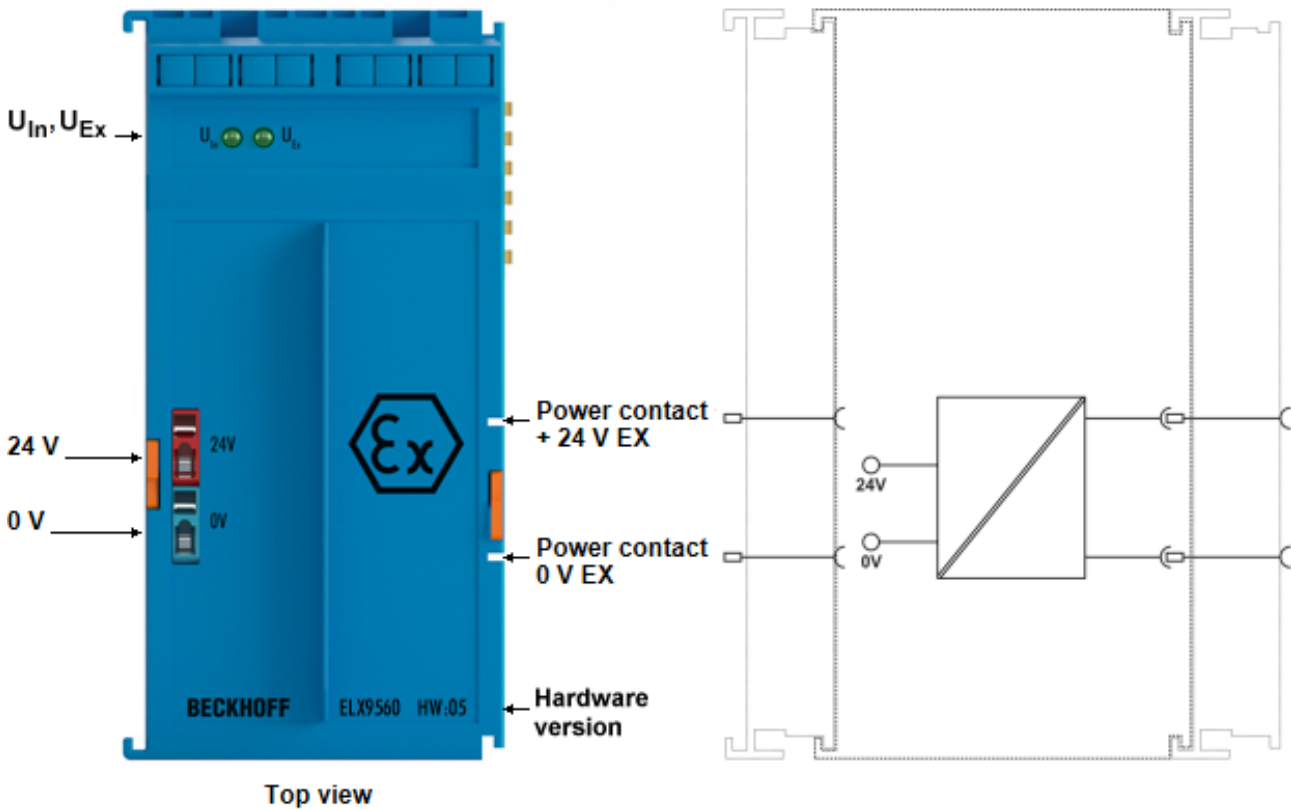

Fig. 4: ELX9560 - power supply terminal, 24 V<sub>DC</sub>, electrically isolated

The ELX9560 power supply terminal generates an electrically isolated output voltage of 24 V Ex from a 24 V<sub>DC</sub> input voltage for supplying downstream ELX terminals. The connected ELX terminals are supplied via the power contacts. The applied voltage and the voltage output at the power contacts are continuously monitored. The operating state of the terminal is indicated by the LEDs and can be read out for diagnostics purposes within the process image of the higher-level control system.

#### **⚠ WARNING**

##### **Pay attention to the hardware version of the ELX9560!**

Note that the field interfaces and reactances ( $U_o$ ,  $I_o$ ,  $P_o$ ,  $L_o$  and  $C_o$ ) of the terminals may differ depending on the hardware version of the ELX9560 used!

## 2.2 Technical data

Technical data		ELX9560-0000
Technology	terminal supply	
Input voltage	24 V <sub>DC</sub> (-15% / +20%)	
Output voltage	24 V <sub>DC</sub> Ex	
Output current	0.35 A (hardware version 00) 0.65 A (from hardware version 01)  Please refer to the date code on the right side of the terminal for the hardware version (see chapter <a href="#">Marking of ELX terminals [► 8]</a> ). Furthermore, as of hardware version 04, you will find this additionally on the <a href="#">front of the ELX9560 [► 12]</a> .	
Special features	electrically isolated output voltage, reverse polarity protection, diagnostic of supply and output voltage	
Input voltage E-Bus	typ. 5 V <sub>DC</sub>	
Current consumption from E-Bus	typ. 40 mA	
Electrical isolation	1500 V (E-Bus / field voltage)	
Bit width in the process image	2 bit	
Weight	app. 200 g	
Permissible ambient temperature range during operation	-25°C ... + 60°C	
Permissible ambient temperature range during storage	-40°C ... + 85°C	
Permissible relative humidity	95%, no condensation	
Permissible air pressure (operation, storage, transport)	800 hPa to 1100 hPa (this corresponds to a height of approx. -690 m to 2000 m over sea level assuming an international standard atmosphere)	
Dimensions (W x H x D)	app. 50 mm x 100 mm x 70 mm (aligned width: 48 mm)	
<a href="#">Mounting [► 24]</a>	on 35 mm mounting rail conforms to EN 60715	
Vibration / shock resistance	conforms to EN 60068-2-6 / EN 60068-2-27	
EMC immunity / emission	conforms to EN 61000-6-2 / EN 61000-6-4	
Protect. class	IP20	
Permissible installation position	See chapter <a href="#">Installation position and minimum distances [► 23]</a>	
Approvals / markings	CE, UL, ATEX, IECEx, cFMus	

Technical data for explosion protection		ELX9560-0000
Ex marking	ATEX	II 3 G Ex ec IIC T4 Gc
	IECEx	Ex ec IIC T4 Gc
	cFMus	Class I, Division 2, Groups A, B, C, D Class I, Zone 2, AEx/Ex ec IIC T4 Gc
Certificate numbers	BVS 18 ATEX E 005 X IECEx BVS 18.0005X FM19US0075X, FM19CA0041X	
Power supply	U <sub>o</sub> = 27.7 V (up to hardware version 04, for supply of the following ELX signal terminals) U <sub>o</sub> = 27.0 V (from hardware version 05, for supply of the following ELX signal terminals) U <sub>m</sub> = 253 V <sub>AC</sub> (front connector)	

## 2.3 ELX9410 - Introduction

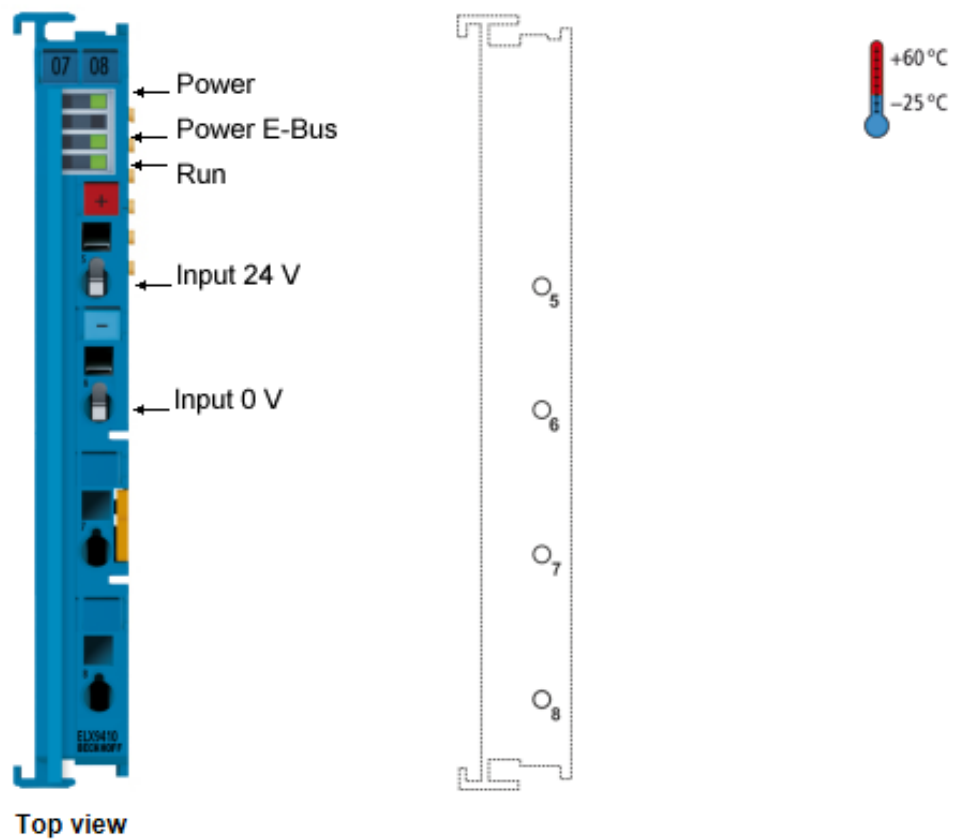

Fig. 5: ELX9410 - Power supply terminal for E-Bus refresh

The supply terminal ELX9410 generates an output voltage ( $5 V_{DC}$ ) from the input voltage ( $24 V_{DC}$ ) to supply the following ELX terminals. The supplied voltage and the voltage output in the E-Bus are continuously monitored. The operating status of the terminal is indicated by LEDs and can be read out for diagnostic purposes in the process image of the higher-level controller.

## 2.4 Technical data

Technical data		ELX9410-0000
Technology	terminal supply	
Short circuit proof	yes	
Input voltage	24 V <sub>DC</sub> (-15% / +20%)	
Output voltage	5 V to supply the E-Bus	
Output current	1 A	
Current consumption from the E-Bus	app. 45 mA	
Electrical isolation	500 V (E-Bus / field voltage)	
Diagnosis within the process image	yes	
Bit width in the process image	2 bit	
Special features	E-Bus feeding for ELX terminals	
Weight	app. 75 g	
Permissible ambient temperature range during operation	-25...+60°C	
Permissible ambient temperature range during storage	-40...+85°C	
Permissible relative humidity	95%, no condensation	
Permissible air pressure (operation, storage, transport)	800 hPa to 1100 hPa (this corresponds to a height of approx. -690 m to 2000 m over sea level assuming an international standard atmosphere)	
Dimensions (W x H x D)	app. 15 mm x 100 mm x 85 mm (aligned width: 12 mm)	
Mounting <a href="#">▶ 24</a>	on 35 mm mounting rail conforms to EN 60715	
Vibration / shock resistance	conforms to EN 60068-2-6 / EN 60068-2-27	
EMC immunity / emission	conforms to EN 61000-6-2 / EN 61000-6-4	
Protection class	IP20	
Permissible installation position	See chapter <a href="#">Installation position and minimum distances</a> <a href="#">▶ 23</a>	
Approvals / markings	CE, UL, ATEX, IECEx, cFMus	

Technical data for explosion protection		ELX9410-0000
Ex marking	ATEX	II 3 G Ex ec IIC T4 Gc
	IECEx	Ex ec IIC T4 Gc
	cFMus	Class I, Division 2, Groups A, B, C, D Class I, Zone 2, AEx/Ex ec IIC T4 Gc
Certificate numbers	BVS 18 ATEX E 005 X IECEx BVS 18.0005X FM19US0075X, FM19CA0041X	
Power supply	U <sub>m</sub> = 253 V <sub>AC</sub>	

## 2.5 ELX9012 - Introduction

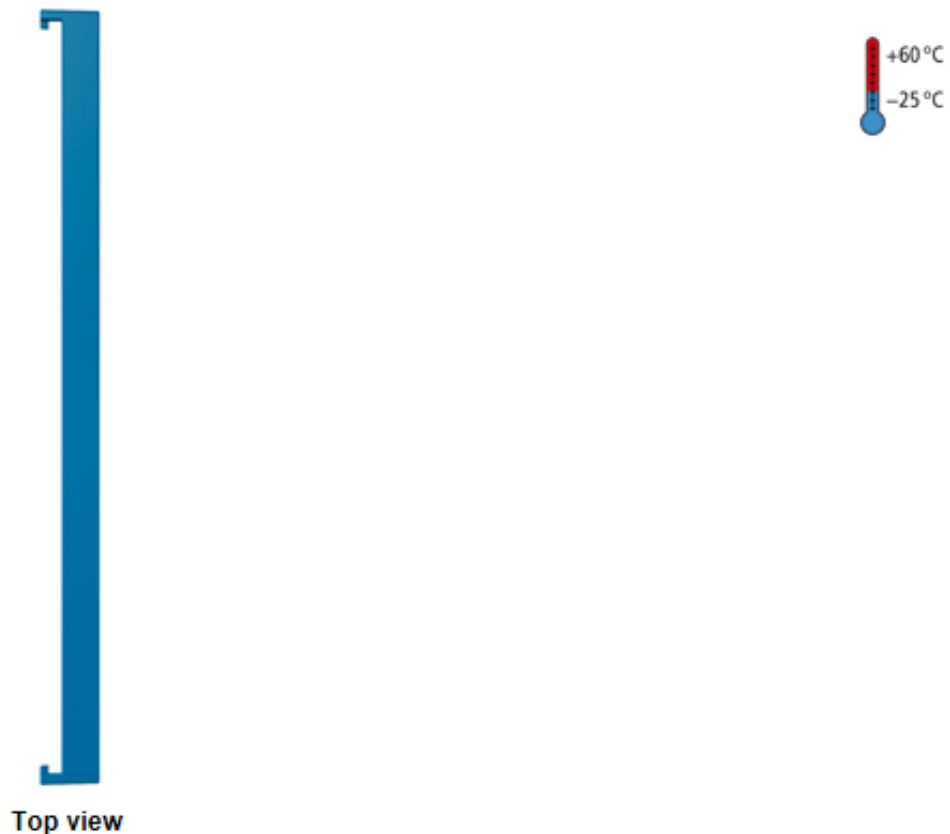

Fig. 6: ELX9012 - Bus end cover for ELXxxxx, cover for power and E-bus contacts, blue

The ELX9012 is used to terminate each ELX terminal segment and covers the power contacts according to IEC 60079-11, in addition to the E-bus contact. It is color-matched to the ELX terminal series.

## 2.6 Technical data

Technical data	ELX9012
Technology	bus end cover
Current consumption from E-Bus	0 mA
Special features	cover for power and E-Bus contacts
Weight	app. 16 g
Permissible ambient temperature range during operation	-25°C ... + 60°C
Permissible ambient temperature range during storage	-40°C ... + 85°C
Permissible relative humidity	95%, no condensation
Dimensions (W x H x D)	app. 7 mm x 100 mm x 55 mm (aligned width: 5 mm)
<a href="#">Mounting</a> [ <a href="#">▶ 24</a> ]	on 35 mm mounting rail conforms to EN 60715
Vibration / shock resistance	conforms to EN 60068-2-6 / EN 60068-2-27
EMC immunity / emission	conforms to EN 61000-6-2 / EN 61000-6-4
Protect. class	IP20
Permissible installation position	See chapter <a href="#">Installation position and minimum distances</a> [ <a href="#">▶ 23</a> ]
Approvals / markings	CE, UL, ATEX, IECEx, cFMus



## 2.7 Intended use

### WARNING

#### **Endangering the safety of persons and equipment!**

The ELX components may only be used for the purposes described below!

### CAUTION

#### **Observe ATEX and IECEx!**

The ELX components may only be used in accordance with the ATEX directive and the IECEx scheme!

The ELX terminals extend the field of application of the Beckhoff bus terminal system with functions for integrating intrinsically safe field devices from hazardous areas. The intended field of application is data acquisition and control tasks in discrete and process engineering automation, taking into account explosion protection requirements.

The ELX terminals are protected by the type of protection "Increased safety" (Ex e) according to IEC 60079-7 and must only be operated in hazardous areas of Zone 2 or in non-hazardous areas.

The field interfaces of the ELX terminals achieve explosion protection through the type of protection "intrinsic safety" (Ex i) according to IEC 60079-11. For this reason, only appropriately certified, intrinsically safe devices may be connected to the ELX terminals. Observe the maximum permissible connection values for voltages, currents and reactances. Any infringement can damage the ELX terminals and thus eliminate the explosion protection.

The ELX terminals are open, electrical equipment for installation in lockable cabinets, enclosures or operating rooms. Make sure that access to the equipment is only possible for authorized personnel.

### CAUTION

#### **Ensure traceability!**

The buyer has to ensure the traceability of the device via the Beckhoff Traceability Number (BTN).

## 3 Mounting and wiring

### 3.1 Special conditions of use for ELX terminals

#### ⚠ WARNING

##### Observe the special conditions of use for the intended use of Beckhoff ELX terminals in potentially explosive areas (ATEX directive 2014/34/EU)!

- The certified components are to be installed in a suitable housing that guarantees an ingress protection of at least IP54 in accordance with EN 60079-0 and EN 60529! The prescribed environmental conditions during installation, operation and maintenance are thereby to be taken into account! Inside the housing, pollution degree 1 and 2 are permissible.
- If the temperatures during rated operation are higher than 70°C at the feed-in points of cables, lines or pipes, or higher than 80°C at the wire branching points, then cables must be selected whose temperature data correspond to the actual measured temperature values!
- Observe the permissible ambient temperature range of -25 to +60°C of Beckhoff ELX terminals!
- Measures must be taken to protect against the rated operating voltage being exceeded by more than 40% due to short-term interference voltages! The power supply of the ELX9560 power supply terminal must correspond to overvoltage category II according to EN 60664-1
- The individual terminals may only be unplugged or removed from the bus terminal system if all supply voltages have been switched off or if a non-explosive atmosphere is ensured!
- The connections of the ELX9560 power supply terminal may only be connected or disconnected if all supply voltages have been switched off or if a non-explosive atmosphere is ensured!
- Address selectors and switches may only be adjusted if all supply voltages have been switched off or if a non-explosive atmosphere is ensured!

### 3.2 Installation notes for ELX terminals

#### NOTE

##### Storage, transport and mounting

- Transport and storage are permitted only in the original packaging!
- Store in a dry place, free from vibrations.
- A brand new ELX terminal with a certified build version is delivered only in a sealed carton. Therefore, check that the carton and all seals are intact before unpacking.
- Do not use the ELX terminal if
  - its packaging is damaged
  - the terminal is visibly damaged or
  - you cannot be sure of the origin of the terminal.
- ELX terminals with a damaged packaging seal are regarded as used.

#### ⚠ WARNING

##### Observe the accident prevention regulations

During mounting, commissioning, operation and maintenance, adhere to the safety regulations, accident prevention regulations and general technical rules applicable to your devices, machines and plants.

#### ⚠ CAUTION

##### Observe the erection regulations

Observe the applicable erection regulations.

**NOTE****Protect the terminals against electrostatic discharge (ESD)**

Electronic components can be destroyed by electrostatic discharge. Therefore, take the safety measures to protect against electrostatic discharge as described in DIN EN 61340-5-1 among others. In conjunction with this, ensure that the personnel and surroundings are suitably earthed.

**NOTE****Do not place terminals on E-bus contacts**

Do not place the ELX terminals on the E-bus contacts located on the right-hand side. The function of the E-bus contacts can be negatively affected by damage caused by this, e.g. scratches.

**NOTE****Protect the terminals against dirt**

To ensure the functionality of the ELX terminals they must be protected against dirt, especially on the contact points. For this reason use only clean tools and materials.

**NOTE****Handling**

- It is forbidden to insert conductive or non-conductive objects of any kind into the interior of the housing (e.g. through the ventilation slots in the housing).
- Use only the openings provided in the housing front and appropriate tools to actuate the spring-loaded terminal contacts on the front side for attaching connection cables to the terminal; see chapter [Wiring](#) [► 26].
- The opening of the housing, the removal of parts and any mechanical deformation or machining of an ELX terminal are not permitted!

If an ELX terminal is defective or damaged it must be replaced by an equivalent terminal. Do not carry out any repairs to the devices. For safety reasons repairs may only be carried out by the manufacturer.

**NOTE****Contact marking and pin assignment**

The colored inscription labels above the front connection contacts shown in the illustrations in the introduction chapter are only examples and are not part of the scope of delivery!

A clear assignment of channel and terminal designation according to the chapter contact assignment to the actual terminal point can be made via the lasered channel numbers 1 to 8 on the left above the respective terminal point as well as via the laser image.

Observe any possible polarity dependency of connected intrinsically safe circuits!

### 3.3 Arrangement of ELX terminals within a bus terminal block

**⚠ WARNING**

**Observe the following instructions for the arrangement of ELX terminals!**

- ELX signal terminals must always be installed behind an ELX9560 power supply terminal, without exception!
- Only signal terminals of the ELX series may be installed behind an ELX9560 power supply terminal!
- Multiple ELX9560 power supply terminals may be set in one terminal block as long as one ELX9410 is placed before each additional ELX9560!
- An ELX9410 power supply terminal must not be mounted to the right of an ELX9560 nor to the left of any ELX signal terminal!
- The last terminal of each ELX segment is to be covered by an ELX9012 bus end cover, unless two ELX9410 power supply terminals are installed in direct succession for continuing the same terminal segment with standard Beckhoff EtherCAT terminals (e.g. EL/ES/EK)!

**Examples for the arrangement of ELX terminals**

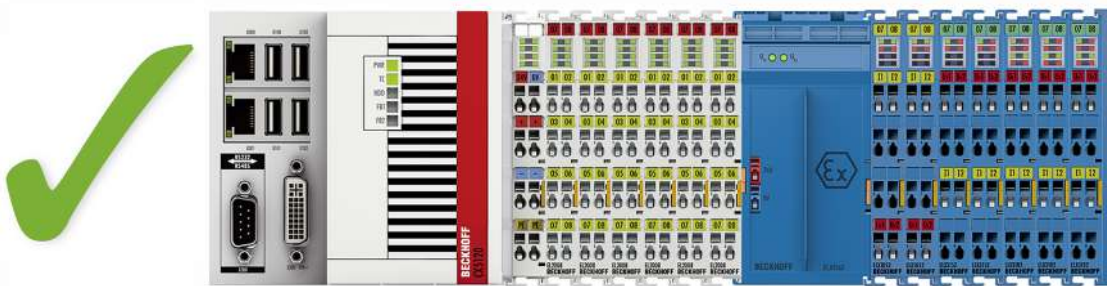

Fig. 7: Valid arrangement of the ELX terminals (right terminal block).

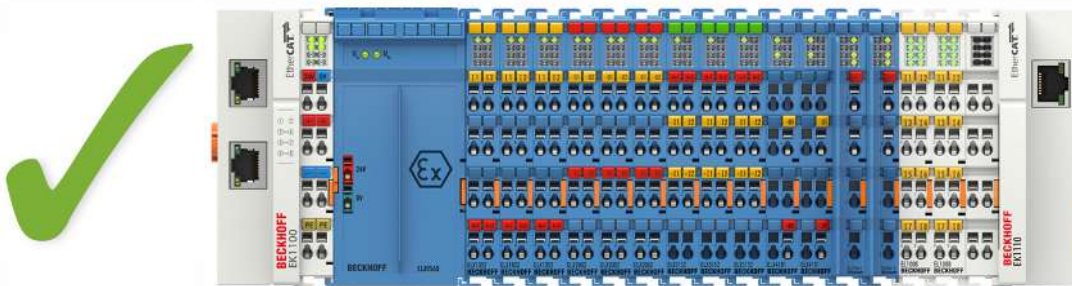

Fig. 8: Valid arrangement - terminals that do not belong to the ELX series are set before and after the ELX terminal segment. The separation is realized by the ELX9560 at the beginning of the ELX terminal segment and two ELX9410 at the end of the ELX terminal segment.



Fig. 9: Valid arrangement - multiple power supplies by ELX9560, each with an upstream ELX9410.

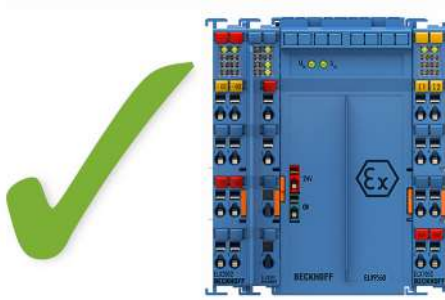

Fig. 10: Valid arrangement - ELX9410 in front of an ELX9560 power supply terminal.

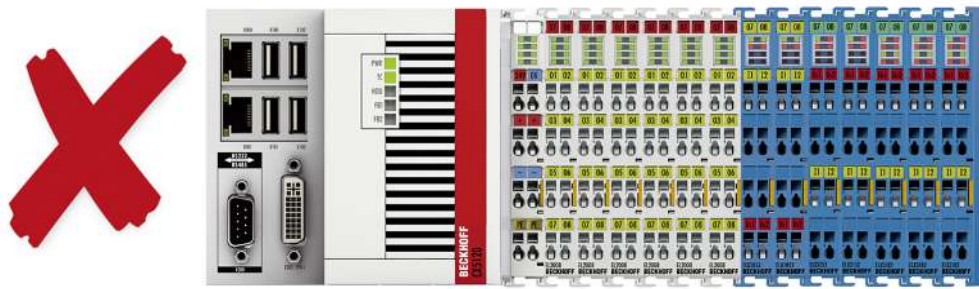

Fig. 11: Invalid arrangement - missing ELX9560 power supply terminal.

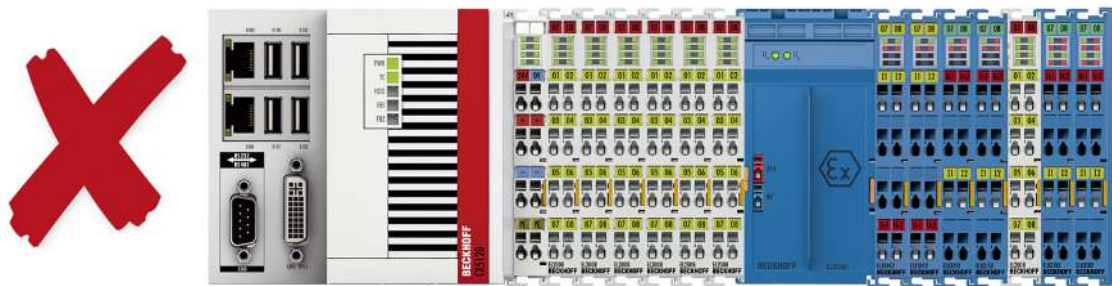

Fig. 12: Invalid arrangement - terminal that does not belong to the ELX series within the ELX terminal segment.

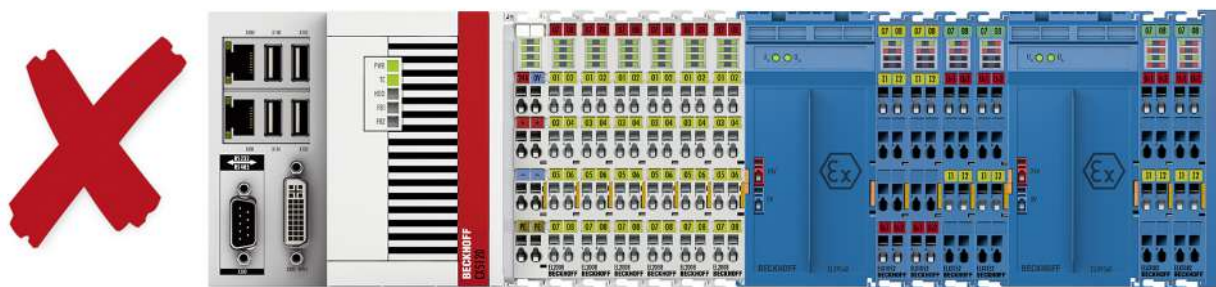

Fig. 13: Invalid arrangement - second ELX9560 power supply terminal within the ELX terminal segment without an upstream ELX9410.

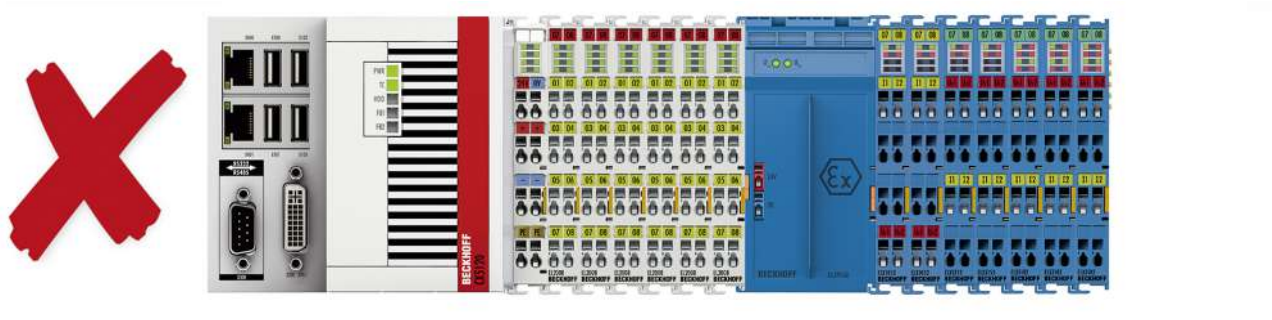

Fig. 14: Invalid arrangement - missing ELX9012 bus end cover.

### NOTE

#### Observe the maximum output current of the ELX9560

When configuring the ELX terminal segment, please note the maximum available output current of the ELX9560 power supply terminal in accordance with the specified technical data. If required, an additional power supply terminal ELX9560 with an upstream ELX9410 connected (see mounting examples) must be installed or a completely new terminal block must be assembled.

## 3.4 Installation position and minimum distances

### Installation position

For the prescribed installation position the mounting rail is installed horizontally and the mating surfaces of the ELX terminals point toward the front (see illustration below). The terminals are ventilated from below, which enables optimum cooling of the electronics through convection. The direction indication “down” corresponds to the direction of positive acceleration due to gravity.

### Minimum distances

Observe the following minimum distances to ensure optimum convection cooling:

- above and below the ELX terminals: 35 mm (required!)
- besides the bus terminal block: 20 mm (recommended)

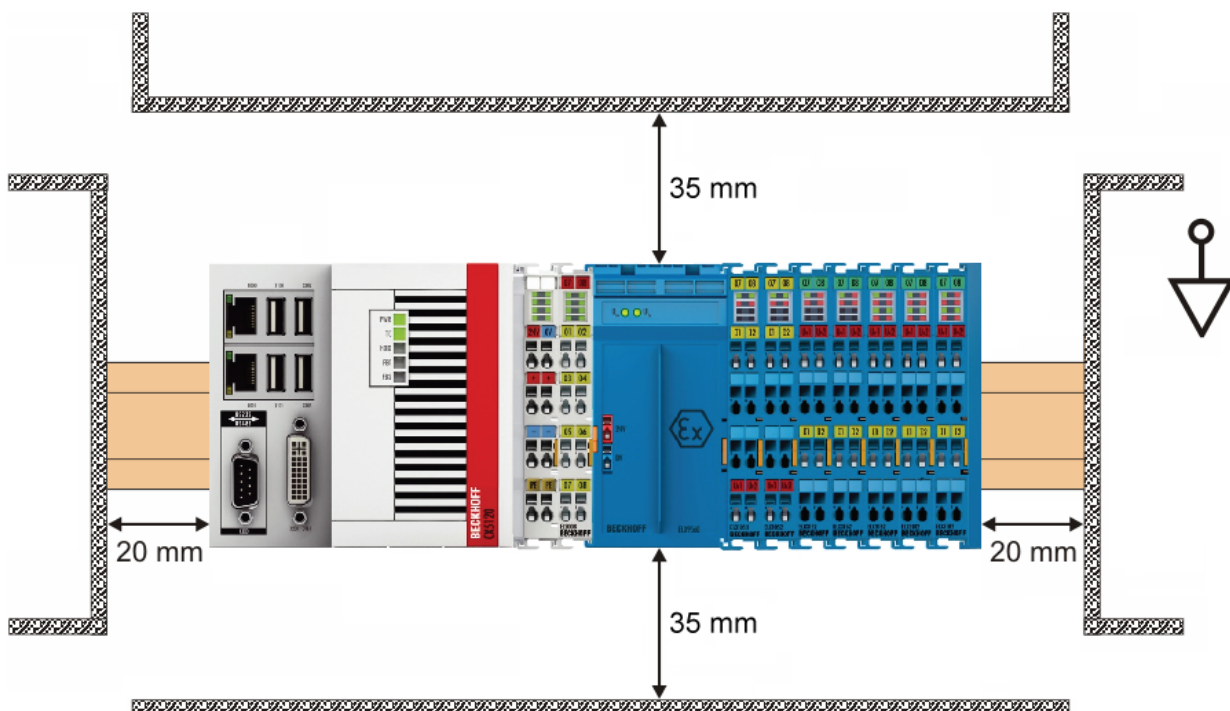

Fig. 15: Installation position and minimum distances

### ⚠ WARNING

#### Observe the minimum separation distances according to IEC 60079-14!

Observe the prescribed minimum separation distances between intrinsically safe and non-intrinsically safe circuits according to IEC 60079-14.

### 3.5 Installation of ELX terminals on mounting rails

#### ⚠ WARNING

##### Risk of electric shock and damage of device!

Bring the bus terminal system into a safe, powered down state before starting installation, disassembly or wiring of the bus terminals!

#### ⚠ CAUTION

##### Danger of injury due to power contacts!

For your own protection, pay attention to careful and careful handling of the ELX terminals. In particular, the left side mounted, sharp-edged blade contacts pose a potential risk of injury.

#### Assembly

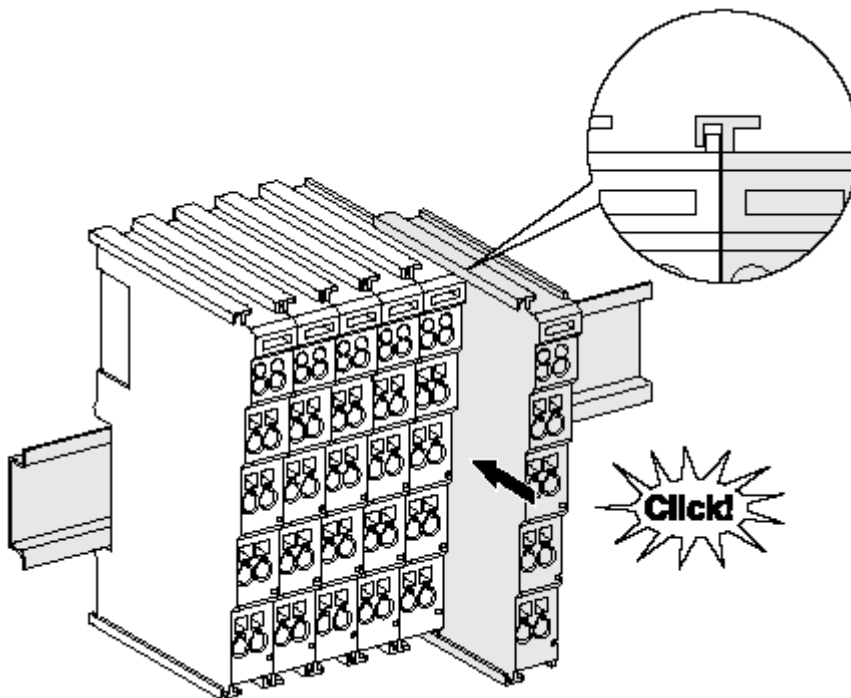

Fig. 16: Attaching on mounting rail

The bus coupler and bus terminals are attached to commercially available 35 mm mounting rails (DIN rails according to EN 60715) by applying slight pressure:

1. First attach the fieldbus coupler to the mounting rail.
2. The bus terminals are now attached on the right-hand side of the fieldbus coupler. Join the components with tongue and groove and push the terminals against the mounting rail, until the lock clicks onto the mounting rail.

If the terminals are clipped onto the mounting rail first and then pushed together without tongue and groove, the connection will not be operational! When correctly assembled, no significant gap should be visible between the housings.

#### ● Fixing of mounting rails

**i** The locking mechanism of the terminals and couplers extends to the profile of the mounting rail. At the installation, the locking mechanism of the components must not come into conflict with the fixing bolts of the mounting rail. To mount the mounting rails with a height of 7.5 mm under the terminals and couplers, you should use flat mounting connections (e.g. countersunk screws or blind rivets).



Disassembly

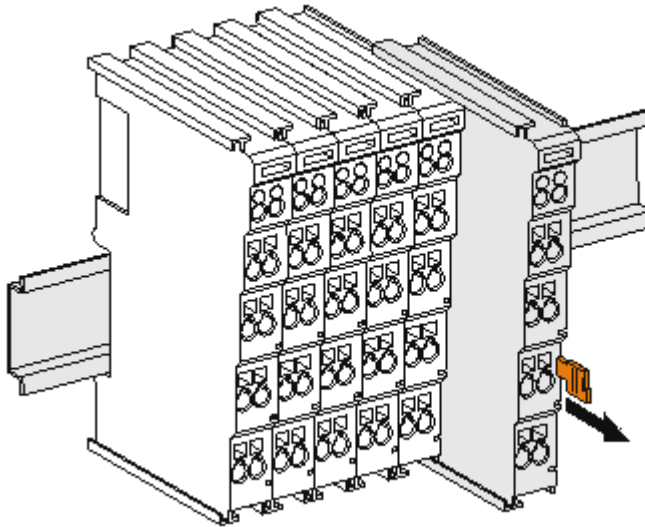

Fig. 17: Disassembling of terminal

Each terminal is secured by a lock on the mounting rail, which must be released for disassembly:

1. Pull the terminal by its orange-colored lugs approximately 1 cm away from the mounting rail. In doing so for this terminal the mounting rail lock is released automatically and you can pull the terminal out of the bus terminal block easily without excessive force.
2. Grasp the released terminal with thumb and index finger simultaneous at the upper and lower grooved housing surfaces and pull the terminal out of the bus terminal block.

**Connections within a bus terminal block**

The electric connections between the Bus Coupler and the Bus Terminals are automatically realized by joining the components:

- The six spring contacts of the E-Bus deal with the transfer of the data and the supply of the Bus Terminal electronics.
- The power contacts deal with the supply for the field electronics and thus represent a supply rail within the bus terminal block.  
The power contacts of the ELX terminals are supplied by the ELX9560 power terminal. This interrupts the power contacts and thus represents the beginning of a new supply rail.

**i Power Contacts**

During the design of a bus terminal block, the pin assignment of the individual Bus Terminals must be taken account of, since some types (e.g. analog Bus Terminals or digital 4-channel Bus Terminals) do not or not fully loop through the power contacts.

**3.6 Connection**

**3.6.1 Connection system**

**⚠ WARNING**

**Risk of electric shock and damage of device!**

Bring the bus terminal system into a safe, powered down state before starting installation, disassembly or wiring of the bus terminals!

The terminals of ELXxxxx series include electronics and connection level in a single enclosure.

**Standard wiring**

Fig. 18: Standard wiring

The terminals of ELXxxx series feature integrated screwless spring force technology for fast and simple assembly.

**High Density Terminals (HD Terminals)**Fig. 19: *High Density Terminals*

The Bus Terminals from these series with 16 connection points are distinguished by a particularly compact design, as the packaging density is twice as large as that of the standard 12 mm Bus Terminals. Massive conductors and conductors with a wire end sleeve can be inserted directly into the spring loaded terminal point without tools.

**Ultrasonically "bonded" (ultrasonically welded) conductors**

**i** **Ultrasonically "bonded" conductors**

It is also possible to connect the Standard and High Density Terminals with ultrasonically "bonded" (ultrasonically welded) conductors. In this case, please note the tables concerning the wire-size width below!

**3.6.2 Wiring**

**⚠ WARNING**

**Risk of electric shock and damage of device!**

Bring the bus terminal system into a safe, powered down state before starting installation, disassembly or wiring of the bus terminals!

Terminals for standard wiring

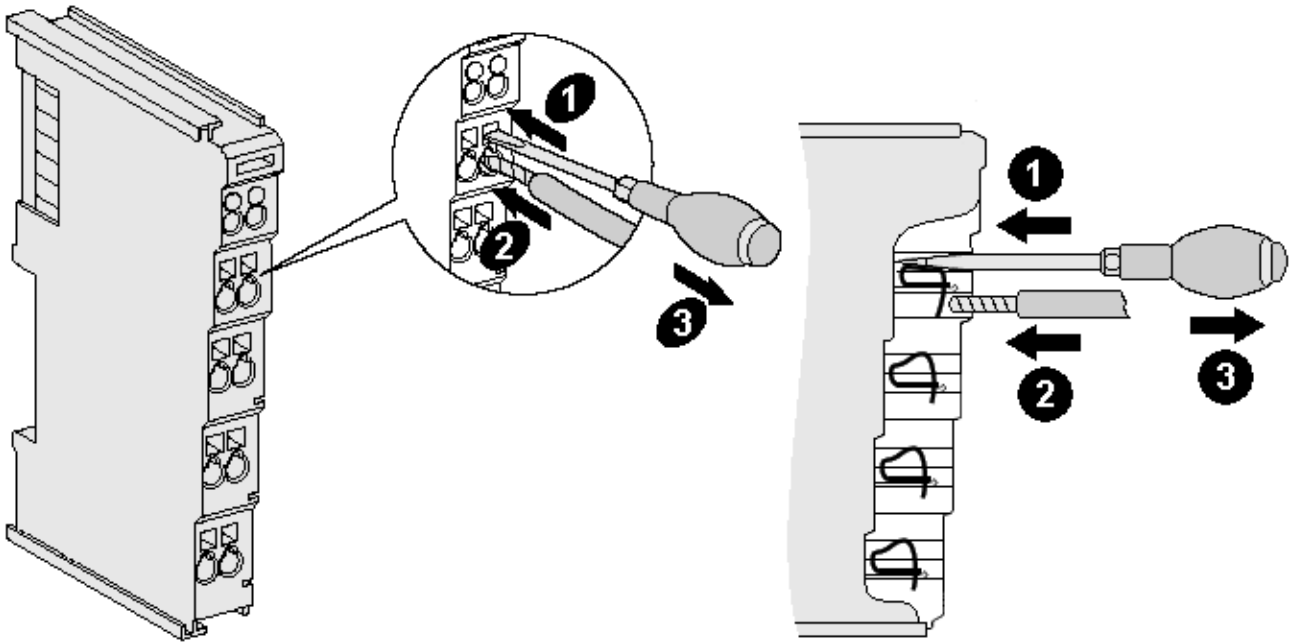

Fig. 20: Connecting a cable on a terminal point

Up to eight terminal points enable the connection of solid or finely stranded cables to the Bus Terminal. The terminal points are implemented in spring force technology. Connect the cables as follows:

1. Open a terminal point by pushing a screwdriver straight against the stop into the square opening above the terminal point. Do not turn the screwdriver or move it alternately (don't toggle).
2. The wire can now be inserted into the round terminal opening without any force.
3. The terminal point closes automatically when the pressure is released, holding the wire securely and permanently.

Observe the requirements for connecting cables and cross sections according to IEC 60079-7 and IEC 60079-11. See the following tables for the suitable wire size width.

Terminal housing	Standard wiring	ELX9560
Wire size width (single core wires)	0.08 ... 2.5 mm <sup>2</sup>	0.14 ... 1.5 mm <sup>2</sup>
Wire size width (fine-wire conductors)	0.08 ... 2.5 mm <sup>2</sup>	0.14 ... 1.5 mm <sup>2</sup>
Wire size width (conductors with a wire end sleeve)	0.14 ... 1.5 mm <sup>2</sup>	0.14 ... 1.0 mm <sup>2</sup>
Wire stripping length	8 ... 9 mm	8 ... 9 mm

**NOTE**

**Maximum screwdriver width for ELX9560**

Use a screwdriver with a maximum width of 2 mm to wire the ELX9560 power supply terminal. Wider screwdrivers can damage the terminal points.

**High Density Terminals (HD Terminals) with 16 terminal points**

The conductors of the HD Terminals are connected without tools for single-wire conductors using the direct plug-in technique, i.e. after stripping the wire is simply plugged into the terminal point. The cables are released, as usual, using the contact release with the aid of a screwdriver. See the following table for the suitable wire size width.

Terminal housing	High Density Housing
Wire size width (single core wires)	0.08 ... 1.5 mm <sup>2</sup>
Wire size width (fine-wire conductors)	0.25 ... 1.5 mm <sup>2</sup>
Wire size width (conductors with a wire end sleeve)	0.14 ... 0.75 mm <sup>2</sup>
Wire size width (ultrasonically "bonded" conductors)	only 1.5 mm <sup>2</sup>
Wire stripping length	8 ... 9 mm

### 3.6.3 Proper line connection

Always connect only one wire per terminal point.

When using fine-wire conductors it is recommended to connect them with wire end sleeves in order to establish a safe, conductive connection.

In addition, make sure that the pin assignment is correct to prevent damage to the ELX terminals and the connected devices.

### 3.6.4 Shielding and potential separation



#### Shielding

Encoder, analog sensors and actors should always be connected with shielded, twisted paired wires.

#### CAUTION

##### Observe installation requirements in areas of potentially explosive atmospheres!

During installation, observe the requirements for cables, shielding and earth potential equalization in areas of potentially explosive atmospheres according to IEC 60079-11, IEC 60079-14 and IEC 60079-25.

#### WARNING

##### Ensure potential separation of the 24 V Ex busbar!

In any case, make sure that the galvanic isolation made by the ELX9560 between the 24 V Ex busbar (power contacts +24 V Ex and 0 V Ex) and other system potentials (if applicable also functional or protective earths) is not removed.

### 3.6.5 ELX9560 - Contact assignment

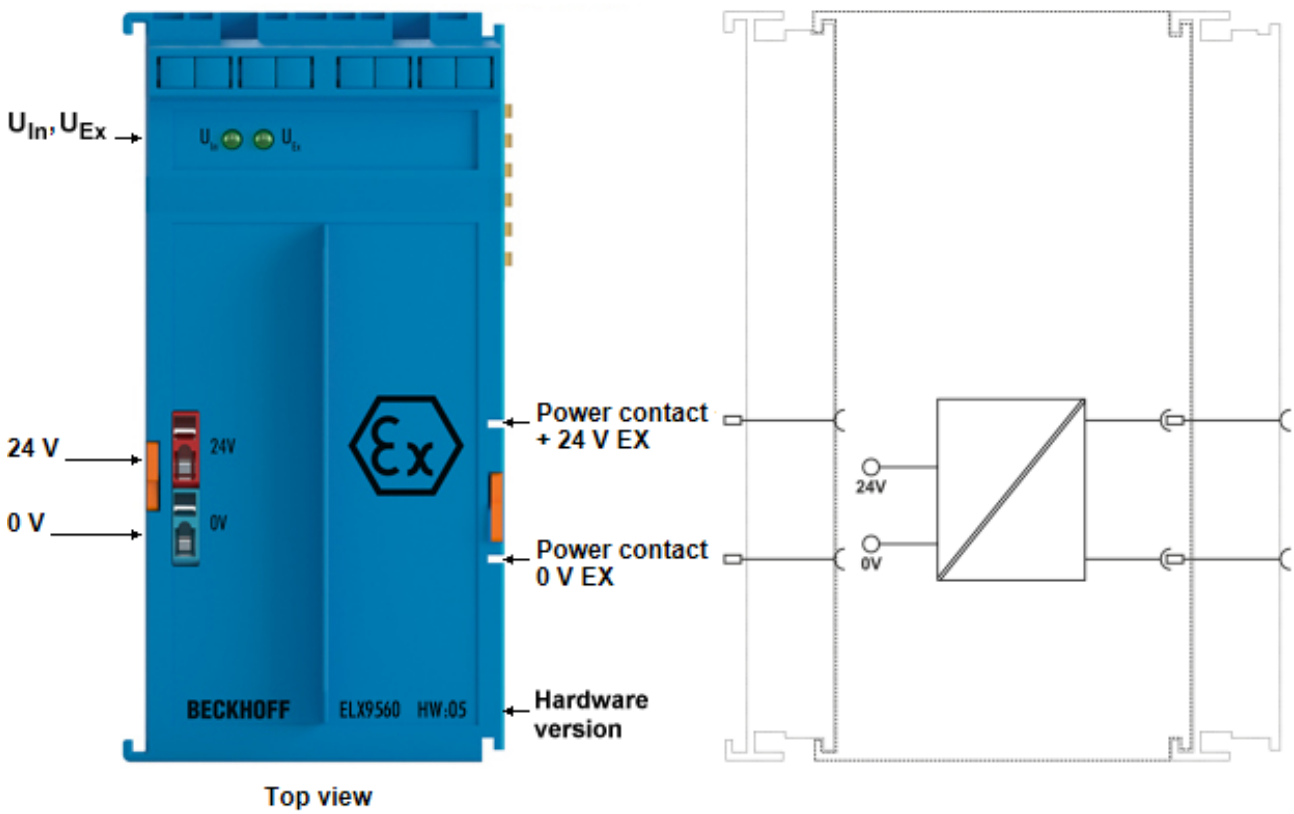

Fig. 21: ELX9560 - Contact assignment

Terminal point	Description
24 V	24 V <sub>DC</sub> input
0 V	0 V <sub>DC</sub> input

#### NOTE

##### Maximum screwdriver width for ELX9560

Use a screwdriver with a maximum width of 2 mm to wire the ELX9560 power supply terminal. Wider screwdrivers can damage the terminal points.

#### LED display

LED	Color	State	Meaning
U <sub>in</sub>	green	on	24 V <sub>DC</sub> input present
U <sub>Ex</sub>	green	on	24 V Ex present

### 3.6.6 ELX9410 Contact assignment

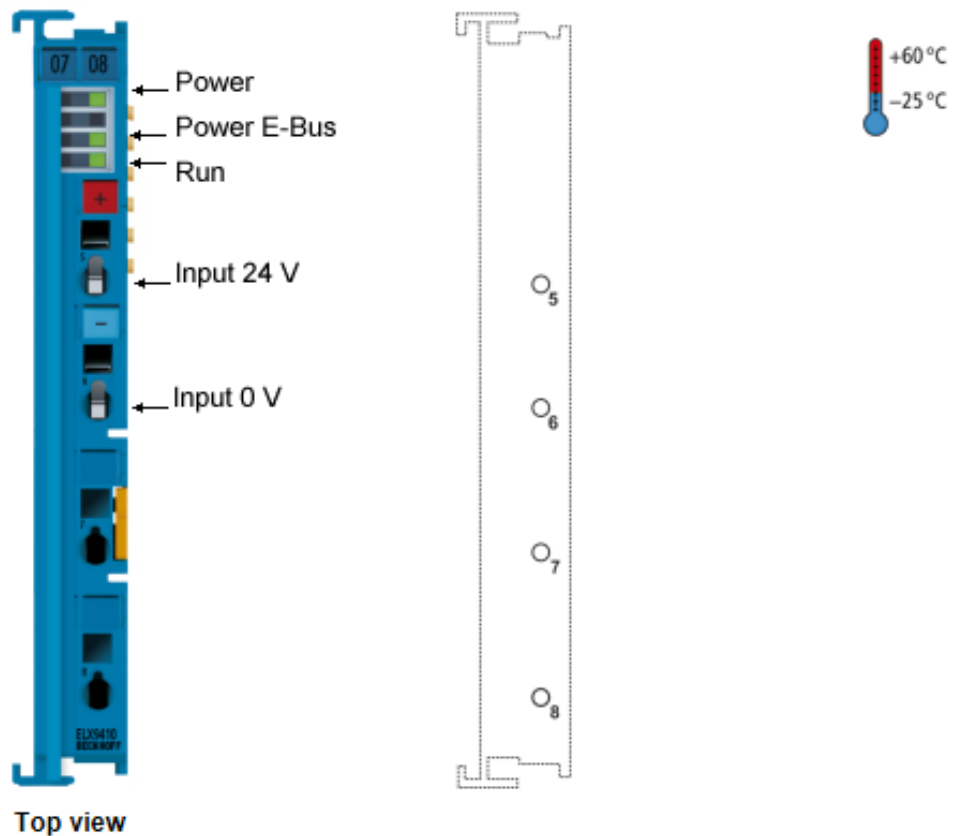

Fig. 22: ELX9410 - Contact assignment



Terminal point	Description
Input 24 V	24 V <sub>DC</sub> input
Input 0 V	0 V <sub>DC</sub> input

#### LED display

LED	Color	State	Meaning
Power	green	on	24 V <sub>DC</sub> input present
Power E-Bus	green	on	E-Bus supply present (5 V <sub>DC</sub> )
Run	green	This LED indicates the terminal's operating state:	
		off	State of the EtherCAT State Machine: <b>INIT</b> = initialization of the terminal
		flashing	State of the EtherCAT State Machine: <b>PREOP</b> = function for mailbox communication and different standard-settings set
		single flash	State of the EtherCAT State Machine: <b>SAFEOP</b> = verification of the Sync Manager channels and the distributed clocks. Outputs remain in safe state
		on	State of the EtherCAT State Machine: <b>OP</b> = normal operating state; mailbox and process data communication is possible
		flickering	State of the EtherCAT State Machine: <b>BOOTSTRAP</b> = function for firmware updates of the terminal

## 4 Appendix

### 4.1 UL notice

	<p><b>Application</b> Beckhoff EtherCAT modules are intended for use with Beckhoff's UL Listed EtherCAT System only.</p>
	<p><b>Examination</b> For cULus examination, the Beckhoff I/O System has only been investigated for risk of fire and electrical shock (in accordance with UL508 and CSA C22.2 No. 142).</p>
	<p><b>For devices with Ethernet connectors</b> Not for connection to telecommunication circuits.</p>

#### Basic principles

Two UL certificates are met in the Beckhoff EtherCAT product range, depending upon the components:

1. UL certification according to UL508. Devices with this kind of certification are marked by this sign:



2. UL certification according to UL508 with limited power consumption. The current consumed by the device is limited to a max. possible current consumption of 4 A. Devices with this kind of certification are marked by this sign:

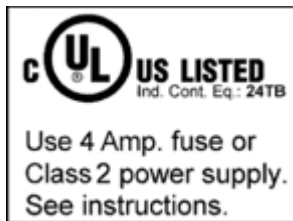

Almost all current EtherCAT products (as at 2010/05) are UL certified without restrictions.

#### Application

If terminals certified *with restrictions* are used, then the current consumption at 24 V<sub>DC</sub> must be limited accordingly by means of supply

- from an isolated source protected by a fuse of max. 4 A (according to UL248) or
- from a voltage supply complying with *NEC class 2*.  
A voltage source complying with *NEC class 2* may not be connected in series or parallel with another *NEC class 2* compliant voltage supply!

These requirements apply to the supply of all EtherCAT bus couplers, power adaptor terminals, Bus Terminals and their power contacts.

## 4.2 FM notice

### Special notice regarding ANSI/ISA Ex

**⚠ WARNING**

**Observe the permissible range of application!**

The I/O modules of the ELX series may only be used in potentially explosive areas of Class I, Division 2, Group A, B, C, D or in non-explosive areas!

**⚠ WARNING**



**Consider the *Control Drawing ELX* documentation!**

When installing the I/O modules of the ELX series, be sure to read the *Control Drawing ELX* documentation, which is available in the download area of your ELX terminal on <https://www.beckhoff.com/ELXxxxx>!



## 4.3 Support and Service

Beckhoff and their partners around the world offer comprehensive support and service, making available fast and competent assistance with all questions related to Beckhoff products and system solutions.

### Beckhoff's branch offices and representatives

Please contact your Beckhoff branch office or representative for local support and service on Beckhoff products!

The addresses of Beckhoff's branch offices and representatives round the world can be found on her internet pages: <https://www.beckhoff.com>

You will also find further documentation for Beckhoff components there.

### Beckhoff Support

Support offers you comprehensive technical assistance, helping you not only with the application of individual Beckhoff products, but also with other, wide-ranging services:

- support
- design, programming and commissioning of complex automation systems
- and extensive training program for Beckhoff system components

Hotline: +49 5246 963 157  
Fax: +49 5246 963 9157  
e-mail: [support@beckhoff.com](mailto:support@beckhoff.com)

### Beckhoff Service

The Beckhoff Service Center supports you in all matters of after-sales service:

- on-site service
- repair service
- spare parts service
- hotline service

Hotline: +49 5246 963 460  
Fax: +49 5246 963 479  
e-mail: [service@beckhoff.com](mailto:service@beckhoff.com)

### Beckhoff Headquarters

Beckhoff Automation GmbH & Co. KG

Huelshorstweg 20  
33415 Verl  
Germany

Phone: +49 5246 963 0  
Fax: +49 5246 963 198  
e-mail: [info@beckhoff.com](mailto:info@beckhoff.com)  
web: <https://www.beckhoff.com>

## Table of figures

Fig. 1	ELX2008-0000 with date code 2519HMHM, BTN 0001f6hd and Ex marking .....	9
Fig. 2	ELX9560-0000 with date code 12150000, BTN 000b000 and Ex marking .....	10
Fig. 3	ELX9012 with date code 12174444, BTN 0000b0si and Ex marking .....	11
Fig. 4	ELX9560 - power supply terminal, 24 VDC, electrically isolated .....	12
Fig. 5	ELX9410 - Power supply terminal for E-Bus refresh .....	14
Fig. 6	ELX9012 - Bus end cover for ELXxxxx, cover for power and E-bus contacts, blue .....	16
Fig. 7	Valid arrangement of the ELX terminals (right terminal block). .....	20
Fig. 8	Valid arrangement - terminals that do not belong to the ELX series are set before and after the ELX terminal segment. The separation is realized by the ELX9560 at the beginning of the ELX terminal segment and two ELX9410 at the end of the ELX terminal segment. ....	20
Fig. 9	Valid arrangement - multiple power supplies by ELX9560, each with an upstream ELX9410. ...	20
Fig. 10	Valid arrangement - ELX9410 in front of an ELX9560 power supply terminal.....	21
Fig. 11	Invalid arrangement - missing ELX9560 power supply terminal.....	21
Fig. 12	Invalid arrangement - terminal that does not belong to the ELX series within the ELX terminal segment. ....	21
Fig. 13	Invalid arrangement - second ELX9560 power supply terminal within the ELX terminal segment without an upstream ELX9410.....	21
Fig. 14	Invalid arrangement - missing ELX9012 bus end cover. ....	22
Fig. 15	Installation position and minimum distances .....	23
Fig. 16	Attaching on mounting rail .....	24
Fig. 17	Disassembling of terminal.....	25
Fig. 18	Standard wiring.....	26
Fig. 19	High Density Terminals.....	26
Fig. 20	Connecting a cable on a terminal point .....	27
Fig. 21	ELX9560 - Contact assignment.....	29
Fig. 22	ELX9410 - Contact assignment.....	30



More Information:  
[www.beckhoff.com/ELXxxxx](http://www.beckhoff.com/ELXxxxx)

Beckhoff Automation GmbH & Co. KG  
Hülshorstweg 20  
33415 Verl  
Germany  
Phone: +49 5246 9630  
[info@beckhoff.com](mailto:info@beckhoff.com)  
[www.beckhoff.com](http://www.beckhoff.com)

