

Manual | EN

CX2100-0014

Power supply unit for CX20xx



Table of contents

1	Notes on the documentation	5
1.1	Representation and structure of warnings	6
1.2	Related documents	7
1.3	Documentation issue status	7
2	For your safety	8
2.1	Intended use	8
2.2	Staff qualification	8
2.3	Safety instructions	8
3	Transport and storage	10
4	Product overview	11
4.1	Configuration of the CX2100-0014 power supply unit.....	12
4.2	Name plate	13
5	Commissioning	14
5.1	Mounting	14
5.1.1	Attaching the power supply unit	14
5.1.2	Installing the bar clips.....	14
5.1.3	Note the permissible installation positions	16
5.1.4	Attaching on mounting rail.....	18
5.1.5	Installing passive EtherCAT Terminals	19
5.2	Power supply.....	20
5.2.1	Connect Embedded PC	20
5.2.2	Observe the UL requirements	22
6	Configuration	23
6.1	Display	23
6.1.1	Character representation	23
6.1.2	Displaying texts	24
6.2	Operating principle of the button	34
6.3	Example Program	36
7	Error handling and diagnostics	39
7.1	Diagnostics in the PLC program	39
7.2	K-bus	41
7.3	E-bus	44
8	Decommissioning	45
8.1	Removing cables.....	45
8.2	Disassembling the power supply unit.....	45
9	Technical data	48
10	Appendix	49
10.1	Certifications	49
10.2	Support and Service.....	50
11	List of tables	51
12	List of figures	52

1 Notes on the documentation

This description is intended exclusively for trained specialists in control and automation technology who are familiar with the applicable national standards.

For installation and commissioning of the components, it is absolutely necessary to comply with the documentation and the following notes and explanations.

The qualified personnel is always obliged to use the currently valid documentation.

The responsible staff must ensure that the application or use of the products described satisfies all safety requirements, including all the relevant laws, regulations, guidelines, and standards.

Disclaimer

The documentation has been prepared with care. The products described are, however, constantly under development.

We reserve the right to revise and change the documentation at any time and without notice.

No claims to modify products that have already been supplied may be made on the basis of the data, diagrams, and descriptions in this documentation.

Trademarks

Beckhoff®, TwinCAT®, TwinCAT/BSD®, TC/BSD®, EtherCAT®, EtherCAT G®, EtherCAT G10®, EtherCAT P®, Safety over EtherCAT®, TwinSAFE®, XFC®, XTS® and XPlanar® are registered and licensed trademarks of Beckhoff Automation GmbH.

If third parties make use of designations or trademarks used in this publication for their own purposes, this could infringe upon the rights of the owners of the said designations.

Patents

The EtherCAT Technology is covered by the following patent applications and patents, without this constituting an exhaustive list:

EP1590927, EP1789857, EP1456722, EP2137893, DE102015105702

and similar applications and registrations in several other countries.

EtherCAT 

EtherCAT® is registered trademark and patented technology, licensed by Beckhoff Automation GmbH, Germany

Copyright

© Beckhoff Automation GmbH & Co. KG, Germany.

The distribution and reproduction of this document, as well as the use and communication of its contents without express authorization, are prohibited.

Offenders will be held liable for the payment of damages. All rights reserved in the event that a patent, utility model, or design are registered.

1.1 Representation and structure of warnings

The following warnings are used in the documentation. Read and follow the warnings.

Warnings relating to personal injury:

⚠ DANGER

Hazard with high risk of death or serious injury.

⚠ WARNING

Hazard with medium risk of death or serious injury.

⚠ CAUTION

There is a low-risk hazard that can result in minor injury.

Warnings relating to damage to property or the environment:

NOTICE

There is a potential hazard to the environment and equipment.

Notes showing further information or tips:



This notice provides important information that will be of assistance in dealing with the product or software. There is no immediate danger to product, people or environment.

1.2 Related documents

This documentation contains and describes material that is relevant for the CX2100-0014 power supply unit. The CX2100-0014 power supply unit is part of a modular system and belongs to the CX2000 Embedded PC series. Further information on the devices of the CX2000 Embedded PC series can be found in the associated documentation. Read and follow in particular the sections on safety in this documentation.

The following important documentation can be viewed at and downloaded from the Beckhoff website:
<http://www.beckhoff.de>

Document name
CX20x0 multi-core

Retaining the documentation

This documentation is part of the CX2100-0014 power supply unit. Keep the documentation in the immediate vicinity of the device throughout its entire service life. Ensure that personnel have access to the documentation at all times. Pass on the documentation to subsequent users, and in addition ensure that all supplementary information is included in the documentation.

1.3 Documentation issue status

Version	Modifications
1.0	First version
1.1	Chapter "Mounting passive EtherCAT Terminals" adapted and chapter "Display" revised.
1.2	Chapter "Commissioning" updated.
1.3	Editorial corrections

2 For your safety

Read the chapter on safety and follow the instructions in order to protect from personal injury and damage to equipment.

Limitation of liability

All the components are supplied in particular hardware and software configurations appropriate for the application. Unauthorized modifications and changes to the hardware or software configuration, which go beyond the documented options, are prohibited and nullify the liability of Beckhoff Automation GmbH & Co. KG.

In addition, the following actions are excluded from the liability of Beckhoff Automation GmbH & Co. KG:

- Failure to comply with this documentation.
- Improper use.
- Use of untrained personnel.
- Use of unauthorized replacement parts.

2.1 Intended use

The CX2100-0014 power supply unit is part of a modular control system and is intended for mounting on a DIN rail. The system is scalable, so that the basic PC modules, power supply units, system modules and extension modules can be assembled and installed in the control cabinet or terminal box as required.

The CX2100-0014 power supply unit supplies power to the Embedded PCs of the CX2000 series, the system modules and the extension modules. The Embedded PCs of the CX2000 series are then used together with bus terminals to receive digital and analog signals from sensors and output them to actuators or forward them to higher-level controllers.

The CX2100-0014 power supply units are designed for a working environment that meets the requirements of protection class IP20. This involves finger protection and protection against solid foreign objects up to 12.5 mm, but not protection against water. Operation of the devices in wet and dusty environments is not permitted, unless specified otherwise. The specified limits for electrical and technical data must be adhered to.

Improper use

The power supply unit is not suitable for operation in the following areas:

- Hazardous area.
- Areas with an aggressive environment, e.g. aggressive gases or chemicals.
- Living areas. In living areas, the relevant standards and guidelines for interference emissions must be adhered to, and the devices must be installed in housings or control boxes with suitable attenuation of shielding.

2.2 Staff qualification

All operations involving Beckhoff software and hardware may only be carried out by qualified personnel with knowledge of control and automation engineering. The qualified personnel must have knowledge of the administration of the Industrial PC and the associated network.

All interventions must be carried out with knowledge of control programming, and the qualified personnel must be familiar with the current standards and guidelines for the automation environment.

2.3 Safety instructions

The following safety instructions must be followed during installation and working with networks and the software.

Mounting

- Never work on live equipment. Always switch off the power supply for the device before installation, troubleshooting or maintenance. Protect the device against unintentional switching on.
- Observe the relevant accident prevention regulations for your machine (e.g. the BGV A 3, electrical systems and equipment).
- Ensure standard-compliant connection and avoid risks to personnel. Ensure that data and supply cables are laid in a standard-compliant manner and ensure correct pin assignment.
- Observe the relevant EMC guidelines for your application.
- Avoid polarity reversal of the data and supply cables, as this may cause damage to the equipment.
- The devices contain electronic components, which may be destroyed by electrostatic discharge when touched. Observe the safety precautions against electrostatic discharge according to DIN EN 61340-5-1/-3.

Working with networks

- Restrict access to all devices to an authorized circle of persons.
- Change the default passwords to reduce the risk of unauthorized access. Regularly change the passwords.
- Protect the devices with a firewall.
- Apply the IT security precautions according to IEC 62443, in order to limit access to and control of devices and networks.

Working with the software

- Use up-to-date security software. The safe function of the PC can be compromised by malicious software such as viruses or Trojans.
- The sensitivity of a PC against malicious software increases with the number of installed and active software.
- Uninstall or disable unnecessary software.

Further information about the safe handling of networks and software can be found in the Beckhoff Information System:

<http://infosys.beckhoff.de>

Document name
Documentation about IPC Security

3 Transport and storage

Transport

NOTICE

Short circuit due to moisture

Moisture can form during transport in cold weather or in the event of large temperature fluctuations.

- Avoid moisture formation (condensation) in the power supply unit and leave the power supply unit to adjust to room temperature slowly. If condensation has occurred, wait at least 12 hours before switching on the power supply unit.

Despite the robust design of the unit, the components are sensitive to strong vibrations and impacts. During transport, protect the power supply unit against:

- high mechanical stress and
- use the original packaging for shipping.

Table 1: Dimensions and weights.

Technical data	CX2100-0014
Dimensions (W x H x D)	60 mm x 100 mm x 91 mm
Weight	550 g

Storage

- Store the power supply unit in a dry environment at an ambient temperature between -40° C ... +85° C.
- Store the power supply unit in its original packaging.

4 Product overview

The CX2100-0014 power supply unit supplies power to the Embedded PCs of the CX2000 series. The power supply unit is suitable for all Embedded PCs of the CX2000 series. Additional components such as system, expansion and fieldbus modules are also provided.

Display

The power supply unit CX2100-0014 has an FSTN LCD display with 2 x 16 characters, a selector switch and an Enter key. This allows internal status values as well as custom display parameters or menus, with and without input options, to be queried. The power supply units are controlled via TwinCAT.

Power supply terminal

On the right side of the power supply unit is the power supply terminal with connections for the power supply. Bus Terminals (K-bus) or EtherCAT Terminals (E-bus) can be attached on the right-hand side of the power supply terminal. The power supply terminal automatically recognizes the respective bus system (K-bus or E-bus).

Further power supply units

A total of four different power supply units are available for the Embedded PCs of the CX2000 series:

- CX2100-0004: E-bus/K-bus power supply unit with automatic switchover.
- CX2100-0014: E-bus/K-bus power supply unit with automatic switchover and passive ventilation.
- CX2100-0904: E-bus/K-bus power supply unit with automatic switchover and integrated capacitive UPS.
- CX2100-0914: E-bus/K-bus power supply unit with automatic switchover and integrated electronic charging unit for external battery packs in order to maintain UPS functionality.

Whether a power supply unit can be used together with a specific Embedded PC of the CX2000 series depends on the embedded PC used, the installation position and whether the embedded PC has active cooling.

Table 2: Other power supply units and compatible Embedded PCs from the CX2000 series.

Embedded PC	CX2100-0004	CX2100-0014	CX2100-0904	CX2100-0914
CX2020	X	X	X	X
CX2030	X	X	X	X
CX2040	-	X	-	X
CX2020 (with fan)	-	X	-	X
CX2030 (with fan)	-	X	-	X
CX2042	-	X	-	X
CX2062	-	X	-	-
CX2072	-	X	-	-
CX2033	X*	X	X*	X
CX2043	-	X	-	X
CX2033 (with fan)		X		X

* Can be used if the total load does not exceed 45 W, e.g. due to USB devices or CX25xx modules.

4.1 Configuration of the CX2100-0014 power supply unit

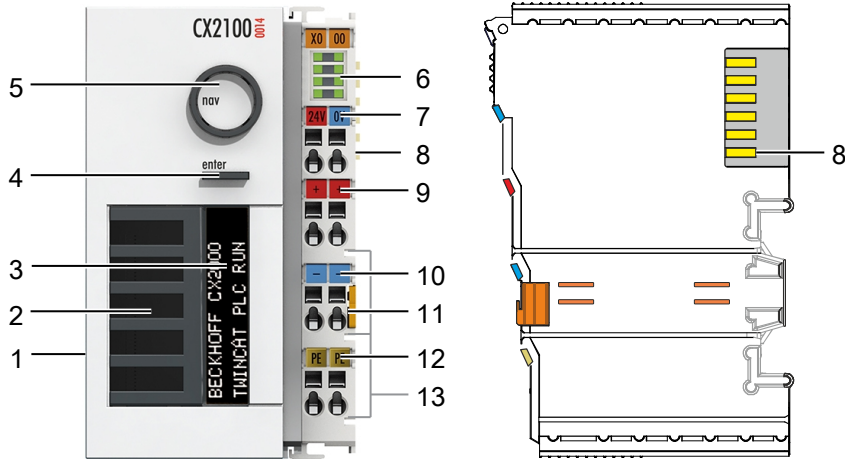

Fig. 1: Configuration of the CX2100-0014 power supply unit.

Table 3: Legend for the configuration.

No.	Component	Description
1	Multi-pole connection	For connection to the basic CPU module on the right.
2	Ventilation openings	Additional ventilation openings for passive cooling.
3	FSTN LCD display [► 23]	Status display with 2 x 16 characters and backlight.
4	Enter key [► 34]	Allows input and query of internal status values.
5	Selector switch [► 34]	For navigation in menus.
6	Diagnostic LEDs [► 41], power supply terminal.	Diagnosis of the power supply for the embedded PC and the terminal bus. Status of the E-bus and K-bus communication.
7	Spring-loaded terminals, +24 V and 0 V	Power supply for embedded PC.
8	Terminal bus (K-bus or E-bus)	Interface for EtherCAT Terminals or bus terminals. Data exchange and supply.
9	Spring-loaded terminal, +24 V	Power supply for bus terminals via power contact.
10	Spring-loaded terminal, 0 V	Power supply for bus terminals via power contact.
11	Terminal release	Releases the power supply terminal and therefore the embedded PC from the mounting rail.
12	Spring-loaded terminal, PE	Spring-loaded terminal for power contact PE.
13	Power contacts, +24 V, 0 V, PE	Power contacts for bus terminals.

4.2 Name plate

The CX2100-0014 power supply unit features a name plate on the left-hand side of the housing.

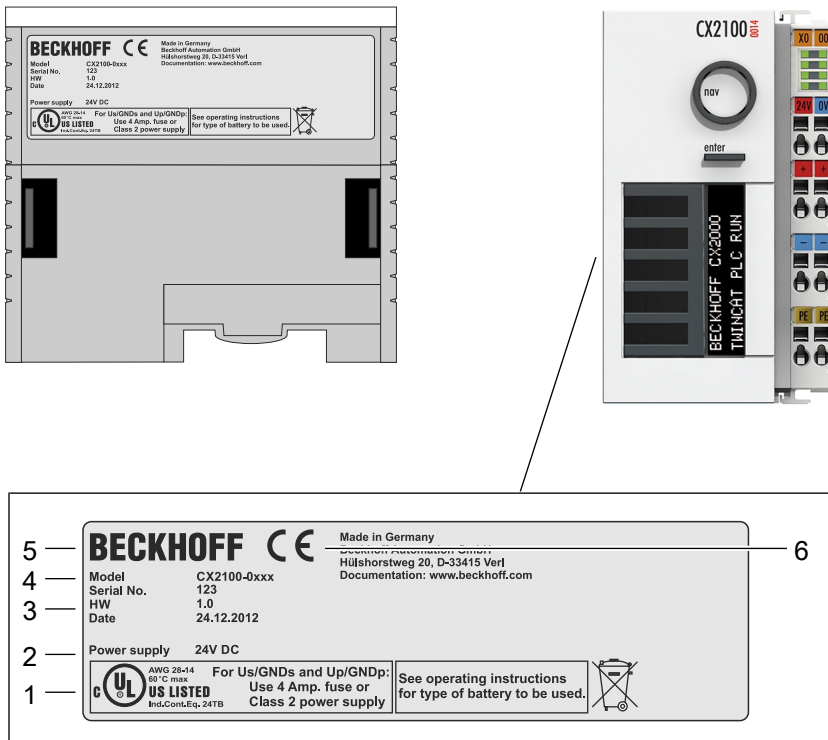

Fig. 2: CX2100-0014 power supply unit name plate.

Table 4: Legend for the name plate.

No.	Description
1	UL approval with prescribed information on power supply, fuse, temperature and cable cross-sections.
2	Information on the power supply unit.
3	Information on: <ul style="list-style-type: none"> • serial number, • hardware version • and date of manufacture.
4	Information on the model. The last four numerals relate to the configuration of the power supply unit.
5	Vendor data including address.
6	CE conformity.

5 Commissioning

5.1 Mounting

This chapter describes how to install the CX2100-0014 power supply unit. This documentation uses the CX2020 Embedded PC to demonstrate the procedure.

5.1.1 Attaching the power supply unit

The CX2100-0014 power supply unit supplies power to Embedded PCs of the CX2000 series. The power supply unit and the embedded PC are connected via the multi-pole connector.

Proceed as follows:

1. Plug the power supply unit into the high-pole connection on the right on the basic CPU module.

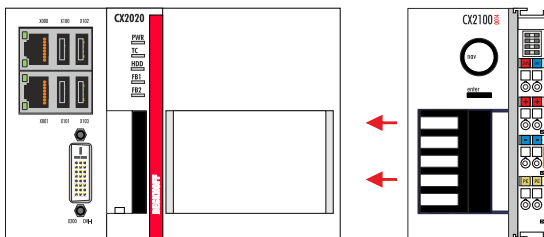

2. Check whether the power supply unit is flush with the embedded PC.
⇒ In the next step, you can install the bar clips.

5.1.2 Installing the bar clips

Usually, the connection between the modules is strong enough. However, the basic CPU module and the attached modules may be subjected to shocks, vibrations or other impacts. The modules can be securely connected to one another with the aid of bar clips.

Install the bar clips as follows:

1. Attach the bar clips at the top and bottom between the cooling fins.

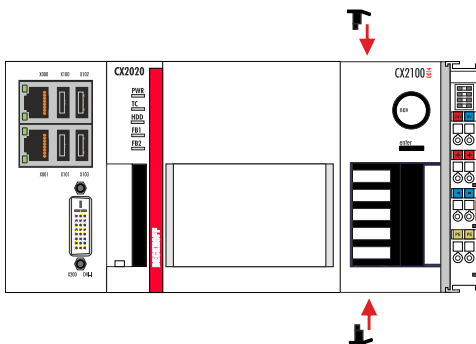

2. Push the bar clips between the cooling fins of your devices, as shown in the image below.

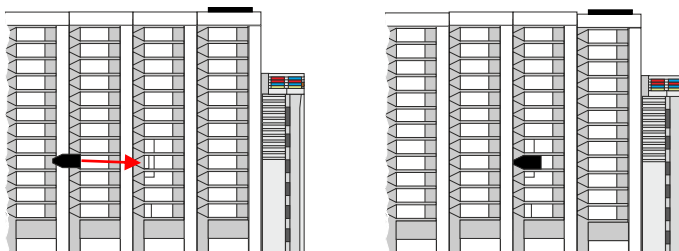

3. Check that the bar clips are flush.

- ⇒ The bar clips have been installed successfully, if they don't protrude and are flush with the cooling fins of your modules.
Once all modules are latched, the devices can be installed on the mounting rail.

5.1.3 Note the permissible installation positions

NOTICE

Increased heat generation

If the minimum distances are not observed, the power supply unit and the Embedded PC may overheat.

- Leave at least 30 mm clearance above and below the Embedded PC. Ensure adequate ventilation. Maintain the permissible ambient temperature in the vicinity of the power supply unit and Embedded PC.

Note the following specifications for the control cabinet:

- Maintain the permissible ambient temperature in the vicinity of the power supply unit and embedded PC. Measure the temperature below the embedded PC at a distance of 30 mm to the cooling fins, in order to determine the ambient temperature correctly.
- Adhere to the minimum distances of 30 mm above and below the embedded PC.
- Additional electrical equipment affects the heat generation in the control cabinet. Select a suitable control cabinet enclosure depending on the application, or ensure that excess heat is dissipated from the control cabinet.

The CX2100-0014 power supply unit and the embedded PC are mounted horizontally on the mounting rail as standard. A vertical or horizontal installation position is only possible if the embedded PC is actively cooled.

Table 5: Compatible Embedded PCs and permissible mounting positions.

	CX2020	CX2030	CX2040	CX2020 with fan option	CX2030 with fan option	CX20x2 many-core
Horizontal installation position	x	x	x	x	x	x
Vertical mounting position	-	-	x	x	x	x
Ambient temperature during operation	-25°C...+60°C	-25°C...+60°C	-25°C...+60°C	-25°C...+60°C	-25°C...+60°C	-25°C...+50°C

Horizontal installation position

Maintain the ambient temperatures. In addition, a minimum clearance of 30 mm above and below the cooling fins of the embedded PCs is required in order to ensure adequate ventilation. This ensures optimum air flow through the cooling fins of the embedded PC.

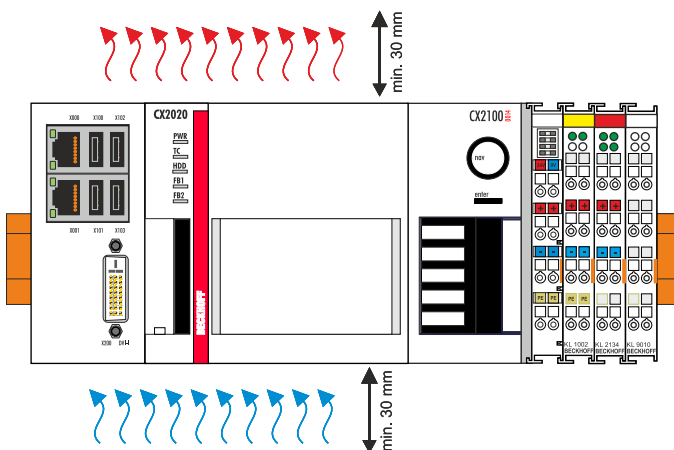

Fig. 3: CX2020 Embedded PC, horizontal installation position.

If there is a risk of vibrations or impact in the same direction as the mounting rail when the embedded PC is installed horizontally, the device must be secured with an additional bracket in order to prevent it slipping.

Vertical installation position

Maintain the ambient temperatures. The minimum distance of at least 30 mm above and below the cooling fins of the embedded PC must also be adhered to when the device is mounted vertically.

Ensure that any bus terminals connected to the embedded PC are designed for operation in vertical position.

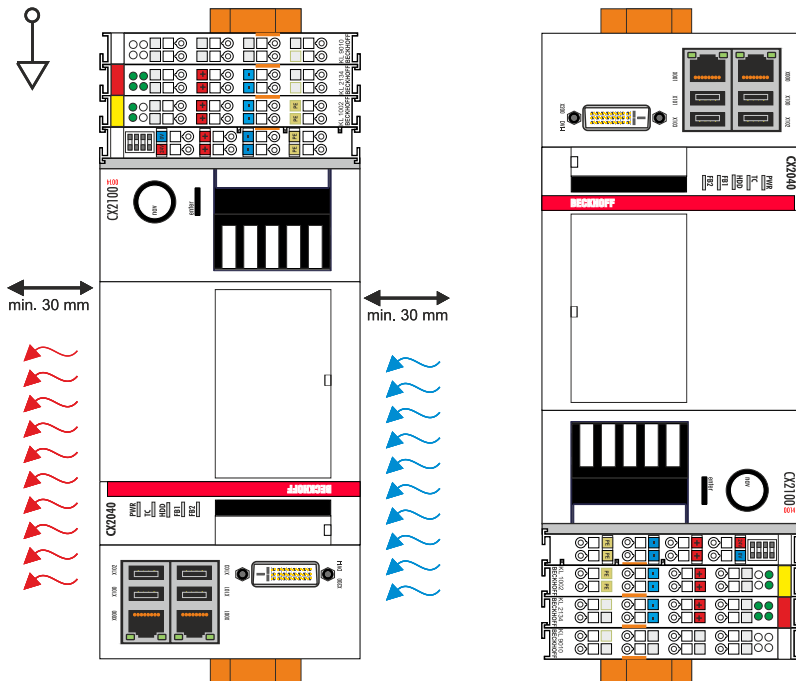

Fig. 4: CX2040 Embedded PC, vertical installation position.

If you install the embedded PC vertically, the device must be fastened properly to prevent it slipping off the DIN rail. Install a bracket below the embedded PC for this purpose.

Horizontal installation position

Maintain the ambient temperatures. The minimum distance of at least 30 mm above and below the cooling fins of the embedded PC must also be adhered to when the device is mounted horizontally.

Ensure that any bus terminals connected to the embedded PC are designed for operation in horizontal position.

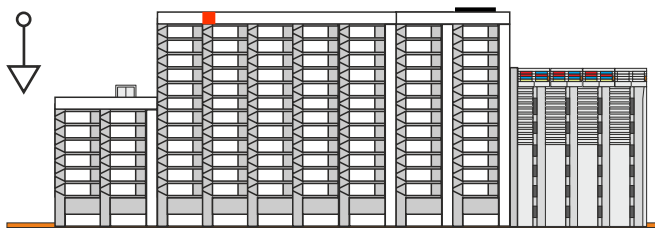

Fig. 5: CX2040 Embedded PC, horizontal installation position.

If there is a risk of vibrations or impact in the same direction as the mounting rail when the embedded PC is installed horizontally, the device must be secured with an additional bracket in order to prevent it slipping.

5.1.4 Attaching on mounting rail

The housing is designed such that the Embedded PC can be pushed against the mounting rail and latched onto it.

Requirements:

- Mounting rail of type TS35/7.5 or TS35/15 according to DIN EN 60715.

Secure the Embedded PC on the mounting rail as follows:

1. Unlock the latches at the top and bottom.

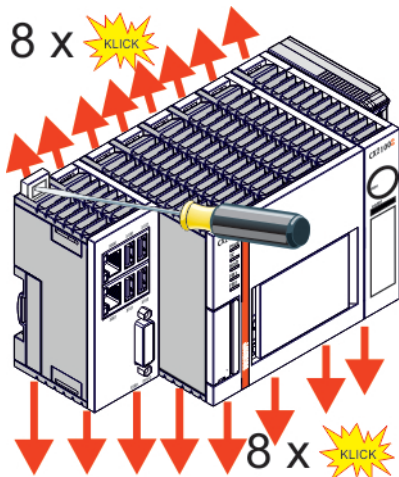

2. Place the Embedded PC at the front of the mounting rail. Slightly press the Embedded PC onto the mounting rail until a soft click can be heard and the Embedded PC has latched.

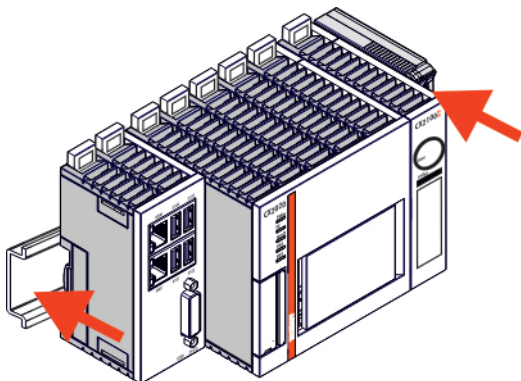

3. Then lock the latches again.

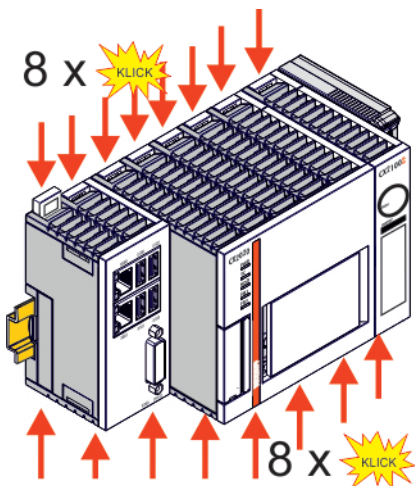

⇒ You have installed the Embedded PC successfully. Double-check the correct installation and latching of the Embedded PC on the mounting rail.

5.1.5 Installing passive EtherCAT Terminals

i **Incorrectly installed passive EtherCAT Terminals**

The E-bus signal between an Embedded PC and the EtherCAT Terminals can be impaired due to incorrectly installed passive EtherCAT Terminals.

Passive EtherCAT Terminals should not be installed directly on the power supply unit.

EtherCAT Terminals that do not take part in active data exchange are referred to as passive terminals. Passive EtherCAT Terminals have no process image and do not require current from the terminal bus (E-bus).

Passive EtherCAT Terminals (e.g. EL9195) can be detected in TwinCAT. In the tree structure the EtherCAT Terminal is displayed without process image, and the value in column "E-bus (mA)" does not change, compared to the preceding EtherCAT Terminal.

Number	Box Name	Ad...	Type	In Size	Out Size	E-Bus (mA)
1	Term 7 (EK1200)		EK1200			
2	Term 8 (EL2828)	1001	EL2828	1.0	1890	
3	Term 9 (EL2828)	1002	EL2828	1.0	1780	
4	Term 10 (EL9195)		EL9195			1780
5	Term 11 (EL2828)	1003	EL2828	1.0	1670	
6	Term 12 (EL9011)		EL9011			

Fig. 6: Identifying a passive EtherCAT Terminal in TwinCAT.

The entry "Current consumption via E-Bus" in the technical data of an EtherCAT Terminal indicates whether a particular EtherCAT Terminal requires power from the terminal bus (E-bus).

The following diagram shows the permissible installation of a passive EtherCAT Terminal. The passive EtherCAT Terminal was not directly attached to the power supply unit.

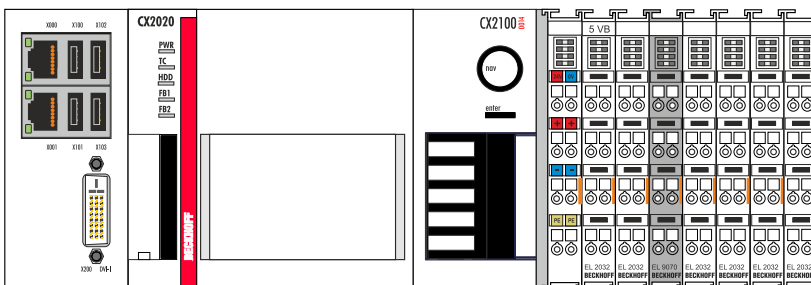

Fig. 7: Passive EtherCAT Terminals, permissible installation.

The following diagram shows the invalid installation of a passive EtherCAT Terminal.

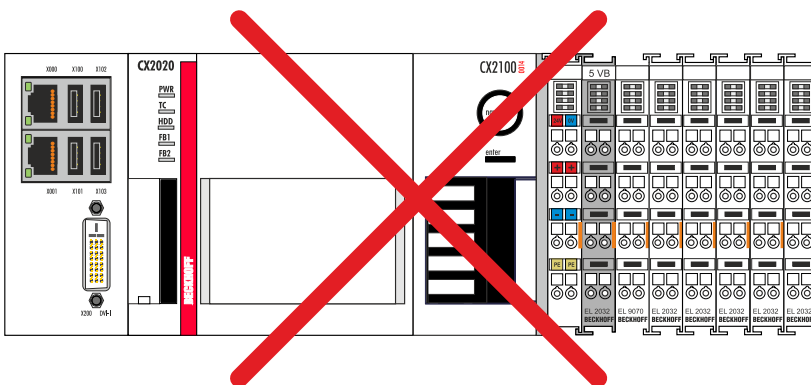

Fig. 8: Passive EtherCAT Terminals, invalid installation.

5.2 Power supply

This chapter describes how to connect the CX2100-0014 power supply unit. This documentation uses the CX2020 Embedded PC to demonstrate the procedure.

5.2.1 Connect Embedded PC

NOTICE

Damage to the Embedded PCs

The Embedded PCs may be damaged during wiring.

- The cables for the power supply should only be connected in de-energized state.

An external voltage source providing a 24 V DC voltage (-15 % / +20 %) is required for the CX2100-0014 power supply unit.

The cabling of the Embedded PC in the control cabinet must be done in accordance with the standard EN 60204-1:2006 PELV = Protective Extra Low Voltage:

- The "PE" and "0 V" conductors of the voltage source for a basic CPU module must be on the same potential (connected in the control cabinet).
- Standard EN 60204-1:2006, section 6.4.1:b stipulates that one side of the circuit, or a point of the energy source for this circuit must be connected to the protective earth conductor system.

Connection example with CX2020 basic CPU module and CX2100-0014 power supply unit:

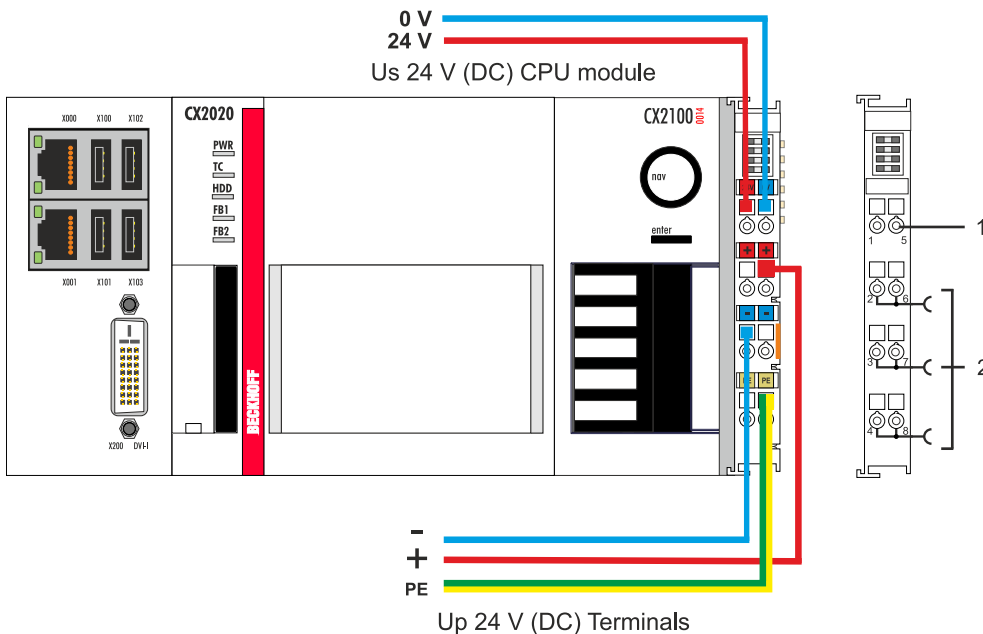

Table 6: Legend for the connection example.

No.	Description
1	The upper spring-loaded terminals identified with "24 V" and "0 V" supply the basic CPU module and the terminal bus (data transfer via K- or E-bus).
2	The spring-loaded terminals identified as "+", "-", and "PE" supply the Bus Terminals via the power contacts and the sensors or actuators connected to the Bus Terminals.

The cables of an external voltage source are connected to the power supply unit with spring-loaded terminals.

Table 7: Required wire cross-sections and strip lengths.

Conductor cross-section	0,5 ... 2,5 mm ²	AWG 20 ... AWG 14
Strip length	8 ... 9 mm	0.33 inch

Connect the embedded PC as follows:

1. Open a spring-loaded terminal by slightly pushing with a screwdriver or a rod into the square opening above the terminal.

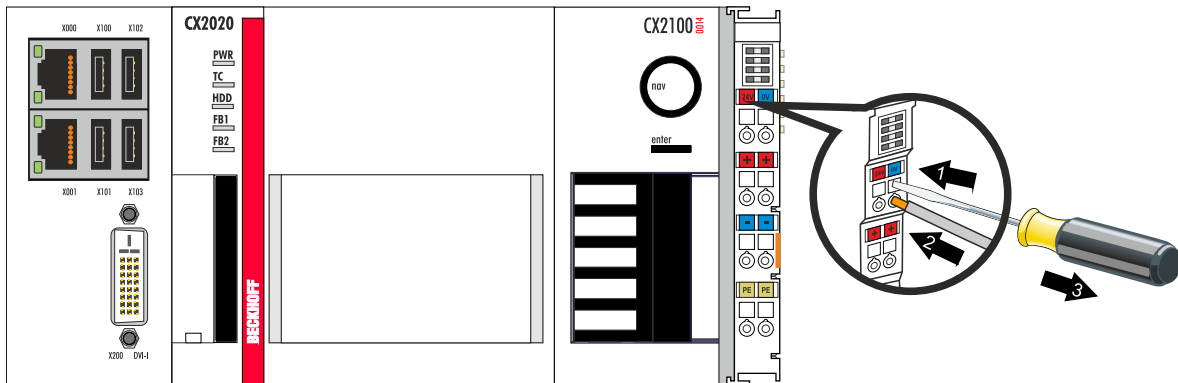

2. The wire can now be inserted into the round terminal opening without any force.
3. The terminal closes automatically when the pressure is released, holding the wire safely and permanently.

The voltage source has been connected to the power supply unit successfully when the two upper power supply terminal LEDs light up in green.

- The left LED (Us) indicates the supply of the basic CPU module and terminal bus.
- The red LED (Up) indicates the Bus Terminal supply via the power contacts.

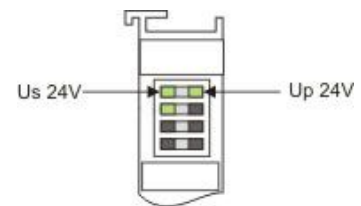

NOTICE

Interrupting / switching off the power supply

To switch off the Embedded PC, do not disconnect the ground (0 V), because otherwise current may continue to flow via the shielding, depending on the device, and damage the Embedded PC or peripheral devices.

- Always disconnect the 24 V line. Devices connected to the Embedded PC, which have their own power supply (e.g. a Panel) must have the same potential for "PE" and "0 V" as the Embedded PC have (no potential difference).

5.2.2 Observe the UL requirements

Observe the UL requirements

The CX20xx Embedded PCs are UL certified. The corresponding UL label can be found on the type plate.

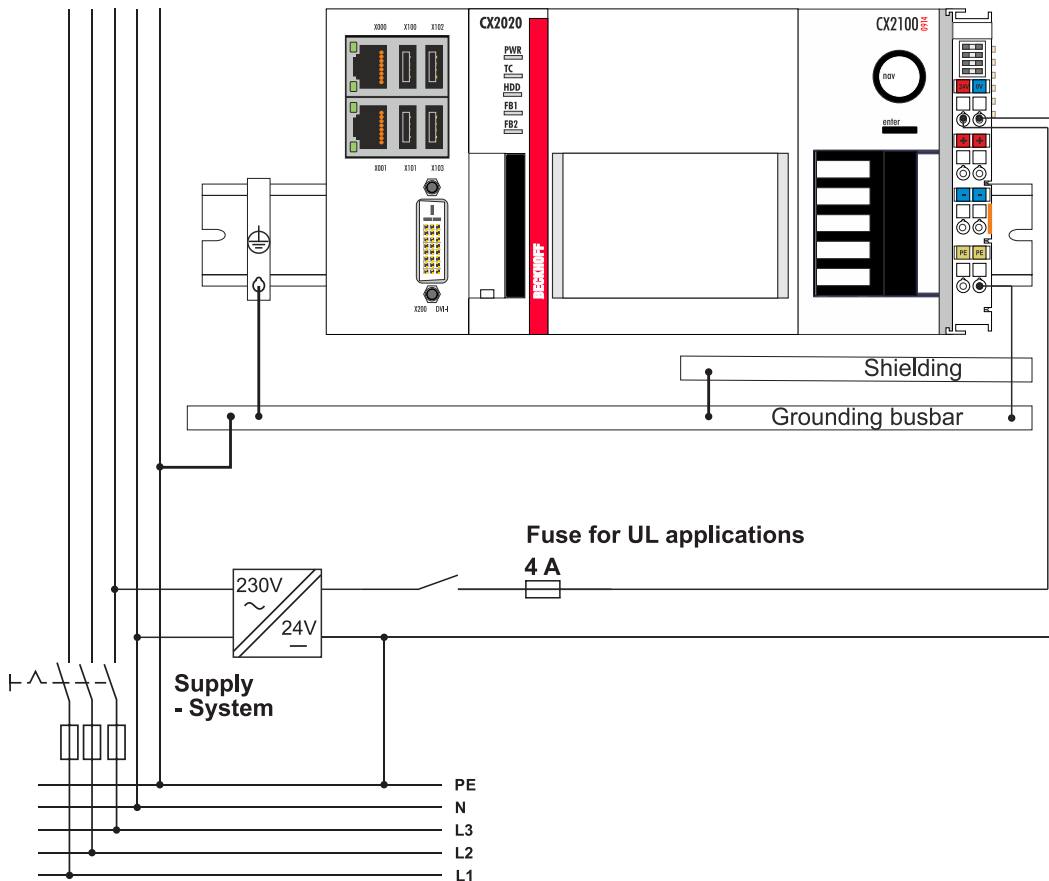

Fig. 9: UL label for CX20xx Embedded PC.

The CX20xx Embedded PCs can thus be used in areas in which special UL requirements have to be met. These requirements apply to the system voltage (U_s) and to the power contacts (U_p). Application areas without special UL requirements are not affected by UL regulations.

UL requirements

- The Embedded PCs must not be connected to unlimited voltage sources.
- Embedded PCs may only be supplied from a 24 V DC voltage source. The voltage source must be insulated and protected with a fuse of maximum 4 A (corresponding to UL248).
- Or the power supply must originate from a voltage source that corresponds to NEC class 2. An NEC class 2 voltage source must not be connected in series or parallel with another NEC class 2 voltage source.



6 Configuration

6.1 Display

The LCD display of the power supply unit has 2 x 16 characters. Each character has a resolution of 5 x 8 pixels. The display has a backlight that can be switched on and off. You can get a user's attention with a flashing display by quickly turning the backlight on and off. The control takes place via the PLC interface, ADS communication or the System Manager.

6.1.1 Character representation

The displayable characters on the display correspond to ASCII / ISO 8859-1 from 0x20 to 0x7E.

Hex	Character	Hex	Character	Hex	Character
0x20		0x40	@	0x60	`
0x21	!	0x41	A	0x61	a
0x22	"	0x42	B	0x62	b
0x23	#	0x43	C	0x63	c
0x24	\$	0x44	D	0x64	d
0x25	%	0x45	E	0x65	e
0x26	&	0x46	F	0x66	f
0x27	'	0x47	G	0x67	g
0x28	(0x48	H	0x68	h
0x29)	0x49	I	0x69	i
0x2A	*	0x4A	J	0x6A	j
0x2B	+	0x4B	K	0x6B	k
0x2C	,	0x4C	L	0x6C	l
0x2D	-	0x4D	M	0x6D	m
0x2E	.	0x4E	N	0x6E	n
0x2F	/	0x4F	O	0x6F	o
0x30	0	0x50	P	0x70	p
0x31	1	0x51	Q	0x71	q
0x32	2	0x52	R	0x72	r
0x33	3	0x53	S	0x73	s
0x34	4	0x54	T	0x74	t
0x35	5	0x55	U	0x75	u
0x36	6	0x56	V	0x76	v
0x37	7	0x57	W	0x77	w
0x38	8	0x58	X	0x78	x
0x39	9	0x59	Y	0x79	y
0x3A	:	0x5A	Z	0x7A	z
0x3B	;	0x5B	[0x7B	{
0x3C	<	0x5C	\	0x7C	
0x3D	=	0x5D]	0x7D	}
0x3E	>	0x5E	^	0x7E	~
0x3F	?	0x5F	_		

6.1.2 Displaying texts

Software connection for the display

There is a possibility to set static texts via the System Manager. Alternatively there are two TwinCAT function blocks. Their names are FB_CXSetTextDisplayUSB(FB) and FB_CXGetTextDisplayUSB(FB). Parameters are written with FB_CXSetTextDisplayUSB(FB) and the status values are read from the function block with FB_CXGetTextDisplayUSB(FB). A detailed documentation of the function blocks can be found in the TwinCAT software documentation. The two screenshots show the associated libraries for the function blocks.

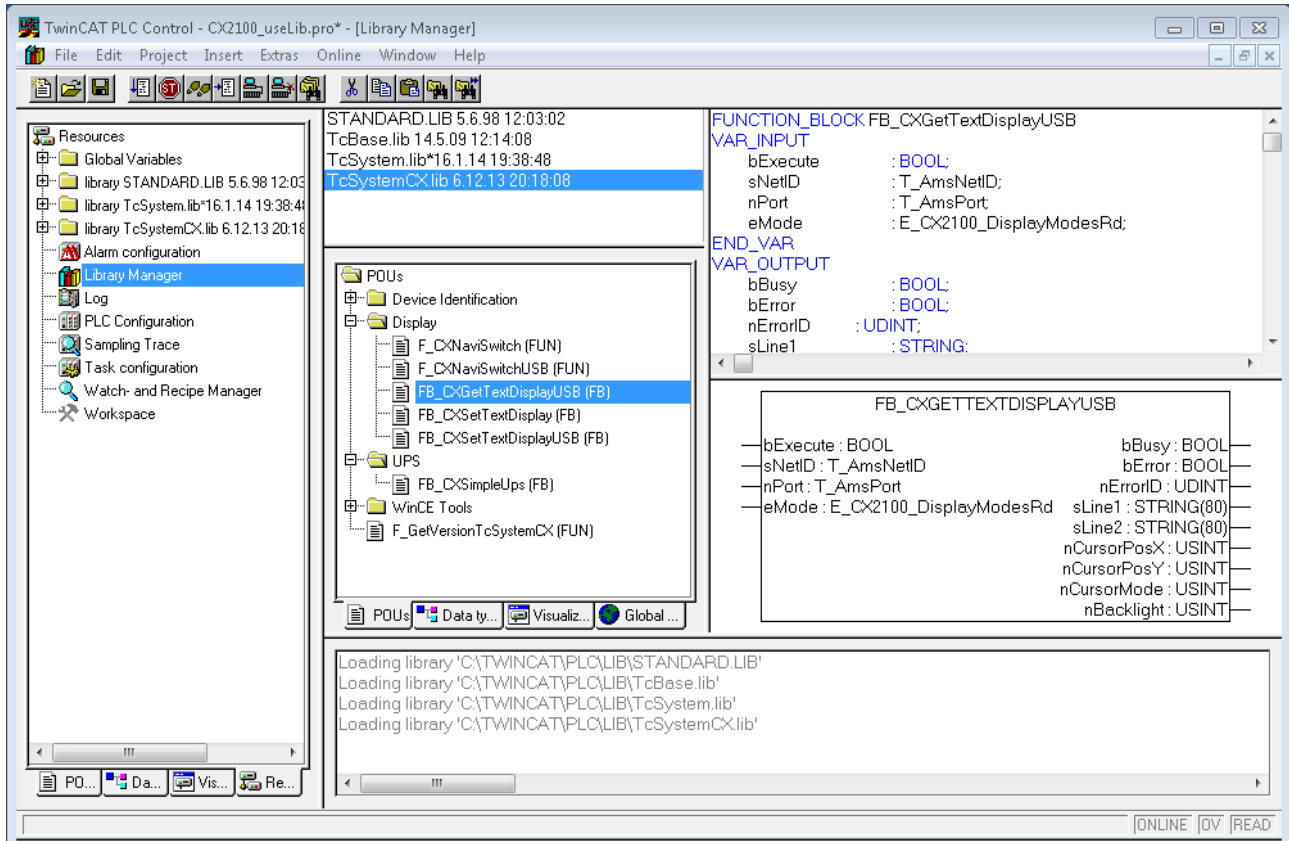

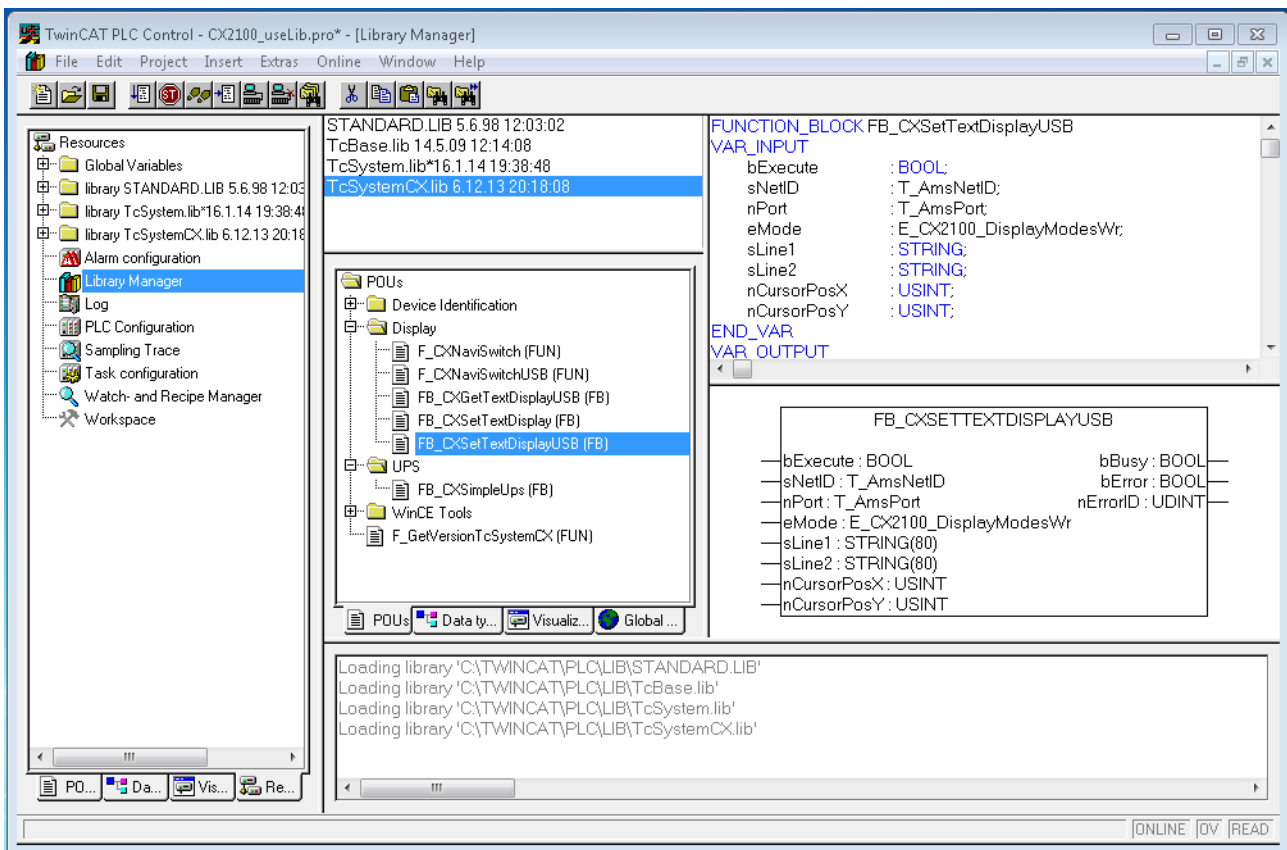

i Availability of the function blocks

These function blocks are available in the TwinCAT builds starting from version TC2.11 R3 Build 2240
TC3.1 Build 4015

With older versions an update is required for the use of the function blocks.

Illustration of the display with the System Manager

There are six tabs in the System Manager. These are briefly described below. The focus is thereby placed on the parameter that is relevant for the power supply unit

Tab: General

The general properties of the power supply unit are displayed here.

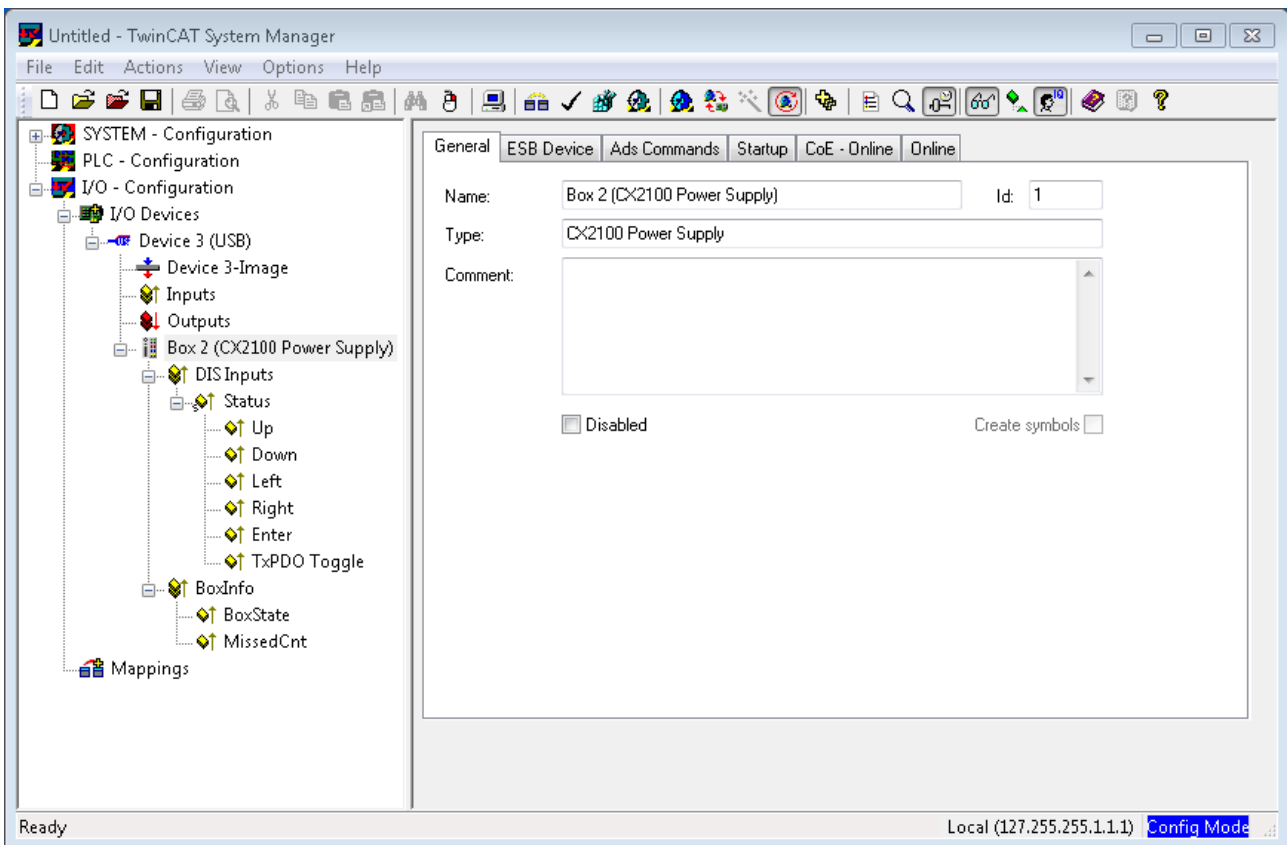

Name	Name of the EtherCAT device
Id	Number of the EtherCAT device
Type	EtherCAT device type
Comment	Here you can add a comment (e.g. regarding the system).
Disabled	Here you can deactivate the EtherCAT device.

Tab: ESB Device

The settings for the exchange of data between the power supply unit and the system are made and/or displayed here.

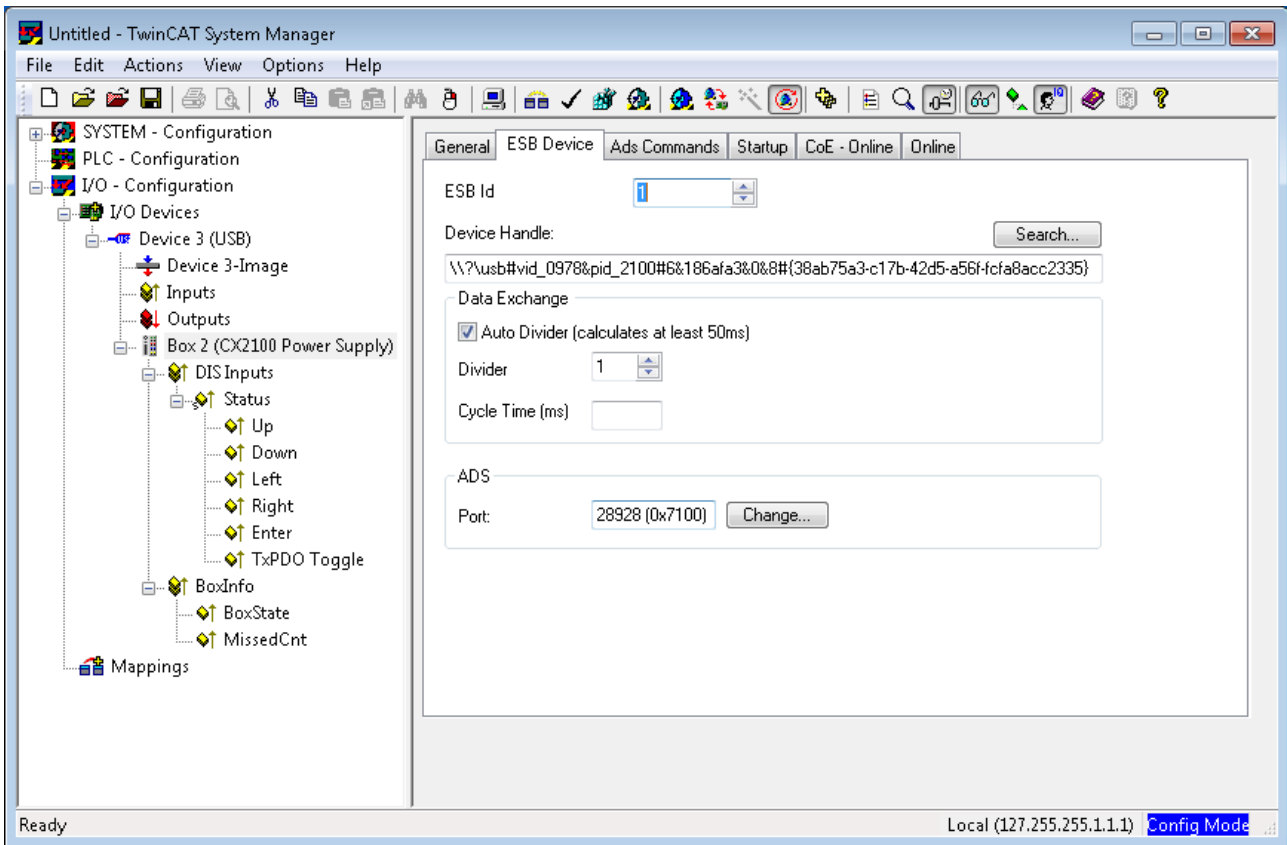

ESB Id	Serial numbers of the devices on the BUS
Device Handle	Pointer to the device driver
Data Exchange	Cycle in which the communication takes place
ADS	Port address for ADS access (7100 for the TwinCAT function block)

Tab: ADS Commands

The range for ADS communication is displayed here.

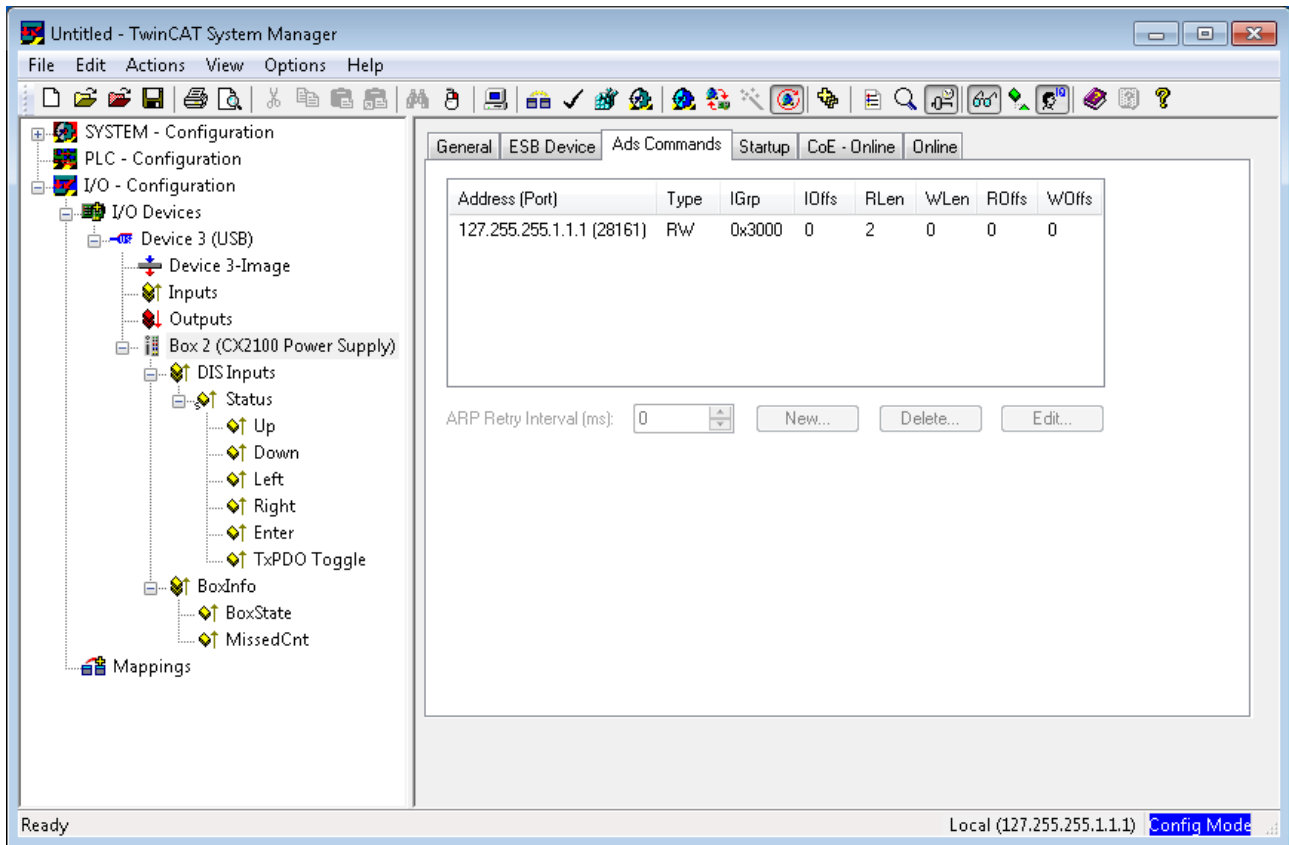

Tab: CoE Online

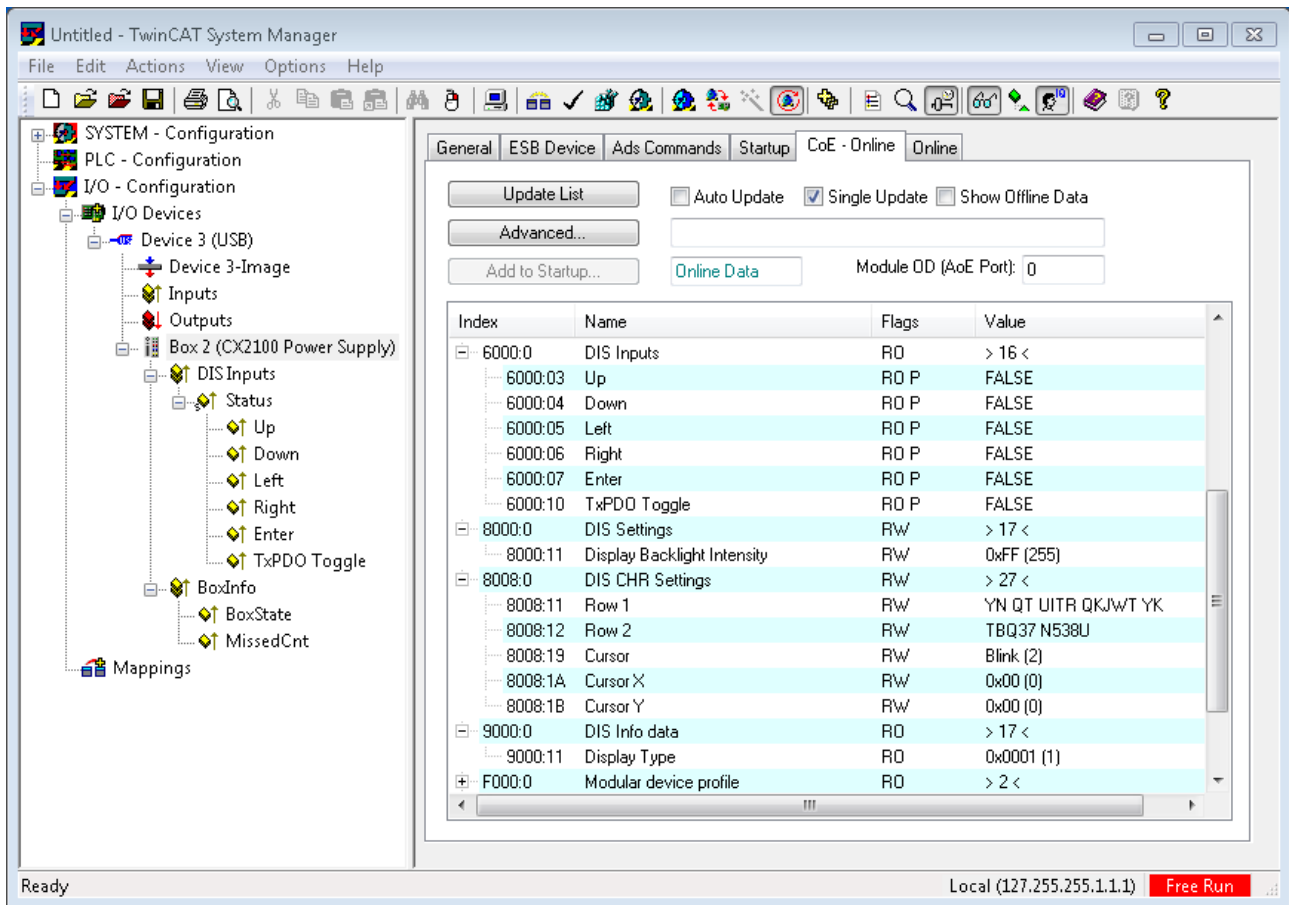

CoE interface – parameter management in the EtherCAT system

Many different devices are used in an automation environment. These devices can be used separately or together in a group on a bus system. Such devices can be controllers, shaft encoders, servo drives, motors, I/O modules or sensors among other things. Depending upon complexity, such a device must be parameterizable/adjustable for the respective requirement. Parameterization is perhaps not necessary in the case of a simple digital 24 V input with a fixed switching threshold and delay; in the case of a shaft encoder, however, it will not be possible to do without it (e.g. number of lines, absolute or relative, data format, etc.)

On top of that it can be of interest to store data in the device during production or operation. The manufacturer could store production data such as device name, serial number, firmware version, calibration data or date of manufacture, if necessary provided with protection against access or amendment. The user could store user calibration data and the application-specific settings in the device.

In order to create a user-friendly interface for device operation, different organizations have created various standards in which the following are defined: the available device classes (e.g.: 'rotary encoder', 'analog input module' class), the parameters that each representative of such a class has (obligatory and optional elements), the locations where these parameters can be found and the mechanism with which they are to be changed. EtherCAT follows the so called CoE standard here: Can-Application-protocol-over-EtherCAT.

Can-over-EtherCAT

The CiA organization (CAN in Automation) pursues among other things the goal of creating order and exchangeability between devices of the same type by the standardization of device descriptions. For this purpose so-called profiles are defined, which conclusively describe the changeable and unchangeable parameters of a device. Such a parameter encompasses at least the following characteristics:

- Index number – for the unambiguous identification of all parameters. The index number is divided into a main index and a subindex in order to mark and arrange associated parameters.
 - Main index
 - Subindex, (offset by a colon “:”)
- Official name – in the form of an understandable, self-descriptive text
- Specification of changeability, e.g. whether it can only be read or can also be written
- A value – depending upon the parameter the value can be a text, a number or another parameter index.

Example: the parameter 'Vendor ID' might have the index number 4120:01 and the numerical value '2' as the ID of a Beckhoff device.

Since hexadecimal values are favored in the machine environment, the parameter is represented from the user's point of view as if it had the RO property (read only), because the vendor ID should not be changed by the user.

Such a list of parameters, the whole of the device-specific CoE directory, can become very extensive. The first entries of a Beckhoff EL3152 analog input terminal appear as follows in the TwinCAT System Manager:

The index numbers are specified in the profile; they begin in EtherCAT with x1000, because the underlying entries do not have to be displayed.

CoE directory – availability

An EtherCAT device can have a CoE directory, but does not need to have one. Simple slaves need no parameter directory or do not have the controller required for administration. On the other hand, the EtherCAT master (like TwinCAT) as a software EtherCAT device can also manage a CoE directory.

If present, the CoE directory is in operation from the PREOP state.

The object directory can be read via the SDO information service (Service Data Objects).

CoE directory – localization in the EtherCAT Slave

The CoE directory as a parameter system must be administrated in the device in the firmware (FW) in the local controller. This is the so-called *online directory*, because it is only available to the user if the EtherCAT slave is in operation with operating voltage supplied and, if applicable, can be manipulated via EtherCAT communication.

So that the parameters can be viewed and changed in advance without the presence of a slave, a default copy of the entire directory is usually stored in the device description file ESI (XML). This is called the *offline directory*. Changes in this directory do not affect the later operation of the slave with TwinCAT. The xml files can be obtained from the Beckhoff website in the [Download area](#).

The TwinCAT system manager 2.11 can display both lists and marks this:

in the online directory	in the offline directory
the actual current slave list is read. This may take several seconds, depending on the size and cycle time	the offline list from the ESI file is displayed. In this case modifications are not meaningful or possible.
the actual identity is displayed	the configured status is shown under Identity
the firmware and hardware version of the equipment according to the electronic information is displayed	no firmware or hardware version is displayed, since these are features of the physical device
a green online is visible in the TwinCAT System Manager, <i>CoE Online</i> tab	a red offline is visible in the TwinCAT System Manager, <i>CoE Online</i> tab

Classification

Different CoE parameter types are possible, including string (text), integer numbers, Boolean values or larger byte fields. They can be used to describe a wide range of features. Examples of such parameters include manufacturer ID, serial number, process data settings, device name, calibration values for analog measurement or passwords.

The ranges in the Slave CoE that are important for the application-oriented EtherCAT fieldbus user are

- x1000: This is where fixed identity information for the device is stored, including name, manufacturer, serial number etc., plus information about the current and available process data configurations.
- x8000: This is where the operational and functional parameters for all channels are stored, such as filter settings or output frequency.

The following ranges are also of interest

- x4000: In some EtherCAT devices the channel parameters are stored here (as an alternative to the x8000 range).
- x6000: Input PDOs ("input" from the perspective of the EtherCAT master)
- x7000: Output PDOs ("output" from the perspective of the EtherCAT master)

Channel-based order

The CoE directory is located in EtherCAT devices that usually encompass several functionally equivalent channels. e.g. a 4-channel 0 – 10 V analog input terminal also has 4 logical channels and thus 4 identical sets of parameter data for the channels. In order to avoid having to list each channel in the documentation, the placeholder "n" tends to be used for the individual channel numbers.

In the CoE system 16 indices, each with 255 subindices, are generally sufficient for representing all channel parameters. The channel-based order is therefore arranged in $16_{\text{dec}}/10_{\text{hex}}$ steps. The parameter range x8000 exemplifies this:

Channel 0: parameter range x8000:00 ... x800F:255

Channel 1: parameter range x8010:00 ... x801F:255

Channel 2: parameter range x8020:00 ... x802F:255

tbc...

This is generally written as x80n0.

CoE directory – changes of value

Several parameters, in particular the setting parameters of the slave, are variable and can be written by the user from the fieldbus side. This can be done in write or read mode

via the System Manager (fig. 3) by the operator clicking on it
 The values are then changed directly in the online-connected slave.
 This is useful for commissioning of the system/slaves. Click on the row of the index to be parameterized and enter a value in the "SetValue" dialog.

from the controller/PLC via ADS e.g. by the function blocks from the TcEtherCAT.lib library
 This is recommended for modifications when the system is running or if no System Manager or operating staff are available.

during the EtherCAT startup through predefined commands, the so-called startup list.
 The TwinCAT configuration is usually created in advance without EtherCAT slaves actually being present.
 Then it should be possible before commissioning to adjust known properties such as filter settings offline in order to accelerate commissioning.

CoE directory – startup list

● Start-up list

i Changes made to the local CoE directory of the EtherCAT slaves are lost with the old device in case of exchange. If a device is replaced with a new Beckhoff device, it will have the default settings. It is therefore advisable to link all changes in the CoE list of an EtherCAT slave with the Startup list of the slave, which is processed whenever the EtherCAT fieldbus is started. In this way a replacement EtherCAT slave can automatically be parameterized with the specifications of the user.

If EtherCAT slaves are used which are unable to store local CoE values permanently, the Startup list must be used.

The startup list is used for these cases: the values here, which are entered by the user, are transmitted to the respective slave upon each EtherCAT state transition/start. A startup entry consists of

- Time: the state transition in which the command is sent
 PS (PREOP-->SAFEOP) is usually the correct choice, since an EtherCAT slave then switches to operative input mode.
- Index:Subindex
- Data

The order of the entries is not taken into account: all entries to which a state transition applies are handed over simultaneously as asynchronous commands to the EtherCAT system and executed there, as soon as the bus load allows. No check is made of whether an identical entry is already present in the slave. The corresponding values are adopted upon clicking the entry 8000:01; 01 is entered in *Data* as the desired value. The entry 'P->S' marks the time of the execution.

CoE directory – data management

● Data management

i If slave CoE parameters are modified online, Beckhoff devices store any changes in a fail-safe manner in the EEPROM, i.e. the modified CoE parameters are still available after a restart.

The situation may be different with other manufacturers.

If EtherCAT slaves are used which are unable to store local CoE values permanently, the Startup list must be used.

Summary of the characteristics

Not every EtherCAT device must have a CoE directory

If a CoE directory is present, it is administrated, prepared for querying and writing and stored in the device by the controller.

The EtherCAT master can be used for viewing/querying/changing, or a local user interface on the device (keypad, screen) allows access.

Changed settings are stored fail-safe in Beckhoff devices.

If the device is later exchanged, however, the settings that have been changed from the series standard are lost. The EtherCAT master can then load the changed CoE parameters into the new device at startup, if it is set up appropriately.

So that a CoE directory is available offline during the preparation for configuration, it can be contained in the device description as a copy.

The extent to which the CoE directory is supported depends on the capabilities of the EtherCAT master.

Tab: Online

the state machine of the EtherCAT communication is displayed here. It can also be switched to a different state here. This is done by selecting the desired state by a mouse-click on the appropriate button. The individual states are briefly described below. For further information, please refer to the EtherCAT system description on our webpage.

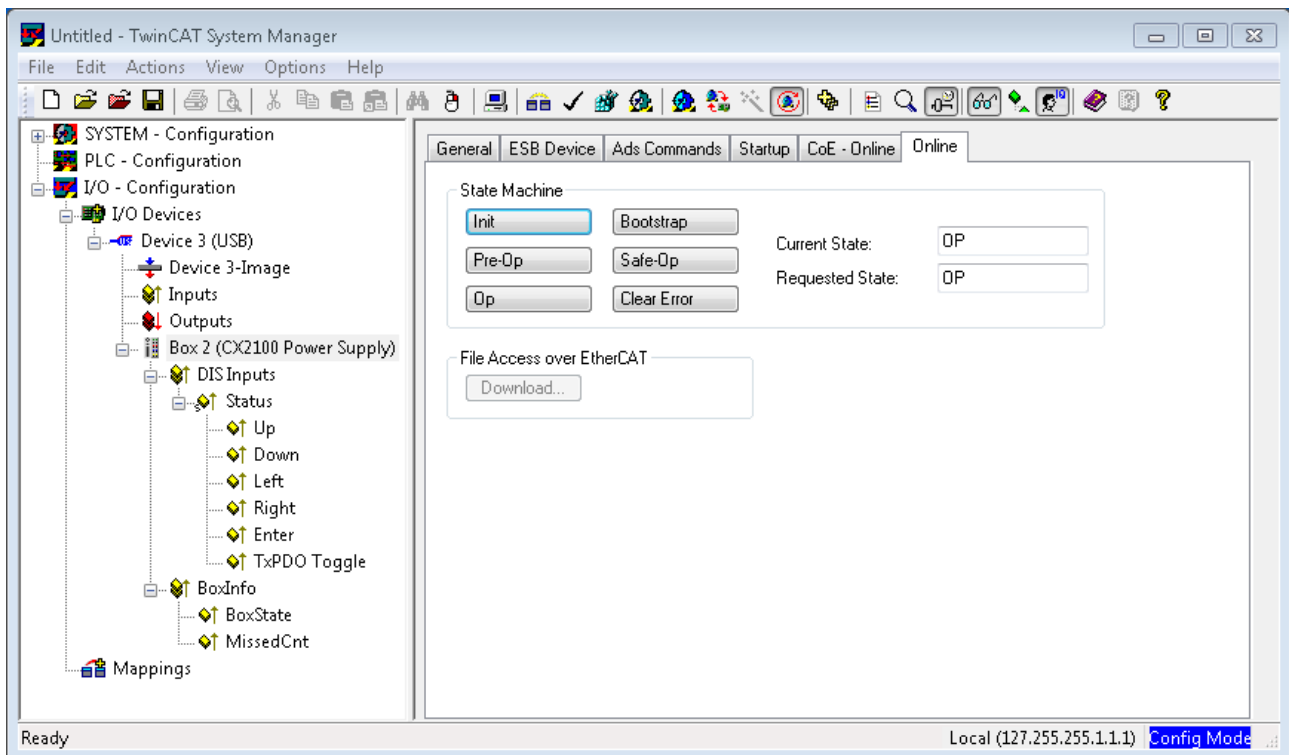

EtherCAT State Machine

The state of the EtherCAT slave is controlled via the EtherCAT State Machine (ESM). Depending upon the state, different functions are accessible or executable in the EtherCAT slave. Specific commands must be sent by the EtherCAT master to the device in each state, particularly during the bootup of the slave.

A distinction is made between the following states:

- Init
- Pre-Operational
- Safe-Operational and
- Operational
- Boot

The regular state of each EtherCAT slave after bootup is the OP state.

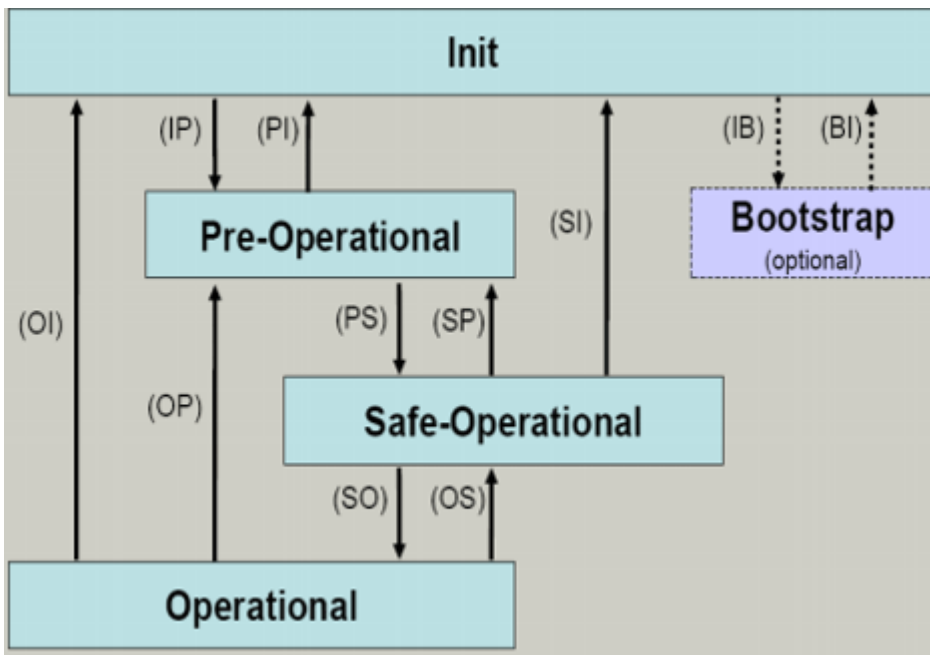

Init

After switch-on the EtherCAT slave in the Init state. No mailbox or process data communication is possible. The EtherCAT master initializes sync manager channels 0 and 1 for mailbox communication.

Pre-Operational (Pre-Op)

During the transition from Init to Pre-Op, the EtherCAT slave checks whether the mailbox has been correctly initialized. Mailbox communication is possible in the Pre-Op state, but no process data communication. The EtherCAT master initializes the sync manager channels for process data (from sync manager channel 2), the FMMU channels and, if the slave supports configurable mapping, PDO mapping or the sync manager PDO assignment. In this state the settings for the process data transfer and perhaps terminal-specific parameters that may differ from the default settings are also transferred.

Safe-Operational (Safe-Op)

During transition between Pre-Op and Safe-Op the EtherCAT slave checks whether the sync manager channels for process data communication and, if required, the distributed clocks settings are correct. Before it acknowledges the change of state, the EtherCAT slave copies current input data into the associated DP-RAM areas of the EtherCAT slave controller (ECSC).

Mailbox and process data communication are possible in the Safe-OP state; however, the slave maintains its outputs in the safe state and does not output them. The input data, however, are already cyclically updated.

Operational (Op)

Before the EtherCAT master switches the EtherCAT Slave from *Safe-Op* to *Op*, it must transmit already valid output data. In the *Op* state the slave copies the output data of the master to its outputs. Process data and mailbox communication is possible.

Boot

In the *Boot* state the slave firmware can be updated. The *Boot* state can only be reached via the *Init* state. In the *Boot* state mailbox communication is possible via the *File-Access over EtherCAT* (FoE) protocol, but no other mailbox communication and no process data communication is possible.

6.2 Operating principle of the button

The CX1100-0xx4 power supply units all have four navigation switches and an Enter button. The buttons can therefore be used to input five basic states

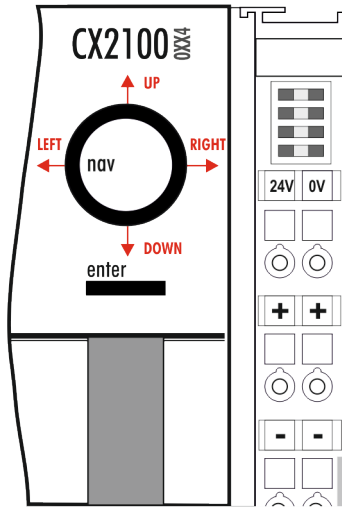

Button	Value	Button	Value
UP	4	RIGHT	32
DOWN	8	ENTER / SELECT	64
LEFT	16		

Combined inputs, such as UP + RIGHT or UP + RIGHT + ENTER can also be entered. Each value is made available separately as a boolean value and can be linked in the PLC.

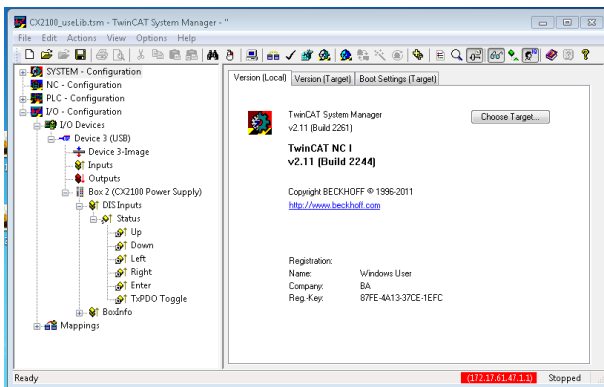

The values of the button can be assessed as a numerical value via a TwinCAT function. A combination of the buttons can also be assessed via the value. The register can be accessed from within a PLC program, and the value can be assessed. This requires a variable of type USINT first to be created in the PLC program. This is then called as a parameter in the 'F_CXNaviSwitchUSB' function. The code fragment shows the declaration of the required variables.

```

PROGRAM MAIN
VAR
  bUp AT %I*      : BOOL;
  bDown AT %I*    : BOOL;
  bLeft AT %I*    : BOOL;
  bRight AT %I*   : BOOL;
  bEnter AT %I*   : BOOL;
  bToggle AT %I*  : BOOL;
  Taster          : USINT; (* als Summenwert *)
  eNaviSwitchCx2 : E_CX2100_NaviSwitch;
END_VAR
    
```

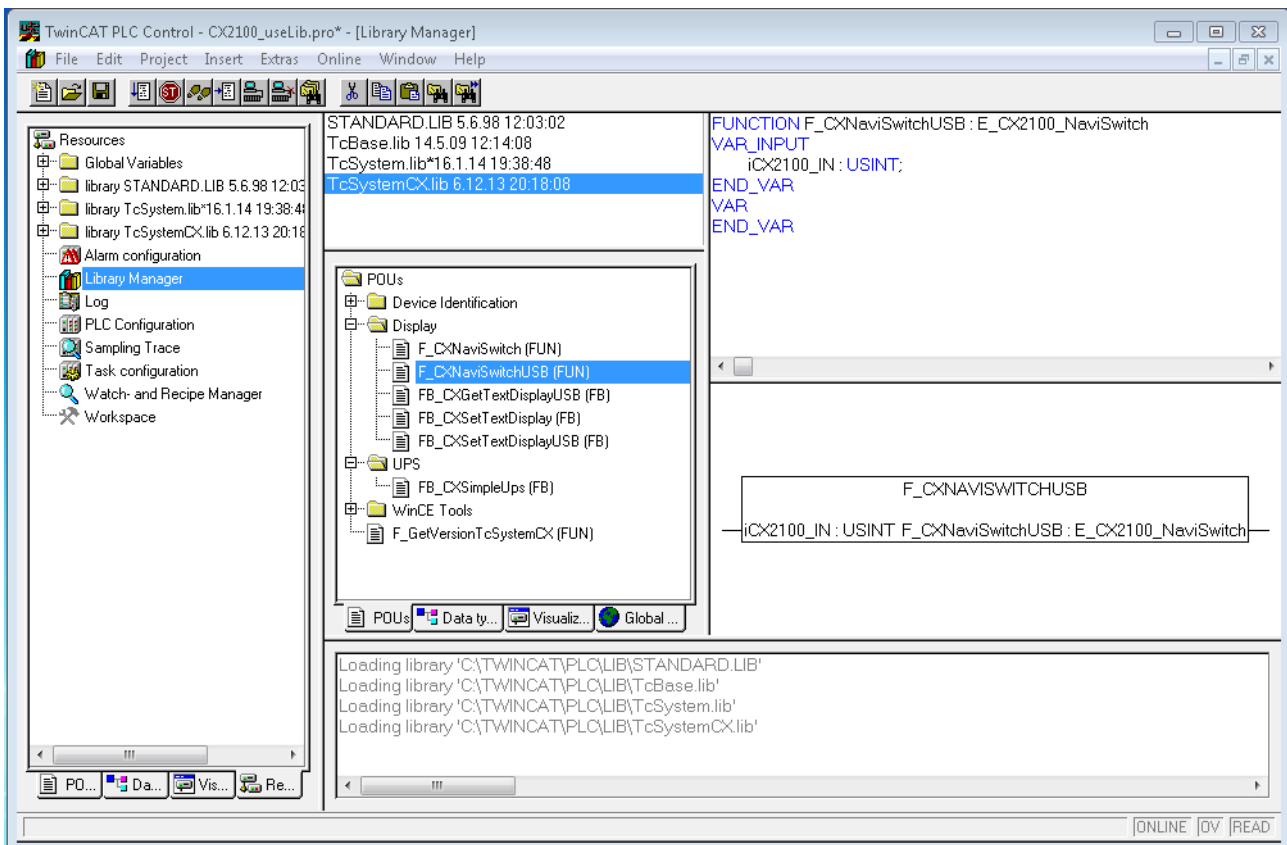

```
(* get navi switch *)
eNaviSwitchCx2 := F_CXNaviSwitchUSB(Taster);
```

The button can be accessed from the PLC program through the button variable. A simple CASE statement can then be used to evaluate the switch, and the desired function can be initiated, e.g.:

```
CASE Taster OF
  4 : ACTION := UP;
  8 : ACTION := DOWN;
 16 : ACTION := LEFT;
 32 : ACTION := RIGHT;
 64 : ACTION := SELECT;
END_CASE;
```

In this case, "ACTION" is a newly defined ENUM type. It is also possible for the desired action to be activated immediately.

The sum of the numerical values is used for the combined functions. In other words, UP (4) and RIGHT (32) would be 4 + 32 = 36. Values are: {UP (4), DOWN(8), LEFT(16), RIGHT(32) and ENTER(64)}. In this way only useful combinations are possible.

6.3 Example Program

The following PLC program shows by way of an example how the three function blocks are used for the power supply unit.

```

PROGRAM MAIN

VAR
  nCounter AT %Q*: USINT;
  (* navi switch *)
  bUp AT %I*      : BOOL;
  bDown AT %I*    : BOOL;
  bLeft AT %I*    : BOOL;
  bRight AT %I*   : BOOL;
  bEnter AT %I*   : BOOL;
  bToggle AT %I*  : BOOL;
  nIn              : USINT;
  eNaviSwitchCx2  : E_CX2100_NaviSwitch;

  (* get display *)
  fbGetDisplayText : FB_CXGetTextDisplayUSB;
  bExecuteRead     : BOOL;
  eModeRead        : E_CX2100_DisplayModesRd;
  nCursorMode      : USINT;
  nBacklight       : USINT;
  bReadCursorInfoReq : BOOL := TRUE;
  bReadBacklightReq : BOOL := TRUE;
  bReadLine1Req    : BOOL;
  bReadLine2Req    : BOOL;
  bReadLinesReq    : BOOL := TRUE;

  (* set display *)
  fbSetDisplayText : FB_CXSetTextDisplayUSB;
  bExecuteWrite    : BOOL;
  eModeWrite       : E_CX2100_DisplayModesWr;
  bCursorOnReq     : BOOL;
  bCursorOffReq    : BOOL;
  bBlinkCursorOnReq : BOOL;
  bBlinkCursorOffReq : BOOL;
  bBacklightOnReq  : BOOL;
  bBacklightOffReq : BOOL;
  bClearDisplayReq : BOOL;
  bWriteLine1Req   : BOOL;
  bWriteLine2Req   : BOOL;
  bWriteLinesReq   : BOOL;
  bSetCursorPosXReq : BOOL;
  bSetCursorPosYReq : BOOL;
  bSetCursorPosXYReq : BOOL;

  (* common *)
  nCursorPosX : USINT;
  nCursorPosY : USINT;
  sLine1      : STRING;
  sLine2      : STRING;
  bBusy       : BOOL;
  bError      : BOOL;
  nErrorID    : UDINT;
END_VAR

nCounter := nCounter + 1;

nIn.2 := bUp;
nIn.3 := bDown;
nIn.4 := bLeft;
nIn.5 := bRight;
nIn.6 := bEnter;

(* get navi switch *)
eNaviSwitchCx2 := F_CXNaviSwitchUSB(nIn);

(* prepare get display mode *)
IF (eModeRead = eCX2100_DisplayNoActionRd) AND (eModeWrite = eCX2100_DisplayNoActionWr) THEN
  IF bReadCursorInfoReq THEN
    eModeRead := eCX2100_ReadCursorInfo;
    bExecuteRead := TRUE;
  ELSIF bReadBacklightReq THEN
    eModeRead := eCX2100_ReadBackLight;
    bExecuteRead := TRUE;
  ELSIF bReadLine1Req THEN

```

```

        eModeRead := eCX2100_ReadLine1;
        bExecuteRead := TRUE;
    ELSIF bReadLine2Req THEN
        eModeRead := eCX2100_ReadLine2;
        bExecuteRead := TRUE;
    ELSIF bReadLinesReq THEN
        eModeRead := eCX2100_ReadLines;
        bExecuteRead := TRUE;
    END_IF
END_IF

(* get display *)

IF (eModeRead <> eCX2100_DisplayNoActionRd) AND (eModeWrite = eCX2100_DisplayNoActionWr) THEN
    fbGetDisplayText (
        bExecute := bExecuteRead,
        sNetID := '',
        nPort := 16#7100,
        eMode := eModeRead,
        bBusy => bBusy,
        bError => bError,
        nErrorID => nErrorID,
    );
    IF NOT fbGetDisplayText.bBusy THEN
        fbGetDisplayText(bExecute := FALSE);
        IF NOT fbGetDisplayText.bError THEN
            CASE eModeRead OF
                eCX2100_ReadCursorInfo:
                    nCursorPosX := fbGetDisplayText.nCursorPosX;
                    nCursorPosY := fbGetDisplayText.nCursorPosY;
                    nCursorMode := fbGetDisplayText.nCursorMode;
                    bReadCursorInfoReq := FALSE;
                eCX2100_ReadBackLight:
                    nBacklight := fbGetDisplayText.nBacklight;
                    bReadBacklightReq := FALSE;
                eCX2100_ReadLine1:
                    sLine1 := fbGetDisplayText.sLine1;
                    bReadLine1Req := FALSE;
                eCX2100_ReadLine2:
                    sLine2 := fbGetDisplayText.sLine2;
                    bReadLine2Req := FALSE;
                eCX2100_ReadLines:
                    sLine1 := fbGetDisplayText.sLine1;
                    sLine2 := fbGetDisplayText.sLine2;
                    bReadLinesReq := FALSE;
            END_CASE
        END_IF

        bExecuteRead := FALSE;
        eModeRead := eCX2100_DisplayNoActionRd;
    END_IF
END_IF

(* prepare set display mode *)
IF (eModeWrite = eCX2100_DisplayNoActionWr) AND (eModeRead = eCX2100_DisplayNoActionRd) THEN
    IF bCursorOnReq THEN
        eModeWrite := eCX2100_CursorOn;
        bExecuteWrite := TRUE;
        bReadCursorInfoReq := TRUE;
    ELSIF bCursorOffReq THEN
        eModeWrite := eCX2100_CursorOff;
        bExecuteWrite := TRUE;
        bReadCursorInfoReq := TRUE;
    ELSIF bBlinkCursorOnReq THEN
        eModeWrite := eCX2100_CursorBlinkOn;
        bExecuteWrite := TRUE;
        bReadCursorInfoReq := TRUE;
    ELSIF bBlinkCursorOffReq THEN
        eModeWrite := eCX2100_CursorBlinkOff;
        bExecuteWrite := TRUE;
        bReadCursorInfoReq := TRUE;
    ELSIF bBacklightOnReq THEN
        eModeWrite := eCX2100_BackLightOn;
        bExecuteWrite := TRUE;
        bReadBacklightReq := TRUE;
    ELSIF bBacklightOffReq THEN
        eModeWrite := eCX2100_BackLightOff;
        bExecuteWrite := TRUE;
        bReadBacklightReq := TRUE;
    END_IF
END_IF

```

```

ELSIF bClearDisplayReq THEN
    eModeWrite := eCX2100_ClearDisplay;
    bExecuteWrite := TRUE;
    bReadLinesReq := TRUE;
ELSIF bWriteLine1Req THEN
    eModeWrite := eCX2100_WriteLine1;
    bExecuteWrite := TRUE;
    bReadLine1Req := TRUE;
ELSIF bWriteLine2Req THEN
    eModeWrite := eCX2100_WriteLine2;
    bExecuteWrite := TRUE;
    bReadLine2Req := TRUE;
ELSIF bWriteLinesReq THEN
    eModeWrite := eCX2100_WriteLines;
    bExecuteWrite := TRUE;
    bReadLinesReq := TRUE;
ELSIF bSetCursorPosXReq THEN
    eModeWrite := eCX2100_CursorPosX;
    bExecuteWrite := TRUE;
    bReadCursorInfoReq := TRUE;
ELSIF bSetCursorPosYReq THEN
    eModeWrite := eCX2100_CursorPosY;
    bExecuteWrite := TRUE;
    bReadCursorInfoReq := TRUE;
ELSIF bSetCursorPosXYReq THEN
    eModeWrite := eCX2100_CursorPosXY;
    bExecuteWrite := TRUE;
    bReadCursorInfoReq := TRUE;
END_IF
END_IF

(* set display *)
IF (eModeWrite <> eCX2100_DisplayNoActionWr) AND (eModeRead = eCX2100_DisplayNoActionRd) THEN
    fbSetDisplayText(
        bExecute := bExecuteWrite,
        sNetID := '',
        nPort := 16#7100,
        eMode := eModeWrite,
        sLine1 := sLine1,
        sLine2 := sLine2,
        nCursorPosX := nCursorPosX,
        nCursorPosY := nCursorPosY,
        bBusy => bBusy,
        bError => bError,
        nErrorID => nErrorID
    );
    IF NOT fbSetDisplayText.bBusy THEN
        fbSetDisplayText(bExecute := FALSE);

        bExecuteWrite := FALSE;
        eModeWrite := eCX2100_DisplayNoActionWr;
    END_IF
END_IF

```

7 Error handling and diagnostics

7.1 Diagnostics in the PLC program

For the analysis of the terminal bus (K-bus) the State register can be accessed via TwinCAT from a PLC program.

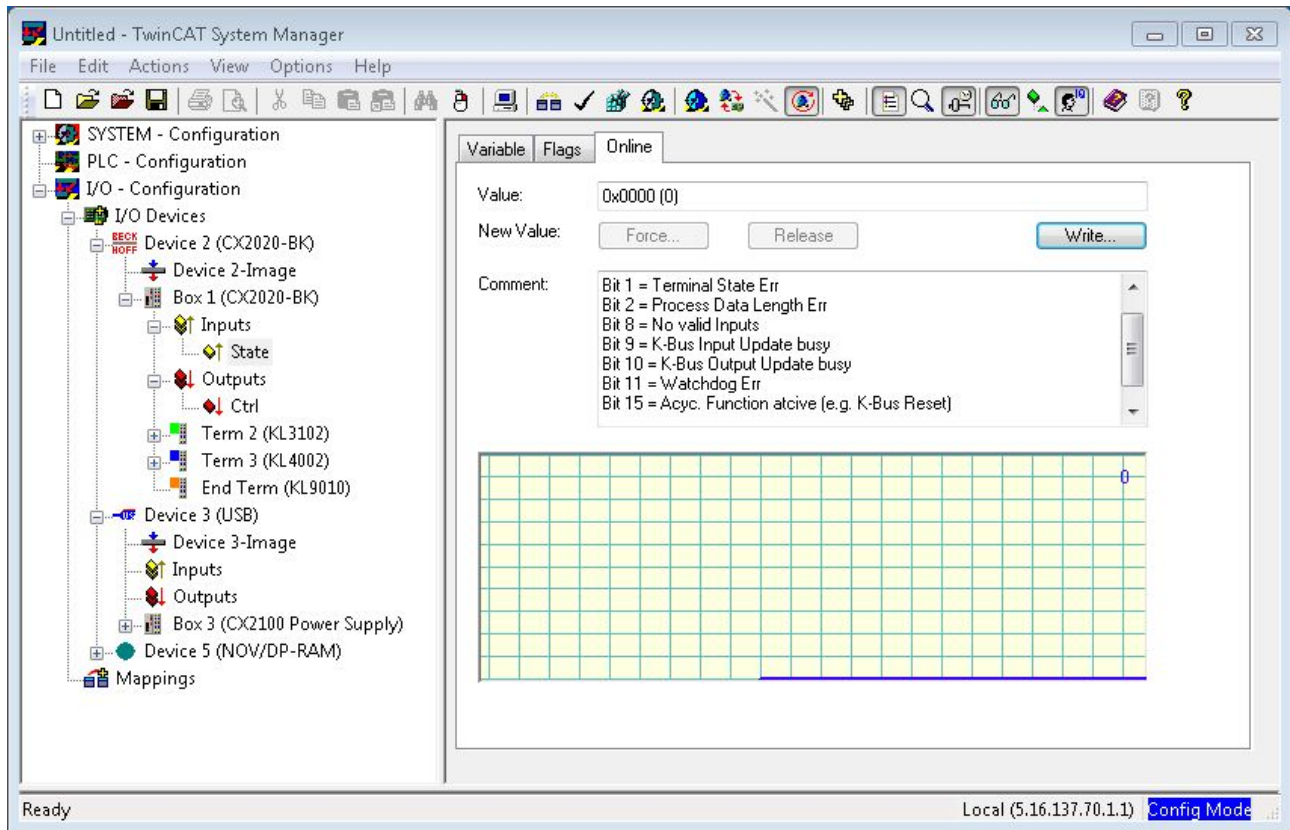

The error analysis is presented as an example below.

A signal/variable is essentially required for the error analysis:

- State (indicates the state of the bus: 0 -> no error)

External variables must similarly be created in the PLC program for this:

```
VAR
    k_bus_state AT %IB2 : USINT;
END_VAR
```

The error can then be determined in the PLC program as follows (this is pseudo code, which is not directly executable in this form)

```
....
IF k_bus_state != 0 THEN      (* auf dem K-Bus ist ein Fehler aufgetreten *)
    IF k_bus_state.1 = 1 THEN melde Fehler; (* Klemmenzustandsfehler *) END_IF
    IF k_bus_state.2 = 1 THEN melde Fehler; (* Prozessdatenlänge ungültig *) END_IF
    IF k_bus_state.8 = 1 THEN melde Fehler; (* keine gültigen Eingänge *) END_IF
    IF k_bus_state.9 = 1 THEN melde Fehler; (* K_Bus Input Update ist aktiv *) END_IF
    IF k_bus_state.10 = 1 THEN melde Fehler; (* K_Bus Output Update ist aktiv *) END_IF
    IF k_bus_state.11 = 1 THEN melde Fehler; (* Watchdog Fehler *) END_IF
    IF k_bus_state.15 = 1 THEN melde Fehler; (* Bus ist asynchron *) END_IF
END_CASE
k_bus_request := TRUE;      (* Rücksetzen des Busses, wenn Fehler beseitigt, dann startet der
```

Klemmbus wieder *)

....

In order for the controller and the registers to co-operate, they must be linked in the System Manager.

7.2 K-bus

The power supply unit checks the connected Bus Terminals for errors. The red LED "K-bus ERR" is off if no error is present. The red LED "K-bus ERR" flashes if Bus Terminal errors are present.

Table 8: Diagnostic LEDs in K-Bus mode.

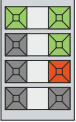
Display	LED	Meaning
Us 24 V  Up 24 V K-BUS RUN K-BUS ERR	Us 24 V	Power supply for basic CPU module. The LED lights green if the power supply is correct.
	Up 24V	Power supply for terminal bus. The LED lights green if the power supply is correct.
	K-BUS RUN	Diagnostic K-bus. The green LED lights up in order to indicate fault-free operation. "Error-free" means that the communication with the fieldbus system is also running.
	K-BUS ERR	Diagnostic K-bus. The red LED flashes to indicate an error. The red LED blinks with two different frequencies.

The frequency and number of the flashes can be used to determine the error code and the error argument. An error is indicated by the "K-bus ERR" LED in a particular order.

Table 9: K-bus ERR LED, fault indication sequence through the LED.

Order	Meaning
Fast blinking	Starting the sequence
First slow sequence	Error code
No display	Pause, the LED is off
Second slow sequence	Error code argument

Count how often the red LED K-bus ERR flashes, in order to determine the error code and the error argument. In the error argument the number of pulses shows the position of the last Bus Terminal before the error. Passive Bus Terminals, such as a power feed terminal, are not included in the count.

Table 10: K-BUS ERR LED, fault description and troubleshooting.

Error code	Error code argument	Description	Remedy
Persistent, continuous flashing		EMC problems.	<ul style="list-style-type: none"> • Check power supply for undervoltage or overvoltage peaks. • Implement EMC measures. • If a K-bus error is present, it can be localized by a restart of the power supply (by switching it off and then on again)
3 pulses	0	K-bus command error.	<ul style="list-style-type: none"> • No Bus Terminal inserted. • One of the Bus Terminals is defective; halve the number of Bus Terminals attached and check whether the error is still present with the remaining Bus Terminals. Repeat this procedure until the faulty Bus Terminal has been found.
4 pulses	0	K-bus data error, break behind the power supply unit.	Check whether the Bus End Terminal 9010 is connected.
	n	Break behind Bus Terminal n	Check whether Bus Terminal n+1 after the power supply unit is connected correctly; replace if necessary.
5 pulses	n	K-bus error in register communication with Bus Terminal n.	Replace Bus Terminal at location n.
6 pulses	0	Error at initialization.	Replace Embedded PC.
	1	Internal data error.	Hardware reset of the Embedded PC (switch off and back on again).
	8	Internal data error.	Hardware reset of the Embedded PC (switch off and back on again).
7 pulses	0	Process data lengths of the set and actual configurations do not correspond.	Check the configuration and the Bus Terminals for consistency.

For some error the LED "K-BUS ERR" does not go out, even if the error was rectified. Switch the power supply for the power supply unit off and back on again to switch off the LED after the error has been rectified.

State variable

In TwinCAT there is a State variable under the Bus Coupler for K-bus diagnostics.

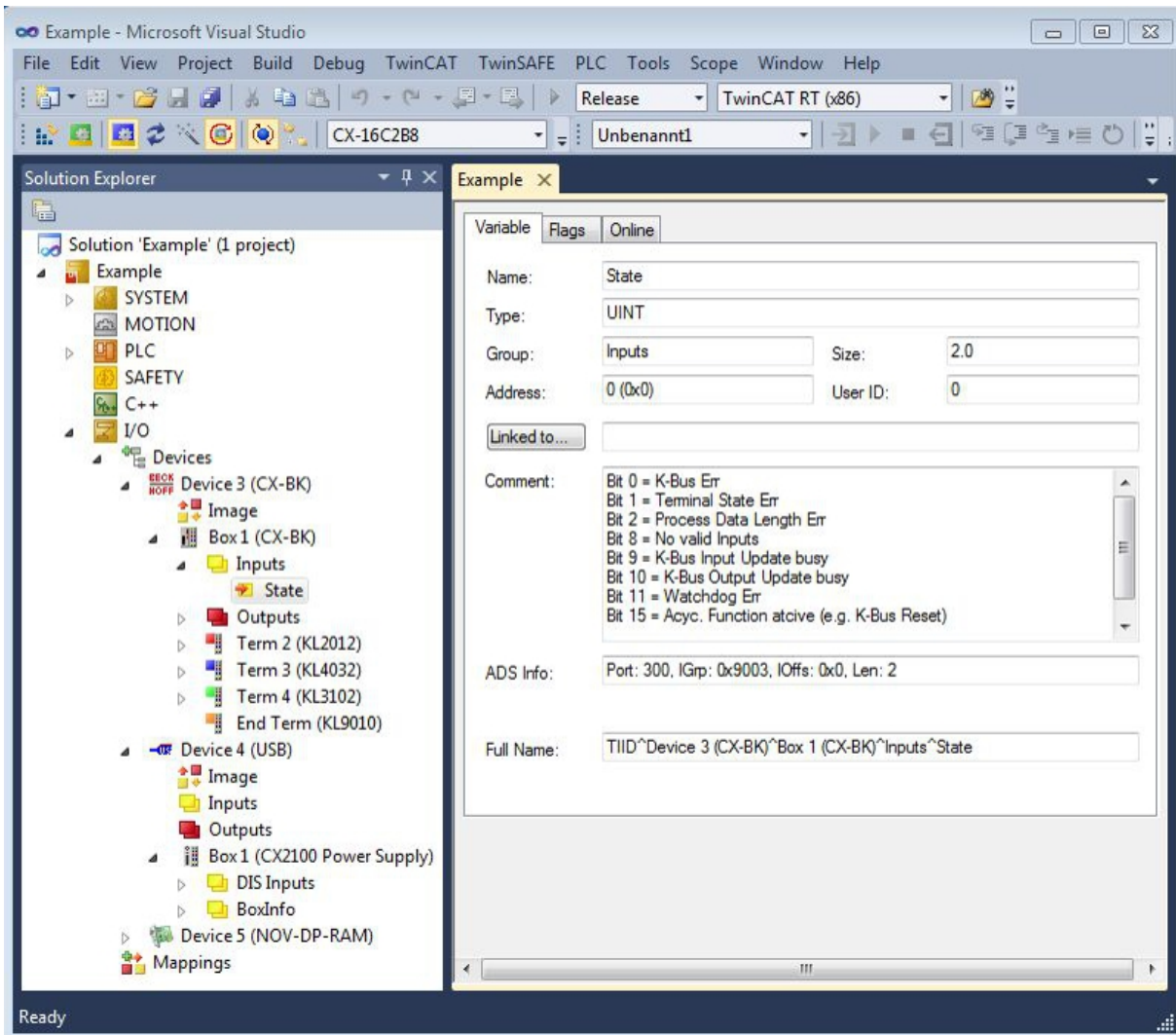

Fig. 10: Status variable for error handling and diagnostics under TwinCAT.

If the value is "0", the K-bus operates synchronous and without error. If the value is \neq "0" there may be a fault, or it may only be an indication that the K-bus cycle is longer than the task. In which case it would no longer be synchronous with the task. The task time should be faster than 100 ms. We recommend a task time of less than 50 ms. The K-bus update time typically lies between one and five ms.

Table 11: Description of the State variable values.

Bit	Description
Bit 0	K-bus error.
Bit 1	Terminal configuration has changed since the start.
Bit 2	Process image lengths do not match.
Bit 8	(still) no valid inputs.
Bit 9	K-bus input update not yet complete.
Bit 10	K-bus output update not yet complete.
Bit 11	Watchdog.
Bit 15	Acyclic K-bus function active (e.g. K-bus reset).

If there is a K-bus error, this can be reset via the IOF_DeviceReset function block (in the TcIoFunctions.lib).

7.3 E-bus

The power supply unit checks the connected EtherCAT Terminals. The "L/A" LED is lit in E-bus mode. The "L/A" LED flashes during data transfer.

Table 12: Diagnostic LEDs in K-Bus mode.

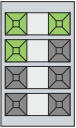
Display	LED	Meaning	
Us 24 V  Up 24 V L/A	Us 24 V	Power supply for basic CPU module. The LED lights green if the power supply is correct.	
	Up 24 V	Power supply for terminal bus. The LED lights green if the power supply is correct.	
	L / A	off	E-bus not connected.
	on	E-bus connected / no data traffic.	
	flashes	E-bus connected / data traffic on the E-bus.	

8 Decommissioning

8.1 Removing cables

NOTICE

Electrical voltage

If the power supply is switched on during dismounting, this can lead to damage to the Embedded PCs.

- Switch off the power supply for the Embedded PC during disassembly.

i Cabling

Make a note of the wiring configuration, if you wish to restore it with another device.

Before dismantling the embedded PC, shut down the embedded PC and switch off the power supply. Only then can you remove all the cables. Also remove all cables from the first terminal after the power supply terminal.

Requirements:

- Exit the software and shut down the embedded PC.
- Switch off the power supply.

Remove the cables as follows:

1. Remove the wiring from the basic CPU module, any system interfaces that may be connected and the extension modules.
2. Remove the wiring from the first terminal next to the power supply terminal.
3. Pull the orange strap to remove the first terminal after the power supply terminal by pulling it forward.

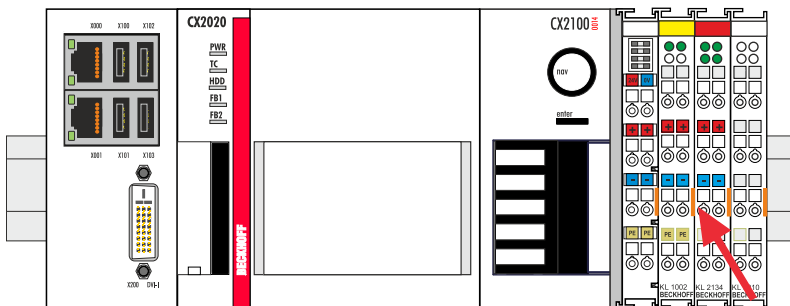

⇒ In the next step the embedded PC can be removed from the DIN rail and dismantled.

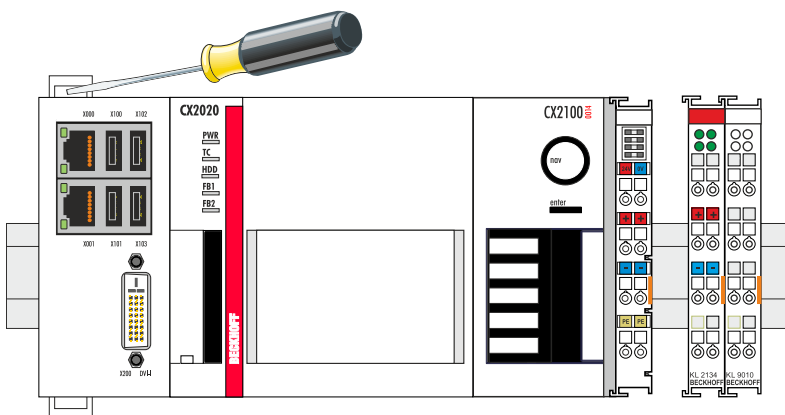

8.2 Disassembling the power supply unit

The CX2000 Embedded PC series is a modular system and enables individual modules to be replaced or removed quite easily. This section describes how to remove devices from the CX2000 Embedded PC series.

Requirements:

- All cables were removed from the embedded PC.

Dismantle the embedded PC as follows:

1. Release the DIN rail mounting by pushing the latches outwards with a screwdriver.

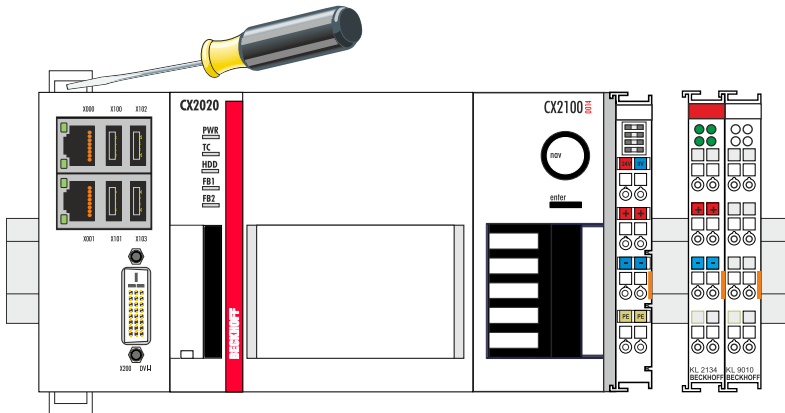

2. Pull the orange strap on the power supply unit and gently remove the device from the DIN rail.

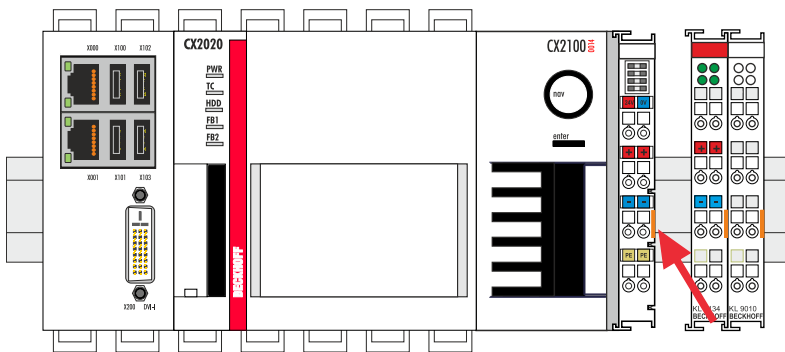

3. Lift the bar clips with the aid of a screwdriver and remove the bar clips.

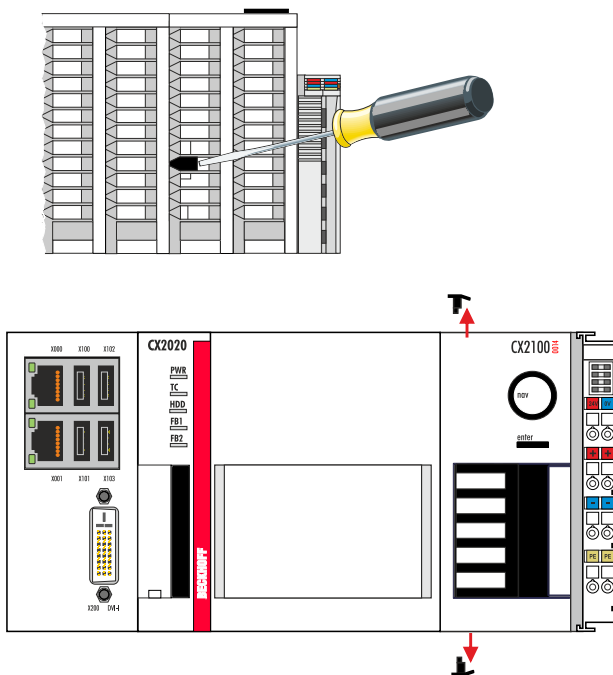

⇒ Once the bar clips have been removed successfully, the modules can be separated from each other.

Disposal

The device must be fully dismantled in order to dispose of it. Electronic components must be disposed of according to national electronic waste regulations.

9 Technical data

Table 13: Technical data, dimensions and weights.

Technical data	CX2100-0014
Dimensions (W x H x D)	60 mm x 100 mm x 91 mm
Weight	550 g

Table 14: Technical data, general data.

Technical data	CX2100-0014
Power supply	24 V DC (-15 %/+20 %)
Dielectric strength	500 V (supply / internal electronics)
Connection type	spring-loaded system
Max. output	130 W
Max. power consumption	3.5 W
UPS	-
Charge	-
Display	FSTN display 2 lines x 16 characters of text, illuminated
Diagnostic LED	1 x PWR, 1 x I/O Run, 1 x I/O Err
Approvals	CE, UL

Table 15: Technical data, I/O terminals.

Technical data	CX2100-0014
I/O connection	K-bus or E-bus, automatic recognition
Power supply for I/O terminals	max. 2 A
Power contacts current loading	max. 10 A
Process data on the K-bus	max. 2048 bytes input and 2048 bytes output
max. number of terminals (K-bus)	64 (255 with K-bus extension)
max. number of terminals (E-bus)	Up to 65534 terminals

Table 16: Technical data, environmental conditions.

Technical data	CX2100-0014
Ambient temperature during operation	-25° C ... +60° C
Ambient temperature during storage	-40° C ... +85° C
Relative humidity	95% no condensation
Shock resistance	conforms to EN 60068-2-27
Vibration resistance	conforms to EN 60068-2-6
EMC immunity	conforms to EN 61000-6-2
EMC emission	conforms to EN 61000-6-4
Protection class	IP 20

10 Appendix

10.1 Certifications

FCC Approvals for the United States of America

FCC: Federal Communications Commission Radio Frequency Interference Statement

This equipment has been tested and found to comply with the limits for a Class A digital device, pursuant to Part 15 of the FCC Rules. These limits are designed to provide reasonable protection against harmful interference when the equipment is operated in a commercial environment. This equipment generates, uses, and can radiate radio frequency energy and, if not installed and used in accordance with the instruction manual, may cause harmful interference to radio communications. Operation of this equipment in a residential area is likely to cause harmful interference in which case the user will be required to correct the interference at his own expense.

FCC Approval for Canada

FCC: Canadian Notice

This equipment does not exceed the Class A limits for radiated emissions as described in the Radio Interference Regulations of the Canadian Department of Communications.

10.2 Support and Service

Beckhoff and their partners around the world offer comprehensive support and service, making available fast and competent assistance with all questions related to Beckhoff products and system solutions.

Download finder

Our [download finder](#) contains all the files that we offer you for downloading. You will find application reports, technical documentation, technical drawings, configuration files and much more.

The downloads are available in various formats.

Beckhoff's branch offices and representatives

Please contact your Beckhoff branch office or representative for [local support and service](#) on Beckhoff products!

The addresses of Beckhoff's branch offices and representatives round the world can be found on our internet page: www.beckhoff.com

You will also find further documentation for Beckhoff components there.

Beckhoff Support

Support offers you comprehensive technical assistance, helping you not only with the application of individual Beckhoff products, but also with other, wide-ranging services:

- support
- design, programming and commissioning of complex automation systems
- and extensive training program for Beckhoff system components

Hotline: +49 5246 963-157
e-mail: support@beckhoff.com

Beckhoff Service

The Beckhoff Service Center supports you in all matters of after-sales service:

- on-site service
- repair service
- spare parts service
- hotline service

Hotline: +49 5246 963-460
e-mail: service@beckhoff.com

Beckhoff Headquarters

Beckhoff Automation GmbH & Co. KG

Huelshorstweg 20
33415 Verl
Germany

Phone: +49 5246 963-0
e-mail: info@beckhoff.com
web: www.beckhoff.com

11 List of tables

Table 1	Dimensions and weights.	10
Table 2	Other power supply units and compatible Embedded PCs from the CX2000 series.	11
Table 3	Legend for the configuration.	12
Table 4	Legend for the name plate.	13
Table 5	Compatible Embedded PCs and permissible mounting positions.	16
Table 6	Legend for the connection example.	20
Table 7	Required wire cross-sections and strip lengths.	21
Table 8	Diagnostic LEDs in K-Bus mode.	41
Table 9	K-bus ERR LED, fault indication sequence through the LED.	41
Table 10	K-BUS ERR LED, fault description and troubleshooting.	42
Table 11	Description of the State variable values.	43
Table 12	Diagnostic LEDs in K-Bus mode.	44
Table 13	Technical data, dimensions and weights.	48
Table 14	Technical data, general data.	48
Table 15	Technical data, I/O terminals.	48
Table 16	Technical data, environmental conditions.	48

12 List of figures

Fig. 1	Configuration of the CX2100-0014 power supply unit.....	12
Fig. 2	CX2100-0014 power supply unit name plate.	13
Fig. 3	CX2020 Embedded PC, horizontal installation position.....	16
Fig. 4	CX2040 Embedded PC, vertical installation position.	17
Fig. 5	CX2040 Embedded PC, horizontal installation position.....	17
Fig. 6	Identifying a passive EtherCAT Terminal in TwinCAT.	19
Fig. 7	Passive EtherCAT Terminals, permissible installation.....	19
Fig. 8	Passive EtherCAT Terminals, invalid installation.....	19
Fig. 9	UL label for CX20xx Embedded PC.....	22
Fig. 10	Status variable for error handling and diagnostics under TwinCAT.....	43

More Information:
www.beckhoff.com/CX2100-0014

Beckhoff Automation GmbH & Co. KG
Hülshorstweg 20
33415 Verl
Germany
Phone: +49 5246 9630
info@beckhoff.com
www.beckhoff.com

