

BECKHOFF

CB1064-XXXX

Manual

Rev. 1.2



Kabylake

Beckhoff Automation GmbH & Co. KG
Eiserstr. 5
33415 Verl
Germany

phone: +49 (0) 52 46/963-0
fax: +49 (0) 52 46/963-198
email: info@beckhoff.de
web: www.beckhoff.de

Contents

0	Document History.....	7
1	Introduction	8
1.1	Notes on the Documentation	8
1.1.1	Disclaimer	8
1.1.2	Trademarks.....	8
1.1.3	Patent Pending	8
1.1.4	Copyright.....	8
1.2	Safety Instructions	9
1.2.1	Disclaimer	9
1.2.2	Description of Safety Symbols.....	10
1.3	FCC Approvals for the United States of America	10
1.4	FCC Approval for Canada	10
1.5	Essential Safety Measures	11
1.5.1	Operator's Obligation to Exercise Diligence	11
1.5.2	National Regulations Depending on the Machine Type	11
1.5.3	Operator Requirements	11
1.6	Functional Range.....	12
2	Overview	13
2.1	Features.....	13
2.2	Feature List.....	14
2.3	Specifications and Documents	15
3	Connectors.....	16
3.1	Power Supply, System Connectors, CPU	17
3.1.1	Power Supply.....	17
3.1.2	System	19
3.1.3	CPU Socket	20
3.1.4	CMOS Battery.....	21
3.2	Back Panel Connectors	22
3.2.1	DVI Connectors.....	22
3.2.2	DVI/HDMI.....	24
3.2.3	Display Port.....	25
3.2.4	PS/2 Keyboard and Mouse.....	26
3.2.5	Serial Port COM1	27
3.2.6	USB and LAN.....	28
3.2.7	Audio Connectors	30
3.3	SATA and Memory	31
3.3.1	SATA Interfaces.....	31
3.3.2	Memory	32
3.4	Internal Connectors	35
3.4.1	USB 2.0.....	35
3.4.2	Serial ports COM2 to COM4.....	36
3.4.3	CD-In.....	37
3.4.4	S/PDIF	38
3.4.5	PCI Interfaces	39
3.4.6	PCI-express Interfaces (x1).....	41
3.4.7	PCI-express Interfaces (x4).....	42

Contents

3.4.8	PCI-express Interface (x16).....	44
3.4.9	SMB/I2C.....	46
3.4.10	GPIO.....	47
3.4.11	Fan Connectors.....	48
3.5	Jumper Settings.....	49
3.5.1	Clear CMOS.....	49
3.5.2	Jumper: Keyboard Power (KBPWR).....	50
4	BIOS-Einstellungen.....	51
4.1	General Remarks.....	51
4.2	Main.....	52
4.3	Advanced.....	54
4.3.1	Platform Misc Configuration Configuration.....	56
4.3.2	CPU Configuration.....	60
4.3.3	Intel(R) I210 Gigabit Network Connection.....	64
4.3.4	Intel(R) Ethernet Connection I219-LM.....	66
4.3.5	Driver Health.....	67
4.3.6	Trusted Computing.....	70
4.3.7	ACPI Settings.....	71
4.3.8	SCH3114 Super IO Configuration.....	72
4.3.9	H/W Monitor.....	74
4.3.10	Serial Port Console Redirection.....	76
4.3.11	PCI Subsystem Settings.....	79
4.3.12	Network Stack Configuration.....	81
4.3.13	Power Controller Options.....	82
4.3.14	Compatibility Support Module Configuration.....	84
4.3.15	NVMe Controller and Drive Information.....	85
4.3.16	USB Configuration.....	86
4.3.17	SATA and RST Configuration.....	87
4.3.18	AMT Configuration.....	91
4.4	Chipset.....	97
4.4.1	System Agent (SA) Configuration.....	98
4.4.2	PCH-IO Configuration.....	110
4.5	Security.....	120
4.5.1	Secure Boot Menu.....	121
4.6	Boot.....	123
4.6.1	Fixed Boot Order Priority.....	125
4.7	Save & Exit.....	126
4.8	BIOS Update.....	127
5	Mechanical Drawings.....	128
5.1	PCB: Mounting Holes.....	128
5.2	PCB: Dimensions.....	129
6	Technical Data.....	130
6.1	Electrical Data.....	130
6.2	Environmental Conditions.....	130
6.3	Thermal Specifications.....	131
7	Support and Service.....	132
7.1	Beckhoff's Branch Offices and Representatives.....	132
7.2	Beckhoff Support.....	132

7.3	Beckhoff Service	132
7.4	Beckhoff Headquarters	132
I	Annex: Post-Codes	134
II	Annex: Resources	135
	Interrupt	135
	PCI Devices	135
	Ressourcen: SMB-Devices	136

0 Document History

Version	Changes
0.1	first pre-release
1.0	first released version
1.1	Annex II: added SMB table
1.2	Updated mechanical drawings

All company names, brand names, and product names referred to in this manual are registered or unregistered trademarks of their respective holders and are, as such, protected by national and international law.

1 Introduction

1.1 Notes on the Documentation

This description is only intended for the use of trained specialists in control and automation engineering who are familiar with the applicable national standards.

It is essential that the documentation and the following notes and explanations are followed when installing and commissioning the components.

It is the duty of the technical personnel to use the documentation published at the respective time of each installation and commissioning.

The responsible staff must ensure that the application or use of the products described satisfy all the requirements for safety, including all the relevant laws, regulations, guidelines and standards.

1.1.1 Disclaimer

The documentation has been prepared with care. The products described are, however, constantly under development.

For that reason the documentation is not in every case checked for consistency with performance data, standards or other characteristics.

None of the statements of this manual represents a guarantee (Garantie) in the meaning of § 443 BGB of the German Civil Code or a statement about the contractually expected fitness for a particular purpose in the meaning of § 434 par. 1 sentence 1 BGB.

In the event that it contains technical or editorial errors, we retain the right to make alterations at any time and without warning.

No claims for the modification of products that have already been supplied may be made on the basis of the data, diagrams and descriptions in this documentation.

1.1.2 Trademarks

Beckhoff®, TwinCAT®, EtherCAT®, Safety over EtherCAT®, TwinSAFE®, XFC® and XTS® are registered trademarks and licensed by Beckhoff Automation GmbH & Co. KG.

Other designations used in this publication may be trademarks whose use by third parties for their own purposes could violate the rights of the owners.

1.1.3 Patent Pending

The EtherCAT Technology is covered, including but not limited to the following patent applications and patents:

EP1590927, EP1789857, DE 102004044764, DE 102007017835

with corresponding applications or registrations in various other countries.

The TwinCAT Technology is covered, including but not limited to the following patent applications and patents:

EP0851348, US6167425 with corresponding applications or registrations in various other countries..

EtherCAT® is registered trademark and patented technology, licensed by Beckhoff Automation GmbH & Co. KG, Germany.

1.1.4 Copyright

© Beckhoff Automation GmbH & Co. KG, Germany.

The reproduction, distribution and utilization of this document as well as the communication of its contents to others without express authorization are prohibited.

Offenders will be held liable for the payment of damages. All rights reserved in the event of the grant of a patent, utility model or design.

1.2 Safety Instructions

Consider the following safety instructions and descriptions!





Product specific safety instructions are to be found on the following pages or in the areas mounting, wiring, commissioning etc.

1.2.1 Disclaimer

All the components are supplied in particular hardware and software configurations appropriate for the application. Modifications to hardware or software configurations other than those described in the documentation are not permitted, and nullify the liability of Beckhoff Automation GmbH & Co. KG.

1.2.2 Description of Safety Symbols

The following safety symbols are used in this documentation. You have to read the safety symbols carefully and adhere them strictly!

 DANGER	<p>Acute risk of injury!</p> <p>If you do not adhere the safety advise adjoining this symbol, there is immediate danger to life and health of individuals!</p>
 WARNING	<p>Risk of injury!</p> <p>If you do not adhere the safety advise adjoining this symbol, there is danger to life and health of individuals!</p>
 CAUTION	<p>Hazard to devices and environment</p> <p>If you do not adhere the safety advise adjoining this symbol, there is obvious hazard to individuals!</p>
 Attention	<p>Hazard to devices and environment</p> <p>If you do not adhere the notice adjoining this symbol, there is obvious hazard to materials and environment.</p>
 Notice	<p>Note or pointer</p> <p>This symbol indicates information that contributes to better understanding.</p>

1.3 FCC Approvals for the United States of America

FCC: Federal Communications Commission Radio Frequency Interference Statement

This equipment has been tested and found to comply with the limits for a Class A digital device, pursuant to Part 15 of the FCC Rules. These limits are designed to provide reasonable protection against harmful interference when the equipment is operated in a commercial environment. This equipment generates, uses, and can radiate radio frequency energy and, if not installed and used in accordance with the instruction manual, may cause harmful interference to radio communications. Operation of this equipment in a residential area is likely to cause harmful interference in which case the user will be required to correct the interference at his own expense.

1.4 FCC Approval for Canada

FCC: Canadian Notice

This equipment does not exceed the Class A limits for radiated emissions as described in the Radio Interference Regulations of the Canadian Department of Communications.

1.5 Essential Safety Measures

1.5.1 Operator's Obligation to Exercise Diligence

The operator must ensure that

- the product is only used for its intended purpose
- the product is only operated in sound condition and in working order
- the instruction manual is in good condition and complete, and always available for reference at the location where the products are used
- the product is only used by suitably qualified and authorised personnel
- the personnel is instructed regularly about relevant occupational safety and environmental protection aspects
- the operating personnel is familiar with the operating manual and in particular the safety notes contained herein

1.5.2 National Regulations Depending on the Machine Type

Depending on the type of machine and plant in which the product is used, national regulations governing the controllers of such machines will apply, and must be observed by the operator. These regulations cover, amongst other things, the intervals between inspections of the controller. The operator must initiate such inspections in good time.

1.5.3 Operator Requirements

- Read the operating instructions

All users of the product must have read the operating instructions for the system they work with.

- System know-how

All users must be familiar with all accessible functions of the product.

1.6 Functional Range

The descriptions contained in the present documentation represent a detailed and extensive product description. As far as the described motherboard was acquired as an integral component of an Industrial PC from Beckhoff Automation GmbH & Co. KG, this product description shall be applied only in limited scope. Only the contractually agreed specifications of the corresponding Industrial PC from Beckhoff Automation GmbH & Co. KG shall be relevant. Due to several models of Industrial PCs, variations in the component placement of the motherboards are possible. Support and service benefits for the built-in motherboard will be rendered by Beckhoff Automation GmbH & Co. KG exclusively as specified in the product description (inclusive operation system) of the particular Industrial PC.

2 Overview

2.1 Features

The CB1064 is a computer motherboard for industrial applications. Complying to the ATX form factor and based on Intel®'s Q170 PCH chipset, it is equipped with an LGA1151 CPU socket for Intel® CPUs of the 6th and 7th Generation Core™- families. Modern DDR4 technology provides top-notch memory performance, accommodating up to 64 GByte of RAM (DDR4-2133) via SO-DIMM260. Expansion cards can be added into two PCI slots, two PCIe x1 slots, two PCIe x4 slots and one PCIe x16 slots. The CB1064 also offers a wide range of internal and external connectors, such as four serial ports, two LAN connectors, 12 USB channels, six SATA connectors offering up to 6Gb/s, digital and analogue audio, DVI/HDMI connectors, DisplayPort connector, etc.

In addition the board serves via the integrated Trusted Platform Module as Trusted Computing Platform and provides essential safety functions.

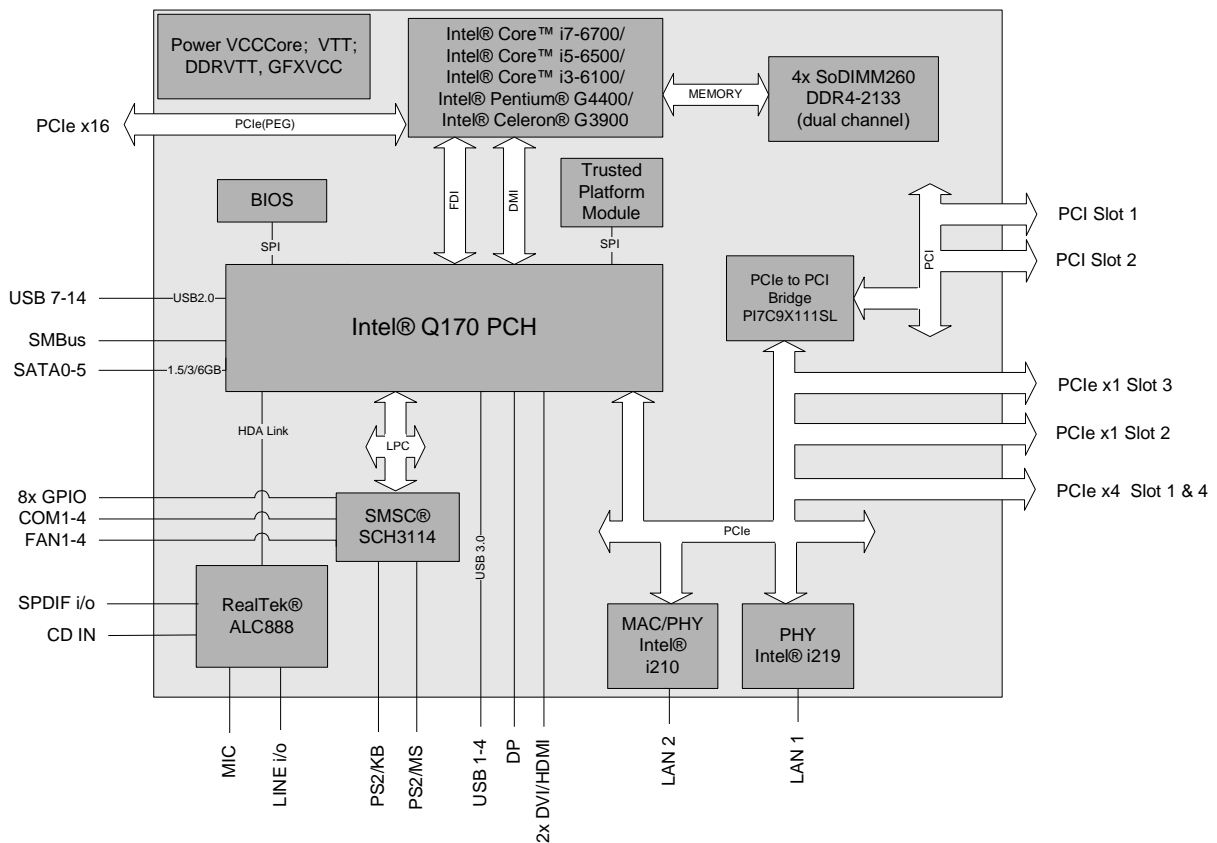

2.2 Feature List

CB1064	ATX-Board	
CPU	Intel® Core™ i5 6500TE (6M, 4 Cores, 35W TDP)	
	Intel® Core™ i7 6700TE (8M, 4 Cores, 35W TDP)	
Chipset	Intel® Q170	
Socket	LGA1151	
Memory	4x DDR4@2133MHz à 16GB, SODIMM260 (NonECC), total memory capacity up to 64GByte	
I/O	Internal	3x COM
		6x SATA 3.0, RAID 0/1/5/10
		2x PCI32-Slot
		2x PCIe x1 (3.0) + 2x PCIe x4 (3.0) + 1x PCIe x16 (3.0)
		8x USB 2.0
		8x GPIO
		4x FAN (from which 3 are regulated)
		1x SMB interface
	External	1x DisplayPort1.2
		1x Sound (Mic, Line out, Aux)
		1x PS/2 mouse & keyboard
		2x DVI-D (DVI oder HDMI 1.4)
		4x USB 3.0
		2x GBit-LAN, Intel® i219/i210
		1x COM
Graphics	HDMI1.4: 2560x1600@60Hz; 4096x2160@24Hz DisplayPort: 4096x2304@60Hz DVI: 1920x1200@60Hz	
RTC	Internal or external CMOS battery	
BIOS	AMI® Aptio V	
Power Supply	Standard ATX PSU	
Format	ATX (305mm x 220mm)	

2.3 Specifications and Documents

In making this manual and for further reading of technical documentation, the following documents, specifications and web-pages were used and are recommended.

- ATX Specification
Version 2.2
www.formfactors.com
- PCI Specification
Version 2.3 resp. 3.0
www.pcisig.com
- PCI Express® Base Specification
Version 2.0
www.pcisig.com
- ACPI Specification
Version 5.0
www.acpi.info
- ATA/ATAPI Specification
Version 7 Rev. 1
www.t13.org
- USB Specifications
www.usb.org
- SM-Bus Specification
Version 2.0
www.smbus.org
- Intel® Chipset Description
Intel® 8 Series Chipset datasheet
www.intel.com
- Intel® Chip Description
6th Gen. Intel® Core™ Processor Family Mobile datasheet
www.intel.com
- Intel® Chip Description
i219 Datasheet
www.intel.com
- Intel® Chip Description
i210 Datasheet
www.intel.com
- SMSC® Chip Description
SCH3114 Datasheet
www.smsc.com
(NDA required)
- Realtek® Chip Description
ALC885/889 Datasheet
www.realtek.com.tw
- American Megatrends®
Aptio™ Text Setup Environment (TSE) User Manual
www.ami.com
- American Megatrends®
Aptio™ 5.x Status Codes
www.ami.com

3 Connectors

This section describes all the connectors found on the CB1064.

**Notice****Please consider the requirements on the cabling!**

For most interfaces, the cables must meet certain requirements. For instance, USB 2.0 requires twisted and shielded cables to reliably maintain full speed data rates. Restrictions on maximum cable length are also in place for many high speed interfaces and for power supply. Please refer to the respective specifications and use suitable cables at all times.

3.1 Power Supply, System Connectors, CPU

3.1.1 Power Supply

The connector for the power supply is a 2x12pin ATX connector ("ATX24"). It is accompanied by a 2x4pin connector, which must be used to provide the COREIN power supply.

2x4pin connector:

Manufacturer	Description	Mating connector
Molex	39-29-3086	e.g. 39-01-2085

2x12pin connector:

Manufacturer	Description	Mating Connector
Amphenol	MF42-SD-24LK	Standard ATX connector

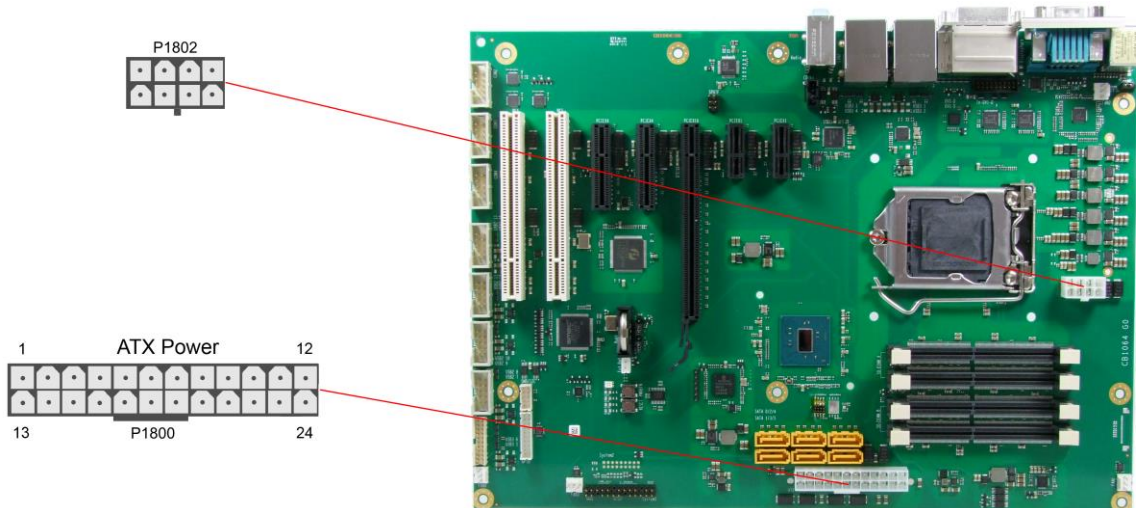

Pinout ATX power connector 2x2:

Description	Name	Pin	Name	Description
ground	GND	1	3	COREIN
ground	GND	2	4	COREIN
				12 volt supply
				12 volt supply

Pinout "ATX24" power connector:

Description	Name	Pin	Name	Description
3.3 volt supply	3.3V	1	13	3.3V
3.3 volt supply	3.3V	2	14	-12V
ground	GND	3	15	GND
5 volt supply	VCC	4	16	PS_ON
ground	GND	5	17	GND
5 volt supply	VCC	6	18	GND
ground	GND	7	19	GND
ATX Powergood	PWRGOOD	8	20	-5V
standby supply 5V	SVCC	9	21	VCC
12 volt supply	12V	10	22	VCC
12 volt supply	12V	11	23	VCC
				5 volt supply

Description	Name	Pin		Name	Description
3.3 volt supply	3.3V	12	24	GND	ground

3.1.2 System

Typical signals for system control are provided through a 2x13 IDC socket connector with a spacing of 2.54mm. This connector combines signals for power button, reset, keyboard lock and several LEDs.

Manufacturer	Description	Mating Connector
Samtec	TSW-113-07-S-D	XXX-113-01-T-D

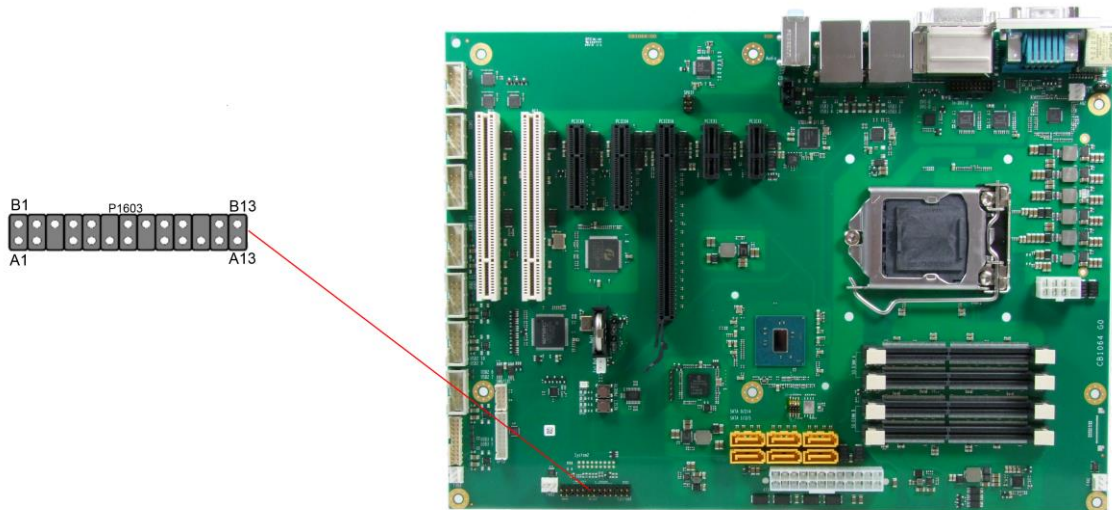

Pinout IDC socket connector "System 1":

Description	Name	Pin		Name	Description
on/suspend button	PWRBTN#	A1	B1	GND	ground
ground	GND	A2	B2	N/C	reserved
reserved	N/C	A3	B3	PWLED#	power LED
ground	GND	A4	B4	N/C	reserved
5 volt supply	VCC	A5	B5	PWLED	3.3 volt supply
harddisk LED	HDLED#	A6	B6	N/C	reserved
5 volt supply	VCC	A7	B7	VCC	5 volt supply
reserved	N/C	A8	B8	GND	ground
IrDA transmit	IRTX	A9	B9	N/C	reserved
ground	GND	A10	B10	BEEP	speaker
reserved	N/C	A11	B11	N/C	reserved
reserved	N/C	A12	B12	GND	ground
5 volt supply	VCC	A13	B13	RESET#	reset

3.1.3 CPU Socket

The CB1064 board has an LGA1151 CPU socket accomodating certain versions of Intel®'s 6th and 7th Generation Core™ architecture CPUs. The LGA1151 is a socket, in which the processor is inserted and subsequently gets fixed by using the clamping bracket. There is only one orientation in which the processor will fit into the socket. Once the processor is in place, the clamping bracket must be fixed to ensure proper electrical contact.

	<p>In case of improper insertion of the processor contacts can bend and therefore be damaged.</p>
<p>Notice</p>	<p>Processors must be ordered separately. The board ships without a CPU.</p>

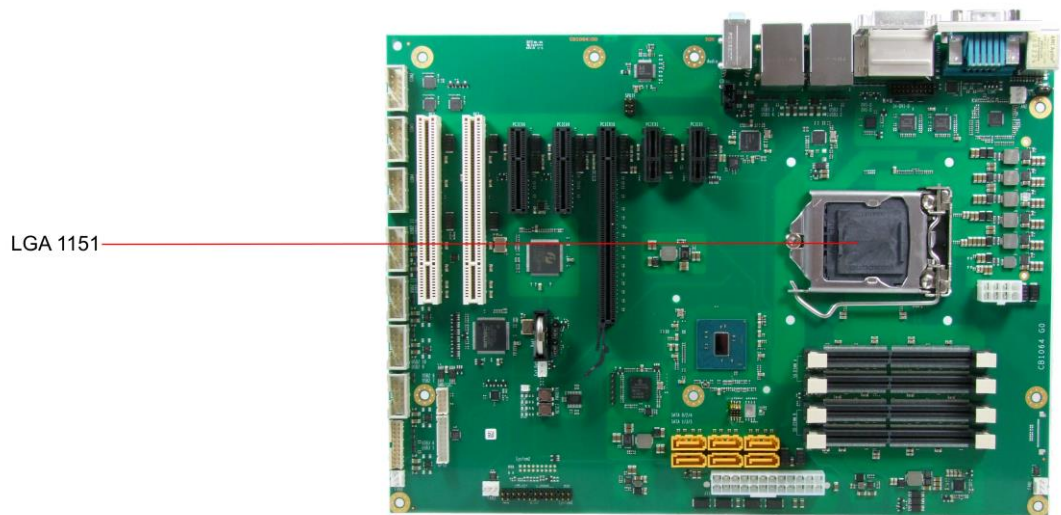

3.1.4 CMOS Battery

The board ships with a CR2032 battery holder and 3V battery. Alternatively, an external battery can be connected via a 2pin connector.

Manufacturer	Description	Mating Connector
RenataSA	VBH2032-1	(battery)

2pin connector for external battery:

Manufacturer	Description	Mating Connector
JST	B 2B-EH-A(LF)(SN)	JST 02HR-6S-P-N

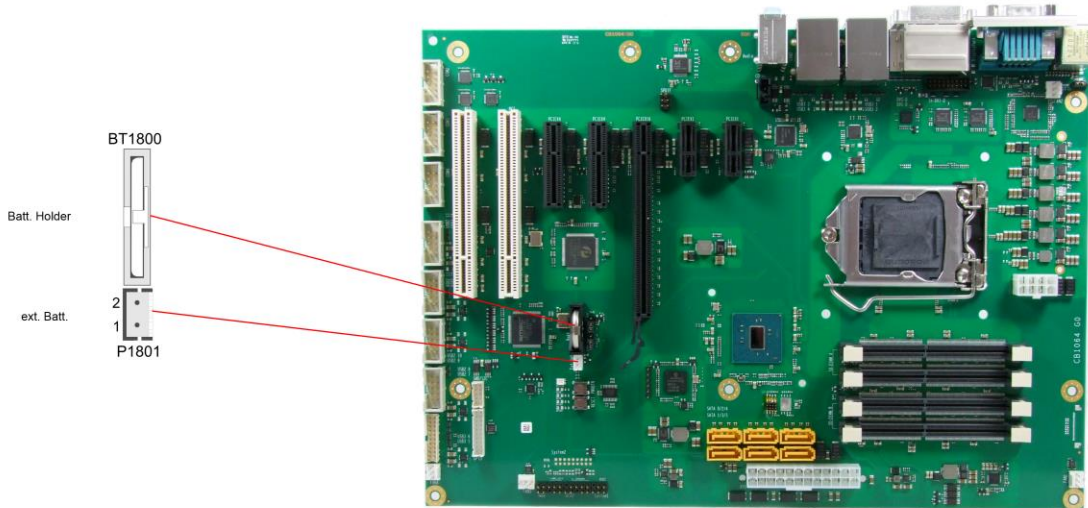

Pin	Name	Description
1	BATT	battery 3.3 volt
2	GND	ground

3.2 Back Panel Connectors

The board complies with the ATX form factor and thus honours the "I/O Connector Area" as defined in the ATX specification. A range of standard connectors are available: You can connect PS/2 keyboard and mouse, displays, speakers, microphone, LAN, USB etc. If the board is mounted in a normal ATX compliant case, these connectors are located on the back side of the case.

3.2.1 DVI Connectors

The CB1064 has two DVI-D connectors combined in one component (Foxconn QH11121-DADF-4F). Digital DVI or HDMI displays can be attached to both connectors. The CPU's graphics system supports up to three independent displays.

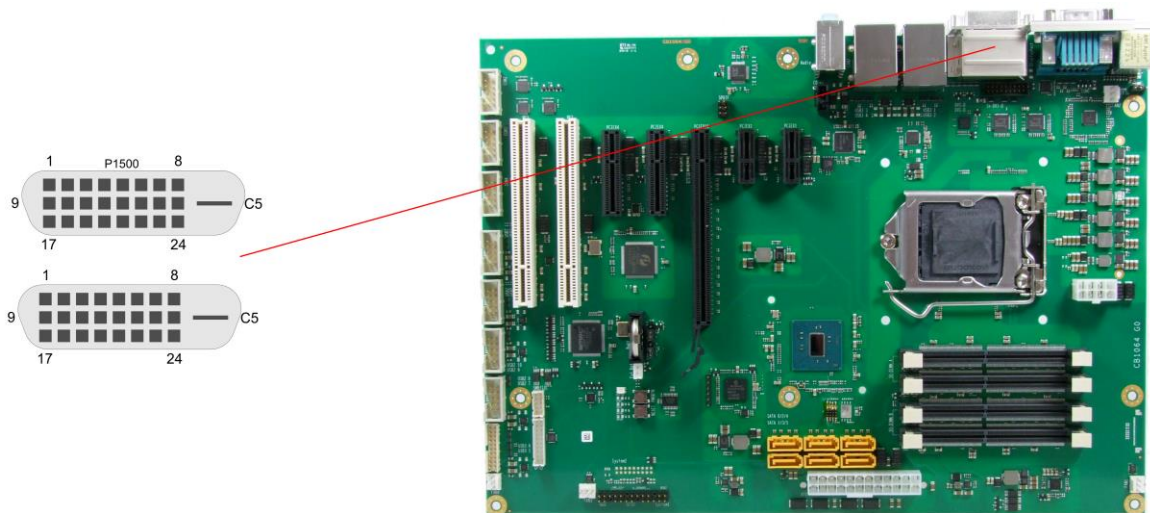

Pinout DVI-D:

Pin	Name	Description
1	TMDSDAT2#	DVI data 2 -
2	TMDSDAT2	DVI data 2 +
3	GND	ground
4	N/C	reserved
5	N/C	reserved
6	DDC CLK	DDC clock (DVI/VGA)
7	DDC DAT	DDC data (DVI/VGA)
8	N/C	reserved
9	TMDSDAT1#	DVI data 1 -
10	TMDSDAT1	DVI data 1 +
11	GND	ground
12	N/C	reserved
13	N/C	reserved
14	VCC	5 volt supply
15	GND	ground
16	HP_DETECT	hot plug detect
17	TMDSDAT0#	DVI data 0 -
18	TMDSDAT0	DVI data 0 +
19	GND	ground
20	N/C	reserved
21	N/C	reserved

Pin	Name	Description
22	GND	ground
23	TMDS CLK	DVI clock +
24	TMDS CLK#	DVI clock -
C1	N/C	reserved
C2	N/C	reserved
C3	N/C	reserved
C4	N/C	reserved
C5	GND	ground

3.2.2 DVI/HDMI

The CB1064 provides a second DVI interface which is realized as a 2x9pin header. Analog VGA is not available on this connector. However, an HDMI device can be connected. This connector and the lower DVI-D connector cannot be used simultaneously.

Manufacturer	Description	Mating Connector
Molex	87831-1820	e.g. Molex 0791098658-ND

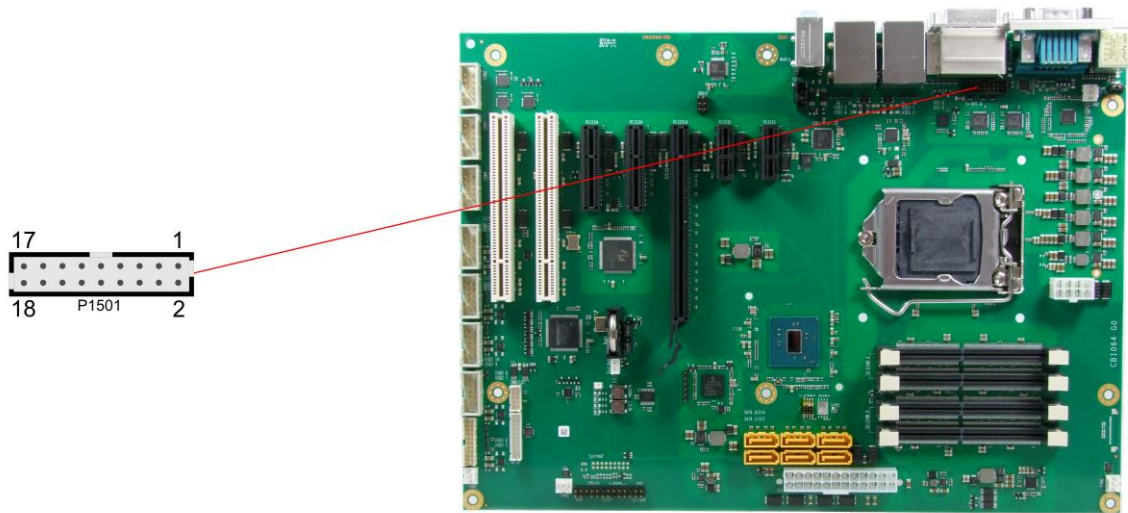

Pinout 2x9pin connector DVI/HDMI:

Description	Name	Pin	Name	Description
HDMI panel detected	HPD_SINK	1	2	N/C reserved
SMBus clock (DDC)	SCL_SINK	3	4	SDA_SINK SMBus dat (DDC)
5 volt supply	VCC	5	6	GND ground
ground	GND	7	8	TMDS_CLK# DVI clock -
DVI data 0 -	TMDS_D0#	9	10	TMDS_CLK DVI clock +
DVI data 0 +	TMDS_D0	11	12	GND ground
ground	GND	13	14	TMDS_D1# DVI data 1 -
DVI data 2 -	TMDS_D2#	15	16	TMDS_D1 DVI data 1 +
DVI data 2 +	TMDS_D2	17	18	GND ground

3.2.3 Display Port

For DisplayPort devices, a suitable standard connector is available (Foxconn 3VD11203-D7AB-4H). The interface also offers HDMI/DVI signals.

An adapter for using HDMI/DVI signals must be applied. Please consult your distributor for such an adapter.

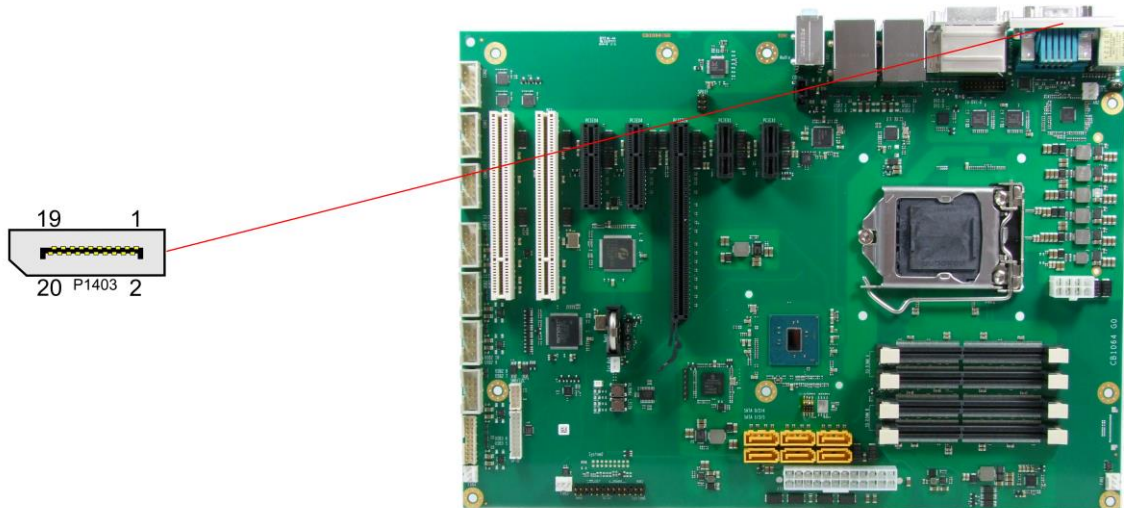

Pinout DisplayPort connector:

Description	Name	Pin	Pin	Name	Description
Displayport Lane 0 +	DPL0	1	2	GND	Ground
Displayport Lane 0 -	DPL0#	3	4	DPL1	Displayport Lane 1 +
Ground	GND	5	6	DPL1#	Displayport Lane 1 -
Displayport Lane 2 +	DPL2	7	8	GND	Ground
Displayport Lane 2 -	DPL2#	9	10	DPL3	Displayport Lane 3 +
Ground	GND	11	12	DPL3#	Displayport Lane 3 -
Configuration pin 1	Config1	13	14	Config2	Configuration pin 2
Displayport Aux +	DPAUX	15	16	GND	Ground
Displayport Aux -	DPAUX#	17	18	HPD	Hotplug Detect
Ground	GND	19	20	3.3V	Power supply 3,3V

3.2.4 PS/2 Keyboard and Mouse

PS/2 mice and keyboards are connected via standard mini-DIN connectors. If you want to use the keyboard or mouse to wake up the board from standby or suspend mode you have to activate this functionality by adjusting the KBPWR jumper settings (page 50). With this jumper you can switch from normal power supply (VCC) to standby power supply (SVCC) for keyboard/mouse. Some relevant settings will have to be adjusted in BIOS setup.

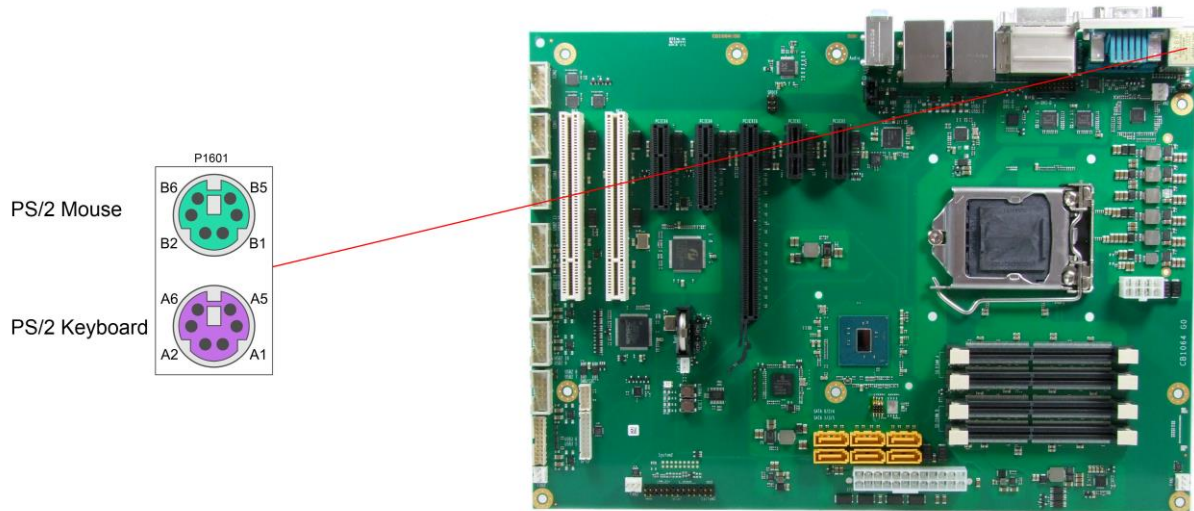

Pinout PS/2 mouse:

Description	Name	Pin		Name	Description
mouse data	MDAT	B1	B2	N/C	reserved
ground	GND	B3	B4	(S)VCC	5 volt supply
mouse clock	MCLK	B5	B6	N/C	reserved

Pinout PS/2 keyboard:

Description	Name	Pin		Name	Description
keyboard data	KDAT	A1	A2	MDAT	mouse data
ground	GND	A3	A4	(S)VCC	5 volt supply
keyboard clock	KCLK	A5	A6	MCLK	mouse clock

3.2.5 Serial Port COM1

The serial port COM1 is made available via a 9 pin connector. Signals are RS232. The port address and the interrupt are set via the BIOS setup.

Manufacturer	Description	Mating Connector
Foxconn	DM10151-N5W3-4F	standard DSUB connector

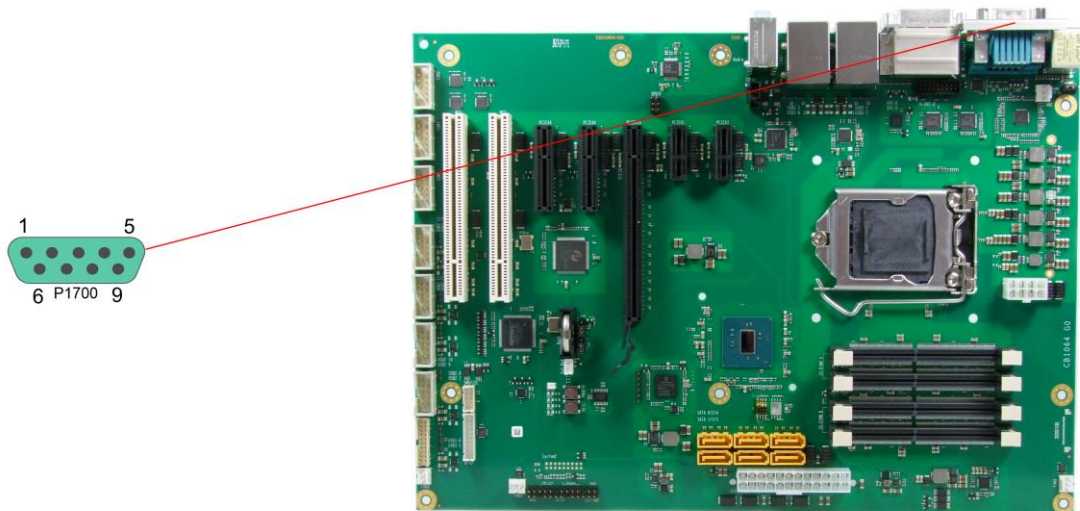

Pinout serial port (DSUB connector):

Description	Name	Pin	Name	Description	
data carrier detect	DCD	1	6	DSR	data set ready
receive data	RXD	2	7	RTS	request to send
transmit data	TXD	3	8	CTS	clear to send
data terminal ready	DTR	4	9	RI	ring indicator
ground	GND	5			

3.2.6 USB and LAN

To save space USB and LAN connectors are provided in the form of combo connectors. These comprise two USB connectors and one LAN connector. This way all board variants provide four external USB channels and two LAN ports.

All USB channels support USB 3.0.

You may note that the setting of USB keyboard or USB mouse support in the BIOS-setup is only necessary and advisable, if the OS offers no USB-support. BIOS-setup can be changed with a USB keyboard without enabling USB keyboard support. Running Windows with these features enabled may lead to significant performance or functionality limitations.

The interfaces provide up to 900 mA current. All USB interfaces are protected by an electronically resettable fuse.

The board also offers two Gigabit-LAN connectors. Both LAN connectors support 10/100/1000 Ethernet with automatic bandwidth selection. Controller chips are the i219 (PHY, LAN1) and i210 (MAC/PHY, LAN2).

 <p>Notice</p>	<p>For realtime applications, the external controller (MAC/PHY) is to prefer.</p>
--	---

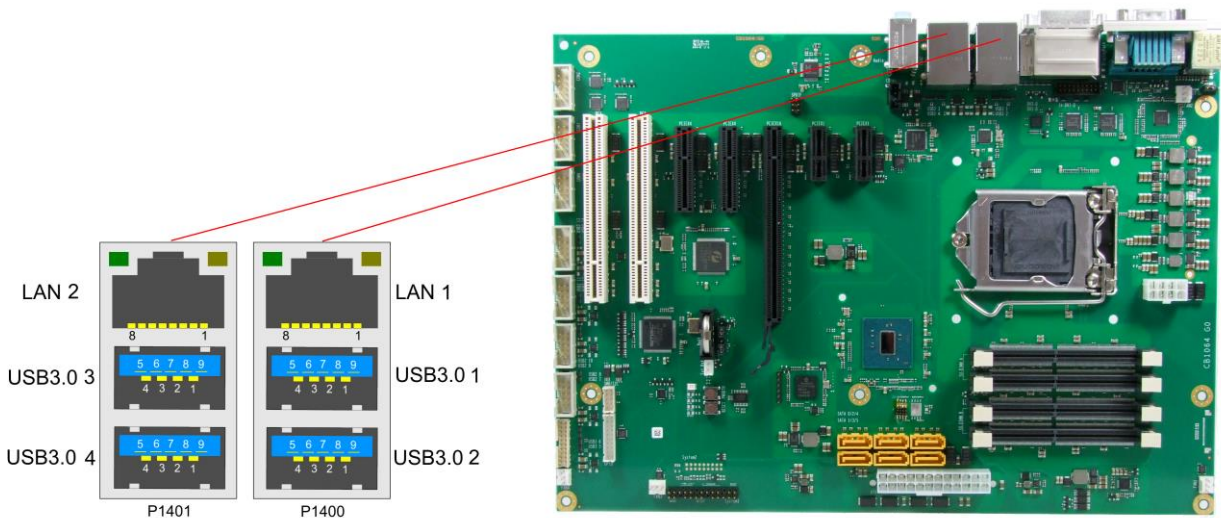

Pinout USB3.0 connector for channel X:

Pin	Name	Description
1	VCC	5 volt for USBX
2	USBX#	Minus channel USBX
3	USBX	Plus channel USBX
4	GND	ground
5	StdA_SSRX-	SuperSpeed Receiver -
6	StdA_SSRX+	SuperSpeed Receiver +
7	GND	ground
8	StdA_SSTX-	SuperSpeed Transmitter -
9	StdA_SSTX+	SuperSpeed Transmitter +

Pinout LAN 10/100/1000:

Pin	Name	Description
1	LAN2-0	LAN2 channel 0 plus
2	LAN2-0#	LAN2 channel 0 minus
3	LAN2-1	LAN2 channel 1 plus
4	LAN2-2	LAN2 channel 2 plus
5	LAN2-2#	LAN2 channel 2 minus
6	LAN2-1#	LAN2 channel 1 minus
7	LAN2-3	LAN2 channel 3 plus
8	LAN2-3#	LAN2 channel 3 minus

3.2.7 Audio Connectors

Line-in, line-out, and microphone signals are provided in the form of three 3,5mm-TRS-connectors.

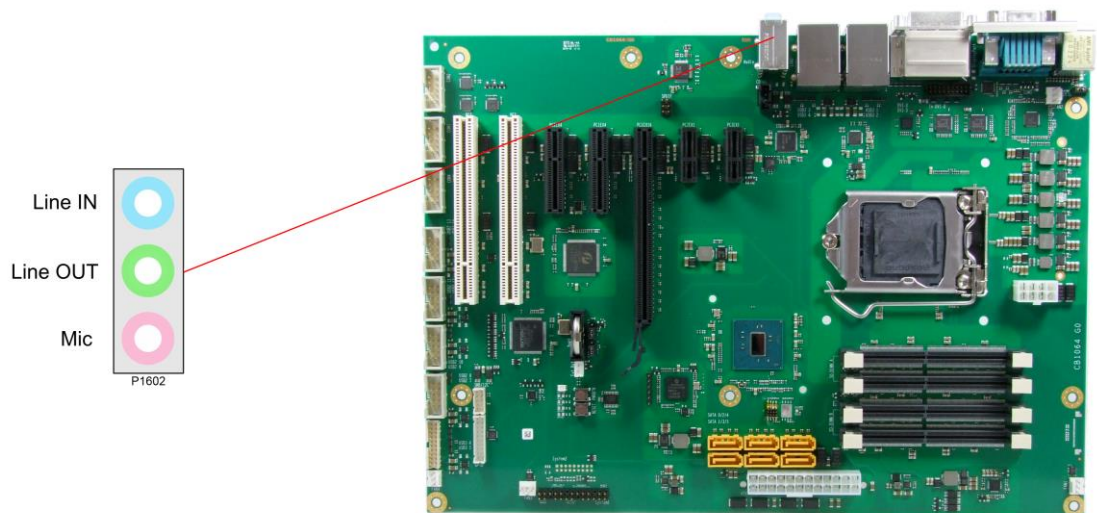

3.3 SATA and Memory

3.3.1 SATA Interfaces

The CB1064 provides six SATA interfaces. They all support transfer rates of 1,5Gbit/s up to 6Gbit/s.

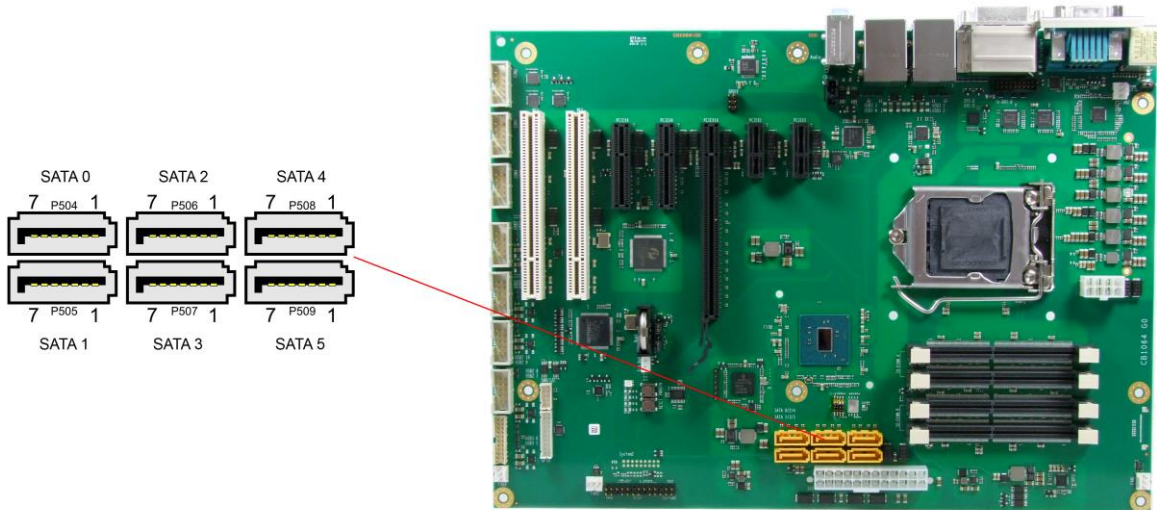

Pinout SATA:

Pin	Name	Description
1	GND	ground
2	SATATX	SATA transmit +
3	SATATX#	SATA transmit -
4	GND	ground
5	SATARX	SATA receive -
6	SATARX#	SATA receive +
7	GND	ground

3.3.2 Memory

The CB1064 is equipped with four SO-DIMM260 sockets for DDR4-2133-RAM. For technical and mechanical reasons it is possible that particular memory modules cannot be employed. Please ask your distributor for recommended memory modules

With currently available memory modules a memory extension up to 64 GByte is possible. All timing parameters for different memory modules are automatically set by BIOS.

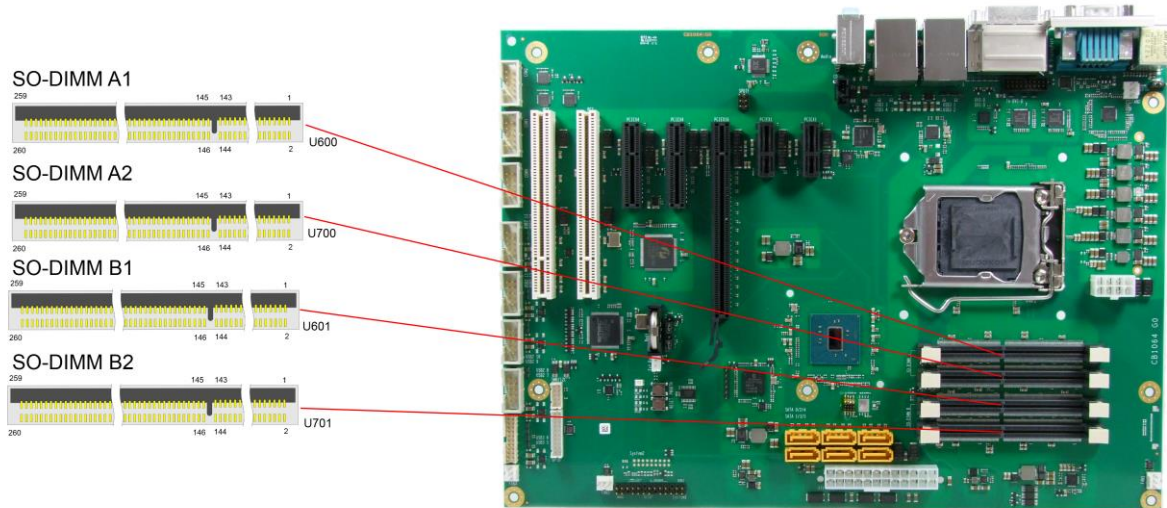

Description	Name	Pin	Name	Description
Ground	GND	1	2	GND
Data lane 5	DQ5	3	4	DQ4
Ground	GND	5	6	GND
Data lane 1	DQ1	7	8	DQ0
Ground	GND	9	10	GND
Data Strobe 0 -	DQS0_c	11	12	NC
Data Strobe 0 +	DQS0_t	13	14	GND
Ground	GND	15	16	DQ6
Data lane 7	DQ7	17	18	GND
Ground	GND	19	20	DQ2
Data lane 3	DQ3	21	22	GND
Ground	GND	23	24	DQ12
Data lane 13	DQ13	25	26	GND
Ground	GND	27	28	DQ8
Data lane 9	DQ9	29	30	GND
Ground	GND	31	32	DQS1_c
Reserved	NC	33	34	DQS1_t
Ground	GND	35	36	GND
Data lane 15	DQ15	37	38	DQ14
Ground	GND	39	40	GND
Data lane 10	DQ10	41	42	DQ11
Ground	GND	43	44	GND
Data lane 21	DQ21	45	46	DQ20
Ground	GND	47	48	GND
Data lane 17	DQ17	49	50	DQ16
Ground	GND	51	52	GND

Description	Name	Pin		Name	Description
Data Strobe 2 -	DQS2_c	53	54	NC	Reserved
Data Strobe 2 +	DQS2_t	55	56	GND	Ground
Ground	GND	57	58	DQ22	Data lane 22
Data lane 23	DQ23	59	60	GND	Ground
Ground	GND	61	62	DQ18	Data lane 18
Data lane 19	DQ19	63	64	GND	Ground
Ground	GND	65	66	DQ28	Data lane 28
Data lane 29	DQ29	67	68	GND	Ground
Ground	GND	69	70	DQ24	Data lane 24
Data lane 25	DQ25	71	72	GND	Ground
Ground	GND	73	74	DQS3_c	Data Strobe 3 -
Reserved	NC	75	76	DQS3_t	Data Strobe 3 +
Ground	GND	77	78	GND	Ground
Data lane 30	DQ30	79	80	DQ31	Data lane 31
Ground	GND	81	82	GND	Ground
Data lane 26	DQ26	83	84	DQ27	Data lane 27
Ground	GND	85	86	GND	Ground
Reserved	NC	87	88	NC	Reserved
Ground	GND	89	90	GND	Ground
Reserved	NC	91	92	NC	Reserved
Ground	GND	93	94	GND	Ground
Data Strobe 8 -	DQS8_c	95	96	NC	Reserved
Data Strobe 8 +	DQS8_t	97	98	GND	Ground
Ground	GND	99	100	NC	Reserved
Reserved	NC	101	102	GND	Ground
Ground	GND	103	104	NC	Reserved
Reserved	NC	105	106	GND	Ground
Ground	GND	107	108	RESET_n	Reset
Clock Enable 0	CKE0	109	110	CKE1	Clock Enable 1
Power supply 1,2V	VCC	111	112	VCC	Power supply 1,2V
Bank Group Input 1	BG1	113	114	ACT_n	Activation Command Input
Bank Group Input 0	BG0	115	116	ALERT_n	Alert
Power supply 1,2V	VCC	117	118	VCC	Power supply 1,2V
Address lane 12	A12	119	120	A11	Address lane 11
Address lane 9	A9	121	122	A7	Address lane 7
Power supply 1,2V	VCC	123	124	VCC	Power supply 1,2V
Address lane 8	A8	125	126	A5	Address lane 5
Address lane 6	A6	127	128	A4	Address lane 4
Power supply 1,2V	VCC	129	130	VCC	Power supply 1,2V
Address lane 3	A3	131	132	A2	Address lane 2
Address lane 1	A1	133	134	EVENT_n	Event
Power supply 1,2V	VCC	135	136	VCC	Power supply 1,2V
Clock-Signal 0 +	CK0_t	137	138	CK1_t	Clock 1 +
Clock-Signal 0 -	CK0_c	139	140	CK1_c	Clock 1 -
Power supply 1,2V	VCC	141	142	VCC	Power supply 1,2V
Even parity check	Parity	143	144	A0	Address lane 0
SDRAM Bank 2	BA1	145	146	A10/AP	Address lane 10/Autoprecharge
Power supply 1,2V	VCC	147	148	VCC	Power supply 1,2V
Chip Select 0	CS0_n	149	150	BA0	Bank Address 0
Address lane 14/Write Enable	A14/WE_n	151	152	A16/RAS_n	Address lane 16/Row Address Strobe
Power supply 1,2V	VCC	153	154	VCC	Power supply 1,2V
On Die Termination 0	ODT0	155	156	A15/CAS_n	Address lane 15/Column Address Strobe

Description	Name	Pin		Name	Description
Chip Select 1	CS1_n	157	158	A13	Address lane 13
Power supply 1,2V	VCC	159	160	VCC	Power supply 1,2V
On Die Termination 1	ODT1	161	162	NC	Reserved
Power supply 1,2V	VCC	163	164	VREFCA	Reference voltage
Reserved	NC	165	166	SA2	SPD address 2
Ground	GND	167	168	GND	Ground
Data lane 37	DQ37	169	170	DQ36	Data lane 36
Ground	GND	171	172	GND	Ground
Data lane 33	DQ33	173	174	DQ32	Data lane 32
Ground	GND	175	176	GND	Ground
Data Strobe 4 -	DQS4_c	177	178	NC	Reserved
Data Strobe 4 +	DQS4_t	179	180	GND	Ground
Ground	GND	181	182	DQ39	Data lane 39
Data lane 38	DQ38	183	184	GND	Ground
Ground	GND	185	186	DQ35	Data lane 35
Data lane 34	DQ34	187	188	GND	Ground
Ground	GND	189	190	DQ45	Data lane 45
Data lane 44	DQ44	191	192	GND	Ground
Ground	GND	193	194	DQ41	Data lane 41
Data lane 40	DQ40	195	196	GND	Ground
Ground	GND	197	198	DQS5_c	Data Strobe 5 -
Reserved	NC	199	200	DQS5_t	Data Strobe 5 +
Ground	GND	201	202	GND	Ground
Data lane 46	DQ46	203	204	DQ47	Data lane 47
Ground	GND	205	206	GND	Ground
Data lane 42	DQ42	207	208	DQ43	Data lane 43
Ground	GND	209	210	GND	Ground
Data lane 52	DQ52	211	212	DQ53	Data lane 53
Ground	GND	213	214	GND	Ground
Data lane 49	DQ49	215	216	DQ48	Data lane 48
Ground	GND	217	218	GND	Ground
Data Strobe 6 -	DQS6_c	219	220	NC	Reserved
Data Strobe 6 +	DQS6_t	221	222	GND	Ground
Ground	GND	223	224	DQ54	Data lane 54
Data lane 55	DQ55	225	226	GND	Ground
Ground	GND	227	228	DQ50	Data lane 50
Data lane 51	DQ51	229	230	GND	Ground
Ground	GND	231	232	DQ60	Data lane 60
Data lane 61	DQ61	233	234	GND	Ground
Ground	GND	235	236	DQ57	Data lane 57
Data lane 56	DQ56	237	238	GND	Ground
Masse	GND	239	240	DQS7_c	Data Strobe 7 -
Reserved	NC	241	242	DQS7_t	Data Strobe 7 +
Ground	GND	243	244	GND	Ground
Data lane 62	DQ62	245	246	DQ63	Data lane 63
Ground	GND	247	248	GND	Ground
Data lane 58	DQ58	249	250	DQ59	Data lane 59
Ground	GND	251	252	GND	Ground
SMBus Clock	SCL	253	254	SDA	SMBus Data
I ² C Power for SPD EEPROM	VCCSPD	255	256	SA0	SPD address 0
DRAM Activating Power	VPP	257	258	VTT	Termination voltage
DRAM Activating Power	VPP	259	260	SA1	SPD address 1

3.4 Internal Connectors

3.4.1 USB 2.0

The USB channels 7 to 14 are provided via four 2x5 pin connectors. They support USB2.0

You may note that the setting of USB keyboard or USB mouse support in the BIOS-setup is only necessary and advisable, if the OS offers no USB-support. BIOS-setup can be changed with a USB keyboard without enabling USB keyboard support. Running Windows with these features enabled may lead to significant performance or functionality limitations.

Each USB interface provides up to 500mA current and is protected by an electronically resettable fuse.

2x5pin connector:

Manufacturer	Description	Mating connector
FCI	75869-301LF	e.g. 71600-610LF

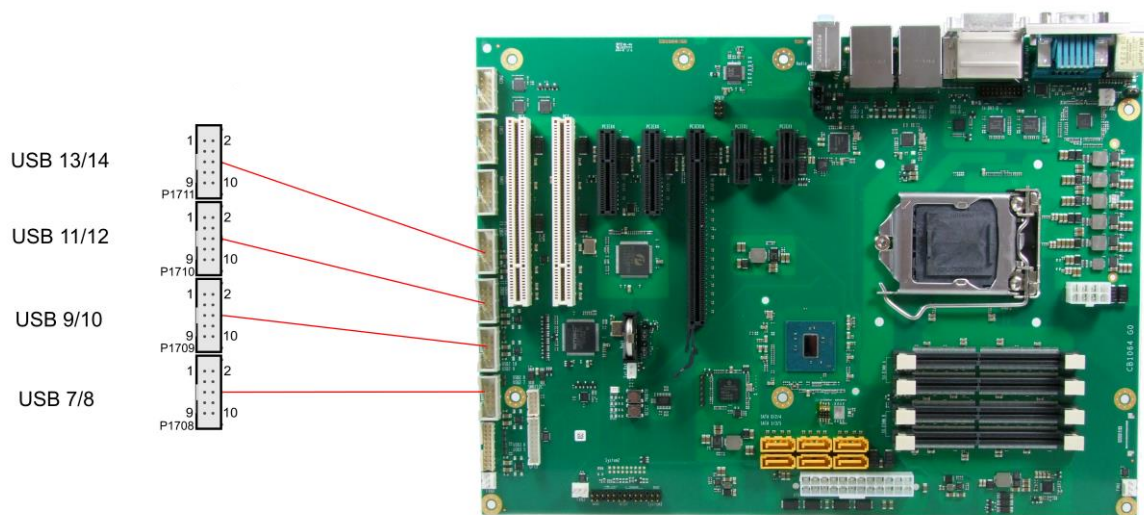

Pinout 2x5 pin connector USB x/y:

Description	Name	Pin	Name	Description
5 volt for USBx	VCC	1	2	VCC
minus channel USBx	USBx#	3	4	USBx#
plus channel USBx	USBx	5	6	USBx
ground	GND	7	8	GND
reserved	N/C	9	10	N/C

3.4.2 Serial ports COM2 to COM4

The three serial ports COM2 to COM4 are made available via a 2x5 pin connector each. Signals are RS232.

The port address and the interrupt are set via the BIOS setup.

2x5pin connector:

Manufacturer	Description	Mating connector
FCI	75869-301LF	e.g. 71600-610LF

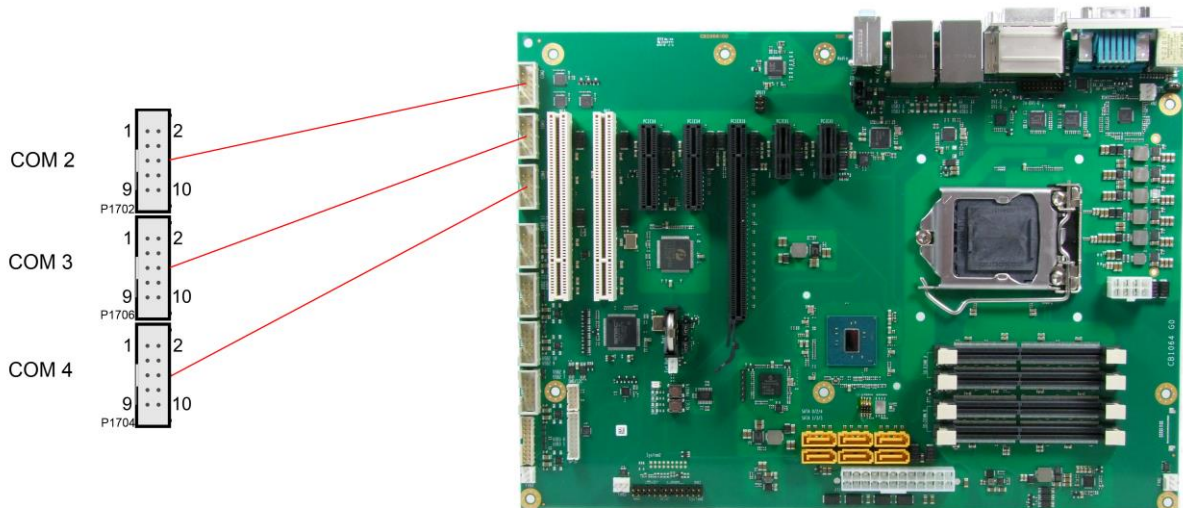

Pinout COM connector:

Description	Name	Pin	Name	Description	
data carrier detect	DCD	1	2	DSR	data set ready
receive data	RXD	3	4	RTS	request to send
transmit data	TXD	5	6	CTS	clear to send
data terminal ready	DTR	7	8	RI	ring indicator
ground	GND	9	10	VCC	5 volt supply

3.4.3 CD-In

In addition to the external TRS connectors mentioned above, the CB1064 offers an internal 4 pin connector (Foxconn HF1104E-P1), providing customers with even more possibilities to connect audio devices (analogue signals).

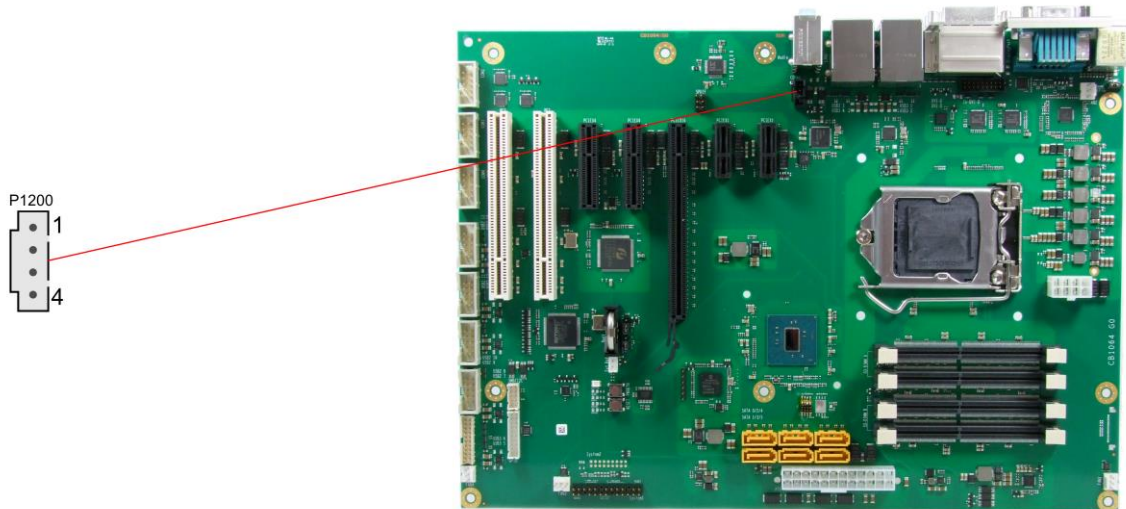

Pinout CD-in connector:

Pin	Name	Description
1	CD_L	CD left channel
2	CD_GND	CD ground
3	CD_GND	CD ground
4	CD_R	CD right channel

3.4.4 S/PDIF

For digital audio signals an SPDIF interface is available, which can be accessed using an internal 2x3 pin IDC socket connector with a spacing of 2,54mm.

Manufacturer	Description	Mating Connector
Samtec	TSW-103-07-S-D	e.g. (XXX)-103-01-T-D

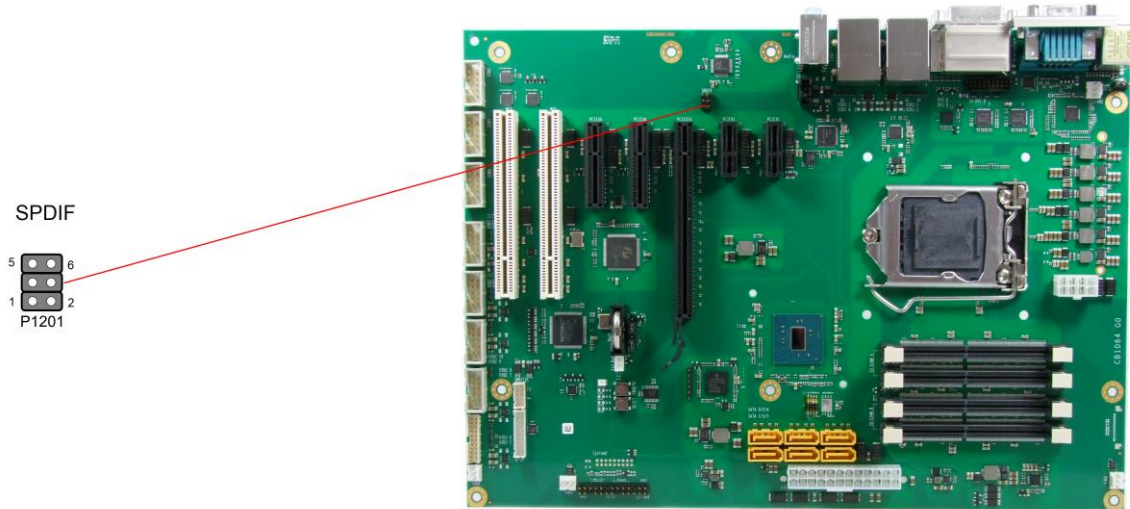



Pinout SPDIF connector:

Description	Name	Pin		Name	Description
ground	GND	1	2	SPDIFO	SPDIF out
3.3 volt supply	3,3V	3	4	VCC	5 volt supply
ground	GND	5	6	SPDIFI	SPDIF in

3.4.5 PCI Interfaces

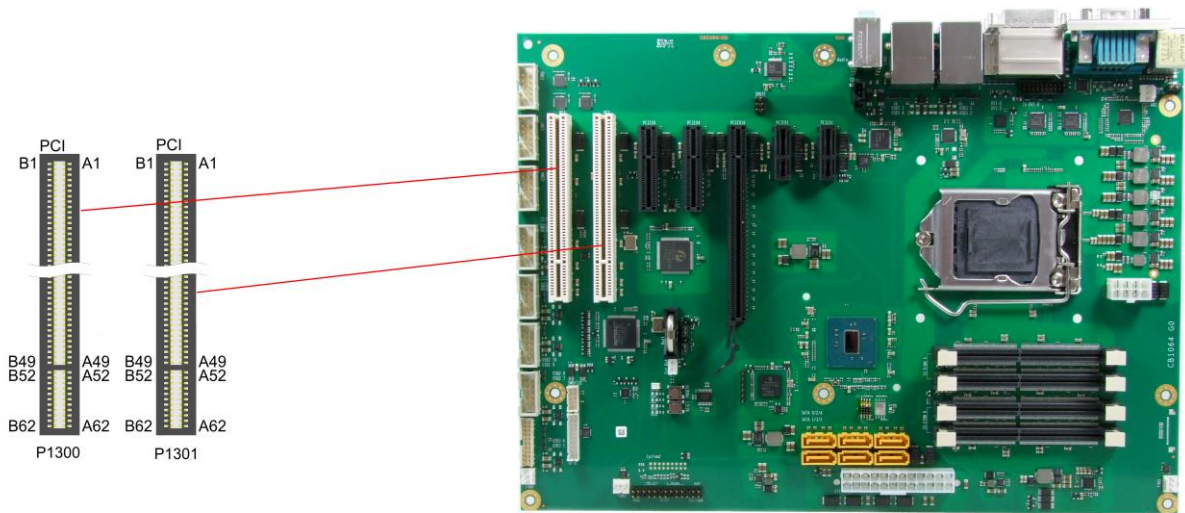
There are two standard PCI slots available on the CB1064.



 Notice	<p>Please note that due to the nature of the PCI bus some signals in the following table are different from one PCI slot to the other. This applies to the test signals (A4, B4), the interrupt signals (A6, A7, B7, B8), the clock signal (B16), the grant signal (A17), the request signal (B18), and the ID-select signal (A26).</p>
---	---

Pinout PCI slot:

Description	Name	Pin	Name	Description
test logic reset	TRST#	A1	B1	-12V
12 volt supply	12V	A2	B2	TCK
test mde select	TMS	A3	B3	GND
test data input	TDI	A4	B4	TDO
5 volt supply	VCC	A5	B5	VCC
interrupt A	INTA#	A6	B6	VCC
interrupt C	INTC#	A7	B7	INTB#
5 volt supply	VCC	A8	B8	INTD#
reserved	N/C	A9	B9	GND
5 volt supply	VCC	A10	B10	N/C
reserved	N/C	A11	B11	GND
ground	GND	A12	B12	GND
ground	GND	A13	B13	GND
3.3 volt supply	3.3VAux	A14	B14	N/C
PCI reset	PRST#	A15	B15	GND
5 volt supply	VCC	A16	B16	PCLK
grant PCI use	GNT#	A17	B17	GND
ground	GND	A18	B18	REQ#
power management event	PME#	A19	B19	VCC
address/data 30	AD30	A20	B20	AD31
3.3 volt supply	3.3V	A21	B21	AD29
address/data 28	AD28	A22	B22	GND
address/data 26	AD26	A23	B23	AD27
ground	GND	A24	B24	AD25

Description	Name	Pin		Name	Description
address/data 24	AD24	A25	B25	3.3V	3.3 volt supply
init device select	IDSEL	A26	B26	CBE3#	command, byte enable 3
3.3 volt supply	3.3V	A27	B27	AD23	address/data 23
address/data 22	AD22	A28	B28	GND	ground
address/data 20	AD20	A29	B29	AD21	address/data 21
ground	GND	A30	B30	AD19	address/data 19
address/data 18	AD18	A31	B31	3.3V	3.3 volt supply
address/data 16	AD16	A32	B32	AD17	address/data 17
3.3 volt supply	3.3V	A33	B33	CBE2#	command, byte enable 2
cycle frame	FRAME#	A34	B34	GND	ground
ground	GND	A35	B35	IRDY#	initiator ready
Target Ready	TRDY#	A36	B36	3.3V	3.3 volt supply
ground	GND	A37	B37	DEVSEL#	device select
stop request by target	STOP#	A38	B38	GND	ground
3.3 volt supply	3.3V	A39	B39	PLOCK#	lock bus
SMBus clock PCI	SMBCLK	A40	B40	PERR#	parity error
SMBus data PCI	SMBDAT	A41	B41	3.3V	3.3 volt supply
ground	GND	A42	B42	SERR#	system error
parity	PAR	A43	B43	3.3V	3.3 volt supply
address/data 15	AD15	A44	B44	CBE1#	command, byte enable 1
3.3 volt supply	3.3V	A45	B45	AD14	address/data 14
address/data 13	AD13	A46	B46	GND	ground
address/data 11	AD11	A47	B47	AD12	address/data 12
ground	GND	A48	B48	AD10	address/data 10
address/data 9	AD9	A49	B49	GND	ground
coded	N/C	A50	B50	N/C	coded
coded	N/C	A51	B51	N/C	coded
command, byte enable 0	CBEO#	A52	B52	AD8	address/data 8
3.3 volt supply	3.3V	A53	B53	AD7	address/data 7
address/data 6	AD6	A54	B54	3.3V	3.3 volt supply
address/data 4	AD4	A55	B55	AD5	address/data 5
ground	GND	A56	B56	AD3	address/data 3
address/data 2	AD2	A57	B57	GND	ground
address/data 0	AD0	A58	B58	AD1	address/data 1
5 volt supply	VCC	A59	B59	VCC	5 volt supply
reserved	N/C	A60	B60	VCC	5 volt supply
5 volt supply	VCC	A61	B61	VCC	5 volt supply
5 volt supply	VCC	A62	B62	VCC	5 volt supply

3.4.6 PCI-express Interfaces (x1)

The CB1064 board has two slots for PCIe-x1 expansion cards.

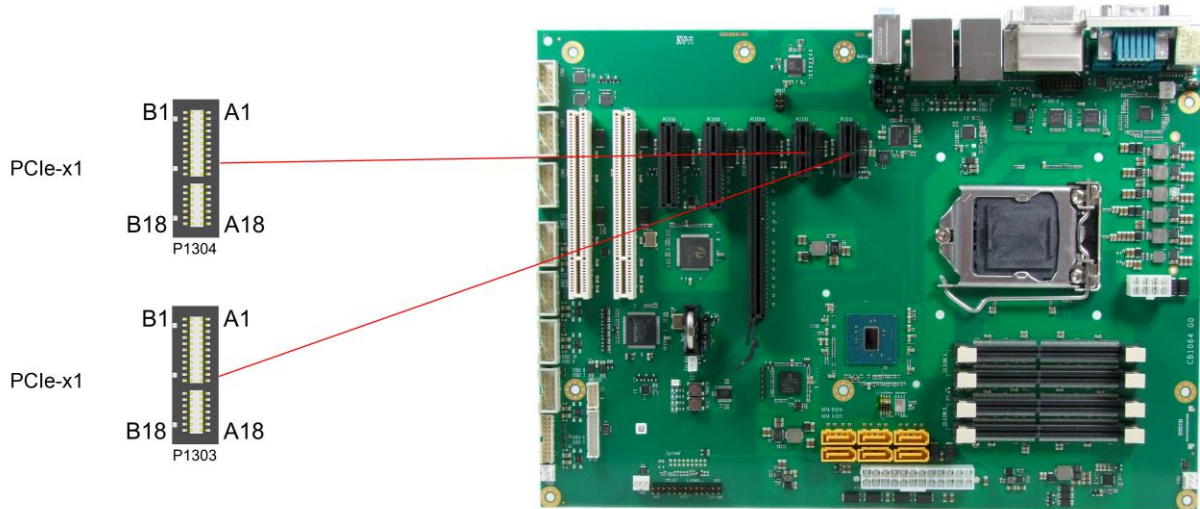

 <p>Notice</p>	<p>Please note that some signals in the following table are different from one PCIe slot to the other. This applies to the clock signals (A13, A14), the receive signals (A16, A17), and the transmit signals (B14, B15).</p>
--	---

Pinout PCI-express-x1 connector:

Description	Name	Pin	Name	Description
hot plug detect 1	PRSNT1#	A1	B1	12V
12 volt supply	12V	A2	B2	12V
12 volt supply	12V	A3	B3	N/C
ground	GND	A4	B4	GND
reserved	N/C	A5	B5	SMBCLK
reserved	N/C	A6	B6	SMBDAT
reserved	N/C	A7	B7	GND
reserved	N/C	A8	B8	3.3V
3.3 volt supply	3.3V	A9	B9	N/C
3.3 volt supply	3.3V	A10	B10	S3.3V
PCIe reset	PERST#	A11	B11	PEWAKE#
ground	GND	A12	B12	N/C
reference clock +	REFCLK	A13	B13	GND
reference clock -	REFCLK#	A14	B14	PET0
ground	GND	A15	B15	PET0#
receive lane 0 +	PER0	A16	B16	GND
receive lane 0 -	PER0#	A17	B17	PRSNT2#
ground	GND	A18	B18	GND

3.4.7 PCI-express Interfaces (x4)

The CB1064 has two slots for PCIe-x4 expansion cards. This slots also accomodates x1 expansion cards.

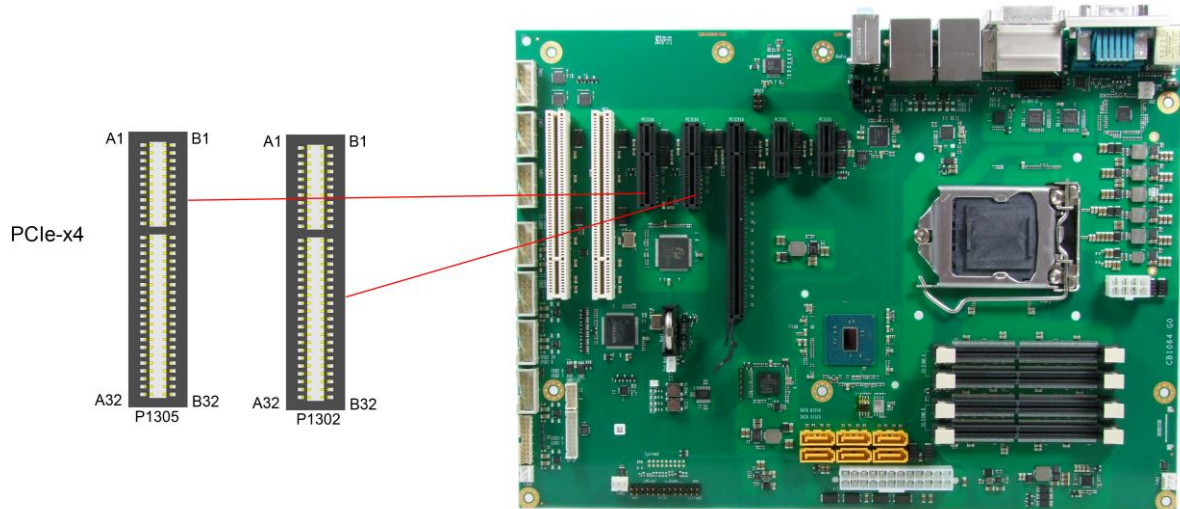

Pinout PCI-express-x1 connector:

Description	Name	Pin	Name	Description
hot plug detect 1	PRSNT1#	A1	B1	12V
12V supply	12V	A2	B2	12V
12V supply	12V	A3	B3	N/C
ground	GND	A4	B4	GND
reserved	N/C	A5	B5	SMBCLK
reserved	N/C	A6	B6	SMBDAT
reserved	N/C	A7	B7	GND
reserved	N/C	A8	B8	3,3V
3.3V supply	3,3V	A9	B9	N/C
3.3V supply	3,3V	A10	B10	S3,3V
PCIe reset	PERST#	A11	B11	PEWAKE#
ground	GND	A12	B12	N/C
reference clock +	REFCLK	A13	B13	GND
reference clock -	REFCLK#	A14	B14	PET0
ground	GND	A15	B15	PET0#
receive lane 0 +	PER0	A16	B16	GND
receive lane 0 -	PER0#	A17	B17	PRSNT2#
ground	GND	A18	B18	GND
reserved	N/C	A19	B19	PET1
ground	GND	A20	B20	PET1#
receive lane 1 +	PER1	A21	B21	GND
receive lane 1 -	PER1#	A22	B22	GND
ground	GND	A23	B23	PET2
ground	GND	A24	B24	PET2#
receive lane 2 +	PER2	A25	B25	GND
receive lane 2 -	PER2#	A26	B26	GND
ground	GND	A27	B27	PET3
ground	GND	A28	B28	PET3#
receive lane 3 +	PER3	A29	B29	GND

Description	Name	Pin		Name	Description
receive lane 3 -	PER3#	A30	B30	N/C	reserved
ground	GND	A31	B31	PRSNT2#	hot plug detect 2
reserved	N/C	A32	B32	GND	ground

3.4.8 PCI-express Interface (x16)

One slot for PCI-express-x16-cards makes the expansion options on the CB1064 complete. You can use this slot for PCIe-x16 graphic adapters. This slot also accommodates x1 or x4 expansion cards.

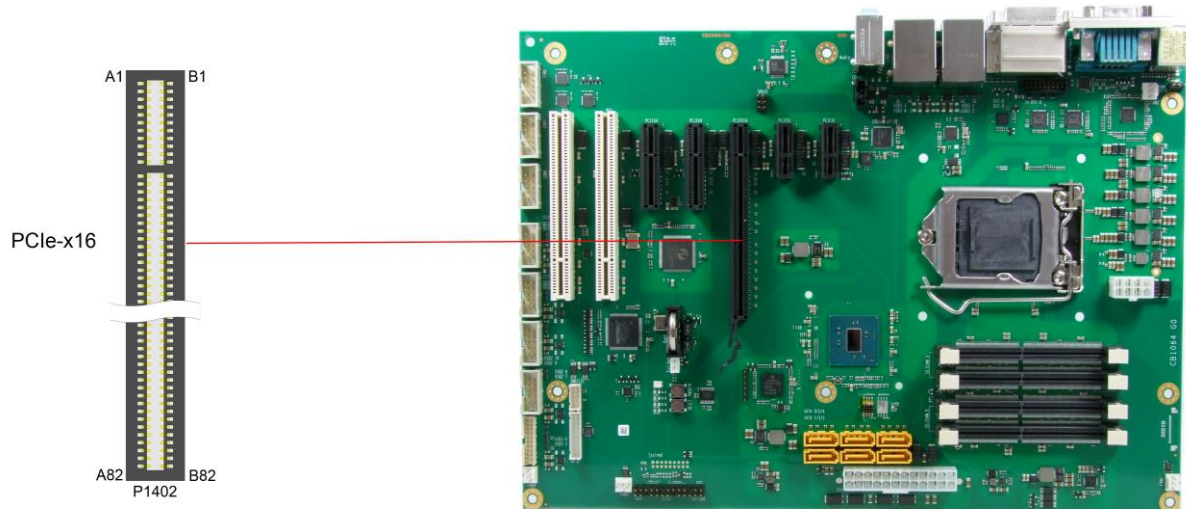

Pinout PCI-express-x16 connector:

Description	Name	Pin	Name	Description	
hot plug detect 1	PRSNT1#	A1	B1	12V	12 volt supply
12 volt supply	12V	A2	B2	12V	12 volt supply
12 volt supply	12V	A3	B3	N/C	reserved
ground	GND	A4	B4	GND	ground
reserved	N/C	A5	B5	SMBCLK	SMBus clock PCIe
reserved	N/C	A6	B6	SMBDAT	SMBus data PCIe
reserved	N/C	A7	B7	GND	ground
reserved	N/C	A8	B8	3.3V	3.3 volt supply
3.3 volt supply	3.3V	A9	B9	N/C	reserved
3.3 volt supply	3.3V	A10	B10	S3.3V	3.3V standby-supply
PCIe reset	PERST#	A11	B11	PEWAKE#	link reactivation
ground	GND	A12	B12	N/C	reserved
reference clock +	REFCLK	A13	B13	GND	ground
reference clock -	REFCLK#	A14	B14	PET0	transmit lane 0 +
ground	GND	A15	B15	PET0#	transmit lane 0 -
receive lane 0 +	PER0	A16	B16	GND	ground
receive lane 0 -	PER0#	A17	B17	PRSNT2#	hot plug detect 2
ground	GND	A18	B18	GND	ground
reserved	N/C	A19	B19	PET1	transmit lane 1 +
ground	GND	A20	B20	PET1#	transmit lane 1 -
receive lane 1 +	PER1	A21	B21	GND	ground
receive lane 1 -	PER1#	A22	B22	GND	ground
ground	GND	A23	B23	PET2	transmit lane 2 +
ground	GND	A24	B24	PET2#	transmit lane 2 -
receive lane 2 +	PER2	A25	B25	GND	ground
receive lane 2 -	PER2#	A26	B26	GND	ground
ground	GND	A27	B27	PET3	transmit lane 3 +
ground	GND	A28	B28	PET3#	transmit lane 3 -
receive lane 3 +	PER3	A29	B29	GND	ground

Description	Name	Pin		Name	Description
receive lane 3 -	PER3#	A30	B30	N/C	reserved
ground	GND	A31	B31	PRSNT2#	hot plug detect 2
reserved	N/C	A32	B32	GND	ground
reserved	N/C	A33	B33	PET4	transmit lane 4 +
ground	GND	A34	B34	PET4#	transmit lane 4 -
receive lane 4 +	PER4	A35	B35	GND	ground
receive lane 4 -	PER4#	A36	B36	GND	ground
ground	GND	A37	B37	PET5	transmit lane 5 +
ground	GND	A38	B38	PET5#	transmit lane 5 -
receive lane 5 +	PER5	A39	B39	GND	ground
receive lane 5 -	PER5#	A40	B40	GND	ground
ground	GND	A41	B41	PET6	transmit lane 6 +
ground	GND	A42	B42	PET6#	transmit lane 6 -
receive lane 6 +	PER6	A43	B43	GND	ground
receive lane 6 -	PER6#	A44	B44	GND	ground
ground	GND	A45	B45	PET7	transmit lane 7 +
ground	GND	A46	B46	PET7#	transmit lane 7 -
receive lane 7 +	PER7	A47	B47	GND	ground
receive lane 7 -	PER7#	A48	B48	PRSNT2#	hot plug detect 2
ground	GND	A49	B49	GND	ground
reserved	N/C	A50	B50	PET8	transmit lane 8 +
ground	GND	A51	B51	PET8#	transmit lane 8 -
receive lane 8 +	PER8	A52	B52	GND	ground
receive lane 8 -	PER8#	A53	B53	GND	ground
ground	GND	A54	B54	PET9	transmit lane 9 +
ground	GND	A55	B55	PET9#	transmit lane 9 -
receive lane 9 +	PER9	A56	B56	GND	ground
receive lane 9 -	PER9#	A57	B57	GND	ground
ground	GND	A58	B58	PET10	transmit lane 10 +
ground	GND	A59	B59	PET10#	transmit lane 10 -
receive lane 10 +	PER10	A60	B60	GND	ground
receive lane 10 -	PER10#	A61	B61	GND	ground
ground	GND	A62	B62	PET11	transmit lane 11 +
ground	GND	A63	B63	PET11#	transmit lane 11 -
receive lane 11 +	PER11	A64	B64	GND	ground
receive lane 11 -	PER11#	A65	B65	GND	ground
ground	GND	A66	B66	PET12	transmit lane 12 +
ground	GND	A67	B67	PET12#	transmit lane 12 -
receive lane 12 +	PER12	A68	B68	GND	ground
receive lane 12 -	PER12#	A69	B69	GND	ground
ground	GND	A70	B70	PET13	transmit lane 13 +
ground	GND	A71	B71	PET13#	transmit lane 13 -
receive lane 13+	PER13	A72	B72	GND	ground
receive lane 13-	PER13#	A73	B73	GND	ground
ground	GND	A74	B74	PET14	transmit lane 14 +
ground	GND	A75	B75	PET14#	transmit lane 14 -
receive lane 14 +	PER14	A76	B76	GND	ground
receive lane 14 -	PER14#	A77	B77	GND	ground
ground	GND	A78	B78	PET15	transmit lane 15 +
ground	GND	A79	B79	PET15#	transmit lane 15 -
receive lane 15 +	PER15	A80	B80	GND	ground
receive lane 15 -	PER15#	A81	B81	N/C	reserved
ground	GND	A82	B82	N/C	reserved

3.4.9 SMB/I2C

The CB1064 can communicate with external devices via the SMBus protocol or the I2C protocol. The signals for these protocols are available through a 2x5 pin connector. The SMBus signals are processed by the chipset, the I2C signals are processed by the SIO unit.

Manufacturer	Description	Mating Connector
JST	B10B-PHDSSLFSN	e.g. PHDR-10VS

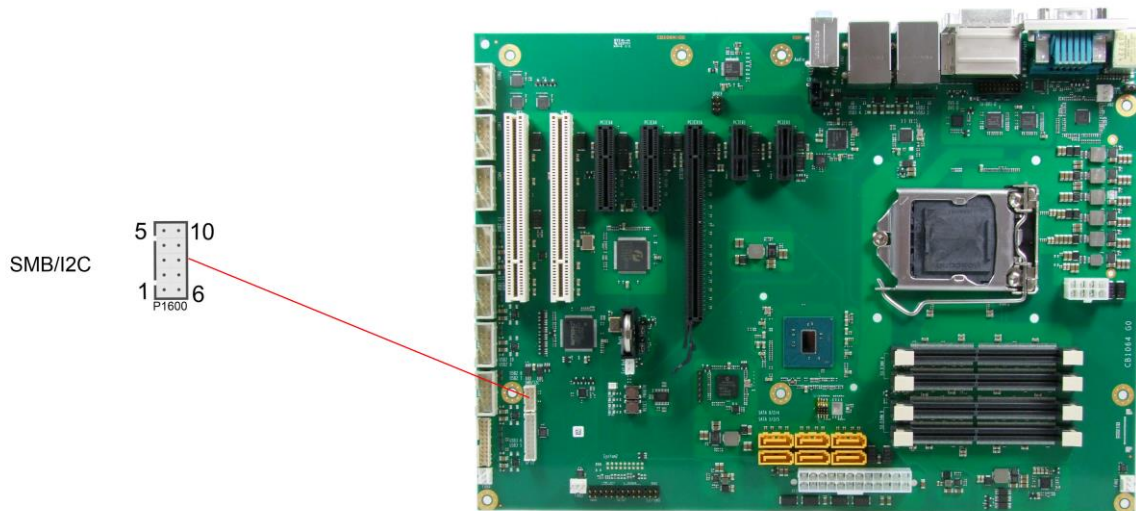

Pinout SMBus/I2C connector:

Description	Name	Pin	Name	Description
3.3 volt supply	3.3V	1	6	GND ground
SMBus clock	SMBCLK	2	7	SMBDAT SMBus data
SMBus alarm	SMBALRT#	3	8	SVCC standby supply 5V
I2C bus clock	I2CLK	4	9	I2DAT I2C bus data
5 volt supply	VCC	5	10	GND ground

3.4.10 GPIO

The General Purpose Input/Output interface is made available through a 2x10 pin connector. To make use of this interface the SIO unit must be programmed accordingly. Please refer to your distributor for information on available software support.

Manufacturer	Description	Mating Connector
JST	B20B-PHDSSLFSN	PHDR-20VS

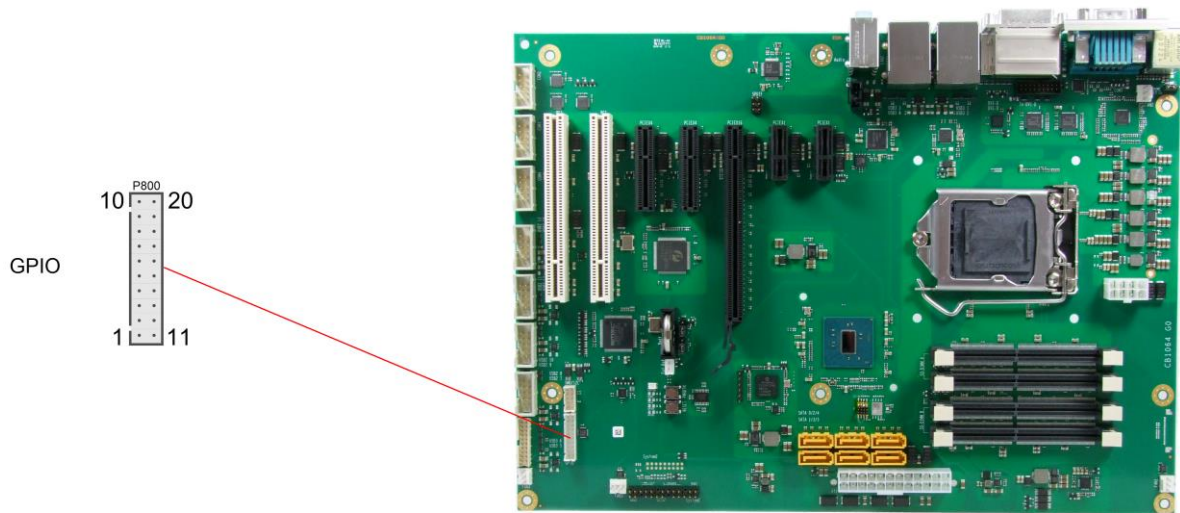

Description	Name	Pin		Name	Description
5 volt supply	VCC	1	11	VCC	5 volt supply
GP input/output 10	GPIO10	2	12	N/C	reserved
GP input/output 11	GPIO11	3	13	N/C	reserved
GP input/output 12	GPIO12	4	14	N/C	reserved
GP input/output 13	GPIO13	5	15	N/C	reserved
GP input/output 14	GPIO14	6	16	N/C	reserved
GP input/output 15	GPIO15	7	17	N/C	reserved
GP input/output 16	GPIO16	8	18	N/C	reserved
GP input/output 17	GPIO17	9	19	N/C	reserved
ground	GND	10	20	GND	ground

3.4.11 Fan Connectors

Four 3 pin connectors are available for attaching external 12V fans. All connectors except FAN4 can monitor fan speed. For this to work the fans must provide a corresponding speed signal.

Manufacturer	Description	Mating Connector
Molex	22-23-2031	e.g. 22-01-2037

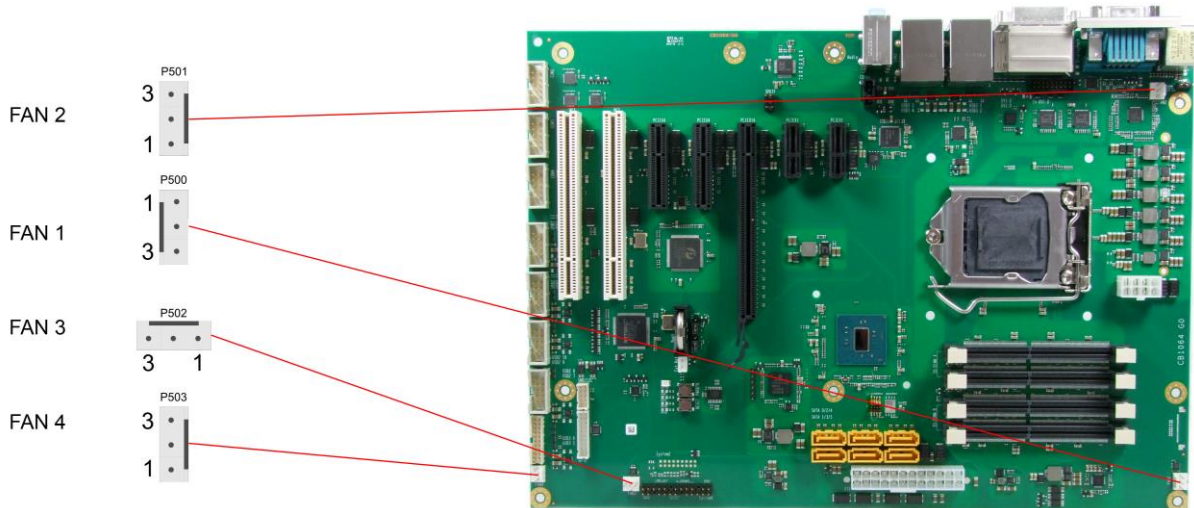

Pinout fan connector:

Pin	Name	Description
1	GND	ground
2	12V	12 volt supply regulated
3	TACHO	fan monitoring signal

 Notice	The FAN4 connector doesn't have pin 3 connected (N/C).
--	--

3.5 Jumper Settings

3.5.1 Clear CMOS

In case the board doesn't start up anymore and BIOS setup is inaccessible there is a "last resort": You can use the "Clear CMOS" jumpers to reset all CMOS settings to factory defaults. In order to do so you need to shut down the computer, change the jumper settings from normal (pins 1 & 2 short) to "Clear CMOS" (pins 2 & 3 short) first on jumper Clear CMOS 1 and then on jumper Clear CMOS 2, wait a few seconds, put the jumpers back into normal position and reboot.



Notice

In order to avoid an undefined system state it is essential to ensure that the shorting of jumper Clear CMOS 1 (J1800) takes place BEFORE and only combined with the shorting of jumper Clear CMOS 2 (J1801).

Furthermore please notice, that if you reset the CMOS this does not only bring all settings made in BIOS setup back to default values, it also clears the date and time information stored in CMOS. So don't forget that, after the Clear CMOS procedure, you will have to set the clock again.

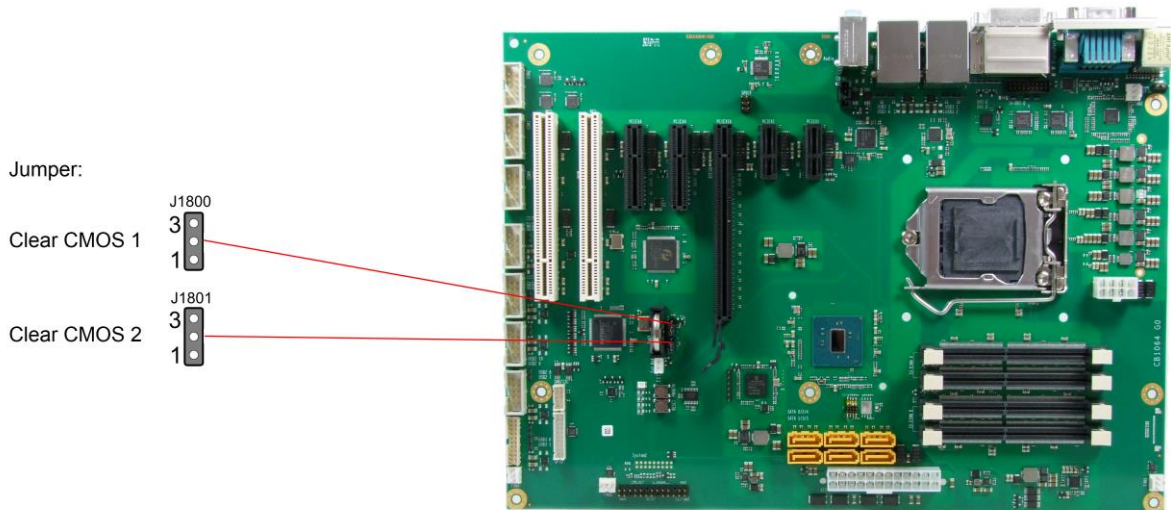

3.5.2 Jumper: Keyboard Power (KBPWR)

Power supply for keyboard and mouse can be provided in two different ways, either using normal power supply VCC or standby power supply SVCC. You can switch between the two by using the KBPWR jumper. For VCC you need to short pins 1 and 2, for SVCC please short pins 2 and 3.

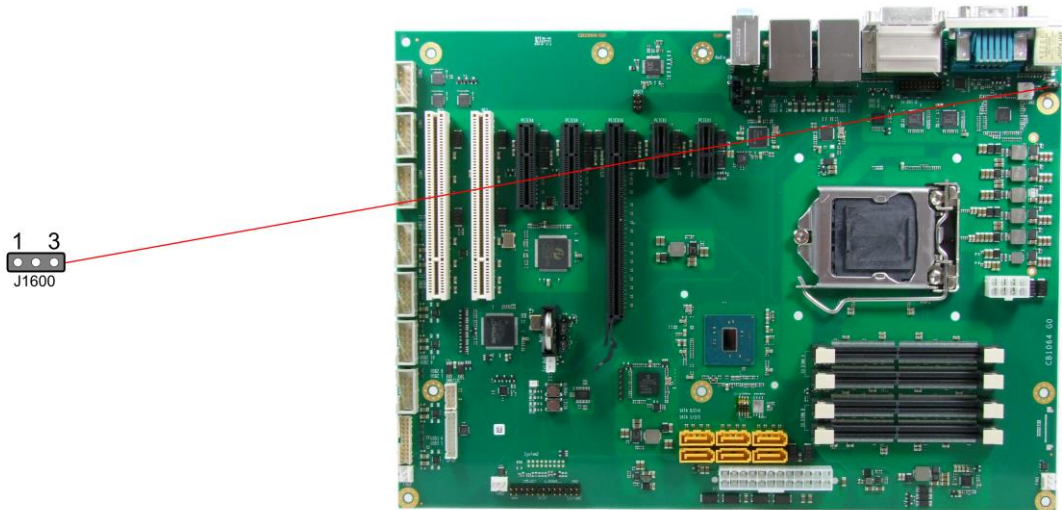

4 BIOS-Einstellungen

4.1 General Remarks

In each setup page, standard values for all setup entries can be loaded. Previously saved settings are loaded by pressing F2 and factory defaults are loaded with F3. Both F2 and F3, and also F4 ("Save & Exit") always affect the whole set of setup entries.

Setup entries starting with a „▶" sign represent submenus. Navigation between entries is done using the arrow keys on the keyboard, with the <Enter> key being used to select an entry, which either opens up a dialog box or opens a whole new submenu of setup entries.

Each setup entry has a short help text associated with it. This is displayed in the upper right hand corner of the screen.



Hinweis

Hinweis zur Setup-Dokumentation

Das BIOS wird regelmäßig weiterentwickelt, so dass die verfügbaren Setup-Optionen sich jederzeit und ohne gesonderte Mitteilung ändern können. Dadurch kann es zu Abweichungen kommen zwischen den tatsächlich vorhandenen Optionen und denen, die nachfolgend beschrieben werden. Zu beachten ist außerdem, dass die in den Setup-Menüs im Folgenden gezeigten Einstellungen nicht notwendigerweise die empfohlenen oder die Default-Einstellungen sind. Welche Einstellungen gewählt werden müssen, hängt jeweils vom Anwendungsszenario ab, in dem das Board betrieben wird.

4.2 Main

Aptio Setup Utility - Copyright (C) 2017 American Megatrends, Inc.
 MAIN Advanced Chipset Security Boot Save & Exit

<pre> Board Information Board CB1064 Revision 2 Bios Version 1.01 Processor Information Name SkyLake DT Type Intel(R) Core(TM) i5-6400 CPU @ 2.70GHz Speed 2700 MHz ID 0x506E3 Stepping R0/S0/N0 Number of Processors 4Core(s) / 4 Thread(s) Microcode Revision A6 GT Info GT2 (0x1912) IGFX VBIOS Version 1049 IGFX GOP Version N/A Memory RC Version 2.0.0.6 Total Memory 4096 MB Memory Frequency 2133 MHz System Date [Wed 05/07/2017] System Time [13:25:06] </pre>	<p>Set the Date. Use Tab to switch between Data elements.</p> <hr/> <pre> ←: Select Screen ↑↓: Select Item Enter: Select +/-: Change Opt. F1: General Help F2: Previous Values F3: Optimized Defaults F4: Save & Exit ESC: Exit </pre>
--	--

Version 2.18.1263. Copyright (C) 2017 American Megatrends, Inc.

- ✓ **Board**
Options: none
- ✓ **Revision**
Options: none
- ✓ **Bios Version**
Options: none
- ✓ **Processor Information**
Options: none
- ✓ **Name**
Options: none
- ✓ **Type**
Options: none
- ✓ **Speed**
Options: none
- ✓ **ID**
Options: none
- ✓ **Stepping**
Options: none
- ✓ **Number of Processors**
Options: none
- ✓ **Microcode Revision**
Options: none

- ✓ **GT Info**
Options: none
- ✓ **IGFX VBIOS Version**
Options: none
- ✓ **IGFX GOP Version**
Options: none
- ✓ **Memory RC Version**
Options: none
- ✓ **Total Memory**
Options: none
- ✓ **Memory Frequency**
Options: none
- ✓ **System Date**
Options: The system date can be adjusted here.
- ✓ **System Time**
Options: The system time can be adjusted here.

4.3 Advanced

Aptio Setup Utility - Copyright (C) 2017 American Megatrends, Inc.
 ADVANCED

<pre> Power-Supply Type [ATX] SoftOff on Overheat [Disabled] ▶ Platform Misc Configuration ▶ CPU Configuration ▶ Intel(R) I210 Gigabit Network Connection - 00:01:05:2C:0B:3F ▶ Intel(R) Ethernet Connection (2) I219-LM - 00:01:05:2C:0B:3E ▶ Driver Health ▶ Trusted Computing ▶ ACPI Settings ▶ SCH3114 Super IO Configuration ▶ Hardware Monitor ▶ Serial Port Console Redirection ▶ PCI Subsystem Settings ▶ Network Stack Configuration ▶ Power Controller Options ▶ CSM Configuration ▶ NVMe Configuration ▶ USB Configuration ▶ SATA and RST Configuration ▶ AMT Configuration </pre>	<p>Trusted Computing Settings</p> <hr/> <pre> ←→: Select Screen ↑↓: Select Item Enter: Select +/-: Change Opt. F1: General Help F2: Previous Values F3: Optimized Defaults F4: Save & Exit ESC: Exit </pre>
--	---

Version 2.18.1263. Copyright (C) 2017 American Megatrends, Inc.

- ✓ **Power-Supply Type**
Options: ATX / AT
- ✓ **SoftOff on Overheat**
Options: Disabled / Enabled
- ✓ **Platform Misc Configuration**
Sub menu: see "Platform Misc Configuration Configuration" (page 56)
- ✓ **CPU Configuration**
Sub menu: see "CPU Configuration" (page 60)
- ✓ **Intel(R) I210 Gigabit Network Connection**
Sub menu: see "Intel(R) I210 Gigabit Network Connection" (page 64)
- ✓ **Intel(R) Ethernet Connection (2) I219-LM**
Sub menu: see "Intel(R) Ethernet Connection I219-LM" (page 66)
- ✓ **Driver Health**
Sub menu: see "Driver Health" (page 67)
- ✓ **Trusted Computing**
Sub menu: see "Trusted Computing" (page 70)
- ✓ **ACPI Settings**
Sub menu: see "ACPI Settings" (page 71)
- ✓ **SCH3114 Super IO Configuration**
Sub menu: see "SCH3114 Super IO Configuration" (page 72)
- ✓ **H/W Monitor**
Sub menu: see "H/W Monitor" (page 74)

- ✓ **Serial Port Console Redirection**
Sub menu: see "Serial Port Console Redirection" (page 76)
- ✓ **PCI Subsystem Settings**
Sub menu: see "PCI Subsystem Settings" (page 79)
- ✓ **Network Stack Configuration**
Sub menu: see "Network Stack Configuration" (page 81)
- ✓ **Power Controller Options**
Sub menu: see "Power Controller Options" (page 82)
- ✓ **CSM Configuration**
Sub menu: see "Compatibility Support Module Configuration" (page 84)
- ✓ **NVMe Configuration**
Sub menu: see "NVMe Controller and Drive Information" (page 85)
- ✓ **USB Configuration**
Sub menu: see "USB Configuration" (page 86)
- ✓ **SATA and RST Configuration**
Sub menu: see "SATA and RST Configuration" (page 87)
- ✓ **AMT Configuration**
Sub menu: see "AMT Configuration" (page 91)

4.3.1 Platform Misc Configuration Configuration

Aptio Setup Utility - Copyright (C) 2017 American Megatrends, Inc.
Advanced

Platform Misc Configuration		PTID Support will be loaded if enabled.
PTID Support	[Enabled]	
PECI Access Method	[Direct I/O]	
Native PCIE Enable	[Enabled]	
Native ASPM	[Disabled]	
BDAT ACPI Table Support	[Disabled]	
Wake system from S5	[Enabled]	
Wake up hour	0	
Wake up minute	0	
Wake up second	0	
ACPI Debug	[Enabled]	
Acpi Memory Buffer Address	N/A	→: Select Screen
Low Power S0 Idle Capability	[Enabled]	↑↓: Select Item
10sec Power Button OVR	[Disabled]	Enter: Select
EC Notification	[Enabled]	+/-: Change Opt.
EC CS Debug Light	[Disabled]	F1: General Help
EC Low Power Mode	[Disabled]	F2: Previous Values
Sensor Standby	[Disabled]	F3: Optimized Defaults
CS PL1 Limit	[Enabled]	F4: Save & Exit
CS PL1 Value	4500	ESC: Exit
▶ PEP Constraints Configuration		
Lpit Recidency Counter	[SLP S0]	

Version 2.18.1263. Copyright (C) 2017 American Megatrends, Inc.

- ✓ **PTID Support**
Options: Disabled / Enabled
- ✓ **PECI Access Method**
Options: Direct I/O / ACPI
- ✓ **Native PCIE Enable**
Options: Disabled / Enabled
- ✓ **Native ASPM**
Options: Disabled / Enabled
- ✓ **BDAT ACPI Table Support**
Options: Disabled / Enabled
- ✓ **Wake system from S5**
Options: Disabled / Enabled
- ✓ **Wake up hour**
Options: 0..23
- ✓ **Wake up minute**
Options: 0..59
- ✓ **Wake up second**
Options: 0..59
- ✓ **ACPI Debug**
Options: Disabled / Enabled
- ✓ **ACPI Memory Buffer Address**
Options: none

- ✓ **ACPI Low Power S0 Idle Capability**
Options: Disabled / Enabled
- ✓ **10sec Power Button OVR**
Options: Disabled / Enabled
- ✓ **EC Notification**
Options: Disabled / Enabled
- ✓ **EC CS Debug Light**
Options: Disabled / Enabled
- ✓ **EC Low Power Mode**
Options: Disabled / Enabled
- ✓ **Sensor Standby**
Options: Disabled / Enabled
- ✓ **CS PL1 Limit**
Options: Disabled / Enabled
- ✓ **PEP Constraints Configuration**
Sub menu: see "PEP Constraints Configuration" (page 58)
- ✓ **Lpit Recidency Counter**
Options: SLP S0 / C10
- ✓ **PCI Delay Optimization**
Options: Disabled / Enabled
- ✓ **ZpODD Support**
Options: Disabled / Enabled

4.3.1.1 PEP Constraints Configuration

Aptio Setup Utility - Copyright (C) 2017 American Megatrends, Inc.
Advanced

<pre> PEP Constraints Configuration PEP CPU [Enabled] PEP Graphics [Disabled] PEP ISP [Disabled] PEP SATA [Storage Controller] PEP UART [Enabled] PEP I2C0 [Enabled] PEP I2C1 [Enabled] PEP I2C2 [Enabled] PEP I2C3 [Enabled] PEP I2C4 [Enabled] PEP I2C5 [Enabled] PEP SPI [Enabled] PEP XHCI [Enabled] PEP Audio [Enabled] PEP EMMC [Enabled] PEP SDXC [Enabled] </pre>	<pre> Add CPU in PEP mitigation list ----- ←: Select Screen ↑: Select Item Enter: Select +/-: Change Opt. F1: General Help F2: Previous Values F3: Optimized Defaults F4: Save & Exit ESC: Exit </pre>
--	--

Version 2.18.1263. Copyright (C) 2017 American Megatrends, Inc.

- ✓ **SPEP CPU**
Options: Disabled / Enabled
- ✓ **PEP Graphics**
Options: Disabled / Enabled
- ✓ **PEP ISP**
Options: Disabled / Enabled
- ✓ **PEP SATA**
Options: No Constraint / Storage Controller
- ✓ **PEP UART**
Options: Disabled / Enabled
- ✓ **PEP I2C0**
Options: Disabled / Enabled
- ✓ **PEP I2C1**
Options: Disabled / Enabled
- ✓ **PEP I2C2**
Options: Disabled / Enabled
- ✓ **PEP I2C3**
Options: Disabled / Enabled
- ✓ **PEP I2C4**
Options: Disabled / Enabled
- ✓ **PEP I2C5**
Options: Disabled / Enabled

- ✓ **PEP SPI**
Options: Disabled / Enabled
- ✓ **PEP XHCI**
Options: Disabled / Enabled
- ✓ **PEP Audio**
Options: Disabled / Enabled
- ✓ **PEP EMMC**
Options: Disabled / Enabled
- ✓ **PEP SDXC**
Options: Disabled / Enabled

4.3.2 CPU Configuration

Aptio Setup Utility - Copyright (C) 2017 American Megatrends, Inc.
Advanced

CPU Configuration		▲ Enable/Disable Software Guard Extensions (SGX)
Type	Intel(R) Core(TM) i5-6400 CPU @ 2.70GHz	↩: Select Screen ↑↓: Select Item Enter: Select +/-: Change Opt. F1: General Help F2: Previous Values F3: Optimized Defaults F4: Save & Exit ESC: Exit
ID	0x506E3	
Speed	2700 MHz	
L1 Data Cache	32 KB x 4	
L1 Instruction Cache	32 KB x 4	
L2 Cache	256 KB x 4	
L3 Cache	6 MB	
L4 Cache	N/A	
VMX	Supported	
SMX/TXT	Not Supported	
SW Guard Extensions (SGX)	[Enabled]	
Select Owner EPOCH input type	[No Change in Owner EPOCHs]	
PRMRR Size	[128MB]	
CPU Flex Ratio Override	[Disabled]	
CPU Flex Ratio Settings	27	
Hardware Prefetcher	[Enabled]	
Adjacent Cache Line Prefetch	[Enabled]	
Intel (VMX) Virtualization Technology	[Enabled]	
PECI	[Enabled]	

Version 2.18.1263. Copyright (C) 2017 American Megatrends, Inc.

- ✓ **Type**
Options: none
- ✓ **ID**
Options: none
- ✓ **Speed**
Options: none
- ✓ **L1 Data Cache**
Options: none
- ✓ **L1 Instruction Cache**
Options: none
- ✓ **L2 Cache**
Options: none
- ✓ **L3 Cache**
Options: none
- ✓ **L4 Cache**
Options: none
- ✓ **VMX**
Options: none
- ✓ **SMX/TXT**
Options: none
- ✓ **SW Guard Extensions (SGX)**
Options: Software Controlled / Enabled / Disabled

-
- ✓ **Select Owner EPOCH input type**
Options: No Change in Owner EPOCHs / Change to New Random Owner EPOCHs / Manual User Defined Owner EPOCHs

 - ✓ **PRMRR Size**
Options: INVALID PRMRR / 32MB / 64MB / 128MB

 - ✓ **CPU Flex Ratio Override**
Options: Disabled / Enabled

 - ✓ **CPU Flex Ratio Settings**
Options: 0..63

 - ✓ **Hardware Prefetcher**
Options: Disabled / Enabled

 - ✓ **Adjacent Cache Line Prefetch**
Options: Disabled / Enabled

 - ✓ **Intel Virtualization Technology**
Options: Enabled / Disabled

 - ✓ **PECI**
Options: Enabled / Disabled

 - ✓ **Active Processor Cores**
Options: All

 - ✓ **Hyper-threading**
Options: Enabled / Disabled

 - ✓ **CPU AES**
Options: Disabled / Enabled

 - ✓ **CPU - Power Management Control**
Sub menu: see "CPU - Power Management Control" (page 62)

4.3.2.1 CPU - Power Management Control

Aptio Setup Utility - Copyright (C) 2017 American Megatrends, Inc.
Advanced

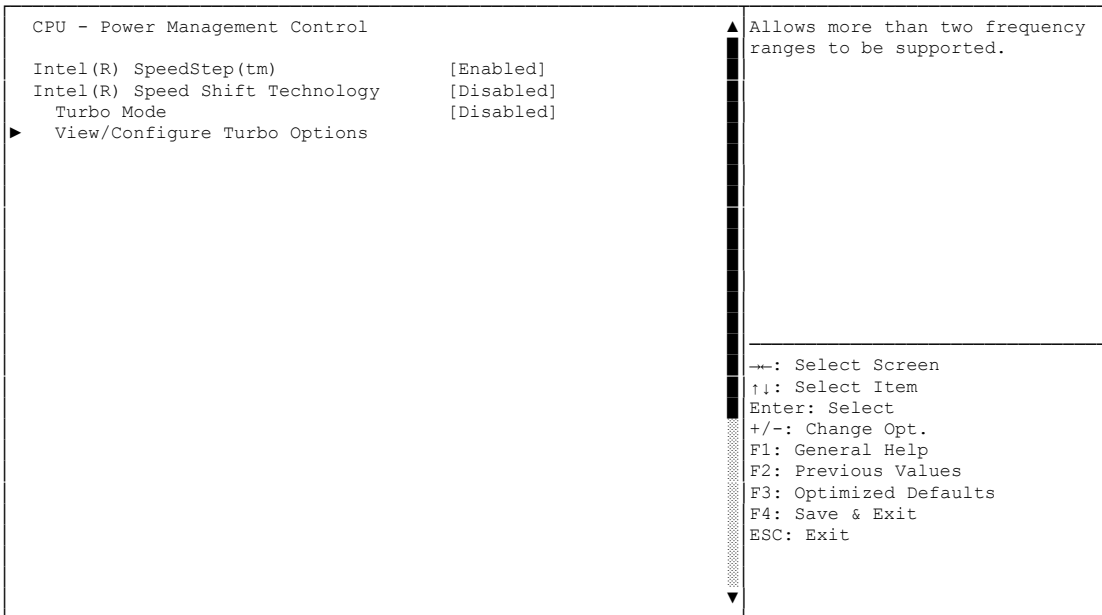

Version 2.18.1263. Copyright (C) 2017 American Megatrends, Inc.

- ✓ **Intel(R) SpeedStep(tm)**
Options: Disabled / Enabled
- ✓ **Intel(R) Speed Shift Technology**
Options: Disabled / Enabled
- ✓ **Turbo Mode**
Options: Disabled / Enabled
- ✓ **View/Configure Turbo Options**
Sub menu: see "View/Configure Turbo Options" (page 63)

4.3.2.1.1 View/Configure Turbo Options

Aptio Setup Utility - Copyright (C) 2017 American Megatrends, Inc.
Advanced

<p>Current Turbo Settings</p> <p>Max Turbo Power Limit 4095.875 Min Turbo Power Limit 0.0 Package TDP Limit 65.0 Power Limit 1 65.0 Power Limit 2 0.0 1-core Turbo Ratio 33 2-core Turbo Ratio 33 3-core Turbo Ratio 32 4-core Turbo Ratio 31</p> <p>Energy Efficient P-state [Enabled] Package Power Limit MSR Lock [Disabled] Energy Efficient Turbo [Disabled]</p>	<p>Enable/Disable Energy Efficient P-state feature. When set to 0, will disable access to ENERGY_PERFORMANCE_BIAS MSR and CPUID Function 6 ECX[3] will read 0 indicating no support for Energy Efficient policy setting. When set to 1 will enable access to ENERGY_PERFORMANCE_BIAS MSR</p> <hr/> <p>←: Select Screen ↑: Select Item Enter: Select +/-: Change Opt. F1: General Help F2: Previous Values F3: Optimized Defaults F4: Save & Exit ESC: Exit</p>
---	--

Version 2.18.1263. Copyright (C) 2017 American Megatrends, Inc.

- ✓ **Max Turbo Power Limit**
Options: none
- ✓ **Min Turbo Power Limit**
Options: none
- ✓ **Package TDP Limit**
Options: none
- ✓ **Power Limit 1**
Options: none
- ✓ **Power Limit 2**
Options: none
- ✓ **x-core Turbo Ratio**
Options: none
- ✓ **Energy Efficient P-state**
Options: Enabled / Disabled
- ✓ **Package Power Limit MSR Lock**
Options: Disabled / Enabled
- ✓ **Energy Efficient Turbo**
Options: Enabled / Disabled

4.3.3 Intel(R) I210 Gigabit Network Connection

Aptio Setup Utility - Copyright (C) 2017 American Megatrends, Inc.
Advanced

<p>▶ NIC Configuration</p> <p>Blink LEDs 0</p> <p>UEFI Driver Intel(R) PRO/1000 7.3.20 PCI-E</p> <p>Adapter PBA 000300-000</p> <p>Device Name Intel(R) I210 Gigabit Network Connection</p> <p>Chip Type Intel i210</p> <p>PCI Device ID 1533</p> <p>PCI Address 05:00:00</p> <p>Link Status [Disconnected]</p> <p>MAC Address 00:01:05:2C:0B:3F</p> <p>Virtual MAC Address 00:00:00:00:00:00</p>		<p>Click to configure the network device port.</p> <hr/> <p>←: Select Screen ↑↓: Select Item Enter: Select +/-: Change Opt. F1: General Help F2: Previous Values F3: Optimized Defaults F4: Save & Exit ESC: Exit</p>
--	--	---

Version 2.18.1263. Copyright (C) 2017 American Megatrends, Inc.

- ✓ **NIC Configuration**
Sub menu: see "NIC Configuration" (page 65)
- ✓ **Blink LEDs**
Options: none
- ✓ **UEFI Driver**
Options: none
- ✓ **Adapter PBA**
Options: none
- ✓ **Device Name**
Options: none
- ✓ **Chip Type**
Options: none
- ✓ **PCI Device ID**
Options: none
- ✓ **PCI Address**
Options: none
- ✓ **Link Status**
Options: none
- ✓ **MAC Address**
Options: none
- ✓ **Virtual MAC Address**
Options: none

4.3.3.1 NIC Configuration

Aptio Setup Utility - Copyright (C) 2017 American Megatrends, Inc.
Advanced

Link Speed Wake On LAN	[Auto Neg] [Enabled]	Specifies the port speed used for the selected boot protocol.
		←: Select Screen ↑: Select Item Enter: Select +/-: Change Opt. F1: General Help F2: Previous Values F3: Optimized Defaults F4: Save & Exit ESC: Exit

Version 2.18.1263. Copyright (C) 2017 American Megatrends, Inc.

- ✓ **Link Speed**
Options: Auto Negotiated / 10Mbps Half / 10Mbps full / 100Mbps Half / 100Mbps Full
- ✓ **Wake On LAN**
Options: Enabled / Disabled

4.3.4 Intel(R) Ethernet Connection I219-LM

Aptio Setup Utility - Copyright (C) 2017 American Megatrends, Inc.
Advanced

<pre> PORT CONFIGURATION MENU ▶ NIC Configuration Blink LEDs 0 PORT CONFIGURATION INFORMATION UEFI Driver: Intel(R) Gigabit 0.0.166 Adapter PBA: FFFFFFF-0FF Chip Type Intel PCH SPT PCI Device ID 15B7 PCI Address 00:1F:06 Link Status [Disconnected] MAC Address 00:01:05:2C:0B:3E </pre>	<p>Click to configure the network device port.</p> <hr/> <pre> ←: Select Screen ↑↓: Select Item Enter: Select +/-: Change Opt. F1: General Help F2: Previous Values F3: Optimized Defaults F4: Save & Exit ESC: Exit </pre>
---	---

Version 2.18.1263. Copyright (C) 2017 American Megatrends, Inc.

- ✓ **NIC Configuration**
Sub menu: see "NIC Configuration" (page 65)
- ✓ **Blink LEDs**
Options: none
- ✓ **UEFI Driver**
Options: none
- ✓ **Adapter PBA**
Options: none
- ✓ **Chip Type**
Options: none
- ✓ **PCI Device ID**
Options: none
- ✓ **PCI Address**
Options: none
- ✓ **Link Status**
Options: none
- ✓ **MAC Address**
Options: none

4.3.5 Driver Health

Aptio Setup Utility - Copyright (C) 2017 American Megatrends, Inc.
Advanced

▶ Intel(R) Gigabit 0.0.16	Healthy	Provides Health Status for the Drivers/Controllers
▶ Intel(R) PRO/1000 7.3.20 PCI-E	Healthy	
		→: Select Screen ↑↓: Select Item Enter: Select +/-: Change Opt. F1: General Help F2: Previous Values F3: Optimized Defaults F4: Save & Exit ESC: Exit

Version 2.18.1263. Copyright (C) 2017 American Megatrends, Inc.

- ✓ **Intel(R) Gigabit 0.0.16**
Sub menu: see "Intel(R) Gigabit 0.0.16" (page 67)
- ✓ **Intel(R) PRO/1000 7.3.20 PCI-E**
Sub menu: see "Intel(R) PRO/1000 7.3.20" (page 69)

4.3.5.1 Intel(R) Gigabit 0.0.16

Aptio Setup Utility - Copyright (C) 2017 American Megatrends, Inc.
Advanced

<p>Controller 899de498 Child 0</p>	<p>Healthy</p>	<p>Provides Health Status for the Drivers/Controllers</p> <hr/> <p>←: Select Screen ↑: Select Item Enter: Select +/-: Change Opt. F1: General Help F2: Previous Values F3: Optimized Defaults F4: Save & Exit ESC: Exit</p>
------------------------------------	----------------	---

Version 2.18.1263. Copyright (C) 2017 American Megatrends, Inc.

- ✓ **Controller 899dd918 Child 0 Healthy**
Options: none

4.3.5.2 Intel(R) PRO/1000 7.3.20

Aptio Setup Utility - Copyright (C) 2017 American Megatrends, Inc.
Advanced

<pre>Controller 899de498 Child 0 Healthy Intel(R) I210 Gigabit Network Connection Healthy</pre>	<pre>Provides Health Status for the Drivers/Controllers ----- ←: Select Screen ↑: Select Item Enter: Select +/-: Change Opt. F1: General Help F2: Previous Values F3: Optimized Defaults F4: Save & Exit ESC: Exit</pre>
---	---

Version 2.18.1263. Copyright (C) 2017 American Megatrends, Inc.

- ✓ **Controller 899de498 Child 0 Healthy**
Options: none
- ✓ **Intel(R) I210 Gigabit Network Connection**
Options: none

4.3.6 Trusted Computing

Aptio Setup Utility - Copyright (C) 2017 American Megatrends, Inc.
Advanced

<pre>Configuration Security Device Support [Enable] NO Security Device Found</pre>	<pre>Enables or Disables BIOS support for security device. O.S. will not show Security Device. TCG EFI protocol and INT1A interface will not be available. ----- ←: Select Screen ↑↓: Select Item Enter: Select +/-: Change Opt. F1: General Help F2: Previous Values F3: Optimized Defaults F4: Save & Exit ESC: Exit</pre>
---	---

Version 2.18.1263. Copyright (C) 2017 American Megatrends, Inc.

- ✓ **Security Device Support**
Options: Enable / Disable

4.3.7 ACPI Settings

Aptio Setup Utility - Copyright (C) 2017 American Megatrends, Inc.
Advanced

ACPI Settings		Enables or Disables BIOS ACPI Auto Configuration.
Enable ACPI Auto Configuration	[Disabled]	
Enable Hibernation	[Enabled]	
ACPI Sleep State	[S1 (CPU Stop Clock)]	
Lock Legacy Resources	[Disabled]	
		←: Select Screen ↑↓: Select Item Enter: Select +/-: Change Opt. F1: General Help F2: Previous Values F3: Optimized Defaults F4: Save & Exit ESC: Exit

Version 2.18.1263. Copyright (C) 2017 American Megatrends, Inc.

- ✓ **Enable ACPI Auto Configuration**
Options: Enabled / Disabled
- ✓ **Enable Hibernation**
Options: Enabled / Disabled
- ✓ **ACPI Sleep State**
Options: Suspend Disabled / S1 (CPU Stop Clock)
- ✓ **Lock Legacy Resources**
Options: Enabled / Disabled

4.3.8 SCH3114 Super IO Configuration

Aptio Setup Utility - Copyright (C) 2017 American Megatrends, Inc.
Advanced

<pre> SCH3114 Super IO Configuration Super IO Chip SCH3114 ▶ Serial Port 1 Configuration ▶ Serial Port 2 Configuration ▶ Serial Port 3 Configuration ▶ Serial Port 4 Configuration </pre>	<pre> Set Parameters of Serial Port 1 (COMA) ----- ←: Select Screen ↑↓: Select Item Enter: Select +/-: Change Opt. F1: General Help F2: Previous Values F3: Optimized Defaults F4: Save & Exit ESC: Exit </pre>
--	--

Version 2.18.1263. Copyright (C) 2017 American Megatrends, Inc.

- ✓ **Serial Port X Configuration**
Sub menu: see "Serial Port X Configuration" (page 73)

4.3.8.1 Serial Port X Configuration

Aptio Setup Utility - Copyright (C) 2017 American Megatrends, Inc.
Advanced

Serial Port 1 Configuration		Enable or Disable Serial Port (COM)
Serial Port	[Enabled]	
Device Settings	IO=3F8h; IRQ=4;	
Change Settings	[Auto]	
Device Mode	[Normal]	
		←: Select Screen ↑↓: Select Item Enter: Select +/-: Change Opt. F1: General Help F2: Previous Values F3: Optimized Defaults F4: Save & Exit ESC: Exit

Version 2.18.1263. Copyright (C) 2017 American Megatrends, Inc.

- ✓ **Serial Port**
Options: Enabled / Disabled
- ✓ **Device Settings**
Options: none
- ✓ **Change Settings**
Options: Auto / IO=3F8h; IRQ=4 / IO=3F8h; IRQ=3, ...12 / IO=2F8h; IRQ=3, ...12 / IO=3E8h; IRQ=3, ...12 / IO=2E8h; IRQ=3, ...12
- ✓ **Device Mode**
Options: Normal / High Speed

4.3.9 H/W Monitor

Aptio Setup Utility - Copyright (C) 2017 American Megatrends, Inc.
Advanced

PC Health Status		
CPU dig.	: +23'C	
1.05V	: +0.98 V	
VCCCORE	: +0.95 V	
5V	: +4.94 V	
12V	: +12.18V	
VBATT	: +3.00 V	
3.3V	: +3.38 V	
SIO Temp	: +27 'C	
1.00V	: +0.99 V	
Memory VDD	: +1.18 V	
FAN 1	: N/A	
FAN 2	: +2222 RPM	
FAN 3	: N/A	
MB Temp	: +27 'C	
Memory Temp	: +28 'C	
PwrCtrlTemp	: +28 'C	
PwrCtrlVCC	: +5.00 V	
		←: Select Screen ↑↓: Select Item Enter: Select +/-: Change Opt. F1: General Help F2: Previous Values F3: Optimized Defaults F4: Save & Exit ESC: Exit

Version 2.18.1263. Copyright (C) 2017 American Megatrends, Inc.

- ✓ **CPU dig.**
Options: none
- ✓ **1.05V**
Options: none
- ✓ **VCCCORE**
Options: none
- ✓ **5V**
Options: none
- ✓ **12V**
Options: none
- ✓ **VBATT**
Options: none
- ✓ **3.3V**
Options: none
- ✓ **SIO Temp**
Options: none
- ✓ **1.00V**
Options: none
- ✓ **Memory VDD**
Options: none
- ✓ **FAN 1**
Options: none

- ✓ **FAN 2**
Options: none
- ✓ **FAN 3**
Options: none
- ✓ **MB Temp**
Options: none
- ✓ **Memory Temp**
Options: none
- ✓ **PwrCtrlTemp**
Options: none
- ✓ **PwrCtrlVCC**
Options: none

4.3.10 Serial Port Console Redirection

Aptio Setup Utility - Copyright (C) 2017 American Megatrends, Inc.
Advanced

COM0 Console Redirection [Disabled] ▶ Console Redirection Settings	Console Redirection Enable or Disable.
COM1 Console Redirection [Disabled] ▶ Console Redirection Settings	
COM2 Console Redirection [Disabled] ▶ Console Redirection Settings	
COM3 Console Redirection [Disabled] ▶ Console Redirection Settings	←: Select Screen ↑↓: Select Item Enter: Select +/-: Change Opt. F1: General Help F2: Previous Values F3: Optimized Defaults F4: Save & Exit ESC: Exit
COM4 (Pci Bus0,Dev0,Func0) (Disabled) Console Redirection Port Is Disabled	

Version 2.18.1263. Copyright (C) 2017 American Megatrends, Inc.

- ✓ **Console Redirection**
Options: Enabled / Disabled
- ✓ **Console Redirection Settings**
Sub menu: see "Console Redirection Settings" (page 77)

4.3.10.1 Console Redirection Settings

Aptio Setup Utility - Copyright (C) 2017 American Megatrends, Inc.
Advanced

<pre> COMO Console Redirection Settings Terminal Type [VT-UTF8] Bits per second [115200] Data Bits [8] Parity [None] Stop Bits [1] Flow Control [None] VT-UTF8 Combo Key Support [Enabled] Recorder Mode [Disabled] Resolution 100x31 [Enabled] Legacy OS Redirection Resolution [80x24] Putty KeyPad [VT100] Redirection After BIOS POST [Always Enable] </pre>	<pre> Emulation: ANSI: Extended ASCII char set. VT100: ASCII char set. VT100+: Extends VT100 to support color, function keys, etc. VT-UTF8: Uses UTF8 encoding to map Unicode chars onto 1 or more bytes. ----- ←: Select Screen ↑: Select Item Enter: Select +/-: Change Opt. F1: General Help F2: Previous Values F3: Optimized Defaults F4: Save & Exit ESC: Exit </pre>
--	--

Version 2.18.1263. Copyright (C) 2017 American Megatrends, Inc.

- ✓ **Terminal Type**
Options: VT100 / VT100+ / VT-UTF8 / ANSI
- ✓ **Bits per second**
Options: 9600 / 19200 / 38400 / 57600 / 115200
- ✓ **Data Bits**
Options: 7 / 8
- ✓ **Parity**
Options: None / Even / Odd / Mark / Space
- ✓ **Stop Bits**
Options: 1 / 2
- ✓ **Flow Control**
Options: None / Hardware RTS/CTS
- ✓ **VT-UTF8 Combo Key Support**
Options: Disabled / Enabled
- ✓ **Recorder Mode**
Options: Disabled / Enabled
- ✓ **Resolution 100x31**
Options: Disabled / Enabled
- ✓ **Legacy OS Redirection Resolution**
Options: 80x24 / 80x25
- ✓ **Putty KeyPad**
Options: VT100 / LINUX / XTERMR6 / SCO / ESCN / VT400

✓ **Redirection After BIOS POST**

Options: Always Enable / BootLoader

4.3.11 PCI Subsystem Settings

Aptio Setup Utility - Copyright (C) 2017 American Megatrends, Inc.
Advanced

PCI Bus Driver Version PCI Devices Common Settings: PCI Latency Timer PCI-X Latency Timer VGA Palette Snoop PERR# Generation SERR# Generation Above 4G Decoding ▶ PCI Hot-Plug Settings	A5.01.12 [32 PCI Bus Clocks] [64 PCI Bus Clocks] [Disabled] [Disabled] [Disabled] [Disabled]	Value to be programmed into PCI Latency Timer Register. ←: Select Screen ↑↓: Select Item Enter: Select +/-: Change Opt. F1: General Help F2: Previous Values F3: Optimized Defaults F4: Save & Exit ESC: Exit
---	--	---

Version 2.18.1263. Copyright (C) 2017 American Megatrends, Inc.

- ✓ **PCI Latency Timer**
Options: 32, 64,...224, 248 PCI Bus Clocks
- ✓ **PCI-X Latency Timer**
Options: 32, 64,...224, 248 PCI Bus Clocks
- ✓ **VGA Palette Snoop**
Options: Disabled / Enabled
- ✓ **PERR# Generation**
Options: Disabled / Enabled
- ✓ **SERR# Generation**
Options: Disabled / Enabled
- ✓ **Above 4G Decoding**
Options: Enabled / Disabled
- ✓ **PCI Hot-Plug Settings**
Sub menu: see "PCI Hot-Plug Settings" (page 80)

4.3.11.1 PCI Hot-Plug Settings

Aptio Setup Utility - Copyright (C) 2017 American Megatrends, Inc.
Advanced

<p>PCI Hot-Plug Settings</p> <p>BIOS Hot-Plug Support [Enabled]</p> <p>PCI Buses Padding [1]</p> <p>I/O Resources Padding [4 K]</p> <p>MMIO 32 bit Resources Padding [16 M]</p> <p>PFMMIO 32 bit Resources Padding [16 M]</p>	<p>If ENABLED allows BIOS build in Hot-Plug supported Ordering</p> <hr/> <p>←: Select Screen ↑: Select Item Enter: Select +/-: Change Opt. F1: General Help F2: Previous Values F3: Optimized Defaults F4: Save & Exit ESC: Exit</p>
---	--

Version 2.18.1263. Copyright (C) 2017 American Megatrends, Inc.

- ✓ **BIOS Hot-Plug Support**
Options: Enabled / Disabled
- ✓ **PCI Buses Padding**
Options: Disabled / 1 / 2 / 3 / 3 / 5
- ✓ **I/O Resources Padding**
Options: Disabled / 4 K / 8 K / 16 K / 32 K
- ✓ **MMIO 32 bit Resources**
Options: Disabled / 4 K / 8 K / 16 K / 32 K
- ✓ **PFMMIO 32 bit Resources**
Options: Disabled / 1 M / 2 M / 4 M / 8 M / 16 M / 32 M / 64 M / 64 M

4.3.12 Network Stack Configuration

Aptio Setup Utility - Copyright (C) 2017 American Megatrends, Inc.
Advanced

Network Stack	[Enabled]	Enable/Disable UEFI Network Stack
IPv4 PXE Support	[Disabled]	
IPv4 HTTP Support	[Disabled]	
IPv6 PXE Support	[Disabled]	
IPv6 HTTP Support	[Disabled]	
IPv6 Configuration Policy	[Automatic]	
PXE boot wait time	0	
Media detect count	1	
		→: Select Screen ↑↓: Select Item Enter: Select +/-: Change Opt. F1: General Help F2: Previous Values F3: Optimized Defaults F4: Save & Exit ESC: Exit

Version 2.18.1263. Copyright (C) 2017 American Megatrends, Inc.

- ✓ **Network stack**
Options: Disabled / Enabled
- ✓ **IPv4 PXE Support**
Options: Disabled / Enabled
- ✓ **IPv4 HTTP Support**
Options: Disabled / Enabled
- ✓ **IPv6 PXE Support**
Options: Disabled / Enabled
- ✓ **IPv6 HTTP Support**
Options: Disabled / Enabled
- ✓ **IPv6 Configuration Policy**
Options: Automatic / Manual
- ✓ **PXE boot wait time**
Options: 0..5
- ✓ **Media detect count**
Options: 0..50

4.3.13 Power Controller Options

Aptio Setup Utility - Copyright (C) 2017 American Megatrends, Inc.
Advanced

Bootloader Version Firmware Version Mainboard Serial No Mainboard Prod. Date (Week.Year) Mainboard BootCount Mainboard Operation Time Voltage (Min/Max) Temperature (Min/Max) ext. USB-Port Voltage int. USB-Port Voltage WDT OSBoot Timeout	1.00-31 1.01-00 15559716370007 51.16 322 86041min (1434h) 4.60V / 5.20V -35'C / 99'C [Off in S3-5] [Off in S3-5] [Disabled]	Select Power line for external USB devices, if powered-down →: Select Screen ↑↓: Select Item Enter: Select +/-: Change Opt. F1: General Help F2: Previous Values F3: Optimized Defaults F4: Save & Exit ESC: Exit
--	---	---

Version 2.18.1263. Copyright (C) 2017 American Megatrends, Inc.

- ✓ **Bootloader Version**
Options: none
- ✓ **Firmware Version**
Options: none
- ✓ **Mainboard Serial No**
Options: none
- ✓ **Mainboard Prod. Date (Week.Year)**
Options: none
- ✓ **Mainboard Boot Count**
Options: none
- ✓ **Mainboard Operation Time**
Options: none
- ✓ **Voltage (Min/Max)**
Options: none
- ✓ **Temperature (Min/Max)**
Options: none
- ✓ **ext. USB-Port Voltage**
Options: Off in S3-5 / by SVCC
- ✓ **int. USB-Port Voltage**
Options: Off in S3-5 / by SVCC
- ✓ **WatchDogTimer Mode**
Options: Normal Mode / Compatibility Mode

✓ **WDT OSBoot Timeout**

Options: Disabled / 45 Seconds ... 255 Seconds

4.3.14 Compatibility Support Module Configuration

Aptio Setup Utility - Copyright (C) 2017 American Megatrends, Inc.
Advanced

Compatibility Support Module Configuration		Determines OpROM execution policy for devices other than Network, Storage, or Video
CSM Support	[Enabled]	
CSM16 Module Version	07.80	
GateA20 Active	[Upon Request]	
Option ROM Messages	[Force BIOS]	
INT19 Trap Response	[Immediate]	
Boot option filter	[UEFI and Legacy]	
Option ROM execution		
Network	[Legacy]	←: Select Screen
Storage	[Legacy]	↑↓: Select Item
Video	[Legacy]	Enter: Select
Other PCI devices	[UEFI]	+/-: Change Opt.
		F1: General Help
		F2: Previous Values
		F3: Optimized Defaults
		F4: Save & Exit
		ESC: Exit

Version 2.18.1263. Copyright (C) 2017 American Megatrends, Inc.

- ✓ **CSM Support**
Options: Disabled / Enabled
- ✓ **CSM16 Module Version**
Options: none
- ✓ **GateA20 Active**
Options: Upon Request / Always
- ✓ **Option ROM Messages**
Options: Force BIOS / Keep Current
- ✓ **INT9 Trap Response**
Options: Immediate / Postponed
- ✓ **Boot option filter**
Options: UEFI and Legacy / Legacy only / UEFI only
- ✓ **Network**
Options: Do not launch / UEFI only / Legacy only
- ✓ **Storage**
Options: Do not launch / UEFI only / Legacy only
- ✓ **Video**
Options: Do not launch / UEFI only / Legacy only
- ✓ **Other PCI devices**
Options: Do not launch / UEFI / Legacy

4.3.16 USB Configuration

Aptio Setup Utility - Copyright (C) 2017 American Megatrends, Inc.
Advanced

<pre> USB Configuration USB Module Version 19 USB Controllers: 1 XHCI USB Devices: 1 Keyboard Legacy USB Support [Enabled] XHCI Hand-off [Enabled] USB Mass Storage Driver Support [Enabled] USB hardware delays and time-outs: USB transfer time-out [20 sec] Device reset time-out [20 sec] Device power-up delay [Manual] Device power-up delay in seconds 5 </pre>	<pre> Enables Legacy USB support. AUTO option disables legacy support if no USB devices are connected. DISABLE option will keep USB devices available only for EFI applications. ----- ->: Select Screen ↑↓: Select Item Enter: Select +/-: Change Opt. F1: General Help F2: Previous Values F3: Optimized Defaults F4: Save & Exit ESC: Exit </pre>
---	--

Version 2.18.1263. Copyright (C) 2017 American Megatrends, Inc.

- ✓ **USB Module Version**
Options: none
- ✓ **USB Devices**
Options: none
- ✓ **USB Controllers**
Options: none
- ✓ **Legacy USB Support**
Options: Enabled / Disabled / Auto
- ✓ **XHCI Hand-off**
Options: Enabled / Disabled
- ✓ **USB Mass Storage Driver Support**
Options: Disabled / Enabled
- ✓ **USB transfer time-out**
Options: 5 sec / 10 sec / 20 sec
- ✓ **USB transfer time-out**
Options: 10 sec / 20 sec / 30 sec / 40 sec
- ✓ **Device power-up delay**
Options: Auto / Manual
- ✓ **Device power-up delay in seconds**
Options: 1..40

4.3.17 SATA and RST Configuration

Aptio Setup Utility - Copyright (C) 2017 American Megatrends, Inc.
Advanced

SATA And RST Configuration		▲ Enable or disable SATA Device.
SATA Controller(s)	[Enabled]	
SATA Mode Selection	[Intel RST Premium]	
SATA Test Mode	[Disabled]	
RAID Device ID	[Client]	
▶ Software Feature Mask Configuration		
Aggressive LPM Support	[Enabled]	
SATA Controller Speed	[Default]	
Serial ATA Port 0	Empty	
Software Preserve	Unknown	
Port 0	[Enabled]	
Hot Plug	[Enabled]	→: Select Screen
Configured as eSATA	Hot Plug supported	↑↓: Select Item n
Spin Up Device	[Disabled]	Enter: Select
SATA Device Type	[Hard Disk Drive]	+/-: Change Opt.
Topology	[Unknown]	F1: General Help
SATA Port 0 DevSlp	[Disabled]	F2: Previous Values
DITO Configuration	[Disabled]	F3: Optimized Defaults
DITO Value	625	F4: Save & Exit
DM Value	15	ESC: Exit
Serial ATA Port 1	Empty	
Software Preserve	Unknown	
Port 1	[Enabled]	
		▼

Version 2.18.1263. Copyright (C) 2017 American Megatrends, Inc.

- ✓ **SATA Controller(s)**
Options: Enabled / Disabled
- ✓ **SATA Mode Selection**
Options: IDE / AHCI / RAID
- ✓ **SATA Test Mode**
Options: Enabled / Disabled
- ✓ **RAID Device ID**
Options: Client / Alternate
- ✓ **Software Feature Mask Configuration**
Sub menu: see "Software Feature Mask Configuration" (page 89)
- ✓ **Aggressive LPM Support**
Options: Enabled / Disabled
- ✓ **SATA Controller Speed**
Options: Default / Gen1 / Gen2 / Gen3
- ✓ **Serial ATA Port X**
Options: none
- ✓ **Software Preserve**
Options: none
- ✓ **Port X**
Options: Enabled / Disabled
- ✓ **Hot Plug**
Options: Enabled / Disabled

- ✓ **Configured as eSATA**
Options: none
- ✓ **Spin Up Device**
Options: Enabled / Disabled
- ✓ **SATA Device Type**
Options: Hard Disk Drive / Solid State Drive
- ✓ **Topology**
Options: Unknown / ISATA / Direct Connect / Flex / M2
- ✓ **SATA Port X DevSlp**
Options: Disabled / Enabled
- ✓ **DITO Configuration**
Options: Disabled / Enabled
- ✓ **DITO Value**
Options: 0..1023
- ✓ **DM Value**
Options: 0..15

4.3.17.1 Software Feature Mask Configuration

Aptio Setup Utility - Copyright (C) 2017 American Megatrends, Inc.
Advanced

<pre> Software Feature Mask Configuration HDD Unlock [Enabled] LED Locate [Enabled] RAID0 [Enabled] RAID1 [Enabled] RAID10 [Enabled] RAID5 [Enabled] Intel Rapid Recovery Technolgy [Enabled] OROM UI and BANNER [Enabled] IRRT Only on eSATA [Enabled] Smart Response Technology [Enabled] OROM UI Normal Delay [2 secs] RST Force Form [Enabled] </pre>	<pre> If enabled, indicates that the HDD password unlock in the OS is enabled. ---: Select Screen ↑↓: Select Item Enter: Select +/-: Change Opt. F1: General Help F2: Previous Values F3: Optimized Defaults F4: Save & Exit ESC: Exit </pre>
--	--

Version 2.18.1263. Copyright (C) 2017 American Megatrends, Inc.

- ✓ **HDD Unlock**
Options: Enabled / Disabled
- ✓ **LED Locate**
Options: Enabled / Disabled
- ✓ **RAID0**
Options: Enabled / Disabled
- ✓ **RAID1**
Options: Enabled / Disabled
- ✓ **RAID10**
Options: Enabled / Disabled
- ✓ **RAID5**
Options: Enabled / Disabled
- ✓ **Intel Rapid Recovery Technology**
Options: Enabled / Disabled
- ✓ **OROM UI and BANNER**
Options: Enabled / Disabled
- ✓ **IRRT Only on eSATA**
Options: Enabled / Disabled
- ✓ **Smart Response Technology**
Options: Enabled / Disabled
- ✓ **OROM UI Normal Delay**
Options: 2 / 4 / 6 / 8 Seconds

✓ **RST Force Form**

Options: Enabled / Disabled

4.3.18 AMT Configuration

Aptio Setup Utility - Copyright (C) 2017 American Megatrends, Inc.
Advanced

ASF Support	[Enabled]	Enable/Disable of AMT USB Provisioning.
USB Provisioning of AMT	[Disabled]	
▶ CIRA Configuration		
▶ ASF Configuration		
▶ Secure Erase Configuration		
▶ OEM Flags Settings		
▶ MEBx Resolution Settings		
		←: Select Screen ↑: Select Item Enter: Select +/-: Change Opt. F1: General Help F2: Previous Values F3: Optimized Defaults F4: Save & Exit ESC: Exit

Version 2.18.1263. Copyright (C) 2017 American Megatrends, Inc.

- ✓ **ASF Support**
Options: Enabled / Disabled
- ✓ **AMT Provisioning of AMT**
Options: Enabled / Disabled
- ✓ **CIRA Configuration**
Sub menu: see "CIRA Configuration" (page 91)
- ✓ **ASF Configuration**
Sub menu: see "ASF Configuration" (page 93)
- ✓ **Secure Erase Configuration**
Sub menu: see "Secure Erase Configuration" (page 94)
- ✓ **OEM Flags Settings**
Sub menu: see "OEM Flags Configuration" (page 95)
- ✓ **MEBx Resolution Settings**
Sub menu: see "MEBx Resolution Settings" (page 96)

4.3.18.1 CIRA Configuration

Aptio Setup Utility - Copyright (C) 2017 American Megatrends, Inc.
Advanced

<pre> Activate Remote Assistance Process [Disabled] CIRA Timeout 0 </pre>	<pre> Enable/Disable of AMT USB Provisioning. ----- --: Select Screen ↑↓: Select Item Enter: Select +/-: Change Opt. F1: General Help F2: Previous Values F3: Optimized Defaults F4: Save & Exit ESC: Exit </pre>
---	--

Version 2.18.1263. Copyright (C) 2017 American Megatrends, Inc.

✓ **Activate Remote Assistance Process**

Options: Enabled / Disabled

✓ **CIRA Timeout**

Options: 0..255

4.3.18.2 ASF Configuration

Aptio Setup Utility - Copyright (C) 2017 American Megatrends, Inc.
Advanced

PET Progress	[Enabled]	Enable/Disable of AMT USB Provisioning.
WatchDog	[Disabled]	
OS Timer	0	
BIOS Timer	0	
		←: Select Screen ↑: Select Item Enter: Select +/-: Change Opt. F1: General Help F2: Previous Values F3: Optimized Defaults F4: Save & Exit ESC: Exit

Version 2.18.1263. Copyright (C) 2017 American Megatrends, Inc.

- ✓ **PET Progress**
Options: Enabled / Disabled
- ✓ **WatchDog**
Options: Enabled / Disabled
- ✓ **OS Timer**
Options: 0..65535
- ✓ **BIOS Timer**
Options: 0..65535

4.3.18.3 Secure Erase Configuration

Aptio Setup Utility - Copyright (C) 2017 American Megatrends, Inc.
Advanced

Secure Erase Mode	[Simulated]	Change Secure Erase module behavior: Simulated: Performs SE flow without erasing SSD Real: Erase SSD.
Force Secure Erase	[Disabled]	
		←: Select Screen ↑↓: Select Item Enter: Select +/-: Change Opt. F1: General Help F2: Previous Values F3: Optimized Defaults F4: Save & Exit ESC: Exit

Version 2.18.1263. Copyright (C) 2017 American Megatrends, Inc.

- ✓ **Secure Erase mode**
Options: Simulated / Real
- ✓ **Force Secure Erase**
Options: Disabled / Enabled

4.3.18.4 OEM Flags Configuration

Aptio Setup Utility - Copyright (C) 2017 American Megatrends, Inc.
Advanced

MEBx hotkey Pressed	[Simulated]	Change Secure Erase module behavior: Simulated: Performs SE flow without erasing SSD Real: Erase SSD.
MEBx Selection Screen	[Disabled]	
Hide Unconfigure ME Confirmation Prompt	[Disabled]	
MEBx OEM Debug Menu Enable	[Disabled]	
Unconfigure ME	[Disabled]	
		←: Select Screen ↑↓: Select Item Enter: Select +/-: Change Opt. F1: General Help F2: Previous Values F3: Optimized Defaults F4: Save & Exit ESC: Exit

Version 2.18.1263. Copyright (C) 2017 American Megatrends, Inc.

- ✓ **MEBx Selection**
Options: Disabled / Enabled
- ✓ **MEBx Selection Screen**
Options: Disabled / Enabled
- ✓ **Hide Unconfigure ME Confirmation Prompt**
Options: Disabled / Enabled
- ✓ **MEBx OEM Debug Menu Enable**
Options: Disabled / Enabled
- ✓ **Unconfigure ME**
Options: Disabled / Enabled

4.3.18.5 MEBx Resolution Settings

Aptio Setup Utility - Copyright (C) 2017 American Megatrends, Inc.
Advanced

Non-UI Mode Resolution	[Auto]	Change Secure Erase module behavior: Simulated: Performs SE flow without erasing SSD Real: Erase SSD.
UI Mode Resolution	[Auto]	
Graphics Mode Resolution	[Auto]	
		←→: Select Screen ↑↓: Select Item Enter: Select +/-: Change Opt. F1: General Help F2: Previous Values F3: Optimized Defaults F4: Save & Exit ESC: Exit

Version 2.18.1263. Copyright (C) 2017 American Megatrends, Inc.

- ✓ **Non-UI Mode Resolution**
Options: Auto / 80x25 / 100x31
- ✓ **UI Mode Resolution**
Options: Auto / 80x25 / 100x31
- ✓ **Graphics Mode Resolution**
Options: Auto / 640x480 / 800x600 / 1024x768

4.4 Chipset

Aptio Setup Utility - Copyright (C) 2017 American Megatrends, Inc.
CHIPSET

<ul style="list-style-type: none">▶ System Agent (SA) Configuration▶ PCH-IO Configuration	<p>System Agent (SA) Parameters</p> <hr/> <p>←→: Select Screen ↑↓: Select Item Enter: Select +/-: Change Opt. F1: General Help F2: Previous Values F3: Optimized Defaults F4: Save & Exit ESC: Exit</p>
--	---

Version 2.18.1263. Copyright (C) 2017 American Megatrends, Inc.

- ✓ **System Agent (SA) Configuration**
Sub menu: see "System Agent (SA) Configuration" (page 98)
- ✓ **PCH-IO Configuration**
Sub menu: see "PCH-IO Configuration" (page 110)

4.4.1 System Agent (SA) Configuration

Aptio Setup Utility - Copyright (C) 2017 American Megatrends, Inc.
Chipset

<p>System Agent (SA) Configuration</p> <p>SA PCIe Code Version 1.7.0.0 VT-d Supported</p> <p>▶ Graphics Configuration ▶ PEG Port Configuration</p> <p>VT-d [Enabled] CHAP Device (B0:D7:F0) [Disabled] Thermal Device (B0:D4:F0) [Disabled] GMM Device (B0:D8:F0) [Enabled] CRID Support [Disabled] Above 4GB MMIO BIOS assignment [Disabled]</p>	<p>Graphics Configuration</p> <hr/> <p>←: Select Screen ↑↓: Select Item Enter: Select +/-: Change Opt. F1: General Help F2: Previous Values F3: Optimized Defaults F4: Save & Exit ESC: Exit</p>
--	--

Version 2.18.1263. Copyright (C) 2017 American Megatrends, Inc.

- ✓ **Graphics Configuration**
Sub menu: see "Graphics Configuration" (page 99)
- ✓ **PEG Port Configuration**
Sub menu: see "PEG Port Configuration" (page 103)
- ✓ **VT-d**
Options: Disabled / Enabled
- ✓ **CHAP Device (B0:D7:F0)**
Options: Disabled / Enabled
- ✓ **Thermal Device (B0:D4:F0)**
Options: Disabled / Enabled
- ✓ **GMM Device (B0:D8:F0)**
Options: Disabled / Enabled
- ✓ **CRID Support**
Options: Disabled / Enabled
- ✓ **Above 4GB MMIO BIOS assignment**
Options: Disabled / Enabled

4.4.1.1 Graphics Configuration

Aptio Setup Utility - Copyright (C) 2017 American Megatrends, Inc.
Chipset

<pre> Graphics Configuration Graphics Turbo IMON Current 31 Skip Scanning of External Gfx Card [Disabled] Primary Display [Auto] Select PCIE Card [Auto] ▶ External Gfx Card Primary Display Configuration Internal Graphics [Auto] GTT Size [8MB] Aperture Size [256MB] DVMT Pre-Allocated [32M] DVMT Total Gfx Mem [256M] Gfx Low Power Mode [Enabled] VDD Enable [Enabled] HDCP Support [Enabled] Algorithm [One-time] EM Support [Enabled] PAVP Enable [Enabled] Cdynmax Clamping Enable [Enabled] Cd Clock Frequency [675 Mhz] IUER Button Enable [Disabled] ▶ LCD Control </pre>	<pre> Graphics turbo IMON current values supported (14-31) ---: Select Screen ↑: Select Item Enter: Select +/-: Change Opt. F1: General Help F2: Previous Values F3: Optimized Defaults F4: Save & Exit ESC: Exit </pre>
--	---

Version 2.18.1263. Copyright (C) 2017 American Megatrends, Inc.

- ✓ **Graphics Turbo IMON Current**
Options: 14...31
- ✓ **Skip scanning of external Gfx Card**
Options: Disabled / Enabled
- ✓ **Primary Display**
Options: Auto / IGFX / PEG / PCI
- ✓ **Select PCIE Card**
Options: Auto / Elk Creek 4 / PEG Eval
- ✓ **External Gfx Card Primary Display Configuration**
Sub menu: see "External Gfx Card Primary Display Configuration" (page 101)
- ✓ **Internal Graphics**
Options: Auto / Disabled / Enabled
- ✓ **GTT Size**
Options: 1MB / 2MB
- ✓ **Aperture Size**
Options: 128MB / 256MB / 512MB
- ✓ **DVMT Pre-Allocated**
Options: 32M / 64M ... 480M / 512M / 1024M
- ✓ **DVMT Total Gfx Mem**
Options: 128M / 256M / MAX
- ✓ **Gfx Low Power Mode**
Options: Disabled / Enabled

-
- ✓ **VDD Enable**
Options: Disabled / Enabled

 - ✓ **HDCP Support**
Options: Disabled / Enabled

 - ✓ **Algorithm**
Options: One-time / Periodic

 - ✓ **PM Support**
Options: Disabled / Enabled

 - ✓ **PAVP Enable**
Options: Disabled / Enabled

 - ✓ **Cdynmax Clamping Enable**
Options: Disabled / Enabled

 - ✓ **Cd Clock Frequency**
Options: 337.5 Mhz / 450 Mhz / 540 Mhz / 675 Mhz

 - ✓ **IUER Button Enable**
Options: Enabled / Disabled

 - ✓ **LCD Control**
Sub menu: see "LCD Control" (page 102)

4.4.1.1.1 External Gfx Card Primary Display Configuration

Aptio Setup Utility - Copyright (C) 2017 American Megatrends, Inc.
Chipset

<p>External Gfx Card Primary Display Configuration</p> <p>Primary PEG [Auto] Primary PCIE [Auto]</p>	<p>Select PEG0/PEG1/PEG2/PEG3 Graphics device should be Primary PEG.</p> <hr/> <p>←: Select Screen ↑↓: Select Item Enter: Select +/-: Change Opt. F1: General Help F2: Previous Values F3: Optimized Defaults F4: Save & Exit ESC: Exit</p>
--	---

Version 2.18.1263. Copyright (C) 2017 American Megatrends, Inc.

- ✓ **Primary PEG**
Options: Auto / PEG11 / PEG 12
- ✓ **Primary PCIE**
Options: Auto / PCIE1 / PCIE2 / ... / PCIE7

4.4.1.1.2 LCD Control

Aptio Setup Utility - Copyright (C) 2017 American Megatrends, Inc.
Chipset

LCD Control		Select the Video Device which will be activated during POST. This has no effect if external graphics present. Secondary boot display selection will appear based on your selection. VGA modes will be supported only on primary display
Primary IGFX Boot Display	[VBIOS Default]	
LCD Panel Type	[VBIOS Default]	
Panel Scaling	[Auto]	
Backlight Control	[PWM Normal]	
Active LFP	[eDP Port-A]	
Panel Color Depth	[18 Bit]	
Backlight Brightness	255	
		←: Select Screen ↑↓: Select Item Enter: Select +/-: Change Opt. F1: General Help F2: Previous Values F3: Optimized Defaults F4: Save & Exit ESC: Exit

Version 2.18.1263. Copyright (C) 2017 American Megatrends, Inc.

- ✓ **Primary IGFX Boot Display**
Options: VBIOS Default / EFP / EFP3 / EFP2
- ✓ **Secondary IGFX Boot Display**
Options: Disabled / EFP / EFP3 / EFP2 / EFP4
- ✓ **LCD Panel Type**
Options: VBIOS Default / 640x480 LVDS ...1366x768 LVDS
- ✓ **Panel Scaling**
Options: Auto / Off / Force Scaling
- ✓ **Backlight Control**
Options: PWM Inverted / PWM Normal
- ✓ **Active LFP**
Options: No eDP / eDP Port-A
- ✓ **Panel Color Depth**
Options: 18 Bit / 24 Bit
- ✓ **Backlight Brightness**
Options: 0..255

4.4.1.2 PEG Port Configuration

Aptio Setup Utility - Copyright (C) 2017 American Megatrends, Inc.
Chipset

PEG Port Configuration		Enabled or Disable Root Port
PEG 0:1:0	Not Present	
Enable Root Port	[Enabled]	
Max Link Speed	[Auto]	
PEG0 Slot Power Limit Value	75	
PEG0 Slot Power Limit Scale	[1.0x]	
PEG0 Physical Slot Number	1	
PEG0 Hotplug	[Enabled]	
Extra Bus Reserved	0	
Reserved Memory	20	
Reserved I/O	4	
PEG 0:1:1	Not Present	
Enable Root Port	[Enabled]	
Max Link Speed	[Auto]	
PEG1 Slot Power Limit Value	75	
PEG1 Slot Power Limit Scale	[1.0x]	
PEG1 Physical Slot Number	2	
PEG1 Hotplug	[Enabled]	
Extra Bus Reserved	0	
Reserved Memory	10	
Reserved I/O	4	
PEG 0:1:2	Not Present	
Enable Root Port	[Auto]	
Max Link Speedhasel Eq	[Auto]	

←: Select Screen
 ↑: Select Item
 Enter: Select
 +/-: Change Opt.
 F1: General Help
 F2: Previous Values
 F3: Optimized Defaults
 F4: Save & Exit
 ESC: Exit

Version 2.18.1263. Copyright (C) 2017 American Megatrends, Inc.

- ✓ **Enable Root Port**
Options: Disabled / Enabled / Auto
- ✓ **Max Link Speed**
Options: Auto / Gen1 / Gen2 / Gen3
- ✓ **PEGx Slot Power Limit Value**
Options: 0..255
- ✓ **PEGx Slot Power Limit Scale**
Options: 1.0x / 0.1x / 0.01x / 0.001x
- ✓ **PEGx Physical Slot Number**
Options: 0..8191
- ✓ **PEG X Hotplug**
Options: Disabled / Enabled
- ✓ **Extra Bus Reserved**
Options: 0...7
- ✓ **Reserved Memory**
Options: 1...20
- ✓ **Reserved I/O**
Options: 4K / 8K / 12K / 16K / 20K
- ✓ **PEG Port Feature Configuration**
Sub menu: see "PEG Port Feature Configuration" (page 105)
- ✓ **Program PCIe ASPM after OpROM**
Options: Enabled / Disabled

-
- ✓ **Program Static Phase1 Eq**
Options: Disabled / Enabled

 - ✓ **Gen3 Root Port Preset Value for each Lane**
Sub menu: see "PEG Gen3 Root Port Preset Value for each Lane" (page 106)

 - ✓ **PEG Gen3 Endpoint Preset Value for each Lane**
Sub menu: see "PEG Gen3 Endpoint Preset Value each Lane" (page 107)

 - ✓ **PEG Gen3 Endpoint Hint Value for each Lane**
Sub menu: see "PEG Gen3 Endpoint Hint Value each Lane" (page 108)

 - ✓ **Gen3 RxCTLE Control**
Sub menu: see "Gen3 RxCTLE Control" (page 109)

 - ✓ **Always Attempt SW EQ**
Options: Enabled / Disabled

 - ✓ **Number of Presets to test**
Options: 7, 3, 5 / 0-9 / Auto

 - ✓ **Allow PERST# GPIO Usage**
Options: Disabled / Enabled

 - ✓ **SW EQ Enable VOC**
Options: Jitter Only Test Mode / Jitter & VOC Test Mode / Auto

 - ✓ **Jitter Dwell Time**
Options: 0..65535

 - ✓ **Jitter Error Target**
Options: 1..65535

 - ✓ **VOC Dwell Time**
Options: 0..65535

 - ✓ **VOC Error Target**
Options: 1..65535

 - ✓ **Generate BDAT Margin DATA**
Options: Disabled / Generate Port Jitter Data

 - ✓ **PCIe Rx CEM Test Mode**
Options: Disabled / Enabled

 - ✓ **PEG Lane Number for Test**
Options: 0..15

 - ✓ **Non-Protocol Awareness**
Options: Disabled / Enabled

4.4.1.2.1 PEG Port Feature Configuration

Aptio Setup Utility - Copyright (C) 2017 American Megatrends, Inc.
Chipset

PEG Port Feature Configuration	Detect Non-Compliance PCI Express Device in PEG
Detect Non-Compliance Device [Disabled]	
	←: Select Screen ↑: Select Item Enter: Select +/-: Change Opt. F1: General Help F2: Previous Values F3: Optimized Defaults F4: Save & Exit ESC: Exit

Version 2.18.1263. Copyright (C) 2017 American Megatrends, Inc.

- ✓ **Detect Non-Compliance Device**
Options: Disabled / Enabled

4.4.1.2.2 PEG Gen3 Root Port Preset Value for each Lane

Aptio Setup Utility - Copyright (C) 2017 American Megatrends, Inc.
Chipset

Gen3 Root Port Preset Value for each Lane		Value for Lane 0
Lane 0	7	
Lane 1	7	
Lane 2	7	
Lane 3	7	
Lane 4	7	
Lane 5	7	
Lane 6	7	
Lane 7	7	
Lane 8	7	
Lane 9	7	
Lane 10	7	
Lane 11	7	
Lane 12	7	
Lane 13	7	
Lane 14	7	
Lane 15	7	

←: Select Screen ↑: Select Item Enter: Select +/-: Change Opt. F1: General Help F2: Previous Values F3: Optimized Defaults F4: Save & Exit ESC: Exit
--

Version 2.18.1263. Copyright (C) 2017 American Megatrends, Inc.

- ✓ **Gen3 Root Port Preset Value for each Lane**
Options: 1..11

4.4.1.2.3 PEG Gen3 Endpoint Preset Value each Lane

Aptio Setup Utility - Copyright (C) 2017 American Megatrends, Inc.
Chipset

Gen3 Endpoint Preset Value for each Lane	Lane 0 End point preset value for Gen3 Equalization.
Lane 0 7	
Lane 1 7	
Lane 2 7	
Lane 3 7	
Lane 4 7	
Lane 5 7	
Lane 6 7	
Lane 7 7	
Lane 8 7	
Lane 9 7	
Lane 10 7	
Lane 11 7	
Lane 12 7	
Lane 13 7	
Lane 14 7	
Lane 15 7	
	←: Select Screen ↑↓: Select Item Enter: Select +/-: Change Opt. F1: General Help F2: Previous Values F3: Optimized Defaults F4: Save & Exit ESC: Exit

Version 2.18.1263. Copyright (C) 2017 American Megatrends, Inc.

- ✓ **Gen3 Endpoint Preset Value each Lane**
Options: 0..11

4.4.1.2.4 PEG Gen3 Endpoint Hint Value each Lane

Aptio Setup Utility - Copyright (C) 2017 American Megatrends, Inc.
Chipset

Gen3 Endpoint Hint Value for each Lane	Lane 0 End Point Hint value for Gen3 Equalization.
Lane 0 2	
Lane 1 2	
Lane 2 2	
Lane 3 2	
Lane 4 2	
Lane 5 2	
Lane 6 2	
Lane 7 2	
Lane 8 2	
Lane 9 2	
Lane 10 2	
Lane 11 2	
Lane 12 2	
Lane 13 2	
Lane 14 2	
Lane 15 2	
	←: Select Screen ↑: Select Item Enter: Select +/-: Change Opt. F1: General Help F2: Previous Values F3: Optimized Defaults F4: Save & Exit ESC: Exit

Version 2.18.1263. Copyright (C) 2017 American Megatrends, Inc.

- ✓ **PEG Gen3 Endpoint Hint Value each Lane**
Options: 0..11

4.4.1.2.5 Gen3 RxCTLE Control

Aptio Setup Utility - Copyright (C) 2017 American Megatrends, Inc.
Chipset

Gen3 RxCTLE Control		Gen3 RxCTLE setting for Bundle0 (Lane0, Lane1)
Bundle0	0	
Bundle1	0	
Bundle2	0	
Bundle3	0	
Bundle4	0	
Bundle5	0	
Bundle6	0	
Bundle7	0	
RxCTLE Override	[Disabled]	
		←: Select Screen ↑: Select Item Enter: Select +/-: Change Opt. F1: General Help F2: Previous Values F3: Optimized Defaults F4: Save & Exit ESC: Exit

Version 2.18.1263. Copyright (C) 2017 American Megatrends, Inc.

- ✓ **PCIe Gen3 RxCTLEp Setting x**
Options: 0..15

4.4.2 PCH-IO Configuration

Aptio Setup Utility - Copyright (C) 2017 American Megatrends, Inc.
Chipset

<p>PCH-IO Configuration</p> <ul style="list-style-type: none"> ▶ PCI Express Configuration ▶ USB Configuration ▶ HD Audio Configuration <p>PCH LAN Controller [Enabled] DeepSx Power Policies [Disabled] LAN Wake From DeepSx [Enabled] Wake on LAN [Enabled] SLP_LAN# Low on DC Power [Enabled] Second LAN Controller [Enabled] CLKRUN# logic [Enabled] State after G3 [S0 State] Compatible Revision ID [Disabled] PCH Cross Throttling [Enabled] PCIe P11 SSC [Auto]</p>	<p>PCI Express Configuration settings</p> <hr/> <p>←: Select Screen ↑: Select Item Enter: Select +/-: Change Opt. F1: General Help F2: Previous Values F3: Optimized Defaults F4: Save & Exit ESC: Exit</p>
--	---

Version 2.18.1263. Copyright (C) 2017 American Megatrends, Inc.

- ✓ **PCI Express Configuration**
Sub menu: see "PCI Express Configuration" (page 112)
- ✓ **USB Configuration**
Sub menu: see "USB Configuration" (page 118)
- ✓ **HD Audio Configuration**
Sub menu: see "HD Audio Configuration" (page 119)
- ✓ **PCH LAN Controller**
Options: Disabled / Enabled
- ✓ **Wake on LAN**
Options: Disabled / Enabled
- ✓ **SLP_LAN# Low on DC Power**
Options: Disabled / Enabled
- ✓ **Second LAN Controller**
Options: Disabled / Enabled
- ✓ **DeepSx Policies**
Options: Disabled / Enabled in S4-S5
- ✓ **LAN Wake From DeepSx**
Options: Disabled / Enabled
- ✓ **Wake on LAN**
Options: Disabled / Enabled
- ✓ **SLP_LAN# Low on DC Power**
Options: Disabled / Enabled

- ✓ **Second LAN Controller**
Options: Disabled / Enabled
- ✓ **LAN2 MAC address**
Options: none
- ✓ **CLKRUN# Logic**
Options: Disabled / Enabled
- ✓ **State After G3**
Options: S0 State / S5 State
- ✓ **Compatible Revision ID**
Options: Disabled / Enabled
- ✓ **PCH Cross Throttling**
Options: Disabled / Enabled
- ✓ **PCIe PII SSC**
Options: Auto / 0.0% / 0.1% / 0.2% / ... / 2.0%

4.4.2.1 PCI Express Configuration

Aptio Setup Utility - Copyright (C) 2017 American Megatrends, Inc.
Chipset

<pre> PCI Express Configuration PCI Express Clock Gating [Enabled] Peer Memory Write Enable [Disabled] Compliance Test Mode [Disabled] PCIe-USB Glitch W/A [Disabled] ▶ PCI Express Gen3 Eq Lanes ▶ PCI Express Root Port 1 PCIE Port 5 is assigned to LAN PCIE Port 6 is assigned to LAN2 ▶ PCI Express Root Port 7 ▶ PCI Express Root Port 8 ▶ PCI Express Root Port 9 PCIE Port 19 is assigned to PCIe to PCI Bridge </pre>	<pre> PCI Express Clock Gating Enabled/Disable for each root port. ---: Select Screen ↑↓: Select Item Enter: Select +/-: Change Opt. F1: General Help F2: Previous Values F3: Optimized Defaults F4: Save & Exit ESC: Exit </pre>
--	--

Version 2.18.1263. Copyright (C) 2017 American Megatrends, Inc.

- ✓ **PCI Express Clock Gating**
Options: Disabled / Enabled
- ✓ **Peer Memory Write Enable**
Options: Disabled / Enabled
- ✓ **Compliance Test Mode**
Options: Disabled / Enabled
- ✓ **PCIe-USB Glitch W/A**
Options: Disabled / Enabled
- ✓ **PCI Express Gen3 Eq Lanes**
Sub menu: see "PCI Express Gen3 Eq Lanes" (page 113)
- ✓ **PCI Express Root Port X**
Sub menu: see "PCI Express Root Port" (page 114)

4.4.2.1.1 PCI Express Gen3 Eq Lanes

Aptio Setup Utility - Copyright (C) 2017 American Megatrends, Inc.
Chipset

PCIE1	Cm	0
PCIE1	Cp	63
PCIE2	Cm	6
PCIE2	Cp	2
PCIE3	Cm	6
PCIE3	Cp	2
PCIE4	Cm	6
PCIE4	Cp	2
PCIE5	Cm	6
PCIE5	Cp	2
PCIE6	Cm	6
PCIE6	Cp	2
PCIE7	Cm	6
PCIE7	Cp	2
PCIE8	Cm	6
PCIE8	Cp	2
PCIE9	Cm	6
PCIE9	Cp	2
PCIE10	Cm	6
PCIE10	Cp	2
PCIE11	Cm	6
PCIE11	Cp	2
PCIE12	Cm	6
PCIE12	Cp	2
PCIE13	Cm	6

←: Select Screen
↑: Select Item
Enter: Select
+/-: Change Opt.
F1: General Help
F2: Previous Values
F3: Optimized Defaults
F4: Save & Exit
ESC: Exit

Version 2.18.1263. Copyright (C) 2017 American Megatrends, Inc.

- ✓ **PCIEX Cm**
Options: 0..63
- ✓ **PCIEX Cp**
Options: 0..63

4.4.2.1.2 PCI Express Root Port

Aptio Setup Utility - Copyright (C) 2017 American Megatrends, Inc.
Chipset

PCI Express Root Port 1	[Enabled]	▲ Control the PCI Express Root Port. ▼
Topology	[Unknown]	
ASPM	[Disabled]	
L1 Substates	[Disabled]	
Gen3 Eq Phase3 Method	[Software Search]	
UPTP	5	
DPTP	7	
ACS	[Enabled]	
URR	[Disabled]	
FER	[Disabled]	
NFER	[Disabled]	
CER	[Disabled]	
CTO	[Disabled]	
SEFE	[Disabled]	
SENF	[Disabled]	
SECE	[Disabled]	
PME SCI	[Enabled]	
Hot Plug	[Disabled]	
Advanced Error Reporting	[Enabled]	
PCIe Speed	[Auto]	
Transmitter Half Swing	[Disabled]	
Detect Timeout	0	
Extra Bus Reserved	0	
Reserved Memory	10	
Reserved I/O	4	

Version 2.18.1263. Copyright (C) 2017 American Megatrends, Inc.

- ✓ **PCI Express Root Port x**
Options: Disabled / Enabled
- ✓ **Topology**
Options: Unknown / x1 / x4 / SATA Express / M2
- ✓ **ASPM Support**
Options: Disabled / L0s / L1 / L0sL1 / Auto
- ✓ **L1 Substates**
Options: Disabled / L1.1 / L1.2 / L1.1 & L1.2
- ✓ **Gen3 Eq Phase3 Method**
Options: Hardware / Static Coeff. / Software Search
- ✓ **UPTP**
Options: 0..10
- ✓ **DPTP**
Options: 0..10
- ✓ **ACS**
Options: Enabled / Disabled
- ✓ **URR**
Options: Enabled / Disabled
- ✓ **FER**
Options: Enabled / Disabled
- ✓ **NFER**
Options: Enabled / Disabled

-
- ✓ **CER**
Options: Enabled / Disabled
 - ✓ **CTO**
Options: Enabled / Disabled
 - ✓ **SEFE**
Options: Enabled / Disabled
 - ✓ **SENF**
Options: Enabled / Disabled
 - ✓ **SECE**
Options: Enabled / Disabled
 - ✓ **PME SCI**
Options: Enabled / Disabled
 - ✓ **Hot Plug**
Options: Enabled / Disabled
 - ✓ **Advanced Error Reporting**
Options: Enabled / Disabled
 - ✓ **PCIe Speed**
Options: Auto / Gen1 / Gen2
 - ✓ **Transmitter Half Swing**
Options: Disabled / Enabled
 - ✓ **Detect Timeout**
Options: 0..65535
 - ✓ **Extra Bus Reserved**
Options: 0...7
 - ✓ **Reserved Memory**
Options: 1...20
 - ✓ **Prefetchable Memory**
Options: 1...20
 - ✓ **Reserved I/O**
Options: 4 / 8 / 12 / 16 / 20
 - ✓ **PCIe PCIE1 LTR**
Options: Disabled / Enabled
 - ✓ **Snoop Latency Override**
Options: Disabled / Manual / Auto
 - ✓ **Snoop Latency Value**
Options: 0..1023
 - ✓ **Snoop Latency Multiplier**
Options: 1 / 32 / 1024 / 32768 / 1048576 / 33554432 ns
 - ✓ **Non Snoop Latency Override**
Options: Disabled / Manual / Auto

-
- ✓ **Non Snoop Latency Value**
Options: 0..1023

 - ✓ **Non Snoop Latency Multiplier**
Options: 1 / 32 / 1024 / 32768 / 1048576 / 33554432 ns

 - ✓ **Force LTR Override**
Options: Disabled / Enabled

 - ✓ **PCIE1 LTR Lock**
Options: Disabled / Enabled

 - ✓ **PCIE1 CLKREQ Mapping Override**
Options: Default / No CLKREQ / Custom Number

 - ✓ **CLKREQ Number**
Options: 0..15

 - ✓ **Extra Options**
Sub menu: see "Extra Options" (page 117)

4.4.2.1.2.1 Extra Options

Aptio Setup Utility - Copyright (C) 2017 American Megatrends, Inc.
Chipset

Detect Non-Compliance Device	[Enabled]	▲	Detect Non-Compliance PCIoot Express Device. If enable, it will take more time at POST time.
Prefetchable Memory	[Unknown]		
Reserved Memory Alignment	[Disabled]		
Prefetchable Memory Alignment	[Disabled]		
			▼
			←: Select Screen
			↑: Select Item
			Enter: Select
			+/-: Change Opt.
			F1: General Help
			F2: Previous Values
			F3: Optimized Defaults
			F4: Save & Exit
			ESC: Exit

Version 2.18.1263. Copyright (C) 2017 American Megatrends, Inc.

- ✓ **Detect Non-Compliance Device**
Options: Disabled / Enabled
- ✓ **Prefetchable Memory**
Options: 1..20
- ✓ **Reserved memory Alignment**
Options: 1..31
- ✓ **Prefetchable Memory Alignment**
Options: 1..31

4.4.2.2 USB Configuration

Aptio Setup Utility - Copyright (C) 2017 American Megatrends, Inc.
Chipset

USB Configuration		▲ Options to disable Compliance Mode. Default is FALSE to not disable Compliance Mode. Set TRUE to disable Compliance Mode. ←: Select Screen ↑: Select Item Enter: Select +/-: Change Opt. F1: General Help F2: Previous Values F3: Optimized Defaults F4: Save & Exit ESC: Exit ▼
XHCI Disable Compliance Mode	[FALSE]	
USB Port Disable Override	[Select Per-Pin]	
USB SS Physical Connector #0	[Enabled]	
USB SS Physical Connector #1	[Enabled]	
USB SS Physical Connector #2	[Enabled]	
USB SS Physical Connector #3	[Enabled]	
USB SS Physical Connector #4	[Enabled]	
USB SS Physical Connector #5	[Enabled]	
USB HS Physical Connector #0	[Enabled]	
USB HS Physical Connector #1	[Enabled]	
USB HS Physical Connector #2	[Enabled]	
USB HS Physical Connector #3	[Enabled]	
USB HS Physical Connector #4	[Enabled]	
USB HS Physical Connector #5	[Enabled]	
USB HS Physical Connector #6	[Enabled]	
USB HS Physical Connector #7	[Enabled]	
USB HS Physical Connector #8	[Enabled]	
USB HS Physical Connector #9	[Enabled]	
USB HS Physical Connector #10	[Enabled]	
USB HS Physical Connector #11	[Enabled]	
USB HS Physical Connector #12	[Enabled]	

Version 2.18.1263. Copyright (C) 2017 American Megatrends, Inc.

- ✓ **XHCI Disable Compliance Mode**
Options: FALSE / TRUE
- ✓ **xDCI Support**
Options: Disabled / Enabled
- ✓ **USB Port Disable Override**
Options: Disabled / Select Per-Pin
- ✓ **USB SS Physical Connector #x**
Options: Disabled / Disabled
- ✓ **USB HS Physical Connector #x**
Options: Disabled / Disabled
- ✓ **USB Precondition**
Options: Disabled / Enabled

4.4.2.3 HD Audio Configuration

Aptio Setup Utility - Copyright (C) 2017 American Megatrends, Inc.
Chipset

<pre> HD Audio Subsystem Configuration Settings HD Audio [Disabled] </pre>	<pre> Control Detection of the HA-Audio device. Disabled = HDA will be unconditionally disabled Enabled = HDA will be unconditionally enabled Auto = HDA will be enabled if present, disabled otherwise. ----- ←: Select Screen ↑: Select Item Enter: Select +/-: Change Opt. F1: General Help F2: Previous Values F3: Optimized Defaults F4: Save & Exit ESC: Exit </pre>
---	---

Version 2.18.1263. Copyright (C) 2017 American Megatrends, Inc.

- ✓ **HD Audio**
Options: Disabled / Enabled / Auto
- ✓ **HDA-Link Codec Select**
Options: Platform Onboard / External Kit
- ✓ **iDisplay Audio Disconnect**
Options: Disabled / Enabled
- ✓ **PME Enable**
Options: Disabled / Enabled

4.5.1 Secure Boot Menu

Aptio Setup Utility - Copyright (C) 2017 American Megatrends, Inc.
Security

System Mode	Setup	Secure Boot activated when Platform Key(PK) is enrolled, System mode is User/Deployed, and CSM function is disabled.
Secure Boot	Not Active	
Vendor Key	Not Active	
Attempt Secure Boot	[Enabled]	
Secure Boot Mode	[Standard]	
▶ Key Management		
		→: Select Screen ↑↓: Select Item Enter: Select +/-: Change Opt. F1: General Help F2: Previous Values F3: Optimized Defaults F4: Save & Exit ESC: Exit

Version 2.18.1263. Copyright (C) 2017 American Megatrends, Inc.

- ✓ **Secure Boot Support**
Options: Disabled / Enabled
- ✓ **Secure Boot Mode**
Options: Standard / Custom
- ✓ **Key Management**
Sub menu: see "Key Management" (page 122)

4.5.1.1 Key Management

Aptio Setup Utility - Copyright (C) 2017 American Megatrends, Inc.
Security

<p>Provision Factory Default [Disabled]</p> <ul style="list-style-type: none"> ▶ Install Factory Default keys ▶ Enroll Efi Image ▶ Save all Secure Boot variables <table border="1" style="width: 100%; border-collapse: collapse;"> <thead> <tr> <th style="text-align: left;">Secure Boot variable</th> <th style="text-align: left;">Size</th> <th style="text-align: left;">Keys#</th> <th style="text-align: left;">Key Source</th> </tr> </thead> <tbody> <tr> <td>▶ Platform Key(PK)</td> <td>0</td> <td>0</td> <td>No Key</td> </tr> <tr> <td>▶ Key Exchange Keys</td> <td>0</td> <td>0</td> <td>No Key</td> </tr> <tr> <td>▶ Authorized Signatures</td> <td>0</td> <td>0</td> <td>No Key</td> </tr> <tr> <td>▶ Forbidden Signatures</td> <td>0</td> <td>0</td> <td>No Key</td> </tr> <tr> <td>▶ Authorized TimeStamps</td> <td>0</td> <td>0</td> <td>No Key</td> </tr> <tr> <td>▶ OsRecovery Signatures</td> <td>0</td> <td>0</td> <td>No Key</td> </tr> </tbody> </table>	Secure Boot variable	Size	Keys#	Key Source	▶ Platform Key(PK)	0	0	No Key	▶ Key Exchange Keys	0	0	No Key	▶ Authorized Signatures	0	0	No Key	▶ Forbidden Signatures	0	0	No Key	▶ Authorized TimeStamps	0	0	No Key	▶ OsRecovery Signatures	0	0	No Key	<p>Allow to provision factory default Secure Boot keys when System is in Setup Mode</p> <hr/> <p>←: Select Screen ↑: Select Item Enter: Select +/-: Change Opt. F1: General Help F2: Previous Values F3: Optimized Defaults F4: Save & Exit ESC: Exit</p>
Secure Boot variable	Size	Keys#	Key Source																										
▶ Platform Key(PK)	0	0	No Key																										
▶ Key Exchange Keys	0	0	No Key																										
▶ Authorized Signatures	0	0	No Key																										
▶ Forbidden Signatures	0	0	No Key																										
▶ Authorized TimeStamps	0	0	No Key																										
▶ OsRecovery Signatures	0	0	No Key																										

Version 2.18.1263. Copyright (C) 2017 American Megatrends, Inc.

- ✓ **Install Factory Defaults**
Options: Press [Enter]
- ✓ **Enroll Efi Image**
Options: Press [Enter]
- ✓ **Save All Secure Boot Variables**
Options: Press [Enter]
- ✓ **Platform Key(PK)**
Options: Set New Key
- ✓ **Key Exchange Keys**
Options: Set New Key / Append Key
- ✓ **Authorized Signatures**
Options: Set New Key / Append Key
- ✓ **Forbidden Signatures**
Options: Set New Key / Append Key
- ✓ **Authorized TimeStamps**
Options: Set New Key / Append Key
- ✓ **OsRecovery Signatures**
Options: Set New / Append

4.6 Boot

Aptio Setup Utility - Copyright (C) 2017 American Megatrends, Inc.
BOOT

Boot Configuration Setup Prompt Timeout 5 Bootup NumLock State [On] Full Screen Logo [Enabled] Fast Boot [Enabled] SATA Support [All Sata Devices] VGA Support [EFI Driver] USB Support [Partial Initial] PS2 Support [Enabled] NetWork Stack Driver Support [Disabled] Redirection Support [Disabled] New Boot Option Policy [Default] StartUpDelay for UEFI shell 5 Boot mode select [Legacy] FIXED BOOT ORDER Priorities Boot Option #1 [CFast/SSD] Boot Option #2 [Hard Disk] Boot Option #3 [CD/DVD] Boot Option #4 [Service Stick] Boot Option #5 [USB Stick] Boot Option #6 [USB Floppy] Boot Option #7 [USB Hard Disk] Boot Option #8 [USB CD/DVD]	▲ Number of 1/10 sec. to wait for setup activation key. 0 means no wait. ←: Select Screen ↑↓: Select Item Enter: Select +/-: Change Opt. F1: General Help F2: Previous Values F3: Optimized Defaults F4: Save & Exit ESC: Exit ▼
--	--

Version 2.18.1263. Copyright (C) 2017 American Megatrends, Inc.

- ✓ **Setup Prompt Timeout**
Options: 0...65535 [x 1/10 sec.]
- ✓ **Bootup NumLock State**
Options: On / Off
- ✓ **Full Screen Logo**
Options: Disabled / Enabled
- ✓ **Fast Boot**
Options: Disabled / Enabled
- ✓ **SATA Support**
Options: Last Boot HDD Only / All Sata Devices / HDD Only
- ✓ **VGA Support**
Options: Auto / EFI Driver
- ✓ **USB Support**
Options: Disabled / Full Initial / Partial Initial
- ✓ **PS2 Devices Support**
Options: Disabled / Enabled
- ✓ **NetWork Stack Driver Support**
Options: Disabled / Enabled
- ✓ **Redirection Support**
Options: Disabled / Enabled
- ✓ **New Boot Option Policy**
Options: Default / Place First / Place Last

- ✓ **StartUpDelay for UEFI shell**
Options: 0..255
- ✓ **Boot mode select**
Options: Legacy / UEFI / DUAL
- ✓ **Fixed Boot Order Priorities**
Options: Review or change the sequence of available boot devices
- ✓ **Advanced Fixed Boot Order Parameters**
Sub menu: see "Fixed Boot Order Priority" (page 125)

4.6.1 Fixed Boot Order Priority

Aptio Setup Utility - Copyright (C) 2017 American Megatrends, Inc.
 BOOT

Max. CFast/SSD capacity (GB)	200	Capacity limit for boot group CFast/SSD in GB
Max. USB Stick capacity /GB)	64	
		←: Select Screen ↑↓: Select Item Enter: Select +/-: Change Opt. F1: General Help F2: Previous Values F3: Optimized Defaults F4: Save & Exit ESC: Exit

Version 2.18.1263. Copyright (C) 2017 American Megatrends, Inc.

✓ **Max. CFast/SSD capacity (GB)**

Options: 1..16384

✓ **Max. USB Stick capacity (GB)**

Options: 1..16384

4.7 Save & Exit

Aptio Setup Utility - Copyright (C) 2017 American Megatrends, Inc.
SAVE & EXIT

<p>Save Changes and Reset Discard Changes and Reset</p> <p>Restore Optimized Defaults</p> <p>Boot Override IBA CL Slot 00FE v0105</p>	<p>Reset the system after saving the changes.</p> <hr/> <p>←→: Select Screen ↑↓: Select Item Enter: Select +/-: Change Opt. F1: General Help F2: Previous Values F3: Optimized Defaults F4: Save & Exit ESC: Exit</p>
---	---

Version 2.18.1263. Copyright (C) 2017 American Megatrends, Inc.

- ✓ **Save Changes and Reset**
Options: Press [Enter]
- ✓ **Discard Changes and Reset**
Options: Press [Enter]
- ✓ **Restore Defaults**
Options: Press [Enter]
- ✓ **Save as User Defaults**
Options: Press [Enter]
- ✓ **Restore User Defaults**
Options: Press [Enter]
- ✓ **Boot Override**
Options: Press [Enter]
- ✓ **IBA GE Slot 00C8 v1381**
Options: none

4.8 BIOS Update

If a BIOS update needs to be done, the program "DecdFlash" as well as a bootable medium which contains the newest BIOS version is used for this. It is important, that the program is started from a DOS environment without a virtual memory manager, for example "EMM386.EXE". In case such a memory manager is loaded, the program will stop with an error message.

DecdFlash is a program which provides automatic BIOS updates on any AMI-BIOS boards. All files need to be copied from the .zip-file in another directory.

The system may not be interrupted during the flash process, otherwise the update is stopped and the BIOS is destroyed afterwards.

The program should be started as follows:

```
DecdFlsh BIOS-Filename
```

After checking the name of the BIOS file and its length the BIOS will be programmed.

The flashing takes nearly 75 seconds. The firmware will get updated automatically.



Attention

A faulty BIOS update process may cause damages on the board!

Updating the BIOS in an improper way can render the board unusable. Therefore, you should only update the BIOS if you really need the changes/corrections which come with the new BIOS version.

Before you proceed to update the BIOS you need to make absolutely sure that you have the right BIOS file which was issued for the exact board and exact board revision that you wish to update. If you try to update the BIOS using the wrong file the board will not start up again.

5 Mechanical Drawings

	All dimensions are in mil (1 mil = 0,0254 mm).
Notice	

5.1 PCB: Mounting Holes

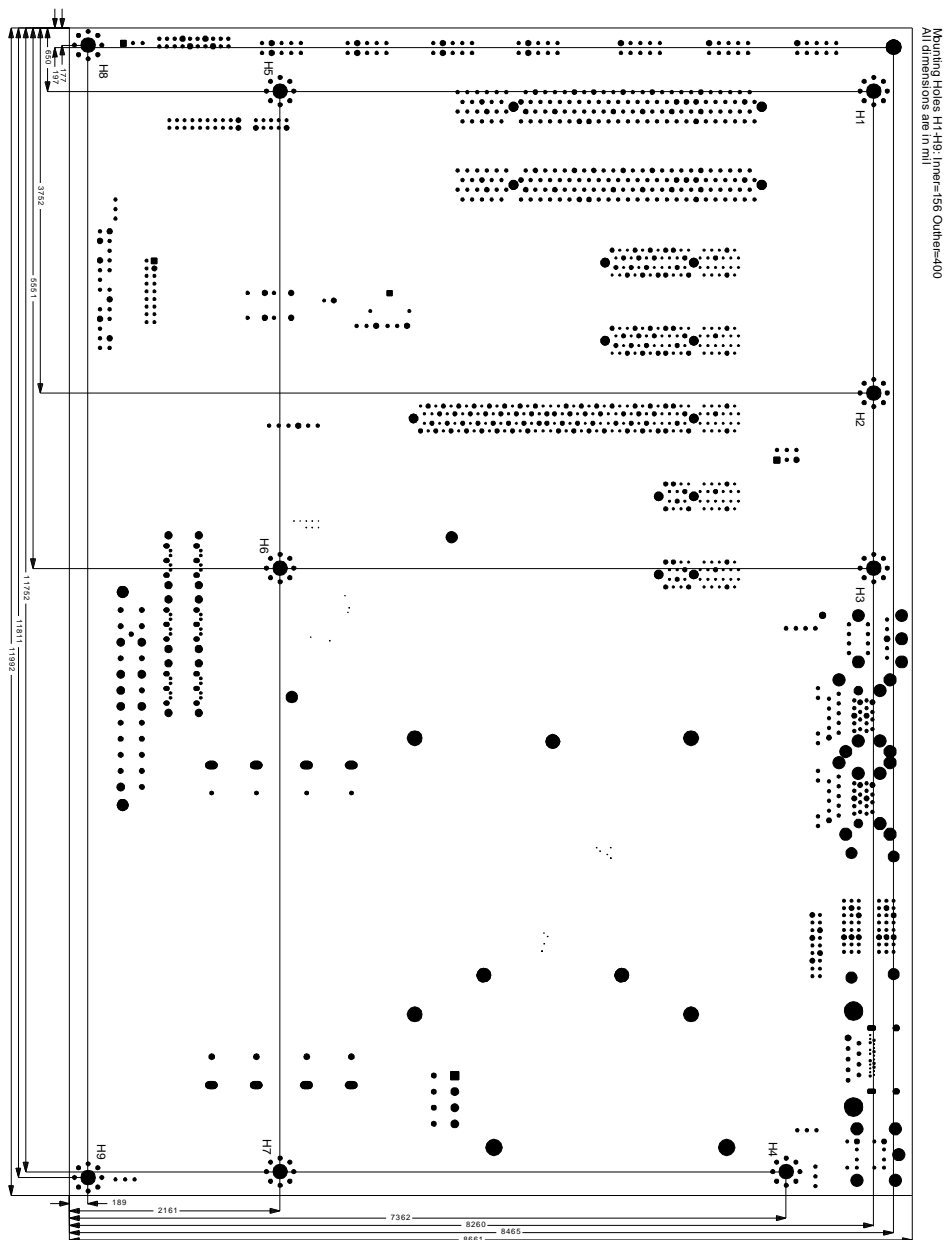

5.2 PCB: Dimensions

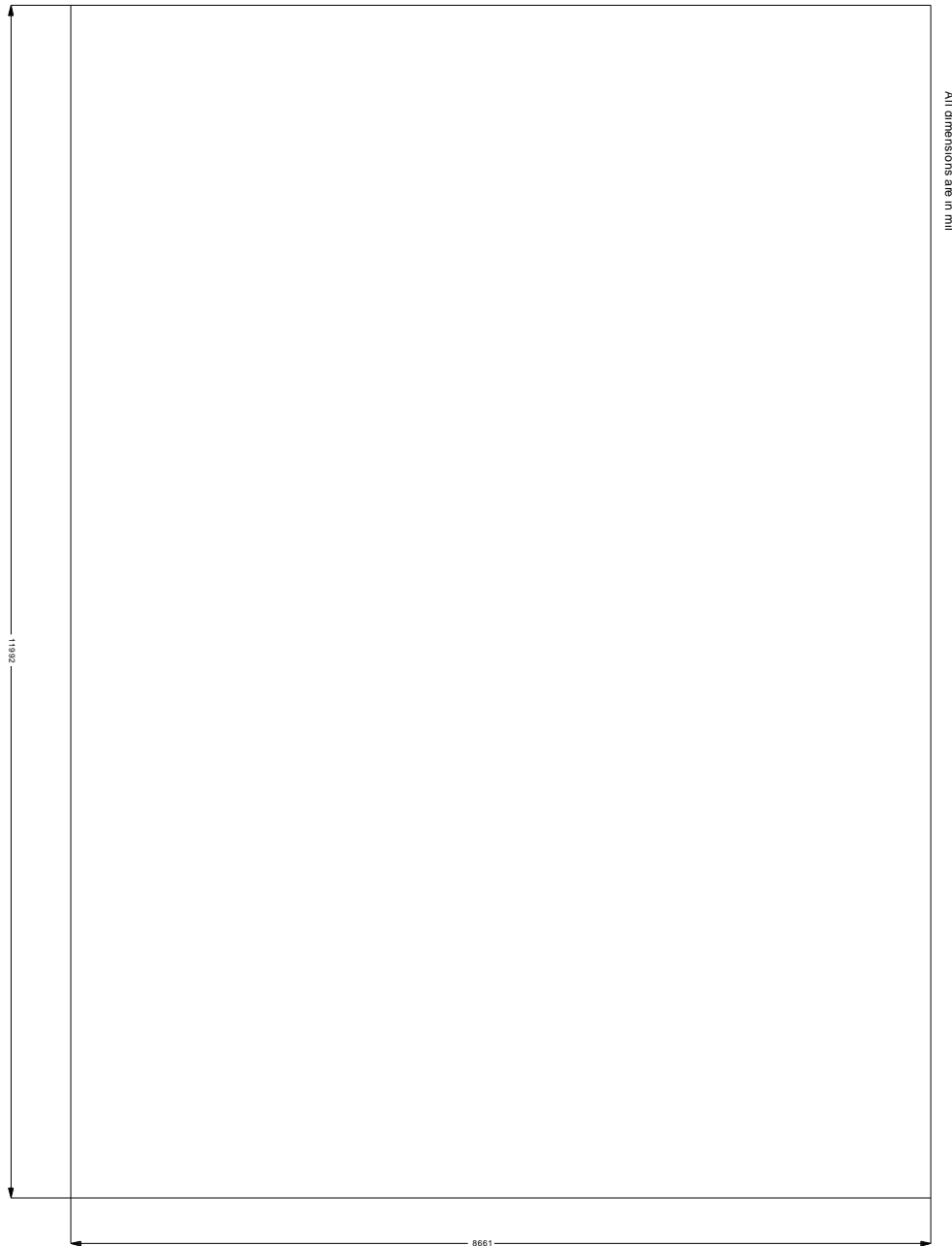

6 Technical Data

6.1 Electrical Data

Power Supply:

Board: ATX, including 2x2pin 12V connector
 RTC: ≥ 3 Volt

Electric Power Consumption:

Board: typically 10VA (CPU and expansion cards excluded)
 RTC: $\leq 10\mu\text{A}$

6.2 Environmental Conditions

Temperature Range:

Operating: 0°C to $+60^{\circ}\text{C}$ (extended temperature on request)
 Storage: -25°C up to $+85^{\circ}\text{C}$
 Shipping: -25°C up to $+85^{\circ}\text{C}$, for packaged boards

Temperature Changes:

Operating: 0.5°C per minute, 7.5°C per 30 minutes
 Storage: 1.0°C per minute
 Shipping: 1.0°C per minute, for packaged boards

Relative Humidity:

Operating: 5% up to 85% (non condensing)
 Storage: 5% up to 95% (non condensing)
 Shipping: 5% up to 100% (non condensing), for packaged boards

Shock:

Operating: 150m/s^2 , 6ms
 Storage: 400m/s^2 , 6ms
 Shipping: 400m/s^2 , 6ms, for packaged boards

Vibration:

Operating: 10 up to 58Hz, 0.075mm amplitude
 58 up to 500Hz, 10m/s^2
 Storage: 5 up to 9Hz, 3.5mm amplitude
 9 up to 500Hz, 10m/s^2
 Shipping: 5 up to 9Hz, 3.5mm amplitude
 9 up to 500Hz, 10m/s^2 , for packaged boards



Notice

Shock and vibration

Shock and vibration figures pertain to the motherboard alone and do not include additional components such as heat sinks, memory modules, cables etc.

6.3 Thermal Specifications

The board is specified to operate in an environmental temperature range from 0°C to +60°C (extended temperature on request). Maximum die temperature is 105°C. To keep the processor under this threshold an appropriate cooling solution needs to be applied. This solution has to take typical and maximum power consumption into account. The maximum power consumption may be twice as high and should be used as a basis for the cooling concept. Additional controllers may also affect the cooling concept. The power consumption of such components may be comparable to the consumption of the processor.

The board design includes thermal solution mounting points that will provide the best possible thermal interface between die and solution. Since we take thermal solutions seriously we have several advanced, aggressive cooling solutions in our product portfolio. Please contact your sales representative to order or discuss your thermal solution needs.

7 Support and Service

Beckhoff and their partners around the world offer comprehensive support and service, making available fast and competent assistance with all questions related to Beckhoff products and system solutions.

7.1 Beckhoff's Branch Offices and Representatives

Please contact your Beckhoff branch office or representative for local support and service on Beckhoff products.

The addresses of Beckhoff's branch offices and representatives around the world can be found on her internet pages: <http://www.beckhoff.com>

You will also find further documentation for Beckhoff components there.

7.2 Beckhoff Support

Support offers you comprehensive technical assistance, helping you not only with the application of individual Beckhoff products, but also with other, wide-ranging services:

- support
- design, programming and commissioning of complex automation systems
- and extensive training programs for Beckhoff system components

hotline: +49(0)5246/963-157
fax: +49(0)5246/963-9157
e-mail: support@beckhoff.com

7.3 Beckhoff Service

The Beckhoff Service Center supports you in all matters of after-sales service:

- on-site service
- repair service
- spare parts service
- hotline service

hotline: +49(0)5246/963-460
fax: +49(0)5246/963-479
e-mail: service@beckhoff.com

7.4 Beckhoff Headquarters

Beckhoff Automation GmbH & Co. KG
Eiserstr. 5
33415 Verl
Germany

phone: +49(0)5246/963-0
fax: +49(0)5246/963-198
e-mail: info@beckhoff.com
web: www.beckhoff.com

I Annex: Post-Codes

During boot, the BIOS generates a sequence of status codes (so-called "POST codes"), which can be viewed using a special output device (POST code card). The meaning of these codes is described in the document "Aptio™ 4.x Status Codes" by American Megatrends®, which can be downloaded from their website <http://www.ami.com>. The following additional OEM POST codes are generated:

Code	Description
87h	BIOS-API started
88h	PCA9535 started
89h	PWRCTRL-Firmware started

II Annex: Resources

Interrupt

The used resources depend on setup settings.

The listed interrupts and their use are given through AT compatibility.

If interrupts must exclusively be available on the ISA side, they have to be reserved through the BIOS setup. The exclusivity is not given and not possible on the PCI side.

Address	Function
IRQ0	Timer
IRQ1	PS/2 Keyboard
IRQ2 (9)	
IRQ3	COM1
IRQ4	COM2
IRQ5	
IRQ6	
IRQ7	
IRQ8	RTC
IRQ9	
IRQ10	COM4
IRQ11	COM3
IRQ12	PS/2 Mouse
IRQ13	FPU
IRQ14	
IRQ15	

PCI Devices

All listed PCI devices exist on the board. Some PCI devices or functions of devices may be disabled in the BIOS setup. Once a device is disabled other devices may get PCI bus numbers different from the ones listed in the table.

AD	INTA	REQ	Bus	Dev.	Fkt.	Kontroller / Slot
-	-	-	0	00	0	Host Bridge
A	-	-	0	02	0	VGA Controller ID1912
A	-	-	0	08	0	System Peripheral ID1911
A	-	-	0	20	0	XHCI Controller IDA12F
A	-	-	0	20	2	Other DPIO Module IDA131
A	-	-	0	22	0	Serial Other IDA13A
A	-	-	0	22	3	Serial (16550) IDA13D
B	-	-	0	23	0	SATA (AHCI 1.0) IDA102
A	-	-	0	27	0	PCI Bridge IDA167
B	-	-	0	27	2	PCI Bridge IDA169
C	-	-	0	28	0	PCI Bridge IDA110
D	-	-	0	28	5	PCI Bridge IDA115
B	-	-	0	31	0	ISA Bridge IDA146
A	-	-	0	31	2	Memory Controller IDA121
A	-	-	0	31	3	HDA IDA170
C	-	-	0	31	4	SMBus Controller IDA123
A	-	-	0	31	6	Ethernet Controller ID1587
A	-	-	2	00	0	PCI Bridge IDE111

AD	INTA	REQ	Bus	Dev.	Fkt.	Kontroller / Slot
	A	-	5	00	0	Ethernet Controller x1 ID1533

Ressourcen: SMB-Devices

The following table contains all reserved SM-Bus device addresses in 8-bit notation. Note that external devices must not use any of these addresses even if the component mentioned in the table is not present on the motherboard.

Address	Function
34-35	API access to PSU
36-39	Reserved
40-41	GPIO
5C-5D	NCT7491
60-6F	Reserved for DDR4
70-73	POST-Code output
88-89	BIOS-defined slave address
92-93	i210 default
A0-A7	Reserved for DDR4
B0-B3	Power-Controller (access by BIOS-API)
B8-BB	Power-Controller (access by BIOS-API)