

**BECKHOFF** New Automation Technology

Manual | EN

# Push-button extension for 7-inch "Economy" built-in Panel

C9900-G070 and C9900-G071





# Table of contents

<b>1 Foreword</b> .....	<b>5</b>
1.1 Notes on the documentation .....	5
1.2 For your safety .....	5
1.3 Notes on information security.....	7
<b>2 Transport and unpacking</b> .....	<b>8</b>
<b>3 Product description</b> .....	<b>9</b>
3.1 Product overview.....	9
3.2 Options.....	10
3.3 Intended use .....	11
3.4 Accessing the connections.....	11
3.4.1 C9900-G070 connections .....	11
3.4.2 C9900-G071 connections .....	14
3.5 Accessories.....	16
3.5.1 Push-button caps and labels.....	16
<b>4 Mounting</b> .....	<b>17</b>
4.1 Installing the labels.....	17
4.2 Installing the Wago picoMax® connector system .....	18
<b>5 TwinCAT System Manager</b> .....	<b>19</b>
<b>6 Dimensional drawing</b> .....	<b>20</b>
6.1 Dimensional drawing CP6x06 with C9900-G070 or C9900-G071 .....	20
<b>7 Technical data</b> .....	<b>22</b>
<b>8 Support and Service</b> .....	<b>24</b>



# 1 Foreword

## 1.1 Notes on the documentation

This description is intended exclusively for trained specialists in control and automation technology who are familiar with the applicable national standards.

For installation and commissioning of the components, it is absolutely necessary to observe the documentation and the following notes and explanations.

The qualified personnel is obliged to always use the currently valid documentation.

The responsible staff must ensure that the application or use of the products described satisfies all requirements for safety, including all the relevant laws, regulations, guidelines, and standards.

### Disclaimer

The documentation has been prepared with care. The products described are, however, constantly under development.

We reserve the right to revise and change the documentation at any time and without notice.

No claims to modify products that have already been supplied may be made on the basis of the data, diagrams, and descriptions in this documentation.

### Trademarks

Beckhoff®, TwinCAT®, TwinCAT/BSD®, TC/BSD®, EtherCAT®, EtherCAT G®, EtherCAT G10®, EtherCAT P®, Safety over EtherCAT®, TwinSAFE®, XFC®, XTS® and XPlanar® are registered and licensed trademarks of Beckhoff Automation GmbH.

If third parties make use of designations or trademarks used in this publication for their own purposes, this could infringe upon the rights of the owners of the said designations.

### Patents

The EtherCAT Technology is covered, including but not limited to the following patent applications and patents:

EP1590927, EP1789857, EP1456722, EP2137893, DE102015105702  
and similar applications and registrations in several other countries.

## EtherCAT®

EtherCAT® is registered trademark and patented technology, licensed by Beckhoff Automation GmbH, Germany

### Copyright

© Beckhoff Automation GmbH & Co. KG, Germany.

The distribution and reproduction of this document as well as the use and communication of its contents without express authorization are prohibited.

Offenders will be held liable for the payment of damages. All rights reserved in the event that a patent, utility model, or design are registered.

## 1.2 For your safety

### Safety regulations

Read the following explanations for your safety.

Always observe and follow product-specific safety instructions, which you may find at the appropriate places in this document.

**Exclusion of liability**

All the components are supplied in particular hardware and software configurations which are appropriate for the application. Modifications to hardware or software configurations other than those described in the documentation are not permitted, and nullify the liability of Beckhoff Automation GmbH & Co. KG.

**Personnel qualification**

This description is only intended for trained specialists in control, automation, and drive technology who are familiar with the applicable national standards.

**Signal words**

The signal words used in the documentation are classified below. In order to prevent injury and damage to persons and property, read and follow the safety and warning notices.

**Personal injury warnings****⚠ DANGER**

Hazard with high risk of death or serious injury.

**⚠ WARNING**

Hazard with medium risk of death or serious injury.

**⚠ CAUTION**

There is a low-risk hazard that could result in medium or minor injury.

**Warning of damage to property or environment****NOTICE**

The environment, equipment, or data may be damaged.

**Information on handling the product**

This information includes, for example:  
recommendations for action, assistance or further information on the product.

## 1.3 Notes on information security

The products of Beckhoff Automation GmbH & Co. KG (Beckhoff), insofar as they can be accessed online, are equipped with security functions that support the secure operation of plants, systems, machines and networks. Despite the security functions, the creation, implementation and constant updating of a holistic security concept for the operation are necessary to protect the respective plant, system, machine and networks against cyber threats. The products sold by Beckhoff are only part of the overall security concept. The customer is responsible for preventing unauthorized access by third parties to its equipment, systems, machines and networks. The latter should be connected to the corporate network or the Internet only if appropriate protective measures have been set up.

In addition, the recommendations from Beckhoff regarding appropriate protective measures should be observed. Further information regarding information security and industrial security can be found in our <https://www.beckhoff.com/secguide>.

Beckhoff products and solutions undergo continuous further development. This also applies to security functions. In light of this continuous further development, Beckhoff expressly recommends that the products are kept up to date at all times and that updates are installed for the products once they have been made available. Using outdated or unsupported product versions can increase the risk of cyber threats.

To stay informed about information security for Beckhoff products, subscribe to the RSS feed at <https://www.beckhoff.com/secinfo>.

## 2 Transport and unpacking

Note the specified transport and storage conditions (see Chapter 8, Technical data)

Despite the robust design of the unit, the components are sensitive to strong vibrations and impacts. During transport the device must therefore be protected from mechanical stress. Appropriate packaging of the Control Panel, in particular the original packaging, can improve the vibration resistance during transport.

### NOTICE

#### Hardware damage due to condensation

Unfavorable weather conditions during transport can cause damage to the device.

- Protect the device against moisture (condensation) during transport in cold weather or in case of extreme temperature fluctuations.
- Do not put the device into operation until it has slowly adjusted to the room temperature.
- Should condensation occur, wait for about 12 hours before switching the device on.

#### Unpacking

Proceed as follows to unpack the device:

1. Check the packaging for transport damage
2. Remove packaging.
3. Keep the packaging for possible future transport.
4. Check your delivery for completeness by comparing it with your order.
5. Check the contents for visible shipping damage.
6. In case of discrepancies between the package contents and the order, or in case of transport damage, please inform Beckhoff Service (see Chapter 10.1 Support and Service)



## 3 Product description

### 3.1 Product overview



CP6x06

The C9900-G07x push button extensions add an emergency stop and three illuminated push buttons to the "Economy" built-in panel PCs and control panels.

The push button extension can be ordered ex factory for all control panels and panel PCs of the "Economy" family in size 7-inch (CP6606, CP6706 and CP6906).

#### C9900-G070 (USB version)

The actuation of the emergency stop and other push buttons is transferred to the controller via USB and can be read with TwinCAT. Optionally, customers may use the signals for additional purposes.

- The emergency stop S1 has two normally closed contacts and one normally open contact. The normally open contact operates on a pulse basis and does not establish a permanent contact. The signal of the normally open contact is transferred to the controller. The two normally closed contacts can be used by the customer.
- The push buttons S2 (green) and S4 (blue) each actuate two normally open contacts, of which one is relayed to the controller and one is available as a potential-free contact for use by the customer.
- The push button S3 (red) actuates a normally closed contact and a normally open contact. The normally open contact is relayed to the controller, the normally closed contact is available as a potential-free contact for use by the customer.
- The indicator lamps are only controlled via USB.
- All terminal strips are pluggable.

#### C9900-G071 (hard-wired version)

The actuation of the emergency stop and push buttons is only queried via the terminal strip.

- The emergency stop S1 actuates two normally closed contacts.
- The push buttons S2 (green) and S4 (blue) each actuate two normally open contacts.
- The push button S3 (red) actuates two normally closed contacts.
- The indicator lamps can be controlled via the terminal strip. In this case, an additional 24 V<sub>DC</sub> power supply is required at terminal strips X3.1 and X3.2.
- All terminal strips are pluggable.

By default, the push buttons are delivered with green, red and blue push button caps. Other push button cap color options are available for retrofitting (see chapter [Accessories](#) |▶ 16|).

A label sheet with 54 pre-punched button labels is available under order code C9900-Z260. Application is explained in chapter [Installing the labels](#) [▶ 17].

## 3.2 Options

Options	Description
C9900-G070	Push-button extension for CP6x06 with horizontal 7-inch display <ul style="list-style-type: none"> <li>• push-button extension on the bottom side</li> <li>• 3 push-button with signal lamp, type RAFI RAFIX 22FS+, round, 30 mm</li> <li>• 1 emergency stop, type RAFI RAFIX 22FS+</li> <li>• Labels for push-button caps for individual marking of each push-button can be ordered as an option.</li> <li>• The emergency stop is wired with two normally-closed contacts, the red push-button with one normally-closed contact and the remaining push-buttons each with one normally-open contact to a terminal row.</li> <li>• Additionally, all push-buttons are transmitted with a normally-open contact via USB.</li> <li>• The LEDs of the push-buttons are controlled via USB only.</li> </ul>
C9900-G071	Push-button extension for CP6x06 with horizontal 7-inch display <ul style="list-style-type: none"> <li>• push-button extension on the bottom side</li> <li>• 3 push-button with signal lamp, type RAFI RAFIX 22FS+, round, 30 mm</li> <li>• 1 emergency stop, type RAFI RAFIX 22FS+</li> <li>• Labels for push-button caps for individual marking of each push-button can be ordered as an option.</li> <li>• The emergency stop and the red push-button are wired each with two normally-closed contacts to a terminal row. The remaining push-buttons are wired each with two normally-open contacts to a terminal row.</li> <li>• The LEDs of the push-buttons are wired to a terminal row.</li> </ul>

### 3.3 Intended use

The C9900-G0xx built-in Panels with push-button extension are designed for industrial use in machine and plant engineering applications. The push-button extension is located below the touchscreen.

<b>NOTICE</b>	
	<p><b>Risk of explosion</b></p> <p>The built-in Panels must not be used in potentially explosive atmospheres.</p>

### 3.4 Accessing the connections

The connections of the push-button extension for use by the customer are located at the bottom of the housing.

The following table provides information on which conductors and wire cross-sections you can use for the connections.

Table 1: Overview conductors

Conductor	Wire cross-section
Solid conductor	0,2 to 1,5 mm <sup>2</sup>
Stranded conductor, with ferrules, with plastic collar	0,25 to 0,75 mm <sup>2</sup>
Stranded conductor, with ferrules, without plastic collar	0,25 to 1,5 mm <sup>2</sup>

#### 3.4.1 C9900-G070 connections

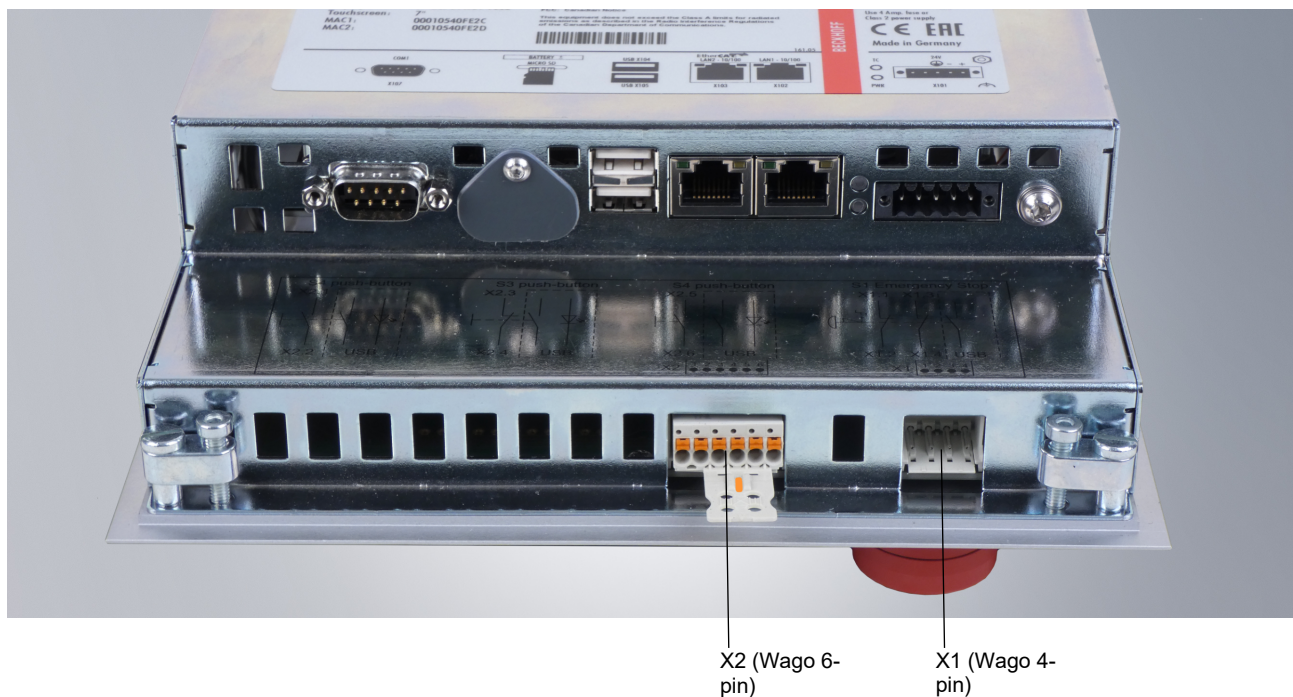

**3.4.1.1 C9900-G070 circuit diagram**

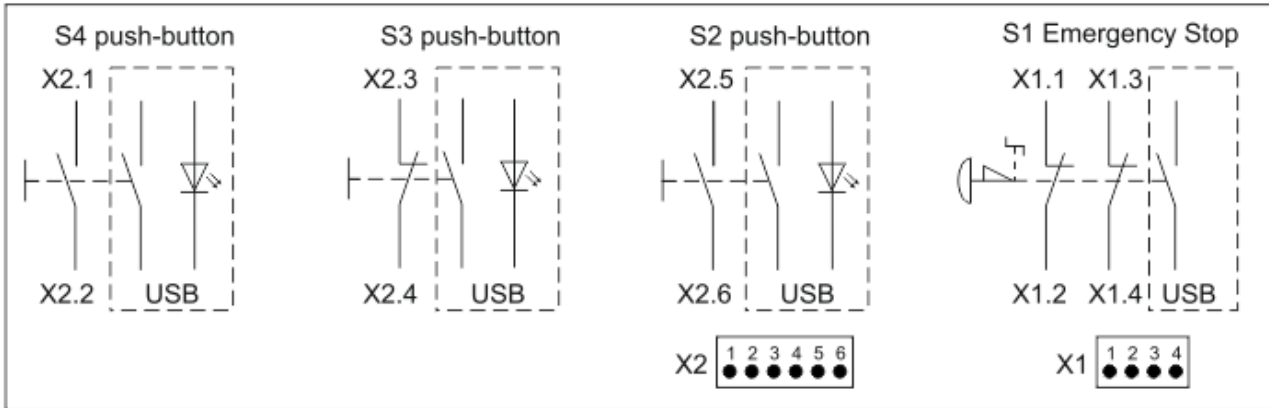



Fig. 1: C9900-G070

**3.4.1.2 Description of the C9900-G070 connections**

Connection strip	Terminal point	Description
X1	1	X1.1 NO contact emergency stop
	2	X1.2 NO contact emergency stop
	3	X1.3 NO contact emergency stop
	4	X1.4 NO contact emergency stop

Connection strip	Terminal point	Description
X2	1	X2.1 NO contact S4 blue
	2	X2.2 NO contact S4 blue
	3	X2.3 NC contact S3 red
	4	X2.4 NC contact S3 red
	5	X2.5 NO contact S2 green
	6	X2.6 NO contact S2 green

<b>NOTICE</b>	
	<p><b>Electrical characteristic values of the operating elements</b></p> <p>The electrical characteristic values of the emergency stop and push-button contacts must not be exceeded. (see chapter <a href="#">Technical data</a> [<a href="#">▶</a> 22])</p>

### 3.4.2 C9900-G071 connections

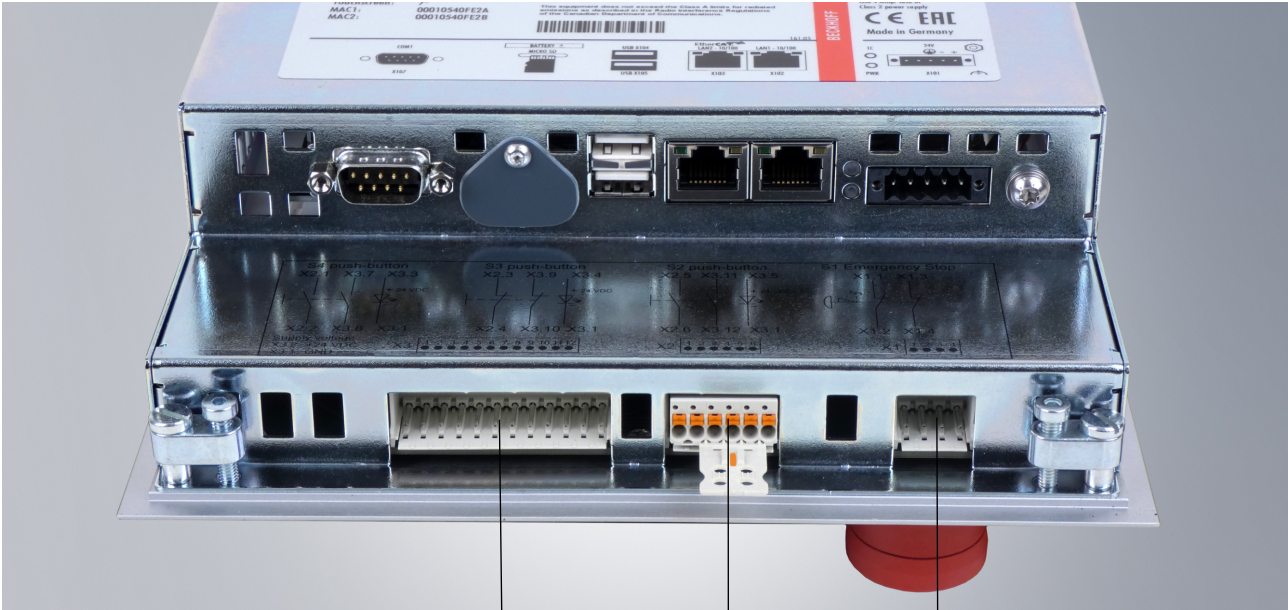

X3 (Wago 12-pin)

X2 (Wago 6-pin)

X1 (Wago 4-pin)

#### 3.4.2.1 C9900-G071 circuit diagram

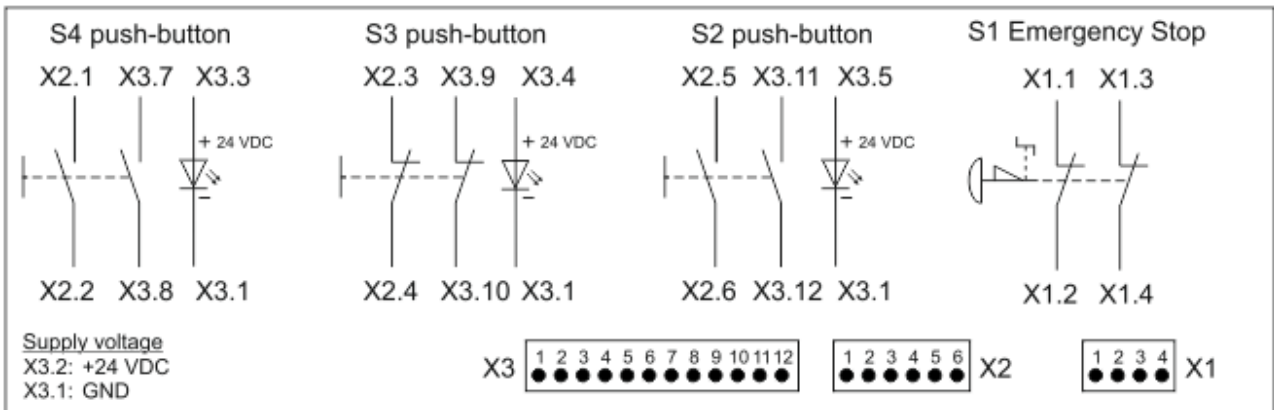

Fig. 2: C9900-G071

**3.4.2.2 Description of the C9900-G071 connections**

Connection strip	Terminal point	Description
X1	1	X1.1 NO contact emergency stop
	2	X1.2 NO contact emergency stop
	3	X1.3 NO contact emergency stop
	4	X1.4 NO contact emergency stop

Connection strip	Terminal point	Description
X2	1	X2.1 NO contact S4 blue
	2	X2.2 NO contact S4 blue
	3	X2.3 NC contact S3 red
	4	X2.4 NC contact S3 red
	5	X2.5 NO contact S2 green
	6	X2.6 NO contact S2 green

Connection strip	Terminal point	Description
X3	1	GND Supply Power
	2	+24 V <sub>DC</sub> Supply Power
	3	X3.3 + 24 V LED blue
	4	X3.4 + 24 V LED red
	5	X3.5 + 24 V LED green
	6	N.C.
	7	X3.7 NO contact S4 blue
	8	X3.8 NO contact S4 blue
	9	X3.9 NC contact S3 red
	10	X3.10 NC contact S3 red
	11	X3.11 NO contact S2 green
	12	X3.12 NO contact S2 green

**NOTICE**



**Electrical characteristic values of the operating elements**

The electrical characteristic values of the emergency stop and push-button contacts must not be exceeded. (see chapter [Technical data](#) [► 22])

## 3.5 Accessories

### 3.5.1 Push-button caps and labels

Options	Description
C9900-Z255	Push-button cap (blue) for individual application to a C9900-G0xx push-button extension, type Rafi FS+, diameter: 22.3 mm, 5 pcs.
C9900-Z256	Push-button cap (yellow) for individual application to a C9900-G0xx push-button extension, type Rafi FS+, diameter: 22.3 mm, 5 pcs.
C9900-Z257	Push-button cap (green) for individual application to a C9900-G0xx push-button extension, type Rafi FS+, diameter: 22.3 mm, 5 pcs.
C9900-Z258	Push-button cap (red) for individual application to a C9900-G0xx push-button extension, type Rafi FS+, diameter: 22.3 mm, 5 pcs.
C9900-Z259	Push-button cap (clear) for individual application to a C9900-G0xx push-button extension, type Rafi FS+, diameter: 22.3 mm, 5 pcs.
C9900-Z260	Transparent film for individual labeling of a C9900-G0xx- push-button extension, type Rafi FS+, diameter: 22.3 mm, 1 sheet DIN A4, 54 pcs.



## 4 Mounting

### 4.1 Installing the labels

The blank label sheets for the push-buttons of the push-button extension offered under order code C9900-Z260 can be printed with a conventional office printer and then inserted in the push-button extension.

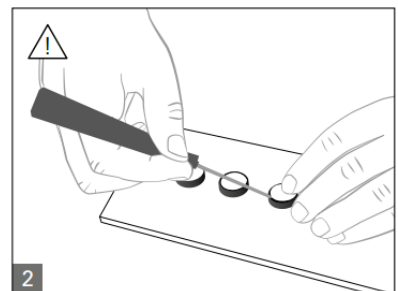
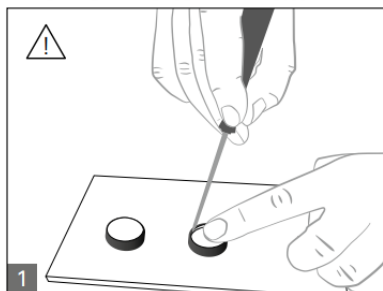
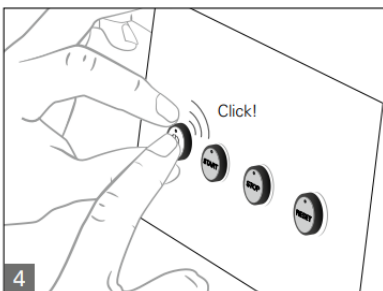
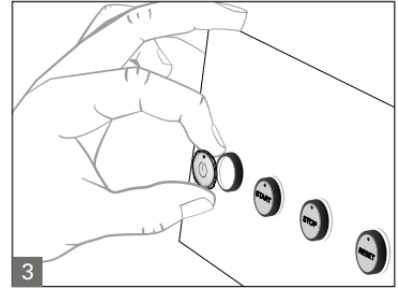
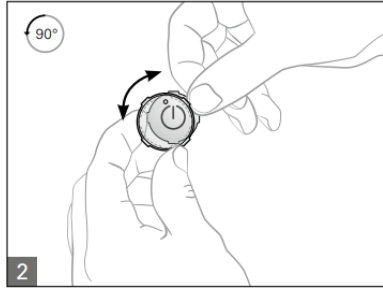
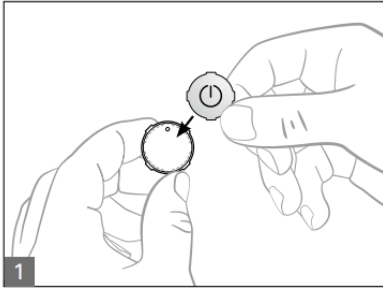

## 4.2 Installing the Wago picoMax® connector system

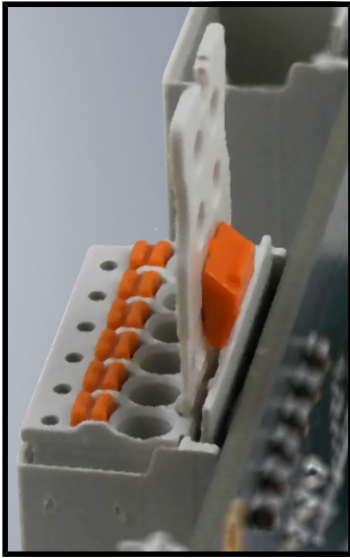

Plugged connection consists of male connector and female connector with grip plate and release slide

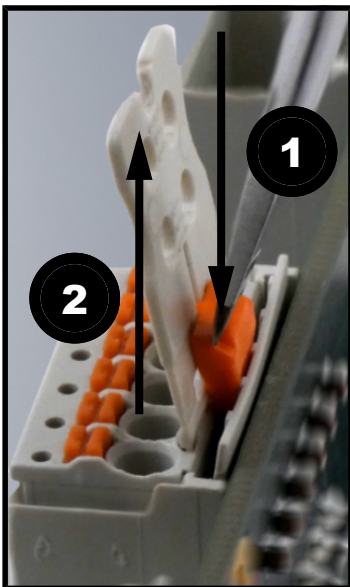

Disconnect the plug connection with the release slide.

1. Open the locking device (latch) by pushing down the release slide on the grip plate.
2. Pull out the female connector with the grip plate from the male connector.

## 5 TwinCAT System Manager

Before the push-button extension can be put into operation, it must first be configured in the TwinCAT System Manager.

**Proceed as follows:**

1. Click at the top in the menu on **File > New > Project** and create a new **TwinCAT XAE Project**.
2. In the tree view on the left, click on **I/O** and then right-click on **Device**.
3. In the context menu click on **Scan**.

The **New I/O Devices** window appears. All available devices are displayed.

4. Select the devices you want to use and confirm the selection with **OK**.
5. Confirm the request with **Yes**, in order to look for boxes.
6. Confirm the request whether to enable **FreeRun** with **Yes**.  
 ⇒ The device is inserted as a box in the tree view and displayed with the respective inputs and outputs (e.g. Term 2 to 5). Label the inputs and outputs (Term 2 to 5) as follows.

Term label after activating FreeRun	Term label after processing

## 6 Dimensional drawing

### 6.1 Dimensional drawing CP6x06 with C9900-G070 or C9900-G071

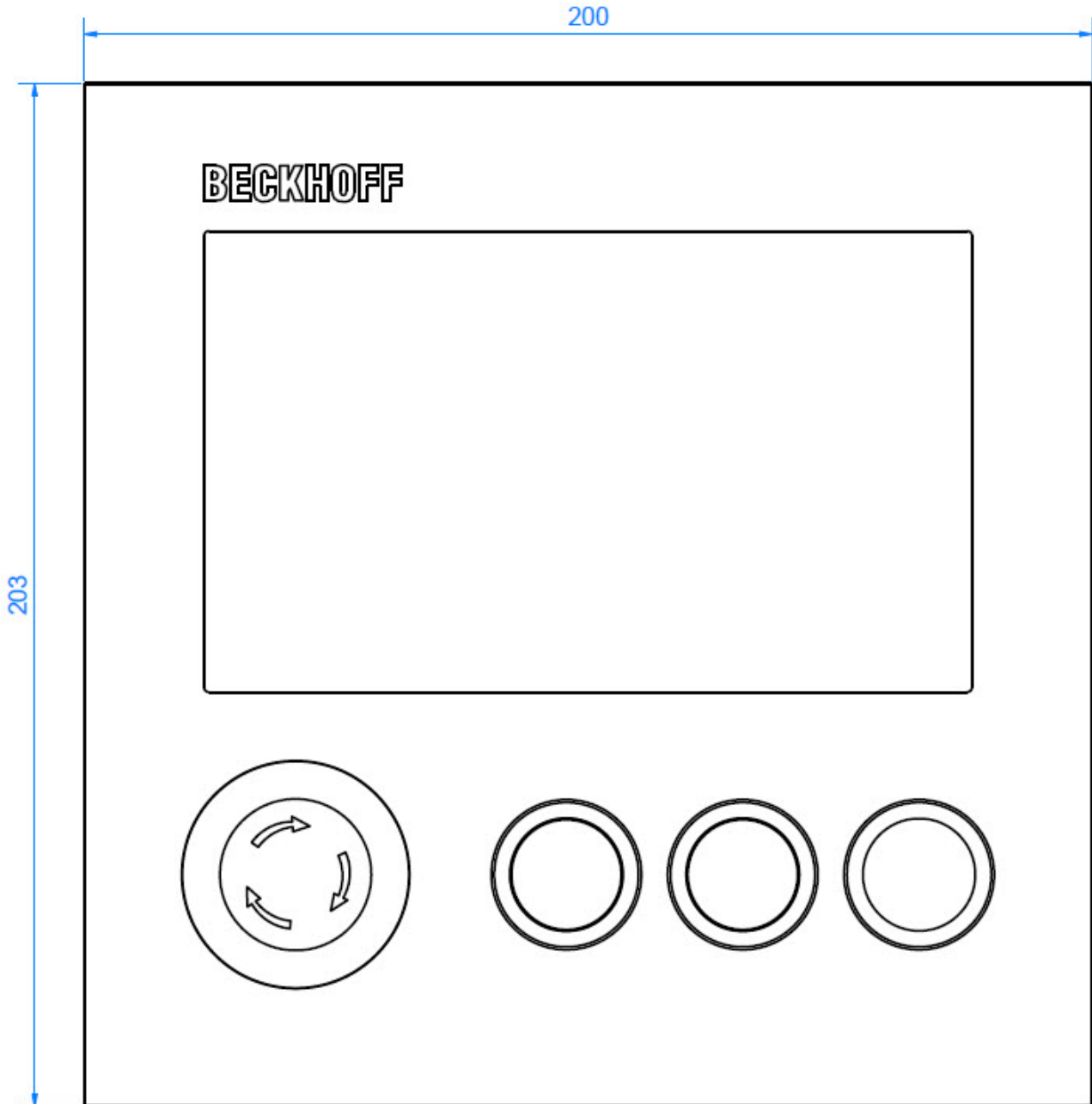

Fig. 3: External dimension

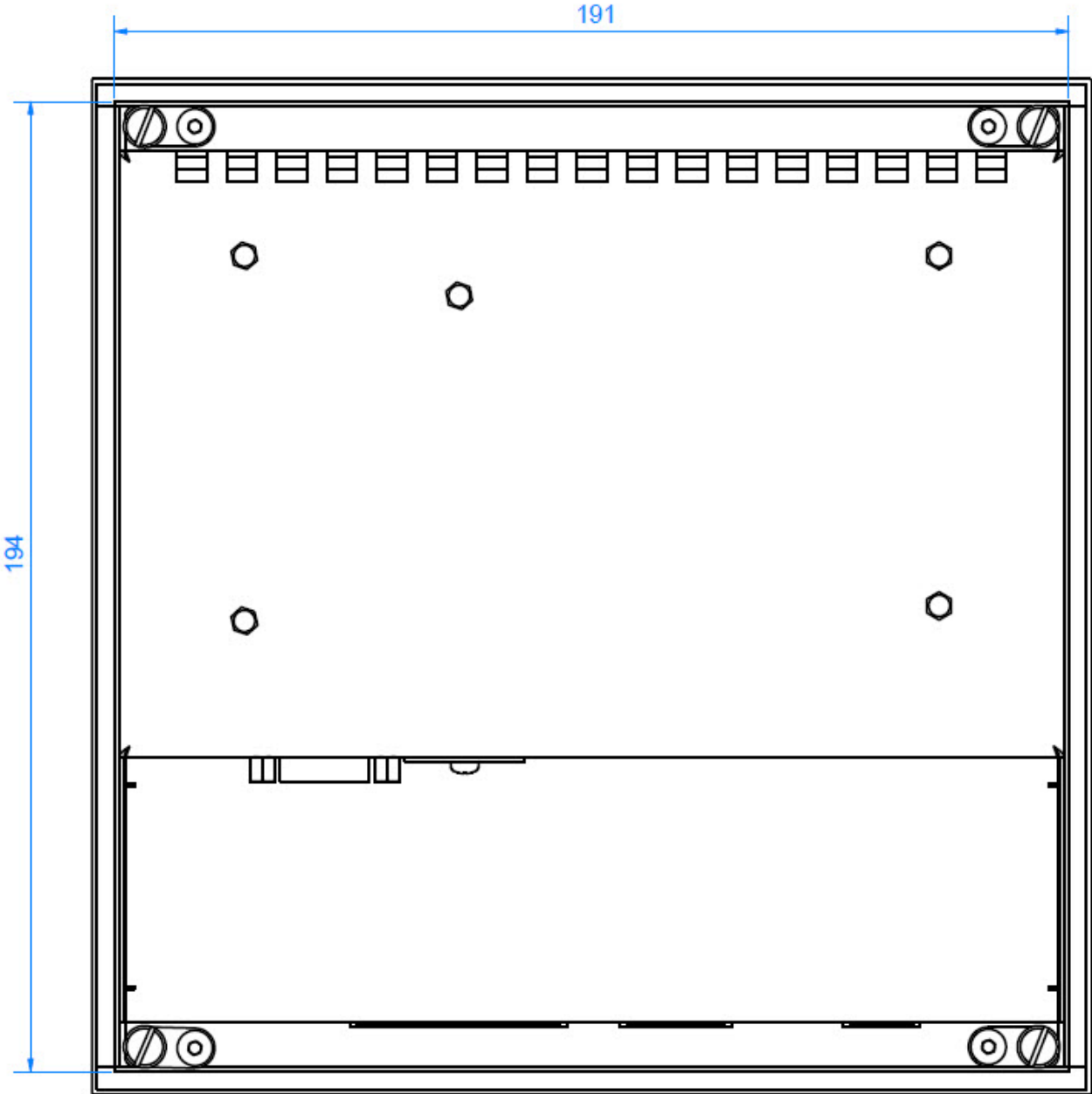

Fig. 4: Installation dimension

## 7 Technical data

**NOTICE**



**Risk of explosion!**

The built-in panels with push button extension must not be used in hazardous areas!

Product designation	C9900-G070/-G071	
Operating temperature	0...55 °C	
Shock resistance (sinusoidal vibration)	EN 60068-2-6:	10 to 58 Hz: 0.035 mm 58 to 500 Hz: 0.5 G (~ 5 m/s <sup>2</sup> )
	Shock resistance (shock)	EN 60068-2-27: 5 G (~50 m/s <sup>2</sup> ), duration: 30 ms
Protection rating	Front IP54, rear IP20	
Supply voltage	24 V <sub>DC</sub> (20.4 – 28.8 V <sub>DC</sub> )	
Min. operating voltage AC/DC	5 V	
Max. operating voltage AC/DC	35 V	
Min. operating current AC/DC	1 mA	
Max. operating current AC/DC	100 mA	
Switching capacity max.	250 mW	
EMC interference immunity	conforms to EN 61000-6-2	
EMC interference emission	conforms to EN 61000-6-4	
Permissible relative air humidity	Maximum 95%, no condensation	
Certifications	CE, UL	
Max. cable length	30 m	

Table 2: Characteristic values emergency stop and push buttons

Properties	Description	
Min. operating current AC/DC	1 mA	
Max. operating current AC/DC	100 mA	
Switching capacity max.	250 mW	
Protection rating	IP65	
Emergency stop type	1.30.273.512/0030 Rafi 22FS+	
	The emergency stop is reset by rotating.	
	Lifetime	50,000 cycles
	B10 value	65,000 cycles
Switching element (emergency stop)	1.20.126.414/0000 Rafi FS	
	1 x normally open contact / 2 x normally closed contact	
	Lifetime	1 million cycles at 10 mA / 24 V DC
	B10 value	65,000 cycles
Illuminated push button type	9.30.270.027/1500 Rafi 22FS+	Green
	9.30.270.027/1300 Rafi 22FS+	Red
	9.30.270.027/1600 Rafi 22FS+	Blue
	9.30.270.027/1000 Rafi 22FS+	Clear
	Lifetime	1,000,000 cycles
	B10 value	1,300,000 cycles
	Switching element (buttons)	1.20.126.003/9000
1 x normally open contact / 1 x normally closed contact		
1.20.126.005/9000		
2 x normally open contact		
1.20.126.004/9000		
2 x normally closed contact		
	Lifetime	1,000,000 cycles
	B10 value	1,300,000 cycles

## 8 Support and Service

Beckhoff and their partners around the world offer comprehensive support and service, making available fast and competent assistance with all questions related to Beckhoff products and system solutions.

### Download finder

Our [download finder](#) contains all the files that we offer you for downloading. You will find application reports, technical documentation, technical drawings, configuration files and much more.

The downloads are available in various formats.

### Beckhoff's branch offices and representatives

Please contact your Beckhoff branch office or representative for [local support and service](#) on Beckhoff products!

The addresses of Beckhoff's branch offices and representatives round the world can be found on our internet page: [www.beckhoff.com](http://www.beckhoff.com)

You will also find further documentation for Beckhoff components there.

### Beckhoff Support

Support offers you comprehensive technical assistance, helping you not only with the application of individual Beckhoff products, but also with other, wide-ranging services:

- support
- design, programming and commissioning of complex automation systems
- and extensive training program for Beckhoff system components

Hotline: +49 5246 963-157  
e-mail: [support@beckhoff.com](mailto:support@beckhoff.com)

### Beckhoff Service

The Beckhoff Service Center supports you in all matters of after-sales service:

- on-site service
- repair service
- spare parts service
- hotline service

Hotline: +49 5246 963-460  
e-mail: [service@beckhoff.com](mailto:service@beckhoff.com)

### Beckhoff Headquarters

Beckhoff Automation GmbH & Co. KG

Huelshorstweg 20  
33415 Verl  
Germany

Phone: +49 5246 963-0  
e-mail: [info@beckhoff.com](mailto:info@beckhoff.com)  
web: [www.beckhoff.com](http://www.beckhoff.com)





Beckhoff Automation GmbH & Co. KG  
Hülshorstweg 20  
33415 Verl  
Germany  
Phone: +49 5246 9630  
[info@beckhoff.com](mailto:info@beckhoff.com)  
[www.beckhoff.com](http://www.beckhoff.com)