



Installation and Operating instructions for

Built-in Control Panel CP66xx

Version: 1.3

Date: 2009-12-04

BECKHOFF

Table of contents

1. General Notes	2
Notes on the documentation	2
Liability conditions	2
Description of safety symbols	2
Basic safety measures	3
Operator's obligation to exercise diligence	4
Operator requirements	4
2. Product Description	5
Appropriate Use	5
Interfaces	5
Pin assignment	5
Connector description	6
Serial interface	6
USB interfaces	6
Network interfaces	6
Power supply	6
Ground connection	6
Status-LEDs	6
3. Installation Instructions	7
Transport and Unpacking	7
Transport	7
Unpacking	7
Assembly	8
Assembly dimensions	8
Mounting of the Control Panel	10
Fitting the cable	11
Material for assembling the connectors	11
Assembling the connectors	11
Connecting the Control Panel	12
Connecting cables	12
Earthing measures	12
4. Operating Instructions	13
Functional description	13
On-board Memory	13
Keyboard codes	14
Servicing and maintenance	16
Cleaning the Control Panel	16
Replacing the battery on the motherboard	16
Servicing	16
Emergency procedures	16
Shutting down	16
Disposal	16
5. Troubleshooting	17
Fault correction	17
Beckhoff Support & Service	18
Beckhoff branches and partner companies	18
Beckhoff Headquarters	18
Beckhoff Support	18
Beckhoff Service	18
6. Appendix	19
Technical data	19
Approvals	19
FCC: Federal Communications Commission Radio Frequency Interference Statement	19
FCC: Canadian Notice	19

General Notes

Notes on the documentation

This description is only intended for the use of trained specialists in control and automation engineering who are familiar with the applicable national standards. It is essential that the following notes and explanations are followed when installing and commissioning these components.

Liability conditions





The responsible staff must ensure that the application or use of the products described satisfy all the requirements for safety, including all the relevant laws, regulations, guidelines and standards.

The documentation has been prepared with care. The products described are, however, constantly under development. For this reason, the documentation may not always have been fully checked for consistency with the performance data, standards or other characteristics described. None of the statements in this manual represent a guarantee for as set out in § 443 of the German Civil Code or a statement about the assumed use according to the contract as set out in § 434 para. 1 clause 1 no. 1 of the German Civil Code. In the event that it contains technical or editorial errors, we retain the right to make alterations at any time and without warning. No claims for the modification of products that have already been supplied may be made on the basis of the data, diagrams and descriptions in this documentation.



© This documentation is protected by copyright. Any reproduction or third party use of this publication, whether in whole or in part, without the written permission of Beckhoff Automation GmbH, is forbidden.

Description of safety symbols

The following safety symbols are used in this operating manual. They are intended to alert the reader to the associated safety instructions.

 DANGER	<p>Serious risk of injury!</p> <p>Failure to follow the safety instructions associated with this symbol directly endangers the life and health of persons.</p>
 WARNING	<p>Risk of injury!</p> <p>Failure to follow the safety instructions associated with this symbol endangers the life and health of persons.</p>
 CAUTION	<p>Danger for persons!</p> <p>Failure to follow the safety instructions associated with this symbol may endanger persons.</p>
 Attention	<p>Danger for the environment or equipment</p> <p>Failure to follow the safety instructions associated with this symbol may endanger the environment or equipment.</p>
 Note	<p>Tip or pointer</p> <p>This symbol indicates information that contributes to better understanding.</p>

Basic safety measures

 <p>Attention</p>	<p>Switch off all parts of the equipment, then uncouple the fieldbus</p> <p>Before opening the control panel housing, and whenever the control panel is not being used for control purposes (such as during functional checks after a repair), all parts of the equipment must first be switched off, after which the control panel is to be disconnected from the equipment.</p> <p>Disconnect the device by unplugging the connectors on the Control Panel side.</p> <p>Items of equipment that have been switched off must be secured against being switched on again.</p>
 <p>DANGER</p>	<p>High Voltage!</p> <p>Displays used for the control panel's LC-display are operated with a voltage of up to 1000 V, depending on type. For that reason:</p> <p>The supply voltage must be disconnected before the housing of the Control Panel is opened.</p>
 <p>Attention</p>	<p>Avoid assembly work during operation</p> <p>Assembly work on the Control Panel during operation may damage the panel:</p> <ul style="list-style-type: none">• if metal objects such as screws or tools fall onto operating circuit boards• if connecting cables internal to the control panel are removed or inserted during operation.

Operator's obligation to exercise diligence

The operator must ensure that

- the Control Panel is only used for its intended purpose (see [Product Description](#) section);
- the Control Panel is only operated in a sound condition and in working order;
- the instruction manual is in good condition and complete, and always available for reference at the place of installation of the Control Panel;
- the Control Panel is operated, maintained and repaired only by suitably qualified and authorized personnel.
- the personnel is instructed regularly about relevant occupational safety and environmental protection aspects, and is familiar with the operating manual and in particular the safety notes contained herein.
- none of the safety and warning notes attached to the Control Panel are removed, and all notes remain legible.

National regulations depending on the machine type

Depending on the type of machine and plant in which the Control Panel is used, national regulations governing the controllers of such machines will apply, and must be observed by the operator. These regulations cover, amongst other things, the intervals between inspections of the controller.

The operator must initiate such inspections in good time.

Procedure in the event of a fault

In the event of faults at the Control Panel, the list in the section [Troubleshooting](#) can be used to determine the measures to be taken.

Operator requirements

Read the operating instructions

Anyone who uses the Control Panel must have read these operating instructions.

Software knowledge

Every user must be familiar with all the functions of the software installed on the Control Panel to which he has access.

Product Description

Appropriate Use

The CP66xx Control Panel is designed for industrial application in machine and plant engineering. A steel plate housing with aluminum front contains a TFT display, touch screen/ pad (optional) and a PC keyboard (optional). The Control Panel is installed in the front of control cabinets.

Do not use the Control Panel in areas of explosive hazard

The Control Panel must not be used where there is a risk of explosion.

Interfaces to the CP6607 with 5,7" display

Interfaces

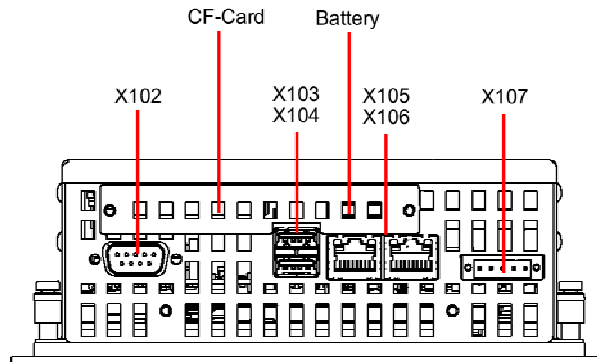

Interfaces to the CP66xx with 12", 15" und 19" display

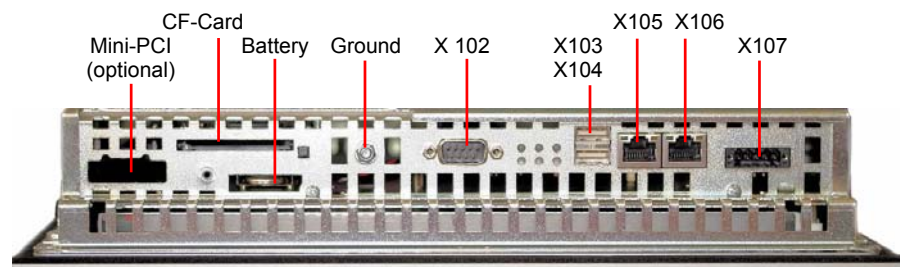

Mini-PCI-Slot (optional), CF-Card, Battery

The Mini-PCI-Slot (optional), the CF-Card and the Battery are located behind a cover which is fixed with a screw.

Pin assignment

X 102
Serial interface



D-SUB plug 9-pin (RS 232)

Pin	Signal	Pin	Signal
1	CD	6	DSR
2	RxD	7	RTS
3	TxD	8	CTS
4	DTR	9	RI
5	GND		

X103, X104
USB out



X103

X104

USB Type-A twin circuit board mounting (FCI 72309-0030B USB Double Receptacle A-Type)

Pin	Signal	Pin	Signal
1	5V	3	D+
2	D-	4	GND

X 105, X 106
Network



RJ-45 connector (Ethernet 10/ 100 MBit)

Pin	Signal	Pin	Signal
Housing	Screen	5	n.c.
1	TD+	6	RD-
2	TD-	7	n.c.
3	RD+	8	n.c.
4	n.c.		

X107
Power



Socket 5-pol RM3.50 Sw Screw Clamp
BL3.5/180F (WEIDMÜLLER 1615810000)

Pin	Function	
1	NC	
2	NC	
3	⊕	
4	-	24 V DC
5	+	Power Supply

Connector description

Serial interface

X102
Serial interface COM1

The Control Panel is equipped with a COM1 (**X 102**) serial interface (Type RS232) for the connection of serial peripheral devices.

USB interfaces

X103
USB out

The USB interface (**X 103**) (connector type A) is used for connecting peripheral devices with USB connection (e.g. keyboard, mouse). USB 1.1 standard is supported.

X104
USB out

The USB interface (**X104**) (connector type A) is used for connecting peripheral devices with USB connection. USB 2.0 standard is supported.

Network interfaces

X105, X106
Network

The RJ-45 sockets (**X 105, X 106**) enable connection of the Control Panel to a 10/ 100 MBit Ethernet network.

Power supply

X107
Power

The power supply for the Control Panel is established via the socket (**X 107**).

Ground connection

Ground connection

The Control Panel is grounded via the stud bolt.

Status-LEDs

Description of the Status-LEDs

The Status-LEDs are located near the connectors:

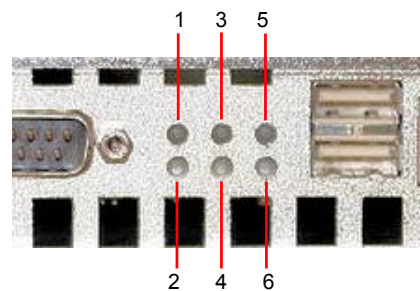

Fieldbus (1):	run
Fieldbus (2):	error
HDD (3):	active
User (4):	Can be defined by user
Not connected (5):	-
24 V in (6):	Power Supply is established

Installation Instructions

Please also refer to chapter [General Notes](#).

Transport and Unpacking

The specified storage conditions must be observed (see chapter [Technical data](#)).

Transport

Despite the robust design of the unit, the components are sensitive to strong vibrations and impacts. During transport, your Control Panel should therefore be protected from excessive mechanical stress. Therefore, please use the original packaging.



Attention

Danger of damage to the unit

If the device is transported in cold weather or is exposed to extreme variations in temperature, make sure that moisture (condensation) does not form on or inside the device.

Prior to operation, the unit must be allowed to slowly adjust to room temperature. Should condensation occur, a delay time of approximately 12 hours must be allowed before the unit is switched on.

Unpacking

Proceed as follows to unpack the unit:

1. Remove packaging.
2. Do not discard the original packaging. Keep it for future relocation.
3. Check the delivery for completeness by comparing it with your order.
4. Please keep the associated paperwork. It contains important information for handling the unit.
5. Check the contents for visible shipping damage.
6. If you notice any shipping damage or inconsistencies between the contents and your order, you should notify Beckhoff Service.

Assembly

Assembly dimensions

 <p>Attention</p>	<p>Notice mounting orientation</p> <p>The assembly of the unit must take place with the orientation diagrammed here.</p>
---	---

All dimensions are in mm.

*Control Panel
CP6607
with 5,7" display*

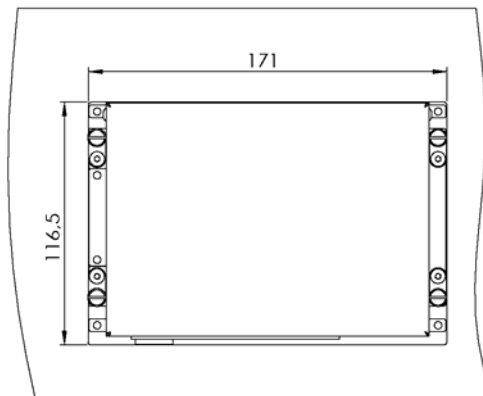

rear view with cutout dimensions

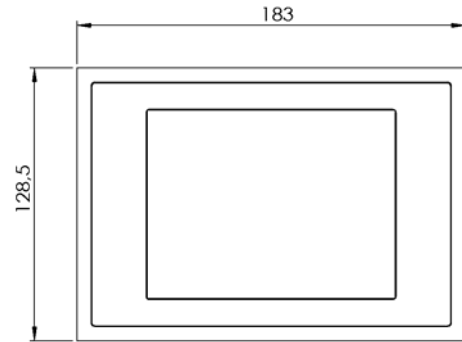

front view

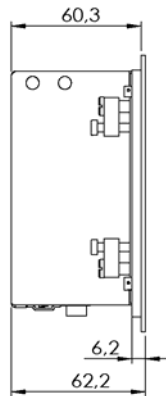

side view

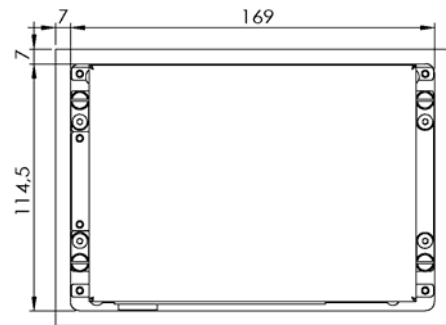

rear view

 Attention	<p>Notice mounting orientation</p> <p>The assembly of the unit must take place with the orientation diagrammed here.</p>
---	---

Control Panel CP66xx

All dimensions are in mm.

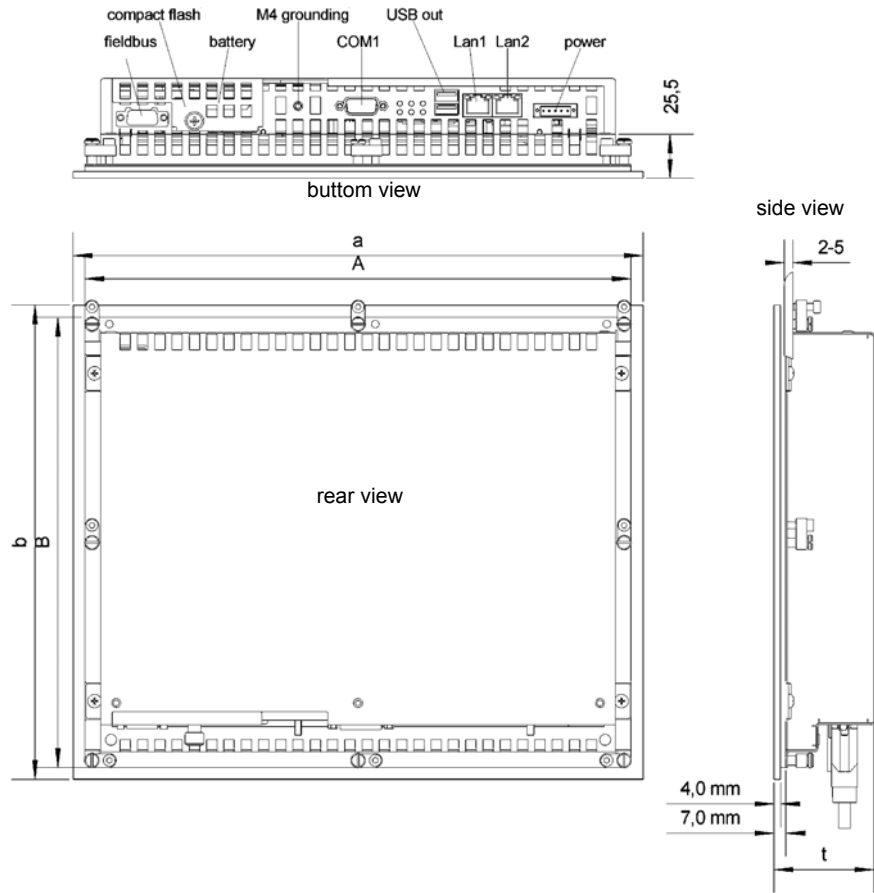

Dimensions CP660x		a	b	t	A	B
CP6609	6,5"-Display	240	175	55	226	161
CP6601	12"-Display	330	275	58	316	261
CP6602	15"-Display	380	315	59	366	301
CP6603	19"-Display	455	390	67	441	376

Dimensions CP661x		a	b	t	A	B
CP6619	6,5"-Display	272,3	221	55	258,3	207
CP6611	12"-Display	372,2	342,2	58	358,2	328,2
CP6612	15"-Display	430,4	403	59	416,4	389
CP6613	19"-Display	508,4	463	67	494,4	449

Dimensions CP662x		a	b	t	A	B
CP6629	6,5"-Display	340,4	221	55	326,4	207
CP6621	12"-Display	414	336	58	400	322
CP6621-0002	12"-Display	444,2	336	58	430,2	322
CP6622	15"-Display	519,4	378,2	59	505,4	364,2
CP6623	19"-Display	567,4	434	67	553,4	420

Dimensions CP663x		a	b	t	A	B
CP6631	12"-Display	410,4	378,2	58	396,4	364,2
CP6631-0002	12"-Display	430,4	378,2	58	416,4	364,2
CP6632	15"-Display	489,4	418,2	59	475,4	404,2
CP6633	19"-Display	508,4	543	67	494,4	529

Mounting of the Control Panel

Please refer to the tables for Control Panel cutout dimensions.

Mounting of the Control Panel

Clamping levers



Release clamping levers,

Insert the Control Panel into the cutout.

Release the clamping levers with a No. 2.5 Allen key.

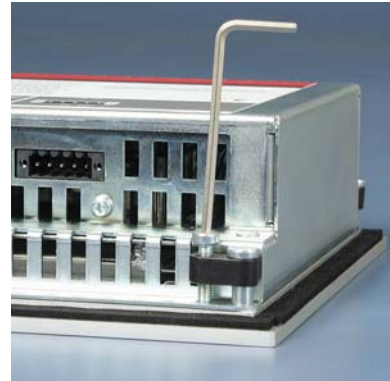

Folding them out

Turn the clamping levers to the side through 90°

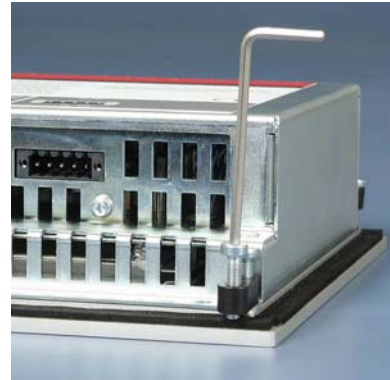

and retighten them.

and retighten the screws.



Fitting the cable

Wiring

Fit the cables for the power supply of the Industrial PC, using the included material for assembling the connectors.

Material for assembling the connectors

Material for assembling the connectors

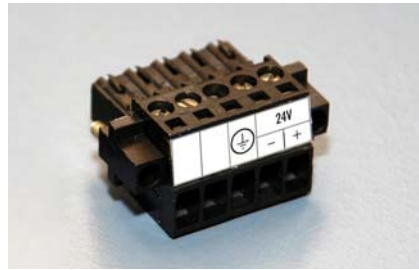

Plug connector 5-pole

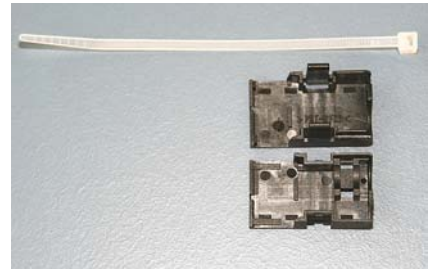

Stain relief housing with lacing cord

Assembling the connectors

Conductive cross-section

The connector is specified for 16 A and can lift conductive cross-sections until 1.5 mm².

Fitting the connector to the cable

So the connector is fitted to the cable:

1. Strip insulation from the cable ends (Length of stripped conductor is 8 - 9 mm).
2. Screw together the cable ends in the 5-pole plug connector in accordance with wiring diagram.

Applying the strain relief

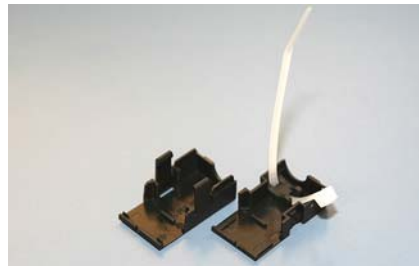

Thread the lacing cord into that lower part of the stain relief housing.

Putting in the plug connector





Put the plug connector into that lower part of the stain relief housing. Tighten the lacing cord and pinch off the plastic strap.

Fixing the upper part of the stain relief housing



Fix the upper part of the stain relief housing by snapping it onto the lower part.

Connecting the Control Panel

 <p>DANGER</p>	<p>Risk of explosion!</p> <p>The Control Panel must never be connected or disconnected in an area that is subject to explosion hazard!</p>
 <p>Attention</p>	<p>Mains plug</p> <p>The mains plug of the Control Panel must be disconnected!</p> <p>Please read the documentation for the external devices prior to connecting them.</p> <p>During thunderstorms, plug connector must neither be inserted nor removed.</p> <p>When disconnecting a plug connector, always handle it at the plug. Do not pull the cable!</p>

Connecting cables

The connections are located at the rear of the Control Panel and are documented in the [Product Description](#) section.

When connecting cables to the Control Panel, please adhere to the following order:

- Disconnect the Control Panel from the power supply
- Connect all cables at the Control Panel and at the devices to be connected
- Ensure that all screw connections between connectors and sockets are tight!
- Reconnect all devices to the power supply.

Earthing measures

Earthing connections dissipate interference from external power supply cables, signal cables or cables.

Connect the earth point on the Control Panel housing to the central earthing point with a low resistance connection. The earthing connection is located at the rear of the housing (see photograph on the left).

Earthing measures



Operating Instructions

Please also refer to chapter [General Notes](#).

Functional description

Switch on

The Control Panel does not have its own mains power switch. As soon as the power supply is switched on the control panel is activated.

Switching off

Control software, as typically applied in Control Panels, enables the assignment of different rights to all users. A user who is not entitled to shut down the software may not switch off the Control Panel as an attempt to shut it down when the software is running could result in the loss of software data on the Compact Flash memory card (CF card).

If the control panel is shut down while the software is writing a file onto the CF card, the file will be destroyed. Control software typically writes something to the CF card every few seconds, so that the probability of causing damage by switching off while the software is running is very high.

Operation

The Control Panel's membrane keypad may only be actuated by fingertips.

 Attention	<p>Do not operate with objects</p> <p>Attempts to actuate it with other objects can easily result in the destruction of the device. Neither may the membrane keypad be operated with a touch screen pen.</p>
---	---

The touch screen may only be actuated by finger tips or with the touch screen pen. The operator may wear gloves but there must be no hard particles such as metal shavings, glass splinters embedded in the glove.

On-board Memory

On-board memory

Integrated Industrial PCs with Intel® IXP420 XScale® technology and 533 MHz clock frequency are fitted with 128 MB on-board RAM und 32 MB on-board flash memory. The on-board memory can not be upgraded.

 Note	<p>Please note when using the on-board memory:</p> <ul style="list-style-type: none"> • Do not use 100% of the available memory capacity for applications. • Regard that the displayed time for copying data can be exceeded when writing great data volume. • Avoid cyclic writing to the memory.
--	--

Keyboard codes

Type-dependent number of keys

Depending on the precise type, the Control Panel can have fewer keys than those described here.

Operation



The cursor is the blinking character that marks the point at which the next character entered will be displayed. The cursor is also known as the insertion point. The cursor keys each move the cursor one place in the associated direction.



The Home key moves the cursor to the beginning of the line, while the End key moves it to the end of the line.



The *Pg Up* key scrolls one page back, the *Pg Dn* key scrolls one page forward.



The Tab key takes the cursor to the next input field, while Shift and Tab moves to the previous input field.



The mouse cursor can be moved over the screen with the aid of the touch screen or of the touch pad (optional). The keys correspond to the left and right hand keys of a Microsoft mouse.



The *Del* key deletes the character to the right of the cursor.



The *Ins* key causes characters to the right of the cursor to be overwritten. The overwrite mode is cancelled by pressing the key again.



Print-Screen prints a hard copy of a text screen on the printer.



The Pause key stops the computer until another key is pressed (only under MS-DOS).



Your input is confirmed with the Enter key.



Backspace deletes the character to the left of the cursor.



If the Shift key is pressed at the same time as another key, then instead of the numbers you obtain the character printed above the number, and you obtain upper case letters instead of lower case letters.



Pressing the *Caps Lock* key once activates and locks the *Shift* key. Pressing the *Shift* key cancels this function.



Rather like the effect of the *Shift* key, *Ctrl* and *Alt* also change the meaning of another key that is pressed at the same time.



This key brings up the Start menu of the operating system in use (Windows 95, 98, ME, NT, 2000, XP).



Pressing this key opens the property sheet of the active (or marked) object.



The *Esc* key has the effect of closing dialog windows and of interrupting some of the computer's working operations.



All other keys bring the character printed on them onto the display at the position of the cursor.



The meaning of the function keys, *F1* to *F10*, is determined by the software and is displayed at the bottom edge of the display.



The function of the special keys above the display is also determined by the software. The function is displayed at the top edge of the display. The special keys each have an orange LED controlled by the software.

Servicing and maintenance

Please also refer to chapter [General Notes](#).

Cleaning the Control Panel



Attention

Disconnect from power supply

Switch off the Control Panel and all connected devices, and disconnect the Control Panel from the power supply.

The Control Panel can be cleaned with a soft, damp cloth. Do not use any aggressive cleaning materials, thinners, scouring material or hard objects that could cause scratches.

The front of the Panel can be cleaned with a soft, damp cleaning cloth. Do not use any aggressive cleaning materials, thinners, scouring material or hard objects that could cause scratches.

Replacing the battery on the motherboard

A used battery on the motherboard has to be replaced according to the rules of the board manufacturer. See also chapter [Interfaces](#).



WARNING

Danger of Explosion!

Danger of Explosion if battery is incorrectly replaced. Replace only with same or equivalent type recommended by the manufacturer. Dispose of used batteries according to the manufacturer's instructions.

Servicing

The Control Panel is maintenance-free.



Note

Do not open the housing of the Control Panel

For technical support contact [Beckhoff Service](#).

Emergency procedures

In case of fire, the control panel should be extinguished with powder or nitrogen.

Shutting down

Disposal

The device must be fully dismantled in order to dispose of it. The housing can be sent for metal recycling.

Electronic parts such as lamps and circuit boards must be disposed of in accordance with national electronics scrap regulations.

Dismantle the Control Panel

Observe national electronics scrap regulations

Troubleshooting

Please also refer to chapter [General Notes](#).



Note

Pixel errors

Pixel errors in the TFT display are production-caused and represent no complaint-reason!

Fault correction

Fault	Cause	Measures
The Control Panel shows no function when the Industrial PC has been started	No power supply to Control Panel Cable not connected	Check power supply cable 1. Correctly connect cable 2. Call Beckhoff Service
The Industrial PC does not boot fully	Hard disk damaged (e.g. by switching off while software running) Setup settings are incorrect Other cause	1. Boot with boot diskette 2. Start SCANDISK Check the setup settings Call Beckhoff Service
Computer boots, software starts, but control does not operate correctly	The cause of the error is in the software or in parts of the equipment outside the control panel	Call the manufacturer of the machine or the software
Floppy disk or CD access error	Faulty drive	Call Beckhoff Service
The Control Panel has only partial function, or only functions some of the time, for instance the picture is dark or absent	Defective components in control panel	Call Beckhoff Service.
USB error while USB access via TwinCAT	Cycle time in TwinCAT set to 10 ms	Change cycle time to 50 ms

Beckhoff Support & Service

Beckhoff and their partners around the world offer comprehensive support and service, guaranteeing fast and competent assistance with all questions related to Beckhoff products and system solutions.

Beckhoff branches and partner companies

Please contact your Beckhoff branch office or partner company for [local support and service](#) on Beckhoff products!

The contact addresses for your country can be found in the list of Beckhoff branches and partner companies: www.beckhoff.com

You will also find further [documentation](#) for Beckhoff components there.

Beckhoff Headquarters

Beckhoff Automation GmbH
Eiserstraße 5
33415 Verl
Germany

Phone: +49(0)5246/963-0
Fax: +49(0)5246/963-198
e-mail: info@beckhoff.com

Beckhoff Support

Beckhoff offers you comprehensive technical assistance, helping you not only with the application of individual Beckhoff products, but also with wide-ranging services:

- worldwide support
- design, programming and commissioning of complex automation systems
- training program for Beckhoff system components

Hotline: +49(0)5246/963-157
Fax: +49(0)5246/963-9157
e-mail: support@beckhoff.com

Beckhoff Service

The Beckhoff service center supports you in all matters of after-sales service:

- on-site service
- repair service
- spare parts service
- hotline service

Hotline: +49(0)5246/963-460
Fax: +49(0)5246/963-479
e-mail: service@beckhoff.com

Quote the project number If servicing is required, please quote the **project number** of your product.

Appendix

Technical data

<i>Dimensions</i>	Dimensions (W x H x D): see section Assembly dimensions .
<i>Operation in areas that are subject to explosion hazard</i>	The Control Panel must not be used where there is a risk of explosion.
<i>Environmental conditions</i>	The following conditions must be observed during operation: Ambient temperature: 0 to 55°C Atmospheric humidity: Maximum 95%, non-condensing
<i>Shock resistance</i>	Sinusoidal vibration: (EN 60068-2-6) 10 to 58 Hz: 0.035 mm 58 to 500 Hz: 0.5 G (~ 5 m/ s ²) Impact: (EN 60068-2-27/ 29) 5 G (~ 50 m/ s ²), duration: 30 ms
<i>Protection class</i>	Front side: IP65 Rear side: IP20
<i>Power supply</i>	Supply voltage: 24 V _{DC} (20.4 – 28.8 V _{DC}) Power consumption: approx. 8 W with 5.7" display approx. 19 W with 12" display approx. 30 W with 15" display approx. 37 W with 19" display
<i>EMC compatibility</i>	Resistance to interference: conforms to EN 61000-6-2 Emission of interference: conforms to EN 61000-6-4
<i>Transport and storage</i>	The same values for atmospheric humidity and shock resistance are to be observed during transport and storage as in operation. Suitable packaging of the Control Panel can improve the resistance to impact during transport. The ambient temperature during storage and transport must be between -20°C and +65°C.

 Note	Pixel errors Pixel errors in the TFT display are production-caused and represent no complaint-reason!
--	---

Approvals

FCC: Federal Communications Commission Radio Frequency Interference Statement

FCC Approval for USA

This equipment has been tested and found to comply with the limits for a Class A digital device, pursuant to Part 15 of the FCC Rules. These limits are designed to provide reasonable protection against harmful interference when the equipment is operated in a commercial environment. This equipment generates, uses, and can radiate radio frequency energy and, if not installed and used in accordance with the instruction manual, may cause harmful interference to radio communications. Operation of this equipment in a residential area is likely to cause harmful interference in which case the user will be required to correct the interference at his own expense.

FCC: Canadian Notice

FCC Approval for Canada

This equipment does not exceed the Class A limits for radiated emissions as described in the Radio Interference Regulations of the Canadian Department of Communications.