



Installation- and Operating instructions for

FC9891-0000

WLAN Controller Option for Panel PC

Version: 1.1
Date: 2010-09-08

BECKHOFF

Table of contents

1. Foreword	3
Notes on the Documentation	3
Liability Conditions	3
Trademarks	3
Patent Pending	3
Copyright	3
State at Delivery	3
Delivery conditions	3
Description of safety symbols	4
2. Product Description	5
Product Overview	5
Connector	6
Antenna Terminal	6
3. Operating Instructions	7
IEEE 802.11 Standard	7
Antennas	8
ZS6100-0900	8
ZS6200-0400	9
ZS6201-0410	10
ZS6201-0500	11
ZS6203-0200	12
Coaxial Cable	12
Antenna alignment	13
Directional characteristic Omni directional antennas	13
Directional characteristic directional antennas	13
Alignment examples	14
Polarization	14
Omni directional antennas	14
Directional antennas	14
Placement of the antennas	14
Attenuation and range	15
Fresnel Zone	15
Attenuation in practice	15
Ranges for a selection of the following antenna combinations	16
Examples of Use	17
Operating mode: FC9891 as Client	17
Operating mode: FC9891 as Access Point	17
4. Software Installation	18
Installation under Windows XP	18
Operating the FC9891 as Client	21
Configuration with the Microsoft Zero Configuration Tool	21
Configuration with RaUI-Client Configuration Tool	23
Operating the FC9891 as Access Point	27
General Installation Instructions	30
TwinCAT Real-Time-System	30
Operation with Windows Firewall	30
Windows CE	31

5. Appendix	32
Technical data	32
Certificates	33
Grant of Equipment Authorization	33
Technical Acceptance Certificate	34
CE Declaration of Conformity	35
Operation Notes for USA/Canada	36
Calculating with decibels	37
Beckhoff Support & Service	38
Beckhoff branches and partner companies	38
Beckhoff Headquarters	38
Beckhoff Support	38
Beckhoff Service	38

Foreword

Notes on the Documentation

This description is only intended for the use of trained specialists in control and automation engineering who are familiar with the applicable national standards. It is essential that the following notes and explanations are followed when installing and commissioning these components.

The responsible staff must ensure that the application or use of the products described satisfy all the requirements for safety, including all the relevant laws, regulations, guidelines and standards.

Liability Conditions

The documentation has been prepared with care. The products described are, however, constantly under development. For that reason the documentation is not in every case checked for consistency with performance data, standards or other characteristics. In the event that it contains technical or editorial errors, we retain the right to make alterations at any time and without warning. No claims for the modification of products that have already been supplied may be made on the basis of the data, diagrams and descriptions in this documentation.

Trademarks

Beckhoff[®], TwinCAT[®], EtherCAT[®], Safety over EtherCAT[®], TwinSAFE[®] and XFC[®] are registered trademarks of and licensed by Beckhoff Automation GmbH.

Other designations used in this publication may be trademarks whose use by third parties for their own purposes could violate the rights of the owners.

Patent Pending

The EtherCAT Technology is covered, including but not limited to the following patent applications and patents:

EP1590927, EP1789857, DE102004044764, DE102007017835

with corresponding applications or registrations in various other countries.

The TwinCAT Technology is covered, including but not limited to the following patent applications and patents:

EP0851348, US6167425 with corresponding applications or registrations in various other countries.

Copyright

© Beckhoff Automation GmbH.

The reproduction, distribution and utilization of this document as well as the communication of its contents to others without express authorization are prohibited. Offenders will be held liable for the payment of damages. All rights reserved in the event of the grant of a patent, utility model or design.

State at Delivery





All the components are supplied in particular hardware and software configurations appropriate for the application. Modifications to hardware or software configurations other than those described in the documentation are not permitted, and nullify the liability of Beckhoff Automation GmbH.

Delivery conditions

In addition, the general delivery conditions of the company Beckhoff Automation GmbH apply.

Description of safety symbols

The following safety symbols are used in this operating manual. They are intended to alert the reader to the associated safety instructions.

 <p>DANGER</p>	<p>Acute risk of injury!!</p> <p>If you do not adhere the safety advise adjoining this symbol, there is immediate danger to life and health of individuals!</p>
 <p>WARNING</p>	<p>Risk of injury!</p> <p>If you do not adhere the safety advise adjoining this symbol, there is danger to life and health of individuals!</p>
 <p>CAUTION</p>	<p>Hazard to individuals!</p> <p>If you do not adhere the safety advise adjoining this symbol, there is obvious hazard to individuals!</p>
 <p>Attention</p>	<p>Hazard to devices and environment</p> <p>If you do not adhere the notice adjoining this symbol, there is obvious hazard to materials and environment.</p>
 <p>Note</p>	<p>Note or pointer</p> <p>This symbol indicates information that contributes to better understanding.</p>

Product Description

Product Overview

View of a Control Panel,
fitted with the FC9891-0000
WLAN Controller



The Option FC9891 is a fully integrated industrial grade data exchange unit for radio technology. The FC9891 is based on the standard IEEE 802.11 b/g and can be used either as access-point or as client. Client drivers are available for Windows XP, XP Embedded as well as Windows CE, thus for each Beckhoff IPC as well as the CX-series. These support also adhoc modus.

With the drivers for Windows XP and XP Embedded, the FC9891 can also operate as an access-point.

The encryption methods are possible from AES-128 bit up to WPA2, the module is compatible to Cisco CCX and supports PEAP and LEAP. The data rate is adapted dynamically up to 54 Mbit/s.

The FC9891 has a reverse SMA plug for connection of various radio antennas on the backside of the Panel. The free choice of antenna enables adaptation to the respective environment. Beckhoff offers a complete accessories program of antennas and cables.

The outdoor range between two modules depends on the environment and can be up to 300 m.

It is possible to choice between 11 channels in the 2.4 GHz-band while following the country specific rules.

Connector

View of the antenna terminal
on back of the Panel



Antenna terminal

Antenna Terminal

The FC9891 WLAN controller has a reverse SMA plug (**X20**) for connection of various radio antennas. The free choice of antenna enables adaptation to the respective environment.

Operating Instructions

IEEE 802.11 Standard

Wireless LANs (WLANs) are local radio networks with main reference to wireless computer networks. The IEEE 802.11 standard was first published in 1997. Basically the standard allows either the wireless connection of two (or more) PCs (or laptops) with each other directly (ad-hoc) or to expand an existing wired computer network with an infrastructure (access points) for wireless users.

The most popular standard is the IEEE 802.11 b/g that provides a data transfer rate up to 54 MBit/s for the 2.4 GHz band. The data rate is adjusted dynamically.

The standard provides 11 channels worldwide, but only 3 can be used without overlapping:

Channel overlapping

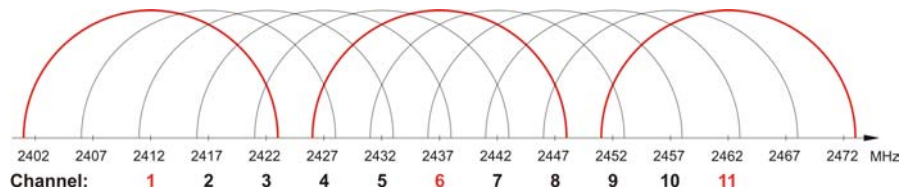

When using the network in a confined area (e.g. in a factory building) notice the following comb-shaped structure with a channel difference of 5 channels to each neighbor cell:

Comb-shaped



Antennas

The use of the FC9891-0000 is permitted with the following antennas:

Designation	Description
ZS6100-0900	Directional antenna (gain 9 dBi), without cable
ZS6200-0400	Omni directional antenna (gain 4 dBi), without cable
ZS6201-0410	Rod antenna (gain 4 dBi), with cable (1 m)
ZS6201-0500	Rod antenna (gain 5 dBi), without cable
ZS6203-0200	Rod antenna (gain 2 dBi), 90° offset connection



Note

Use original Beckhoff accessories

The CE conformity of the FC9891-0000 is only guaranteed if it is operated with original Beckhoff accessories (antennas, coaxial cable)!

ZS6100-0900

ZS6100-0900

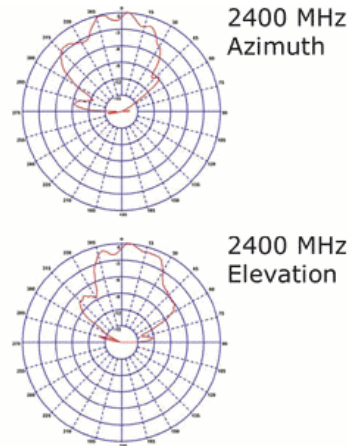

Technical data	ZS6100-0900
Frequency range	2400...2485 MHz
Transmission factor	9 dBi
3 dB bandwidth, horizontal	65°
3 dB bandwidth, vertical	65°
Connection	SMA socket
Dimensions (W x H x D)	93 mm x 93 mm x 25 mm
Weight (incl. accessories and packaging)	approx. 190 g
Operating temperature	-40°C ... + 80°C
Relative humidity	95%, no condensation
Protection class	IP20
Installation position	variable
Approval	CE
Mounting	bracket mounting, included in scope of supply
Suitable coaxial cable	ZS6000-0102-0020, ZS6000-0102-0040

ZS6200-0400

ZS6200-0400

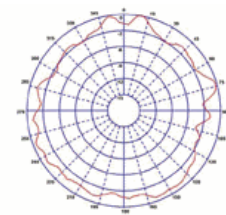

2400 MHz
Azimuth

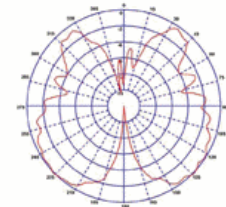

2400 MHz
Elevation

Technical data	ZS6200-0400
Frequency range	2400...2485 MHz
Transmission factor	4 dBi
3 dB bandwidth, horizontal	360°
3 dB bandwidth, vertical	70°
Connection	SMA socket
Dimensions	diameter 110 mm, height 45 mm
Weight (incl. accessories and packaging)	approx. 210 g
Operating temperature	-40°C ... + 80°C
Relative humidity	95%, no condensation
Protection class	IP20
Installation position	variable, predestined for mounting below the ceiling
Approval	CE
Suitable coaxial cable	ZS6000-0102-0020, ZS6000-0102-0040

ZS6201-0410

ZS6201-0410

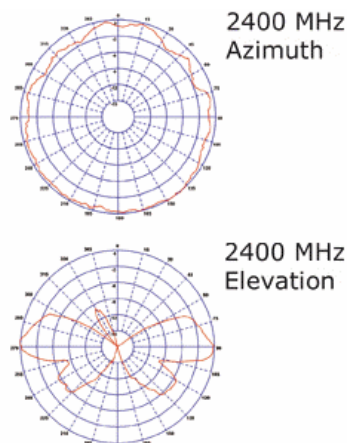

Technical data	ZS6201-0410
Frequency range	2400...2485 MHz
Transmission factor	4 dBi
3 dB bandwidth, horizontal	360°
3 dB bandwidth, vertical	70°
Connection	reverse SMA socket (with 1 m cable, permanently connected to antenna)
Dimensions	height 202 mm, foot diameter 35 mm
Weight (incl. cable, accessories and packaging)	approx. 220 g
Operating temperature	-40°C ... + 80°C
Relative humidity	95%, no condensation
Mounting	cap nut M14
Protection class	IP20
Installation position	variable
Approval	CE
Coaxial cable	1 m, included in scope of supply

ZS6201-0500

ZS6201-0500

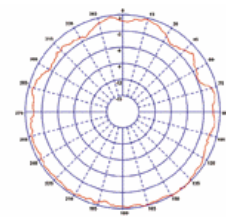

2400 MHz
Azimuth

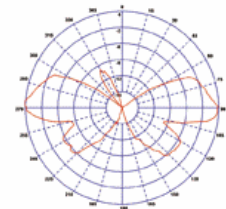

2400 MHz
Elevation

Technical data	ZS6201-0500
Frequency range	2400...2485 MHz
Transmission factor	5 dBi
3 dB bandwidth, horizontal	360°
3 dB bandwidth, vertical	70°
Connection	reverse SMA socket
Dimensions	height 195 mm, foot diameter 12 mm
Weight (incl. packaging)	approx. 40 g
Operating temperature	-40°C ... + 80°C
Relative humidity	95%, no condensation
Mounting	direct connection with hinged joint
Protection class	IP20
Installation position	variable
Approval	CE

ZS6203-0200

ZS6203-0200

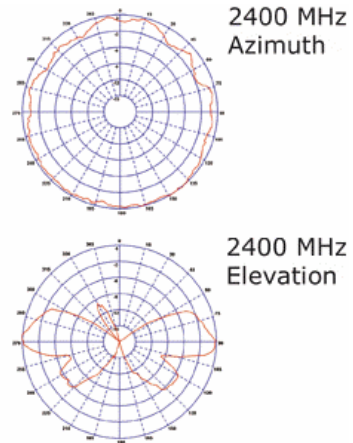

Technical data	ZS6203-0200
Frequency range	2400...2485 MHz
Transmission factor	2 dBi
3 dB bandwidth, horizontal	360°
3 dB bandwidth, vertical	70°
Connection	reverse SMA socket
Dimensions	height 120 mm, foot diameter 12 mm
Weight (incl. packaging)	approx. 40 g
Operating temperature	-40°C ... + 80°C
Relative humidity	95%, no condensation
Mounting	direct connection with 90° offset
Protection class	IP54
Installation position	direct at the rear side of the Panel
Approval	CE

Coaxial Cable

Coaxial cables

The following coaxial cables are available:

Designation	Description
ZK6000-0102-0020	Coaxial cable, characteristic impedance 50 Ω, preassembled plug connectors (SMA plug and reverse SMA socket), black, 2 m
ZK6000-0102-0040	Coaxial cable, characteristic impedance 50 Ω, preassembled plug connectors (SMA plug and reverse SMA socket), black, 4 m

Antenna alignment

Please pay attention to the directional characteristics and polarization of the antennas in order to mount and align them to each other optimally!

Directional characteristic Omni directional antennas

ZS6201-0410, ZS6201-0500, ZS6203-0200

Design form



Side view
(vertical directional characteristic)

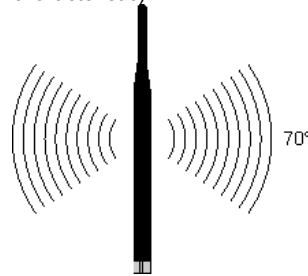

Top view
(horizontal directional characteristic)

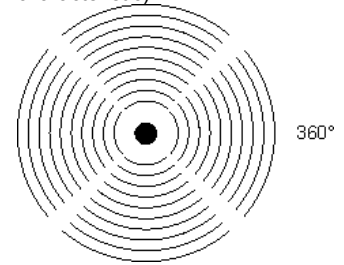

ZS6200-0400

Predestined for mounting below the ceiling.

Design form



Side view
(vertical directional characteristic)

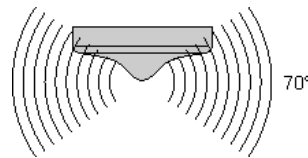

Top view
(horizontal directional characteristic)

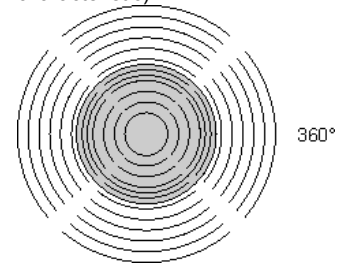

Directional characteristic directional antennas

ZS6100-0900

Design form

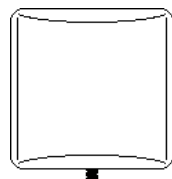

Side view
(vertical directional characteristic)

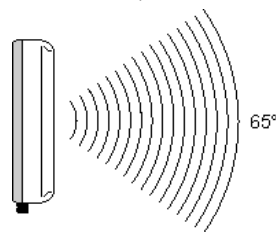

Top view
(horizontal directional characteristic)

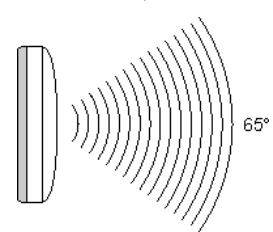

Alignment examples

Align the antennas so that each lies within the radiation cone of the opposite antenna.

Omni directional antennas

Two ZS6201-0410, ZS6201-0500 or ZS6203-0200



Directional antennas

Two ZS6100-0900



Mixed operation

e.g. one ZS6201-0410 and two ZS6100-0900

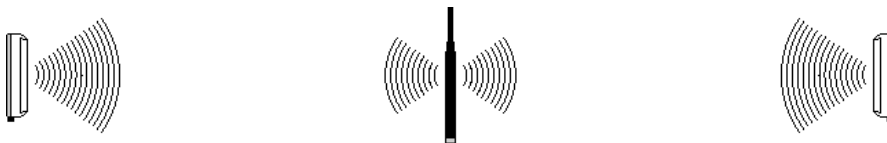

Polarization

For optimum transmission, all antennas used must have the same polarization.

Omni directional antennas

Care must also be taken when using omni directional antennas that the antennas used have the same polarization.

Omni directional antennas such as the ZS6201-0410, ZS6201-0500 or ZS6200-0400 are mostly mounted for vertical polarization.

Directional antennas

Arrows marked with the letters H and V are located on the rear side of the housing of the ZS6100-0900 directional antenna in order to identify the polarization

Mount the directional antennas such that the marked arrows of all the antennas used correspond to one another.

Placement of the antennas

Mount the antennas such that they can radiate freely!

There must be no obstructions in the direct vicinity of the antenna that could hinder the development of the Fresnel zone. Metal obstacles such as control cabinets, machine parts, pipelines, iron beams etc. particularly hinder the development of the Fresnel zone!

The connection of the antennas to the FC9891 via the RSMA plug and coaxial cable enables the antenna to be mounted remotely, so that you can position the antenna optimally.

Attenuation and range

Fresnel Zone

Fresnel Zone

In radio transmission, the space between the transmitting and receiving antennas is known as the Fresnel zone. The Fresnel zone is a notional spheroid between the antennas.

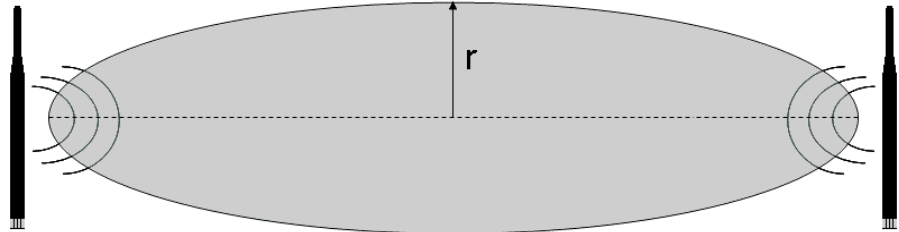

The main portion of the energy is transmitted in the area of the Fresnel zone.

This zone should be free of obstructions (e.g. objects, houses, trees etc.). Metal obstacles such as control cabinets, machine parts, pipelines, iron beams etc. particularly hinder the development of the Fresnel zone! Each hindrance of the Fresnel zone attenuates the transmission. If the Fresnel zone is half obscured, for example, the additional attenuation is 6 dB, i.e. the field strength is reduced to half of the free field value. Reception may then be disturbed or completely interrupted under certain circumstances.

If the Fresnel zone is free from obstructions, the propagating wave is only attenuated by the free field attenuation.

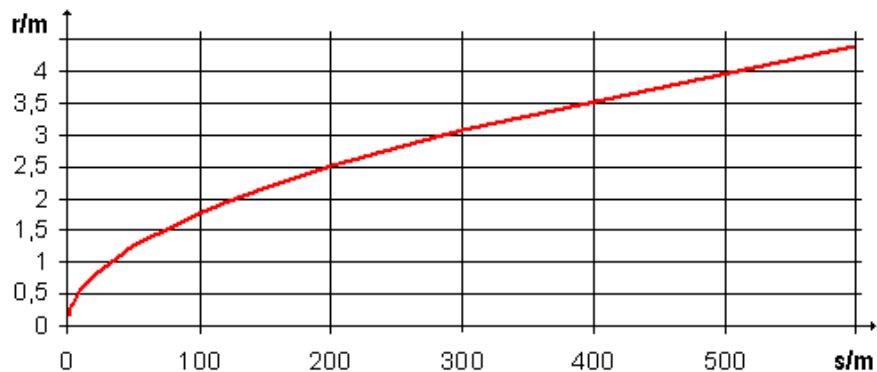

Radius r of the Fresnel zone in relationship to the distance s .

Attenuation in practice

Attenuation

With an attenuation of 6 dB the range is shortened to half of the value for an unobstructed connection, with 12 dB it is shortened to a quarter.

Material	Attenuation	Range approx.	Example for an unobstructed range of 280 m
Thin wall	2-5 dB	(free field range)/1.5 - (free field range)/2	180 m - 140 m
Wooden wall	5 dB	(free field range)/2	140 m
Masonry wall	6-12 dB	(free field range)/2 - (free field range)/4	140 m - 70 m
Concrete wall	10-20 dB	(free field range)/4 - (free field range)/8	70 m - 35 m
Concrete ceiling	20 dB	(free field range)/8	< 35 m

Ranges for a selection of the following antenna combinations

The given ranges are based on an unobstructed view and adherence to the Fresnel zone.

Two omni directional antennas

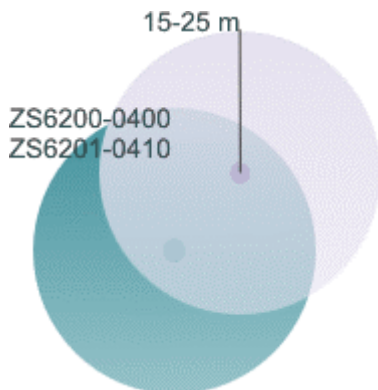

Omni directional antennas combined with a directional antenna

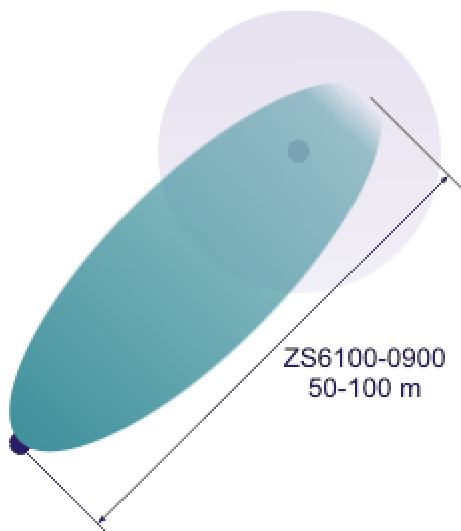

Two directional antennas

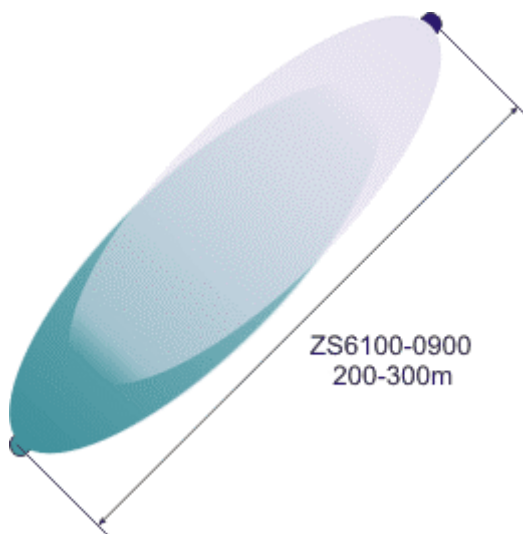

Examples of Use

Operating mode: FC9891 as Client

Client Modus

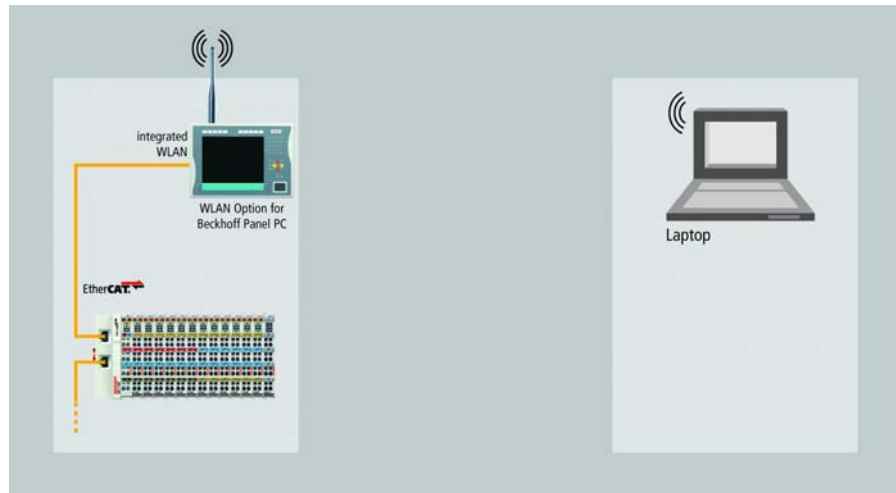

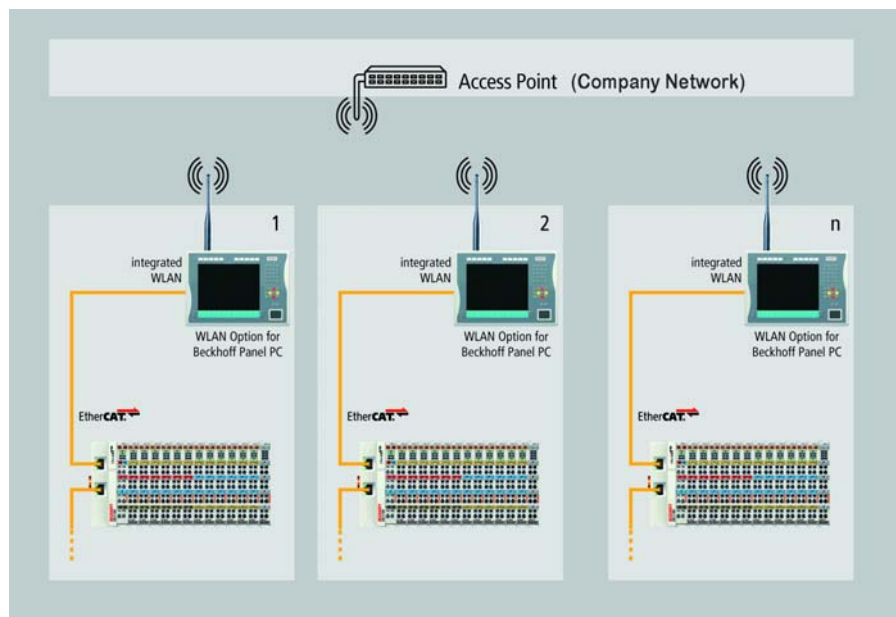

Operating mode: FC9891 as Access Point

Access Point Modus



Software Installation

Installation under Windows XP

 Note	<p>Depending on the order option the software is already installed</p> <p>If the software is not yet installed, then install the software first before connecting the FC9891 WLAN-Controller!</p>
 Note	<p>Deactivate the firewall</p> <p>During installation the firewall should be deactivated.</p>

The XP/ XPe driver for the FC9891 WLAN-Controller can be found on the Beckhoff driver CD / DVD.

Download the up-to-date driver

The up-to-date driver may be downloaded also from the Internet under:

ftp://ftp.beckhoff.com/Software/embPC-Control/XPe/Solutions/CUxxxx_Driver/FC9891_XP_Driver.zip

or

http://www.beckhoff.de/download/Software/embPC-Control/XPe/Solutions/CUxxxx_Driver/FC9891_XP_Driver.zip

After execute the setup.exe file the installation routine of Ralink opens:

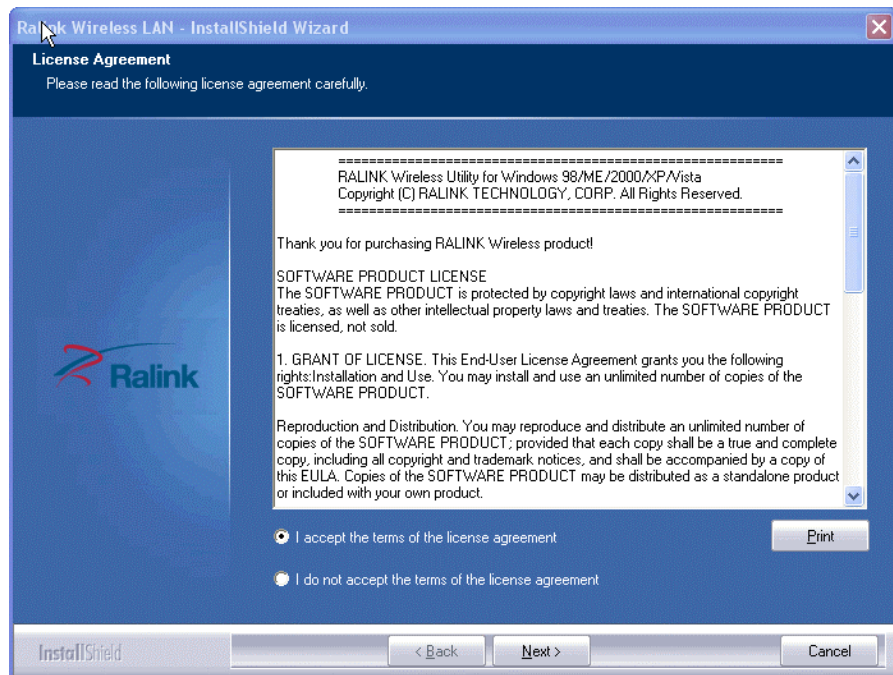

Accept the terms of the license agreement and click *Next*. The installation procedure will now ask for the configuration tool you prefer:

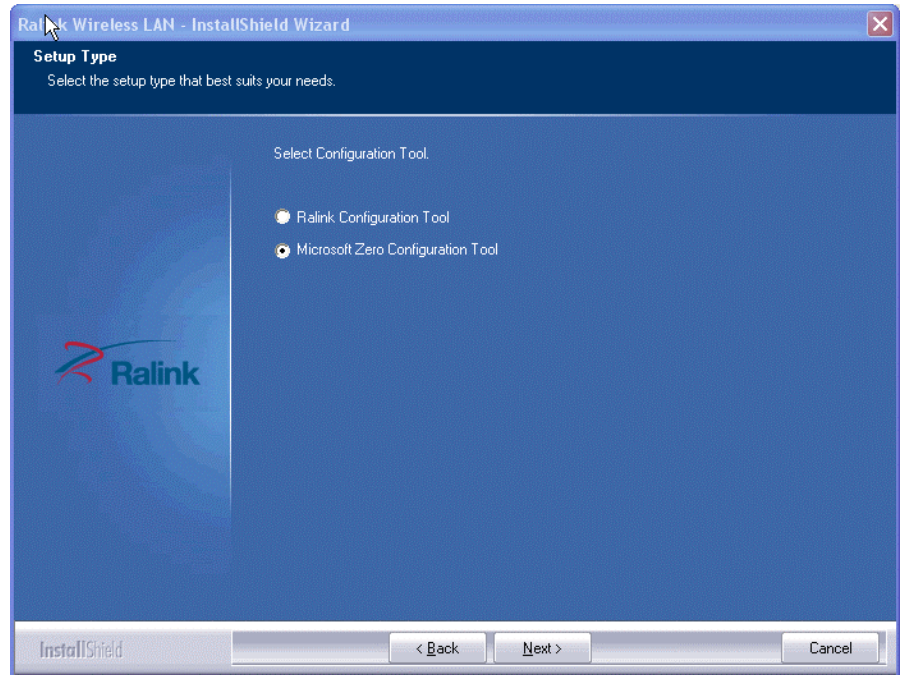

Select *Microsoft Zero Configuration Tool* and click *Next* to continue.

 Note	<p>Change to Ralink Configuration Tool</p> <p>After the installation has finished you can always change to the Ralink Configuration Tool.</p>
--	--

At the window *Setup Type* choose *Optimize for WiFi mode* and go on by clicking onto *Next*::

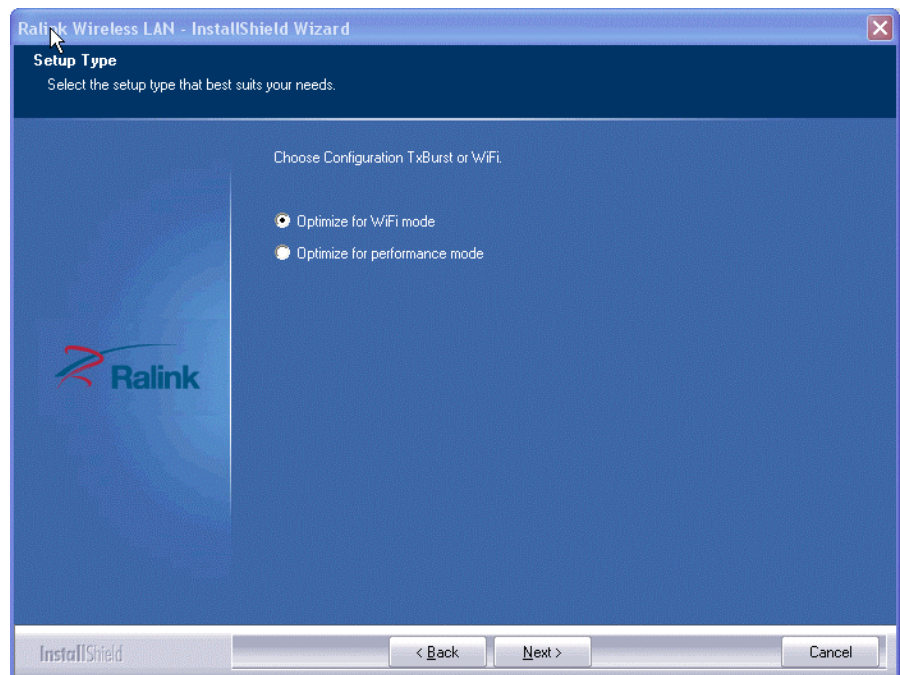

Click *Install* to start the installation procedure. The required data will now be copied to the hard disk.

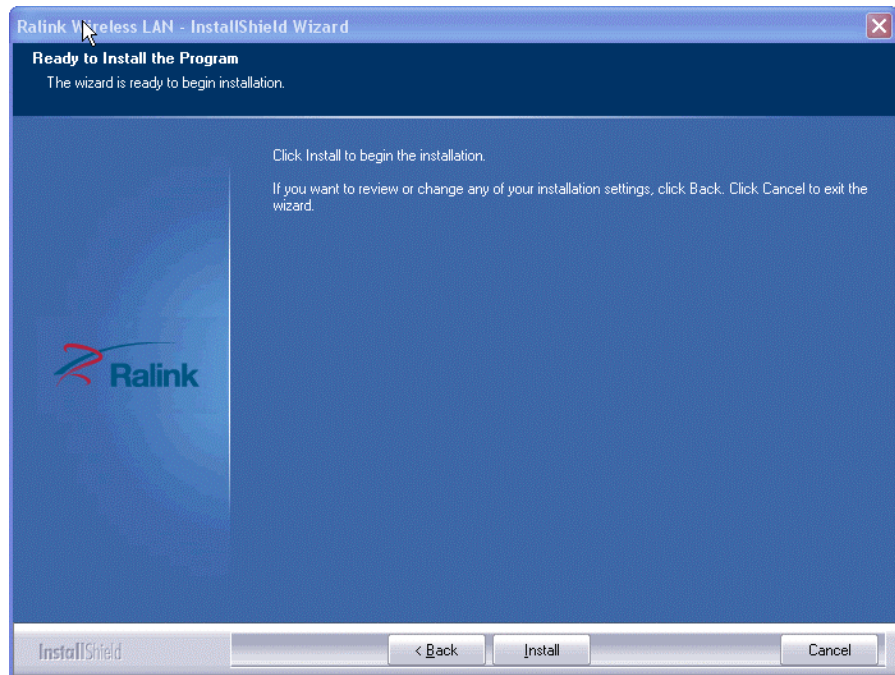

Click *Finish* and the installation is completed:

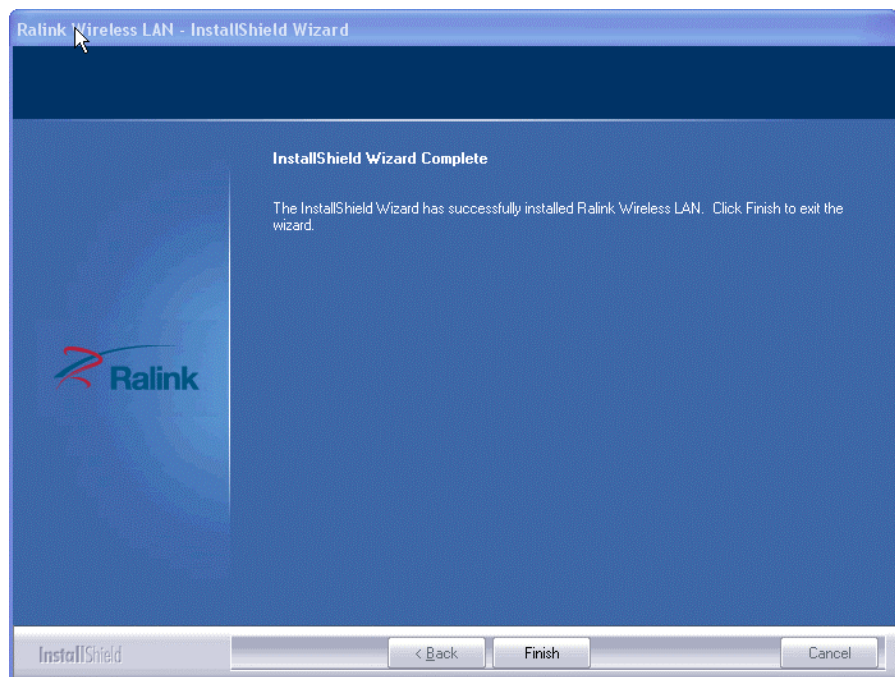

In the task bar of your computer you now see the crossed Ralink symbol that indicates an inactive USB connection.

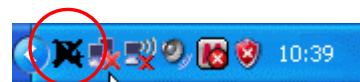

Connecting USB cable

Connect now the FC9891 WLAN controller with your computer via the USB cable.

When the USB connection is active you see the following symbol in the task bar:



The installation of the Ralink driver is completed successfully.

 Note	<p>Default mode</p> <p>After successfully installation under Windows XP the FC9891 WLAN-Controller is generally in client modus.</p>
--	---

Operating the FC9891 as Client

Generally the FC9891 WLAN controller is in client modus.

Configuration with the Microsoft Zero Configuration Tool

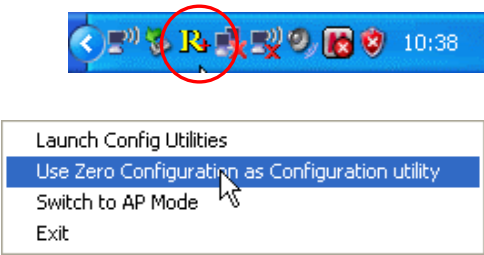
 Note	<p>Change to Microsoft Zero Configuration Tool</p> <p>If you didn't choose the Microsoft Zero Configuration Tool as it was recommended during setup, we recommend now to do this via a right mouse click onto the Ralink symbol within the task bar:</p>	
--	---	--

Via double click the onto Zero Configuration Tool Symbol you can start the Zero Configuration Tool:



Choose *View Wireless Networks* to get a list of the available networks:

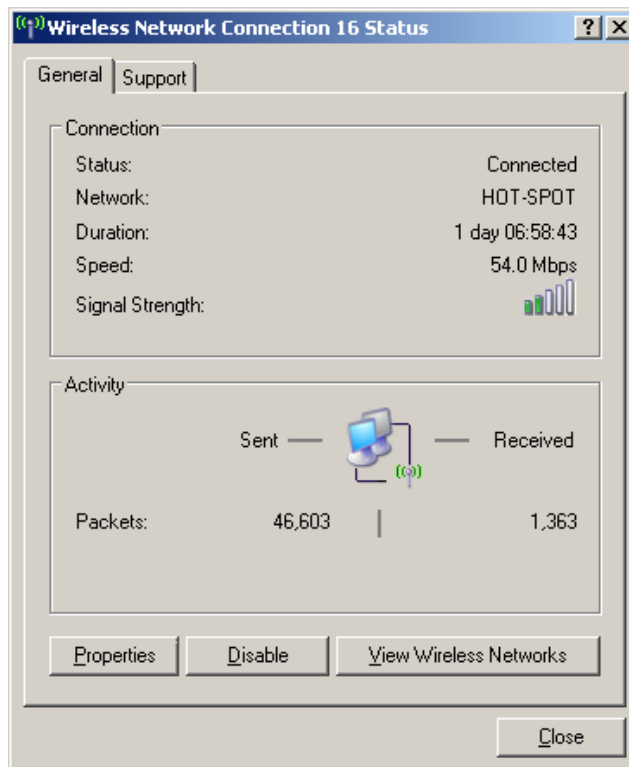

A window with a list of the available networks opens:

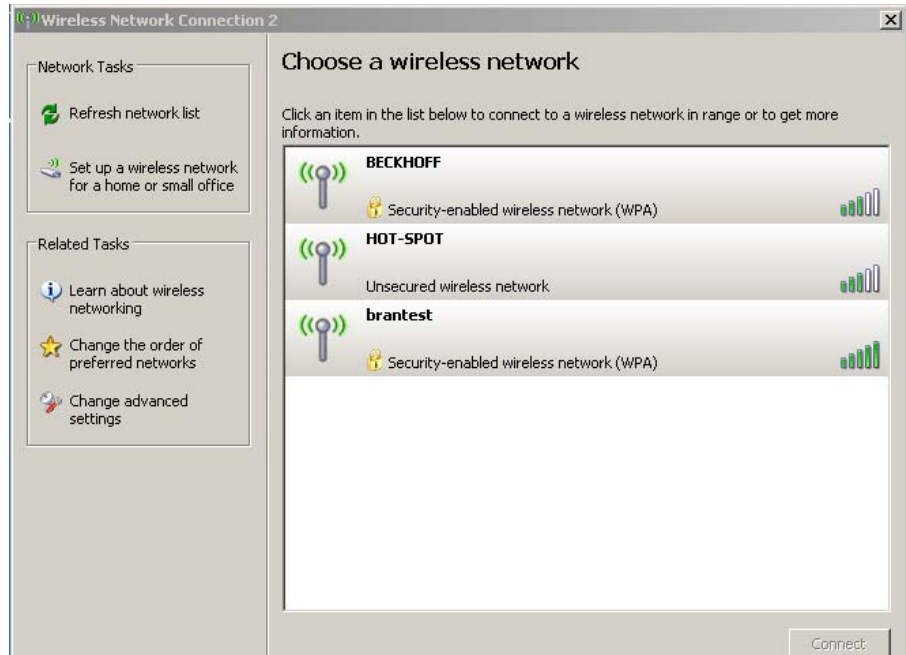

Via double click the desired network a connection to this is made.

If a network key is necessary you will be requested to enter it:

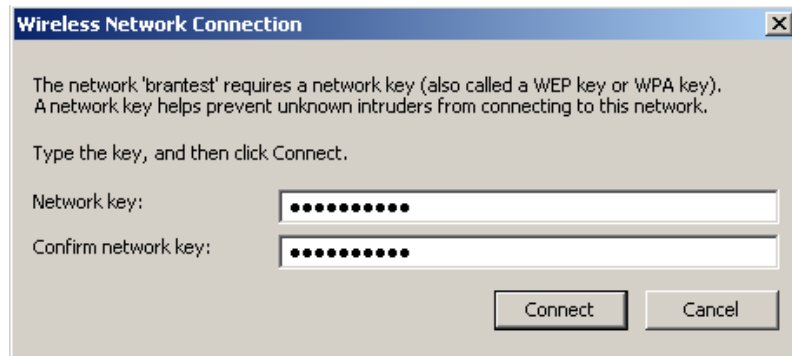

Enter the key and click to *Connect* to connect with this network.

Configuration with RaUI-Client Configuration Tool

The configuration can alternatively also be done with the Ralink Tool. Double click the Ralink Symbol at the Task bar to start the *RaUI-Client Configuration-Tool*.

 Note	<p>RaUI-Client Configuration Tool for experienced users</p> <p>We recommend the RaUI-Client Configuration Tool only to experienced users! To operate this tool a monitor resolution of 1024 x 768 pixel is necessary.</p> <p>With the RaUI-Client Configuration Tool in client mode the visible networks can be sorted in order of channels what may be useful for coexistence planning. Also the operation as an Access Point-Betrieb is only possible with this. Details in chapter Operating the FC9891 as Access Point.</p>
--	--

Double click on the Ralink symbol in the task bar starts the *RaUI-Client configuration tool*.



To connect to an existing network select the register *Network* in the RaUI-Client configuration tool. A list of the available WLANs is shown:

Network	Channel	Signal
BECKHOFF	1	100%
BECKHOFF	1	60%
BECKHOFF	6	34%
HOT-SPOT	1	60%
HOT-SPOT	6	34%
test	11	81%

Status >>	HOT-SPOT <-> 00-13-60-6D-04-E1	Link Quality >> 96%
Extra Info >>	Link is Up [TxPower:100%]	Signal Strength 1 >> 33%
Channel >>	1 <-> 2412 MHz	Noise Strength >> 3%
Authentication >>	Open	
Encryption >>	NONE	
Network Type >>	Infrastructure	
IP Address >>	192.168.104.84	Transmit
Sub-Mask >>	255.255.255.0	Link Speed >> 54.0 Mbps
Default Gateway >>	192.168.104.1	Throughput >> 0.688 Kbps
		Max 19,936 Kbps
		Receive
		Link Speed >> 54.0 Mbps
		Throughput >> 47.188 Kbps
		Max 123,504 Kbps

Click *Rescan* to refresh the list:

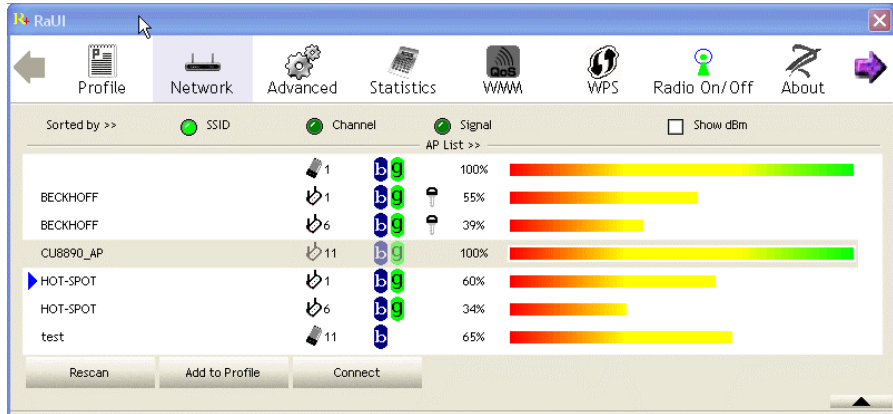

Click on the button *Channel* to get a list of the networks sorted by channels.



Note

Multiple networks

If multiple networks are on one channel, a bad performance can be possible and you should change the channel!

Connecting the WLAN-Controller

The blue arrow in the network window symbolize the active connection. Click on the network to select it.

Now the *System Config* window appears and you can give a profile name to the selected network:

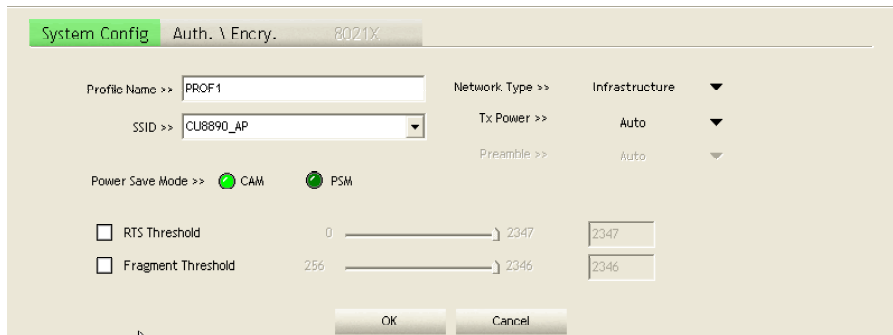

In the next window you can select the encryption method. Therefore click on the register *Auth. \ Encry.:*

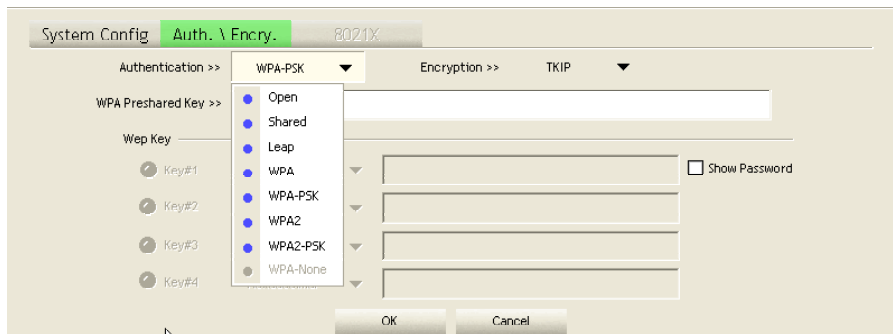

You now see a list of the selectable encryption methods. On top of the list the method *Open* is shown, that means no encryption.

If there is an encryption in the actual network, it now can be selected. In our example it is *WPA-PSK* (WPA2-PSK recommended).

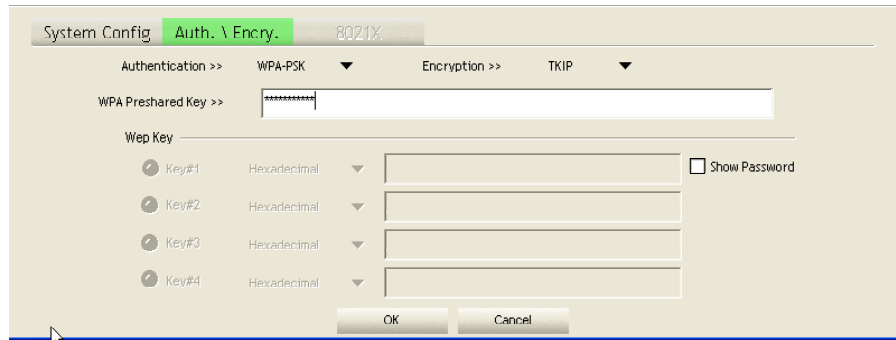

Type the *WPA preshared key* and confirm with *OK*.

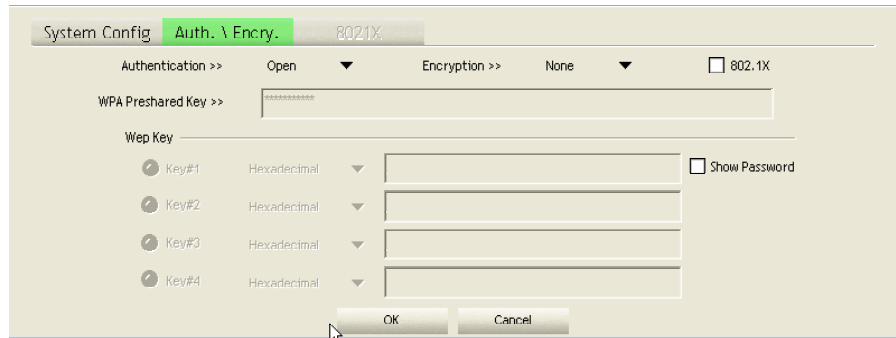

Now the view changes to the *Profile* window and you can see the new profile:

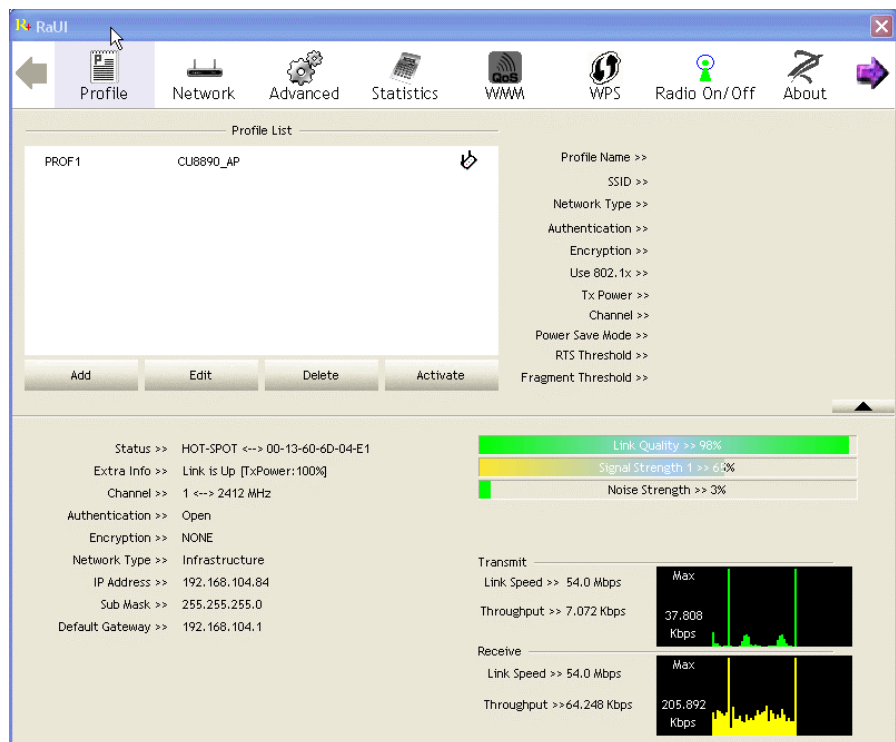

Click on you profile and the *Activate* button to activate the network.

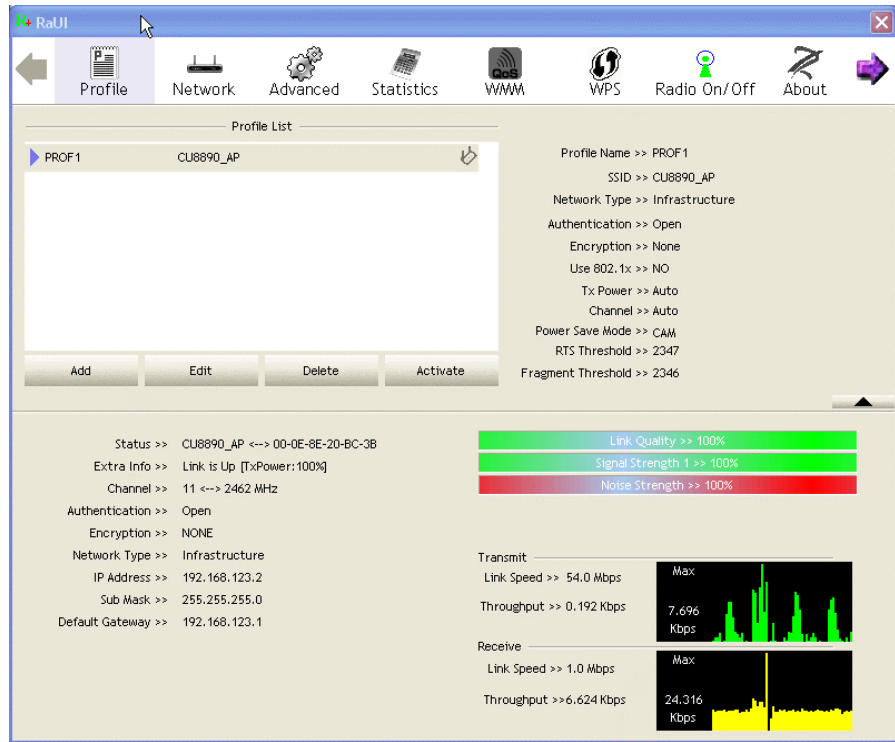

The WLAN-Controller now has a network IP-Address shown in the status messages:

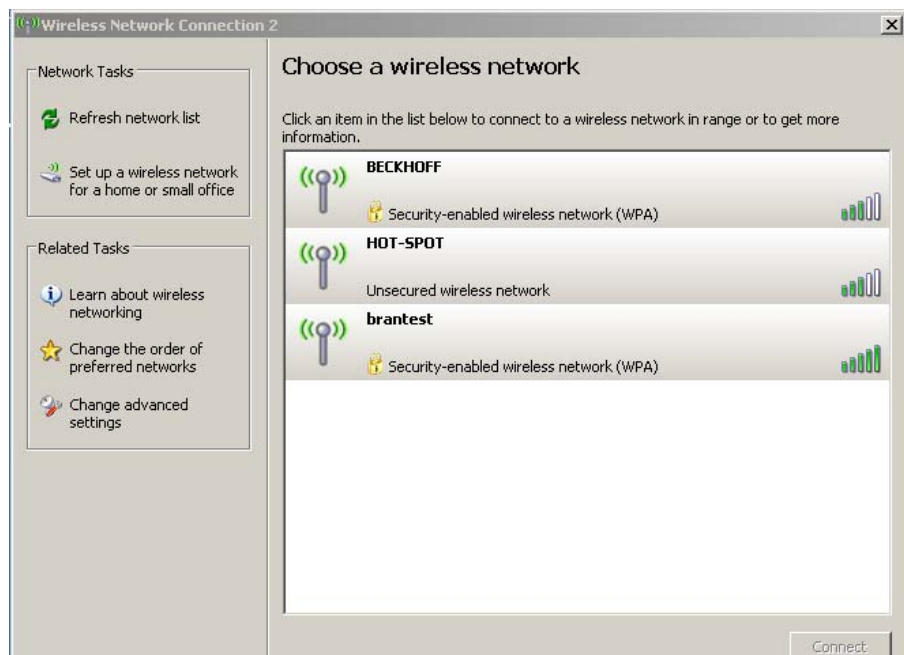

Now the network connection is also shown in the standard Windows network diagram:



Operating the FC9891 as Access Point

 Note	<p>Access point operation is not possible under Windows CE</p> <p>By default the FC9891 WLAN-Controller is in client modus. Access point operation is also only possible under XP/ Xpe, but not under Windows CE.</p>
 Note	<p>Access point operation is only possible with Ralink RaUI Configuration Software</p> <p>Access point operation is only possible with Ralink RaUI Configuration Software, but not with the Microsoft Zero Tool. A display resolution of 1024*768 pixel is required for configuration the Ralink RaUI Configuration Software.</p>

When the FC9891 should be operated as access point you can change the mode by right mouse click on the Ralink symbol in the task bar:

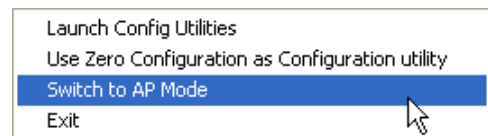

The symbol in the task bar has now be changed into AP:





The window *Internet Connection Sharing (ICS)* appears:

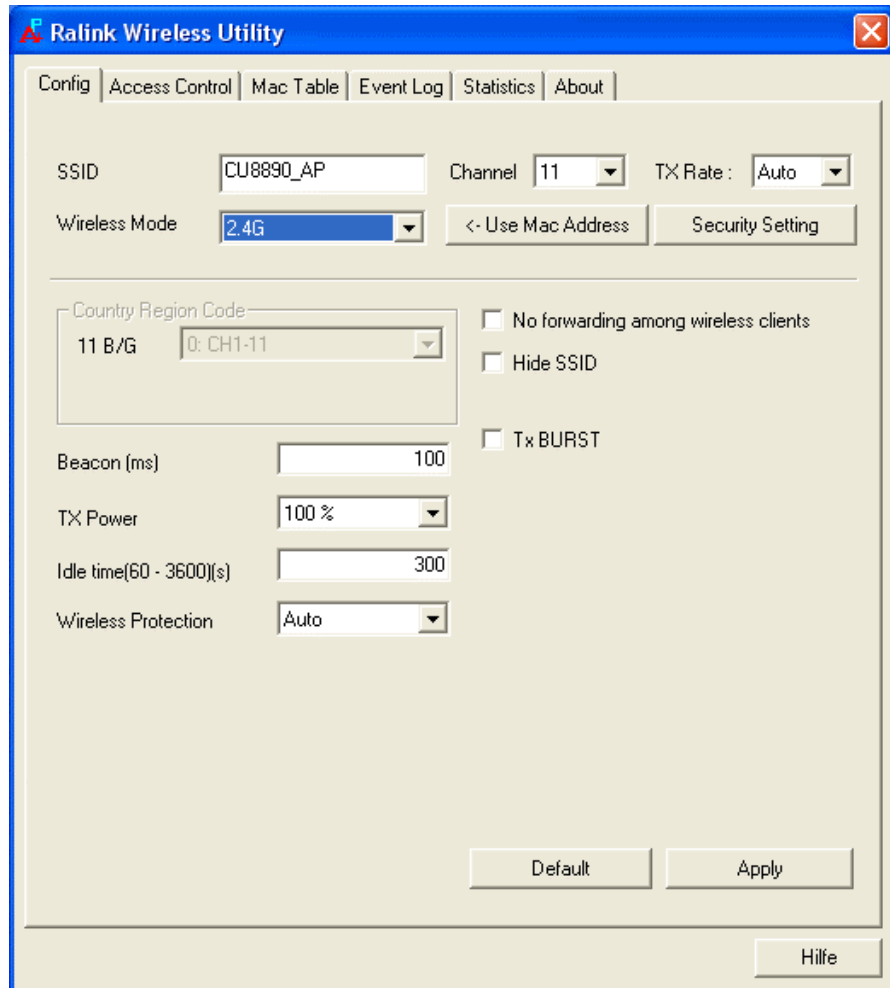

Select the WAN adapter and click OK. The *Ralink Wireless Utility* window appears and you can type the network name (SSID) and the channel.

Click *Apply* and the alignments will be saved.



 Note	<p>Modification of the network name (SSID)</p> <p>The modification of the network name (SSID) is not applied until the WLAN adapter is deactivated and then activated again after changing the name.</p> <p>Changing the channel without deactivating/ activating is not possible.</p>
--	--

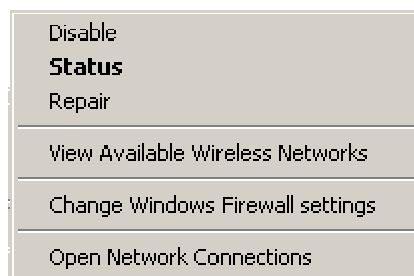

Click the button *Security Settings* to open the security settings window. Here you can select the designated encryption mode (e.g. WPA-PSK, suggested) and assign the according key.

The network is not encrypted if you select *Open*.

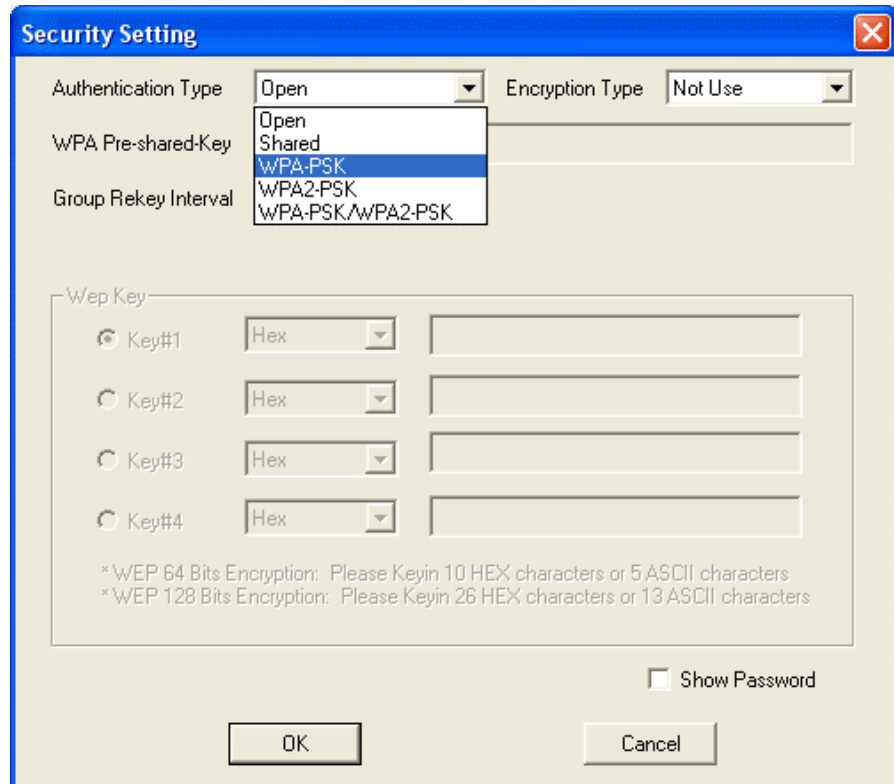

The FC9891 WLAN-Controller now provides the network with the network name (SSID) on the selected channel. WLAN clients can now connect to the network. If a network key was assigned under data encryption options it must be published to the clients.

General Installation Instructions

TwinCAT Real-Time-System

TwinCAT

With the FC9891, TwinCAT network variable swapping is possible on base of UDP/IP (Publisher/ Subscriber Variables).

For installation the FC9891 ethernet adapter for TwinCAT, run the manual installation via the *windows network settings*, do not use the system manager.

Proceed as follows:

1. Select *Windows Network Settings*
2. Select *Wireless LAN*
3. Right mouse click for *Properties*
4. Click *Install*
5. *Add Service*
6. Select the manufacturer: *Beckhoff*
7. Network protocol *TwinCAT RT-Ethernet Intermediate Driver*
8. Click *OK* to finish.

In the TwinCAT system manager the wireless network interface is listed under the category *installed devices (system manager -> options -> list real-time ethernet compatible devices)*.

Then TwinCAT network variable swapping is possible on base of UDP/IP. It is not possible to run RT-EtherNet protocol or EtherCAT!

Operation with Windows Firewall

Windows Firewall

When operating the wireless network while Windows firewall is activated the access point mode can be blocked. In that case deactivate the firewall.

Windows CE

Windows CE

Under Windows CE the operation of the FC9891 WLAN-Controller is only possible in client mode.

The Windows CE driver is available for CE 6. You can download the driver for Beckhoff x86- and ARM based devices under:

ftp://ftp.beckhoff.com/Software/embPC-Control/CE/Solutions/CUxxxx_Driver/FC9891_CE60.zip

For operating the FC9891 WLAN-Controller you need the CE driver as well as the Microsoft Zero tool for configuration the WLAN. On x86 based devices this is already integrated in the CE 6 image. On ARM based devices the installation has to be started later on.

Proceed as follows:

Driver Installation on ARM based Devices

ARM based devices

Proceed as follows to install the drivers:

1. Download and unpack file *FC9891_CE60.zip*.
There are two sub-folders for the particular systems *x86* or *ARM*.
2. Copy the files of the selected system (x86 or ARM) to the CE device (via USB stick, public folder or FTP folder)
3. Copy the files to the correct folders:
Hard Disk\System:
 xcopy all files to device under \hard disk\System
Hard Disk\RegFiles:
 xcopy all files to device under \hard disk\Regfiles
4. Double click on all new *Registry Files*
5. Finally reboot the system.

After rebooting the system, the driver is installed, as well the Microsoft Zero Tool at ARM based devices.

Connecting with the network

Connecting with the network

In the graphical user interface you can select a network. Click *connect* to connect with the network:



Appendix

Technical data

Antenna terminal	Connection via a reverse SMA plug (RP-SMA)
Standard	IEEE 802.11 b/g and TCP/ UDP IP
Data transfer rate	max. 54 Mbit/s
Data transmission band	2,4 GHz
Channels	11
Channel separation	5 MHz
Channel width	22 MHz
Available	Worldwide
Data rate adjustment	Dynamic data rate adjustment at mode b: 1, 5, 11 Mbit/s; at mode g: 6, 9, 12, 18, 24, 36, 48, 54 Mbit/s. Not usable for Realtime Ethernet or EtherCAT!
Encryption	64-/128-Bit-encryption, WEP, WPA, WPA2 Cisco-compatible extension CCX, providing PEAP and LEAP
The following conditions must be observed during operation:	
Environmental conditions	Ambient temperature: 0 to 55°C (operation) -25°C to +70°C (transport/ storage)
	Atmospheric humidity: Maximum 95%, non-condensing
Vibration/ Shock resistance	EN 60068-2-6 / EN 60068-2-27, EN 60068-2-29
EMC resistance burst/ ESD	EN 60000-6-2 Burst: EN 60000-6-4, EN 300328 V1.7.1 Safety of persons in electromagnetic fields: EN 50371:2002
Do not use the FC9891 in areas of explosive hazard	The Panel PC may not be used in areas of explosive hazard.
Approvals	CE, FCC, IC



Note

Use original Beckhoff accessories

The CE conformity of the FC9891-0000 is only warranted when operated with original Beckhoff accessories (see chapter [Antennas](#))

The FC9891-0000 meets demands of the EN 300328 V1.7.1 and is approvable in all countries of the EU as well as Liechtenstein, Switzerland, Ireland and Iceland.

The FC9891-0000 meets also demands of FCC Part 15.4 and Canada IC.
More countries on request.

Certificates

Grant of Equipment Authorization

TCB

**GRANT OF EQUIPMENT
AUTHORIZATION**

TCB

Certification
Issued Under the Authority of the
Federal Communications Commission
By:

TUV Rheinland of North America, Inc.
Product Safety Division 762 Park Avenue
Youngsville, NC 27596

Date of Grant: 07/21/2010
Application Dated: 07/19/2010

Beckhoff Automation GmbH
Eiserstrasse 5
Verl, 33415
Germany

Attention: Michel Matuschke , Dipl. Ing.

NOT TRANSFERABLE

EQUIPMENT AUTHORIZATION is hereby issued to the named GRANTEE, and is VALID ONLY for the equipment identified hereon for use under the Commission's Rules and Regulations listed below.

FCC IDENTIFIER: XS3-FC9891-0000
Name of Grantee: Beckhoff Automation GmbH
Equipment Class: Digital Transmission System
Notes: USB Wireless LAN Module
Modular Type: Single Modular

<u>Grant Notes</u>	<u>FCC Rule Parts</u>	<u>Frequency Range (MHZ)</u>	<u>Output Watts</u>	<u>Frequency Tolerance</u>	<u>Emission Designator</u>
	15C	2412.0 - 2460.0	0.151	1520.0 Hz	F1D

The antenna(s) used for this transmitter must be installed to provide a separation distance of at least 20 cm from all persons. OEM integrators, End-users and installers must be provided with antenna installation instructions and transmitter operating conditions for satisfying RF exposure compliance.

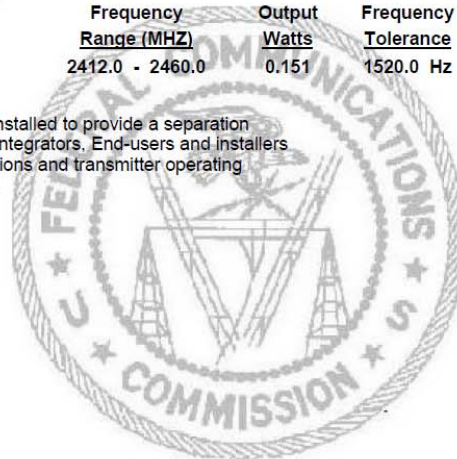

Technical Acceptance Certificate

TECHNICAL ACCEPTANCE CERTIFICATE

ISSUED UNDER THE AUTHORITY OF THE CERTIFICATION
AND ENGINEERING BUREAU OF INDUSTRY CANADA
MODULAR APPROVAL



CERTIFICATE NO.: No. DE CERTIFICATION:	IC: 8573A-FC98910000	TRADENAME AND MODEL MARQUE ET MODELE	USB Wireless LAN Module FC9891-0000
CERTIFICATE TYPE: TYPE DE CERTIFICATION:	Spread Spectrum / Digital Device (2400–2483.5 MHz)	TYPE OF EQUIPMENT GENERE DE MATÉRIEL	W-LAN Module
ISSUED TO: DÉLIVRÉ À:	Beckhoff Automation Eiserstraße 5 33415 Verl Germany		
TESTED BY: TESTÉ A:	TUV Rheinland Product Safety Am Grauen Stein Cologne, Germany	CN:	3466A-1
CONTACT: CONTACT:	Oswin Schäfer Tel. 49 221 806-3313	Email	Oswin.schaefer@de.tuv.com Fax 49 221 806-3907

FREQUENCY RANGE BANDE DE FRÉQUENCES	EMISSION TYPE GENRE D'ÉMISSION	SPECIFICATION / ISSUE / DATE SPECIFICATION / ÉDITION / DATE
2412 - 2460 MHz	DSS	RSS-210 / Issue 7, June 07
RF POWER PUISSANCE HF	ANTENNA TYPE Type D'ANTENNE	ANTENNA GAIN GAIN D'ANTENNE
0.151 W	Patch / Omni / Panel Mount	6 dBi Maximum

Note 1: Limited Modular Approval: Power listed is conducted. This Module is approved only for installation in devices under control of the grantee and only for models indicated in this filing. Only antenna(s) documented in this filings may be used with this transmitter. The antenna(s) used for this transmitter must be installed to provide a separation distance of at least 20 cm from all persons and must not be co-located or operating in conjunction with any other antenna or transmitter. OEM integrators and End-users and installers must be provided with antenna installation instructions and transmitter operating conditions for satisfying RF exposure compliance.

Certification of equipment means only that the equipment has met the requirements of the above noted specification. Licence applications, where applicable to use certified equipment, are acted on accordingly by the issuing office and will depend on the existing radio environment, service and location of operation. This certificate is issued on condition that the holder complies and will continue to comply with the requirements and procedures issued by Industry Canada / La certification du matériel signifie seulement que le matériel a satisfait aux exigences de la norme indiquée ci-dessus. Les demandes de licences nécessaires pour l'utilisation du matériel certifié sont traitées en conséquence par le bureau de délivrance et dépendent des conditions radio ambiantes, du service et de l'emplacement d'exploitation. Le présent certificat est délivré à la condition que le titulaire satisfasse et continue de satisfaire aux exigences et aux procédures d'Industrie Canada

Date: Thursday, August 26, 2010

Certifier: Mark Ryan

Signature: 

Title: Senior Specialist

TUV Rheinland of North America Inc., North American Headquarters, 12 Commerce Road, Newtown, CT 06470
Tel: (203) 426-0888, Fax: (203) 426-4009
QF094221

Page 1 of 1

Revision 0

CE Declaration of Conformity

BECKHOFF New Automation Technology

EG-Konformitätserklärung, EC Declaration of Conformity

Hersteller <i>Manufacturer</i>	Beckhoff Automation GmbH
Anschrift <i>Address</i>	Eiserstr. 5 33415 Verl Bundesrepublik Deutschland
Produktbezeichnung <i>Product description</i>	CU8890 WLAN-Controller mit USB-Eingang <i>CU8890 WLAN controller with USB input</i>

Die hier genannten Baugruppen sind entwickelt, konstruiert und gefertigt in Übereinstimmung mit den EG-Richtlinien 1999/5/EG R&TTE-Richtlinie, 2004/108/EG EMV-Richtlinie und 2006/95/EG Niederspannungsrichtlinie.

Folgende Normen wurden angewandt:

The components mentioned herein have been developed, designed and manufactured in accordance with the EC Guideline 1999/5/EG, 2004/108/IEC and 2006/95/IEC. The following standards have been used:



- | | |
|--|---|
| Generic Standard: EN 61000-6-2:2006
<i>Generic Standard: EN 61000-6-2:2006</i> | Störfestigkeit für Industriebereich
<i>immunity for industrial environments</i> |
| Generic Standard: EN 61000-6-4:2007
<i>Generic Standard: EN 61000-6-4:2007</i> | Störaussendung für Industriebereich
<i>emission standard for industrial environments</i> |
| Standard: EN 300 328 V1.7.1:2006
<i>Standard: EN 300 328 V1.7.1:2006</i> | Datenübertragungsgeräte, die im 2,4 GHz-ISM-Band arbeiten und Breitband-Modulationstechniken verwenden
<i>Data transmission equipment operating in the 2,4 GHz ISM band and using wide band modulation techniques</i> |
| Standard: EN 301 489-1 V1.6.1:2005
<i>Standard: EN 301 489-1 V1.6.1:2005</i> | EMV und Funkpektrumanangelegenheiten (ERM) – EMV für Funkeinrichtungen und –dienste - Teil 1: Gemeinsame technische Anforderungen
<i>EMC and Radio spectrum Matters (ERM)- EMC for radio equipment and services - Part 1: Common technical requirements</i> |
| Standard: EN 301 489-17 V1.2.1:2002
<i>Standard: EN 301 489-17 V1.2.1:2002</i> | Teil 17: Spezifische Bedingungen für Breitband-übertragungssysteme im 2,4 GHz Band
<i>Part 17:specific conditions for 2,4 GHz wideband transmission systems</i> |
| Generic Standard: EN 50371:2002
<i>Generic Standard: EN 50371:2002</i> | Sicherheit von Personen in elektromagnetischen Feldern
<i>human exposure to radio frequency electromagnetic fields</i> |

Verl, den / the 19.06.2009

Unterschrift, signature
Name, name
Funktion, function

Hans Beckhoff
 Geschäftsführer, *Executive Director*

Operation Notes for USA/Canada

 Note	<p>Beware of unapproved and unauthorized modifications</p> <p>Changes or modifications not expressly approved by the manufacturer could void the user's authority to operate the equipment.</p> <p>The manufacturer is not responsible for any radio or TV interference caused by unauthorized modifications to this equipment. Such modifications could void the user's authority to operate the equipment.</p>
 CAUTION	<p>Consider Health Canada limits for the general population!</p> <p>The installer of this equipment must ensure that the antenna is located or pointed such that it does not emit RF field in excess of Health Canada limits for the general population; consult Safety Code 6, obtainable from Health Canada's website http://www.hc-sc.gc.ca/rpb.</p>

FCC ID and IC ID

FCC ID: XS3 – FC9891-0000
 IC ID: 8573A – FC98910000

BECKHOFF

CP7733-0001-0020

Serial No:	200186-001	Beckhoff Automation GmbH
Date:	13.11.2008	Eiserstraße 5
Mainboard:	CP9720-V1 500MHz	D-33415 Verl
CPU:	AMD ALX 500MHz	Germany
On-Board RAM:	4 x 64MB DDR RAM	Phone: +49 5246 / 963-0
Power supply:	24V DC	Fax +49 5246/ 963-149
Compact Flash:	64MB IDE	Documentation: www.beckhoff.com
Display:	19" FLC48XC8V-10	 Made in Germany
Touchscreen:	19" ELO Accutouch	
MAC1:	000105033612	
MAC2:	000105033613	







FC9891-0000
 FCC ID: XS3-FC9891-0000
 IC ID: 8573A-FC98910000

FCC: Federal Communications Commission Radio Frequency Interference Statement

This Device complies with Part 15 of the FCC Rules. Operation is subject to the following two conditions:

- (1) This device may not cause harmful interference, and
- (2) This device must accept any interference received, including interference that may cause undesired operation.

Calculating with decibels

In communication technology power is expressed in decibels (dB), a tenth of the unit Bel. It is the logarithmic ratio between two quantities with the same unit.

A reference variable (P1), e.g. a milliwatt (mW) is compared with the measured variable (P2). The logarithmic correlation was discovered by Alexander Graham Bell, in whose honor the unit Bel was named.

Since the number values would be too unwieldy if the Bel was used, it was agreed to use 1/10 of the value, i.e. the decibel.

Definition of the level difference: Level difference [dB] = 10 log ([P1] / [P2]).

Definition of a power ratio: power ratio = $10^{\text{level difference}/10}$

The advantage of expressing the powers and losses (attenuations) in dB is that the calculation method for power ratios can be replaced by a lower calculation method for the dB calculation.

Power ratio	dB calculation
Multiplication or Division	Addition or subtraction
Exponent	Factor

Examples of power ratios:

Factor	Amplification [dB]
x 1	+0 dB
x 1,25	+1 dB
x 2	+3 dB
x 4	+6 dB
x 10	+10 dB
x 16	+12 dB
x 100	+20 dB
x 1000	+30 dB

Factor	Attenuation [dB]
x 1	-0 dB
x 0,8	-1 dB
x 0,5	-3 dB
x 0,25	-6 dB
x 0,1	-10 dB
x 0,6	-12 dB
x 0,01	-20 dB
x 0,001	-30 dB

Examples of calculations with decibels:

Change	in dB
10 / 2 = 5	10 - 3 = 7
2 x 2 x 2 = 8	3 + 3 + 3 = 9
2 x 100 = 200	3 + 20 = 23
1000 / 2 = 500	30 - 3 = 27

Beckhoff Support & Service

Beckhoff and their partners around the world offer comprehensive support and service, guaranteeing fast and competent assistance with all questions related to Beckhoff products and system solutions.

Beckhoff branches and partner companies

Please contact your Beckhoff branch office or partner company for [local support and service](#) on Beckhoff products!

The contact addresses for your country can be found in the list of Beckhoff branches and partner companies: www.beckhoff.com

You will also find further [documentation](#) for Beckhoff components there.

Beckhoff Headquarters

Beckhoff Automation GmbH
Eiserstraße 5
33415 Verl
Germany

Phone: +49(0)5246/963-0
Fax: +49(0)5246/963-198
e-mail: info@beckhoff.com

Beckhoff Support

Beckhoff offers you comprehensive technical assistance, helping you not only with the application of individual Beckhoff products, but also with wide-ranging services:

- worldwide support
- design, programming and commissioning of complex automation systems
- training program for Beckhoff system components

Hotline: +49(0)5246/963-157
Fax: +49(0)5246/963-9157
e-mail: support@beckhoff.com

Beckhoff Service

The Beckhoff service center supports you in all matters of after-sales service:

- on-site service
- repair service
- spare parts service
- hotline service

Hotline: +49(0)5246/963-460
Fax: +49(0)5246/963-479
e-mail: service@beckhoff.com

Quote the project number If servicing is required, please quote the **project number** of your product.