

CP3918-0000  
with  
C9900-M575  
C9900-E274

main dimensions and  
fixing points

dimensions in mm

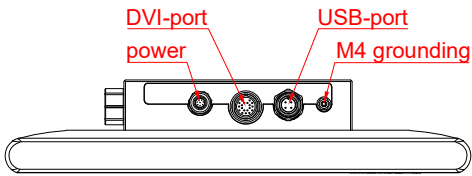
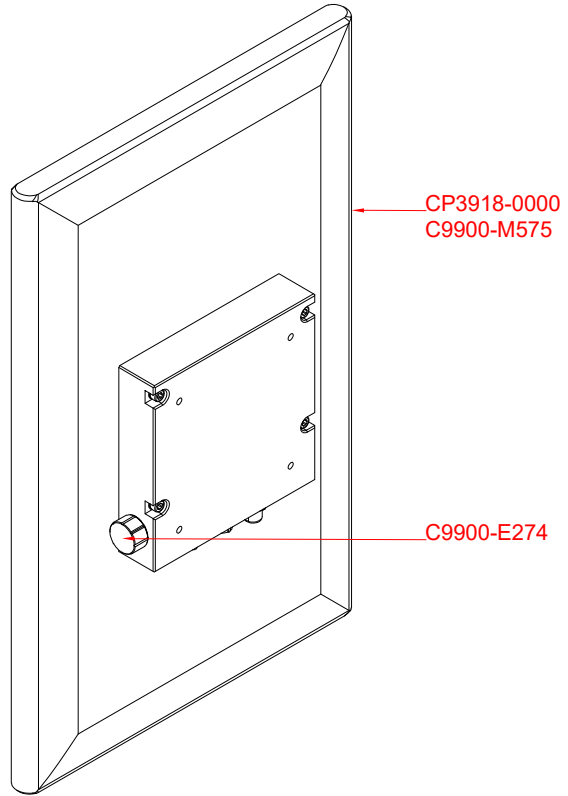

bottom view

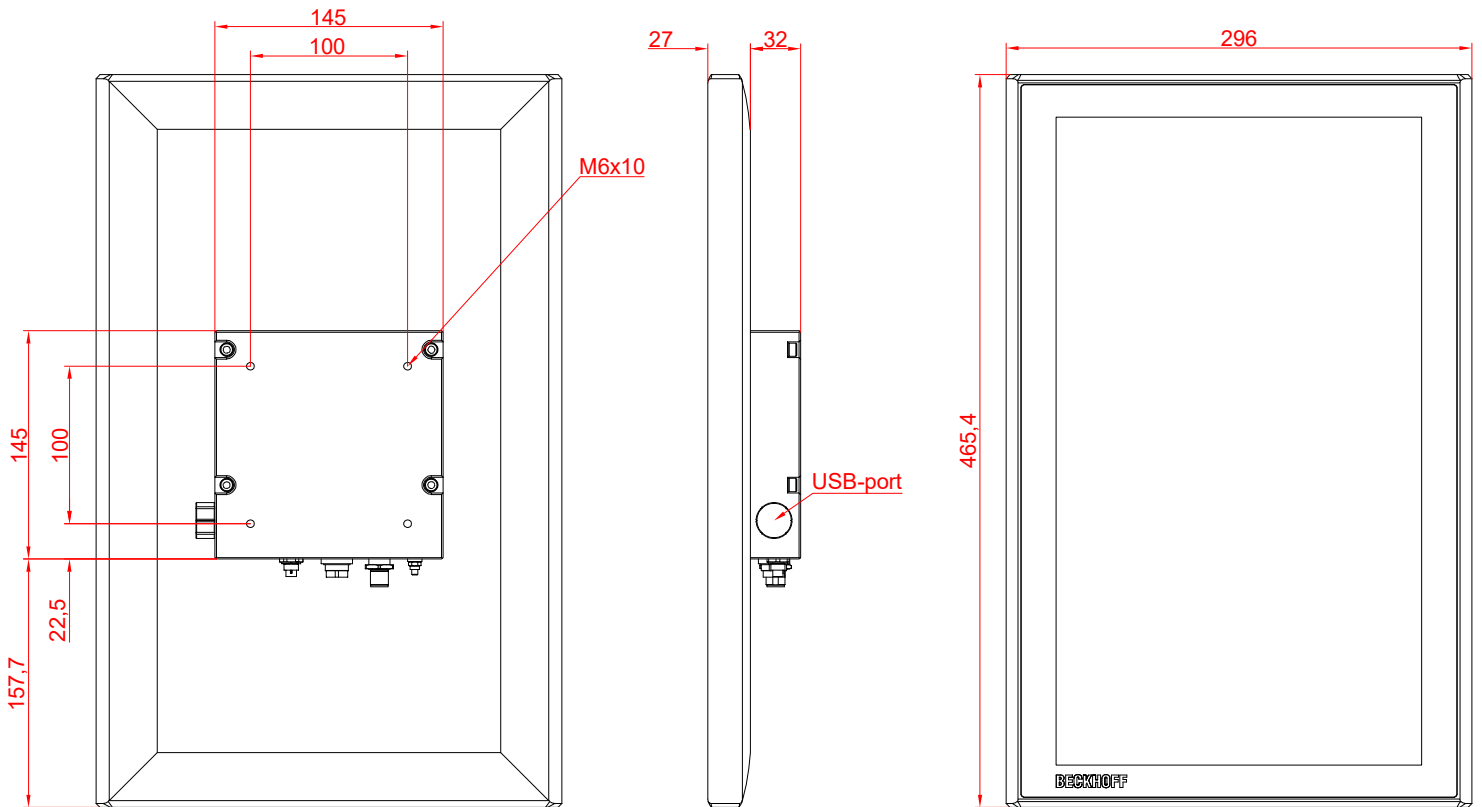

rear view

side view

front view