

CP3924-0000
with
C9900-M406

main dimensions and
fixing points

dimensions in mm

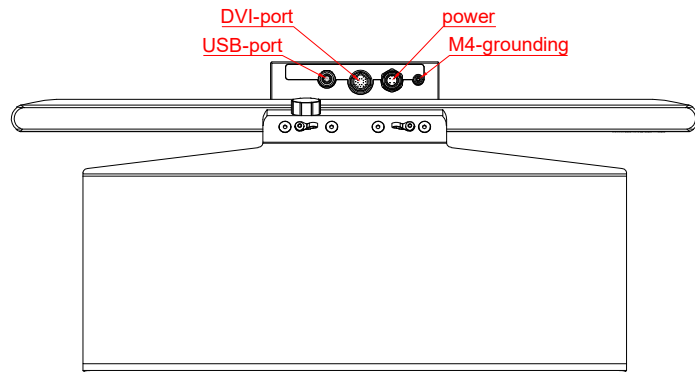

bottom view

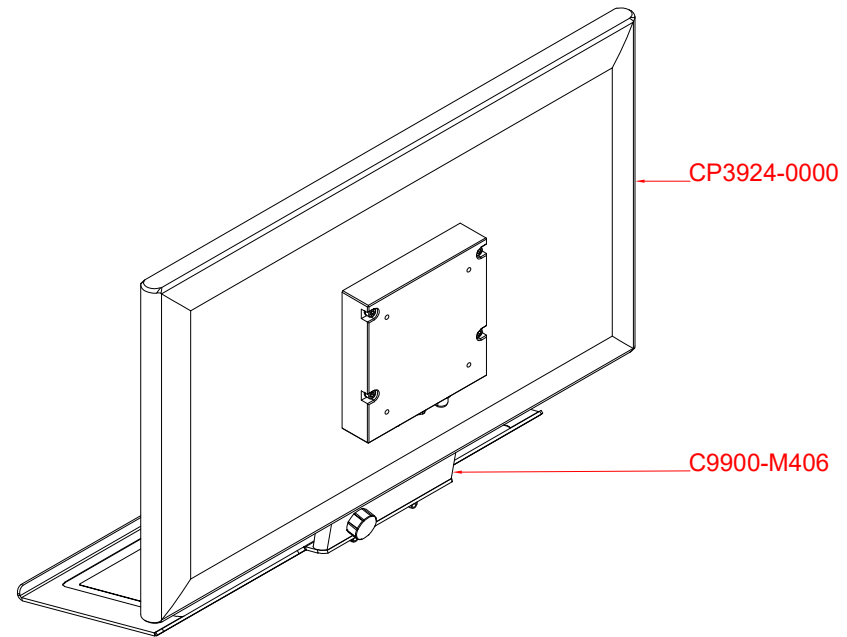

CP3924-0000

C9900-M406

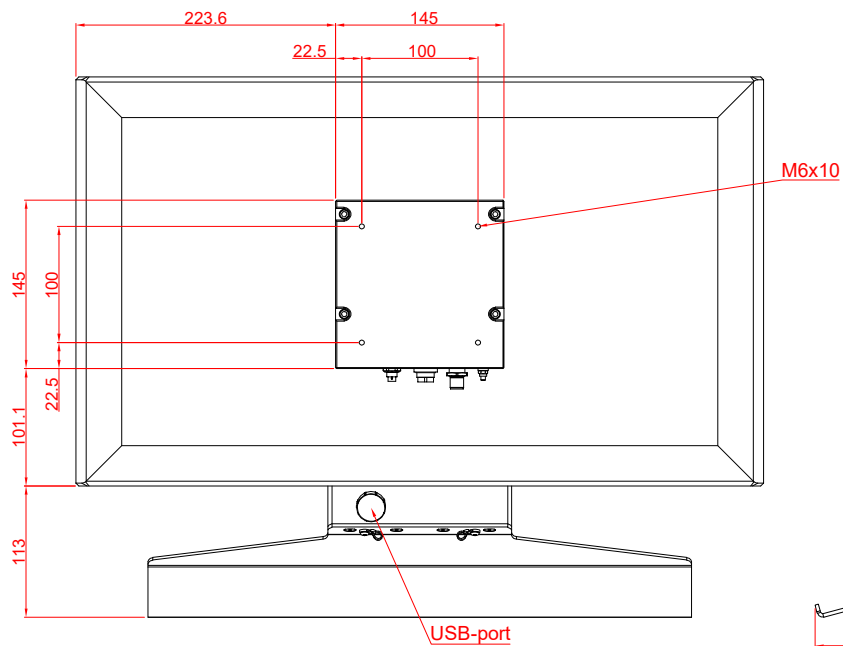

rear view

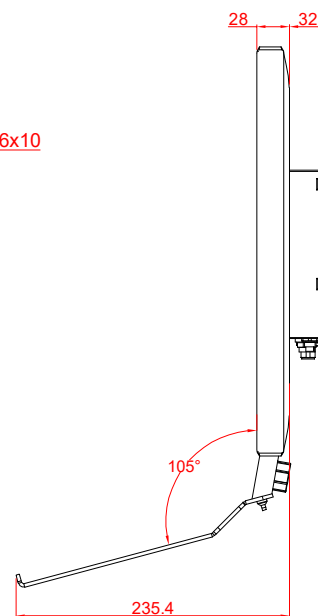

side view

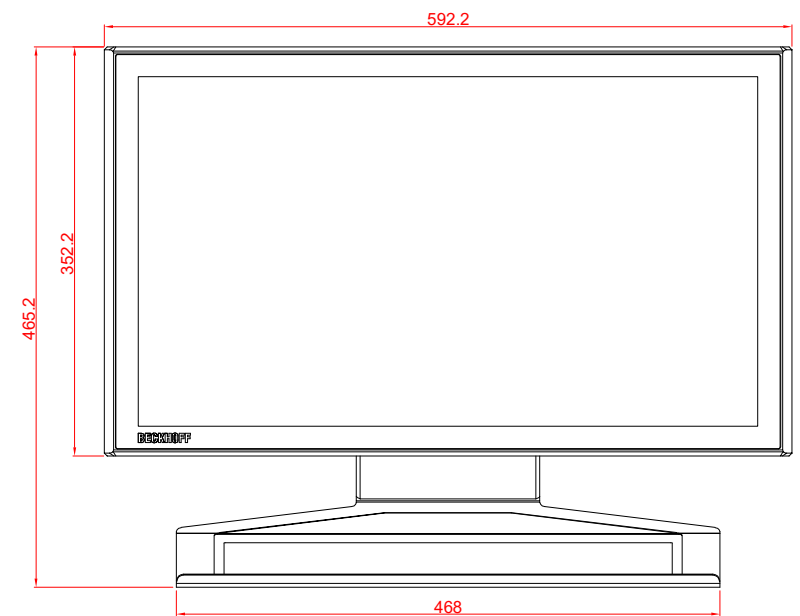

front view