

bottom view

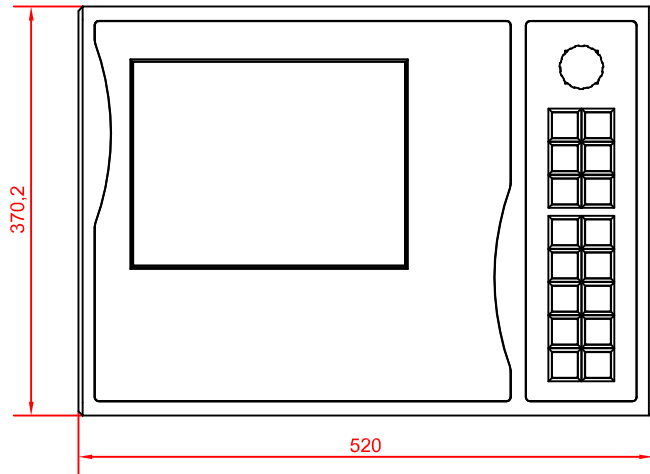

front view

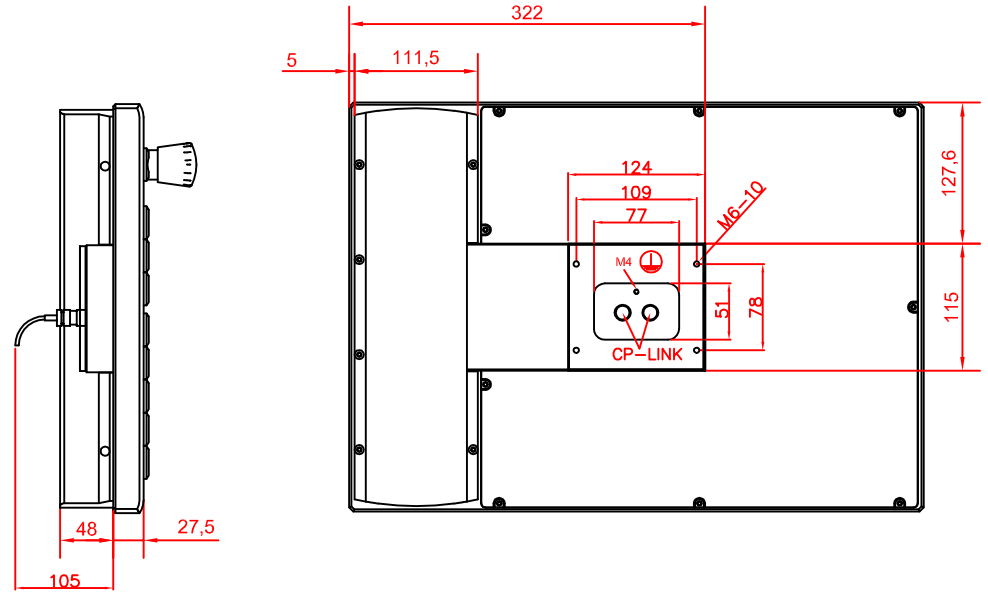

left view

rear view

CP7031-0000-E616
 arm adapter for
 Rolec - Tara - suspension adaption
 146.025.019

main dimensions and
 fixing points

dimensions in mm

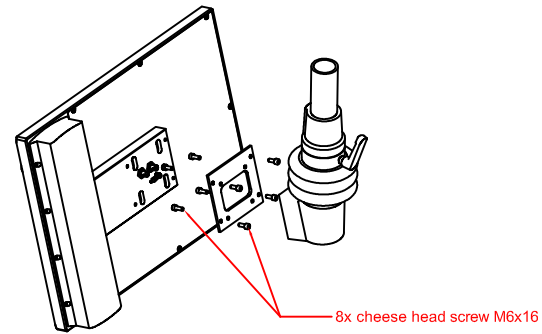

149.025.014