

front view

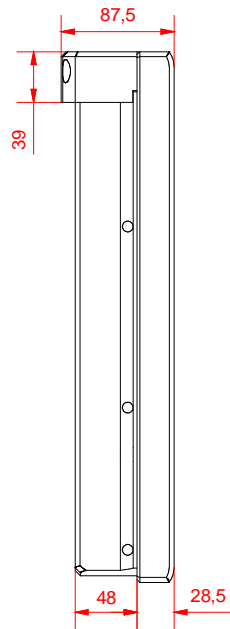

left view

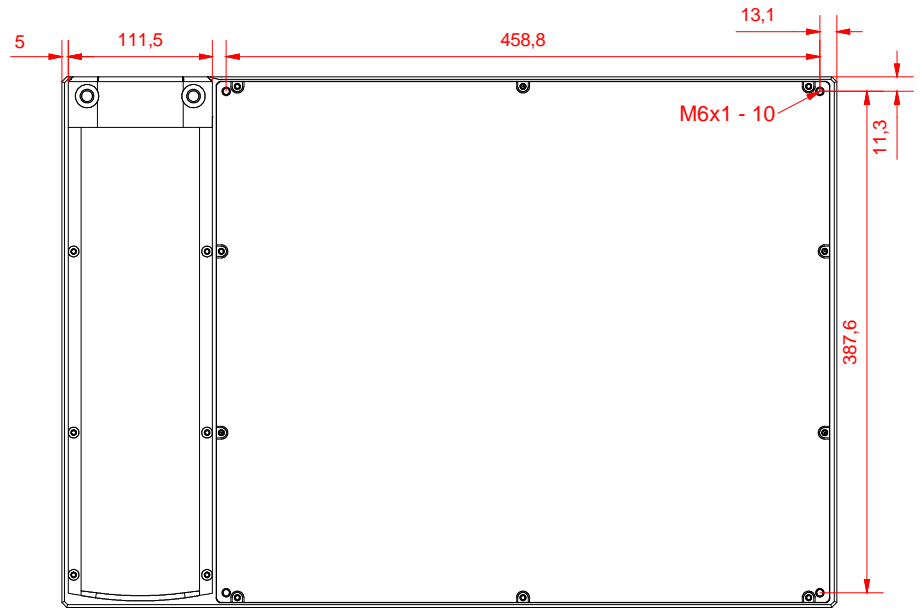

rear view

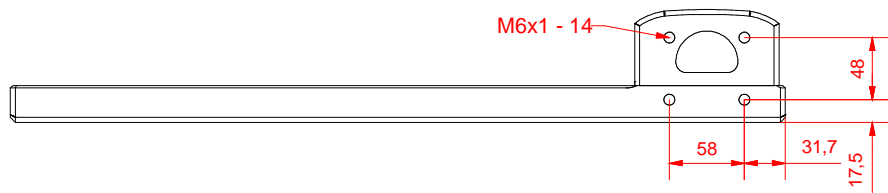

top view

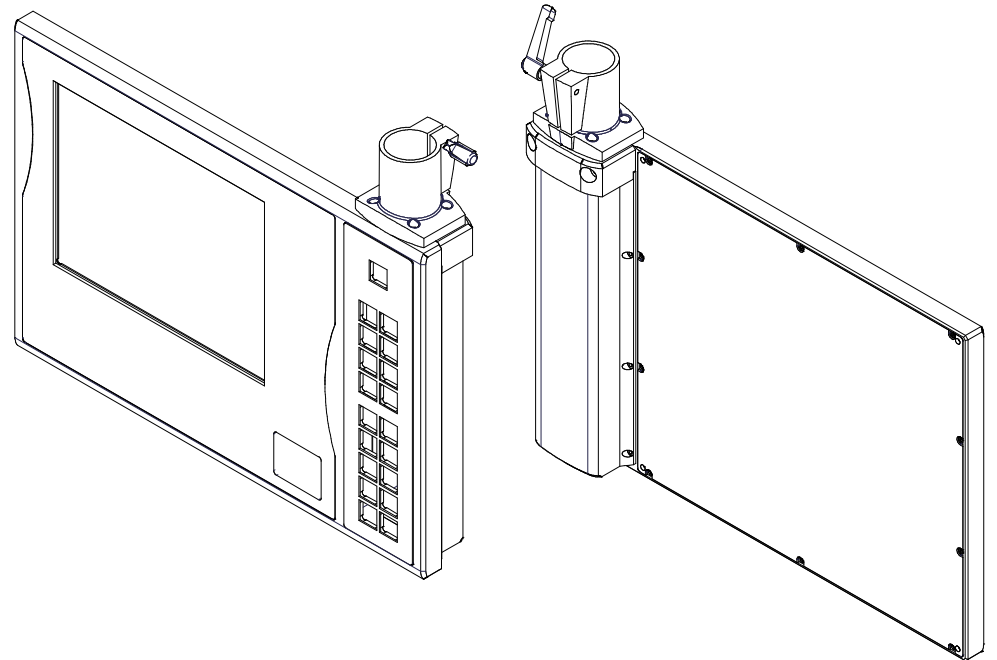

CP7032 - 0000 - E676

arm adapter for
Rolec - Tara - suspension adaption
146.025.019

main dimensions and
fixing points

dimensions in mm