

bottom view

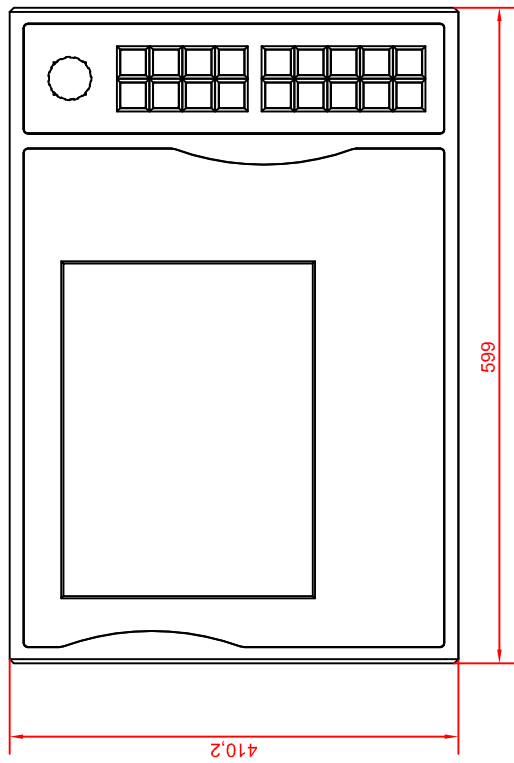

front view

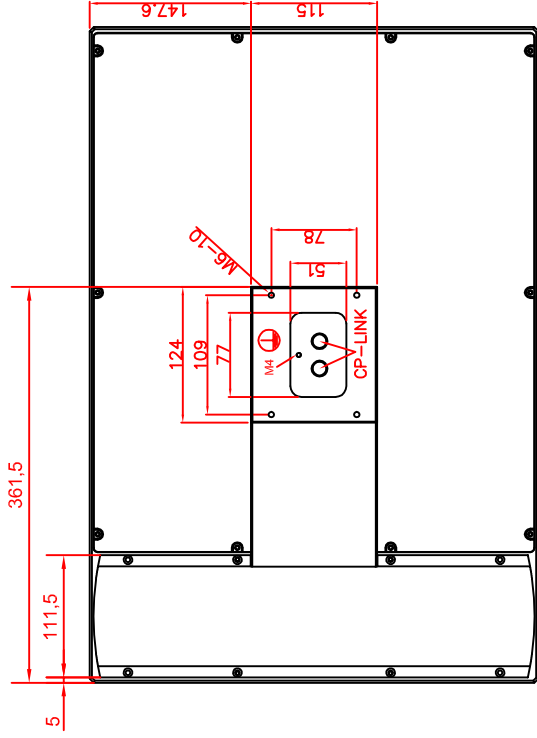

rear view

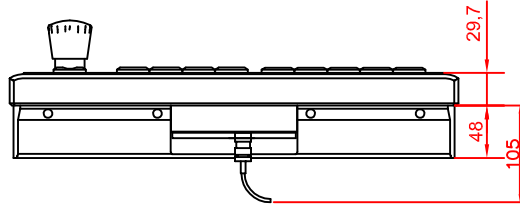

left view

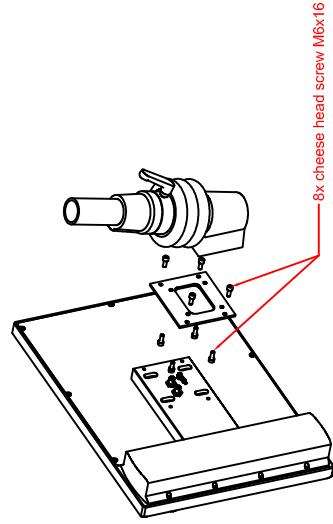

8x cheese head screw M6x16

149.025.014

CP7032-0000-E776
arm adapter for
Rolec - Tara - suspension adaption
146.025.019

main dimensions and
fixing points

dimensions in mm