

front view

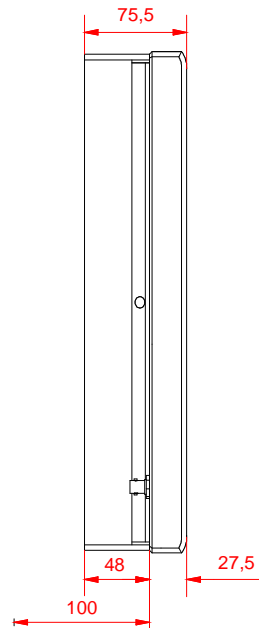

installation depth
cp-link connectors
left view

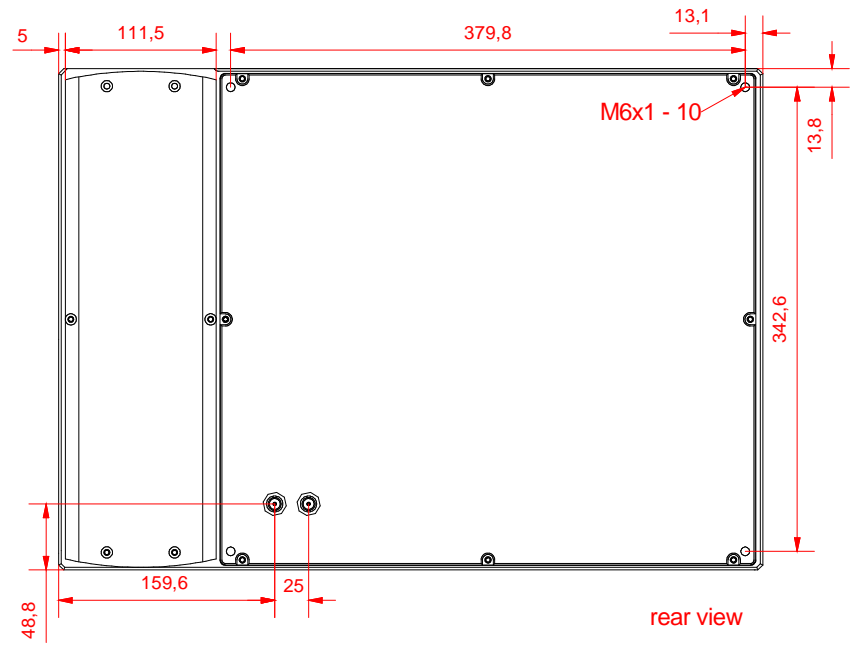

rear view

CP 7037 - 0000 - E621

main dimensions and
fixing points

dimensions in mm

